



Pathfinder™ Pro 
Search and Rescue Transponder

MANUAL

Part #: 2914



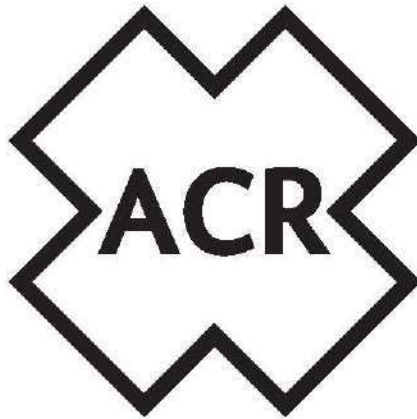

©2015 ACR Electronics, Inc.

The technical data, information and illustrations contained in this manual were believed to be correct at the time of print. ACR Electronics, Inc. reserve the right to change specifications and other information contained in this manual as part of our continual improvement process.

No part of this manual may be reproduced, stored in a retrieval system or transmitted in any form, electronic or otherwise, without the prior permission of ACR Electronics, Inc.

No liability can be accepted for any inaccuracies or omissions in this manual. ACR Electronics® and Pathfinder PRO® are registered trademarks of ACR Electronics, Inc.

IN CASE OF EMERGENCY

- REMOVE THE SART FROM ITS MOUNTING OR HOUSING
- ACTIVATE THE SART

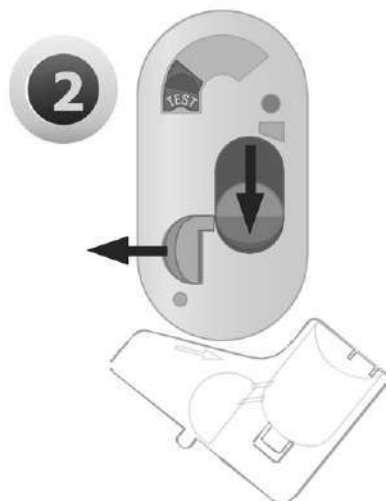

- TETHER THE SART TO THE LIFE RAFT USING THE LANYARD TO AVOID IT BEING LOST OVERBOARD.
- FOR MAXIMUM EFFECTIVENESS, THE SART NEEDS TO BE MOUNTED AT LEAST 1 METER ABOVE THE SEA.
- THE SART MAY BE ATTACHED TO THE ROOF OF THE LIFE RAFT USING THE TIE PROVIDED IN THE LIFE RAFT. ALTERNATIVELY THE SART MAY BE MOUNTED ON THE TELESCOPIC POLE SUPPLIED AND ATTACHED TO THE SIDE OF THE LIFE RAFT.

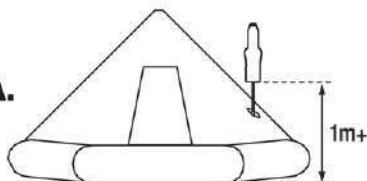
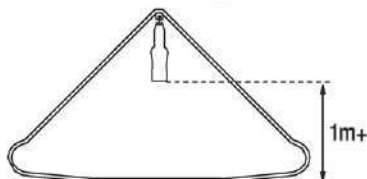

NOTE: Refer to section 4.3 for deactivation instructions.



Pathfinder PRO User Manual

CONTENTS

1	General	5
	1.1 Exposure to RF Electromagnetic Energy	5
	1.2 Warnings	5
2	Pathfinder PRO Overview	6
3	Installation	7
4	Operation	8
	4.1 Deployment	9
	4.2 Activation	9
	4.3 Deactivation	10
	4.4 Testing	10
5	Batteries	11
	5.1 Battery Replacement	12
6	Appendix	13
	6.1 Maintenance and Troubleshooting	13
	6.2 Accessories	13
	6.3 Specifications	13
	6.4 Approvals	14
	6.5 Limited Warranty	14









1 GENERAL

1.1 EXPOSURE TO RF ELECTROMAGNETIC ENERGY

This product has been evaluated for compliance with the FCC RF exposure limits given in CFR 47 part 2.1093 at a distance of 2.5 cm for "Occupational Use Only".

1.2 WARNINGS

-  Always operate the SART with any part of the device at least 6cm (2.4in) away from your body.
-  The Pathfinder PRO SART is designed for use in emergency only. Only operate it in situations of grave and imminent danger.
-  The Pathfinder PRO SART incorporates a protective tab over the operating controls to avoid accidental activation and indicate that the unit has been used.
-  After any period of operation, the battery should be replaced and the unit returned to your local service dealer for replacement of the protective tab.
-  Always replace the battery before the expiry date is exceeded to ensure full operating capacity in case of emergency.
-  Please ensure you follow local regulations before disposing of this item. Ensure the battery is removed from the unit before disposal.



2 Pathfinder PRO OVERVIEW

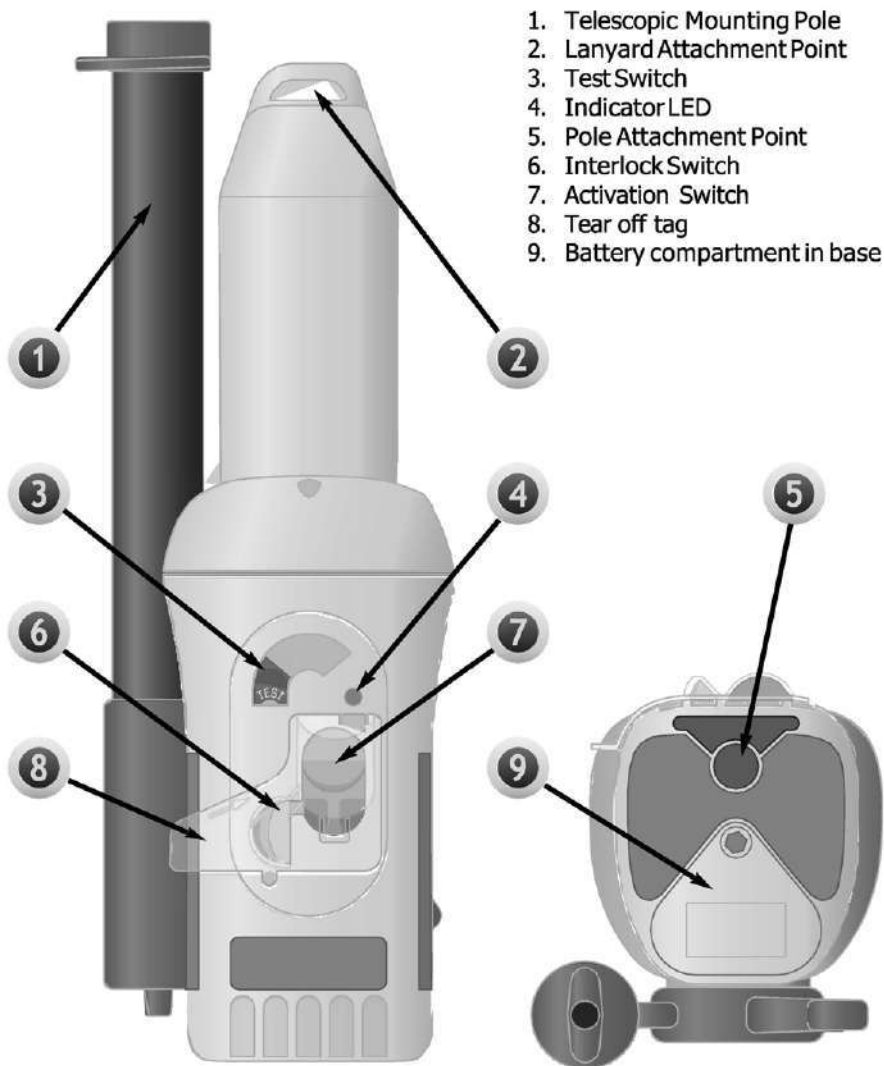



3 INSTALLATION

The Pathfinder PRO is supplied with a quick release mounting bracket. This bracket should be mounted on a suitable wall or bulkhead in a position where it can easily be retrieved in an emergency.

Although the Pathfinder PRO is rugged and waterproof, ACR Electronics recommends mounting the SART in a protected position whenever possible.

- ❗ Do not mount the SART closer than 1 meter to any steering compass as this may affect the accuracy of the compass.
- ❗ Keep the Pathfinder PRO away from any strong magnetic sources such as loudspeakers, compass compensation magnets, etc.

Mark the location of the four screw holes onto the mounting position. Pre-drill the holes if required then screw the mounting bracket to the surface using the four No. 6 x 5/8" screws supplied.

The SART simply clips onto the mounting bracket.

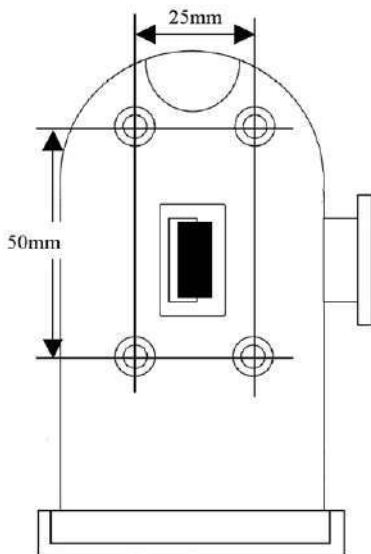



4 OPERATION

Ensure the SART is always fitted with an unused battery that is within the marked expiry date.

A SART is not intended as a primary distress alerting device. At least one of the following should also be carried onboard your vessel to alert the authorities to your situation: an EPIRB; a DSC radio; an Inmarsat satellite terminal.

Once the SART is activated it will help guide the Search and Rescue authorities to your position.

4.1 DEPLOYMENT

For the best performance, it is important that the SART is mounted as high as possible in the liferaft. The Pathfinder PRO SART is supplied with a telescopic pole which will keep the SART at a height of 1 meter above sea level.

Remove the pole from the back of the SART. A lanyard is stowed under the rubber pole retainer.

- ⚠ The lanyard should be unwound at this stage and tied securely to the liferaft to ensure the SART is not lost overboard.

Remove the cap from the top of the pole and then pull out the sections until fully extended. Ensure the sections are locked tight by pulling on them.

Fit the smallest section of the pole into the pole attachment point in the base of the SART as shown, ensuring it is pushed in tightly.

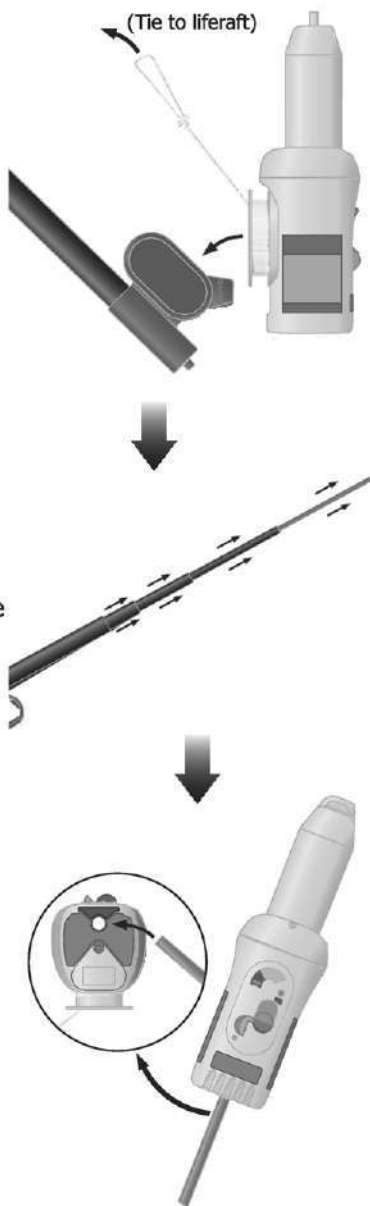



Pathfinder PRO User Manual

Raise the SART vertically and attach the pole to the liferaft. Most liferafts are fitted with suitable attachments to accommodate the SART pole.

Alternatively, the SART may be attached directly to the liferaft canopy.

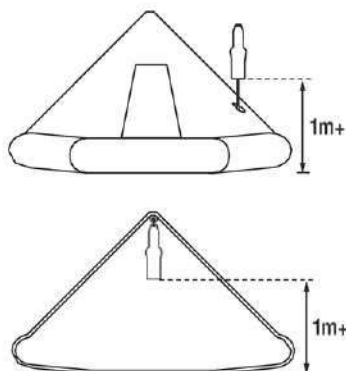

4.2 ACTIVATION

- ⚠ The SART should only be activated if there is grave and imminent danger to the vessel and its crew.

To activate the SART, remove the unit from its mounting bracket.

Break off the clear protective cover over the Green and Red switches.

Holding the Green switch to the left, push the Red switch down and hold.

While holding the Red switch down, release the Green switch to lock the Red switch in the active position.

During operation, the Red LED next to the Test switch will flash once every 2-3 secs to indicate the SART is operational:



When activated by a received radar pulse the Red LED will start flashing rapidly

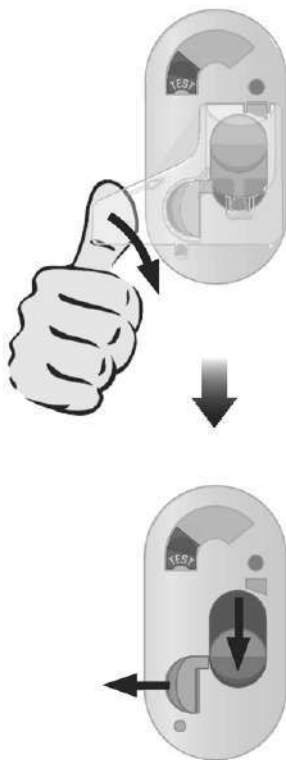



4.3 DEACTIVATION

If the SART has been inadvertently activated, it can be turned off simply by reversing the activation process.

Slide the Green switch to the left - the Red switch will return to the off position. Release the Green switch.

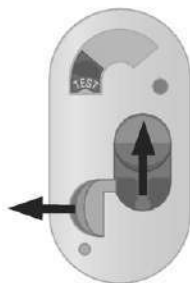

It is not possible for the user to replace the clear protective cover. Return the SART to an ACR Electronics authorized service center for replacement.

4.4 TESTING

It is recommended that the SART is tested periodically. A full test should be carried out in conjunction with an X-band radar on a nearby vessel if possible. A full test should always be carried out as part of the annual service, with short inspections every two months.

Activate Test Mode by rotating the grey test switch clockwise and holding.

If there is radar activity in the area then the Red LED will start to flash intermittently, indicating that the radar signals are being received.

The radar display of any vessels within radar detection range of your location will now be showing the return from the SART.

Depending on the distance of the vessel to the SART and the tuning of the radar, the display will vary between a set of concentric rings to a line of twelve blips in a straight line on a bearing between the vessel and the SART.

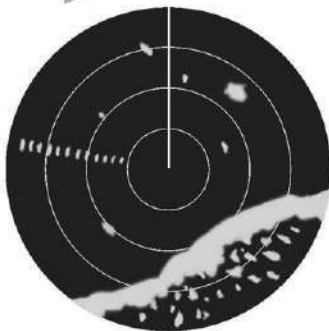







Test Mode is the same as Activation Mode, so keep the test duration to a minimum to avoid falsely alerting other vessels that you may be in distress and minimize battery drain.



5 BATTERIES

The Pathfinder PRO SART uses a Lithium Iron Disulfide battery pack to power the device. These batteries have a five year storage life before any significant reduction in capacity. Each battery is marked with an expiry date, which is located at the base of the unit.

-  The battery should be replaced before the expiry date has passed to ensure reliable operation and full capacity in emergency situations.
-  Always use batteries manufactured by ACR Electronics. Failure to do so will invalidate the type approval and may mean the unit does not operate correctly in a distress situation.
-  Never dispose of batteries in a fire.
-  Never puncture or attempt to dismantle the battery. Never attempt to charge the battery.
-  Extreme temperature caused by failure to observe the above warnings may cause the battery to explode or catch fire, which may result in injury or damage to surrounding personnel or property.
-  Dispose of used batteries in a responsible manner. National or local regulations on battery disposal may apply including restricting the disposal of batteries in domestic refuse.



5.1 BATTERY REPLACEMENT

The battery may be changed by the user, although commercial vessels may be subject to local regulations relating to Shore Based Maintenance that prevent this.

Remove the SART from its mounting bracket and turn it over.

The battery pack is retained by a single hex head screw.

Undo the screw using the 3mm Allen (Hex) key provided.

Remove the pack from the main body.

Insert new battery pack, ensuring that the rubber seal is correctly in position and the pack is pushed home fully. Tighten screw.

Ensure that any maintenance records onboard are updated with the new battery expiry date.

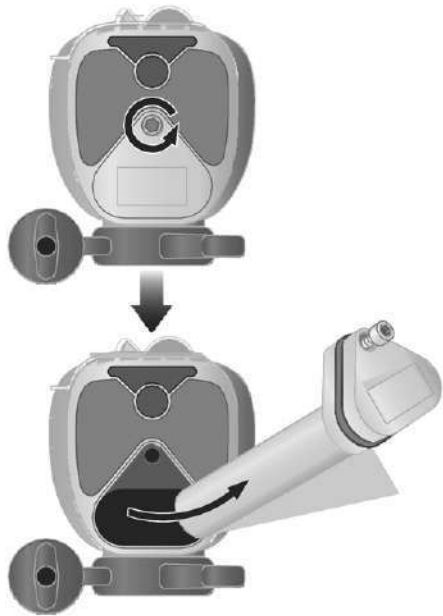



6 APPENDIX



6.1 MAINTENANCE AND TROUBLESHOOTING

The Pathfinder PRO SART should not need servicing during its lifetime, with the exception of changing the battery before the marked expiry date.

Regular cleaning, inspection and testing are advised - clean any grime or salt residue off the unit with a weak solution of detergent in warm water. Never use solvents as this may affect the structural integrity of the plastics used. Rinse well with fresh water after cleaning.

Inspect the unit for signs of case damage or cracks, check the labels are intact and the battery is within the expiry date. Make sure the telescopic pole (if provided) is still present and is free to extend.

Check for correct SART operation using the Test Mode (see section 4.4). If the unit appears to fail testing, check the following points before contacting a service representative:

-  Are there any vessels in the vicinity that would have an active radar system to trigger the SART?
-  Is the SART being shielded from being radar visible to other vessels?

6.2 ACCESSORIES

Replacement Lithium Battery for Pathfinder PRO2920

6.3 SPECIFICATIONS

Transmitter

Frequency 9.2-9.5GHz
Output Power (EIRP) >400mW
Number of sweeps/per interrogation.12

Supply

BatteryLithium Iron Disulfide (LiFeS₂)
Operating life (standby/active)96/12 hours at -20°C



Pathfinder PRO User Manual

Test Standards

IEC61097-2, IEC60945,

Environmental

IEC60945 Category	Portable
Temperature Range (operating)	-20°C to +55°C
Temperature Range (storage)	-30°C to +65°C
Waterproof	10 meters
Drop proof (on water)	20 meters
Compass safe distance	1 meter

6.4 APPROVALS

The Pathfinder PRO SART complies with the requirements of Annex A.1/4.18 of European Directive 98/85/EC as amended by 2009/26/EC, for use onboard ships registered in the European Union.

The Pathfinder PRO SART complies with the GMDSS provisions of part 80 of the FCC rules.