

# **BALMAR<sup>®</sup>**

**DC CHARGING SOLUTIONS**

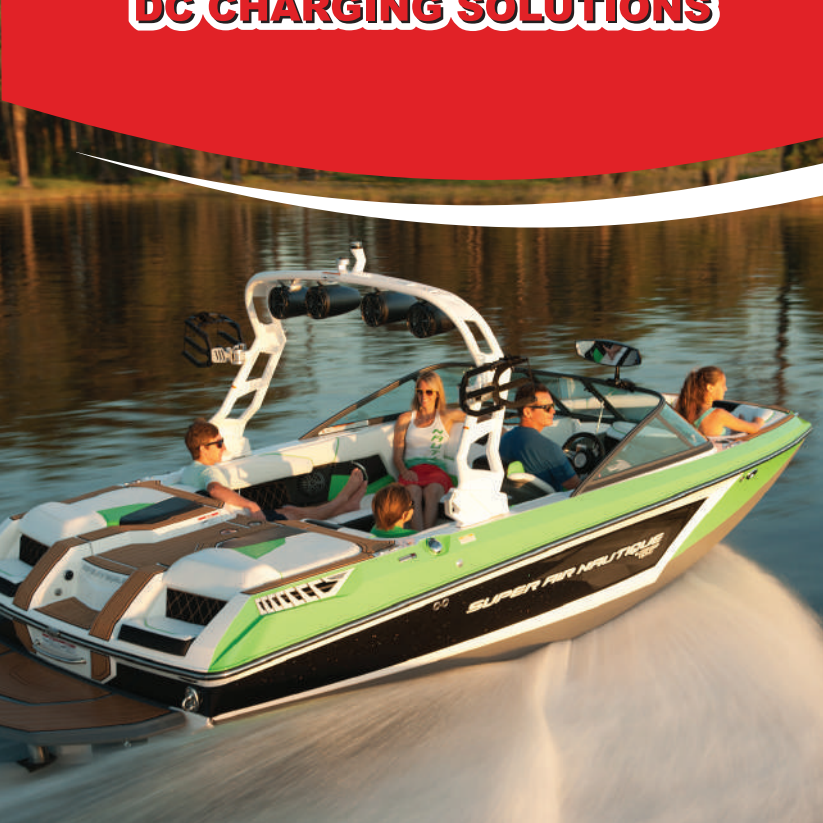

## **2019 CATALOG**

*We Know How To Charge Your Batteries*



## Balmar Knows How To Charge Your Batteries

Balmar has been serving the Marine Industry for over 30 years.

We supply DC Charging Products and Battery Monitors to help sailors, power boaters, and RVers charge and monitor their batteries more efficiently.

Balmar is recognized throughout the industry for its innovative technology, expert technical service and product reliability.



**NEW**

### SG200 Battery Monitor Balmar's Expandable, Next Generation Monitor

Balmar has combined recent technology advances to introduce a next generation battery monitor. The SG200 is quite simply the most accurate battery monitor available today. Balmar has combined the best features of its 1st generation Smartgauge™ with many advantages of a shunt-based amp-hour counting system. Further, we've designed a device architecture which facilitates multiple gauges or multiple shunts to be added to the network – allowing the boater to monitor multiple energy storage banks simultaneously from multiple locations.

In addition, the SG200 Color Display is easy to read, configurable and fits any standard 2 1/16" gauge socket. Now you can determine your battery(s) condition from anywhere on the vessel or vehicle with multiple displays, or simply add the optional Bluetooth® Smartphone App to keep information in your pocket! **See page 12 for details!**



*"I love your products. I have all your high-output alternators on every boat I use and restore. Balmar products should be on every boat!"*

*-Serial Boat Restorer - Newport, Rhode Island*

### On the Cover:

The Super Air Nautique, Fleming Yacht, Balance Catamaran, and Zion SRT Roadtrek all utilize Balmar Charging System Upgrades.



## The Balmar Difference

- More Charging Amps at Low RPM
- More Charging Amps at High RPM
- 30% Faster, More Complete Charging
- Longer Battery Bank Life
- Reduce / Eliminate Genset Usage
- Less Fuel Consumption
- More Reliable Charging Components
- More Accurate Battery Monitoring
- Worry-Free Operation

*This is the essence of what Balmar Products provide.*

*The following pages describe how we do it and how to specify a Balmar Charging System for your needs.*

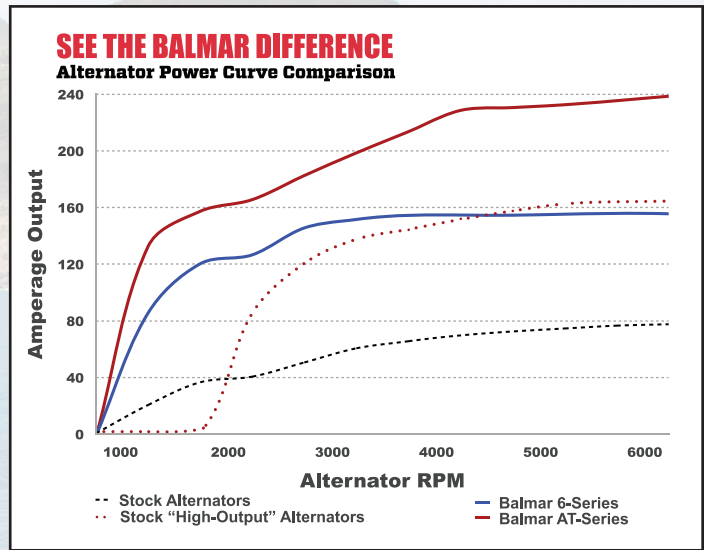

## Table of Contents

Balmar Company Introduction	2
The Balmar Difference	3
How to Select a Balmar Charging System	4-7
Small Case Alternators - 6-Series	8
Small Case Alternators - XT-Series and AT-Series	9
AltMount® Pulley Conversion Kits	10-11
SG200 Battery Monitor	12-15
Smartgauge™ Battery Monitor	16
Valeo Smart Ready® Retrofit	17
Balmar Voltage Regulation Technology	18-19
Balmar Voltage Regulation Products:	20-23
Max Charge and ARS-5 Multi-Stage Regulators	20
Single-Stage Regulators & Regulator Accessories	21
Digital Duo Charge for 2 Battery Banks	22
Centerfielder II for 2 Engine Systems	23
Large Case Alternators - 94 & 95 Series	24
Large Case Alternators - 97 Series	25
Large Case Alternators - 98 Series	26
Alternator Accessories	27
Alternator Output Curves	28
Alternator Dimensions	29
Part Number Listings:	30-38
Alternators	30-31
Alternator Charging Kits	32-33
SG200, Smartgauge™ Battery Monitors & Multi-Lite	33
Regulators & Regulator Accessories	34
Alternator Accessories, AltMount® Pulley Conversion Kits and Accessories	35-38



## Why Upgrade Your Charging System?

There are numerous reasons to upgrade your charging system. Here are some common complaints:

- I can't keep my battery charged!
- My current alternator does not keep up with my electrical requirements/load.
- I don't want to run my engine just to charge the batteries.
- I don't want to run my generator to charge the batteries when my engine is already running.
- I've added several batteries to my house bank, but I don't think they are being charged effectively.
- I operate predominantly at idle speed, but my battery bank doesn't charge at idle.
- I keep burning out alternators.
- I'm replacing my batteries too often.
- I have two engines, but my alternators don't work together to charge the battery bank effectively.
- My alternator charges my house bank, but I want to charge the engine start battery too without remembering to flip a battery switch.

Balmar Charging Systems can solve all these problems and more...

## How to Select a Balmar Charging System

Selecting a charging system upgrade for your vessel can be a confusing task, as there are many inter-related variables to consider. The following guide steps you through a logical progression of questions and choices which must be made to select the best charging system for your needs.

The selection process includes the following steps:

- Step 1: Determine Your Vessel's Electrical Load**
- Step 2: Identify Your Existing Battery Bank Technology and Capacity**
- Step 3: Select Your Optimum Alternator Output**
- Step 4: Identify the Alternator Mounting Style Present on Your Engine**
- Step 5: Determine your Belt and Pulley Requirements**
- Step 6: Select Additional Charging System Options**

These 6 important steps are fully described in the next 3 pages - Read on!

Our most popular charging system packages (shown below) combine Balmar's high amperage alternators and programmable multi-stage regulators – providing the best DC charging solution for your vessel. Keep reading to select the appropriate system for your needs.

See Page 8 to review the 6-Series, our best-selling alternator!



**6-Series Charging Package**  
Includes Alternator, Regulator & Temp Sensors

**NEW**

See Page 9 to review the amazing technology behind our high power XT-Series



**XT-Series Charging Package**  
Includes Alternator, Regulator & Temp Sensors



## How to Select a Balmar Charging System

### Step 1: Determine Your Vessel's Electrical Load

Skip this step if you are confident in your house bank's ability to service your existing vessel loads.

Accurate load calculations require precise measurement of your vessel's equipment. Refer to equipment manuals for actual load ratings or consult with a qualified marine electrician to determine your actual needs. The chart at the right provides typical DC marine loads and an example of load calculations. Use this example to configure and calculate your vessel's electrical load.

**(Device Load x Duty Cycle) x (# of Devices) = Total Load**

House battery capacity is typically derived based on the ability to meet approximately 24 hours' worth of typical demand, but could be longer if you don't expect to be connected to shore power for extended periods.

For example, if your vessel's typical daily electrical load is 300 Ah, then your battery bank should be sized to provide 300Ah of power storage.

*Since many traditional batteries will be damaged if you discharge them beyond a 50% State of Charge (SoC%), then 600Ah of rated storage may be required.*

Add batteries to your bank if you need them!

Typical DC Electrical Loads			
Device	Electrical Load in Amps/Hour	Duty Cycle Hours / 24 Hours	Total Ah Load per 24 Hours
VHF Receive	1.5	8	12
VHF Transmit	5.0	1	5
Depth Finder	1.0	8	8
GPS	0.5	8	4
Radar	4.0	8	32
Weather Fax	2.5	2	5
Laptop Computer	6.0	3	18
Auto Pilot	4.0	8	32
Knot Meter	0.1	8	1
Wind Speed	0.1	8	1
Anchor Light	1.0	2	2
Steaming Light	1.0	4	4
Running Light	3.0	3	9
Bilge Pump	5.0	1	5
Head	25.0	1	25
Wash Down Pump	10.0	.5	5
Refrigerator	7.5	5	38
Hand Spotlight	10.0	1	10
Add'l Devices...			0
<b>Total Daily Ah Load</b>			<b>210</b>

### Step 2: Identify Your Existing Battery Bank Technology and Capacity

Battery bank capacity has a dramatic impact on the size and type of alternator required to keep the batteries healthy. Identify your battery bank technology and capacity, then calculate an acceptance requirement.

- (A) Standard and Deep Cycle Flooded Batteries can accept a charge load up to 25% of their capacity.
- (B) Gel Cell Batteries can accept a charge load up to 35% of their capacity.
- (C) Standard AGM Batteries can accept a charge load up to 40% of their capacity.
- (D) TPPL and Carbon Foam AGM Batteries can accept charge loads up to 100% of their capacity.
- (E) Lithium Batteries can accept an almost unlimited charge load.

Contact your battery manufacturer to confirm their recommended charge loads and profile.

**(Battery Storage Capacity) x (Battery Charge Acceptance Rate) = Maximum Alternator Output Current**

For example, a bank of 3 AGM batteries, each with an individual capacity of 100Ah provide a total capacity of 300Ah. With an AGM acceptance rate of up to 40%, a 120A charging alternator could be utilized. If you have a really large bank or a battery technology that calls for an alternator output that exceeds available alternator technology, then it will just take longer to charge your bank.

Simply choose the highest alternator power which meets your budget, pulley constraints, and acceptance rate.



## How to Select a Balmar Charging System

### Step 3: Select Your Alternator Output

Now that you know the battery bank technology and charging profile, you can choose an alternator output which will optimally charge your bank. The chart on the next page shows Balmar's most popular range of small-case, high-power alternator choices for your vessel, along with an appropriate multi-stage regulator and related temperature sensing cables. (Balmar provides a discount when you buy the package).

For 70A – 120A requirements, choose a 6-Series Alternator Package.

For 170A – 220A requirements, choose an XT-Series or AT-Series Alternator Package.

### Step 4: Identify the Alternator Mounting Style Present on Your Engine

It is critically important to determine how your existing alternator is mounted to match with the high output alternator you have chosen. Marine alternator mountings generally fall into one of four possibilities:

The most common mounting styles are shown to the right:

(A) 1" Single Foot (Spindle Mount)	"Motorola Style"	Balmar 621 Series
(B) 2" Single Foot (Spindle Mount)	"Delco Style"	Balmar 621 Series
(C) 3.15" Dual Foot (Saddle Mount)	"Hitachi Style"	Balmar 60 Series
(D) 4" Dual Foot (Saddle Mount)	"J-180 Style"	Balmar 604 Series

Examples of these mounting styles are shown on the right.

Review your existing alternator mounting to determine the appropriate mounting for your upgrade.

Each Balmar alternator mounting style is identified by a unique part number.

### Step 5: Determine your Belt and Pulley Requirements

Engine drive belt style and width is also a critical factor when selecting a Balmar replacement charging system. Higher output alternators require more drive power to be taken off the engine. All belts have specific limitations regarding the amount of power take-off ("PTO") loads they can support.

Failure to specify an adequate belt/pulley system could result in premature belt wear, belt slippage and potential damage to the alternator and engine.

Balmar alternators can ship with pulleys which are appropriate for the alternator's output and drive belt.

**6-Series Alternators** from 70A-100A can ship with either a Single Vee, Dual Vee or Serpentine Pulley.\*

**6-Series Alternators** from 120A-150A can ship with either a Dual Vee or Serpentine Pulley.\*

**XT/AT-Series Alternators** can ship with either a Dual Vee or Serpentine Pulley.\*

\* Note: Balmar's 1/2" Deep Vee Pulleys (Single and Dual) can accept a 3/8" and 7/16" belt.

Identify the pulley style/size present on your engine and water pump before upgrading the charging system.

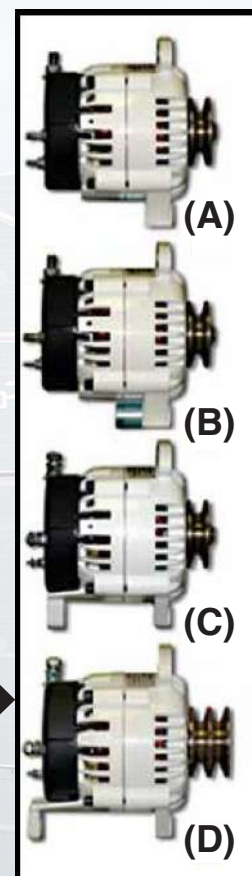

Belt Type	Belt Width	Maximum HP Load	Max Alternator Output	
			12 Volt	24 Volt
Single Vee	3/8"	3.5 HP	80 Amp	30 Amp
Single Vee	1/2"	4.5 HP	100 Amp	45 Amp
Dual Vee	1/2"	12 HP	310 Amp	220 Amp
Serpentine	6-Groove (K)	> 20 HP	310 Amp	220 Amp
Serpentine	10-Groove (J)	> 20 HP	310 Amp	220 Amp



## How to Select a Balmar Charging System

### Step 5: Determine your Belt and Pulley Requirements ... Continued

If the alternator output you have chosen exceeds the capability of your existing belt/pulley system, you must upgrade the pulley system using one of Balmar's patented AltMount® Pulley Conversion Kits. Refer to the chart on page 11 to find the applicable AltMount® Conversion Kit for your engine and alternator choice.



U.S. Patent Nos.  
8.939.855 and D654.778

Here are some additional rules-of-thumb to guide your choices:

- Balmar 6-Series Alternators from 70A-100A can perform with a 1/2" Single Vee pulley. If you need to charge above 100A, then you will need a Dual Vee or Serpentine pulley system to be present on your engine to avoid a pulley upgrade. If a Dual Vee or Serpentine pulley is not present, then an AltMount® Conversion Kit is required.
- Many boaters choose to limit their charging system upgrade to a 100A 6-Series Alternator Package to avoid the additional purchase of a pulley conversion.
- Unless you own a recently produced engine which already contains a Dual Vee or Serpentine pulley system, the superior power afforded by the XT- Series and AT-Series Alternator Packages will in most cases require an AltMount® Conversion Kit Upgrade.
- Choose wisely! Need more help? - call Balmar Technical Support at the number below!

**With the completion of these 5 steps, you have reviewed all the critical variables required to choose the correct charging system upgrade for your vessel.**

### Small Case Alternator Kit Selection Chart - Common Configurations

Balmar Product Family	Output	Mounting	Power Take Off	Alternator Part Number <sup>(1)</sup>	Balmar External Regulator	Temp Sensors	Alternator Kit Number <sup>(1)</sup> (includes Alternator, Regulator & Temp Sensors)	AltMount® Pulley Kit Required?	
6 Series <sup>(2)</sup>	70 A	1-2" Spindle	2.8 HP	621-70-XX	ARS-5-H <sup>(3)</sup>	MC-TS-A & MC-TS-B	621-VUP-70-XX	No	
		3.15" Saddle		60-70-XX			60-YP-70-XX		
	100 A	1-2" Spindle	4.0 HP	621-100-XX			621-VUP-100-XX		
		3.15" Saddle	60-100-XX	60-YP-100-XX					
	120 A	1-2" Spindle	4.8 HP	621-120-XX			621-VUP-120-XX		
		3.15" Saddle		60-120-XX			60-YP-120-XX		
	70 A, 24V	1-2" Spindle	5.6 HP	621-24-70-XX			MC-624-H	621-VUP-24-70-XX	Yes, If Dual Vee or Serpentine is Not Already Present See Page 11
		3.15" Saddle		60-24-70-XX				60-YP-24-70-XX	
XT-Series	170 A	1-2" Spindle	5.2 HP	XT-SF-170-XX	MC-614-H	XT-SF-170-XX-KIT			
		3.15" Saddle		XT-DF-170-XX		XT-DF-170-XX-KIT			
		Vortec		XT-VT-170-K6		XT-VT-170-K6-KIT			
AT-Series	220 A	1-2" Spindle	6.0 HP	AT-SF-200-XX		AT-SF-200-XX-KIT			
		3.15" Saddle		AT-DF-200-XX		AT-DF-200-XX-KIT			

(1) "XX" Pulley Designations: "SV" = 1/2" Single Vee, "DV" = 1/2" Dual Vee, "K6" = K6 Serpentine, "J10" = J10 Serpentine  
 (2) 6-Series Alternators are "Smart-Ready" and can be installed with or without an external Balmar Programmable Regulator.  
 (3) MC-614-H must be substituted when support for a second alternator or twin engines is required.

### Step 6: Select Additional Charging System Options

Now that you have selected an appropriate Balmar Alternator Kit, complete your purchase by adding a SG200 Battery Monitor and a Belt Buddy Tensioning Kit! See pages 12 and 27, respectively for details.





## 6-Series Alternators

### Designed for Recreational Applications

- Balmar's Top Selling Alternator Line
- 70A, 100A, 120A and 150A Versions
- Patented Smart Ready® Technology
- Dual Fan Cooling
- High Airflow Frame
- Maximum RPM: 12,000
- USCG Title 33, CE, ISO 8846 and SAE J1171 Certified
- Ideal for Modest Charging Upgrades

Balmar **6-Series Alternators** deliver high-output performance in a compact, small-case package and are available in all four common mounting configurations (see page 6).

While all Balmar's high-output alternators are designed and recommended for use with our multi-stage voltage regulators, the 6-Series Alternator utilizes Balmar's Smart Ready® Technology. If battery loads are relatively small and your engine is running frequently, the alternator's internal regulator may be sufficient to support your electrical needs without external regulation. If your vessel utilizes larger deep-cycle battery banks or the engine's duty cycle is less frequent (as is the case in most sailing applications), the 6-Series Alternator combines and works seamlessly with Balmar's ARS-5 Voltage Regulator or Max Charge Voltage Regulator.

Purchased either individually or as a charging kit, 6-Series Alternators can solve a multitude of charging problems at a reasonable price. All kits come with alternator, regulator and two temperature sensors.

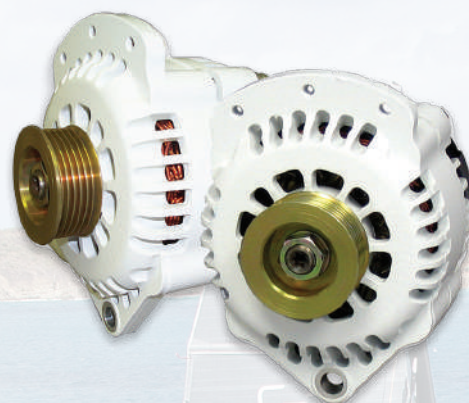

Smart Ready® 6-Series



Charging Kit

6-Series Output	Power Take Off	Mounting <sup>(3)</sup>	Individual Alternator Part Number <sup>(1)</sup>	Alternator Kit with ARS-5 Regulator <sup>(1)(4)</sup>	Alternator Kit with Max Charge Regulator <sup>(1)(2)(4)</sup>	Altmount® Pulley Kit Required?
70 A	2.8 HP	1-2" Spindle	621-70-XX	621-VUP-70-XX	621-VUP-MC-70-XX	No
		3.15" Saddle	60-70-XX	60-YP-70-XX	60-YP-MC-70-XX	
100 A	4.0 HP	1-2" Spindle	621-100-XX	621-VUP-100-XX	621-VUP-MC-100-XX	
		3.15" Saddle	60-100-XX	60-YP-100-XX	60-YP-MC-100-XX	
120 A	4.8 HP	1-2" Spindle	621-120-XX	621-VUP-120-XX	621-VUP-MC-120-XX	Yes, If Dual Vee or Serp is Not Present See Page 11
		3.15" Saddle	60-120-XX	60-YP-120-XX	60-YP-MC-120-XX	
150 A	5.2 HP	1-2" Spindle	621-150-XX	621-VUP-150-XX	621-VUP-MC-150-XX	
		3.15" Saddle	60-150-XX	60-YP-150-XX	60-YP-MC-150-XX	
70 A, 24V	5.6 HP	1-2" Spindle	621-24-70-XX	-	621-VUP-24-70-XX	
		3.15" Saddle	60-24-70-XX	-	60-YP-24-70-XX	

(1) "XX" Pulley Designations: "SV" = 1/2" Single Vee, "DV" = 1/2" Dual Vee, "K6" = K6 Serpentine, "J10" = J10 Serpentine.  
 (2) A Max Charge Regulator Kit is required for 24 volt, Dual-Alternator or Twin Engine Applications.  
 (3) Additional 6-Series mounting styles (J-180 and Vortec) are available and shown on Page 30.  
 (4) All Dual Foot Yanmar Kits include 6-0020 mounting kit.



## XT-Series & AT-Series Alternators Designed for Recreational Applications

- 170A or 220A in a Small Case Package
- Up to 140A at Idle Speeds
- Patented Smart Ready® Technology (XT-Series Only)
- Dual Fan Cooling, High Airflow Frame
- Ideal for Large Battery Banks
- USCG Title 33, CE, ISO 8846 and SAE J1171 Certified

AT-Series and the **New** XT-Series Alternators from Balmar bring together the latest innovations in alternator design to deliver incredible charging power in a compact, Marine-friendly package.

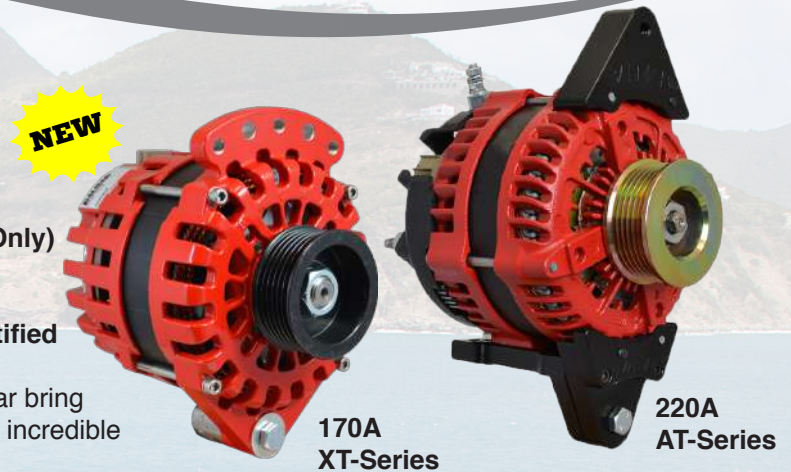

Advanced Braided Stator



Hairpin Stator



Traditional S-Wound Stator

The **New XT-Series 170A Alternator** family features a state-of-the-art, braided wire stator design to generate exceptional output in the smallest possible area. The XT-Series produces slightly more power than our previous AT-Series 165A design and operates 5°-10°C cooler. In addition, we've added Balmar's Smart Ready® internal regulator technology to provide an additional level of fault tolerance for cruising boaters. Available XT-Series mounting styles have been expanded to include the "Vortec" 9Si design found on many GM gasoline engines.

The **AT-Series 220A Alternator** family features a hairpin-wound stator design which uses densely wound square copper wire to generate up to 220A at 3,000 engine rpm. Hairpin-wound stators feature 96 slots - compared to 36 slots in a traditional S-wound stator - allowing the hairpin-wound stator to develop superior electromagnetic energy and efficiency to other traditional stator designs.

**XT-Series** and **AT-Series Alternators** may require a Tachometer Signal Stabilizer (Part No. 15-TSS) if your current tachometer is not adjustable. **XT-Series** and **AT-Series Alternators** should only be used in Dual Vee or Multi-Groove Serpentine belt configurations. Balmar's growing range of **Altmount® Serpentine Pulley Conversion Kits** shown on page 11 support all **XT-** and **AT-Series Alternators**.

XT / AT Series Output	Power Take Off	Mounting	Individual Alternator Part Number <sup>(1)(3)</sup>	Alternator Kit with Max Charge Regulator <sup>(2)</sup>	Altmount® Pulley Kit Required?
170 A	5.2 HP	1-2" Spindle	XT-SF-170-XX	XT-SF-170-XX-KIT	Yes, If DV or Serpentine is Not Present
		3.15" Saddle	XT-DF-170-XX	XT-DF-170-XX-KIT <sup>(4)</sup>	
		Vortec	XT-VT-170-K6	XT-VT-170-K6-KIT	
220 A	6.0 HP	1-2" Spindle	AT-SF-200-XX	AT-SF-200-XX-KIT	
		3.15" Saddle	AT-DF-200-XX	AT-DF-200-XX-KIT <sup>(4)</sup>	
		4" Saddle	AT-DF4-200-XX	AT-DF4-200-XX-KIT	

(1) "XX" Pulley Designations: "DV" = 1/2" Dual Vee, "K6" = K6 Serpentine, "J10" = J10 Serpentine.

(2) Kit Includes AT-Series Alternator, Max Charge Regulator (MC-614-H) and Temperature Sensors (MC-TS-A, MC-TS-B).

(3) The AT-Series Alternator may require a Tachometer Signal Stabilizer (Part No. 15-TSS) if your current tach is not adjustable.

(4) All Dual Foot Yanmar Kits include 6-0020 Mounting Kit.



## AltMount® Serpentine Pulley Conversion Kits

Balmar's Patented AltMount® Serpentine Pulley Kits Facilitate the use of Balmar High Power Alternators

- Better Power Transfer
- Reduced Vibration and Belt Dust
- Quieter Motoring

Single Vee pulleys can only support alternator power loads (PTO) of up to 100A for 12V applications (45A for 24V applications). See the chart on page 6. A serpentine pulley provides greater surface contact between the belt and pulley, and thus can accommodate much higher PTO requirements.



U.S. Patent Nos. 8.939.855 and D654.778

**AltMount® Pulley Kits** are designed uniquely for each engine listed on the adjacent page, including all the hardware required to complete the installation. The system is installed by placing and fastening each conversion pulley over the existing crank and water pump pulleys. Two serpentine belts are provided with each kit.

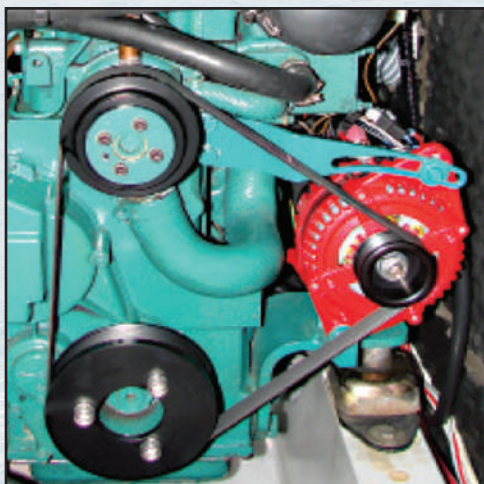

**Volvo**

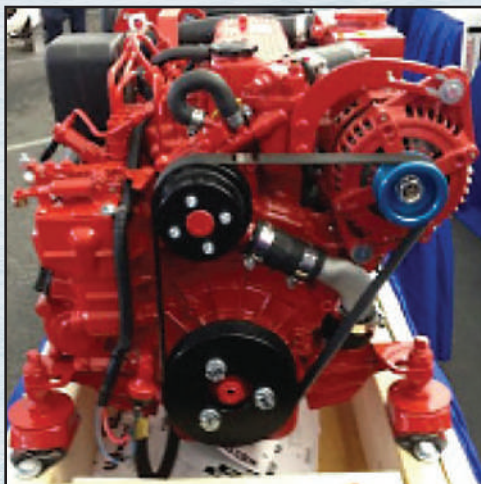

**Westerbeke**



**Yanmar**

**AltMount® Second Alternator Kits** provide the ability to add a high-output second alternator for increased charging output from a single engine. These kits are an ideal upgrade for serious cruisers and others who depend on the propulsion engine for fault tolerance or substantial battery charging needs.

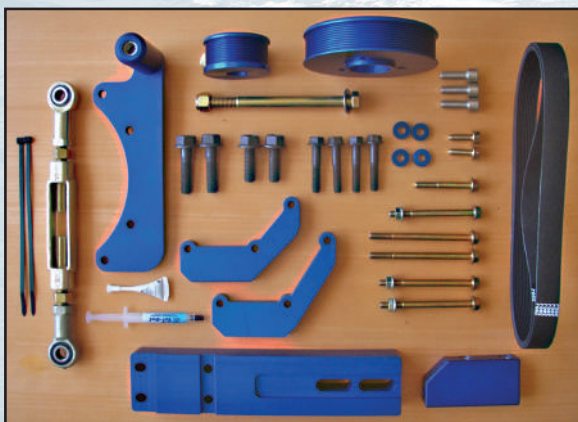

**Second Alternator Kit** (For use on Yanmar engines with 95-Series Alternators only.)



**NEW  
LOWER  
PRICING**

*We Know How To Charge Your Batteries*

YANMAR SERPENTINE PULLEY KITS	
Engine Models	AltMount Kit #
2GM20	48-YSP-3GM-C
2GM20-F	48-YSP-3GM-B
2YM15	48-YSP-3YM-A
3GM	48-YSP-3GM-C
3GM30	48-YSP-3GM-A
3GM30-F	48-YSP-3GM-B
3GM-F	
3HM	48-YSP-3HM-A
3HM35	
3HM35-F	48-YSP-3HM-B
3HM-F	
3JH2-E	48-YSP-3JH-C
3JH2-TE	
3JH3	48-YSP-3JH-E
3JH4-E	48-YSP-3JH-A
3JH5	
3YM20	48-YSP-3YM-A
3YM30	48-YSP-3YM-B
4JHE, TE, HTE, DTE	48-YSP-4JH-F
4JH	
4JH2, TE, HTE, DTE, UTE	48-YSP-4JH-E
4JH3, TE, HTE	48-YSP-4JH-D
4JH4HTE, TE, DTE	48-YSP-4JH-B
4JH4-E	48-YSP-3JH-A
4JH5, 4JH5-E	
4LH-A	48-YSP-4LH-A
6LY, 6LYA-STP, 6LY2-STP	48-YSP-6LY-A

YANMAR 2 <sup>ND</sup> ALTERNATOR KITS (For Use with 95-Series Alternators Only)	
Engine Models	AltMount Kit #
4JH3	48-YDA-4JH-A
4JH4-HTE, TE	48-YDA-4JH-B
4JH4-E	48-YDA-4JH-C
6LY, 6LY-2	48-YDA-6LY-A

**AltMount® Kits** are designed to be used with Balmar alternators. We cannot guarantee fit with other alternators.

FORD LEHMAN SERPENTINE KITS	
Engine Models	AltMount Kit #
FL80, FL120	48-FSP-100

NANNI SERPENTINE PULLEY KITS	
Engine Models	AltMount Kit #
N3.30	48-NSP-3.3
N4.38	
N4.4, N4.5	48-NSP-4.6
N4.6	
N4.85	48-NSP-100
N100	

PERKINS SERPENTINE PULLEY KITS	
Engine Models	AltMount Kit #
4107	48-PSP-410-A
4108	
6.354	48-PSP-6354
PERAMA	48-VSP-MD-A
M20, M25, M30	
PRIMA	48-VSP-PR-A
M50, M60, M80	

VOLVO SERPENTINE PULLEY KITS	
Engine Models	AltMount Kit #
2001, 2002, 2003(T) 3 Pulleys	48-VSP-2001
2001, 2002, 2003(T) 2 Pulleys	48-VSP-2001R
D2-55A, B, C, D, E, F	48-VSP-D2-A
MD2030	48-VSP-MD-A
MD2040	48-VSP-MD-B
PRIMA	48-VSP-PR-A
TMD-22	

WESTERBEKE SERPENTINE KITS	
Engine Models	AltMount Kit #
12C, 12D	48-WSP-12C
13A	48-WSP-21
18	48-WSP-18
20B	48-WSP-12C
21	48-WSP-21
21A	48-WSP-18
27	48-WSP-21
27A	48-WSP-18
30B	48-WSP-12C
30C, 33	48-WSP-33
35A, 35B, 38B	48-WSP-18
40	48-WSP-40
42B	48-WSP-18
44A, 44B, 44C	48-WSP-44A
46	48-WSP-46
71	48-WSP-71
82	

UNIVERSAL SERPENTINE KITS	
Engine Models	AltMount Kit #
M25, M25XP	48-USP-M25
M25XPB	48-USP-M35B
M35	48-USP-M-B
M35B	48-USP-M35B
M40B	
M50, M50A, M50B	48-USP-M50
5444	
5432	48-USP-5432

VETUS SERPENTINE PULLEY KITS	
Engine Models	AltMount Kit #
M4.15, M4.17	48-VSP-M4.17
M4.55	



**New AltMount® Pulley Kits** are constantly under development. If you do not see a kit for your engine, check the Balmar website or call our Technical Support line for the latest list of available kits.



**NEW**



## SG200 Battery Monitor

Balmar's Expandable, Next Generation Monitor

### Learns & Displays All Critical Battery Parameters

- State of Charge (SoC%)
- State of Health (SoH%)
- Charge/Discharge Current Flow
- Time Remaining
- History, Faults & Alerts

### Support for All Common Battery Chemistries & Voltages

- Including Lead Acid, Lithium (LiFePO<sub>4</sub>), Standard AGM, TPPL AGM, Carbon Foam AGM, and GEL Batteries
- Supports 12V-48V Battery Banks

### Intelligent, Self-Calibrating Accuracy

- Typically 97% Accurate within 2 Cycles
- Auto-Calibrating
- Does not Lose Accuracy With Age

### Large, Bright Color Display

- Sunlight Readable, Configurable & Dimmable
- 60 Degree Viewing Angle
- Fits in Standard 2 1/16" Gauge Socket

### Expandable Architecture

- Supports Multiple Displays (*Optional*)
- Supports Multiple Battery Banks (*Optional*)
- Standard Support for 2 Start Batteries (*Voltage Only*)
- Simple, Easy-to-Install Point-to-Point Network

### Optional Smartphone/Bluetooth® Gateway

- Free iOS and Android Apps  
(*Requires Bluetooth® Gateway PN SG2-0300*)
- View All Parameters on your Phone
- Download Product Updates

Balmar has applied recent technology advances to introduce a next generation battery monitor. The SG200 is quite simply the most accurate battery monitor available today. Balmar has combined the best features of its 1st generation Smartgauge™ with many advantages of a shunt-based amp-hour counting system. Further, we've designed a device architecture which facilitates multiple Displays or multiple SmartShunts to be added to the network – allowing the boater to monitor multiple energy storage banks simultaneously from multiple locations.

In addition, the SG200 Color Display is easy to read, configurable and fits any standard 2 1/16" gauge socket. Now you can determine your battery's condition from anywhere on the vessel or vehicle with multiple displays, or simply add the optional Bluetooth® Smartphone App to keep information in your pocket!





## SG200 Battery Monitor



State of Charge (SoC%)	State of Health (SoH%)	Charge/Discharge Amps	Time Remaining
Accurate display of your battery's State of Charge after just two discharge cycles.	Proprietary self-calibrating algorithm determines how your battery has aged from its original capacity.	Displays the real-time current flowing in or out of your house battery.	Time remaining until empty when discharging, or time remaining until full when charging.

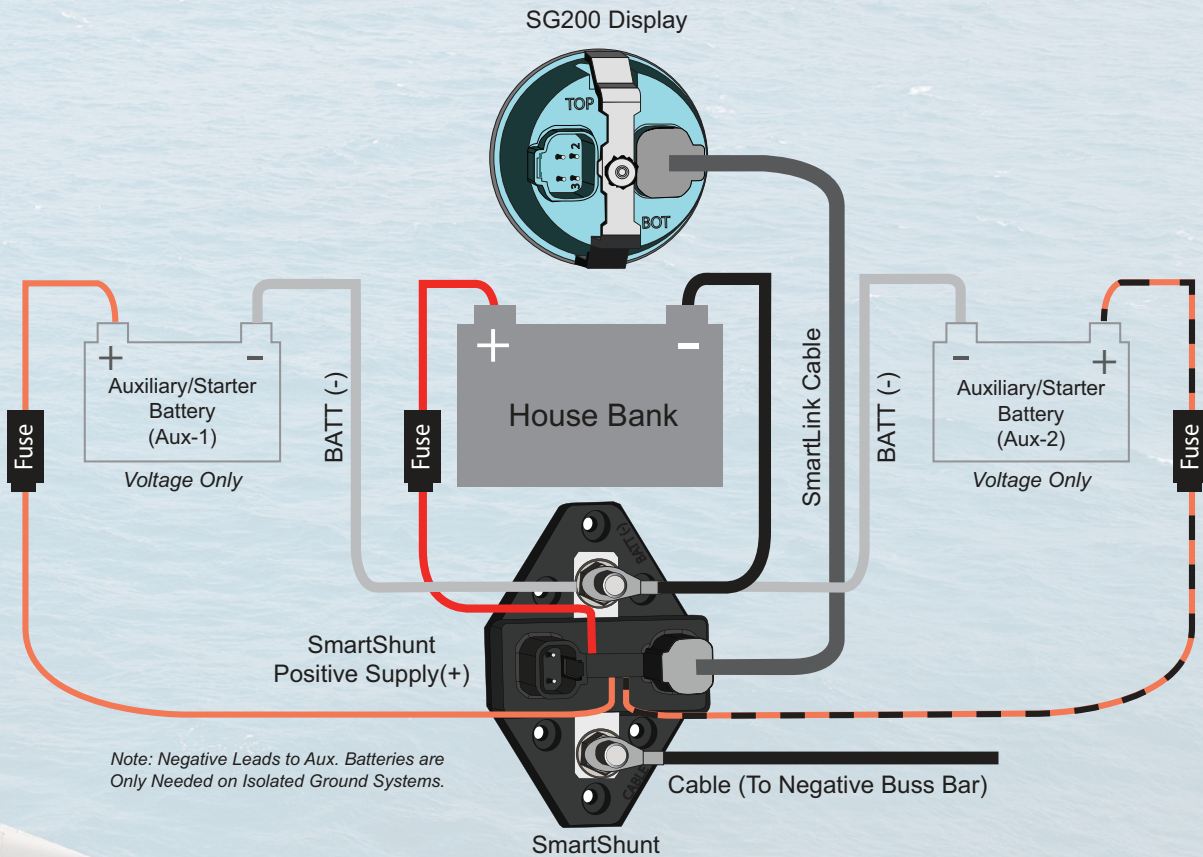

Part Number	Description	Explanation / Includes
SG200	Battery Monitor Kit, 12V-48V	Standard Unit for Initial Purchase: Includes Color Display, SmartShunt, SmartLink Com Cable
SG2-0100	SmartShunt, SG200, 350A, 12V-48V	Add a SmartShunt for Additional Bank: Includes SmartShunt and SmartLink Com Cable
SG2-0200	Color Display, SG200, 2 1/16"	Add a Color Display to an existing SmartLink Network
SG2-0300	Gateway, SG200, Bluetooth®	Optional 39" Bluetooth® Gateway for Smartphone App
SG2-0400	Com Cable, SG200, 10m	Optional SmartLink Com Cable (10 meter) for Longer Cable Runs
SG2-0402	Mounting Plate, SG200	Mounting Adapter from SmartGauge™ to SG200 Display



# SG200 Battery Monitor

## Balmar's Expandable, Next Generation Monitor

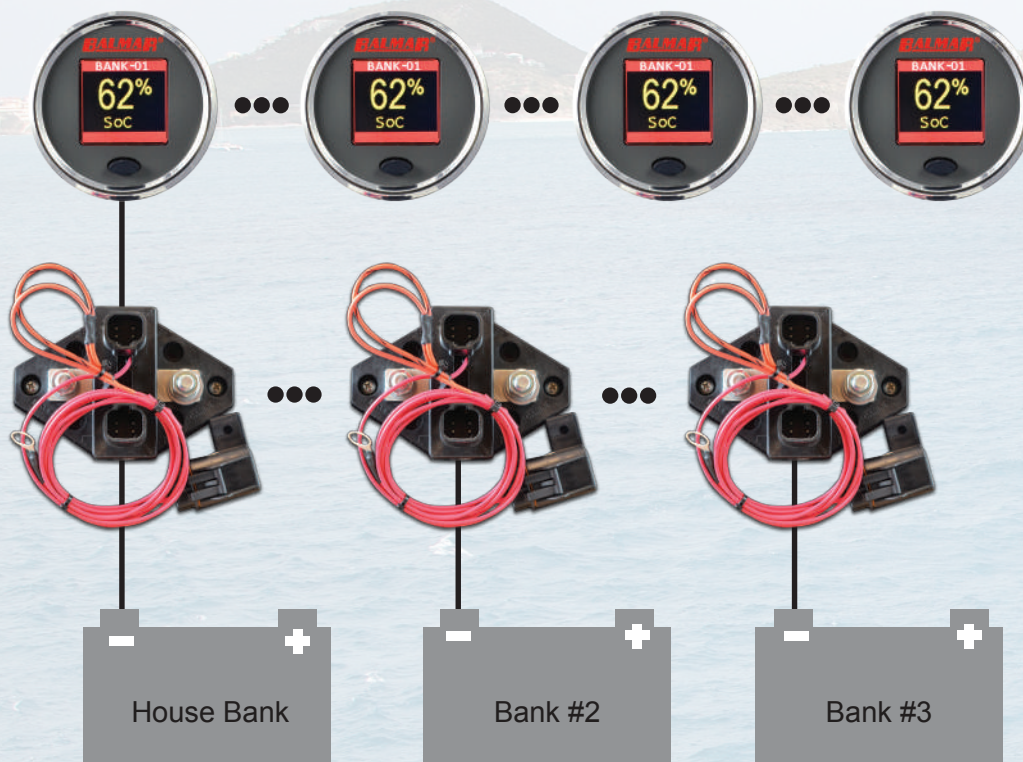

- Build your own battery monitoring network!
- Add Color Displays for viewing data in different locations.
- All battery information can be displayed anywhere on the SmartLink network.
- For additional flexibility, purchase the optional Bluetooth® Gateway and download Balmar's Smartphone App.
- Add SmartShunts if you have multiple banks.
  - Stern Thruster
  - Bow Thruster
  - House Bank #2

1. **Intelligent, Self-Calibrating Accuracy:** The SG200 quickly adapts to the specific characteristics of your battery and maintains accuracy over the life of your battery.
2. **No Synchronization:** SG200 does not drift in accuracy with multiple Partial State of Charge (PSoC) cycles. Synchronization is not needed to ensure the SG200 is accurate!
3. **Revolutionary State of Health (SoH%):** All batteries age, diminishing in capacity over time. The SG200 accounts for aging factors to determine State of Health (SoH) as a percentage of the battery's original capacity. The SG200 also adjusts for changes in battery capacity to account for aging. This means that you no longer run into the real, inevitable problem of discharging batteries below a safe State of Charge before charging. Many battery owners think they are treating their batteries well, but are unaware they are chronically discharging the batteries beyond a point which causes "sulfation" and significantly shortens battery life and capacity.
4. **Works With all Major Battery Types:** Charge profiles are characterized for Standard Lead Acid, Lithium (LiFePO<sub>4</sub>), Standard AGM, Thin Plate Pure Lead AGM (TPPL), Carbon Foam AGM and GEL batteries.
5. **Embedded History, Faults & Alerts:** Provides a complete picture of your dual purpose battery system.

History	Alerts (User Defined)	Faults (System Defined)
Min / Max SoC%	Min / Max SoC%	Over Current
Min / Max Current	Min / Max Current	Over Voltage
Min / Max SoH%	Min / Max SoH%	Under Voltage
Min / Max Voltage	Min / Max Voltage	Low SoC%
Min / Max Power	Min / Max Aux-1 & Aux-2 Voltage	-



## SG200 Battery Monitor

The SG200 solves a number of traditional weaknesses found in battery monitors. For example, have you ever heard the following?

- **I know my batteries are in good shape, I never discharge my batteries below 50% State of Charge (SoC%).**

If you are using a traditional amp-hour meter, there are weaknesses in current technology which could be a problem. There are two issues that may make the SoC% reading on your traditional battery monitor inaccurate.

1. Batteries age and lose capacity over time. When the capacity of your batteries diminish due to aging, the SoC% reading on a traditional meter is going to be higher than is actually the case. In other words, a traditional amp-hour meter only counts amps – which means as your battery ages and the available amps decrease, your amp-hour meter doesn't know it! This condition could send your battery unwittingly into the sulfation zone and shorten its life more rapidly.
2. If you are not fully charging your batteries on a daily basis, the State of Charge reading will drift in value, and become increasingly inaccurate. The more partial charge cycles (PSoC) occurring between full charge cycles with traditional battery monitor, the bigger the measurement drift.

The effect of these two problems is that batteries can die a premature death because of inaccurate monitoring. The SG200 minimizes these issues by compensating for the inherent aging affects of the battery and partial cycles.

- **My batteries are in great shape, because they are only two years old.**

Prior to Balmar's introduction of the SG200, the only way to know the accurate condition of a battery would be to do a controlled, 20-hour discharge test. Few people have the time or inclination to make that investment, so it is rarely accomplished.

SG200 can show you an accurate State of Health (SoH%). If your batteries are failing, you will know it before a battery failure ruins your boating day. Our SoH% calculations are chemistry-specific and comprehensive learning your battery over time to return the most accurate measurements available today. The SG200 gets more accurate, (not less) with time.

### SG200 Specifications

<b>Standard Configuration:</b>	1 Bank per SmartShunt Device 2 Start/Auxiliary Voltage Sense Lines (Up to 32 devices including Displays and SmarShunts can be added to a single network.)	<b>Display Values:</b>	State of Charge (SoC%) State of Health (SoH%) Voltage (V) Charge/Discharge Current (A) Time Remaining (Hrs) History, Faults & Alerts (Consult User Manual)
<b>Supply Voltage Range:</b>	8V - 60V DC	<b>Max Ah Capacity:</b>	1250 Ah (per SmartShunt)
<b>Average Supply Current:</b>	Display On: 20 mA @12V Sleep Mode: 10 mA @12V	<b>Communications Cable:</b>	4 wire, 22 AWG, Shielded 4 pin Deutsch DT Style
<b>SmartShunt Operating Temperature:</b>	-40°C - +85°C (-40°F - +185°F)	<b>Grounding:</b>	Negative Battery Connection
<b>SmartShunt Max Current:</b>	600A Instantaneous (10 minutes @ ambient) 350A Continuous (For Higher Currents Consult User Manual)	<b>SmartShunt Dimensions:</b>	Length: 4.87" (123.7 mm) Width: 3.34" (84.8 mm) Height: 2.01" (50.9 mm)
<b>Weight:</b>	SmartShunt: 0.62lbs Color Display: 0.16lbs	<b>Color Display Dimensions:</b>	Bezel Diameter: 2.37" (60 mm) Base Diameter: 2.05" (52 mm) Depth with Cable Attached: 2.75" (70 mm)
<b>Standards Compliance:</b>	CE EMC Directive 2014/30/EU RoHS 2 Directive 2011/65/EU	<b>Protection Rating:</b>	IP65 (Display), IP67 (SmartShunt)



## Smartgauge™ Battery Monitor

- Advanced Battery Fuel Gauge
- Monitors State-of-Charge Percentage (SoC%) and Voltage of the Primary Battery
- Monitors Voltage of a Second Battery
- Self-Calibrating, No Shunt Required
- Accurate within 5% after just a Few Cycles
- High/Low Voltage and SoC% Alarms

Balmar's Smartgauge™ Battery Monitor provides highly accurate monitoring at a similar cost of standard ampere hour counting monitors. The easy-to-understand display, dependable State-of-Charge Percent (SoC%) reading and its ease-of-use mean that even the most technically challenged crew member can understand just how much power is left in the battery. Smartgauge™ is changing how boaters think about battery monitors.

### Three Key Smartgauge™ Advantages:

#### Ease of Installation

Smartgauge™ connects with just three 14 gauge wires – no need to crimp heavy battery cables for the installation of a shunt.

#### Ease of Use

Just select your battery type at setup and Smartgauge™ does the rest! Smartgauge™ automatically adjusts for 12V or 24V operation.

#### Accuracy

Smartgauge™ is proven in independent testing by Enersys® to be accurate within 3% after 6 months of use. Smartgauge™ automatically adjusts for temperature conditions and the battery's health.

The Smartgauge™ Battery Monitor works with Standard Flooded, Deep Cycle Flooded, Sealed Maintenance Free, Gel Cell, AGM and Lead Acid Hybrid batteries. Smartgauge™ does not monitor Lithium Ion batteries.



Displays battery voltage to within 0.05V (12 or 24V DC systems) for two battery banks.



Displays the capacity remaining in the primary battery as a percentage figure.

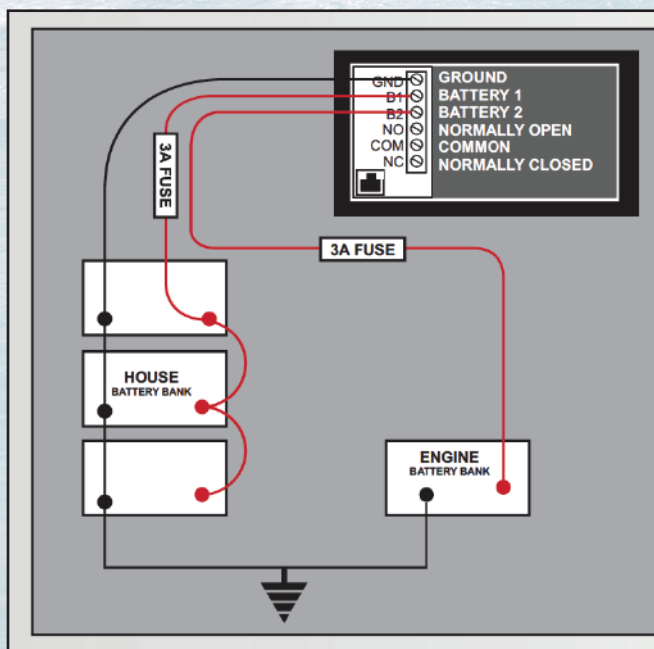

### Smartgauge™ Specification

Balmar Part Number	44-SG-12/24	
Supply Voltage Range	8-40V DC	
Supply Current	Sleep Mode	5mA
	Display On	<15mA
Operating Temperature Range	-25 TO +85C	
Accuracy	State of Charge (Charge)	+/- 10%
	State of Charge (Discharge)	+/- 5%
	Voltage	+/- 0.5%
Dimensions	Front Panel	L 4.3" (110mm) x H 3.0" (76mm)
	Body	L 3.7" (95mm) x H 2.5" (64mm)
	Total Depth	1.1" (28mm)
	Weight	7oz. (0.2 Kg)
Protection Rating	IP20 (Front Panel IP651)	
Standards Compliance	CE, ISO7637-2	



## Smart Ready<sup>®</sup> Retrofit For Yanmar Engines Equipped with Valeo Alternators

Now Yanmar Owners can add Balmar Smart Regulation without Disposing of the Valeo Alternator Present on Recent Production Engines.

- Reduce the Cost of Adding Balmar by Half
- Balmar's Patented Smart Ready<sup>®</sup> Design
- Internal Regulator Provides "Come-Home" Capability
- Perfect for AGM or Lithium Battery Banks
- Kits Come with all Required Conversion Parts



Valeo Retrofit Kits	
Part Number	Kit Includes
30-SR12-02	Internal Regulator Retrofit Kit Only
ARS-5-VL-01	30-SR12-02, ARS-5-H, Temp Cables
MC-614-VL-01	30-SR12-02, MC-614-H, Temp Cables
MC-624-VL-01 <sup>(1)</sup>	Dummy Regulator, MC-624-H, Temp Cables

(1) MC-624-VL-01 (24V Version) is not Smart Ready<sup>®</sup>

### Easy Installation:

Required Tools: 7mm & 8mm Nut Drivers, 13mm Wrench. Kit includes Tool for Installing Brushes.

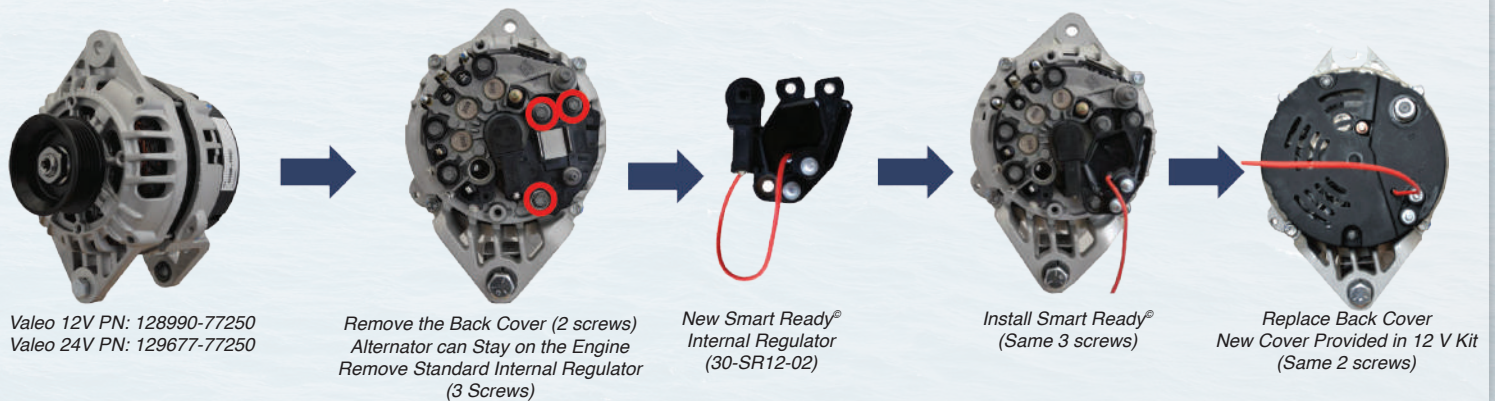

Installation of Balmar's Multi-Stage, Smart Regulators delivers the benefits found in shore power charging systems for your on-board, alternator-based charging system including:

- 30% Faster, More Complete Charging
- User-Selectable Preset Battery Programs
- Advanced Programming Modes
- Over-Temperature Protection
- Detuning Capabilities for Belt Load Management and Reducing Alternator Wear
- Longer Battery and Alternator Life
- Less Fuel Consumption

Optimize Your Charging System and Experience the Balmar Difference!

### Yanmar Engine Models Equipped with a Valeo 120A/12V Alternator

Model #	Serial Number
2YM15	E05891 & after
3YM20	E11910 & after
3YM30E	E20848 & after
3JH5E	E12749 & after
4JH5E	E14236 & after
4JH4-TE	E15602 & after
4JH4-THE	E24940 & after
4JH4-HTE1	E40232 & after
4JH3-DTE	E35417 & after



## Balmar Voltage Regulation Technology

High output alternators are an important part of your system for battery care, but they are definitely not the only part. Without proper voltage regulation, battery charging can be a slow process, or even worse, an ideal recipe for early battery failure.

All commercial alternators come with an internal rectifier/regulator circuit that:

- (1) converts AC current generated by the alternator to DC current, and
- (2) fixes the voltage output to a static level – typically 14.6 volts.

There are several deficiencies with internal regulators:

- (1) Not all battery technologies want to receive 14.6 volts.
- (2) All battery types have an optimal charging “profile”, which means they want different voltages and currents at different stages of their charging cycle, as well as variations when battery temperatures change.
- (3) Once fully charged, batteries can overheat if they are supplied with continuous current at a fixed charge voltage.

Balmar’s patented Max Charge and ARS-5 Voltage Regulators provide a dynamic method for monitoring battery condition and apply the correct level of alternator control (voltage and current) to ensure that your batteries are charged quickly and safely.

During engine operation, Balmar regulators step through the following stages to ensure proper battery charging:

**Stage 1: Start Delay** – After engine startup, the regulator waits for several seconds before applying field current to the alternator. This allows the engine and belts an opportunity to warm up before the alternator load is applied.

**Stage 2: Soft Ramp** – The regulator slowly increases field excitation of the alternator to reduce belt stress.

**Stage 3: Bulk Charging** – The regulator increases field output to the maximum safe level, allowing the alternator to reach maximum amperage output based on the target limits of the battery type being charged. Target voltage ranges from 14.1V to 14.6V depending on the battery type selected (24V bulk charging voltages range from 28.2V to 29.2V). Bulk time is a factory set at 18 minutes, and is fully adjustable in advanced programming mode.

**Stage 4: Calculated Bulk** - At the end of the set bulk time period, the regulator calculates the state of charging based on the alternators ability to reach and maintain target voltage, and the percentage of field output required to maintain that voltage. This stage will maintain bulk charging until all criteria are met, at which point the regulator will ramp down to absorption voltage.

**Stage 5: Absorption Voltage** – Typically two tenths of a volt below bulk target voltage, absorption voltage allows the alternator to drive current into the almost fully charged batteries without overcharging. Absorption time is preset at 18 minutes, and is adjustable in the regulator’s advanced programming mode.

**Stage 6: Calculated Absorption** – At the end of the set absorption time period, the regulator calculates the state of charging based on the alternator’s ability to reach and maintain the target voltage and the percentage of field output required to maintain that voltage. This stage will maintain the absorption charging voltage until all criteria are met, at which point, the regulator will ramp down to float voltage.





**Stage 7: Float Voltage** – Typically one (1) volt below bulk target voltage, float voltage allows the alternator to drive current into fully charged batteries sufficient to replace any battery capacity used while under way. Float time is preset at 18 minutes, and is adjustable in the regulator’s advanced programming mode.

**Stage 8: Calculated Float** – At the end of the set float time period, the regulator calculates the state of charging based on the alternator’s ability to maintain the target float voltage and the percentage of field output required to maintain that voltage. If all of the calculation criteria are met, the regulator will continue to maintain float voltage. If the calculation indicates that the alternator is failing to maintain battery voltage, the regulator will return to absorption voltage.

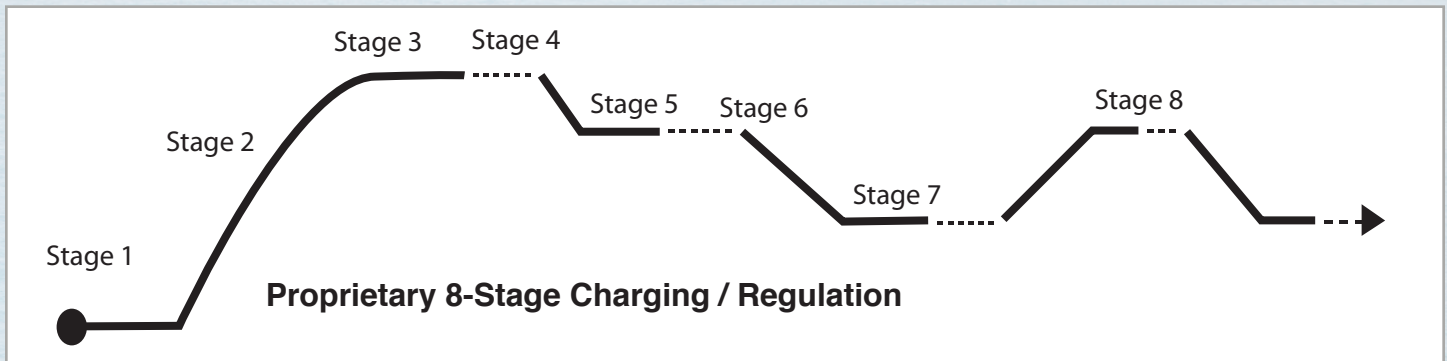

## Additional Features

### User-Selectable Preset Battery Programs

Balmar provides multiple charge profiles to ensure optimal charging. Simply select the battery program that matches your battery technology. The Max Charge regulator family contains 8 preset charge profiles, including a new standard program for lithium batteries. The ARS-5 contains 5 preset profiles. See the chart on page 16 for a listing of battery programs.

### Advanced Programming Modes

Balmar multi-stage regulators feature a broad range of advanced regulator adjustments. By accessing the advanced programming function, the user can modify charging times and voltages in all stages of charge, adjust start delay times, temperature compensation limits, temperature compensation slopes, and modify set points for alternator over-temperature response.

### Alternator and Battery Temperature Sensing and Control

Balmar multi-stage regulators have the ability to automatically correct charging output to ensure that batteries are properly charged regardless of ambient temperature. If battery temperatures exceed safe operating levels, Max Charge and ARS-5 Voltage Regulators will automatically reduce charging outputs to avoid dangerous thermal runaway conditions.

### Belt Load Management

Balmar multi-stage regulators can protect the engine and belt by enabling the user to de-rate the alternator’s output in small increments by adjusting the Belt Load Manager. Adjustable in 5% increments, the Belt Load Manager reduces the regulator’s field pulse bandwidth, thereby reducing load on the drive belt. The Belt Load Manager can also be used to protect the alternator in applications where battery capacity exceeds ideal charging ratios.



# Balmar Max Charge and ARS-5 Voltage Regulators

## Max Charge MC-614 Voltage Regulator

- 8 Selectable Programs for Marine Batteries
- 15 Amp Maximum Field Current
- Advanced Programming Modes (see page 19)
- Alternator & Battery Temperature Sensing & Control
- Exclusive Belt Load Manager Function
- Bright LED Display and Easy Programming Mode
- Can be Used in Twin-Engine Applications with Centerfielder II



## Max Charge MC-624 Voltage Regulator

- Designed for 24 Volt Applications
- 10 Amp Maximum Field Current
- Can be Used in Twin-Engine Applications
- All the Same Functions as the MC-614



## Max Charge MC-612-Dual Voltage Regulator

- Designed to Control 2 Alternators on a Single Engine
- Dual Alternator & Battery Temperature Sensing
- Twin 54" Wiring Harnesses Provided
- All the Same Programming Functions as the MC-614



## ARS-5 Voltage Regulator

- 5 Selectable Programs for Marine Batteries
- 9 Amp Maximum Field Current
- Appropriate for 6-Series Alternators (150A and below)
- Single Engine, Single Alternator Applications Only
- Similar Programming Functions as the MC-614



Preset, Multi-Stage Battery Programs	Balmar Regulators				Digital Duo Charge	Dual Engine Centerfielder
	12 Volt			24 Volt		
	ARS-5	MC-614	MC-612-DUAL	MC-624		
Part Number:	ARS-5	MC-614	MC-612-DUAL	MC-624	DDC-12/24	CFII-12/24
Universal Factory Program, Deep Cycle Flooded, Gel Cell, Absorbed Glass Mat (AGM) and Spiral Wound Flooded (Optima)	Yes	Yes	Yes	Yes	Yes	Yes
Standard Flooded, Halogen Systems, Lithium	-	Yes	Yes	Yes	Yes	Yes
Balmar Alternator Models						
6-Series Alternators (70A-150A)	Yes	Yes	Yes	Yes	Yes	Yes
AT-Series Alternator (165A-200A)	-	Yes	Yes	-	Yes	Yes
9-Series Large Case Alternators (140A-310A)	-	Yes	Yes	Yes	Yes	Yes
Multiple Alternator/Engine Configurations						
Dual Engine, One Alternator Each	-	Yes (qty 2)	-	Yes (qty 2)	Yes	Yes
Single Engine, Two Alternators	-	-	Yes	Yes (qty 2)	Yes	Yes

Complete part number listings and dimensional specifications are found on pages 30-38.



## Single-Stage Regulators

For vessels with nominal battery loads and/or applications where charging times are too short to benefit from the intelligence of multi-stage regulators, a single-stage regulator may be satisfactory.

### BRS-2T Single-Stage Voltage Regulator

- Available in 12 Volt and 24 Volt Models
- Adjustable Target Voltage to Address Battery Types
  - **BRS-2T-12-H** - Adjustable from 13.5V - 14.5V
  - **BRS-2T-24-H** - Adjustable from 26.5V - 29.5V



### ERS-KIT Single Stage Regulator

- 14.1 Volts, Non-Adjustable
- Ideal Backup Regulator
- Kit includes Terminals to Connect to a Balmar 12V Regulator Harness

## Regulator Accessories

### Temperature Sensor Cables

- Provided with All Alternator/Regulator System Packages
- Interchangeable for 12 Volt and 24 Volt Systems
- For use with either Max Charge or ARS-5 Voltage Regulators
- Battery Sensor can be used with the Digital Duo Charge
  - **MC-TS-A** - Alternator Cable, 54" Length
  - **MC-TS-A80** - Alternator Cable, 82" Length
  - **MC-TS-B** - Battery Cable, 240" Length



### Spike Protectors

- Transient Spike Protectors Add System Safety
- Fused Diodes Will Fail Prior to Alternator Diode Damage
- Install Between the Alternator "P" and "N" Terminals
  - **TSP-12** - 12 Volt, 10A Fuse
  - **TSP-24** - 24 Volt, 10A Fuse



### Replacement Regulator Wiring Harnesses

All Balmar Regulators can be purchased with or without a wiring harness.

Replacement wiring harnesses can also be purchased separately.



Alternator Families	Length	Volts	Harness Number
6-Series, XT-Series, AT-Series & 9-Series	54"	12V	1010
		24V	1012
	120" <b>NEW</b>	12V	1020
		24V	1022
94-Series	54"	12V	1011
		24V	1013
7-Series, 97-Series & 98-Series	54"	12V	1014
		24V	1016



## Digital Duo Charge: DDC-12/24

### For Multi Bank Charging

- The DDC is a Solid State Battery Combiner
- Control Voltage and Current between House and Start Batteries
- Eliminates the Need for an Isolator, Relay or a Manually Operated Battery Switch
- Used in Concert with Max Charge or ARS-5 Regulators
- Can also be Employed without a Balmar Regulator
- Works in Both 12V and 24V Applications
- House and Start Batteries can be different technologies
- Start Battery Temperature Sensing Available with the MC-TS-B Sensor Cable
- 4 Battery Programs Supported for the Start Battery: Standard Flooded, Deep Cycle Flooded, AGM and Gel Cell



The **Digital Duo Charge** (“DDC”) provides a “hands off” solution for charging two battery banks without the use of problematic isolators or manual battery switches.

During charging the DDC-12/24 monitors voltage at the house battery. When voltage exceeds the set minimum (typically 13.2V in a 12V system and 26.4V in a 24V system) the DDC automatically engages, providing up to 30A charge current to the starting battery. When no charge source is present, the DDC separates the batteries so the starting battery won't be accidentally discharged into the house battery. An optional solenoid control enables higher start battery charging output when required.

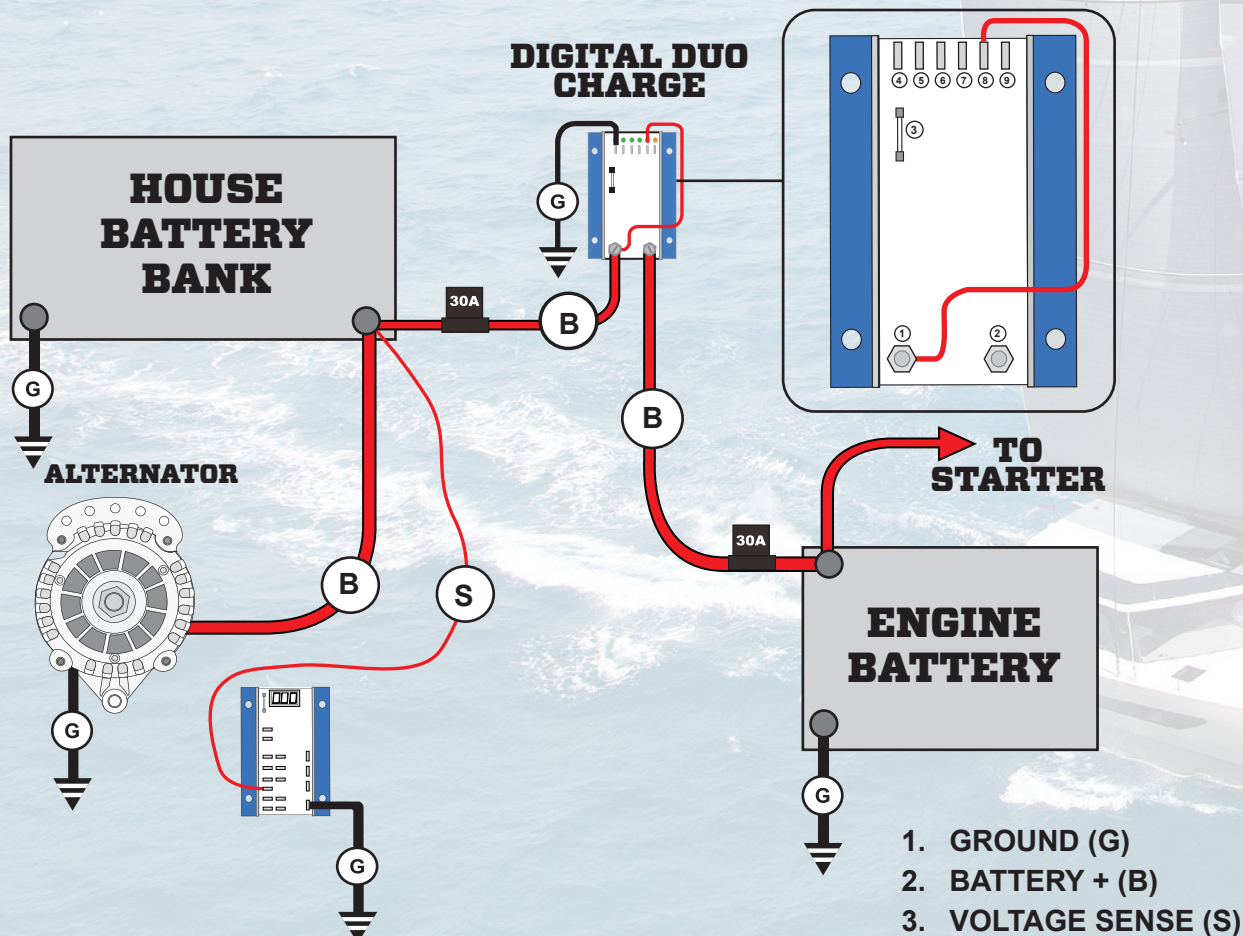



## Centerfielder II: CFII-12/24 For Balanced Twin Engine Charging

- Balances Charging in Twin Engine Applications
- Eliminates Alternator Chatter by Unifying Field Current
- For Use with Max Charge Regulators Only
- Works in Both 12V and 24V Applications
- Includes Upgraded Regulator Power Wires and Fusing
- Isolates Alternators and Regulators when only One Engine is Running
- Can be Used with the Digital Duo Charge to charge a Second Battery



The **Centerfielder II**, when used with Max Charge Regulators, balances twin engine charging systems by monitoring the port and starboard voltage regulators. When both alternators and regulators are working, the Centerfielder II automatically designates the starboard regulator as dominant for both alternators – making it possible to charge a single house battery bank with the combined output of both alternators.

The **Centerfielder II** eliminates the “yo-yo effect” of two regulators repeatedly turning on and off as the battery approaches target voltage because the two systems are not working in concert.

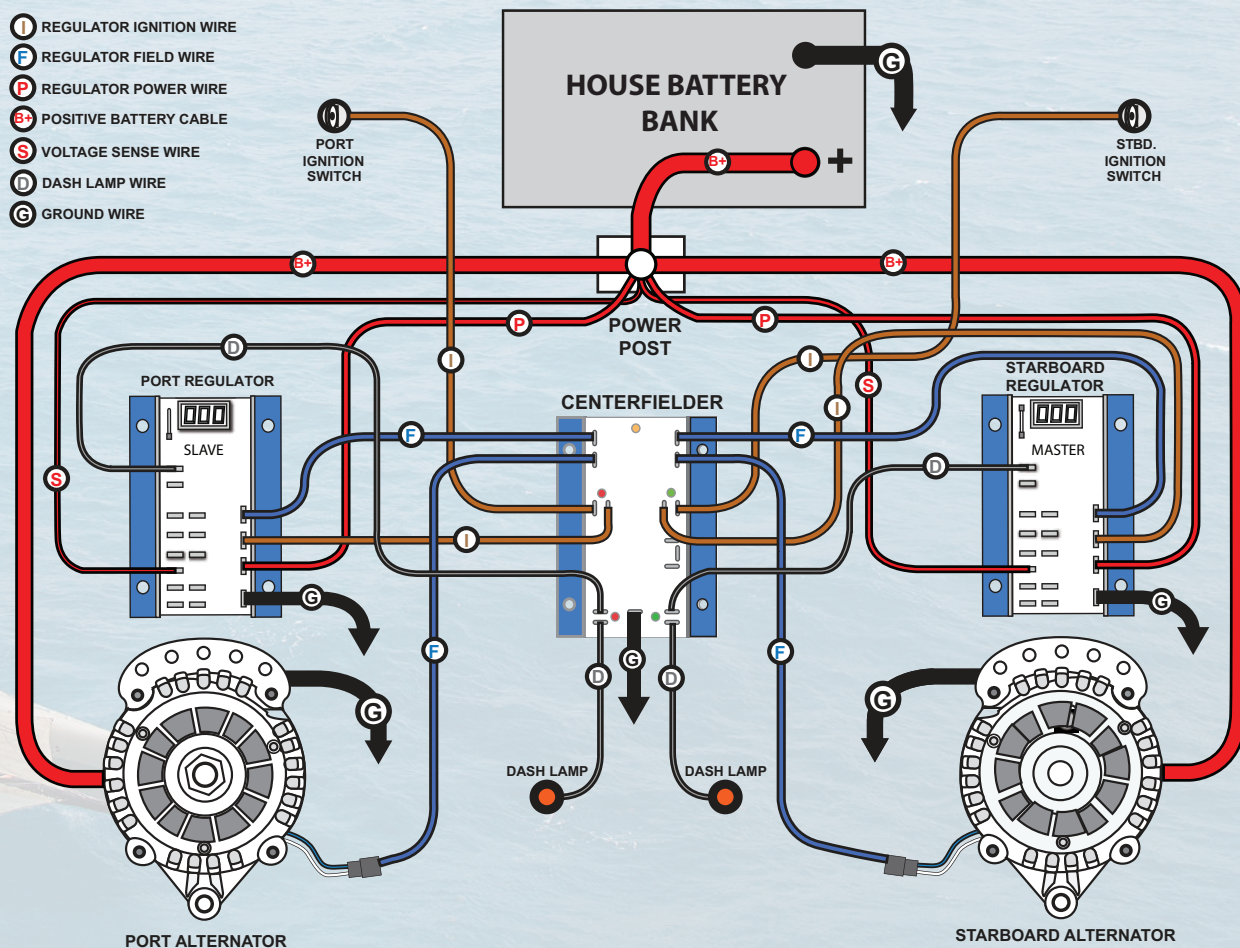

Shown above is a 12V configuration using the MC-614.  
Consult the user manual for a 24V configuration using the MC-624



## Large Case Alternators

### Mid Duty-Cycle, Large Frame Alternators

#### 94-Series

#### 94LY-Series

#### 95-Series

- Extra Heavy Duty Windings, Diodes & Brushes
- Isolated Ground Termination
- Corrosion Resistant Powder Coated Finish
- Bi-Directional Cooling Fans on 94-Series & 95-Series
- Maximum RPM: 7,000
- USCG Title 33 Ignition Protection Compliant

From world class ocean racers to commercial fishers and military patrol vessels, these large-frame alternators have a proven record for supporting large house battery banks and challenging electrical loads under some of the toughest marine conditions imaginable.

**94-Series, 94LY-Series and 95-Series Alternators** feature extra-large gauge custom wound stators and high amperage diode packs to ensure optimal charging performance. Built to meet USCG Title 33 ignition protection standards, 94-Series alternators deliver excellent low RPM output and terrific response throughout the power band.

All Balmar large case alternators are designed to be used with Balmar's external, Multi-Stage Regulators.

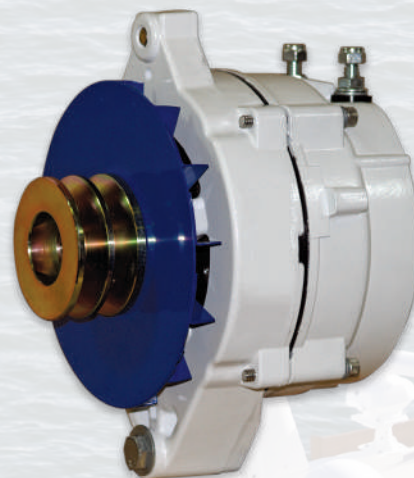

**94-Series**

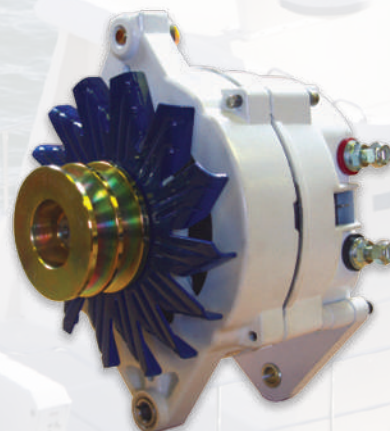

**94LY-Series**



**95-Series**

Part Number	Output		Mounting Style	Minimum Pulley
	Volts	Amps		
94-12-165-IG	12	165	Single Foot 2" (Delco-style)	1/2" Dual Vee <sup>(1)</sup>
94-12-210-IG		210		
94-24-140-IG	24	140		
94LY-12-165-IG	12	165	Dual Foot 3.15" (Hitachi-style)	1/2" Dual Vee <sup>(1)</sup>
94LY-12-210-IG		210		
94LY-24-140-IG	24	140		
9504-12-165-IG	12	165	Dual Foot 4" (J180-style)	1/2" Dual Vee <sup>(1)</sup>
9504-12-210-IG		210		
9504-24-140-IG	24	140		
94LY-0050	Tensioner & Hardware Kit			

(1) All 9-Series Alternators can be outfitted with K6 or K8 Serpentine Pulleys.

(2) 9-Series Alternators are designed to be used with Balmar Multi-Stage Regulators

Offshore Repair Kits are available for most Balmar Alternators. See page 27 for details



## Extra Large Case Alternators Heavy Duty-Cycle, Extra-Large Frame

### 97-Series

- Highly Efficient Brushless Design
- Isolated Ground Termination
- Bi-Directional Cooling Fan
- Maximum RPM: 7,000
- External Regulation Required
- USCG Title 33, CE, ISO 8849 and SAE J1171 Compliant

Built expressly for the added demands of large multi-battery banks, inverter loads and other substantial electrical demands, Extra-Large Case 97-Series Brushless Alternators provide the size, cooling and output across the range of engine RPM required to perform in a league with a small genset.

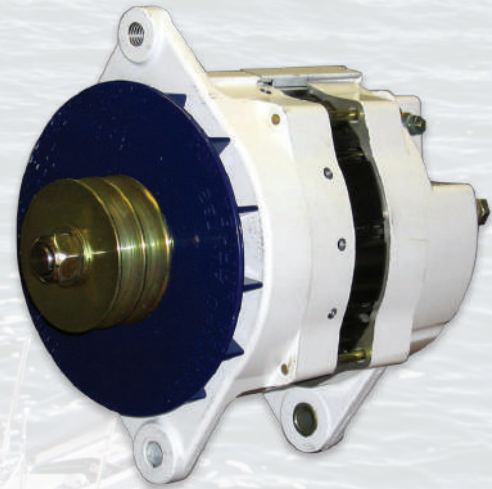

97-Series

Part Number <sup>(2)</sup>	Output		Mounting Style	Minimum Pulley
	Volts	Amps		
9704-12-160-BL-IG	12	160	Dual Foot 4" (J180-style)	1/2" Dual Vee <sup>(1)</sup>
9704-24-140-BL-IG	24	140		

(1) All 97-Series Alternators can be outfitted with K6 or K8 Serpentine Pulleys.

(2) 97-Series Alternators are designed to be used with Balmar Multi-Stage Regulators

### 97EHD-Series

- Designed for Extended Duty Operation
- Case Ground or Isolated Ground Terminations Available
- Bi-Directional Cooling Fan
- Maximum RPM: 7,000
- External Regulation Required
- USCG Title 33 Compliant

Extra-Large Case 97EHD-Series Alternators are appropriate for large diesel applications such as Caterpillar, Cummins, MTU and John Deere to service extensive house battery loads.

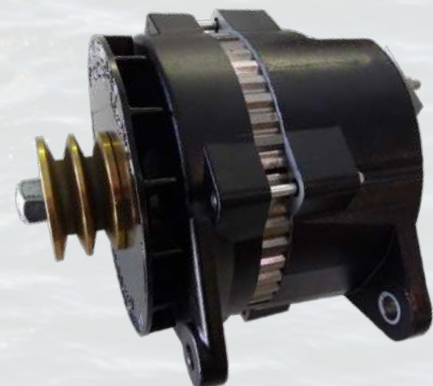
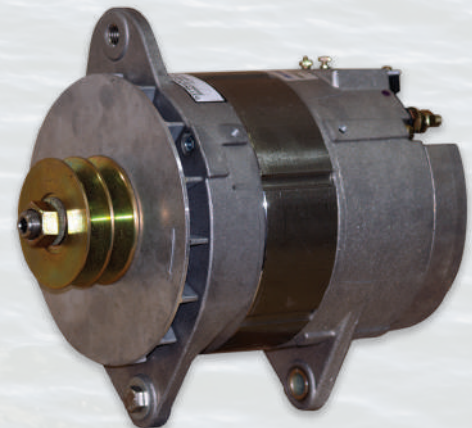

97EHD-Series

Part Number <sup>(2)</sup>	Output		Mounting Style	Minimum Pulley
	Volts	Amps		
97EHD-185-12(-IG) <sup>(3)</sup>	12	185	Dual Foot 4" (J180-style)	1/2" Dual Vee <sup>(1)</sup>
97EHD-265-12(-IG) <sup>(3)</sup>		265		
97EHD-85-24-IG	24	85		
97EHD-110-24-IG		110		
97EHD-190-24(-IG) <sup>(3)</sup>		190		

(1) All 9-Series Alternators can be outfitted with K6 or K8 Serpentine Pulleys

(2) 97EHD Alternators are designed to be used with Balmar Multi-Stage Regulators

(3) 97EHD Alternators can be Delivered with Case or Isolated Ground (-IG)



## Extra Large Case Alternators

### Maximum Duty-Cycle, Extra-Large Frame

### 98-Series

- Highly Efficient Brushless Design
- Isolated Ground Termination
- Dual Cooling Fans, Oversized Bearings
- High Amperage Diodes
- Maximum RPM: 7,000
- Requires External Voltage Regulation
- USCG Title 33, CE, ISO 8846 and SAE J1171 Compliant



**98-Series**

The **Extra-Large Case 98-Series Alternator** offers the capacity to produce nearly 5kW of DC output – on par with many small gensets. The 98-Series Alternator is currently used on USCG 43' Lifeboats.

Part Number	Output		Mounting Style	Minimum Pulley
	Volts	Amps		
98-12-310-IG-BL	12	310	Dual Foot 4" (J180-style)	1/2" Dual Vee <sup>(1)</sup>
98-24-220-IG-BL	24	220		

(1) All 98-Series Alternators can be outfitted with K6 or K8 Serpentine Pulleys.

(2) 9-Series Alternators are designed to be used with Balmar Multi-Stage Regulators

## Alternator Installation Hints

### Battery Cable Sizing

Battery cable size must meet the increased output capacity of your alternator. The easiest method for determining the best cable size for your system is to compare your alternator's rated amperage output and the ROUND TRIP length of the cable running from the alternator to the battery being charged, and back to the alternator via ground to the chart at right.

### Belt Tensioning

Under- or over-tensioned belts can result in belt slippage, premature belt wear, alternator overheating and belt failure. Belt deflection should typically be set between 1/4" and 3/8" when you push your thumb down on the back of the belt at mid-span

between the crank and alternator pulleys. For more precise tensioning adjustments, use a commonly available tensioning gauge. The use of a belt tensioner, such as Balmar's Belt Buddy Universal Tensioning System (shown on the next page) makes it easier to adjust the belt tension by using a rotating and locking adjustment mechanism to push the crank pulley and the alternator pulley apart.

12 Volt Battery Cable Size Chart									
Run Length (ft)	5'	10'	15'	20'	25'	30'	40'	50'	75'
Alternator Output	Battery Cable Gauge								
75 A	8	6	4	2	2	1	1/0	2/0	4/0
100 A	8	4	2	2	1	3/0	3/0	4/0	
125 A	6	4	2	1	1/0	3/0	4/0		
150 A	6	2	1	1/0	2/0	3/0	4/0		
175 A	6	2	1	1/0	2/0	3/0	4/0		
200 A	4	2	1/0	2/0	3/0	4/0			
225 A	4	1	1/0	2/0	3/0	4/0			
250 A	2	1	2/0	3/0	4/0				
275 A	2	1	2/0	3/0	4/0				
300 A	2	1/0	3/0	4/0					



## Alternator Accessories

### Belt Buddy Universal Adjustment Arm

Reduce your installation time! Many installers rely on the Belt Buddy Universal Adjustment Arm for alternator installations and belt tensioning. Precision cut and powder coated for protection from corrosion, the Belt Buddy can be purchased as a kit or by individual component.

Part Number	Description
UBB	Universal Adjustment Arm & Belt Buddy Combination. This is the complete assembly (UBB = UAA + BB), designed for adjusting belt tension and providing a positive stop for no slipping.
UAA	Universal Adjustment Arm Only The UAA provides a longer, more positive arm for alternator adjustment.
BB	Belt Buddy for the UAA The BB adjustable mechanism converts your existing UAA to a UBB.
BBU	Belt Buddy for Any Adjustment Arm This product is designed to fit on your existing tensioning arm, thereby converting it to our Belt Buddy System.



### Yanmar Installation Mounting Kits

Pre-matched mounting Kits for various Yanmar engines can save time and frustration. Required for AT-Series installation.

6CX and 6LP kits include the required pulleys.

Part Number	Yanmar Engine Model
6-0020	GM, JH, LH, LY
6-0030	6CX
6-0040	6LP



### Offshore Repair Kits

Recommended for cruisers, Balmar's Offshore Repair Kits ensure that you will be ready if your alternator needs repair.

Kits vary by alternator model, but all provide the most commonly needed components, such as bearings, brushes, and complete regulator/rectifier assemblies.

Part Number	Alternator Series
7060	6-Series (12V)
7060-24	6-Series (24V)
7090	90-Series (12/24V)
7094	94-Series (12/24V)
7095	95-Series (12/24V)
70-AT-165	AT-Series (165A)
70-XT-170	XT-Series (170A)
70-AT-200	AT-Series (200A)



### Alternator Pulleys, Belts & Mounting Spacers

Balmar offers an extensive selection of pulleys, belts & mounting spacers for its Small, Large and Extra-Large Frame Alternators. Pulley models vary by bore (.17mm and .875"), outside diameter, belt width and type, and rear shoulder width. Balmar pulleys are anodized steel, unless otherwise noted.



See our complete spare parts listing on page 38!



## Alternator Output Curves

Alternator output is dependent on a number of factors: battery condition and capacity, wire size, engine horsepower and engine RPM, battery temperature and alternator temperature. Of these factors, alternator speed and temperatures are the most important.

The following chart describes alternator output based on two temperature levels (ambient (25° C) and hot (60° C)). Test voltages are set at 13.5V (for 12V units) and 27.0V (for 24V units). Engine-to-alternator drive ratios vary by engine, but a conversion factor of 2 is shown here for simplicity.

Engine RPM		500	750	1000	1250	1500	1750	2000	2250	2500	2750	3000
Typical Drive Ratio		2	2	2	2	2	2	2	2	2	2	2
Alternator RPM		1000	1500	2000	2500	3000	3500	4000	4500	5000	5500	6000
Alternator Model	Temp	Alternator Power Curves by Balmar Model										
6-Series, 12V 70 Amp Models	Cold	0	20	68	73	77	78	77	77	76	77	77
	Hot	0	15	56	63	65	66	65	65	66	66	65
6-Series, 12V 100 Amp Models	Cold	0	21	83	100	106	110	104	106	108	109	108
	Hot	0	20	70	80	93	93	93	93	94	93	93
6-Series, 12V 120 Amp Models	Cold	0	21	80	116	121	122	125	125	124	124	125
	Hot	0	20	60	98	105	108	109	110	110	108	109
6-Series, 12V 150 Amp Models	Cold	0	24	80	117	132	141	149	155	158	159	159
	Hot	0	9	65	95	111	120	122	123	125	128	129
6-Series, 24V 70 Amp Models	Cold	0	6	36	55	68	71	73	76	76	75	76
	Hot	0	3	25	40	50	53	53	56	54	56	55
XT-Series, 12V 170 Amp Models	Cold	0	90	128	159	174	182	189	194	196	197	198
	Hot	0	90	118	134	144	154	157	159	162	164	166
AT-Series, 12V 220 Amp Models	Cold	0	132	165	199	215	222	225	231	235	240	243
	Hot	0	99	148	164	181	187	192	197	202	205	207
94/94LY-Series, 12V 165 Amp Models	Cold	0	20	60	89	112	128	140	151	158	163	168
	Hot	0	10	50	72	89	104	109	122	139	142	148
94/94LY-Series, 12V 210 Amp Models	Cold	0	21	78	103	128	147	162	178	191	208	210
	Hot	0	15	68	82	103	120	131	142	161	170	175
94/94LY-Series, 24V 140 Amp Models	Cold	0	8	15	38	50	70	77	96	124	131	135
	Hot	0	0	10	30	40	58	65	75	92	105	110
95-Series, 12V 165 Amp Model	Cold	0	18	76	103	122	130	135	138	142	150	158
	Hot	0	9	58	80	90	105	115	118	121	122	127
95-Series, 12V 210 Amp Model	Cold	0	40	45	100	125	143	155	170	183	190	195
	Hot	0	35	40	80	115	120	135	142	150	158	161
95-Series, 24V 140 Amp Model	Cold	0	7	14	38	55	65	85	100	113	120	133
	Hot	0	5	12	35	50	60	78	95	100	105	110
97-Series, 12V 160 Amp Model	Cold	0	22	80	120	140	153	160	162	163	162	160
	Hot	0	18	115	100	120	140	145	148	145	148	148
97-Series, 24V 140 Amp Model	Cold	0	22	80	120	135	136	138	140	142	142	145
	Hot	0	18	62	100	115	123	123	123	128	131	138
97EHD-Series, 12V 185 Amp Model	Cold	0	100	141	159	165	174	179	183	186	186	184
	Hot	0	83	132	144	150	163	166	170	172	170	171
97EHD-Series, 12V 265 Amp Model	Cold	0	50	150	210	225	245	252	255	260	268	270
	Hot	0	30	120	182	186	194	204	212	218	221	221
97EHD-Series, 24V 190 Amp Model	Cold	0	40	100	148	168	180	188	193	198	199	198
	Hot	0	22	92	125	145	157	166	170	171	178	178
98-Series, 12V 310 Amp Model	Cold	0	36	150	235	262	278	290	295	315	322	320
	Hot	0	30	140	190	215	228	245	250	250	251	252
98-Series, 24V 220 Amp Model	Cold	0	36	100	145	167	180	190	195	205	210	220
	Hot	0	34	92	138	156	166	172	178	186	190	192



## Alternator Dimensions

Alternator Model	Case Diameter	Bolt-to-Bolt Tension to Mounting Foot	Overall Height	Case Length Front-to-Back	Overall Length (Standard Pulley)	Dual Foot Saddle Width (Inside)	Rear Foot Width (including Bushing)	Front Foot Width	Front Foot to Center of Inside Sheave	Standard Pulley Diameter	Mounting Foot Bore	Tension Arm Bolt Dia. / Thread Count	Stator Poles
60 Series	5.35" 136 mm	6.6" 167 mm	7.5" 190 mm	5.08" 129 mm	SV: 6.63" 168 mm	3.28" 83 mm	0.94" 24 mm	0.61" 16 mm	0.5" 13 mm	SV: 2.7" 69 mm	0.39" 10 mm	M8 x 1.25	12
621 Series	5.35" 136 mm	6.6" 167 mm	7.5" 190 mm	5.08" 129 mm	SV: 6.63" 168 mm	N/A	N/A	1.0 / 2.0" 25 / 51 mm	0.5" 13 mm	SV: 2.7" 69 mm	.39" / 0.5" 10 / 13 mm	M8 x 1.25	12
604 Series	5.35" 136 mm	6.6" 167 mm	7.5" 190 mm	5.08" 129 mm	SV: 6.63" 168 mm	4.15" 105 mm	0.94" 24 mm	0.61" 16 mm	0.5" 13 mm	SV: 2.7" 69 mm	0.39" 10 mm	M8 x 1.25	12
XT-170 Series	5.26" 134 mm	6.53" 165 mm	7.43" 188 mm	3.54" 90 mm	DV: 8.00" 203 mm	3.28" 83 mm	.75" 19 mm	0.55" 14 mm	0.62" 16 mm	DV: 2.7" 69 mm	.39" / 0.5" 10 / 13 mm	M8 x 1.25	16
AT-200 Series	5.68" 145 mm	8.15" 207 mm	9.67" 246 mm	5.10" 130 mm	DV: 7.93" 201 mm	3.3" 84 mm	.75" 19 mm	0.55" 14 mm	0.62" 16 mm	DV: 2.7" 69 mm	.39" / 0.5" 10 / 13 mm	3/8" x 16NC	16
AT-DF4-200 Series	5.68" 145 mm	8.15" 207 mm	9.67" 246 mm	5.10" 130 mm	DV: 7.93" 201 mm	4.02" 102 mm	.75" 19 mm	0.55" 14 mm	0.62" 16 mm	DV: 2.7" 69 mm	0.39" 10 mm	3/8" x 16NC	16
94 Series	6.0" 152 mm	8.0" 203 mm	9.0" 229 mm	5.0" 127 mm	DV: 7.0" 178 mm	N/A	N/A	2.0" 51 mm	1.0" 25 mm	DV: 2.9" 74 mm	0.5" 13 mm	3/8" x 16NC	12
94LY Series	6.0" 152 mm	8.0" 203 mm	9.0" 229 mm	5.0" 127 mm	DV: 7.0" 178 mm	3.28" 83 mm	0.55" 14 mm	0.88" 23 mm	1.0" 25 mm	DV: 2.9" 74 mm	0.5" 13 mm	3/8" x 16NC	12
95 Series	6.0" 152 mm	7.7" 196 mm	9.0" 229 mm	6.5" 165 mm	DV: 8.7" 221 mm	4.1" 104 mm	.75" 19 mm	0.56" 14 mm	1.1" 28 mm	DV: 2.9" 74 mm	0.5" 13 mm	3/8" x 16NC	12
97 Series	6.75" 171 mm	8.4" 213 mm	9.75" 248 mm	7.0" 178 mm	DV: 10.9" 277 mm	4.1" 104 mm	.75" 19 mm	0.56" 14 mm	1.0" 25 mm	DV: 2.9" 74 mm	0.5" 13 mm	1/2" x 13NC	16
97EHD Series	6.5" 165 mm	8.4" 213 mm	9.75" 248 mm	8.125" 207 mm	DV: 10.9" 277 mm	4.1" 104 mm	.75" 19 mm	0.65" 17 mm	1.2" 30 mm	DV: 2.9" 74 mm	0.5" 13 mm	1/2" x 13NC	12
98 Series	8.25" 210 mm	8.25" 210 mm	9.6" 244 mm	8.0" 204 mm	DV: 11.0" 279 mm	4.1" 104 mm	0.75" 19 mm	0.58" 15 mm	1.1" 28 mm	DV: 2.9" 74 mm	0.5" 13 mm	1/2" x 13NC	14

### Notes:

In order to ensure quality, Balmar reserves the right to make changes which may affect alternator dimensions or specification. Balmar is not liable for any damages or injuries resulting from faulty product installation. See the Balmar Warranty and ordering instructions at the bottom of page 34 of this catalog for more information.

Small case 60-Series Alternators are equipped standard with 10mm bore spacers and bushings. 8mm bore spacers and bushings are available for those units.

621-Series and XT-Series alternators are equipped with a removable bushed 1" spacer for use in 2" installations. 1" mounts feature a .50" bore. 2" mounts feature a .38" bore. Always compare existing alternator & replacement alternator dimensions. Balmar cannot guarantee direct OEM replacement.

## Multi-Lite™ Utility Lighting Fixture

Balmar's Multi-Lite™ Fixture can be used in 12VDC, 24VDC, 110VAC or 220VAC applications without the need for difficult rewiring. Housed in a protective UV-resistant cage, the Multi-Lite™ uses a glass fresnel lens for optimal light dispersion. See page 38 for ordering details.





## Part Number Listings: 6-Series Alternators

Part Number	Description	Volts	Amps	Superseded
60-70-SV	Alternator, 60 Series, 70a, 12v, SaddleMT, 3.15in, SingPul, IsoGrd	12	70	60-70-SR-IG
60-70-DV	Alternator, 60 Series, 70a, 12v, SaddleMT, 3.15in, DualPul, IsoGrd			-
60-70-K6	Alternator, 60 Series, 70a, 12v, SaddleMT, 3.15in, K6Pul, IsoGrd			-
60-100-SV	Alternator, 60 Series, 100a, 12v, SaddleMT, 3.15in, SingPul, IsoGrd	12	100	60-100-SR-IG
60-100-DV	Alternator, 60 Series, 100a, 12v, SaddleMT, 3.15in, DualPul, IsoGrd			-
60-100-K6	Alternator, 60 Series, 100a, 12v, SaddleMT, 3.15in, K6Pul, IsoGrd			-
60-100-J10	Alternator, 60 Series, 100a, 12v, SaddleMT, 3.15in, J10Pul, IsoGrd			-
60-120-DV	Alternator, 60 Series, 120a, 12v, SaddleMT, 3.15in, DualPul, IsoGrd	12	120	60-120-SR-IG
60-120-K6	Alternator, 60 Series, 120a, 12v, SaddleMT, 3.15in, K6Pul, IsoGrd			-
60-120-J10	Alternator, 60 Series, 120a, 12v, SaddleMT, 3.15in, J10Pul, IsoGrd			-
60-150-DV	Alternator, 60 Series, 150a, 12v, SaddleMT, 3.15in, DualPul, IsoGrd	12	150	60-150-SR-IG
60-150-K6	Alternator, 60 Series, 150a, 12v, SaddleMT, 3.15in, K6Pul, IsoGrd			-
60-150-J10	Alternator, 60 Series, 150a, 12v, SaddleMT, 3.15in, J10Pul, IsoGrd			-
60-24-70-DV	Alternator, 60 Series, 70a, 24v, SaddleMT, 3.15in, DualPul, IsoGrd	24	70	60-24-70-SR-IG
60-24-70-K6	Alternator, 60 Series, 70a, 24v, SaddleMT, 3.15in, K6Pul, IsoGrd			-
60-24-70-J10	Alternator, 60 Series, 70a, 24v, SaddleMT, 3.15in, J10Pul, IsoGrd			-
621-70-SV	Alternator, 621 Series, 70a, 12v, SingleFT, 1-2in, SingPul, IsoGrd	12	70	621-70-SR-IG
621-70-DV	Alternator, 621 Series, 70a, 12v, SingleFT, 1-2in, DualPul, IsoGrd			-
621-70-K6	Alternator, 621 Series, 70a, 12v, SingleFT, 1-2in, K6Pul, IsoGrd			-
621-100-SV	Alternator, 621 Series, 100a, 12v, SingleFT, 1-2in, SingPul, IsoGrd	12	100	621-100-SR-IG
621-100-DV	Alternator, 621 Series, 100a, 12v, SingleFT, 1-2in, DualPul, IsoGrd			-
621-100-K6	Alternator, 621 Series, 100a, 12v, SingleFT, 1-2in, K6Pul, IsoGrd			-
621-100-J10	Alternator, 621 Series, 100a, 12v, SingleFT, 1-2in, J10Pul, IsoGrd			-
621-120-DV	Alternator, 621 Series, 120a, 12v, SingleFT, 1-2in, DualPul, IsoGrd	12	120	621-120-SR-IG
621-120-K6	Alternator, 621 Series, 120a, 12v, SingleFT, 1-2in, K6Pul, IsoGrd			-
621-120-J10	Alternator, 621 Series, 120a, 12v, SingleFT, 1-2in, J10Pul, IsoGrd			-
621-150-DV	Alternator, 621 Series, 150a, 12v, SingleFT, 1-2in, DualPul, IsoGrd	12	150	621-150-SR-IG
621-150-K6	Alternator, 621 Series, 150a, 12v, SingleFT, 1-2in, K6Pul, IsoGrd			-
621-150-J10	Alternator, 621 Series, 150a, 12v, SingleFT, 1-2in, J10Pul, IsoGrd			-
621-24-70-DV	Alternator, 621 Series, 70a, 24v, SingleFT, 1-2in, DualPul, IsoGrd	24	70	621-24-70-SR-IG
621-24-70-K6	Alternator, 621 Series, 70a, 24v, SingleFT, 1-2in, K6Pul, IsoGrd			-
621-24-70-J10	Alternator, 621 Series, 70a, 24v, SingleFT, 1-2in, J10Pul, IsoGrd			-
604-120-DV	Alternator, 604 Series, 120a, 12v, SaddleMT, 4in, DualPul, IsoGrd	12	120	604-120-SR-IG
604-120-K6	Alternator, 604 Series, 120a, 12v, SaddleMT, 4in, K6Pul, IsoGrd			-
604-150-DV	Alternator, 604 Series, 150a, 12v, SaddleMT, 4in, DualPul, IsoGrd	12	150	604-150-SR-IG
604-150-K6	Alternator, 604 Series, 150a, 12v, SaddleMT, 4in, K6Pul, IsoGrd			-
604-24-70-DV	Alternator, 604 Series, 70a, 24v, SaddleMT, 4in, DualPul, IsoGrd	24	70	604-24-70-SR-IG
604-24-70-K6	Alternator, 604 Series, 70a, 24v, SaddleMT, 4in, K6Pul, IsoGrd			-

## Ordering Information

Balmar DC Charging Solutions are available worldwide through our distribution and dealer network. Through its association with CDI Electronics, Balmar has also recently expanded its distribution partner network. .



## XT-Series and AT-Series Alternators

Part Number	Description	Volts	Amps	Superseded
XT-SF-170-DV	Alternator, XT Series, 170a, 12v, SingleFT, 1-2in, DualPul, CaseGrd	12	170	AT-SF-165-DV
XT-SF-170-K6	Alternator, XT Series, 170a, 12v, SingleFT, 1-2in, K6Pul, CaseGrd			AT-SF-165-K6
XT-SF-170-J10	Alternator, XT Series, 170a, 12v, SingleFT, 1-2in, J10Pul, CaseGrd			AT-SF-165-J10
XT-SF-170-IR	Alternator, XT Series, 170a, 12v, SingleFT, 1-2in, K6Pul, Internal Reg			-
XT-VT-170-K6	Alternator, XT Series, 170a, 12v, VortecMT, K6Pul, CaseGrd	12	170	-
XT-VT-170-IR	Alternator, XT Series, 170a, 12v, VortecMT, K6Pul, Internal Reg			-
AT-SF-200-DV	Alternator, AT Series, 220a, 12v, SingleFT, 1-2in, DualPul, IsoGrd	12	220	AT-SF-200-12-IG
AT-SF-200-K6	Alternator, AT Series, 220a, 12v, SingleFT, 1-2in, K6Pul, IsoGrd			-
AT-SF-200-J10	Alternator, AT Series, 220a, 12v, SingleFT, 1-2in, J10Pul, IsoGrd			-
XT-DF-170-DV	Alternator, AT Series, 170a, 12v, DualFT, 3.15in, DualPul, CaseGrd	12	170	AT-DF-165-DV
XT-DF-170-K6	Alternator, AT Series, 170a, 12v, DualFT, 3.15in, K6Pul, CaseGrd			AT-DF-165-K6
XT-DF-170-J10	Alternator, AT Series, 170a, 12v, DualFT, 3.15in, J10Pul, CaseGrd			AT-DF-165-J10
AT-DF-200-DV	Alternator, AT Series, 220a, 12v, DualFT, 3.15in, DualPul, IsoGrd	12	220	AT-DF-200-12-IG
AT-DF-200-K6	Alternator, AT Series, 220a, 12v, DualFT, 3.15in, K6Pul, IsoGrd			-
AT-DF-200-J10	Alternator, AT Series, 220a, 12v, DualFT, 3.15in, J10Pul, IsoGrd			-
AT-DF4-200-DV	Alternator, AT Series, 220a, 12v, DualFT, 4in, DualPul, IsoGrd	12	220	AT-DF4-200-12-IG
AT-DF4-200-K6	Alternator, AT Series, 220a, 12v, DualFT, 4 in, K6Pul, IsoGrd			-

## Large Case Alternators

Part Number	Description	Volts	Amps	Dimensions
94-12-165-IG	Alternator, 94 Series, 165a, 12v, SingleFT, 2in, DualPul, IsoGrd	12	165	7.0" x 9.0" x 6.0"
94-12-210-IG	Alternator, 94 Series, 210a, 12v, SingleFT, 2in, DualPul, IsoGrd	12	210	7.0" x 9.0" x 6.0"
94-24-140-IG	Alternator, 94 Series, 140a, 24v, SingleFT, 2in, DualPul, IsoGrd	24	140	7.0" x 9.0" x 6.0"
94LY-12-165-IG	Alternator, 94 Series, 160a, 12v, Yanmar6LY MT w/Hardware, IsoGrd	12	165	7.0" x 9.0" x 6.0"
94LY-12-210-IG	Alternator, 94 Series, 210a, 12v, Yanmar6LY MT w/Hardware, IsoGrd	12	210	7.0" x 9.0" x 6.0"
94LY-24-140-IG	Alternator, 94 Series, 140a, 40v, Yanmar6LY MT w/Hardware, IsoGrd	24	140	7.0" x 9.0" x 6.0"
94LY-0050	KIT, 94 Series Tensioning Arm Hardware, YanmarLY (arm not included)	-	-	-
9504-12-165-IG	Alternator, 95 Series, 165a, 12v, SaddleMT, 4in, DualPul, IsoGrd	12	165	9.0" x 9.0" x 6.3"
9504-12-210-IG	Alternator, 95 Series, 210a, 12v, SaddleMT, 4in, DualPul, IsoGrd	12	210	9.0" x 9.0" x 6.3"
9504-24-140-IG	Alternator, 95 Series, 140a, 24v, SaddleMT, 4in, DualPul, IsoGrd	24	140	9.0" x 9.0" x 6.3"
9704-12-160-BL-IG	Alternator, 97 Series, 160a, 12v, SaddleMT, 4in, DualPul, IsoGrd, Brushless	12	160	10.6" x 9.5" x 6.5"
9704-24-140-BL-IG	Alternator, 97 Series, 140a, 24v, SaddleMT, 4in, DualPul, IsoGrd, Brushless	24	140	10.6" x 9.5" x 6.5"
97EHD-185-12	Alternator, 97EHD Series, 185a, 12v, SaddleMT, 4in, DualPul, CaseGrd	12	185	11.0" x 9.5" x 6.5"
97EHD-265-12	Alternator, 97EHD Series, 265a, 12v, SaddleMT, 4in, DualPul, CaseGrd	12	265	11.0" x 9.5" x 6.5"
97EHD-265-12-IG	Alternator, 97EHD Series, 265a, 12v, SaddleMT, 4in, DualPul, IsoGrd	12	265	11.0" x 9.5" x 6.5"
97EHD-85-24-IG	Alternator, 97EHD Series, 85a, 24v, SaddleMT, 4in, DualPul, IsoGrd	24	85	11.0" x 9.5" x 6.5"
97EHD-110-24-IG	Alternator, 97EHD Series, 110a, 24v, SaddleMT, 4in, DualPul, IsoGrd	24	110	11.0" x 9.5" x 6.5"
97EHD-190-24	Alternator, 97EHD Series, 110a, 24v, SaddleMT, 4in, DualPul, CaseGrd	24	110	11.0" x 9.5" x 6.5"
97EHD-190-24-IG	Alternator, 97EHD Series, 110a, 24v, SaddleMT, 4in, DualPul, IsoGrd	24	110	11.0" x 9.5" x 6.5"
98-12-310-IG-BL	Alternator, 98 Series, 310a, 12v, SaddleMT, 4in, DualPul, IsoGrd, Brushless	12	310	11.0" x 9.6" x 8.3"
98-24-220-IG-BL	Alternator, 98 Series, 220a, 24v, SaddleMT, 4in, DualPul, IsoGrd, Brushless	24	220	11.0" x 9.6" x 8.3"



## Charging Kits - 6 Series

Part Number	Description	Volts	Amps	Superseded
60-YP-70-SV	KIT, 60 Series 70a SaddleMT Alternator, ARS Regulator, TSensors, SingPul	12	70	60-YP-70-SR-KIT
60-YP-70-DV	KIT, 60 Series 70a SaddleMT Alternator, ARS Regulator, TSensors, DualPul			-
60-YP-70-K6	KIT, 60 Series 70a SaddleMT Alternator, ARS Regulator, TSensors, K6Pul			-
60-YP-100-SV	KIT, 60 Series 100a SaddleMT Alternator, ARS Regulator, TSensors, SingPul	12	100	60-YP-100-SR-KIT
60-YP-100-DV	KIT, 60 Series 100a SaddleMT Alternator, ARS Regulator, TSensors, DualPul			-
60-YP-100-K6	KIT, 60 Series 100a SaddleMT Alternator, ARS Regulator, TSensors, K6Pul			-
60-YP-100-J10	KIT, 60 Series 100a SaddleMT Alternator, ARS Regulator, TSensors, J10Pul			-
60-YP-120-DV	KIT, 60 Series 120a SaddleMT Alternator, ARS Regulator, TSensors, DualPul	12	120	60-YP-120-SR-KIT
60-YP-120-K6	KIT, 60 Series 120a SaddleMT Alternator, ARS Regulator, TSensors, K6Pul			-
60-YP-120-J10	KIT, 60 Series 120a SaddleMT Alternator, ARS Regulator, TSensors, J10Pul			-
60-YP-150-DV	KIT, 60 Series 150a SaddleMT Alternator, ARS Regulator, TSensors, DualPul	12	150	60-YP-150-SR-KIT
60-YP-150-K6	KIT, 60 Series 150a SaddleMT Alternator, ARS Regulator, TSensors, K6Pul			-
60-YP-150-J10	KIT, 60 Series 150a SaddleMT Alternator, ARS Regulator, TSensors, J10Pul			-
60-YP-MC-70-SV	KIT, 60 Series 70a SaddleMT Alternator, MC Regulator, TSensors, SingPul	12	70	60-YP-MC-70-SR-KIT
60-YP-MC-70-DV	KIT, 60 Series 70a SaddleMT Alternator, MC Regulator, TSensors, DualPul			-
60-YP-MC-70-K6	KIT, 60 Series 70a SaddleMT Alternator, MC Regulator, TSensors, K6Pul			-
60-YP-MC-100-SV	KIT, 60 Series 100a SaddleMT Alternator, MC Regulator, TSensors, SingPul	12	100	60-YP-MC-100-SR-KIT
60-YP-MC-100-DV	KIT, 60 Series 100a SaddleMT Alternator, MC Regulator, TSensors, DualPul			-
60-YP-MC-100-K6	KIT, 60 Series 100a SaddleMT Alternator, MC Regulator, TSensors, K6Pul			-
60-YP-MC-100-J10	KIT, 60 Series 100a SaddleMT Alternator, MC Regulator, TSensors, J10Pul			-
60-YP-MC-120-DV	KIT, 60 Series 120a SaddleMT Alternator, MC Regulator, TSensors, DualPul	12	120	60-YP-MC-120-SR-KIT
60-YP-MC-120-K6	KIT, 60 Series 120a SaddleMT Alternator, MC Regulator, TSensors, K6Pul			-
60-YP-MC-120-J10	KIT, 60 Series 120a SaddleMT Alternator, MC Regulator, TSensors, J10Pul			-
60-YP-MC-150-DV	KIT, 60 Series 150a SaddleMT Alternator, MC Regulator, TSensors, DualPul	12	150	60-YP-MC-150-SR-KIT
60-YP-MC-150-K6	KIT, 60 Series 150a SaddleMT Alternator, MC Regulator, TSensors, K6Pul			-
60-YP-MC-150-J10	KIT, 60 Series 150a SaddleMT Alternator, MC Regulator, TSensors, J10Pul			-
60-YP-24-70-DV	KIT, 60 Series 70a 24v SaddleMT Alternator, MC Regltr, TSensors, DualPul	24	70	60-YP-24-70-SR-KIT
60-YP-24-70-K6	KIT, 60 Series 70a 24v SaddleMT Alternator, MC Regltr, TSensors, K6Pul			-
60-YP-24-70-J10	KIT, 60 Series 70a 24v SaddleMT Alternator, MC Regltr, TSensors, J10Pul			-
621-VUP-70-SV	KIT, 621 Series 70a SingleFT Alternator, ARS Regulator, TSensors, SingPul	12	70	621-VUP-70-SR-KIT
621-VUP-70-DV	KIT, 621 Series 70a SingleFT Alternator, ARS Regulator, TSensors, DualPul			-
621-VUP-70-K6	KIT, 621 Series 70a SingleFT Alternator, ARS Regulator, TSensors, K6Pul			-
621-VUP-100-SV	KIT, 621 Series 100a SingleFT Alternator, ARS Regulator, TSensors, SingPul	12	100	621-VUP-100-SR-KIT
621-VUP-100-DV	KIT, 621 Series 100a SingleFT Alternator, ARS Regulator, TSensors, DualPul			-
621-VUP-100-K6	KIT, 621 Series 100a SingleFT Alternator, ARS Regulator, TSensors, K6Pul			-
621-VUP-100-J10	KIT, 621 Series 100a SingleFT Alternator, ARS Regulator, TSensors, K6Pul			-
621-VUP-120-DV	KIT, 621 Series 120a SingleFT Alternator, ARS Regulator, TSensors, DualPul	12	120	621-VUP-120-SR-KIT
621-VUP-120-K6	KIT, 621 Series 120a SingleFT Alternator, ARS Regulator, TSensors, K6Pul			-
621-VUP-120-J10	KIT, 621 Series 120a SingleFT Alternator, ARS Regulator, TSensors, J10Pul			-
621-VUP-150-DV	KIT, 621 Series 150a SingleFT Alternator, ARS Regulator, TSensors, DualPul	12	150	621-VUP-150-SR-KIT
621-VUP-150-K6	KIT, 621 Series 150a SingleFT Alternator, ARS Regulator, TSensors, K6Pul			-
621-VUP-120-J10	KIT, 621 Series 120a SingleFT Alternator, ARS Regulator, TSensors, J10Pul			-

## Ordering Information

Balmar DC Charging Solutions are available worldwide through our distribution and dealer network. Through its association with CDI Electronics, Balmar has also recently expanded its distribution partner network.



## Charging Kits - 6 Series

Part Number	Description	Volts	Amps	Superseded
621-VUP-MC-70-SV	KIT, 621 Series 70a SingleFT Alternator, MC Regulator, TSensors, SingPul	12	70	621-VUP-MC-70-SR-KIT
621-VUP-MC-70-DV	KIT, 621 Series 70a SingleFT Alternator, MC Regulator, TSensors, DualPul			-
621-VUP-MC-70-K6	KIT, 621 Series 70a SingleFT Alternator, MC Regulator, TSensors, K6Pul			-
621-VUP-MC-100-SV	KIT, 621 Series 100a SingleFT Alternator, MC Regulator, TSensors, SingPul	12	100	621-VUP-MC-100-SR-KIT
621-VUP-MC-100-DV	KIT, 621 Series 100a SingleFT Alternator, MC Regulator, TSensors, DualPul			-
621-VUP-MC-100-K6	KIT, 621 Series 100a SingleFT Alternator, MC Regulator, TSensors, K6Pul			-
621-VUP-MC-100-J10	KIT, 621 Series 100a SingleFT Alternator, MC Regulator, TSensors, J10Pul			-
621-VUP-MC-120-DV	KIT, 621 Series 120a SingleFT Alternator, MC Regulator, TSensors, DualPul	12	120	621-VUP-MC-120-SR-KIT
621-VUP-MC-120-K6	KIT, 621 Series 120a SingleFT Alternator, MC Regulator, TSensors, K6Pul			-
621-VUP-MC-120-J10	KIT, 621 Series 120a SingleFT Alternator, MC Regulator, TSensors, J10Pul			-
621-VUP-MC-150-DV	KIT, 621 Series 150a SingleFT Alternator, MC Regulator, TSensors, DualPul	12	150	621-VUP-MC-150-SR-KIT
621-VUP-MC-150-K6	KIT, 621 Series 150a SingleFT Alternator, MC Regulator, TSensors, K6Pul			-
621-VUP-MC-150-J10	KIT, 621 Series 150a SingleFT Alternator, MC Regulator, TSensors, J10Pul			-
621-VUP-24-70-DV	KIT, 621 Series 70a 24v SingleFT Alternator, MC Regltr, TSensors, DualPul	24	70	621-VUP-24-70-SR-KIT
621-VUP-24-70-K6	KIT, 621 Series 70a 24v SingleFT Alternator, MC Regltr, TSensors, K6Pul			-
621-VUP-24-70-J10	KIT, 621 Series 70a 24v SingleFT Alternator, MC Regltr, TSensors, J10Pul			-

## Charging Kits - XT-Series and AT-Series

Part Number	Description	Volts	Amps	Superseded
XT-SF-170-DV-KIT	KIT, XT 170a SingleFT Alternator, MC Regulator, TSensors, DualPul	12	170	AT-SF-165-DV-KIT
XT-SF-170-K6-KIT	KIT, XT 170a SingleFT Alternator, MC Regulator, TSensors, K6Pul			AT-SF-165-K6-KIT
XT-SF-170-J10-KIT	KIT, XT 170a SingleFT Alternator, MC Regulator, TSensors, J10Pul			AT-SF-165-J10-KIT
XT-VT-170-K6-KIT	KIT, XT 170a VortecMT Alternator, MC Regulator, TSensors, K6Pul	12	170	-
AT-SF-200-DV-KIT	KIT, AT 220a SingleFT Alternator, MC Regulator, TSensors, DualPul	12	220	AT-SF-MC-200-KIT
AT-SF-200-K6-KIT	KIT, AT 220a SingleFT Alternator, MC Regulator, TSensors, K6Pul			-
AT-SF-200-J10-KIT	KIT, AT 220a SingleFT Alternator, MC Regulator, TSensors, J10Pul			-
XT-DF-170-DV-KIT	KIT, XT 170a DualFT Alternator ,MC Regulator, TSensors, DualPul	12	170	AT-DF-165-DV-KIT
XT-DF-170-K6-KIT	KIT, XT 170a DualFT Alternator ,MC Regulator, TSensors, K6Pul			AT-DF-165-K6-KIT
XT-DF-170-J10-KIT	KIT, XT 170a DualFT Alternator ,MC Regulator, TSensors, J10Pul			AT-DF-165-J10-KIT
AT-DF-200-DV-KIT	KIT, AT 220a DualFT Alternator, MC Regulator, TSensors, DualPul	12	220	AT-DF-MC-200-KIT
AT-DF-200-K6-KIT	KIT, AT 220a DualFT Alternator, MC Regulator, TSensors, K6Pul			-
AT-DF-200-J10-KIT	KIT, AT 220a DualFT Alternator, MC Regulator, TSensors, J10Pul			-

## Battery Monitors

Part Number	Description	Volts	Amps	Dimensions
SG200	Battery Monitor Kit, 12V/48V	12/48	350	-
SG2-0100	SmartShunt, SG200, 350A, 12/48V	12/48	350	4.9" x 3.3" x 2.0"
SG2-0200	Color Display, SG200, 2 1/16"	-	-	2.05" dia x 2.75" deep
SG2-0300	Gateway, SG200, Bluetooth®	-	-	60"
SG2-0400	Com Cable, SG200, 10m	-	-	10 meters
SG2-0402	Mounting Pate, SG200	-	-	4.50" x 3.25"
44-SG-12/24	Smartgauge™ Battery Monitor, 12/24V	12/24	-	4.3" x 3.0" x 1.1"



## Balmar Regulators

Part Number	Description	Volts	Amps	Dimensions
MC-612-DUAL	Regulator, Dual MC612 Multi-Stage, 12v, w/o Harnesses	12	-	4.8" x 3.2" x 1.5"
MC-612-DUAL-H	Regulator, Dual MC612 Multi-Stage, 12v, w/Harnesses	12	-	4.8" x 3.2" x 1.5"
MC-614	Regulator, MC614 Multi-Stage, 12v, w/o Harness	12	-	4.8" x 3.2" x 1.5"
MC-614-H	Regulator, MC614 Multi-Stage, 12v, w/Harness	12	-	4.8" x 3.2" x 1.5"
MC-614-HC	Regulator, MC614 Multi-Stage, 12v, w/Harness (Clamshell)	12	-	4.8" x 3.2" x 1.5"
MC-614-VL-01	Kit, Smart Ready for Valeo, MC-614 Regulator, TSensors	12	-	4.1" x 3.2" x 1.5"
MC-624	Regulator, MC624 Multi-Stage, 24v, w/o Harness	24	-	4.8" x 3.2" x 1.5"
MC-624-H	Regulator, MC624 Multi-Stage, 24v, w/Harness	24	-	4.8" x 3.2" x 1.5"
MC-624-HC	Regulator, MC624 Multi-Stage, 24v, w/Harness (Clamshell)	24	-	4.8" x 3.2" x 1.5"
MC-624-VL-01	Kit, Smart Ready for Valeo, MC-624 Regulator, TSensors	24	-	4.1" x 3.2" x 1.5"
ARS-5	Regulator, ARS Multi-Stage, 12v, w/o Harness	12	-	4.1" x 3.2" x 1.5"
ARS-5-H	Regulator, ARS Multi-Stage, 12v, w/Harness	12	-	4.1" x 3.2" x 1.5"
ARS-5-HC	Regulator, ARS Multi-Stage, 12v, w/Harness (Clamshell)	12	-	4.1" x 3.2" x 1.5"
ARS-5-VL-01	Kit, Smart Ready for Valeo, ARS-5 Regulator, TSensors	12	-	4.1" x 3.2" x 1.5"
BRS-2T-12	Regulator, BRS Single-Stage, 12v, w/o Harness	12	-	4.8" x 3.2" x 1.5"
BRS-2T-12-H	Regulator, BRS Single-Stage, 12v, w/Harness	12	-	4.6" x 3.2" x 1.5"
BRS-2T-24	Regulator, BRS Single-Stage, 24v, w/o Harness	24	-	4.6" x 3.2" x 1.5"
BRS-2T-24-H	Regulator, BRS Single-Stage, 24v, w/Harness	24	-	4.6" x 3.2" x 1.5"
ERS-KIT	Regulator, Single-Stage, 12v, w/Wiring Kit	12/24	-	2.3" x 1.3" x 0.7"
DDC-12/24	Digital Duo Charge, 12/24v, w/Wires	12/24	-	4.8" x 3.2" x 1.5"
DDC-12/24-C	Digital Duo Charge, 12/24v, w/Wires (Clamshell)	12/24	-	4.8" x 3.2" x 1.5"
CFII-12/24	Centerfielder II, 12/24v, w/Wires	12/24	-	4.8" x 3.2" x 1.5"
CFII-12/24-C	Centerfielder II, 12/24v, w/Wires (Clamshell)	12/24	-	4.8" x 3.2" x 1.5"

## Regulator Accessories

Part Number	Description	Volts	Amps	Dimensions
MC-TS-A	Temperature Sensor, Alternator 54 inch Length	12/24	-	54" length
MC-TS-A80	Temperature Sensor, Alternator 82 inch Length	12/24	-	82" length
MC-TS-B	Temperature Sensor, Battery 20 ft Length	12/24	-	240" length
TSP-12	Spike Ground Protector, 12v Only	12	10	10" length
TSP-24	Spike Ground Protector, 24v Only	24	10	10" length
30-SR12-02	Regulator, Internal Smart Ready 12V Kit for Valeo	12	-	-
1010	Wiring Harness, 6 & AT-Series, 12v, Gray Field/Stator Plug	12	-	54" length
1020	Wiring Harness, 6 & AT-Series, 12v, Gray Field/Stator Plug	12	-	120" length
1012	Wiring Harness, 6-Series, 24v, Gray Field/Stator Plug	24	-	54" length
1022	Wiring Harness, 6-Series, 24v, Gray Field/Stator Plug	24	-	120" length
1011	Wiring Harness, 94 Series, 12v, Black Tee-Style Field/Stator Plug	12	-	54" length
1013	Wiring Harness, 94 Series, 24v, Black Tee-Style Field/Stator Plug	24	-	54" length
1014	Wiring Harness, 70,97,98 Series, 12v, Ring Terminals on Field/Stator Plug	12	-	54" length
1016	Wiring Harness, 96,97,98 Series, 24v, Ring Terminals on Field/Stator Plug	24	-	54" length

## Ordering Information

Balmar DC Charging Solutions are available worldwide through our distribution and dealer network. Through its association with CDI Electronics, Balmar has also recently expanded its distribution partner network.



## Alternator Accessories

Part Number	Description	Volts	Amps	Dimensions
BB	Belt Buddy, only for UAA Adjustment Arm	-	-	11.0" x 1.0" x 1.0"
BBU	Belt Buddy, Universal, w/o Adjustment Arm	-	-	3.0" x 1.0" x 1.0"
UAA	Universal Adjustment Arm	-	-	11.0" x 1.0" x 0.3"
UBB	Belt Buddy, w/UAA Universal Adjustment Arm	-	-	3.0" x 1.0" x 1.0"
15-TSS	Signal Stabilizer, Tachometer	12	-	2.5" X 2.5" X 1"
6-0020	KIT, Hardware, Yanmar (ex. CX/LP)	-	-	-
6-0030	KIT, Hardware, Yanmar 6CX	-	-	-
6-0040	KIT, Hardware, Yanmar LP, 6LP	-	-	-
7060	Offshore Repair Kit, 60 Series, 12v, (incl brngs, brushes, regltr/rectfr)	12	-	-
7060-24	Offshore Repair Kit, 60 Series, 24v, (incl brngs, brushes, regltr/rectfr)	24	-	-
7090	Offshore Repair Kit, 90 Series, 12/24v, (incl brngs, brushes, ps/ng diodes)	12/24	-	-
7094	Offshore Repair Kit, 94 Series, 12/24v, (incl brngs, brushes, ps/ng diodes)	12/24	-	-
7095	Offshore Repair Kit, 95 Series, 12/24v, (incl brngs, brushes, ps/ng diodes)	12/24	-	-
70-XT-170	Offshore Repair Kit, XT Series, 170a, 12v, (incl brngs, brushes, rectfr)	12	-	-
70-AT-165	Offshore Repair Kit, AT Series, 165a, 12v, (incl brngs, brushes, rectfr)	12	-	-
70-AT-200	Offshore Repair Kit, AT Series, 200a, 12v, (incl brngs, brushes, rectfr)	12	-	-
10-4048	Spacer, 1/4in, for 60, 90 Series Alternators	-	-	0.25" x 1.0" dia.
10-4000	Spacer, 1/2in, for 60, 90 Series Alternators	-	-	0.5" x 1.0" dia.
10-4047	Spacer, 1in, for 60, 90 Series Alternators	-	-	1.0" x 1.0" dia.
17-A-201-1	Rectifier Kit, 6 Series, 12V, Smart Ready, IsoGrd	12	-	-
17-A-202-1	Rectifier Kit, 6 Series, 24V, Smart Ready, IsoGrd	24	-	-
12-98-AIR	Air Intake, 98 Series	-	-	1.5" x 6.75" dia.

## AltMount<sup>®</sup> Pulley Kits

Part Number	Description	Type	Pulley	Dia.	Belt
<b>Ford / Lehman</b>					
48-FSP-100	Pulley Kit, Ford/Lehman FL80, FL120	10 Groove Serp.	J10	2.4"	55.0" Circ.
<b>Nanni</b>					
48-NSP-3.3	Pulley Kit, Nanni NE3.30, 4.38	6 Groove Serp.	K6	2.3"	40.0" Circ.
48-NSP-4.6	Pulley Kit, Nanni N4.6	6 Groove Serp.	K6	2.3"	42.3" Circ.
48-NSP-100	Pulley Kit, Nanni N4.85, N100	6 Groove Serp.	K6	2.3"	44.5" Circ.
<b>Perkins/Sabre</b>					
48-PSP-410-A	Pulley Kit, Perkins 4107, 4108	6 Groove Serp.	K6	2.3"	40.0" Circ.
48-PSP-6354	Pulley Kit, Perkins 6.354	10 Groove Serp.	J10	2.4"	55.0" Circ.
48-VSP-MD-A	Pulley Kit, Perkins PERAMA M20, M25, M30, Volvo MD2030	10 Groove Serp.	J10	2.4"	33.0" Circ.
48-VSP-PR-A	Pulley Kit, Perkins Prima, M50, M60, M80, Volvo Prima, TMD-22	10 Groove Serp.	J10	2.4"	40.0" Circ.
<b>Vetus</b>					
48-VSP-M4.17	Pulley Kit, Vetus M4.15, M4.17, M4.55	10 Groove Serp.	J10	2.4"	39.0" Circ.



## AltMount® Pulley Kits (cont'd)

Part Number	Description	Type	Pulley	Dia.	Belt
<b>Yanmar</b>					
48-YSP-3GM-A	Pulley Kit, Yanmar 3GM30	10 Groove Serp.	J10	2.4"	39.0" Circ.
48-YSP-3GM-B	Pulley Kit, Yanmar 3GM30-F, 3GM-F	10 Groove Serp.	J10	2.4"	40.0" Circ.
48-YSP-3GM-C	Pulley Kit, Yanmar 3GM, 2GM-20	10 Groove Serp.	J10	2.4"	32.0" Circ.
48-YSP-3HM-A	Pulley Kit, Yanmar 3HM35, 3HM	10 Groove Serp.	J10	2.4"	33.0" Circ.
48-YSP-3HM-B	Pulley Kit, Yanmar 3HM35-F, 3HM-F	10 Groove Serp.	J10	2.4"	40.0" Circ.
48-YSP-3JH-A	Pulley Kit, Yanmar 3JH5, 3JH4-E, 4JH4-E, 4JH5, 4JH5-E	10 Groove Serp.	J10	2.4"	44.5" Circ.
48-YSP-3JH-C	Pulley Kit, Yanmar 3JH2-TE, 3JH2-E	10 Groove Serp.	J10	2.4"	45.0" Circ.
48-YSP-3JH-E	Pulley Kit, Yanmar 3JH3	10 Groove Serp.	J10	2.4"	46.0" Circ.
48-YSP-3YM-A	Pulley Kit, Yanmar 3YM20, 2YM-15	10 Groove Serp.	J10	2.4"	40.0" Circ.
48-YSP-3YM-B	Pulley Kit, Yanmar 3YM30	10 Groove Serp.	J10	2.4"	39.0" Circ.
48-YSP-4JH-B	Pulley Kit, Yanmar 4JH4-HTE -TE -DTE	10 Groove Serp.	J10	2.4"	46.0" Circ.
48-YSP-4JH-D	Pulley Kit, Yanmar 4JH3, -TE, -HTE	10 Groove Serp.	J10	2.4"	48.0" Circ.
48-YSP-4JH-E	Pulley Kit, Yanmar 4JH2-TE -HTE -DTE -UTE	10 Groove Serp.	J10	2.4"	47.0" Circ.
48-YSP-4JH-F	Pulley Kit, Yanmar 4JH, 4JHE -TE -HTE -DTE	10 Groove Serp.	J10	2.4"	47.0" Circ.
48-YSP-4LH-A	Pulley Kit, Yanmar 4LH-A	10 Groove Serp.	J10	2.4"	47.0" Circ.
48-YSP-6LY-A	Pulley Kit, Yanmar 6LY, 6LYA-STP, 6LY2-STP	10 Groove Serp.	J10	2.4"	55.0" Circ.
<b>Second Alternator Kits for Yanmar</b>					
48-YDA-4JH-A	Pulley Kit, Yanmar 4JH3, Second Alternator Kit	10 Groove Serp.	J10	2.5"	28" Circ.
48-YDA-4JH-B	Pulley Kit, Yanmar 4JH4-HTE, TE, Second Alternator Kit	10 Groove Serp.	J10	2.5"	28" Circ.
48-YDA-4JH-C	Pulley Kit, Yanmar 4JH4-E, Second Alternator Kit	10 Groove Serp.	J10	2.5"	26" Circ.
48-YDA-6LY-A	Pulley Kit, Yanmar 6LY, LY-2, Second Alternator Kit	10 Groove Serp.	J10	2.5"	32" Circ.
<b>Universal</b>					
48-USP-5432	Pulley Kit, Universal 5432	6 Groove Serp.	K6	2.3"	40.0" Circ.
48-USP-M25	Pulley Kit, Universal M25, M-A	10 Groove Serp.	J10	2.4"	42.0" Circ.
48-USP-M35B	Pulley Kit, Universal M35B, M25XPB, M40B	10 Groove Serp.	J10	2.4"	40.0" Circ.
48-USP-M50	Pulley Kit, Universal M50, M-50, M50A, M50B, 5444	6 Groove Serp.	K6	2.3"	40.0" Circ.
48-USP-M-B	Pulley Kit, Universal M-35	10 Groove Serp.	J10	2.4"	43.0" Circ.
<b>Volvo</b>					
48-VSP-2001	Pulley Kit, Volvo 2001, 2002, 2003, 2003T (Three Pulleys)	6 Groove Serp.	K6	2.3"	34.5" Circ.
48-VSP-2001R	Pulley Kit, Volvo 2001, 2002, 2003, 2003T (Two Pulleys, no FW Pump)	6 Groove Serp.	K6	2.3"	33.1" Circ.
48-VSP-D2-A	Pulley Kit, Volvo D2-55A, B, C, D, E, F	10 Groove Serp.	J10	2.4"	44.0" Circ.
48-VSP-MD-A	Pulley Kit, Volvo MD2030, Perkins PERAMA M20, M25, M30	10 Groove Serp.	J10	2.4"	33.0" Circ.
48-VSP-MD-B	Pulley Kit, Volvo MD2040	10 Groove Serp.	J10	2.4"	42.0" Circ.
48-VSP-PR-A	Pulley Kit, Perkins Prima, M50, M60, M80, Volvo Prima, TMD-22	10 Groove Serp.	J10	2.4"	40.0" Circ.
<b>Westerbeke</b>					
48-WSP-12C	Pulley Kit, Westerbeke 12C, 12D, 20B, 30B	10 Groove Serp.	J10	2.4"	38.0" Circ.
48-WSP-18	Pulley Kit, Westerbeke 18, 21A, 27A, 35B, 38B, 42B	10 Groove Serp.	J10	2.4"	40.0" Circ.
48-WSP-21	Pulley Kit, Westerbeke 21, 13A, 27	10 Groove Serp.	J10	2.4"	40.0" Circ.
48-WSP-33	Pulley Kit, Westerbeke 30C, 33	10 Groove Serp.	J10	2.4"	40.0" Circ.
48-WSP-40	Pulley Kit, Westerbeke 40	6 Groove Serp.	K6	2.45"	41.5" Circ.
48-WSP-44A	Pulley Kit, Westerbeke 44A, 44B, 44C	10 Groove Serp.	J10	2.4"	40.0" Circ.
48-WSP-46	Pulley Kit, Westerbeke 46	6 Groove Serp.	K6	2.3"	40.0" Circ.
48-WSP-71	Pulley Kit, Westerbeke 71, 82	10 Groove Serp.	J10	2.4"	47.0" Circ.



## AltMount® Accessories

Part Number	Description	Type	Pulley	Dia.	Belt/Bore
<b>AltMount® Belt Accessories</b>					
48-B-26	Belt, 26in Circumference	10 Groove Serp.	J10	-	26" Circ.
48-B-28	Belt, 28in Circumference	10 Groove Serp.	J10	-	28" Circ.
48-B-30	Belt , Yanmar 3JH4, 4JH4E, 4JH4-HTE, 4JH3, 2nd Alt. Belt 30in Circ.	10 Groove Serp.	J10	-	30" Circ.
48-B-31	Belt, Yanmar, 31in Circumference	10 Groove Serp.	J10	-	31" Circ.
48-B-32	Belt, Yanmar, 32in Circumference, 6LY Second Alternator	10 Groove Serp.	J10	-	32" Circ.
48-B-33	Belt, Yanmar, 33in Circumference	10 Groove Serp.	J10	-	33" Circ.
48-B-34	Belt, Yanmar, 34in Circumference	10 Groove Serp.	J10	-	34" Circ.
48-B-35	Belt, Yanmar, 35in Circumference	10 Groove Serp.	J10	-	35" Circ
48-B-36	Belt, Yanmar, 36in Circumference	10 Groove Serp.	J10	-	36" Circ.
48-B-37	Belt, Yanmar, 37in Circumference	10 Groove Serp.	J10	-	37" Circ.
48-B-38	Belt, Yanmar, 38in Circumference	10 Groove Serp.	J10	-	38" Circ.
48-B-39	Belt, Yanmar 3GM30, 39in Circumference	10 Groove Serp.	J10	-	39" Circ.
48-B-40	Belt, Yanmar 3YM30, 40in Circumference	10 Groove Serp.	J10	-	40" Circ.
48-B-41	Belt, Yanmar, 41in Circumference	10 Groove Serp.	J10	-	41" Circ..
48-B-42	Belt, Yanmar, 42in Circumference	10 Groove Serp.	J10	-	42" Circ.
48-B-43	Belt, Yanmar, 43in Circumference	10 Groove Serp.	J10	-	43" Circ.
48-B-44	Belt, Yanmar, 44in Circumference	10 Groove Serp.	J10	-	44" Circ.
48-B-445	Belt, Yanmar 3JH4, 4JH4-E, 4JH5-E, 3JH5 3 Pulley Kit, 44.5in Circ.	10 Groove Serp.	J10	-	44.5" Circ.
48-B-45	Belt, Yanmar, 45in Circumference	10 Groove Serp.	J10	-	45" Circ.
48-B-46	Belt, Yanmar 4JH4-TE, 4JH4-HTE turbo 3 Pulley Kit, 60in Circ.	10 Groove Serp.	J10	-	60" Circ.
48-B-47	Belt, Yanmar, 47in Circumference	10 Groove Serp.	J10	-	47" Circ.
48-B-48	Belt, Yanmar 4JH3 3 Pulley Kit, 48in Circumference	10 Groove Serp.	J10	-	48" Circ.
48-B-49	Belt, Yanmar, 49in Circumference	10 Groove Serp.	J10	-	49" Circ.
48-B-50	Belt, Yanmar, 50in Circumference	10 Groove Serp.	J10	-	50" Circ.
48-B-51	Belt, Yanmar, 51in Circumference	10 Groove Serp.	J10	-	51" Circ.
48-B-52	Belt, Yanmar, 52in Circumference	10 Groove Serp.	J10	-	52" Circ.
48-B-53	Belt, Yanmar, 53in Circumference	10 Groove Serp.	J10	-	53" Circ.
48-B-54	Belt, Yanmar, 54in Circumference	10 Groove Serp.	J10	-	54" Circ.
48-B-55	Belt, Yanmar 6LY3 Pulley Kit, 55in Circumference	10 Groove Serp.	J10	-	55" Circ.
48-B-56	Belt, Yanmar, 56in Circumference	10 Groove Serp.	J10	-	56" Circ.
48-B-58	Belt, Yanmar, 58in Circumference	10 Groove Serp.	J10	-	58" Circ.
<b>AltMount® Pulley Accessories</b>					
48-AM-39	Pulley, AltMount, 95 Series Alternator	10 Groove Serp.	J10	2.5"	0.875" Bore
48-AM-97	Pulley, AltMount, Hitachi Alternator	10 Groove Serp.	J10	2.4"	17mm Bore
48-AM-102	Pulley, AltMount, 7 Series Alternator	10 Groove Serp.	J10	2.4"	17mm Bore
48-AM-106	Pulley, AltMount, AT Series Alternator	10 Groove Serp.	J10	2.4"	17mm Bore
48-AM-107	Spacer, AltMount, Converts 48-AM-106 for 6 Series Alternators	-	-	1.7"	17mm Bore
48-YBT-4JH-A	Tensioner, Yanmar, 4JH	10 Groove Serp.	J10	2.4"	17mm Bore
48-YP-FT	Pulley, Yanmar, Fixed Tach Alt Pulley	10 Groove Serp.	J10	3.3"	17mm Bore
48-YP-IDL	Pulley, Yanmar, JH Idler Pulley	-	-	2.75"	-

## Ordering Information

Balmar DC Charging Solutions are available worldwide through our distribution and dealer network. Through its association with CDI Electronics, Balmar has also recently expanded its distribution partner network.



## Pulley Accessories

Part Number	Description	Type	Pulley	Dia.	Bore
<b>6-Series and 94-Series Pulley Accessories</b>					
1303	Pulley, Single 2.2" x 1/2" V, 17mm Bore	Single Vee	1/2"	2.2"	17mm Bore
2762	Pulley, Single 2.7" x 7/16" V, 17mm Bore	Single Vee	7/16"	2.7"	17mm Bore
61-0010	Pulley, Single, 2.7" x 1/2" DeepV, 17mm Bore (Std SV on 6-Series)	Single Vee	1/2" DV	2.7"	17mm Bore
1315	Pulley, Single 3.0" x 5/8" V, 17mm Bore	Single Vee	5/8"	2.7"	17mm Bore
24-2100	Pulley, Single 3.4" x 1/2" V, 17mm Bore	Single Vee	1/2"	3.5"	17mm Bore
1305	Pulley, Dual 2.2" x 7/16" V, 17mm Bore	Dual Vee	7/16"	2.2"	17mm Bore
4038-CAM	Pulley, Dual 2.7" x 1/2" V, w/3/8" Spacing	Dual Vee	1/2"	2.7"	17mm Bore
61-0020	Pulley, Dual 2.7" x 1/2" DeepV, 17mm Bore (Std DV on 6-Series)	Dual Vee	1/2" DV	2.7"	17mm Bore
61-0060	Pulley, Dual 2.7" x 1/2" V, 17mm Bore, (For Yanmar 6CX)	Dual Vee	1/2"	2.7"	17mm Bore
2763	Pulley, Dual 2.7" x 5/8" V, 17mm Bore	Dual Vee	5/8"	2.7"	17mm Bore
5908MPV	Pulley, Dual 2.9" x 1/2" V, 17mm Bore	Dual Vee	1/2"	2.9"	17mm Bore
1330	Pulley, Dual 2.9" x 1/2" DeepV, 17mm Bore	Dual Vee	1/2" DV	2.9"	17mm Bore
1318	Pulley, K-6 1.9" (Serp), 17mm Bore	6 Groove Serp.	K6	1.9"	17mm Bore
1273	Pulley, K-6 2.3" (Serp), 17mm Bore	6 Groove Serp.	K6	2.3"	17mm Bore
1316	Pulley, K-6 2.4" (Serp), 17mm Bore	6 Groove Serp.	K6	2.4"	17mm Bore
61-0070	Pulley, K-6 2.45" (Serp), 17mm Bore (Std K6 on 6-Series)	6 Groove Serp.	K6	2.45"	17mm Bore
2749B	Pulley, K-6 2.7" (Serp), 17mm Bore	6 Groove Serp.	K6	2.7"	17mm Bore
1310	Pulley, K-8 2.4" (Serp), 17mm Bore, Short (STD)	8 Groove Serp.	K8	2.4"	17mm Bore
1311	Pulley, K-8 2.4" (Serp), 17mm Bore, (Cummins)	8 Groove Serp.	K8	2.4"	17mm Bore
<b>AT-Series Pulley Accessories</b>					
17-AT-0020	Pulley, Dual 3.2" x 1/2" V, 17mm Bore, Short Shaft (Std DV on AT)	Dual Vee	1/2"	3.2"	17mm Bore
17-AT-K-6	Pulley, K-6 2.5" (Serp), 17mm Bore, Short Shaft (Std K6 on AT)	6 Groove Serp.	K6	2.5"	17mm Bore
17-AT-K-7	Pulley, K-7 2.2" (Serp), 17mm Bore, Short Shaft	7 Groove Serp.	K7	2.2"	17mm Bore
17-AT-K-8	Pulley, K-8 2.7" (Serp), 17mm Bore, Short Shaft	8 Groove Serp.	K8	2.7"	17mm Bore
<b>95-Series, 97-Series, 97EHD-Series and 98-Series Pulley Accessories</b>					
5535-B	Pulley, Dual 2.7" x 1/2" V, .875" Bore	Dual Vee	1/2"	2.7"	0.875" Bore
5540	Pulley, Dual 2.7" x 5/8" V, .875" Bore	Dual Vee	5/8"	2.5"	0.875" Bore
5570	Pulley, Dual 3.6" x 5/8" V, .875" Bore	Dual Vee	5/8"	3.6"	0.875" Bore
59473	Pulley, Dual 2.9" x 1/2" V, .875" Bore	Dual Vee	1/2"	2.9"	0.875" Bore
5538-CAM	Pulley, Dual 2.7" x 1/2" V, .875" Bore	Dual Vee	1/2"	2.7"	0.875" Bore
5550	Pulley, Triple 2.9" x 1/2" V, .875" Bore	Triple Vee	1/2"	2.9"	0.875" Bore
5552	Pulley, K-6 2.7" (Serp), .875" Bore	6 Groove Serp.	K6	2.7"	0.875" Bore
5539	Pulley, K-8 2.5" (Serp), .875" Bore	8 Groove Serp.	K8	2.5"	0.875" Bore
5537-B	Pulley, K-8 2.7" (Serp), .875" Bore, (Cummins)	8 Groove Serp.	K8	2.7"	0.875" Bore

## Multi-Lite™

Part Number	Description	Volts	Amps	Dimensions
458	Multi-Lite, No Switch, DC & AC Applications (Bulb Not Included)	12/24	-	6.5" x 4.0" x 4.5"
458-S	Multi-Lite, Switched, DC & AC Applications (Bulb Not Included)	12/24	-	6.5" x 4.0" x 4.5"

## Ordering Information

Balmar DC Charging Solutions are available worldwide through our distribution and dealer network. Through its association with CDI Electronics, Balmar has also recently expanded its distribution partner network.