

Look for **NEW!** items throughout!

Go Boating with Beckson®



GENUINE THIRSTY-MATE® PUMPS. THE BEST!



CERTIFIED WATERTIGHT DECK PLATES!



YOU WANT OUR PORTS! SEE WHY.



EASY ACCESS HATCHES.



VENTILATE YOUR BOAT 24/7.



ACCESSORIES YOU NEED!



CUSTOM SIGNAGE.



PARTS AND FITTINGS. OEM ADVANTAGE.

MARINE PRODUCTS FROM BECKSON!

All Beckson products are available from fine marine dealers throughout North America. Contact us for technical help, installation advice, and international purchasing assistance.

Go Boating with Beckson!

When you choose genuine Beckson parts and accessories for your boating life, you're joining thousands of boaters and boatbuilders throughout the world who know they can rely on Beckson Marine products to stand up to water and weather.

Developed by boaters for boaters, our top quality marine equipment and accessories are made with your safety, comfort, and enjoyment as our top considerations. To ensure that you get the best, we're continually testing, refining, and adapting our products; and we back them up with exceptional customer service.

There are plenty of low-cost copies of Beckson products in the marketplace; but our customers know that when dependability, safety, and durability really count – genuine Beckson value beats a bargain imitation every time. Always look for the Beckson label or imprint.

For over 60 years, our hand pumps, deck plates, ports, hatches, clips, equipment holders, and other marine items have been installed and used on boats of every kind and on every form of waterway, while earning a solid global reputation for reliability and value.

In 1956, Beckson produced the world's first all-plastic bilge pump, which was introduced to the public at the New York Boat Show in 1957. Thirsty-Mate®, now recognized everywhere by its trademarked red handle and grey body and hoses, is believed to be the first all-plastic machine.

Beckson also premiered the world's first pry-out deck plate, designed to assure a watertight fit. And we don't just say our deck plates are watertight; they've earned FIVE certifications—actually exceeding marine industry and international testing standards for watertightness and submergence!

Over the years we've received many words of gratitude and appreciation from boaters who've found our ports and other products exceptionally reliable and long lasting.

NEW ITEMS THROUGHOUT!

FIND IT!

HAND PUMPS 3 - 13
COMPONENTS | HOSES | ACCESSORIES

DECK ACCESS PLATES 14 - 21
ACCESSORIES | Deck Plate Gasket Maintenance

PORTS 22 - 31
COMPONENTS | Gasket Installation Instructions

HATCHES 32- 37
COMPONENTS | Flush Hatch Installation Instructions

VENTS 38 - 41
COMPONENTS

ACCESSORIES 42 - 48
Holders | Drink Holders | Boat Hooks | Log Books | More

CUSTOM SIGNAGE 48
Documentation Plates | Informational Signs

FITTINGS and FASTENERS 49 - 54
Window Channel | Clips | Barrel Nuts | More

FYI: Safety Notes, Legal Notices 54
OEM Advantage 55



As you look through the catalog, keep an eye out for our little stories about amazing adventurers who went to sea and accomplished what no one had ever done before!

GET YOUR HANDS ON THE REAL THING!

The original grey pump with the red handle beloved by boaters around the world.



124P



Tested to 1,162,835 strokes in salt water without any sign of wear!
Marine Testing Institute

Except for personal flotation devices, there is perhaps no more basic safety equipment for your boat than a hand pump, even on boats equipped with an electric pump.

HIGH CAPACITY LIFEBOAT PUMPS

BILGE PUMPS

KAYAK AND CANOE PUMPS

PONTOON PUMPS

UTILITY PUMPS

CRANKCASE PUMPS

DRUM PUMPS

SIPHON PUMPS

DIAPHRAGM PUMPS





ALL PLASTIC • SELF PRIMING • SELF LUBRICATING • EASY CLEANING
WILL NOT CORRODE • NON-SPARKING

THIRSTY-MATE HIGH CAPACITY SUPER PUMPS FOR ON BOARD AND DOCKSIDE SERIES 519

These pumps can remove a quantity of water easily. See chart, below. Flexible hose in intake end extends to bottom of liquid to be removed. Flexible hose in discharge end allows for directing of flow.

NON-COMMERCIAL USE
MODEL# 519C
MODEL# 519FD
MODEL# 524C

These 519 series pumps are equipped with high quality durable stainless steel hose clamps. See page 11 for more information.



**BELOW DECK PERMANENT MOUNT
MODEL# 519FD**
Outlet Hose is reduced to 1-1/2" for Thru-Hull. Deck plate includes stainless steel safety chain for cover. Mounts below deck.

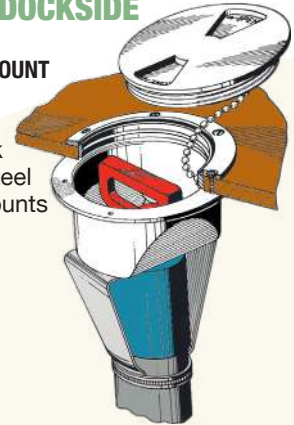

USCG Approval #160.044/14/0
U.S. COAST GUARD APPROVED
LIFEBOAT AND COMMERCIAL VESSEL
MODEL# 519CG#2 MODEL# 519CG#3



All products on this page: 519C, 519FD, 524C, 519CG#2, 519CG#3, 315FP4, 315FP6

Manufactured to exceed the original requirements of U.S. Coast Guard regulation No. 519C. The specifications of this regulation were later reduced when no hand pump other than Beckson's could pass the test requirements. Still "over built" to Beckson's higher standard. Includes stainless steel hose clamps.

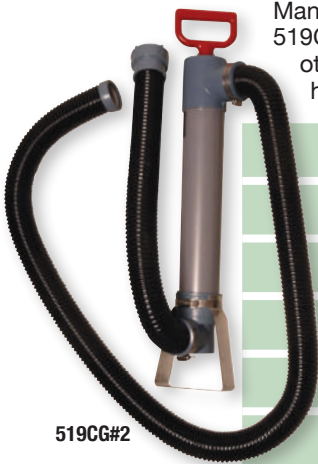

MODEL #	LENGTH	DIAMETER	STROKES/GAL	CAPACITY	INLET HOSE	OUTLET HOSE
519C	24" (61 cm)	3" (7.6 cm)	3	22 GPM (83.3 L)	4' (1.2 m)	6' (1.8 m)
519FD	25" (63 cm)	3" (7.6 cm)	3	22 GPM (83.3 L)	8' (2.4 m)	4' (1.2 m)
524C	33" (84 cm)	3" (7.6 cm)	2.5	30 GPM (113.6 L)	4' (1.2 m)	6' (1.8 m)
519CG#2	24" (61 cm)	3" (7.6 cm)	3	22 GPM (83.3 L)	2' (0.6 m)	6' (1.8 m)
519CG#3	24" (61 cm)	3" (7.6 cm)	3	22 GPM (83.3 L)	3' (1.0 m)	10' (3.0 m)

"... that Thirsty Mate Pump is one of the best I have ever seen. I have an alternate electric pump in the bilge. If I turn it on, it will take about five minutes to empty. With the Thirsty Mate pump I can get the same amount of water out in five or six healthy pumps. Slurp, slurp, slurp and out it goes. A great pump!"

—David Clark, at age 68, one of the world's oldest solo sailor circumnavigators



IMPOSSIBLE PLACE PUMP

A Thirsty-Mate with extra reach! This pump can be permanently installed or used in any position. It comes complete with mounting brackets, intake hose and clamp, strainer/check valve, and discharge hose. Ideal for small boats, engine compartments, and much more.



MODEL #	LENGTH	DIAMETER	STROKES/GAL	CAPACITY	INLET HOSE	OUTLET HOSE
315FP4	14" (35.6 cm)	1-3/4" (4.5 cm)	8	7.5 GPM (28 L)	4' (1.2 m)	2' (61 cm)
315FP6	14" (35.6 cm)	1-3/4" (4.5 cm)	8	7.5 GPM (28 L)	6' (1.8 m)	2' (61 cm)

THIRSTY-MATE PUMPS

The Beckson THIRSTY-MATE® hand pump is manufactured in the U.S.A. of the finest materials available. It is self-priming and very easy to clean. This hand pump will not rust or corrode or mar your boat.

- Self-Priming Plunger Valve
- Special Polyvinyl Grey Body And Shaft
- Removable Foot Valve - Easy Clean
- Non-Sparking
- Solvent welded construction
- Withstands temps to 120°F (49°C)
- Spare parts readily available
- Angled Top Sleeve
- Contoured Red Tee Handle



Products on this page: 118P, 118PF, 118PH, 124P, 124PF, 124PF6, 136P, 136PF, 136PF6, 224P, 224PF, 230PF

What our customers tell us they like about Thirsty-Mate pumps:

- Dependable; they last a long time!
- Lightweight and really easy to use.
- Comfortable handle.
- Very low maintenance.
- Red handle makes them easy to see!



MODEL#	LENGTH	DIAMETER	STROKES/GAL	CAPACITY	HOSE LENGTH
118P	18" (45.7 cm)	1 1/4" (3.2 cm)	10	6 GPM (22.7 L)	NONE
118PF	18" (45.7 cm)	1 1/4" (3.2 cm)	10	6 GPM (22.7 L)	20" (51 cm)
118PH	18" (45.7 cm)	1 1/4" (3.2 cm)	10	6 GPM (22.7 L)	20" (51 cm) RIGID TUBE
124P	24" (61 cm)	1-3/4" (4.4 cm)	6	10 GPM (37.9 L)	NONE
124PF	24" (61 cm)	1-3/4" (4.4 cm)	6	10 GPM (37.9 L)	24" (61 cm)
124PF6	24" (61 cm)	1-3/4" (4.4 cm)	6	10 GPM (37.9 L)	6' (183 cm)
136P	36" (91 cm)	1-3/4" (4.4 cm)	4	13 GPM (49.2 L)	NONE
136PF	36" (91 cm)	1-3/4" (4.4 cm)	4	13 GPM (49.2 L)	3' (91 cm)
136PF6	36" (91 cm)	1-3/4" (4.4 cm)	4	13 GPM (49.2 L)	6' (183 cm)
224P	24" (61 cm)	1-1/2" (3.8 cm)	7	8 GPM (30.3 L)	NONE
224PF	24" (61 cm)	1-1/2" (3.8 cm)	7	8 GPM (30.3 L)	24" (61 cm)
230PF	30" (76.2 cm)	1-1/2" (3.8 cm)	6	10 GPM (37.9 L)	32" (81 cm)

*HOW TO SELECT A PUMP:

Most people prefer pumps with hoses attached.

Hose length determines the proper pump. It's the distance from the pumping site to the side of the boat.

The pump size depends on the amount of fluid to be pumped and the depth of the hull.



ALL PLASTIC • SELF PRIMING • SELF LUBRICATING • EASY CLEANING
WILL NOT CORRODE • NON-SPARKING

KAYAK AND CANOE PUMP MODEL# 318P1

Designed specifically with the sea-kayaker in mind, this upgraded version of our popular **CANOE and KAYAK PUMP 318P** includes a reinforcing shaft which prevents the pump shaft from flexing in a rolling sea and won't affect a compass. They can be conveniently and securely stored in your boat with **CLIPMATE CLIPS** or **CLIPPER CLIPS CLP-1-3/4**. See page 54. For positive flotation for a pump dropped overboard, get **318P1/FPS3R** Sea-Kayak Pump with Float-A-Pump Sleeve installed at the factory.

DON'T LOSE YOUR PUMP. FLOAT YOUR PUMP!

MODEL#	LENGTH	DIAMETER	STROKES/GAL	CAPACITY
318P	18" (45.7 cm)	1-3/4" (4.5 cm)	8	8 GPM (30.3 L)
318P1	18" (45.7 cm)	1-3/4" (4.5 cm)	8	8 GPM (30.3 L)
318P1/FPS3R	18" (45.7 cm)	1-3/4" (4.5 cm)	8	8 GPM (30.3 L)

See other kayak and canoe accessories on page 52.

Anglers are discovering the great fun to be had with kayak fishing. This sport is environmentally friendly and great natural exercise. Also, kayaks can access fishing spots where boats can't go.



WARNING! Cancer and Reproductive Harv
MODEL# 318P-xxx, MODEL# 315FPX, MODEL# 324FPX,
MODEL# 336FPX, MODEL# FP-OUT-3, MODEL# FPS-3R



Add a Float-A-Pump Sleeve (FPS-3R) Page 13.

PONTOON PUMP

The float pump, designed originally for pumping out seaplane pontoons, offers the standard features of a Thirsty-Mate® pump with the addition of a flexible foot and tapered collar that fits standard funnels (see below) in most pontoons. The foot is threaded to accept 1-1/4" (FH 1-1/4) wire-reinforced hose for those who want to extend the reach of their pump. Add a Float-A-Pump Sleeve (FPS-3R) to provide positive flotation in case the pumpslips overboard. This sleeve slides over the foot onto the pump body, providing high visibility as well as flotation. Red or yellow. See page 13.



MODEL#	LENGTH	DIAMETER	CAPACITY
315FPX	15" (38 cm)	1-3/4" (4.5 cm)	7.5 GPM (28.4 L)
324FPX	24" (61 cm)	1-3/4" (4.5 cm)	10 GPM (37.9 L)
336FPX	36" (91 cm)	1-3/4" (4.5 cm)	13 GPM (49.2 L)

PONTOON FUNNEL UV resistant standard funnel. Use with 5/8" (1.6 cm) flexible tubing to pump out pontoons and other enclosed spaces. For M-5 hose clamp, see page 10.

NEW!

MODEL#
FP-FUNNEL

OD: 3" (7.6 cm) CONE HEIGHT: 5/8" (4.1 cm)
I.D. TOP: 1-3/4" (4.4 cm) OUTLET STEM LENGTH: 1" (2.5 cm)
RIM THICKNESS: 1/32" (.1 cm) OUTLET STEM DIAMETER: 5/8" (1.9 cm)

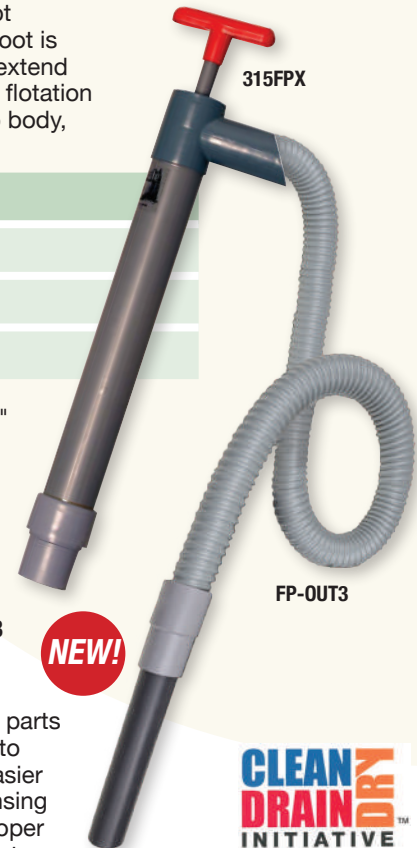

NEW!

PONTOON PUMP DISCHARGE HOSE ASSEMBLY MODEL# FP-OUT3

State, province, and federal agencies which administer bodies of water in the US and Canada are taking action to slow or prevent the spread of highly damaging invasive aquatic plants and animals. Many areas now require cleaning, draining, and drying all parts of water craft, including pontoon floats and seaplanes, after use and before traveling to another body of water. Draining water from aircraft pontoons and floats is so much easier with Beckson's new Pontoon Pump Hose Assembly! Factory fitted with a rigid dispensing spout, the hose (FH-1-1/4) fits securely into a five gallon or other large container for proper disposal of water in an approved area on land. Length: 3' (91 cm). Please inquire about other lengths. Fits Models **315FPX, 324 FPX, 336 FPX**



Clean Drain Dry is a registered trademark of the Association of Fish and Wildlife Agencies.

**ALL PLASTIC • SELF PRIMING • SELF LUBRICATING • EASY CLEANING
WILL NOT CORRODE • NON-SPARKING**

handy-mate®

UTILITY PUMPS

- Great for home, car, RV, garden. For routine, unusual, and emergency pumping jobs.
- Made entirely of lightweight but tough marine plastic. Will not rust or corrode.
- Non-sparking. Self-priming. Easy to use.
- Pump water from bilges, sump tanks, and from one tank to another.
- Change oil, pumping from inboard, stern drive, or engine crankcases.
- Tube provided for inserting into dipstick hole for quick, efficient pumping.
- Versatile 216PC pumps come with a kit of tubes, hoses, reducing foot, and adapter.



NOT FOR HOT OIL
SEE SAFETY INFORMATION on page 54

Also, read and follow the information on the Safety and Instruction Sheet included with your pump.

* IF PUMPING SEEMS SLOW:

- 1) RUN ENGINE FOR A FEW MINUTES ONLY TO WARM OIL AND FACILITATE FLOW. DO NOT USE PUMP WITH HOT OIL!
- 2) ENSURE THE PUMP INTAKE TUBE IS NOT AGAINST THE BOTTOM OF THE OIL CONTAINER.

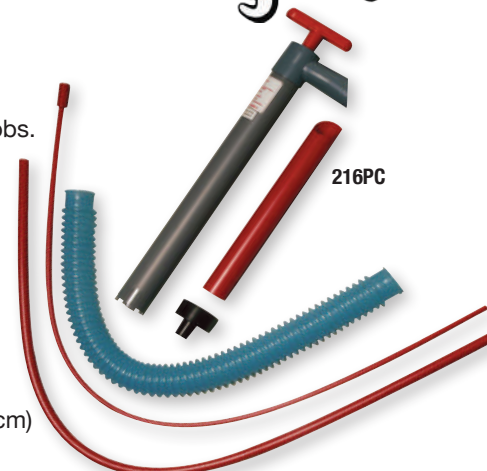

MODEL# 216PC

Length: 16" (40.6 cm)
Diameter: 1-1/2" (3.8 cm)
Pumps: 10 oz/stroke

Two intake tubes:

36" (91.4 cm) long x 1/2" (12.7 mm)
36" (91.4 cm) long x 1/4" (6.4 mm) w adptr

Flexible hose for water discharge:

24" (61 cm) long x 1-1/4" (32 mm)

Red discharge tube for oil:

10" (25 cm) long x 1-1/4" (32 mm)



All products on this page: MODEL# 216PC, MODEL# 212A, MODEL# 212PC, MODEL# 212PGA

MODEL# 212A

For use in draining traps, drain pipes, or other curved piping. Also for pumping from tanks or semi-closed places. Three feet of flexible tube fits into the foot of the pump and extends down into trap or drain. Discharge tube for directing flow into pail or bucket.

212A

NEW!



Length: 12-3/4" (32.4 cm)
Diameter: 1-1/2" (38 mm)
Pumps: 8 oz/stroke
One intake tube:
22" (56 cm) long x 1/2" (12.7 mm)
Red discharge tube:
10" (25 mm) long x 1-1/4" (32 mm)

MODEL# 212PC

Length: 12-3/4" (32.4 cm)
Diameter: 1-1/2" (38 mm)
Pumps: 8 oz/stroke

Two intake tubes:

22" (56 cm) long x 1/2" (12.7 mm)
36" (91.4 cm) long x 1/4" (6.4 mm) w/adptr

Red discharge tube:

10" (25 mm) long x 1-1/4" (32 mm)

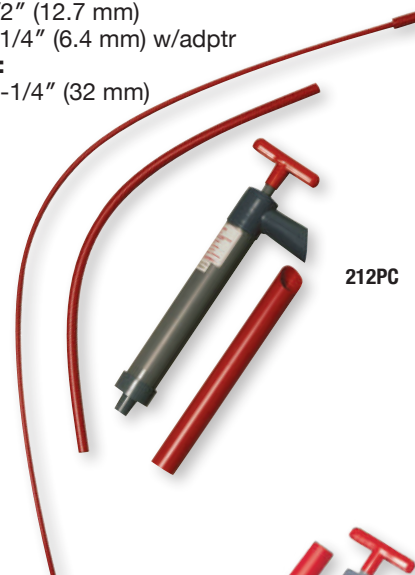

212PC

CRANK CASE PUMP MODEL# 212PGA

ELIMINATE THE MESS OF DIPSTICK OIL CHANGES.

Beckson's Crank Case Pump, the Handy-Mate® 212PGA is specially adapted to pump crank case oil from engines equipped with a threaded fitting on the top of the dipstick tube.

- Threaded adapter fits standard male garden hose couplers.
- Pump attaches quickly and securely.
- Self priming for almost instant pumping action.
- Made of non-sparking materials for safety.
- Large pump body and long pump stroke pumps quickly, easily, and cleanly.
- The Handy-Mate® is made entirely of tough marine plastic; will not rust or corrode.

Length: 12-3/4" (32.4 cm)
Diameter: 1-1/2" (38 mm)
Red discharge tube:
10" (25 cm) long x 1-1/4" (32 mm)

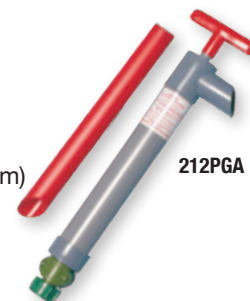

212PGA

siphon-mate®

ALL PLASTIC • SELF PRIMING • SELF LUBRICATING • EASY CLEANING
WILL NOT CORRODE • NON-SPARKING

SIPHON PUMPS SPECIALTY TRANSFER PUMPS

Safety experts caution against the unsafe practice of siphoning petroleum by mouth, warning especially that it can result in a loss of life. Beckson's answer was to invent the Siphon-Mate® pump; a combination displacement lift pump with valves suitable for transferring fuel.

- Acts as a positive displacement hand lift pump.
- Siphons downhill if liquid level in source is higher than receptacle.
- Non-metallic, will not spark or mar finishes.
- Non-corrosive, non-rusting.

MODEL# 109PC SIPHON PUMP
FOR: DIESEL - OIL - WATER

LENGTH: 11-1/2" (29.2 cm)
DIAMETER: 1-1/4" (3.2 cm)
LIFTS: 4 oz (.12 L)

OPEN SIPHON FLOW RATE: 1 gal/min.
Supplied with 8' of clear tubing to allow versatile application. Cut tubing for desired length of intake and discharge hoses.

This pump is not intended for transfer of liquid over 120° F (49° C) nor for solvents that will attack PVC.

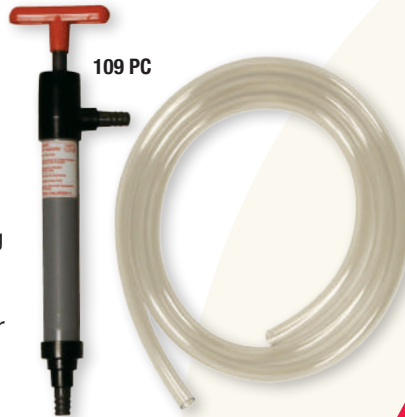

* SIPHON PUMPS: EASY OPERATION!

Begin pumping to start flow. Once flow begins, fully extending the handle will allow siphoning, provided that the source is higher in elevation than the receptacle. Siphon action stops when handle is depressed AND hose is removed from the source.

WARNING! Plan carefully for liquid to drain from pump and hose after dispensing. This is especially important with flammable liquids.

Remove pump from container when not in use to prevent unintentional siphon action or unauthorized use.

! SIPHON PUMPS NOT FOR TRANSFER OF HOT OIL!
SEE SAFETY INFORMATION, PAGE 54

! PUMPS 109PC AND 109A:
SEE SAFETY INFORMATION on page 54. Also, read and follow the information on the Safety and Instruction Sheet included with your pump.

MODEL# 109A SIPHON PUMP
FOR: KEROSENE - DIESEL

LENGTH: 9" (22.9 cm)
DIAMETER: 1-1/4" (3.2 cm)
LIFTS: 4 oz. per stroke (.12 L) per stroke
OPEN SIPHON FLOW RATE: 1 gal/min.

Supplied with 6' clear tubing solvent welded to intake and 3' clear tubing solvent welded to the outlet. Tubing may be cut to desired length. The right angle foot was designed for using the pump in tight spaces.

This pump is not intended for transfer of liquid over 120° F (49° C) nor for solvents that will attack PVC.

NEW!

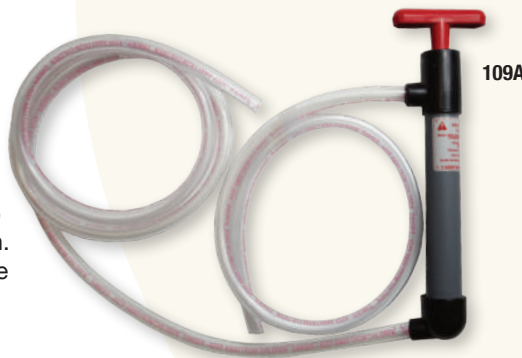

DIAPHRAGM PUMP

- Corrosion-proof marine plastic.
- More than double the capacity of competitively priced pumps.
- 2-position stainless steel handle and adjustable (octagonal) frame permit up to 16 variations in stroke direction.
- Mounts vertically on bulkhead or horizontally on deck; no need for special brackets.
- Uses Beckson FH-1-1/2 (3.8 cm) or VCS-1-1/2 (3.8 cm) hose. Order separately.

(Dimensions with handle removed)

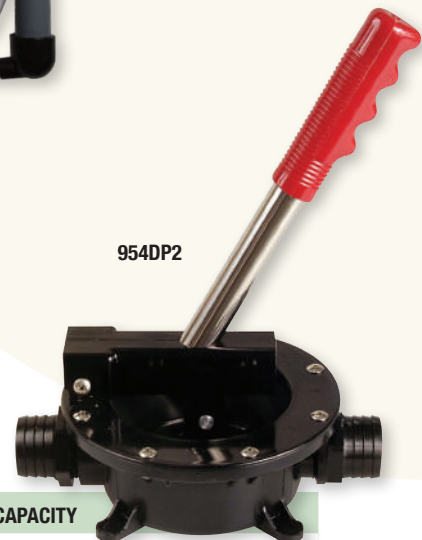

MODEL#	LENGTH	WIDTH	HEIGHT	STROKES/GAL	CAPACITY
954DP2	9" (23 cm)	6-1/4" (16 cm)	4-1/2" (11.4 cm)	28 oz PER STROKE (.8 L)	16 GPM (60 L)

**ALL PLASTIC • SELF PRIMING • SELF LUBRICATING • EASY CLEANING
WILL NOT CORRODE • NON-SPARKING**

**MODEL# 112FUB36,
MODEL# 336PF3-S,
MODEL# 436PF3-S,
MODEL# PMPSTRAP**

DRUM PUMPS

112FUB36 set up for use with 4' hose. (Drum and pail not included)

Pail and drum not to scale.



When you've got jobs that require transferring liquids from large 55 gallon drums to smaller containers, Beckson's drum pumps and their accessories help save your aching back and promote safety and efficiency at the same time. Our highly regarded pumps are made for specific purposes. In addition to our **PAIL DOLLY**, we've got straplocks, pump adapters (see next page), and other items to help you get the job done!

NEW!
PAIL DOLLY
see next page for details



MODEL# 112FUB36 SIPHON FOR POLYPROPYLENE GLYCOL (NON-TOXIC ANTIFREEZE)

NEW!

Included with this pump are a 36" pick-up tube that reaches the bottom of the drum and a 48" discharge hose. Adapters that attach to the threaded opening bungs of most drums are available separately. Beckson's Drum Pump is constructed from PVC and has special valves compatible with non-toxic, propylene glycol anti-freeze.

It is not for use with other chemicals.

Length: 9" (22.9 cm) **Diameter:** 1-1/2" (3.8 cm)
Intake tube: 36" (.91 m) **Discharge hose:** 48" (1.2 m)
Transfers per stroke: 28 oz (.83 L)

Std 2" IPS Bung - Fine Thread Included.
See page 10 for adapter information.

! **PUMPS 112FUB36, 336PF3-S, 436PF3-S:**
SEE SAFETY INFORMATION on page 54. Also, read and follow the information on the Safety and Instruction Sheet included with your pump.

NEW!

STRAPLOCK SAFETY ACCESSORY
MODEL# PMPSTRAP



With an effective design that goes around the pump barrel and over the handle, limiting its movement, our Straplock helps prevent unauthorized and inadvertent use of the pump.

MODEL# 336PF3-S PETROLEUM PUMP

Beckson's 336PF petroleum pump series hand pumps are constructed of PVC with urethane valves and Buna-N seals and come with a reinforced vinyl hose (336 series.)

Length: 38" (.97 m) **Diameter:** 1-1/2" (3.8 cm)
Hose length: 36" (.91 m)
Transfers per stroke: 28 oz (.83 L)

Std 2" IPS Bung- Fine Thread Included.
See page 10 for adapter information.

NEW!

MODEL# 436PF3-S UL LISTED

Eliminate the dangerous practice of lifting or tilting drums. Safely transfer **detergents, waxes, alkalis and certain acids**. The pump shafts are PVC and the valves and seals are Hypalon. They easily fit most drums.

Length: 38" (.97 m) **Diameter:** 1-1/2" (3.8 cm)
Hose length: 36" (.91 m)
Transfers per stroke: 28 oz (.83 L)

Std 2" IPS Bung - Fine Thread Included.
See page 10 for adapter information.

436PF is UL LISTED for transferring **Hydrochloric Acid (HCL)** in concentrations up to 30% maximum at 100° F maximum.

NEW!



NEW!

LIL' DOLLY™ BUCKET / PAIL DOLLY

Perfect for boatyards, marinas, and boatbuilders—anywhere 5, 6, or 15 gallon pails are used for cleaning agents, paints, lubricants, soaps, waxes and similar materials. Ideal for tough jobs and harsh environments. Makes moving and maneuvering heavy five gallon containers so much easier! Meets regulations that require buckets and pails be kept off the floor to allow for more efficient cleaning and to eliminate the accumulation of dirt and bacteria. Beckson's Lil' Dolly™ provides an easy and inexpensive solution. (Pail not included.)

- Five heavy duty ball bearing swivel casters
- Solid urethane 2" wheels
- Base 11" inside diameter
- 75 lb. capacity

MODEL#	MATERIAL	COLOR
DOLLY-2-N-HD	POLYPROPYLENE	BEIGE
DOLLY-2-W-HD	POLYPROPYLENE	WHITE
DOLLY-2-B-HD	POLYPROPYLENE	BLACK

Other colors are available.



Make your transfer jobs easier!

NEW!

CONNECTING A PUMP TO A CONTAINER

The PUMP CONNECTOR and BARREL BUNG ADAPTERS are used to secure the pump to a variety of containers. Please see items below when choosing a connector or adapter for your application.

PMPC CONNECTOR FOR 1-1/2" PUMP

Fits 2" IPS Standard Bung.
Included on the following pumps:
112FUB36
336PF3-S
436PF3-S



PMPC



PMPC



BARREL BUNG ADAPTERS

DRUMADPT-A01 DRUM BUNG ADAPTER
Adapts 2-5/8" ACT Buttress Thread to 2" IPS Standard Thread.
Use with PMPC Connector.



DRUMADPT-B02 DRUM BUNG ADAPTER
Adapts 2-3/4" CCA or Rieke Buttress Thread to 2" IPS Standard Thread.
Use with PMPC Connector



NEW!

CONTAINER WRENCH

MODEL# WRENCH-70

Make the task easier when you're opening large drums for transferring liquids to other containers. For 70 mm and 3/4" Slotted Drum Plugs.

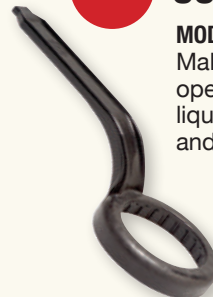

- Easy to Use
- Very Strong
- Small
- Lightweight
- Non-Sparking
- Made of fiberglass filled nylon
- Overall length 9-1/2" (24.1 cm)



NEW!

CLAMPS & MORE

M-FTG0403
90° Poly Elbow
1-1/2" length-
each side



M-06
metal screw
clamp 7/8"
(2.2 cm)



M-05
metal screw
clamp 5/8"
(1.6 cm)



M-WSR-05
nylon washer
OD: 1/2" (1.3 cm)
ID: 1/4" (.6 cm)



M-GPI
nylon ratchet
clamp 1-1/4"
(3.2 cm)



M-KS3198
clamp crimp
3/4"-5/8"
(1.9 cm-1.7 cm)



The M-FTG0403 Poly Elbow is a right angle adapter (1/2" and 3/8") (1.3 cm x 1 cm) foot for a pump that may be used to place 1/2" hose in a space where bending a hose for access would be impractical.

HARD-TO-FIND STAINLESS STEEL THUMB WING HOSE CLAMPS

Perfect for heavy duty and marine use. 5/16" 410 Stainless Steel Thumb Wing Screw with 9/16" Band in 300-series Stainless Steel. 2-piece housing in 300-Series Stainless Steel.



M-24
2 1/16" D.X

NEW!

MODEL#	INCHES	mm
M-24	1-1/16" – 2"	27 – 51
M-36	1-13/16" – 2-3/4"	46 – 70
M-48	2-9/16" – 3-1/2"	65 – 89

PUMP SHAFT ASSEMBLIES

SHAFT, HANDLE, VALVES, AND SUPPORTS

MODEL#	FITS
SHV-118	118 SERIES PUMPS
SHV-124	124 SERIES PUMPS
SHV-136	136 SERIES PUMPS
SHV-224	224 SERIES PUMPS
SHV-230	230 SERIES PUMPS
SHV-318P1	318P1 SERIES PUMPS
SHV-3	519C, 519FD SERIES PUMPS
SHV-3CG	519CG SERIES PUMPS

SHAFT COMPONENT SHV-3

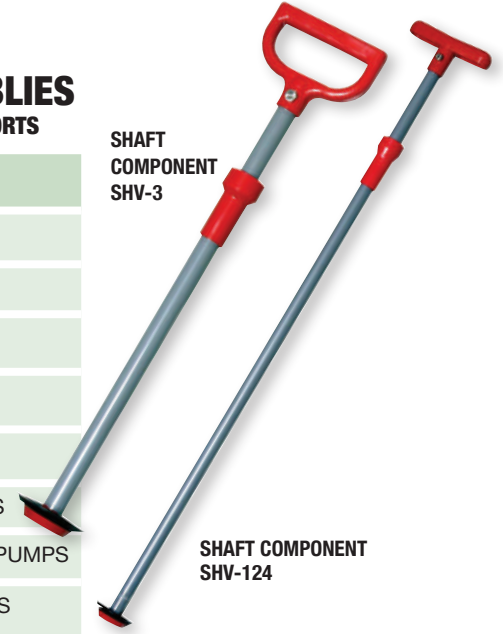

SHAFT COMPONENT SHV-124

PUMP FOOT VALVE ASSEMBLIES

MODEL#	FITS
FV-1-1/4	118 SERIES PUMPS
FV-1-1/2	200 SERIES PUMPS
FV-1-3/4	124, 136, 300 SERIES PUMPS
FV-1-3/4R (RED)	124, 136, 300 SERIES PUMPS
FV-3	519C, 519FD PUMPS
FV-3CG	519CG SERIES PUMPS
FVR1-3/4	124, 136, 300 SERIES PUMPS
FV-FP-4	124, 136, 300 SERIES PUMPS



MODEL# FV-3 VALVE ASSEMBLY for 519 series pumps.



MODEL# FV-1-3/4R



MODEL# FV-1-3/4



MODEL# FV-FP-4 THREADED FOOT VALVE for 1-1/4" (3.2 cm) hose.



"OFF THE BOAT" ROCK STRAINER
MODEL# FVR1-3/4

This strainer replaces the existing foot on the pump and prevents little rocks and debris from damaging the foot valve.

THREADED PIPE ADAPTER

MODEL# A-1

Adapts 1-1/4" (3.2 cm) pipe threads to 1-1/2" (3.8 cm) flexible hose. Ideal for water tanks, heads and holding tanks. Fits Beckson FH-1-1/2 or VCS-1-1/2 hose.



INLINE CHECK VALVE ASSEMBLY

MODEL# CV 1-1/2

Inline check valve to reduce back pressure and facilitate pumping. Fits Beckson FH-1-1/2 or VCS 1-1/2 hose.



*Tip: When attaching Beckson hose to hose caps and threaded fittings, turn **counterclockwise** to tighten.



MODEL# EF-3/4
 MODEL# EF-2
 MODEL# EF-1-1/2 W
 MODEL# CP-1-1/2
 MODEL# CP-2

MODEL# FH-xxx
 MODEL# VCS-xxx

FLEXIBLE WIRE REINFORCED HOSE (FH)

Flexible wire reinforced hose has a coated flexible steel wire in its construction to avoid collapse or distortion. Ideal for pumps and vacuum lines. Color grey. Temperature range -20° to 150° F (-29° to 65° C). **Left hand thread.**



MODEL#	I.D. SIZE	END FITTING	COUPLER
FH-3/4	3/4" (19 mm)	EF-3/4	NONE
FH-1	1" (25 mm)	EF-1	NONE
FH-1-1/4	1-1/4" (32 mm)	EF-1-1/4	CP-1-1/4
FH-1-1/2	1-1/2" (38 mm)	EF-1-1/2	CP-1-1/2
FH-2	2" (51 mm)	EF-2	CP-2

END FITTINGS (EF)

MODEL# EF-3/4
 Fits Beckson FH-3/4 hose



MODEL# EF-2
 Fits Beckson FH-2 hose



MODEL# EF-1-1/2 W
 Fits Beckson VCS-1-1/2 hose



SPECIAL TOILET AND HOLDING TANK HOSE (VCS) SMOOTH INSIDE WALL- WHITE

VCS hose is reinforced with wire and dacron fiber for additional strength, and has a heavy extra coat on the inside to make it smooth. This is superior to our FH hose for toilets and holding tank connections. This smooth inside makes it difficult for bacteria particles to accumulate. Temperature range -20° to 150° F (-29° to 65° C). APPROXIMATE WORKING PRESSURE NEGATIVE PS.I. 12 POSITIVE PS.I. 36 **Left hand thread.**



MODEL#	I.D. SIZE	END FITTING	COUPLER
VCS-1-1/2	1-1/2" (38 mm)	EF-1-1/2W	CP-1-1/2

COUPLERS (CP)

Connect two hose sections of the same diameter together. For use with FH or VCS hose.

MODEL# CP-1-1/2



MODEL# CP-2



COPOLYMER HOSE (VP)

CRUSH PROOF • WILL FLOAT • NON-MAGNETIC • POLYETHYLENE

A special manufacturing process permanently interlocks and seals ball and socket for air tight construction. Ideal for dockside vacuum lines and swimming pools. Contains no metal. Temperature range - 65°F (18°C) to 140°F (56°C). Light grey. 25 foot (7.6 m) lengths. **Left hand thread.**



MODEL#	I.D. SIZE
VP-1-1/4	1-1/4" (32 mm)
VP-1-1/2	1-1/2" (38 mm)
VP-2	2" (51 mm)

* Tip: When attaching Beckson hose to hose caps and threaded fittings, turn **counterclockwise** to tighten.

STRAINER ASSEMBLIES (STV)

Non-corroding strainers including check valve

- MODEL# STV-1
- MODEL# STV-1-1/4
- MODEL# STV-1-1/2
- MODEL# STV-2
- MODEL# FP-OUT3
- MODEL# FH-xxx
- MODEL# FPH-xxx
- MODEL# FPS-3R
- MODEL# FPS-3Y

MODEL# STV-1
Fits Beckson FH-1 hose



MODEL# STV-1-1/4
Fits Beckson FH-1-1/4 hose



MODEL# STV-1-1/2
Fits Beckson FH-1-1/2 hose



MODEL# STV-2
Fits Beckson FH-2 hose



PUMP DISCHARGE HOSE ASSEMBLIES (FH)

MODEL#	LENGTH	FITS
FH-1x2	20" (50.8 cm)	118 Series Pumps
FH-1-1/4x2	24" (61 cm)	124, 136, 300 Series Pumps
FH-1-1/4x3	36" (91 cm)	124, 136, 300 Series Pumps
FH-1-1/4x6	72" (1.8 m)	124, 136, 300 Series Pumps
FP-OUT3 fits foot of pump	36" (91 cm) ask about other lengths	124, 136, 315, 318, 324 pumps



FP-OUT3

FLOAT-A-PUMP SLEEVE

MODEL# FPS-3R (RED) FPS-3Y (YELLOW)

Add a bright red or yellow Float-A-Pump Sleeve to your pump for high visibility and flotation in case the pump slips overboard.

Remove foot; slide sleeve onto pump; replace foot.

Fits 124, 136 and 300 series pumps.



FPS-3R (RED) FPS-3Y (YELLOW)

INTAKE EXTENSION HOSES (FPH)

Designed to extend the intake reach of the 124, 136, and 318 pumps, also models 315FPX, 324FPX, 336FPX.

Includes adaptive threaded foot valve, FVFP4. Use the intake hose to pump out hard to see or reach areas.

Comes with bilge strainer to prevent clogging. Makes difficult pumping jobs easier.

MODEL#	LENGTH
FPH-1-1/4-4	4' (1.2 m)
FPH-1-1/4-6	6' (1.8 m)



*Tip: When attaching Beckson hose to hose caps and threaded fittings, turn **counterclockwise** to tighten.

DECK PLATE INSTALLATION INSTRUCTIONS
ARE INCLUDED WITH CONSUMER PRODUCTS

OUR SELECTION OF CERTIFIED DECK PLATES INCLUDES

- screw-out and pry-out styles
- 3 different sizes
- 3 different surface textures: diamond, smooth, pebble
- multiple material selections
- standard or thin trim rings

In addition, to give you years of dependability, stock plates are made from ASA Plastic for superior strength and durability or Polypropylene for solvent resistance. Both materials include special UV resistance packages.

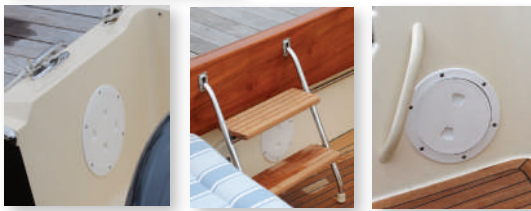

“We have happily used Beckson deck plates for years on our O'Day 37 to get to an almost inaccessible engine room for checking fluids and temperature gauges and so much more. I have always trusted them to keep water out while keeping the captain from having to crawl into the engine room upside down . . .

Anne and Bob Pounds, PA, veteran sailors: Eastern Seaboard, Chesapeake Bay



The Beckson highest quality, certified deck plates that you purchase today have an interesting history. Beckson was one of the first manufacturers of plastic access plates in the mid-20th century. While metal screw-out plates had been around for eons, Beckson invented the plastic pry-out plate for easier access and assured watertightness. Originally manufactured to military specifications, they were used in shipping and land containers for goods all over the world. They were also submitted for review to the US Coast Guard. After having passed their rigorous testing procedures, the Beckson 8" pry-out deck plate was approved for use and installed on Burke class U.S. Navy Guided Missile Destroyers built at Bath Iron Works in Maine.

Today, as we have for years, Beckson still supplies high quality polycarbonate deck plates to the U.S. Navy. You, too, can outfit your own vessel with the best quality deck plates available . . . and they're certified!



DP84-B



DP60-W



DP40-B-C

DP65-N PRY-OUT

WHAT DO YOU WANT FROM DECK ACCESS PLATES?

- No leaks
 - Secure closure
 - No jamming
- Strength and durability
 - Ease of use
 - Choice of sizes, colors, materials, and textures
 - Years of dependability

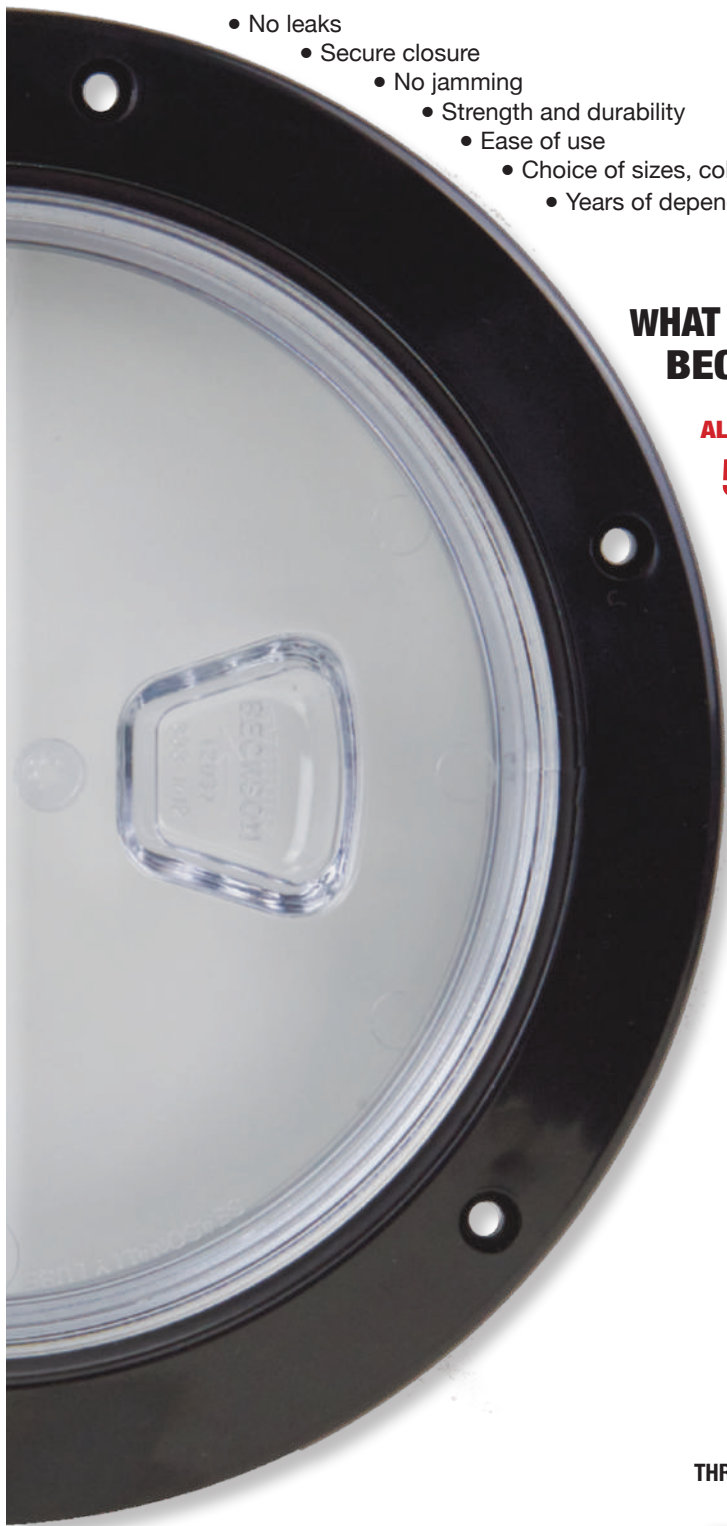

DP60-B-C SCREW-OUT

WHAT DO YOU GET FROM ALL 4", 6", 8" BECKSON DECK ACCESS PLATES?

ALL THE ABOVE AND

5 CERTIFICATIONS. THEY'RE WATERTIGHT!

Certified by independent lab testing to exceed standards:

- 1 ABYC H-3 WATERTIGHTNESS**
- 2 ABYC H-4**
- 3 NEMA 250 6P SUBMERGENCE**
- 4 ISO 12216**
- 5 ISO 11812**

- PRY OUT DECK PLATES**
- SCREW OUT DECK PLATES**
- VENT TOP DECK PLATES**
- STOWAWAY DECK PLATES**

- TWIST OUT ACCESS PLATES**
- COVER PLATES**
- DRAIN PLUGS**
- DECK PLATE ACCESSORIES**

THREE SURFACE TEXTURES

DIAMOND

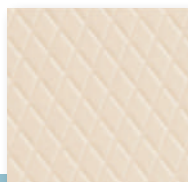

SMOOTH

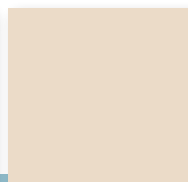

PEBBLE



CERTIFIED WATERTIGHT

PRY-OUT DECK PLATES: 6", 8"

6" PRY-OUT DECK PLATES

MODEL#	COLOR	CENTER STYLE
DP61-B	BLACK	SMOOTH*
DP61-B-C	BLACK/CLEAR	SMOOTH*
DP61-W	WHITE	SMOOTH*
DP61-W-C	WHITE/CLEAR	SMOOTH*
DP63-B	BLACK	PEBBLE
DP63-N	BEIGE	PEBBLE
DP63-W	WHITE	PEBBLE
DP65-B	BLACK	DIAMOND
DP65-N	BEIGE	DIAMOND
DP65-W	WHITE	DIAMOND

OEM Note: Special color/materials and logo centers available.

Beckson developed the first Pry-Out Deck Plate as an access cover to a permanently mounted pump. Designed with an extra heavy O-ring to assure a watertight fit, Pry-out Deck Plates should be installed only in areas where there is no internal pressure (oil-canning.)

Our certified watertight Deck Plates are manufactured with textured or smooth surfaces for different installation requirements. With their assist for better traction, the Diamond Pattern and the Pebble Pattern Deck Plates are for areas with foot traffic. Their non-skid pattern extends across the center, eliminating the edge ring that traps dirt and debris. Rain and spray keep the surface clean. Our smooth surface Deck Plates are for use in vertical applications and in places where there is no foot traffic. For visual inspection and observation of controls or gauges without removing the plate, Beckson clear center plates are ideal. Thin trim rings with or without screw holes are available for 6" Pry-Out deck plates in some color/material combinations.



DP85-W

8" PRY-OUT DECK PLATES

MODEL#	COLOR	CENTER STYLE
DP81-B	BLACK	SMOOTH*
DP81-B-C	BLACK/CLEAR	SMOOTH*
DP81-W	WHITE	SMOOTH*
DP81-W-C	WHITE/CLEAR	SMOOTH*
DP83-B	BLACK	PEBBLE
DP83-N	BEIGE	PEBBLE
DP83-W	WHITE	PEBBLE
DP85-B	BLACK	DIAMOND
DP85-N	BEIGE	DIAMOND
DP85-W	WHITE	DIAMOND



DP81-B-C

*** BE SAFE! Choose textured surface deck plates for pedestrian areas! Smooth Deck Plates are made for vertical applications and areas with no foot traffic. They can be slippery when wet.**

SPECIAL ORDERS

Call us for more information if you require colors other than what you see in this catalog. As always, we continue to produce special color deck access plates for boatbuilders who want dependable, top quality products.

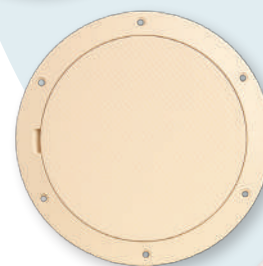

DP65-N



DP63-W

*** We recommend attaching centers with our safety chain. See page 21.**

DIMENSIONS OF PRY-OUT DECK PLATES WITH STANDARD TRIM AND THIN RINGS

All plates include gasket. Use #8 pan head screws.

6"	8"
OD: 8-1/8" (20.6 cm) ID: 6-3/16" (15.7 cm) Hole Cut: 6-1/2" (16.5 cm) Additional Gasket D6P-G Thin Ring OD: 7-1/2" (19.06 cm) For Thin Ring add T to Model #	OD: 10" (25.4 cm) ID: 8" (20.3 cm) Hole Cut: 8-1/2" (21.6 cm) Additional Gasket D8P-G No Thin Ring for 8" deck plates

*** OD: OUTSIDE DIMENSION
ID: INSIDE DIMENSION**

CERTIFIED WATERTIGHT

SCREW-OUT DECK PLATES: 4", 6", 8"



The Beckson Screw-Out Deck Plate was designed to provide access without the use of tools, with a single start, non-jamming (no cross-thread), extra strong, self-cleaning buttress thread. A self-aligning center and an innovative gasket assure a watertight seal. A unique back-up sealing wall leaves the plate water resistant, even if the gasket is missing.

A screw-out plate should be used in compartments where a change in air pressure due to temperature or oil canning can occur. Deck plates are used for access, inspection, and clean out for compartments and tanks, or just as general access for shut-off valves or back fastenings. Clear center plates permit visual inspection and observation of controls or gauges without removal of the plate. Thin trim rings with or without screw holes are available for 4" and 6" Screw-Out deck plates in some color/material combinations.

OEM Note: Special color/materials and branded centers are available.

DP84-B **BE SAFE!** Choose textured surface deck plates for pedestrian areas!

4" SCREW-OUT DECK PLATES

MODEL#	COLOR	CENTER STYLE
DP40-B	BLACK	SMOOTH*
DP40-B-C	BLACK/CLEAR	SMOOTH*
DP40-N	BEIGE	SMOOTH*
DP40-W	WHITE	SMOOTH*
DP40-W-C	WHITE/CLEAR	SMOOTH*
DP42-B	BLACK	PEBBLE
DP42-N	BEIGE	PEBBLE
DP42-W	WHITE	PEBBLE
DP44-B	BLACK	DIAMOND
DP44-N	BEIGE	DIAMOND
DP44-W	WHITE	DIAMOND



6" SCREW-OUT DECK PLATES

MODEL#	COLOR	CENTER STYLE
DP60-B	BLACK	SMOOTH*
DP60-B-C	BLACK/CLEAR	SMOOTH*
DP60-N	BEIGE	SMOOTH*
DP60-W	WHITE	SMOOTH*
DP60-W-C	WHITE/CLEAR	SMOOTH*
DP62-B	BLACK	PEBBLE
DP62-N	BEIGE	PEBBLE
DP62-W	WHITE	PEBBLE
DP64-B	BLACK	DIAMOND
DP64-N	BEIGE	DIAMOND
DP64-W	WHITE	DIAMOND

U.S. Pat No. 6,364,146 B1

8" SCREW-OUT DECK PLATES

MODEL#	COLOR	CENTER STYLE
DP80-B	BLACK	SMOOTH*
DP80-B-C	BLACK/CLEAR	SMOOTH*
DP80-N	BEIGE	SMOOTH*
DP80-W	WHITE	SMOOTH*
DP80-W-C	WHITE/CLEAR	SMOOTH*
DP82-B	BLACK	PEBBLE
DP82-N	BEIGE	PEBBLE
DP82-W	WHITE	PEBBLE
DP84-B	BLACK	DIAMOND
DP84-N	BEIGE	DIAMOND
DP84-W	WHITE	DIAMOND

DIMENSIONS OF SCREW-OUT DECK PLATES WITH STANDARD TRIM AND THIN RINGS All plates include gasket . Use #8 pan head screws.

4"	6"	8"
OD: 6-1/8" (15.6 cm) ID: 4" (10.2 cm) Hole Cut: 4-1/2" (11.4 cm) Additional Gasket D4S-G Thin Ring OD: 5-5/8" (14.3 cm) For Thin Ring add T to Model #	OD: 8-1/8" (20.6 cm) ID: 6" (15.2 cm) Hole Cut: 6-1/2" (16.5 cm) Additional Gasket D4S-G Thin Ring OD: 7-1/2" (19.1 cm) For Thin Ring add T to Model #	OD: 10" (25.4 cm) ID: 7-5/8" (19.4 cm) Hole Cut: 8-1/2" (21.6 cm) Additional Gasket D8S-G No Thin Ring for 8" deck plates



STOWAWAY™ DECK ACCESS PLATES WITH BAGS

4", 5", 6" and 8" bags
Dry - Hidden Storage

Our 4", 5", 6" and 8" Screw-out and Twist-out Deck Plates can double as dry storage areas! The nylon drawstring bag features a rigid ring that fits neatly into the deck plate equipped with a retaining ring and secures the bag. Bags are removable for access below deck and to carry items ashore. Perfect for storing and carrying watches, wallets or any item that could be lost overboard. Extra long bags available for fender storage.



DECK ACCESS PLATE DIMENSIONS ON PAGE 14 AND 15

MODEL #	COVER COLOR	SIZE	COVER TYPE	BAG TYPE
DP40BB	BLACK	4"	SCREW-OUT	12" STANDARD
DP40BW	WHITE	4"	SCREW-OUT	12" STANDARD
DP50BB	BLACK	5"	TWIST-OUT	12" STANDARD
DP50BN	BEIGE	5"	TWIST-OUT	12" STANDARD
DP50BW	WHITE	5"	TWIST-OUT	12" STANDARD
DP50FB	BLACK	5"	TWIST-OUT	20" FENDER
DP50FW	WHITE	5"	TWIST-OUT	20" FENDER
DP60BB	BLACK	6"	SCREW-OUT	12" STANDARD
DP60BW	WHITE	6"	SCREW-OUT	12" STANDARD
DP60FB	BLACK	6"	SCREW-OUT	24" FENDER
DP60FW	WHITE	6"	SCREW-OUT	24" FENDER
DP80BW	WHITE	8"	SCREW-OUT	12" STANDARD
DP80BB	BLACK	8"	SCREW-OUT	12" STANDARD
DP82BW	WHITE	8"	SCREW-OUT	12" STANDARD

Above models have smooth centers. Also available with pebble and diamond centers. Please call us to order.

CONVERSION KITS AVAILABLE

MODEL#	
D4SKBAG	BAG KIT FOR 4"
D5SKBAG	BAG KIT FOR 5"
D6SKBAG	BAG KIT FOR 6"
D8SKBAG	BAG KIT FOR 8"

Standard Red Nylon Drawstring Bag Length 12" for all diameters.

Each kit includes a bag retaining ring to convert Beckson Screw-Out Deck Plates to accept a drop-in Drawstring Ditty Bag. For ABS plates only.

FRESH GASKETS AVAILABLE SEPARATELY.
See page 20.

*** DON'T LOSE YOUR CENTERS!**
Use Safety Chain, page 21.

VENT TOP DECK PLATE

Add extra ventilation with this adaptable deck plate. Each unit includes both vent center and standard smooth center. Cowl vent may be removed and standard smooth center plate installed to keep deck clear and watertight. White only. Standard smooth center can be either solid white or clear. Available in both pry-out and screw-out models. Select low-rise (LP) or high rise (HP).



6"	OD: 8-1/8" (20.6 cm) PASSAGE: 6-3/16" (15.2 cm) HOLE CUT: 6-1/2" (16.5 cm)	SCREW-OUT			PRY OUT		
		MODEL#	HEIGHT	CENTER	MODEL#	HEIGHT	CENTER
		DP-LP-6S	1-3/4" (4.5 cm)	WHITE	DP-LP-6	1-3/4" (4.5 cm)	WHITE
		DP-LPC-6S	1-3/4" (4.5 cm)	CLEAR	DP-LPC-6	1-3/4" (4.5 cm)	CLEAR
		DP-HP-6S	3" (7.62 cm)	WHITE/CLEAR	DP-HP-6	3" (7.62 cm)	WHITE/CLEAR
		DP-HPC-6S	3" (7.62 cm)	CLEAR	DP-HPC-6	3" (7.62 cm)	CLEAR

* OD: OUTSIDE DIMENSION
ID: INSIDE DIMENSION



DP50-W



DP50-B

OEM Note:
Special colors
and branded centers
are available.



BECKSON 5" TWIST-OUT PLATE

Overlapping Cover Conceals Fasteners - For A Clean Modern Look On Any Bulkhead.

Perfect for non load-bearing areas with no foot traffic, Beckson's innovative 5" deck access plate was designed to conceal its mounting fasteners under the quick twist cover. The low profile cover is self-centering and quickly locks in place with a 1/8 twist. Three separate sealing areas, each designed to chase water away from the plate opening, assure a tight closure. The bayonet threads are non-jamming, self-cleaning, and lift the center for easy removal. These 5" Twist-Out deck plates are available with Stowaway Bags.

5"	OD: 7" (17.8 cm)	MODEL#	COLOR
	ID: 5" (12.7 cm)	DP50-W	WHITE
	HOLE CUT: 5-1/2" (14 cm)	D050-B	BLACK
		DP50-N	BEIGE

BECKSON COVER PLATES

Not just for boats! Easily and quickly seal and hide installation holes, instrument panel holes and other access holes where ready entry is not a requirement. Molded of high impact marine quality plastic, with ultraviolet inhibitors for prolonged service, Cover Plates conceal holes up to 5" (13 cm) in diameter and mount with only four screws. High-tech matte finish provides a rich looking installation.



6 1/2"	OD: 6-1/2" (16.5 cm)	MODEL#	COLOR
	ID: 5-1/8" (13 cm)	CVR64AB	BLACK
	COVERS: 5" hole	CVR64AW	WHITE
		CVR64AN	BEIGE
4 1/2"	OD: 4-1/2" (11.4 cm)	M-10	WHITE
	ID: 3-1/2" (8.9 cm)		
	COVERS: 3-1/4" hole	M-10-B	BLACK

NEW!

6" HIGH-TORQUE ACCESS PLATE MODEL# DP60-B-CC Black/Clear | DP60-W-CC White/Clear

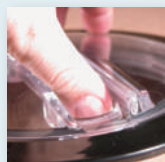

In high pressure, near-vacuum conditions, screw-out centers sometimes became difficult to open. Beckson solved the problem with this watertight high-torque center. Retains the clarity and toughness of the standard center, but has deeper finger holes and a full pry, raised channel to help seal and unseal the unit. Not for decks. Fasteners (6) #8 Pan Head.

O.D. 8-1/8" (20.6 cm) **I.D.** 6" (15.2 cm) **HOLE CUT:** 6-1/2" (16.5 cm)



Roz Savage, a London management consultant, made the decision in 2003 to exchange her high-powered office job for something more meaningful. After mountain climbing in Peru, she turned to ocean rowing. In 2006 she crossed the Atlantic solo; after that, the Pacific; and in 2011, the Indian Ocean. She set four world records—as the first woman ever to row solo across three oceans. Awarded the MBE (Member of the Order of the British Empire), one of England's highest honors, she's also garnered numerous other accolades, as well as speaking engagements around the globe. As writer, speaker, ocean rower, and environmental advocate, she is working to get others to join her in action to keep the oceans and the planet healthy. Her *Rowing the Atlantic: Lessons Learned on the Open Ocean* and *Stop Drifting, Start Rowing*, are inspiring accounts of her monumental, life-changing voyages. As for her rugged, specially designed rowboat, which carried her across vast oceans and through many precarious situations, it was built with Beckson deck plates and hatches aboard!





Thin Rim
6" Screw-Out
Deck Access Plate

Standard Rim
6" Screw-Out
Deck Access Plate

DECK PLATES WITH THIN RINGS

Sometimes space for a deck plate may be extremely limited. For these locations, Beckson has developed outside rings for the 4" and 6" Screw-Out plates and for 6" Pry-Out plates that are at least 1/2" (1.3 cm) smaller than the standard diameter deck plate. Thin Ring Screw-Out plates feature fastenerless mounting, but may be drilled and counter-bored for normal pan head screws. Thin Rim Pry-Out plates are pre-drilled and counter-bored for mounting screws. To order Thin Rim 4" and 6" plates, add "T" to the Deck Plate Model#.

THE ART OF DECK PLATE GASKET INSTALLATION, INSPECTION & MAINTENANCE

• ABOUT BECKSON DECK PLATE GASKETS

The Gasket is an important component of the Deck Plate Set. In a **BECKSON SCREW-OUT DECK PLATE**, the gasket ensures the seal between the Mounting Ring (Receptacle) and the Center (Insert) after threaded closure. For a **BECKSON PRY-OUT DECK PLATE**, the gasket provides both the seal and the closure. For the seals to be at maximum, the gaskets need to be maintained in good condition. Periodic inspection of the integrity of the three component parts is necessary and should be added to your pre-trip checklist. Beckson **DECK PLATE KEYS** help to ensure that Screw-Out Plates are tightly closed and that Pry-Out centers are removed without damage to the Mounting Ring or Center.

• BECKSON SCREW-OUT DECK PLATES:

While the buttress threads of the Screw-Out Deck Plates are to some degree self-cleaning, sand, dirt, grease and other particles and contaminants may still accumulate. This can make the center difficult to open or keep it from closing properly.

If these conditions are present there may be debris between the gasket and the mating surfaces. Remove the Center and clean the threads and the underside of the top lip of the Center. Be sure to clean the threads and thread walls of the Mounting Ring as well. Remove the Gasket and clean both the gasket and the gasket channel and gently re-install the gasket. When installing Screw-Out 4" and 6" Gaskets, be sure that the knock-out marks (little circles) are facing down into the channel. Lay the Gasket gently into the channel and follow it around with your finger to ease it into the channel. Be careful not to twist the Gasket during the installation. Screw-Out Centers should be tightly closed. Threads and Gaskets can be lubricated with Teflon or Silicone Grease or Silicone Spray. Use sparingly. **Petroleum products like WD-40 and CRC-666 and Vaseline should never be used. If the Gasket appears worn or damaged, install a new Gasket.**

• BECKSON PRY-OUT DECK PLATES:

The Beckson Pry-Out Deck Plate Gasket provides both the closure and seal for the Deck Plate Set. The Gasket should be inspected with every opening of the plate. If the Gasket is dirty, remove and clean the gasket and the gasket groove with soap and water and reinstall the gasket. Also clean the mating surfaces of the Mounting Ring or Center with soap and water.

If the Mounting Ring or Center has been damaged or gouged by using an improper tool to remove the Center, a new Deck Plate should be installed. If the gasket appears worn, damaged or flattened, install a new gasket.

When re-installing, the center should press in with some resistance. If it feels loose, use a new Beckson Gasket.

*** It's a good idea to keep genuine Beckson gasket spares aboard with other safety equipment; they can be purchased directly from Beckson by phone or online.**

To ensure the integrity of our deck plates, purchase only genuine Beckson gaskets!

BECKSON DECK PLATE GASKETS

MODEL#	SCREW OUT
D4S-G	4"
D6S-G	6"
D8S-G	8"

MODEL#	TWIST-OUT
D5S-G	5"

MODEL#	PRY-OUT
D6P-G	6"
D8P-G	8"

THE INDISPENSIBLE DRAIN PLUG

Avoid that sinking feeling at the boat ramp! Beckson's best-selling screw-type drain plug with self-cleaning thread, O-ring, and super strength retaining legs secure the center while draining. Works best if it's in place **before** you put your boat in the water! Be sure to keep a few spare centers on hand. These plugs are great for small boats, fish wells, coolers, ice chests, water tanks.

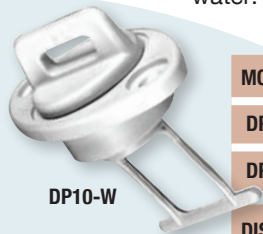

MODEL#	DESCRIPTION	SIZE	O.D
DP10-B	BLACK DRAIN PLUG W/GASKET	HOLE CUT 1" (2.54 cm)	1-1/4" x 2" (3.18 cm x 5.08 cm)
DP10-W	WHITE DRAIN PLUG W/GASKET	HOLE CUT 1" (2.54 cm)	1-1/4" x 2" (3.18 cm x 5.08 cm)
DIS-CTR-B	BLACK CENTER COMPONENT ONLY		
DIS-CTR-W	WHITE CENTER COMPONENT ONLY		
DPS1-B	INSTALLATION SEAL FOR DP10-B		



NEW!

BAITWELL GRAVITY DRAIN ASSEMBLY MODEL D-2

ALL PURPOSE DRAIN

This well-designed, compact **GRAVITY DRAIN ASSEMBLY** is perfect for draining livewells, coolers, and tanks. Angled drain holes on the top prevent debris from clogging the assembly. Drain Assembly includes one plastic washer, two rubber washers, and a plastic nut. Accepts 1/2" (1.23 cm) hose. Hose sold separately.

MODEL# D-2

For Scupper Drains, see page 40.

For line connections, see D-5 on page 50.

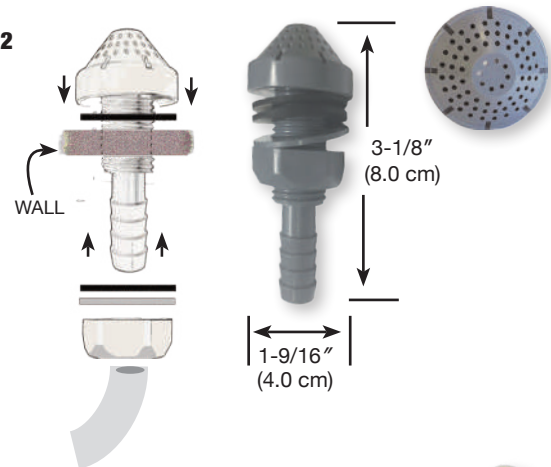

DECK PLATE ACCESSORIES

DPA-4 DECK PLATE KEY. Versatile deck access plate tool. You need this bright yellow, high visibility Deck Plate Key! Made of high strength acetal resin, it's a 3-in-1 multi-tool made to work with screw-out, pry-out, and twist-out plates. The pry-out tool is at one end and a drain plug slot wrench on the other end, which can also be used to hang the key in a handy spot. Two nubs on the tool edge are for use as a spanner wrench with screw-out and twist-out deck plates. Approximately 7" long. You might want to buy extras. They make great gifts for the boaters in your life!

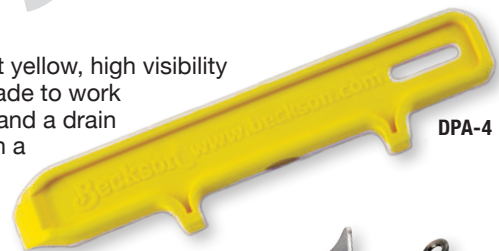

DPA-1 DECK PLATE PRY BAR. For proper removal of the center of 6" or 8" pry-out deck access plates. Made of sturdy aluminum, it comes with an 8" (20.3 cm) 8-18 corrosion and wear-resistant stainless steel chain, and can be kept nearby in a safe convenient place, such as our **HH-81 Soft-Mate Multipurpose Mini-Holder.** (Page 42)



DPA-2 DECK PLATE SAFETY CHAIN. DON'T LOSE YOUR CENTER! 8" (20.3cm) 1-18 stainless steel. For 4", 6" and 8" screw-out as well as 6" and 8" pry-out deck access plates. The underside of the Beckson deck plate center has a 6-pointed starpost into which you can screw one end of the chain with a #6 x 1/2" panhead screw. Attach the other end of the chain to one of the thru-bolts that fasten the mounting rim.







DPA-1 Made in USA
DPA-2 Made in Korea
DPA-4 Made in China





HOW TO SELECT PORTS:

-  **CHOOSE LOCATIONS ON YOUR BOAT THAT COULD BENEFIT FROM ADDITIONAL LIGHT AND AIR.**
-  **WHAT STYLE DO YOU NEED?** Do you need an opening port or a fixed port? The slope of the mounting location will indicate the type of opening port required, NEWPORT™ SELF DRAIN or NEWPORT™ RAIN DRAIN. Fixed ports are sized to match. See the illustration on page 24.
-  **WHAT SIZE DO YOU WANT?** It is generally best to mount the largest port for the available mounting location for new installations. A larger port provides more light and better ventilation. Remember to check both interior and exterior clearances.
-  **WHAT IS THE REQUIRED SPIGOT LENGTH?** For measuring purposes, the spigot is the part of a port which passes through the cabin wall. Estimate the hull or cabin wall thickness at each mounting location as accurately as possible, and add 1/4". Both styles come in standard 1" or 2" spigot lengths, with custom lengths available.
-  **REPLACE OTHER BRANDS.** Beckson Opening and Fixed Ports are engineered to standard mounting hole sizes for interchangeability and replacing other manufacturers' ports.



“About 20 years ago, I installed a set of your wonderful ports in our aft cabin 25 foot Bayliner. I would have to say that these two items that were installed in our boat for light and air were without a doubt the finest trouble free products that I know of.

Cliff and Sandy Steele, Kentucky, long-time Great Lakes boaters and authors of many thoughtful, entertaining, and informative articles about boating.

P0714-WS-10



PF414-BS-20



PB525-WC



WHY CHOOSE BECKSON NEWPORT PORTS?

- YEARS OF TROUBLE-FREE USE WITH NO CORROSION, NO CONDENSATION, NO LEAKS. PORTS OVER 45 YEARS OLD STILL PROVIDE WATERTIGHT SERVICE!
- NO WATERFALL WHEN YOU OPEN THE WINDOW.
- MATCHING FIXED AND OPENING PORTS ARE AVAILABLE.
- OTHER MANUFACTURERS' PORTS CAN BE UPGRADED TO BECKSON PORTS.
- BECKSON OPENING PORTS INCLUDE SCREENS AND EXTERIOR TRIM RINGS.
- ALL BECKSON FIXED PORTS INCLUDE EXTERIOR TRIM RINGS.
- INTERNATIONAL: ALL BECKSON OPENING PORTS ARE CE APPROVED.
- EXCELLENT CUSTOMER SUPPORT

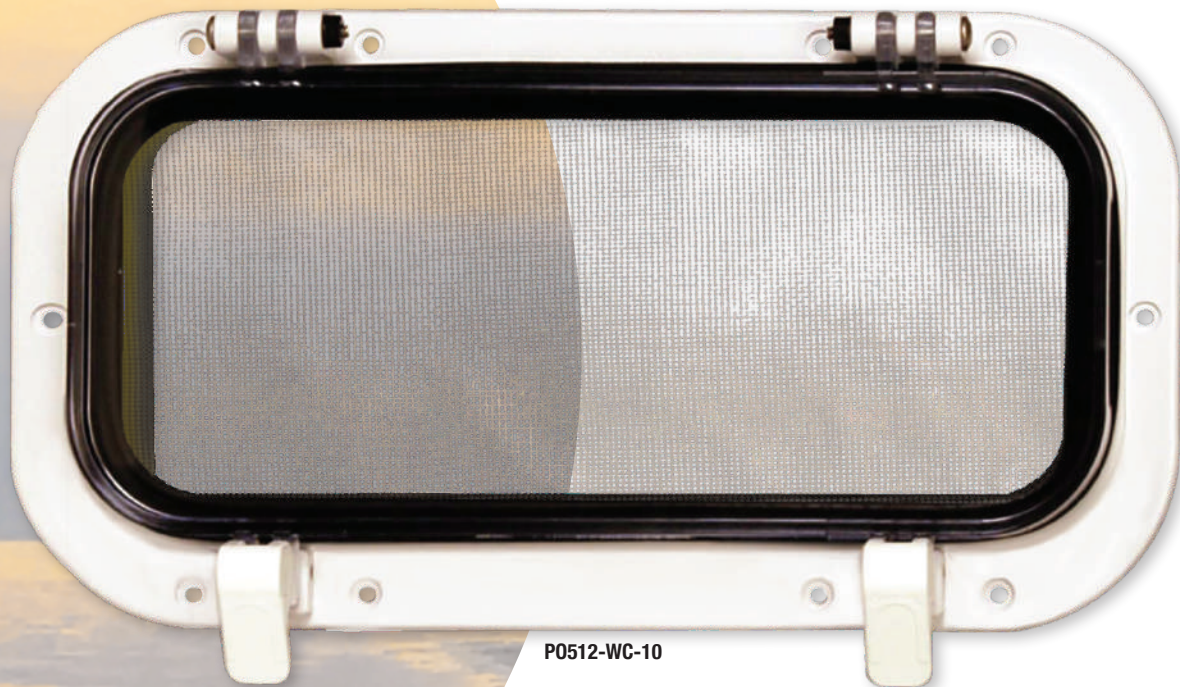

P0512-WC-10

- OPENING PORTS: SELF DRAIN / RAIN DRAIN**
- MATCHING FIXED PORTS**
- ROUND INSPECTION WINDOWS**
- OPENING PORT SIZES**
- COMBINATION OPENING & MATCHING FIXED PORTS**
- SPECIALTY FIXED PORTS**
- PORT GASKETS INSTALLATION**
- PORT PARTS**
- ACCESSORIES**
- LATCHES & KNOBS**

newport™

OPENING PORTS: TWO STYLES

SELF DRAIN™ OPENING PORTS

The Beckson Self Drain Opening Port is innovatively designed with an angled drainage ramp molded on the inside of the spigot. This design promotes drainage without the hassle of making angled cuts in the hull. This also allows for thru-bolting, which is impossible in windows where an angled spigot extends below the bolt holes. The internal angle seats tightly against the gasket and lens, thus omitting an exterior water retention ledge present in most other ports. (No water-fall when you open the port after a rain.) Self Drain Opening Ports are ideal for mounting where installation is within 15° of vertical (with spigot length up to one inch.) Longer spigots are available for vertical installations. For greater angles use Beckson Rain Drain Ports.



RAIN DRAIN™ OPENING PORTS

The Beckson Rain Drain Opening Port is intended primarily for installation where cabin sides have excessive angles and other ports would collect rain and spray. These ports have all the features of our other meticulously designed ports, with the added benefit of Beckson's own Rain Drain. The Rain Drain port, cut at 5/8", will drain while tipped up to 45° degrees. Unlike others, Beckson Rain Drain Ports have open drains which resist clogging and are easy to clean. Other drain windows retain up to one-third of a cup of water in each window when closed. Opening them can soak you and the boat. Where greater mounting angles exist, insist on Beckson Rain Drain ports for superior service.

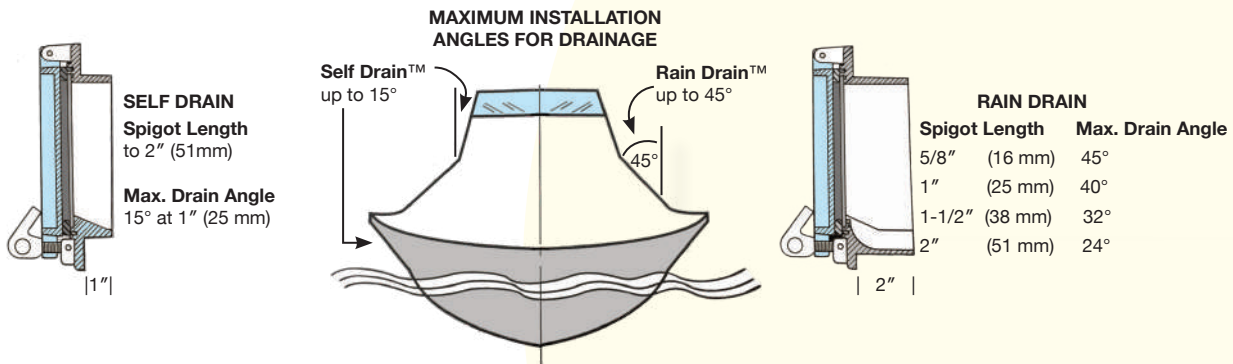

MATCHING FIXED PORTS

Beckson Newport Fixed Ports are designed for light only, and for areas where interior bulkheads, shelves or other restrictions may prevent the installation of an opening port. These matching fixed ports are identical in size, shape, style, mounting, and strength to our opening ports. Standard construction provides for the fixed port to be installed from the interior, with the trim ring on



the exterior, to maintain the same recessed aesthetic appearance as Beckson opening ports. Newport Fixed Ports and Newport Opening Ports share the same mounting hole sizes and overall frame specifications so they are interchangeable. For special installations such as cockpit bulkheads, to simplify installation, or where the same look is not required, Newport Fixed Ports can also be constructed for REVERSE installation, with the trim ring on the interior.

ROUND FIXED INSPECTION WINDOWS

	MODEL#	DESCRIPTION	HOLE CUT	OD
4"	PF4RD-BS	4" BLACK BODY, SMOKED LENS	4-5/8" (11.7 cm)	6-1/2" (15.6 cm)
	PF4RD-WC	4" WHITE BODY, CLEAR LENS	4-5/8" (11.7 cm)	6-1/2" (15.6 cm)
6"	PF6RD-BS	6" BLACK BODY, SMOKED LENS	6-1/2" (16.5 cm)	8-1/8" (20.6 cm)
	PF6RD-WC	6" WHITE BODY, CLEAR LENS	6-1/2" (16.5 cm)	8-1/8" (20.6 cm)
8"	PF8RD-BS	8" BLACK BODY, SMOKED LENS	8-1/8" (20.6 cm)	10" (25.4 cm)
	PF8RD-BC	8" BLACK BODY, CLEAR LENS	8-1/8" (20.6 cm)	10" (25.4 cm)

* OD: OVERALL DIMENSION
ID: INSIDE DIMENSION

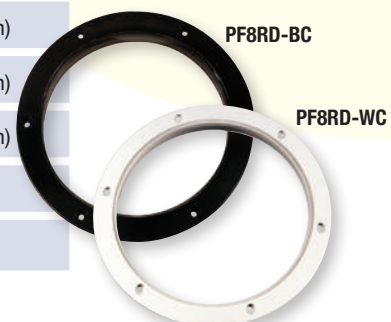

SOLD AS A SINGLE UNIT. NOT SUPPLIED WITH TRIM RING.

OPENING PORTS: SIX SIZES

To determine the size of the ports you need, use the chart below. The overall dimension is the trim ring or frame size. For measuring purposes, the spigot is the part of a port which passes through the cabin wall. Measure from the

outboard end of the frame back to the screen and add 1/4". The end of the spigot should be flush with the exterior surface of the trim ring, which will maximize the draining action of the frame.



PORT SIZE	INSIDE FRAME (HOLE CUT)	OUTSIDE FRAME	LENS OD	SCREEN OD
310	3-1/2" x 10-3/8" (8.9 cm x 26.4 cm)	5-1/2" x 12-3/8" (14.0 cm x 31.4 cm)	3-9/16" x 11" (9.0 cm x 28.0 cm)	2-5/16" x 10-1/4" (5.9 cm x 26.0 cm)
410	4-1/2" x 10-1/2" (11.4 cm x 26.7 cm)	5-1/2" x 12-3/8" (17.1 cm x 32.4 cm)	4-5/8" x 10-7/8" (10.2 cm x 27.6 cm)	4-3/16" x 10-7/16" (10.6 cm x 26.5 cm)
414	4-1/2" x 14-1/2" (11.4 cm x 36.8 cm)	6-3/4" x 16-3/4" (17.1 cm x 42.5 cm)	4-11/16" x 14-7/8" (11.9 cm x 37.8 cm)	4-3/16" x 14-7/16" (10.6 cm x 36.7 cm)
512	5-1/2" x 12-1/2" (14.0 cm x 31.8 cm)	7-3/4" x 14-5/8" (19.7 cm x 37.1 cm)	5-3/4" x 13" (14.6 cm x 33.0 cm)	5-1/4" x 12-1/2" (13.3 cm x 31.8 cm)
714	7-1/2" x 14-3/8" (19.0 cm x 36.5 cm)	9-3/4" x 16-3/4" (24.8 cm x 42.5 cm)	7-7/8" x 15-1/8" (20.0 cm x 38.4 cm)	7-5/16" x 14-7/16" (18.6 cm x 36.7 cm)
8RD	8-1/2" DIAMETER (21.6 cm)	10-3/4" DIAMETER (27.3 cm)	8-1/2" DIAMETER (21.6 cm)	8" DIAMETER (20.3 cm)

* **OD, OA:**
OVERALL DIMENSION
ID: INSIDE DIMENSION

* 714 opening ports have 4 cams, the smaller ports have two. The 8RD has three cams.



8RD (INTERIOR VIEW)

ORDERING CODE FOR OPENING AND FIXED PORTS

PORT	TYPE	SIZE	STYLE	BODY COLOR	LENS TINT	SPIGOT LENGTH
		3x10				10 = 1" (2.5 cm)
P	O (OPENING)	4x10	— (SELF DRAIN)	W (WHITE)	C (CLEAR)	20 = 2" (5.1 cm)
P	F (FIXED)	4x14	D (RAIN DRAIN)	B (BLACK)	S (SMOKE)	NOTE: 3 x 10 ports have a 1-1/2" (3.8 cm) spigot. Longer and shorter spigot lengths available. Please call us.
		5x12			B (BRONZE) (limited sizes)	
		7x14				
		8RD				

* MOST COMBINATIONS AVAILABLE: All Beckson Opening Ports include screens and exterior trim rings. Beckson Cam Latches are standard; twist knobs available. See page 31 for latches and knobs.

EXAMPLES:

PO410DBC-10 (OPENING PORT, 4" x 10", RAIN DRAIN, BLACK FRAME, CLEAR LENS, 1" SPIGOT)

PF714-WS-20 (FIXED PORT, 7" x 14", WHITE FRAME, SMOKED LENS, 2" SPIGOT)



newport™

PB525-WC (EXTERIOR VIEW)



PB525-WC (INTERIOR VIEW)



PB555-WS (EXTERIOR VIEW)



PB555-WS (INTERIOR VIEW)



MATCHING FIXED PORTS SERIES 500

500 Series Matching Fixed ports are available for most combination port models. These ports are generally constructed to be installed with the trim ring on the exterior of the vessel. Optional Thermopane and Reverse construction are available for air-conditioning or extreme environments; please contact Beckson before ordering.

PF525-BS (INTERIOR VIEW)

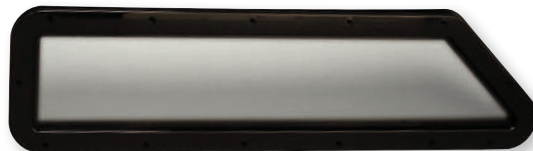

COMBINATION OPENING PORTS SERIES 500

Offering rugged, watertight marine construction along with dependable performance, the Newport Combination Port series incorporates Beckson's innovative features to make these versatile combination opening and fixed ports superior in providing maximum light and ventilation. These Newport combination ports incorporate Rain Drain windows. For component parts use 512 size.

PB525 SERIES 90/45° END ANGLES

SPIGOT DIMENSION HOLE SIZE	OUTSIDE FRAME OVERALL DIMENSION
TOP: 5-1/2" x 23" (14 cm x 58.4 cm)	TOP: 7-3/4" x 25-1/2" (19.7 cm x 64.1 cm)
BOTTOM: 5-1/2" x 27-1/2" (14 cm x 69.9 cm)	BOTTOM: 7-3/4" x 29-3/4" (19.7 cm x 75.6 cm)

PB555 SERIES 90/90° END ANGLES

SPIGOT DIMENSION HOLE SIZE	OUTSIDE FRAME OVERALL DIMENSION
TOP: 5-1/2" x 23-1/4" (14 cm x 59.7 cm)	TOP: 7-3/4" x 25-1/2" (19.7 cm x 64.8 cm)
BOTTOM: 5-1/2" x 23-1/4" (14 cm x 59.7 cm)	BOTTOM: 7-3/4" x 25-1/2" (19.7 cm x 64.8 cm)

* Note: All Newport Combination and Matching Fixed Ports are provided with 1" (25 mm) spigots. Maximum hull thickness: 3/4" (19 mm). Sold in pairs only. Please call us to inquire about the availability of color and size combinations.

ORDERING CODE FOR COMBINATION AND MATCHING FIXED PORTS

PORT	TYPE	MODEL#	ANGLES	BODY COLOR	LENS TINT
P	B (COMBINATION)	525	90/45°	W (WHITE)	C (CLEAR)
P	F (FIXED)	555	90/90°	B (BLACK)	S (SMOKE)

EXAMPLES:





PB525-BC (COMBINATION PORT, 90/45° ANGLES, BLACK FRAME, CLEAR LENS)

PB555-WS (FIXED PORT, 90/90° ANGLES, WHITE FRAME, SMOKED LENS)

SPECIALTY FIXED PORTS

Giving you the maximum amount of light for the interior spaces while adding handsome nautical detail to the exterior of your boat, Beckson Specialty Fixed Ports, manufactured with Beckson's innovative features, provide rugged watertight marine construction for superior performance. Will conform to a small degree of camber.

* These 100 series fixed ports are intended for exterior installation with the trim ring on the vessel interior.

	MODEL#	DESCRIPTION	DIMENSIONS		
PF100 OVAL SOLD AS SINGLE	PF100-SB	BLACK BODY SMOKED LENS	SPIGOT DIMENSION-HOLE SIZE 1-5/8" ENDS x 3-3/4" MIDDLE x 22" LENGTH (4.1 x 9.5 x 55.9 cm)		
			OUTSIDE FRAME- OVERALL DIMENSION 3-3/8" ENDS x 5-1/2" MIDDLE x 23-5/8" LENGTH (8.6 x 14 x 60 cm)		PF100-SB OVAL
PF122 TRAPEZOID SOLD AS PAIRS	PF122-WC	WHITE BODY CLEAR LENS	SPIGOT DIMENSION-HOLE SIZE 4" x 22-1/2" LENGTH (10.2 x 57.2 cm)		
	PF122-WS	WHITE BODY SMOKED LENS	OUTSIDE FRAME-OVERALL DIMENSION 5-1/2" x 24-1/2" LENGTH (14 x 62.2 cm)		PF122-WC TRAPEZOID
PF125 ANGLED ENDS PAIRED 90° AND 45° ANGLED ENDS SOLD AS PAIRS	PF125-BC	BLACK BODY CLEAR LENS	SPIGOT DIMENSION-HOLE SIZE 34" x 21-1/4" LENGTH (10.2 x 54 cm)		
	PF125-BS	BLACK BODY SMOKED LENS			OUTSIDE FRAME-OVERALL DIMENSION 5-1/2" x 23-1/4" LENGTH (14 x 59.1 cm)
	PF125-WC	WHITE BODY CLEAR LENS			CABIN WALL THICKNESS: 1/2" (13 mm) to 1-1/8" (28 mm)
	PF125-WS	WHITE BODY SMOKED LENS			
PF128 PARALLELOGRAM COMPLEMENTARY 135° AND 45° ANGLED ENDS SOLD AS PAIRS	PF128-BC	BLACK BODY CLEAR LENS	SPIGOT DIMENSION-HOLE SIZE 4" x 22-1/2" LENGTH (10.2 x 57.2 cm)		
	PF128-BS	BLACK BODY SMOKED LENS			OUTSIDE FRAME- OVERALL DIMENSION 5-1/2" x 24-1/2" LENGTH (14 x 62.2 cm)
	PF128-WC	WHITE BODY CLEAR LENS			CABIN WALL THICKNESS: 1/2" (13 mm) to 1-1/8" (28 mm)
	PF128-WS	WHITE BODY SMOKED LENS			
PF155 RECTANGLE MATCHING 90° ANGLED ENDS SOLD AS PAIRS	PF155-BC	BLACK BODY CLEAR LENS	SPIGOT DIMENSION-HOLE SIZE 4" x 20" LENGTH (10.2 x 54 cm)		
	PF155-BS	BLACK BODY SMOKED LENS			OUTSIDE FRAME- OVERALL DIMENSION 5-1/2" x 22" LENGTH (14 x 55.9 cm)
	PF155-WC	WHITE BODY CLEAR LENS			CABIN WALL THICKNESS: 1/2" (13 mm) to 1-1/8" (28 mm)
	PF155-WS	WHITE BODY SMOKED LENS			



WHAT YOU WANT TO KNOW ABOUT GASKETS FOR OPENING PORTS:

Most reports we receive about leaking windows have turned out to involve other manufacturers' ports. There are too many reasons why other ports leak to cover here; however, you are welcome to call Beckson for advice about solving your problems with non-Beckson ports. This article covers occurrences that are relevant to Beckson ports. On a Beckson port, the Beckson name or patent number is located between the hinges on the top face of the window frame.

Leaks in older ports can be caused by either a dirty gasket or deterioration of the caulking. The first step is to find exactly where the water is leaking. Signs of improper or deteriorating caulking are: the bottom front of the window frame is dry but the area below it is wet; a leak is occurring at the screw heads; or the window frame or the cabin "above" it is wet.

If the trail of a leak is not readily apparent, you can use the following logic as a short-cut in finding the cause without taking apart the cabin. A hull and deck are caulked together to form a water-tight assembly. Holes are then cut into this assembly for fittings and accessories. To find the source of a leak, look for these holes in the general area above the leak. For example, leaks in deck fittings can run down the inside of the hull or behind the liner and drip off the window frame leading one to conclude that the port must be leaking. Likewise, a window caulking leak which emerges at the bottom of the window frame will cause some to swear the window gasket has failed. Only when water is "visibly" leaking between the gasket and the lens is it not a caulking problem.

Over-tightened gaskets can cause compression set; effectively the gasket becomes a solid piece of rubber, losing most of its resiliency and ability to repel water. Wiping the gasket with a very light coating of petroleum jelly and leaving the port open for a few days will rejuvenate the gasket. Cam latches will help avoid that problem.

“ . . . 36 years . . . through many storms on the great lakes . . . the Beckson ports never leaked a single drop of water!!

Cliff and Sandy Steele, Kentucky, long-time Great Lakes boaters; authors of many thoughtful, entertaining informative articles about boating.

If you remove the gasket and screen from the window frame, remember to re-install the screen with the smooth side of the face toward you (so it will be against the gasket). The legs on the screen fit into the groove in the port frame. The gasket should be placed with the seam at the top of the window. Push the leg of the gasket into the groove at the two corners of one end and then slightly stretching it, do the two corners on the other end. Then press in the rest and you are finished. Make sure the gasket is placed correctly with the seam at the 12:00 position. All manufacturers use an extruded gasket which is bonded in a loop. Since the bond point could interfere with the seal, we place this at the top of the window. A person removing and re-installing the gasket may not have noticed this. The resulting leak will be a rare drip, but why have any at all?

Beckson Ports are not high maintenance! Many boat owners feel compelled to do some maintenance on the ports. Resist the urge! If you find yourself using an aerosol can of CRC or WD-40 or other lubricant, don't spray the hinges! If you are cleaning the galley with a spray cleaner, don't clean the lens. If you're annointing the boat with an aerosol insect spray, don't spray the screen or lens. A good rule of thumb is, if you won't put it on your face, don't put it on the window.

Summary

If a Beckson opening port has been performing fine and a leak suddenly appears, it is a deterioration of the caulking or a gasket problem. With only minimal care, you will be assured of satisfactory service and long life for your Beckson opening ports.

GASKETS FOR BECKSON OPENING PORTS

GASKETS MODEL#

GK-310

GK-410

GK-414

GK-512

GK-714

GK-8RD

The Gasket is an important part of an opening port. For years of leak-free ports, check out the helpful tips above. To order new gaskets, use Model# GK followed by the port size.



* NEW GASKETS

The gasket you take out of your port is rectangular like the gasket on the right. The round one we send you looks wrong, but actually, all gaskets start out round. It's a matter of feeding the leg of the gasket into the groove in the frame.

Ed Gillet already had about 30,000 miles of sailing and 10,000 miles of ocean kayaking experience when he left Monterrey, California in 1987 for a long-distance paddling voyage to Hawaii, a trip of 2400 miles across the Pacific. His very well-prepared 21-foot kayak included Beckson deck plates as part of the pontoon arrangement he created to keep the craft stable when he slept. After battling severe winds and crashing waves, he then had to deal with lack of wind, which slowed his journey considerably. It took 63 days instead of the 40 he'd estimated, putting a severe strain on his food supply and leading some to believe he was lost. However, he became the first, and still the only person to successfully kayak solo from California to Hawaii. Read about his remarkable journey, based on his logs and on interviews, in the 2018 book, *The Pacific Alone* by Dave Shively.



ANATOMY OF A BECKSON OPENING PORT

(EXTERIOR TRIM RING NOT SHOWN)

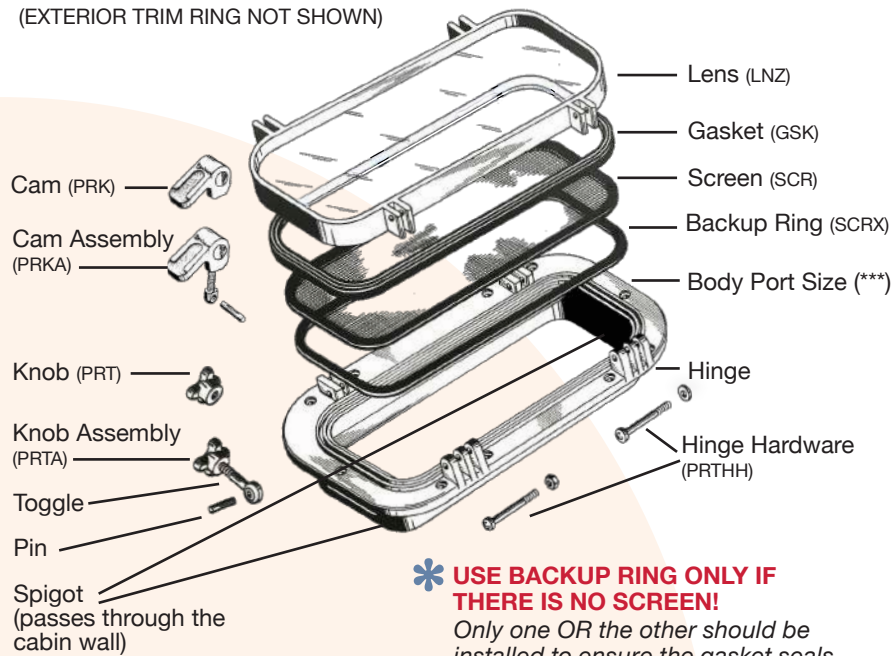

*** USE BACKUP RING ONLY IF THERE IS NO SCREEN!**

Only one OR the other should be installed to ensure the gasket seals properly. If you have both in, please discard the backup ring.

LENSES

In 1982 we changed the styling of the frame hinge, which required a change to the lens. We can still provide lenses for any year port. In the illustration below, the top lens hinge is manufactured after 1982. The outer posts measure 5/16" (.78 cm) and the center post measures 1/4" (.64 cm)

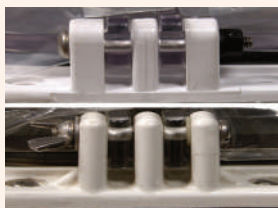

New-style hinge made after 1982

Hinge made before 1982

LNZ-512S (lens only, 5" x 12", smoke)



LNZ-8RDC (lens only, 8" round, clear)



To order lenses, order part number LNZ-*** and specify color. Lens colors are Clear or Smoked (green tint.) If the production date of your boat is pre-1982, order the Pre-82 lens. Each lens comes with two bolts and nuts.

ORDERING CODE FOR LENSES C (CLEAR) S (SMOKED)

LNZ-310C
LNZ-310S
LNZ-410C
LNZ-410S
LNZ-414C
LNZ-414CD (PRE-82 LENS)
LNZ-414S
LNZ-414SD (PRE-82 LENS)
LNZ-512C
LNZ-512CD (PRE-82 LENS)
LNZ-512S
LNZ-512SD (PRE-82 LENS)
LNZ-714C
LNZ-714CD (PRE-82 LENS)
LNZ-714S
LNZ-714SD (PRE-82 LENS)
LNZ-8RDC
LNZ-8RDS

SCREENS



SCREENS

SCR-310	SCR-512
SCR-410	SCR-714
SCR-414	SCR-8RD

TRIM RINGS

To order, specify trim rings by model and color. Available in white or black. All trim rings come undrilled.



ORDERING CODE FOR TRIM RINGS

MODEL#	PORT STYLE	COLOR
PTR-310B	SELF DRAIN	BLACK
PTR-310W	SELF DRAIN	WHITE
PTRD310B	RAIN DRAIN	BLACK
PTRD310W	RAIN DRAIN	WHITE
PTR-410B	SELF DRAIN	BLACK
PTR-410W	SELF DRAIN	WHITE
PTRD410B	RAIN DRAIN	BLACK
PTRD410W	RAIN DRAIN	WHITE
PTR-414B	SELF DRAIN	BLACK
PTR-414W	SELF DRAIN	WHITE
PTRD414B	RAIN DRAIN	BLACK
PTRD414W	RAIN DRAIN	WHITE
PTR-512B	SELF DRAIN	BLACK
PTR-512W	SELF DRAIN	WHITE
PTRD512B	RAIN DRAIN	BLACK
PTRD512W	RAIN DRAIN	WHITE
PTR-714B	SELF DRAIN	BLACK
PTR-714W	SELF DRAIN	WHITE
PTRD714B	RAIN DRAIN	BLACK
PTRD714W	RAIN DRAIN	WHITE
PTR-8RDB	SELF DRAIN	BLACK
PTR-8RDW	SELF DRAIN	WHITE

BECKSON PORT RAINSHIELDS

INTERNAL RAINSHIELD

Constant fresh air for your boat! Open louvers are designed for maximum ventilation. Heat repelling smoked lenses on Beckson's Internal Rain Shields allow windows to be left open and fresh air to circulate. Eliminates not only stagnant, unhealthy air, but also helps prevent mildew formation. No longer is opening a closed boat an overwhelming experience. These Rain Shields allow comfortable, healthy air flow during all warm weather conditions, including rain showers. Internal rain shields come with bug screen installed. Boat owners without Beckson ports can adapt Internal Rain Shields to some non-Beckson ports.

IRS-512S



IRS -512S



DOUBLE LOUVER MODEL#		SINGLE LOUVER MODEL#	
IRS-414S	4 x 14 OPENING PORTS	IRS-310S	3 x 10 OPENING PORTS
IRS-512S	5 x 12 OPENING PORTS	IRS-410S	4 x 10 OPENING PORTS
IRS-714S	7 x 14 OPENING PORTS		

EASY TO INSTALL. JUST REMOVE SCREEN AND INSERT INTERNAL RAINSHIELD.

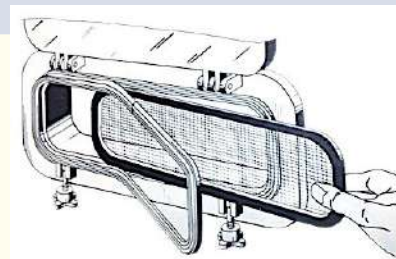

RS-10

RS-10 INSTALLED



EXTERNAL RAINSHIELD/SHADE HOOD

This practical port accessory provides shade as well as keeping out rain and spray. It may be fastened with screws or by bonding to the exterior trim ring of opening ports. Projection from mounting surface on all sizes is 2-1/2" (6.3 cm). Vertical dimension of hood overall is 3" (7.6 cm).

MODEL#	PORT SIZE	DIMENSIONS (OVERALL : UNDER HOOD)
RS-10	3 x 10 and 4 x 10	12-3/8" : 10-1/4" (31.4 : 26.0 cm)
RS-14	4 x 14 and 7 x 14	16-3/4" : 14-1/2" (42.5 : 36.8 cm)
RS-12	5 x 12	14-5/8" : 12-3/4" (37.1 : 32.4 cm)
RS-18	8 x 18	20-1/8" : 18" (51.1 : 45.7 cm)

BECKSON PORT HOLDERS

Safety-soft rubber holders to be fastened on the overhead or cabin wall. When installed, the fork on the lens passes over the bell of the port holder which holds the lens in an open position.



MODEL#	COLOR
PC-A	WHITE
PC-B	BLACK

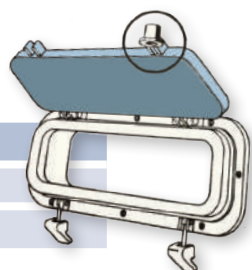

STAINLESS STEEL CHAINS

Time tested traditional method to secure a Beckson open port lens. Chains may be easily reduced in length.

MODEL#	LENGTH
PC-3	3"
PC-9	9"

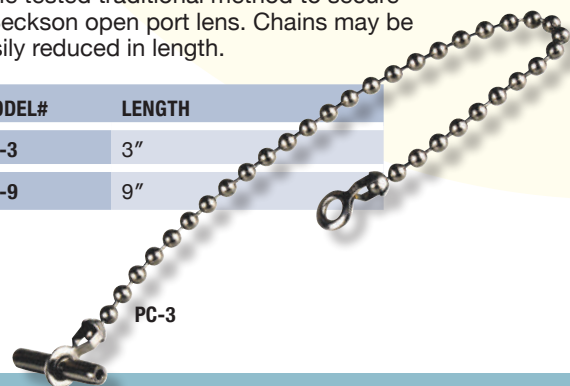

FAST CAM LATCHES

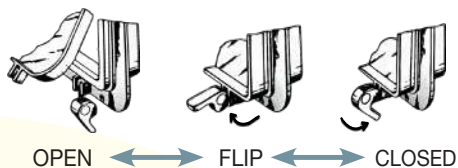

When you're in a hurry to get all those ports closed tight before the cloudburst hits, you'll be so happy you replaced all your old port knobs with quick-closing **CAM LATCHES!**

Invented by Beckson, and stronger and easier to use than knobs or levers, Cam Latches make it simple to open and close ports with just a quick flip. They are self-lubricating, non-fouling, anti-vibrational, positive closures that adjust in increments of 90 degrees and eliminate overtightening.

Cam latches are available to retrofit your older Beckson Ports and will fit many other manufacturers' opening ports. Detailed instructions come with the cams and you can also find more information about how to do it on the **Cam Latch Retrofit information sheet.**

Port spigots can be cut or extended to the proper depth by special order. Contact us for assistance. We do not represent or guarantee that the Cam Latches will fit all opening ports, however all Beckson ports can be retrofitted with Beckson cam latches. Cam Latches and Knobs for Beckson Opening ports are available with or without stainless hardware. Packed in pairs. Use Model# to order.

SAFETY TWIST KNOBS AND ASSEMBLIES



We still make them, just for the traditionalist. Beckson Twist Knobs utilize a stainless steel hex nut molded in place. This design eliminates "free-spinning." The hex nut accepts bolts 1/4" in diameter with 20 threads per inch. Not just for ports, of course. Replace broken or missing knobs on roof racks for skis, barbecues, Bimini tops, or for any application. Twist Knob assemblies include port frame pins and 1/4-20 toggles. Sold in pairs. Use Model# to order.

TWIST BOLTS

Beckson twist bolts are available with a threaded stud molded in place. The stainless steel stud extends 1/2" (13 mm) from the knob base. Generously sized knobs and durable materials provide easy, trouble-free service. Replace broken and missing knobs. Use Model# to order.

HARDWARE

PORT LENS HINGE HARDWARE
MODEL# PRTHH
Sold in pairs.



TWIST KNOB OR CAM ASSEMBLY HARDWARE ONLY
MODEL# PRTAH, PRKAH
Sold in pairs.



CAM LATCH ASSEMBLY

MODEL#	COLOR	DESCRIPTION
PRKAB	BLACK	COMPLETE ASSEMBLY, PAIR
PRKAW	WHITE	COMPLETE ASSEMBLY, PAIR

PRKAB



Includes port frame pins and 1/4-20 toggles

CAMS ONLY: FIT 1/4-20 TOGGLES

MODEL #	COLOR	DESCRIPTION
PRK-B	BLACK	CAM LATCH ONLY, PAIR
PRK-W	WHITE	CAM LATCH ONLY, PAIR

PRK-W



RETRO-FIT non-Beckson ports with Beckson Cams

MODEL#	COLOR	DESCRIPTION
PRK-B312	BLACK	CAM LATCH ONLY, PAIR
PRK-W312	WHITE	CAM LATCH ONLY, PAIR

Tapped to fit other manufacturers' 5/16-18 toggles

SAFETY TWIST KNOB ASSEMBLY

MODEL#	COLOR	DESCRIPTION
PRTAB	BLACK	COMPLETE ASSEMBLY, PAIR
PRTAW	WHITE	COMPLETE ASSEMBLY, PAIR

PRTAB

Includes port frame pins and 1/4-20 toggles



SAFETY TWIST KNOBS ONLY

MODEL#	COLOR	DESCRIPTION
PRT-B	BLACK	WITH 1/4-20 S/S HEX NUT, PAIR
PRT-W	WHITE	WITH 1/4-20 S/S HEX NUT, PAIR

PRT-B



TWIST BOLTS

MODEL#	COLOR	DESCRIPTION
PRT-2B	BLACK	TWIST BOLT 1/4-20 x 1/2"
PRT-CB	BLACK	TWIST BOLT 5/16-18 x 1/2"

PRT-2B

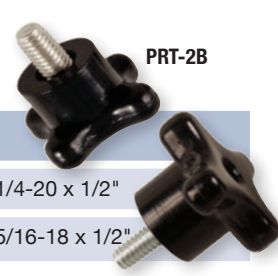

STOWAWAY HATCH

Providing ventilation where space may be limited, this versatile hatch can also serve as a glove compartment, a cover for engine controls, fire extinguishers, and other storage uses which have a vertical application. Incorporated into the design are features to make your boating life easier and more enjoyable:

- "Complete Swing" hinges let the cover open a full 180 degrees!
- Rugged "SLIP-CLIP" snubbing latch holds the cover firmly closed.
- Low profile frame and cover reduce bulkhead clutter and clothing snags.
- Open center cover handle provides an easy grip for opening and closing.
- Frame is designed to reduce distortion during installation for tight closure.
- Can be fitted with a lock supplied with two keys.



PH714MWC-20

Standard hatch spigot depth is 2" (5.1 cm); can be cut for thinner walls.

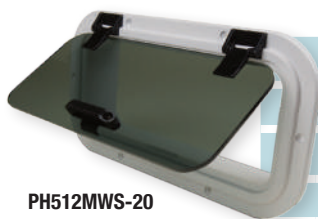

PH512MWS-20

MODEL#	COLOR	HOLE CUT	OD
PH410MBS-20	BLACK BODY, SMOKED COVER	4-1/2" x 10-1/2" (11.4 cm x 26.7 cm)	6-3/4" x 12-3/4" (17.1 cm x 32.4 cm)
PH410MWC-20	WHITE BODY, CLEAR COVER		
PH414MBS-20	BLACK BODY, SMOKED COVER	4-1/2" x 14-1/2" (11.4 cm x 36.8 cm)	6-3/4" x 16-3/4" (17.1 cm x 42.5 cm)
PH414MWC-20	WHITE BODY, CLEAR COVER		
PH512MBS-20	BLACK BODY, SMOKED COVER	5-1/2" x 12-1/2" (14.0 cm x 31.8 cm)	7-3/4" x 14-5/8" (19.7 cm x 37.1 cm)
PH512MWC-20	WHITE BODY, CLEAR COVER		
PH714MBS-20	BLACK BODY, SMOKED COVER	7-1/2" x 14-1/2" (19.0 cm x 36.8 cm)	9-3/4" x 16-3/4" (24.8 cm x 42.5 cm)
PH714MWC-20	WHITE BODY, CLEAR COVER		

White and black covers also available.
ADD SUFFIX "L" TO MODEL# FOR LOCK.

OD: OVERALL DIMENSION

SMALL VENTILATION HATCH



VHWS-3

This Ventilation Hatch can provide ventilation where space may be limited. It's ideal for installation in the galley, main cabin, aft cabin, or head. Constructed of high impact materials, U.V. and ozone inhibited. Of special note is the polycarbonate cover. This hatch should only be installed on a flat surface using a silicone caulk. Maintain a level profile while installing to ensure proper gasket alignment. If fastening on deck crown, construct level frame base or allow caulking to fill in void area. Fasten into place using #10 round head or pan head fasteners. Hatch is provided with a 2" spigot and trim frame.

MODEL#	COLOR	HOLE CUT	OD
VHBS-3	BLACK BODY / SMOKE GREY COVER	7-3/8" x 14-3/8" (18.7 cm x 36.5 cm)	9-3/4" x 16-3/4" (24.8 cm x 42.5 cm)
VHWS-3	WHITE BODY / SMOKE GREY COVER		

HIGH QUALITY HATCHES = COMFORT AND CONVENIENCE!

- **LOW PROFILE HATCHES 1/2" HIGH WHEN CLOSED**
- **OPEN A FULL 180 DEGREES**
- **NOTHING TO SNAG LINES**
- **ONE HAND OPERATION**
- **MOUNT VERTICALLY OR HORIZONTALLY**
- **UV STABILIZED MATERIAL**
- **INVISIBLE FASTENERS**
- **TEXTURED NON-SKID SURFACE**
- **HANDLES AND LOCKABLE LATCHES ARE AVAILABLE.**

*HT Series Hatches
are made in Italy and
distributed by Beckson*



THE POPULAR HT1424-W HATCH WITH LOW PROFILE EASY-GRIP LATCHES

- BECKSON HATCHES:**
- STOWAWAY HATCH**
- LOW PROFILE HATCHES**
- RAISED FULL SIZE HATCHES**
- RAISED HATCHES FOR SMALLER SPACES**
- SMALL VENTILATION HATCH**

INSTALLING LOW PROFILE HATCHES

HT SERIES HATCHES

FLUSH HATCH INSTALLATION RECOMMENDATIONS:

Please read the following recommendations for the installer thoroughly and carefully before starting. Beckson will not be held responsible for installer error. For special installations, seek additional information and/or professional help.

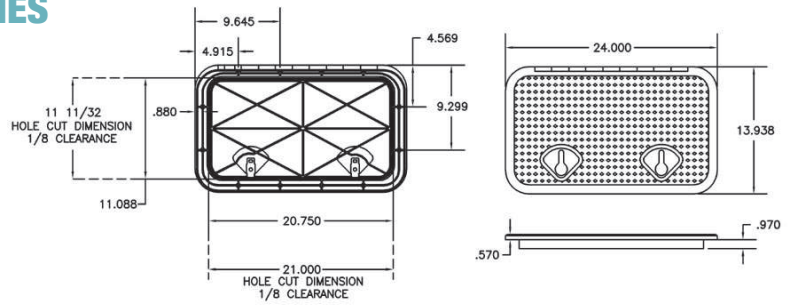

HT1424

LOCATION:

Determine the location for your hatch and check for adequate room for operation. Be sure to check the area below or behind where the hatch is to be installed for possible conflicts.

TOOLS:

Pencil, utility knife, single edged razor blade, saber saw, drill, 3/8" drill bit (to start saw cut), small drill for pilot holes, rough file, silicone sealant, and #10 fasteners. Hatch may be installed with counter-sunk #10 screws or bolts. Your choice will determine the drill size required for the fastener holes. Determine the proper length of the fasteners by adding 1/4" (screws) or 1/2" (bolts) to the deck or wall thickness.

CUTOUT:

Template - Remove the hatch cover by opening the hatch 180 degrees and applying pressure on the hatch cover in the fully open position. The cover should pop off the connecting hinges. Be careful not to twist the cover during removal, which could result in breaking the hinges. Once the cover is removed, place the mounting ring in the installation location and scribe inside the hatch to initiate the main hole cut template. Remove the hatch and scribe an outer line 1/4" outside the first. **Verify again that there are no conflicts to the installation area such as electrical wire, structural supports, etc.** Drill a pilot hole between the two lines and then open the hole with the 3/8" drill. Insert your saber saw and make your hole cut by "taking out" the outside line with the saw. Check the cutout with the hatch itself for proper fit. The cutout needs to allow room for sealant around the hatch to provide a proper sealing area and also act as a flexible gasket for changes in temperature.

DRILLING FASTENER HOLES:

Center the mounting ring in the cutout and drill pilot holes for the fasteners. Remove the mounting ring and reattach the cover by snapping back into place. Next, open the fastener holes with the appropriate drill bit for the fasteners that you have chosen.

TIP FOR EASY CLEANUP:

Set the hatch in place without sealant or fasteners. Use a damp sponge with a small amount of liquid soap, wrung dry, and apply around the hatch where excess sealant may squeeze out during installation.

SEALANT: BECKSON RECOMMENDS USING ONLY SILICONE SEALANT. Liberally apply sealant on the underside of the mounting ring and around the outside of the spigot (the flange through the mounting hole) and around the fastener holes. Put the hatch in place and align with drilled fastener holes. Fasten the hatch. Tighten until there are one to two turns left, then stop. Do not remove excess sealant at this time. Allow sealant to set. See recommended curing time per the manufacturer's instructions. After sealant has cured, turn fasteners one last turn. Do not overtighten.

CLEANUP: Carefully trim excess sealant that may have squeezed out during installation with a single edged razor blade. Perform final cleanup with a wet sponge. Close hatch and latch. Thank you and congratulations on your purchase and successful installation of your new hatch!

Please contact Beckson for additional drawings.

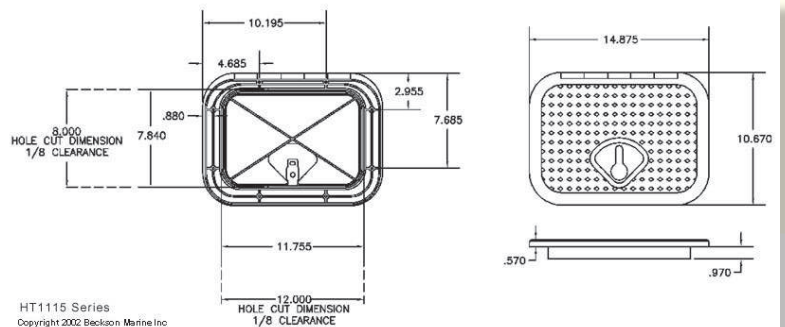

HT1115 Series
Copyright 2002 Beckson Marine Inc

HT1115

LOW PROFILE HATCHES



HT1424



LOW PROFILE HATCHES

MODEL
HT1424-W
HT1424-B

OD: 14" x 24" (35.5 cm x 60.9 cm)
ID: 10-1/2" x 20-3/8" (26.7 cm x 51.7 cm)
Hole Cut: 11-1/8" x 20-7/8" (28.3 cm x 53.0 cm)
Color: White, Black



HT1515



MODEL
HT1515

OD: 14-5/8" x 14-3/4" (37.1 cm x 37.5 cm)
ID: 11-1/8" x 11-1/4" (28.3 cm x 28.6 cm)
Hole Cut: 11-3/4" x 11-3/4" (29.8 cm x 29.8 cm)
Color: White

MODEL
HT1821

OD: 18-1/2" x 20-1/8" (47.0 cm x 51.1 cm)
ID: 14-5/8" x 17" (37.1 cm x 43.2 cm)
Hole Cut: 15-3/8" x 17-3/8" (39.0 cm x 44.1 cm)
Color: White



HT1821



MODEL
HT1115-W
HT1115-B

OD: 10-3/4" x 14-3/4" (27.3 cm x 37.5 cm)
ID: 7-1/4" x 11-1/4" (18.4 cm x 28.6 cm)
Hole Cut: 7-7/8" x 11-3/4" (20.0 cm x 29.8 cm)
Color: White, Black

MODEL
HT1024

OD: 9-1/2" x 23-7/8" (24.1 cm x 60.6 cm)
ID: 6" x 20-1/2" (15.2 cm x 52.0 cm)
Hole Cut: 6-3/4" x 20-7/8" (17.1 cm x 53.0 cm)
Color: White

* **OD:** OVERALL DIMENSION
ID: INSIDE DIMENSION



HT1115



HT1024



HT Series Hatches
are made in Italy and
distributed by Beckson

RAISED HATCHES FOR SMALLER SPACES

This access hatch offers many boat owners and builders the versatility they have not previously been able to enjoy. While providing generous passage, its compact size makes it ideal for nearly every decked boat afloat. Sturdy stainless steel adjustable tension riser, hinges, and tie downs complete the hatch, which you receive fully assembled.



HS-1 (OPEN)



HS-2 (EXTERIOR CLOSURE)



HS-2 (OPEN)



HS-1 (INTERIOR CLOSURE)

MODEL#	COLOR	LATCHES	HOLE CUT	OUTSIDE FRAME
HS-1	WHITE	1	12-1/2" x 16-1/2" (32 cm x 42 cm)	18" x 22" (46 cm x 57 cm)
HS-2	WHITE	2	12-1/2" x 16-1/2" (32 cm x 42 cm)	18" x 22" (46 cm x 57 cm)

*** Installation:** Apply silicone caulking under flange. Fasten flange to deck. **NOTE:** Use pan head or round head fasteners only. Hatches may be painted with an acrylic-base paint to match color.

WHEN Curtis and Kathleen Saville decided to row across the Atlantic Ocean, they carefully planned and built their 25-foot boat, **Excalibur**, themselves. They chose Beckson for the all-important deck plates, cabin hatches, ports, ventilators, diaphragm pumps, mounting clips, hose, bilge pumps, couplings, strainers, and boat hooks. In July 1981, the couple became the first Americans to row across the Atlantic Ocean, and Kathleen, the first woman to row across the North Atlantic. But they didn't stop there. In midsummer 1984, after several other rows, including one to Labrador and a 2400-mile journey down the Mississippi River, they embarked in their five year old boat on a cross-Pacific row, from Peru to Cairns, Australia—a voyage of 10,000 miles. It took them a little over a year. Kathleen Saville became the first woman to row across two oceans, which earned her another spot in the Guinness Book of World Records.



Throughout the thousands of nautical miles they rowed and the unimaginably ferocious storms they encountered on the open ocean during that time, the Beckson equipment proved reliable and durable. It stood up to the worst that punishing storms, blistering sun, and salt water could inflict and helped bring the Savilles safely ashore. As a matter of fact, after their aluminum mast corroded away and sunlight destroyed the carbon fiber paddles they'd substituted, the Beckson boat hook was set in place to do the job. And at the end of their incredible voyage when they landed in Cairns, someone asked where they'd gotten the new boathook!

Rowing for My Life: Two Oceans, Two Lives, One Journey, Kathleen Saville's riveting and affecting memoir of their courageous ocean rowing voyages, imbued with her own personal journey, was published in 2017 by Arcade Publishing, New York, N.Y.

You can find the boat hooks on page 47.



Photo courtesy Kathleen Saville © 2017

RAISED FULL SIZE HATCHES

Designed for new installations or for changing from other manufacturers' hatches, these are completely assembled and watertight. The hatch cover fits into a specially designed groove to stop water from blowing in during heavy weather and rain. There is a closed cell vinyl gasket on the cover to further ensure watertightness. Two designs: Camber, with a deck flange designed to fit the slight curve of the deck, and Flat, for level decks. White ABS coated with Korad® film for superior color retention and UV protection.

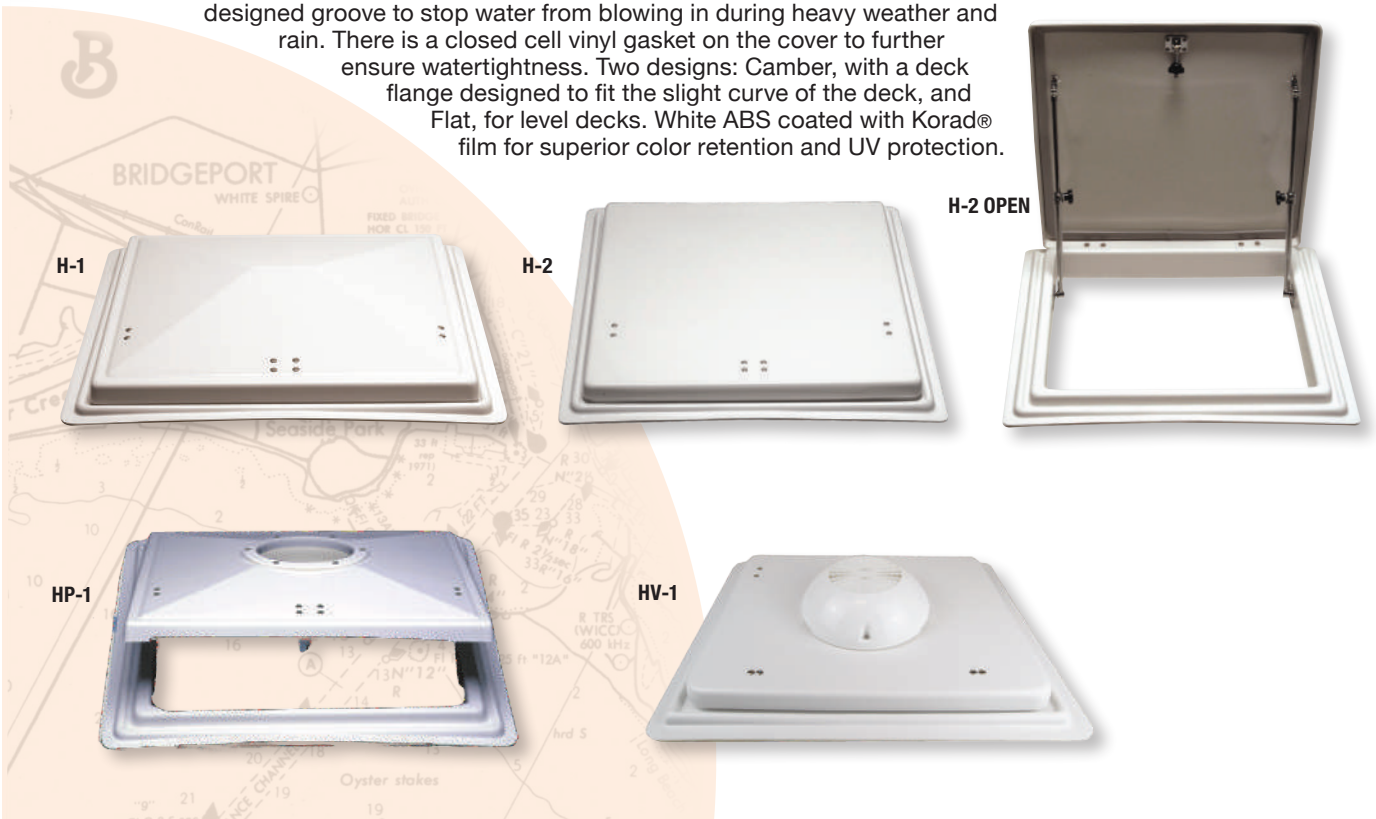

DIMENSIONS: HOLE CUT FOR ALL: 20" x 20" (51 X 51 cm) OVERALL DIMENSION: 25" x 25" (64 x 64 cm)

MODEL#	THRU-DECK	DESCRIPTION	MODEL#	THRU-DECK
H-1	CAMBER	SOLID ABS RISES TO 3" CROWN	HF-1	FLAT
HP-1	CAMBER	SAME AS H-1, WITH CLEAR DECK PLATE INSTALLED	HPF-1	FLAT
HV-1	CAMBER	SAME AS H-1, WITH VENT-O-MATE® INSTALLED	HVF-1	FLAT
H-2	CAMBER	SOLID WHITE ABS WITH FLAT COVER, 1-1/2" HIGH	HF-2	FLAT
HP-2	CAMBER	SAME AS H-2, WITH CLEAR DECK PLATE INSTALLED	HPF-2	FLAT
HV-2	CAMBER	SAME AS H-2, WITH VENT-O-MATE® INSTALLED	HVF-2	FLAT

HATCH HARDWARE

TIE DOWN
Model# TDS-1

Stainless Steel Twist Knob pivots to adjust and fold back 90° for flush fit. Length in closed position is 2" (5.1 cm)





YOU AND YOUR BOAT CAN BREATHE EASY . . .

Wherever you keep your boat, wherever you go boating, your vessel needs ventilation—a boat doesn't "breathe" on its own. Without ventilation, your boat is susceptible to moisture buildup and the accompanying problems that mold and mildew bring along. Unpleasant smells, health issues and permanent damage to your boat's electrical parts and metal, wood, fabric and even plastic can all result from lack of ventilation. Merely closing up your boat may make it worse!

Beckson makes several different styles of vents for you to choose from: clam shell vents, cowl vents, scoop vents and exhaust vents that keep air moving. Our drain vents (**SV-1B and SV-4B**) can serve as floor drains or for ventilation of small interior spaces aboard.

Vacuum-formed white ABS air scoops have white KORAD® caps to prevent cracking or discoloring. Injection molded models **C-7** and **C-8** snap on and off an included deck mounted adapter and are also available in black. All of these vents can be spray painted with acrylic paint to match gel coat.

Vent-O-Mate® is also ideal for adding ventilation to heads, galleys, and forepeaks to help prevent mildew damage to interior wood and cabinetry.

Install over anchor locker to dry wet line and keep musty odors from below. A clear shield on top permits light to enter and the vent can be closed from the inside during chilly weather to retain cabin heat.

- Draft free
- Water tight
- Allows light below
- No obstruction below deck

For high traffic areas we recommend our Beckson Soft-Mate® Soft Cowl model **SC-7** to protect bare feet.

Beckson also manufactures a vent-top deck plate. See page 18.

KORAD® is a registered trademark of Polymer Extruded Products.

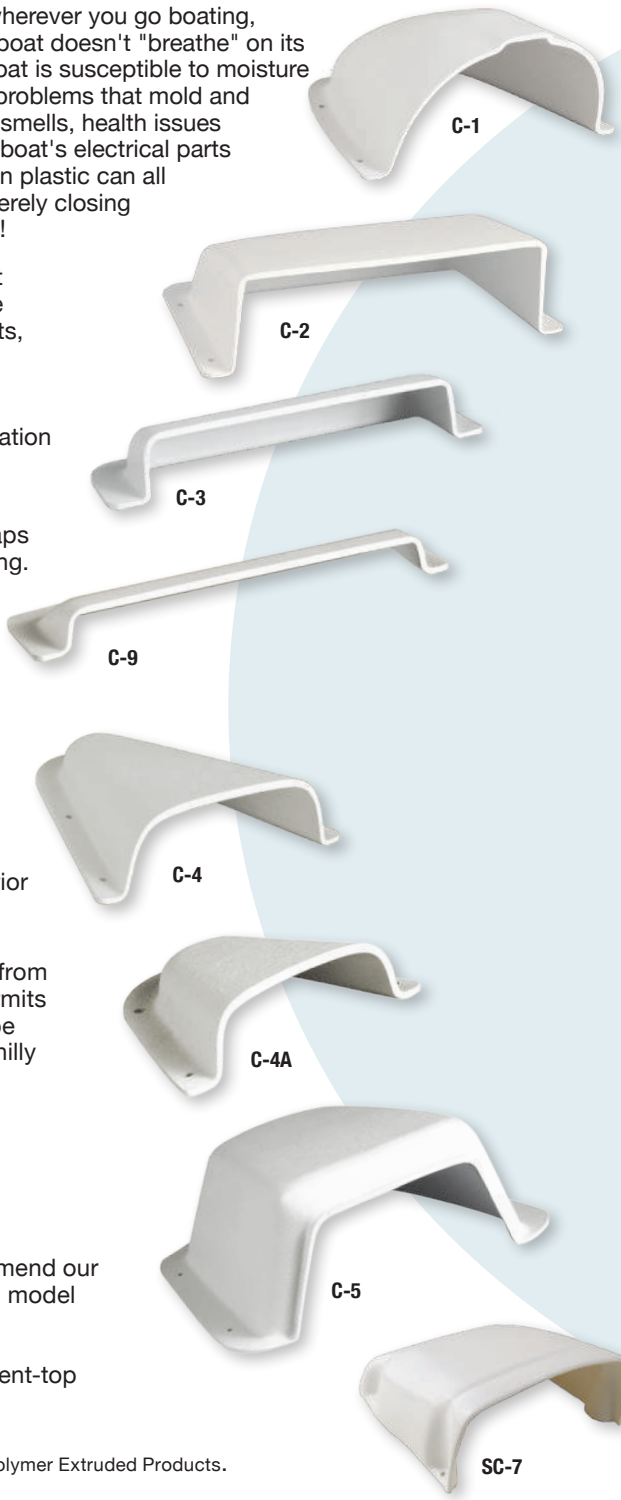

C-1 COWL VENT
Width: 6-1/4" (15.9 cm) Depth: 7" (17.8 cm) Height: 3" (7.6 cm) Adapters and Hose Size: (A-3/VT-3) (A-4/VT-4) (SA-3/VT-3)
C-2 SCOOP VENT
Width: 8" (20.3 cm) Depth: 5-1/2" (14.0 cm) Height: 2-1/4" (5.7 cm) Adapters and Hose Size: (A-3/VT-3) (A-4/VT-4) (SA-3/VT-3)
C-3 MINI LOCKER VENT
Width: 7-1/8" (18.1 cm) Depth: 2-3/8" (6.0 cm) Height: 1-1/4" (3.1 cm)
C-9 LOCKER VENT
Width: 8-3/4" (20.3 cm) Depth: 2-1/4" (5.7 cm) Height: 1" (2.5 cm)
C-4 CLAM SHELL VENT
Longer version of a C-4A Width: 5-3/4" (14.6 cm) Depth: 7-1/4" (18.4 cm) Height: 1-1/2" (3.8 cm) Adapters: (A-3/VT-3)
C-4A MINI CLAM SHELL VENT
Smaller version of a C-4 Width: 4-1/4" (10.8 cm) Depth: 4-1/8" (10.5 cm) Height: 1-1/2" (3.8 cm)
C-5 SUPER COWL VENT
Width: 8" (20.3 cm) Depth: 10-1/2" (26.7 cm) Height: 3-1/4" (8.3 cm) Adapters and Hose Size: (A-3/VT-3) (A-4/VT-4) (SA-3/VT-3)
SC-7 SOFT COWL VENT
Width: 4-7/8" (12.4 cm) Depth: 5-1/8" (13.0 cm) Height: 2" (5.8 cm) Adapters and Hose Size: (A-3/VT-3) (A-4/VT-4) (SA-3/VT-3)

**WIND POWER!**

**VENTILATE YOUR BOAT
EVERY HOUR, EVERY DAY
YEAR AFTER YEAR,
NO NEED TO WAIT
ANOTHER MINUTE!**



C-6SS EXHAUST VENT WITH STAINLESS COVER

**BETTER VENTILATION
NON-STOP - YEAR AFTER YEAR**

Powered by just a slight breeze, the **Vent-O-Mate®** ventilator automatically exhausts stale, hot and moisture-laden damp air from inside a closed boat to help eliminate mildew and keep odors from accumulating. No need to wonder why your solar powered vent is not working. Wind moving over the open grill on top creates a partial vacuum that literally sucks air out of the boat and removes 350 cu. ft. of air per hour with a breeze of only 6 mph. That's enough to completely change the air in a 30' sailboat in about an hour!

**VENTILATORS
VENT HOSE ADAPTERS
SOFT COWL VENT
BILGE VENTILATION HOSE
DRAIN VENTS**



VENT HOSE ADAPTORS !

MODEL# A-3 AND A-4

A-3, A-4

SLIDE ON VENT HOSE ADAPTORS

For attaching ventilation hose to deck.

A-3 for use with VT-3 (3")

A-4 for use with VT-4 (4")

SA-3, SA-4

SCREW ON VENT HOSE ADAPTORS

For attaching ventilation hose to deck.

SA-3 for use with VT-3 (3")

SA-4 for use with VT-4 (4")

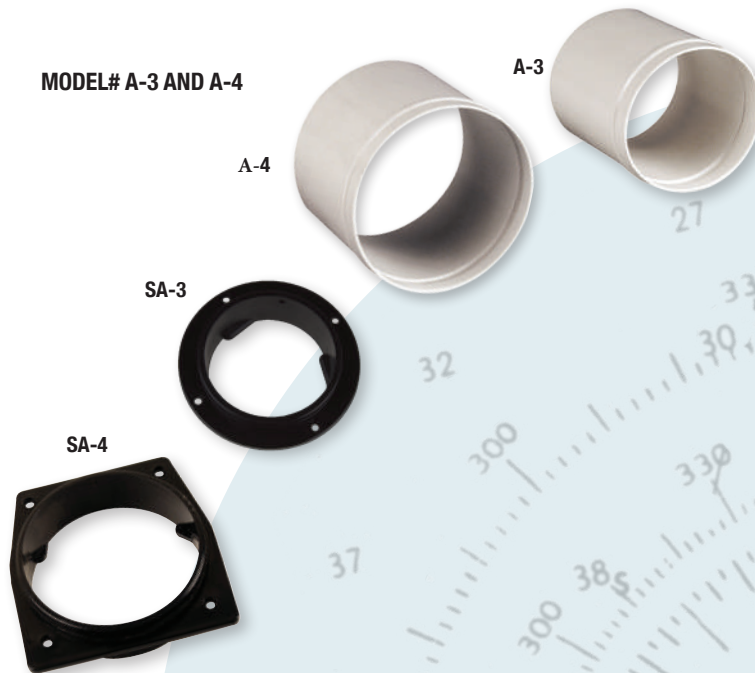

BILGE VENTILATION HOSE (VT-3 AND VT-4)

Designed for venting bilge gases. Wire reinforced vinyl hose that is light and easy to bend. For use with all vents. White. Packaged in 50' lengths.

MODEL#	DIAMETER
VT-3	3" (7.6 cm)
VT-4	4" (10.2 cm)

DRAIN VENTS

SV-1B SCUPPER/DRAIN VENT

Small vent for deck or bulkhead mount.

Raised fins reduce clogging when used as a scupper. Perfect for venting areas under fixed seating too.

Color: Black, White

PLEASE CALL FOR MORE INFORMATION ABOUT OTHER COLORS.

Hole Cut Diameter: 2-1/4" (5.7 cm)

OA: 4"x 2.5" (10.1 cm x 6.4 cm)

SV-4B SCUPPER/DRAIN VENT

Flush vent design may be used as a floor drain or for ventilation of a speaker enclosure or locker.

Color: Black

Hole Cut Diameter: 4" (10.2 cm)

OD: 5-1/2" (14.0 cm).

SV-1B DRAIN VENT



SV-1W DRAIN VENT



SV-4B DRAIN VENT





UNSURPASSED CABIN EXHAUST VENTILATOR!

C-6SS VENT-O-MATE® VENTILATOR WITH STAINLESS STEEL COVER.

Do away with dampness, mildew, and condensation. VENT-O-MATE® is ideal for adding ventilation to heads, galleys, and forepeaks to help prevent mildew damage to interior wood and cabinetry. Install over anchor locker to dry wet line and help prevent unpleasant and unhealthy odors from below. A clear shield on top permits light to enter. During chilly weather, the vent can be closed from the inside to retain cabin heat.

Not for engine room ventilation.

See safety information page 50.

- Draft free • Water tight • Allows light below
- No obstruction below deck

*** We suggest C-6SS in heavy traffic areas or exceptionally hot environments.**

Under the cover



C-6SS



C-6

C-6 WHITE VENT-O-MATE® WITH PLASTIC COVER

Dimensions:

OA Diameter: 7-3/4" (19.7 cm)

Height: 2-1/4" (5.7 cm)

Hole Cut Diameter: 4" (10.2 cm)

COMPONENTS available separately.

INSTALLATION: Illustrated, detailed instructions are included with consumer products and also available on our website.

C-6 Series vents made in Taiwan

NEW!

SAFETY REMINDER PLAQUE



P-201 Affix this safety reminder near the ignition on your boat. NOTICE Before Starting Engine Operate Blower 5 Min. Black text on yellow background. Non-corrosive molded plastic with adhesive backing and mounting holes. 3-1/4" x 1" (8.3 x 2.5 cm).

HARD CLAMSHELL VENTS

C-7 and C-8 are hard clamshell style vents that snap onto a hose adapter for 3" (**C-7**) or 4" (**C-8**) ventilation hose.

Hose available on page 40. Hose Adapters (**SA-3, SA-4**) are also available separately. See page 40. Model C-8 is available with an installed bug screen. Order Model# **C-8-S**



C-8

C-8 Snap On Clam Vent Open Base
C-8-S Snap On Clam Vent Screen Base
Width: 5-1/2" (14.0 cm)
Depth: 6-1/4" (15.9 cm)
Height: 2-1/2" (6.4 cm)
Adapters: Includes 4" (10.2 cm) hose adapter for use with VT-4

NEW!

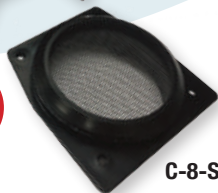

C-8-S



C-7B

C-7 White **C-7B** Black
Width: 5-1/2" (14.0 cm)
Depth: 6-1/4" (15.9 cm)
Height: 2-1/2" (6.4 cm)
Adapters: Includes 3" (7.6 cm) hose adapter for use with VT-3



soft-mate™

SAFETY-SOFT HOLDERS

- Flexible, designed not to hurt you or mar your equipment
- Convenient sizes for stashing a variety of gear
- For boat, home, RV, anywhere
- Think of all the places you could use them!

We get great comments from customers about our radio holders. Users call them "indestructible," and say, "great product and great price." They accommodate the smaller hand held GPS units, radios, and cell phones and are handy for holding many other small items, too.

The full size RADIO HOLDER (HH-8) is the ideal size for large hand held radios (CB and 2 meter), GPS units, and scanners which need an easily accessible but safe resting place when not in use.

Besides radios, the SOFT-MATE MINI RADIO HOLDER (HH-81) is also good for storing eyeglass cases, pens, pencils, or calculators. The unit is designed for both boats and land vehicles. You'll also find plenty of places around the house where it would be useful.

For Safety-Soft holders in other colors or sizes, please contact us.



RADIO HOLDER BLACK HH-8B

RADIO HOLDER WHITE HH-8

MULTIPURPOSE MINI-HOLDER HH-81

FILET KNIFE HOLDER HH-1
Convenient and protective housing for a filet knife. Screw or suction cup mount. Two screws included.

WINCH HANDLE HOLDER HH-2
For medium winch handles: top action, standard, or ratchet.

WINCH HANDLE HOLDER HH-3
For large winch handles: top action, standard, or ratchet.

** Do you sail?
Beckson's innovative—and often copied—SOFT-MATE WINCH HANDLE HOLDERS were designed using downward slanting angles to keep lines from getting caught, allowing them to slide off. There are lots of look-alikes, but we did the math—and these are Beckson quality!*

MODEL #	DESCRIPTION	HEIGHT	WIDTH	DIAMETER	COLOR	MOUNT
HH-1	FILET KNIFE HOLDER	10" (25.0 cm)	1-1/16" (4.1 cm)	1-1/8" (2.8 cm)	WHITE	SC
HH-2	WINCH HANDLE HOLDER	8-1/2" (21 cm)	3" (7.6 cm)	2" (5.1 cm)	WHITE	
HH-3	WINCH HANDLE HOLDER	11" (28 cm)	3-1/2" (8.9 cm)	2-1/8" (5.4 cm)	WHITE	
HH-6	DRINK/AIR HORN HOLDER	4-1/2" (8.9 cm)	3" (10.1 cm)	2-3/4" (7.0 cm)	WHITE OR BLACK	SC
HH-61	DRINK /AIRHORN HOLDER	5" (12.7 cm)	3" (7.6 cm)	3-1/2" (8.9 cm)	WHITE OR BLACK	SC
PLEASE CONTACT US IF YOU NEED OTHER COLORS OR SIZES						
MODEL	DESCRIPTION	HEIGHT	WIDTH	DEPTH	COLOR	
HH-4	BINOCULAR HOLDER	8-1/4" (21 cm)	8-3/4" (22.2 cm)	2-3/4" (7.0 cm)	WHITE	
HH-8	RADIO HOLDER	6" (15.2 cm)	3" (7.6 cm)	2" (5.1 cm)	WHITE OR BLACK	SC
HH-81	MINI RADIO HOLDER	4-3/4" (12.1 cm)	2-3/4" (7 cm)	2" (5.1 cm)	WHITE OR BLACK	SC

FOR ITEMS WITH SUCTION CUP MOUNT, ADD "-SC" TO THE MODEL#

SAFETY-SOFT HOLDERS

Our best selling can holders are great for beverages or air horns. We know you'll figure out other ways to use them!



CAN AND AIR HORN HOLDER HH-6

Safety-soft flexible PVC helps prevent injuries. Though designed to hold beverage cans and bottles, according to our customers they're also handy for air horns and for other small items. Use screws or suction cups for mounting.

HH-6B



HH-6

*Soft-Mate Holders were designed with slanted top and bottom planes to allow ropes to slide off instead of getting snagged on them. Also, because these holders are flexible, they're less likely to pull away from their mounting if hit by a hard object or stepped on.



BEVERAGE HOLDER HH-61

Perfect size for beverage cans with insulators. Mount with screws or suction cups. White, Black

HH-61



HH-61B



HH-4

BINOCULAR HOLDER HH-4

If you keep your binoculars in this holder, you'll be able to grab them just when you need them! Of course, this holder is also suitable for magazines, log books, and tools.

SUCTION CUP OPTIONS:

If you're looking for a Soft-Mate holder that can be moved around or you don't want to drill holes for your Soft-Mate holder, order the model with the suction cup mounts. Models available with the set of three suction cup mounts are noted in the product chart. The clear plastic suction cups provide tremendous holding power. The suction cup mounts can also be purchased separately if you already have Soft-mate™ can or radio holders. Add -SC to the model #.



HH-6-SC



HH-6B



ALUMINUM INSERTS & DRINK HOLDERS



DOMED RIM ALUMINUM INSERT GH42AL



Here's a sleek, modern way to dress up your Beckson **GH43 SERIES** DRINK HOLDERS! The **GH42AL ALUMINUM INSERT** slips snugly into the **GH43** and will stay in place until you want to remove it for cleaning. The domed rim hides the plastic cup rim completely. The plastic cup and aluminum insert can be purchased together. Standard anodized colors are gloss clear or flat black.



FLAT RIM DRINK HOLDERS GH40AL

This low profile ALUMINUM CUP HOLDER from Beckson is a winner on table tops, gaming tables and counters where minimal height is critical. It sets into the hole cut by itself. No other part needed. No drainage holes.

RIGID RECESSED DRINK HOLDERS



THE MEGA™ SERIES GH44

Great for cabins and galleys, The MEGA DRINK HOLDER holds the largest size of fountain drink (45 oz.), cans with sleeves, water and wine bottles. Also great for keeping a galley or work station organized. Simple installation. No fasteners needed. No drain holes, no leaking. Stand-offs in the slightly concave bottom keep containers from sticking. Any condensate or spills run into the shallow well beneath the container and can be easily wiped up. The standard colors are White, Black and Beige. Rims may be customized with chrome, woodgrain, and many foil colors such as pewter, gold, red, and blue.

These drink holders are easy to install. They fit into a standard 4" hole cut, and may be affixed with tape, fasteners, or caulk to suit your requirements.



BECKSON RIGID PLASTIC RECESSED DRINK HOLDERS

SERIES	MODEL#	COLOR	FLANGE DIAMETER	HOLE CUT	CUP DEPTH	CUP DIAMETER
GH31 SHALLOW	GH31-B1	BLACK	3-7/16" (8.73 cm)	3" (7.62 cm)	INSIDE:	INSIDE:
	GH31-N1	BEIGE			1-5/16" (3.33 cm)	2-11/16" (6.82 cm)
	GH31-W1	WHITE			OUTSIDE:	OUTSIDE:
					1-7/16" (3.65 cm)	2-13/16" (7.14 cm)
GH33 STANDARD	GH33-B1	BLACK	3-7/16" (8.73 cm)	3" (7.62 cm)	INSIDE:	INSIDE:
	GH33-N1	BEIGE			3" (7.62 cm)	2-11/16" (6.82 cm)
	GH33-W1	WHITE			OUTSIDE:	OUTSIDE:
					2-7/8" (7.30 cm)	2-13/16" (7.14 cm)
GH43 SUPER SIZE	GH43-B1	BLACK	4-3/8" (11.11 cm)	3-3/4" (9.52 cm)	INSIDE from stand-off:	INSIDE:
	GH43-N1	BEIGE			3-1/4" (8.25 cm)	3-9/16" (9.04 cm)
	GH43-W1	WHITE			OUTSIDE from bottom:	OUTSIDE:
					3-3/8" (8.57 cm)	3-11/16" (9.36 cm)
GH43D SUPER SIZE DRAIN	GH43DB1	BLACK	4-3/8" (11.11 cm)	3-3/4" (9.52 cm)	INSIDE from stand-off:	INSIDE:
	GH43DN1	BEIGE			3-1/4" (8.25 cm)	3-9/16" (9.04 cm)
	GH43DW1	WHITE			OUTSIDE: OVERALL	OUTSIDE:
					3-1/2" (8.89 cm)	3-11/16" (9.37 cm)
GH44 MEGA	GH44-B1	BLACK	4-1/2" (11.43 cm)	4" (10.16 cm)	INSIDE from stand-off:	INSIDE:
					3-3/8" (8.57 cm)	3-7/8" (9.84 cm)
					OUTSIDE from bottom:	OUTSIDE:
					3-9/16" (9.05 cm)	4" (10.16 cm)

ALUMINUM DRINK HOLDERS AND INSERTS

Aluminum drink holders made in China from Beckson tools.

SERIES	MODEL#	COLOR	FLANGE DIAMETER	HOLE CUT	CUP DEPTH	CUP DIAMETER
GH40AL RECESSED HOLDER	GH40AL-C	GLOSS CLEAR	FLAT FLANGE 4.30" (10.92 cm)	3-3/4" (9.53 cm)	INSIDE:	INSIDE:
	GH40AL-B	FLAT BLACK			3.27" (8.30 cm)	3.61" (9.17 cm)
					OUTSIDE:	OUTSIDE:
					3.31" (8.40 cm)	3.7" (9.4 cm)
GH42AL INSERT FOR GH43 SERIES	GH42AL-C	GLOSS CLEAR	CURVED FLANGE 4.57" (11.61 cm)	3-1/2" (8.89 cm)	INSIDE:	INSIDE:
	GH42AL-B	BLACK			2.68" (6.81 cm)	3.43" (8.71 cm)
					OUTSIDE:	OUTSIDE:
					2.72" (6.91 cm)	3.5" (8.89 cm)

RIGID PLASTIC RECESSED DRINK HOLDERS

WHERE TO PUT YOUR DRINK! On your boat, RV, or around your home you need a secure place to put your drink; and we have the perfect holders for you! These can be installed almost anywhere: table, countertop, dashboard, seat back, ship's galley, home theater, pickup, camper. The largest size, **GH-44**, accommodates cans with insulator sleeves, soda and most wine bottles. The **GH43** is great for large coffee cups and cans with insulator sleeves.

The **GH31 and GH33** series are perfect for cans and water bottles. You'll appreciate these practical features:

- May be installed without fasteners.
- Molded stand-offs on the bottom of our standard and super-size holders help prevent condensation build-up and keep containers from sticking to the bottom.
- Four angled drainage holes (also available without holes.)
- Beckson Super Size and Drain Spigot Drink Holders will hold 1 liter bottles, cans with foam insulating rings, and soda and beverage cans or glasses alone.
- All available in Black, Beige, and White.
- Flat rim is ideal for foil decoration with woodgrain, color, or chrome.



GH43- with a woodgrain decorated rim



GH43-W1

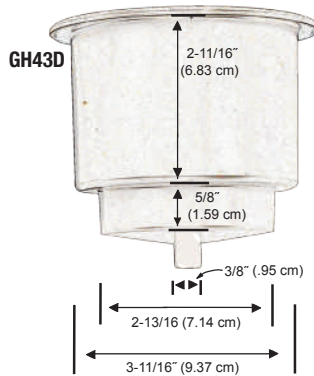

GH43D

SUPERSIZE SERIES GH43

SUPERSIZE DRINK HOLDER

The inner step of the versatile G43 series holds soda cans and air horns, and the outer step holds cans with insulators, wine bottles, and similar items.



GH43-B1



GH43-N1



GH43-W3

OEM Notes: Drink holders come with drain holes and hoses. Beckson will color match all the parts you buy from us.

DRAIN SPIGOT SERIES GH43D

SUPERSIZE DRINK HOLDER WITH DRAIN safely conducts spray, rainwater, and spills, using 3/8" (.96 cm) hose to bypass moisture sensitive electronics or dry storage to drain where you want it.



GH43DW1



GH43D39

STANDARD SERIES GH33

STANDARD SIZE CAN HOLDER
Nice tight fit for can and water bottles. It is a single step model, but is deep enough to keep the container secure.



GH33-W1



GH33-N1



GH33-B1

SHALLOW SERIES GH31

SHALLOW DRINK HOLDER.
Close fit for can and water bottles, especially where space is at a premium.



GH31-W1



GH31-B1

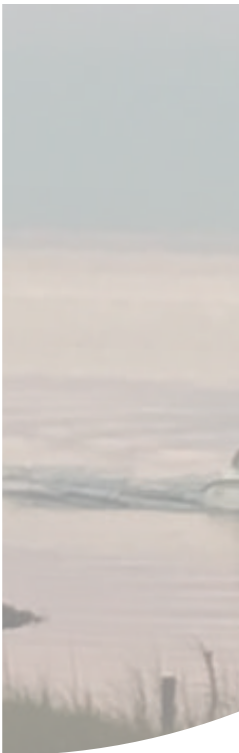

* **OD:** OVERALL DIMENSION
ID: INSIDE DIMENSION





SEA SNAP® Unusual and Useful Giant Clothespin



Hang wet towels on rails or lines with Sea Snap nautically inspired clothespins from Bernard Engraving. Sea Snap is 2-1/2" wide at rest and 6-1/4" long, with a 1-1/2" jaw opening. These colorful translucent plastic pins have big teeth—all the better to hold things with!

- Wide hook designed for hanging Sea Snap from 3/4" to 1-1/4" railings—on the boat, shower rods at home, in the shop.
- Hang items safely from lifelines and other rigging.
- Available in teal, yellow, red, clear, and blue.
- Handy for clipping and organizing wires and cables.
- Useful for drying towels, swimwear, and snow wear.
- Great holiday stocking stuffers and useful hostess gifts.
- Sold individually.
- Available with two straight sides. Call to order.

MODEL #	COLOR	DIMENSIONS
SS1TEA	TEAL	
SS1YEL	YELLOW	LENGTH: 6-1/4" (15.9 cm)
SS1RED	RED	RESTING WIDTH: 2-1/2" (6.4 cm)
SS1CLR	CLEAR	JAW OPENS: 1-1/2" (3.8 cm)
SS1BLU	BLUE	



Shipmate™ STAINLESS PICK/PROBE

So versatile! Simple in appearance, but carefully designed, this rugged tool is an ideal multitasker for boating, fishing, camping, crafts, and home projects. Its sharp tapered blade does not flex under normal use, so it can be used to split ice—no chopping necessary—just push! Easily make pilot holes in wood and leather, scrape grime and old caulk out of hard to reach places, and use for numerous other purposes. We've introduced a new model with a shorter blade that marine surveyors can appreciate—it's ideal for testing for wood rot. Also multipurpose, it can even be used to pin a fish to a board to filet it; and it's a fantastic awl and hole starter!

You can see why you'd need one of these—or even both! Designed to fit almost everyone's hand size and shaped to prevent accidental roll-off from counters and decks, Shipmate's durable handle is made of tough marine resin for long service. Both the original blue 7" Shipmate and the new black 5-1/2" Shipmate "shorty" make welcome and practical gifts that can last a lifetime!

BLUE: Overall Length: 7" (17.8 cm)
Blade: 4" (10.2 cm)

BLACK: Overall Length: 5-1/2" (14.0 cm)
Blade: 2-1/2" (6.4 cm)



The
NEW
"Shorty!"

MODEL#	COLOR	MODEL#	COLOR	DESCRIPTION
IPS01BL	BLUE			GIFT BOX WITH STAINLESS PICK, SHEATH, 1 MOUNTING CLIP, 2 SCREWS
IPB01BL	BLUE	IPB02BK	BLACK	PICK WITH SHEATH IN A BAG
IPM01BL	BLUE			PICK WITH MOUNTING CLIP AND SCREWS IN A BAG
IP-SHEATH	BLACK			SHEATH - FULLY PROTECTS STAINLESS PICK DURING STORAGE
IPx01BL	BLUE	IPx02BK	BLACK	BULK BAG OF TEN PICKS ON A CARDBOARD BACKING

ALL WEATHER NON-SKID STEP PAD

Heavy duty 3" wide tread for stepping surfaces, both indoor and out. Comfortable to walk on, never too hot or too cold. Supplied in 12" (30.5cm) pairs. Self-adhesive backing. Will not crack or discolor.

Thickness: 1/16" (1.6 mm)

Custom colors and sizes upon request. Minimum order. Call for pricing.



MODEL#	COLOR	WIDTH	LENGTH
SM-1B PAIR	BLACK	3" (7.6 cm)	12" (30.5 cm)
SM-1BR PAIR	BROWN	3" (7.6 cm)	12" (30.5 cm)
SM-1W PAIR	WHITE	3" (7.6 cm)	12" (30.5 cm)

BOAT HOOKS

- **THEY FLOAT!**
- **STRONG • NON-CONDUCTIVE**
- **NON-MARRING • NON-CORRODING**



The boat hook is one of the most overlooked but important pieces of boating safety equipment. Our Beckson Hook-Mate® boat hook was designed to incorporate the features boat owners told us they wanted and needed. Unlike exposed metal boat hooks, these stay comfortable to hold on the hottest afternoon or on a frigid winter morning. In addition, our hook end has multiple uses—no wonder Hook-Mate's hook end is the most copied in the world!

- Fixed length - no collapse in an emergency.
- PVC shaft avoids splinters and cracks.
- Pushes, pulls, and retrieves without slippage.
- Easily cleaned for a lifetime of service.
- Replaceable heads in red or blue.
- Not electrically conductive.
- It FLOATS, so you can spot it readily!
- Finger grips align with the hook for orientation in the dark!

RED HOOK-MATE® MODELS (RED HOOK & HANDLE)

MODEL#	SIZE	MODEL#	SIZE
HM-3	3' (.92 m)	HM-4	4' (1.2 m)
HM-5	5' (1.5 m)	HM-6	6' (1.8 m)
HM-7	7' (2.1 m)	HM-8	8' (2.4 m)

BLUE HOOK-MATE® MODELS (BLUE HOOK & HANDLE)

HM-3BL	3' (.92 m)	HM-4BL	4' (1.2 m)
HM-5BL	5' (1.5 m)	HM-6BL	6' (1.8 m)
HM-7BL	7' (2.1 m)	HM-8BL	8' (2.4 m)

RED HOOK ENDS HM-R BLUE HOOK ENDS HM-BL

Hook Ends will also fit any 1" OD rod.

Hook-Mate pushes, pulls, retrieves, and stores conveniently.



"I've had a 5' Hook-Mate boat hook for probably more than 20 years now. I got it with a used boat I bought and it was a bit dirty and beat-up, but it never disappointed. I made the mistake of buying several telescoping boat hooks, most of which . . . became hard to operate . . . caps often came off . . . poorly designed hooks . . . So, I got the old Hook-Mate out today and cleaned it up with spray cleaner and a scrubbing sponge. I spent a few minutes with plastic polish on the shaft as I watched TV. And it looks like brand new.

—Fred Maxwell, VA, powerboater and fisherman, Chesapeake Bay and Potomac River

The 3' MODEL# HM-3 HOOK-MATE® was designed especially with kayakers in mind. It stows snugly with the 1" accessory clips, as do all of the Hook-Mates. See page 53 for more clip info.

- MODEL# CLP-1 BLACK
- MODEL# CLP-1W WHITE



memory-mate™

BOAT MANAGER BOOKS

ML-PBMGR Power Boat Manager ML-SBMGR Sailboat Manager

You don't need batteries or an internet connection to access these information-packed, comprehensive Sailboat and Power Boat Manager Books. As for the details of all your adventures on the water, our logbooks are ideal for recording them!

The SAILBOAT MANAGERS AND POWER BOAT MANAGERS provide a wealth of information about boating safety, nautical references, and maintenance. For both beginners and experienced boaters, they are a must! Features include: durable poly cover, hard back writing surface, U.S and international reference materials, coded chapter tabs, and laminated quick reference pull-out cards in a convenient size for easy storage and access. Page size: 6" x 9".

LAMINATED QUICK REFERENCE CARDS CONTAIN

- Information about emergency procedures.
- Practical and recommended information.
- Waypoint Log.

CORE CONTENTS OF BOTH BOOKS INCLUDE

- Piloting, including basic instruction.
- Forms for owner information and other required documentation.
- Forms to record inventory/medical information/supplies.
- Vessel information and much more.



MODEL#	COLOR	COVER SIZE	PAGE SIZE
MM303		9-1/2" x 12-1/4"	8-1/2" x 11"
MM403	NAVY COVER	9" x 11-1/4"	9" x 11-1/4"
MM503		9" x 6-3/8"	8-1/2" x 5-3/8"
MLPBMGR POWER BOATS		8-3/4" x 9-3/4"	6" x 9"
MLSBMGR SAILBOATS		8-3/4" x 9-3/4"	6" x 9"

Find more Memory-Mate Log Books

- MM304 Refill Pages for MM303
- MM400 Series of spiral-bound logbooks with flexible vinyl covers
- MM506 GPS Register

LOG BOOKS

MM303 22-RING LOOSE-LEAF COMBINATION LOG

Record all information about your voyage and boat operation: trip log, radio use, maintenance, guest register, business use. Contains copies of U.S. Coast Guard-required plaques, Mayday radio procedures. Sturdy, vinyl-clad hardcover. Refillable.



MM403 SHIP'S LOG

Record all information about your trips. Includes copies of plaques required by the U.S. Coast Guard and the radio procedures for Mayday calls. Spiral bound with sturdy flexible vinyl cover.

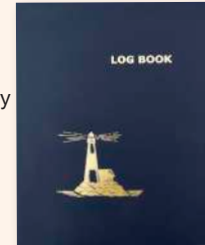

MM503

SMALL CRAFT LOG HALF-SIZED

Record all your information in a smaller format, great for smaller boats. Laminated plastic cover.



GET IT CUSTOM MADE!



ENGRAVED PLASTIC PLATES

Want something different? We love making custom plates for our customers! Just call with your requirements.

ENGRAVED PLASTIC STRIPS

These engraved plastic strips, from 6" to 11-1/2" long, are 1/2" high, but they can be made in other sizes. Your choice of self-adhesive backing or with holes for brads. Please call to tell us what you need.

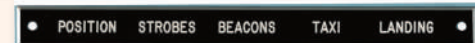

HULL IDENTIFICATION NUMBERS

Our Custom Engraved Plates are ideal for federally required Hull Identification Numbers—two plates with alphanumeric characters required for each vessel. Minimum letter height 1/4". Call to order.

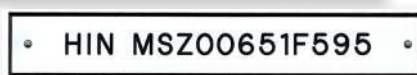

DOCUMENTATION PLATES

USCG Documentation Plate. Engraved Plastic. Measures 5" high x 20" long. The alphanumeric characters are 3" tall.

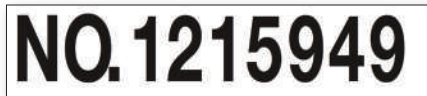

RIGID WINDOW CHANNEL

- Available for either double or single windows and doors.
- Made of rigid B-FLEX marine plastic, will not crack or discolor.
- Ideal for installing sliding cabinet doors.
- Resistant to all weather and salt spray; non-corrosive, non-corroding.
- Slightly narrowed grooves for a snug fit to seal out leaks.
- Easy opening and closing of windows and doors aided by the raised slide at the bottom of the channel.

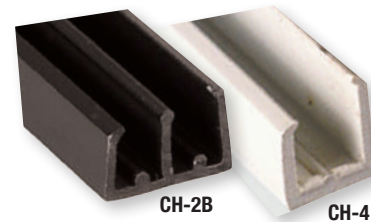

MODEL#	TYPE	GLASS WIDTH	COLOR
CH-1	SINGLE	1/4" (6.4 mm)	WHITE
CH-2	DOUBLE	1/4" (6.4 mm)	WHITE
CH-2BR	DOUBLE	1/4" (6.4 mm)	BROWN
CH-2B	DOUBLE	1/4" (6.4 mm)	BLACK
CH-3	DOUBLE	3/16" (4.8 mm)	WHITE
CH-3BR	DOUBLE	3/16" (4.8 mm)	BROWN
CH-4	SINGLE	3/16" (4.8 mm)	WHITE



Channel is in 8' lengths. Shipping will incur dimensional upcharge.

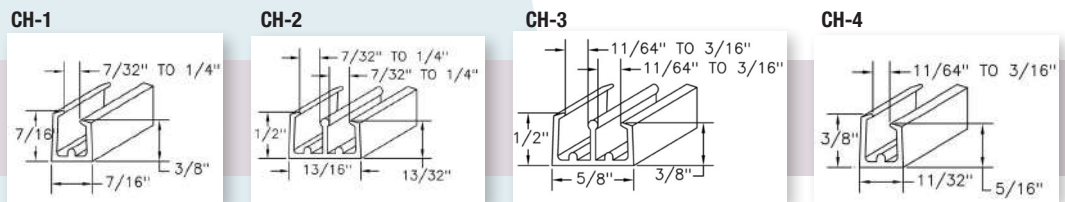

ALL RIGID WINDOW CHANNEL- MODEL# CH-1, CH-2, CH-2BR, CH-2B, CH-3, CH-3BR, CH-4

TRIM-MATE[™]

FLEXIBLE VINYL TRIM: IT BENDS!

You'll love this labor-saving flexible all-vinyl trim!

- Serrated metal reinforced self-locking inset.
- Just snap it on and it stays put.
- No rivets; no adhesive.
- Excellent trim for rough edge of fiberglass and wood.
- Will bend into a 4" circle.
- Ideal for use on the bottom of gas cans.

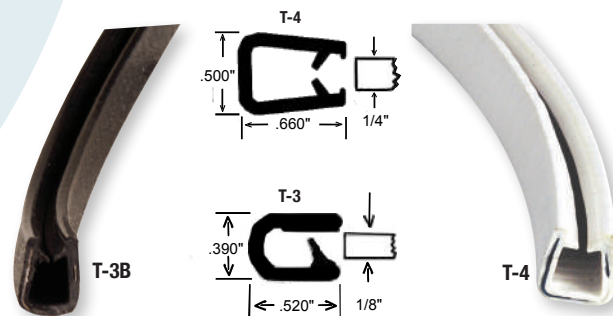

MODEL#	QUANTITY	DESCRIPTION	COLOR
T-3	100'/CARTON	1/2" HIGH. FITS EDGES 1/8" to 1/4" (3.2 mm to 6.4 mm)	WHITE
T-3B	100'/CARTON	1/2" HIGH. FITS EDGES 1/8" to 1/4" (3.2 mm to 6.4 mm)	BLACK
MODEL#	QUANTITY	DESCRIPTION	COLOR
T-4	125'/ROLL	5/8" HIGH. FITS EDGES 1/8" to 3/8" (3.2 mm to 9.5 mm)	WHITE
T-4B	125'/ROLL	5/8" HIGH. FITS EDGES 1/8" to 3/8" (3.2 mm to 9.5 mm)	BLACK



LACING HOOKS & EYE STRAPS

It's no fun to lose your gear overboard! When you're out on the water and it's crucial to keep everything securely in place and accessible, use Beckson's durable lacing hook and eye straps to do the job. Through whitewater, up against rough weather, or just breezing along, lacing hardware used with netting and shock cords, keeps your gear stowed where you need it.

On your kayak or canoe, stow a spare paddle, pump, and recovery equipment within easy reach. On larger vessels, you can safely store boat hooks, long-handled brushes, and other necessities, out of sight yet conveniently near at hand.

For securing smaller items or individualizing your storage options, you can make pockets using netting with Beckson's hook and eye hardware. These can even handle light rigging and furling duties on sailboats. The hooks are also useful for hanging swimsuits and similar lightweight items.

- Made of high grade nylon.
- Will not deteriorate or stain surfaces.
- Two eye strap models provide installation options: **BKT-04-C** has a countersunk mounting hole. **BKT-04-S** has a flat surface for pop rivets.
- Standard color is black; custom colors available in quantity purchases.
- 1" tall **BKT-02** hook accommodates cord up to 1/4" diameter.

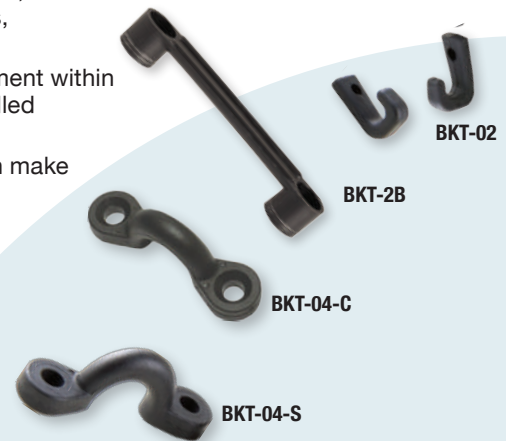

MODEL #	DESCRIPTION	LENGTH	HEIGHT	FASTENER SPACING	QUANTITY
BKT-02	1/4" (.64 cm) LACING HOOK	1" (2.54 cm)	5/8" (1.59 cm)		5-PACK
BKT-04-C	5/16" (.79 cm) EYE STRAP	1-7/8" (4.76 cm)	11/16" (1.75 cm)	1-3/8" (3.50 cm)	5-PACK
BKT-04-S	5/16" (.79 cm) EYE STRAP	1-7/8" (4.76 cm)	11/16" (1.75 cm)	1-3/8" (3.50 cm)	5-PACK
BKT-2B	BRACKET 2" (5.1 cm) STRAP EYE USED IN PAIRS, SOLD SINGLY				

BECKSON NYLON CABLE TIES

These cable ties feature smooth edges with a tapered lip for easy installation. Beckson's innovative locking system assures a firm grip so your harness assembly won't slip even after bending and flexing.

✳ Black cable ties have a higher ultra-violet resistance and are best for exterior applications.

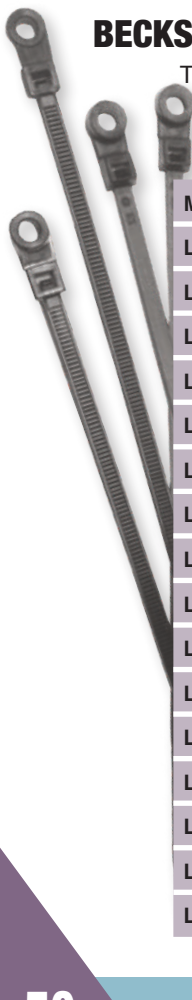

MODEL#	QUANTITY	DESCRIPTION	COLOR
L-4	24/PACK	4" (10.16 cm) WITHOUT MOUNTING HOLE	WHITE
L-4/C	100/PACK	4" (10.16 cm) WITHOUT MOUNTING HOLE	WHITE
L-4B	24/PACK	4" (10.16 cm) WITHOUT MOUNTING HOLE	BLACK
L-4B/C	100/PACK	4" (10.16 cm) WITHOUT MOUNTING HOLE	BLACK
L-7	24/PACK	7" (17.78 cm) WITHOUT MOUNTING HOLE	WHITE
L-7/C	100/PACK	7" (17.78 cm) WITHOUT MOUNTING HOLE	WHITE
L-7B	24/PACK	7" (17.78 cm) WITHOUT MOUNTING HOLE	BLACK
L-7B/C	100/PACK	7" (17.78 cm) WITHOUT MOUNTING HOLE	BLACK
L-7MH	12/PACK	7" (17.78 cm) WITH MOUNTING HOLE	WHITE
L-7MH/C	100/PACK	7" (17.78 cm) WITH MOUNTING HOLE	WHITE
L-7MHB	12/PACK	7" (17.78 cm) WITH MOUNTING HOLE	BLACK
L-7MHB/C	100/PACK	7" (17.78 cm) WITH MOUNTING HOLE	BLACK
L-14MH	5/PACK	14" (35.56 cm) WITH MOUNTING HOLE	WHITE
L-14MH/C	100/PACK	14" (35.56 cm) WITH MOUNTING HOLE	WHITE
L-14HB	5/PACK	14" (35.56 cm) WITH MOUNTING HOLE	BLACK
L-14MHB/C	100/PACK	14" (35.56 cm) WITH MOUNTING HOLE	BLACK



B PLASTIC HINGES from Beckson's ingenious design team.

- Choice of two styles: Full Opening (one pin) and Offset (two pin)
- Interchangeable parts provide various configurations for your needs and space.
- Lightweight, strong, injection molded high strength acetal resin with Monel® pins
- Non-corroding; perfect alternative to shorter-lived expensive metal hinges.
- Great for doors, hatches, instrument covers, any number of applications.
- Colors: Black, White. OEM custom colors quoted upon request.
- Sold in pairs. Model numbers specify component matches.
- Suitable for all size boats: personal watercraft, fishing fleets and the largest cruiser.

FULL OPENING HINGE HGAP Series

- Exceptional hinge with full 180° opening lets hinge rest flat in its fully folded position, which enables hatch covers to lie flat.

MODEL#	COLOR	MODEL#	COLOR
HGAP11-B	BLACK	HGAP33-B1	BLACK
HGAP11-W	WHITE	HGAP33-W	WHITE
HGAP22-B1	BLACK	HGAP44-B1	BLACK
HGAP22-W	WHITE	HGAP44-W	WHITE



OFFSET HINGE HGB Series

- Installation advantage: all the features of the HGAP hinge, plus a wider gap.
- Side to side vertical offset "forgives" off-level mounting.
- Dual Monel® Pins provide flexibility for multiple mounting applications.
- Allows up to 3/4" setback from edge of door or hatch cover for secure fastening.
- Injection molded high strength acetal resin with Monel® pins.
- 1.5" width up to 4.25" length overall.
- Colors: Black, White, OEM Custom.

OEM: HINGE COMPONENTS ARE INTERCHANGEABLE FOR MULTIPLE COMBINATIONS

MODEL#	COLOR	MODEL#	COLOR
HGBP11-B1	BLACK	HGBP33-B1	BLACK
HGBP11-W	WHITE	HGBP33-W	WHITE
HGBP22-B1	BLACK	HGBP44-B1	BLACK
HGBP22-W	WHITE	HGBP44-W	WHITE

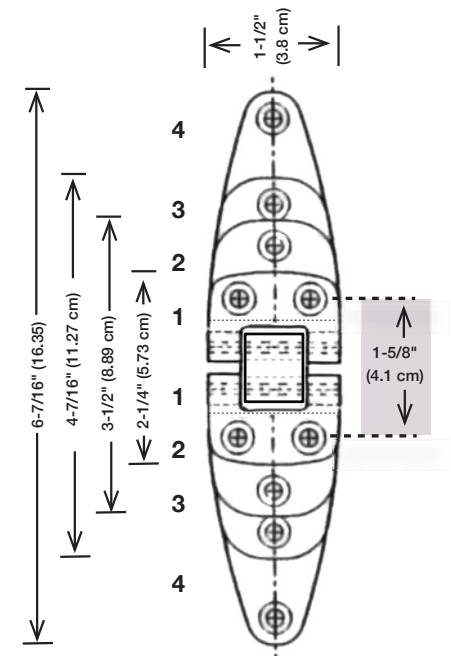
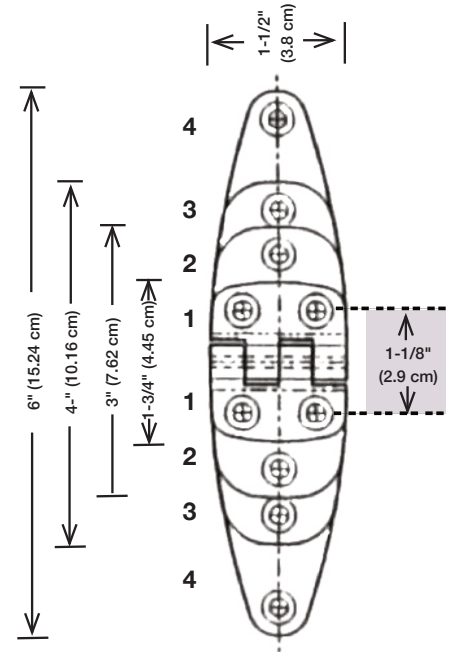
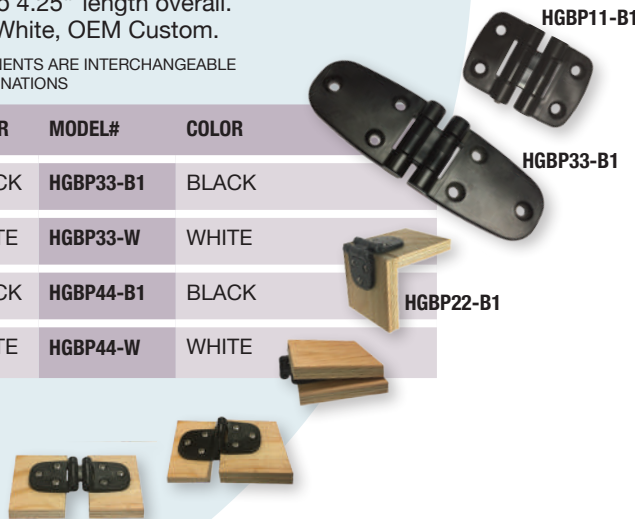

It wasn't the last of Gerry Speiss's daring ocean crossings when he fulfilled his dream in 1979 aboard what was then the smallest sailboat ever to make it across across the North Atlantic, west to east. *Yankee Girl*, a plywood sloop only ten feet long, had been meticulously designed and built in his garage at home in Minnesota. Enhancing its unique exterior appearance and bringing light to the interior of the sturdy little boat were three round Beckson portlights on each side. His all-important safety gear included a Beckson Thirsty-Mate® pump.

In 1981 he took his *Yankee Girl* for an even longer expedition, 7800 miles from California to Australia, achieving another first—in the smallest vessel ever to cross the South Pacific! He arrived in Sydney, after a stop in Honolulu, to a hero's welcome. Afterwards, about Beckson products, he said they had "... served me faithfully on my solo sailing voyage across the Pacific..." Speiss's perilous Atlantic crossing is recounted with Marlin Bree in a must-read thriller of a book, *Alone Against the Atlantic* (1981). His Pacific voyage is included in *Broken Seas*, an anthology of astounding sea adventures by Marlin Bree.



THRU-DECK FAIRLEADS

• LIGHTWEIGHT • NON-CORRODING • DURABLE

Perfect for routing conduit pipe, wire, and cable. Also for securely holding seating and table pedestal posts corresponding to the fairlead OD. Caulk to set in place.

NEW!

MODEL# COLOR	ID	OD	HOLE CUT	DESCRIPTION
A-200WTS WHITE	2.0" (5 cm)	2-1/2" (6.4 cm)	2-1/4" (5.7 cm)	ROUND FLANGE 1/4" (.6 cm)
A-175B BLACK	1-3/4" (4.5 cm)	2-1/2" x 4.0" (6.4 cm x 10.2 cm)	2-1/4" (5.7 cm)	OVAL FLANGE, 2 SCREW HOLES
A-150B BLACK	1-9/16" (4.0 cm)	2-1/2" x 4" (6.4 cm x 10.2 cm)	2" (5.0 cm)	OVAL FLANGE 2 SCREW HOLES
A-150BT BLACK	1-9/16" (4.0 cm)	2-1/2" (6.4 cm)	2" (5.0 cm)	ROUND FLANGE 3/8" (1.0 cm)
A-0732BL BLACK	7/32" (.6 cm)	7/8" (2.2 cm)	3/4" (1.9 cm)	2-PART ITEM ROUND FLANGE
A-732BS BLACK	7/32" (.6 cm)	7/8" (2.2 cm)	3/4" (1.9 cm)	3/32" (.2 cm)



SHORT *Stories*
OF
EXTRAORDINARY
Voyages
BOATING WITH BECKSON

At the time retired geography professor and veteran sailor, **Marvin Creamer**, set out on his boat, *Globe Star*, to sail around the world in 1982, he went with specific intent. When he returned to his starting place in New Jersey eighteen months later, he had completed an amazing voyage—his teenage dream finally realized. He'd also become the first person ever recorded to circumnavigate the globe with no navigational equipment, whatsoever. Plotting his course using celestial bodies when they were visible and other natural means, including deductive reasoning, he didn't even wear a watch! He was well-prepared with other equipment, though, including two Beckson Siphon-Mate pumps that went around the world with him.

HAWSE PIPE BECKSON HEAVY DUTY PLASTIC HAWSE PIPE

MODEL#	ID	OD	HOLE CUT	COLOR
AH42R-W1	1-1/2" x 3-3/4" (3.8 cm x 9.5 cm)	2-1/2" x 5-5/8" (6.4 cm x 14.3 cm)	1-7/8" x 4" OVAL (4.8 cm x 10.2 cm)	WHITE
AH42R-B1				BLACK

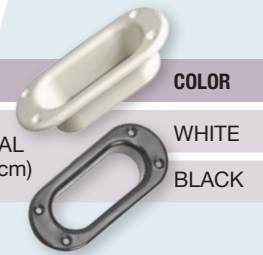

NEW!

THRU-BULKHEAD HOSE FITTING MODEL# D-5

This sturdy and extremely useful item is perfect when you need to drain through a bulkhead or other similar setup. Attaches to 1/2" hose. The D-5 includes one plastic washer, two rubber washers, and a plastic nut. Fits 1/2" (1.23 cm) hose. Requires 13/16" (2 cm) hole cut. This item is compatible with the **D-2 Baitwell Gravity Drain Assembly** with screen on page 21.

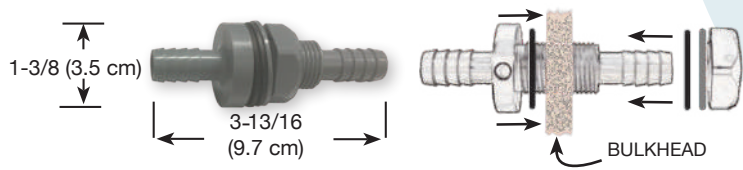

“My 1984 Tartan has original Beckson Marine portlights that needed to be re-bed and their hardware was not usable. Jay, in Beckson's customer service department, took the time to help me research new hardware and shipped the items right off, so I could complete the maintenance. In the hustle of spring commissioning, I had misplaced the new hardware. When I called Beckson to re-order, they noticed I was ordering the same item, and they immediately discounted the replacements and shipped them the next day. When the misplaced items were found a few weeks later, Beckson happily took the return and credited my account. This company did everything possible to accommodate me (for my mistakes) and couldn't have been easier to work with. What a terrific company with excellent people.”





CLIPPER™ CLIPS

Think of all the things these strong plastic clips can hold!

- Ideal for storing boat hooks, gaffs, mops, flashlights, pumps, tools and more.
- Discover hundreds of uses to organize your tools, parts, materials, and accessories.
- Beckson's safety design has no sharp edges, reducing the chance of injury.
- Available in many sizes and colors other than shown here, upon request.
- Non-electrically conductive, non-magnetic, and non-corrosive.
- Perfect for indoor or outdoor use.

Clips have two 1/8" holes on a 3/4" center for all sizes, except 1/4" with a single hole, which needs a #6 pan head fastener. The other CLP clips require two #6 oval or flathead fasteners. Sold in pairs. Order by Model#.

	MODEL# BLACK	MODEL# WHITE	APPROXIMATE HOLDING RANGE
	CLP-1/4	CLP -1/4W	1/4" to 5/16" (.6 cm to .8 cm)
	CLP-1/2	CLP-1/2W	3/8" to 1/2" (1.0 cm to 1.3 cm)
	CLP-3/4	CLP-3/4W	5/8" to 7/8" (1.6 cm to 2.2 cm)
	CLP-1	CLP-1W	7/8" to 1-1/2" (2.2 cm to 3.8 cm)
	CLP-1-1/4	CLP-1-1/4W	1-1/8" to 1-3/8" (2.9 cm to 3.5 cm)
	CLP-1-1/2	CLP-1-1/2W	1-3/8" to 1-5/8" (3.5 cm to 4.1 cm)
	CLP-1-3/4	CLP-1-3/4W	1-5/8" to 1-7/8" (4.1 cm to 4.8 cm)
	CLP-2	CLP-2W	1-7/8" to 2-1/8" (4.8 cm to 5.4 cm)

clip-mate™ CLIP-MATE CLIPS

The unique design and tempered B-Flex plastic material make Beckson's clips the perfect way to hold brooms, racks, pumps, flashlights, tools, blueprint tubes and other round objects neatly in place. Our own leg design provides permanent holding spring action unlike metal or other plastic clips, which ultimately become fatigued. Corrosion is non-existent. Available in both black and white. Sold in pairs. Clip-mate clips require a #6 pan head fastener.

MODEL # BLACK	MODEL# WHITE	APPROXIMATE HOLDING RANGE
N/A	CM-3/4	11/16" to 7/8" (1.8 cm to 2.2 cm)
CM-1B	CM-1	7/8" to 1-1/8" (2.2 cm to 2.9 cm)
CM-1-1/2B	CM-1-1/2	1-3/16" to 1-1/2" (3 cm to 3.8 cm)
N/A	CM-2	1-1/2" to 2" (3.8 cm to 5 cm)

SWELL CAMS

These unique compression latches secure in virtually any frame, rail and stanchion. Manufactured of non-corroding marine materials, they can be installed in fiberglass, wood, plastic and metal. Perfect for deck gates, lockers, interior latches, engine covers, sun decks, fillet boards and more. Quick and easy to install.

MODEL#	COLOR	HOLE CUT
SWK-B	BLACK	5/8" (1.59 cm)
SWK-W	WHITE	5/8" (1.59 cm)

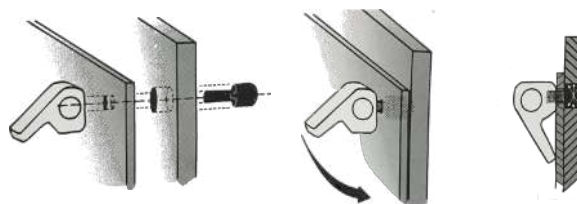

BARREL NUTS AKA INTERSCREWS, SEX NUTS, CHICAGO SCREWS, ARCHITECTURAL BOLTS

STANDARD BARREL NUT

Depending on your installation requirements, standard Barrel Nuts provide the most secure installation. They are available in two different thread sizes and two different head styles.



FLUSH MOUNT BARREL NUT

The Flush Mount Barrel Nut provides the security of a thru-bolt installation and also a clean modern look with no fasteners showing, easier port installation, and elimination of installation leaks.



STANDARD BARREL NUT

MODEL#	OVERALL LENGTH	SHANK DIAMETER	FASTENER SIZE	FINISH	QUANTITY
BB187-01	3/8" (0.95 cm)	1/4" (.66 cm)	10-24	CHROME	100
BB187-01/25	3/8" (0.95 cm)	1/4" (.66 cm)	10-24	CHROME	25
BB187-01/12	3/8" (0.95 cm)	1/4" (.66 cm)	10-24	CHROME	12
BB187-02	1/2" (1.27 cm)	1/4" (.66 cm)	10-24	CHROME	100
BB187-02/25	1/2" (1.27 cm)	1/4" (.66 cm)	10-24	CHROME	25
BB187-02/12	1/2" (1.27 cm)	1/4" (.66 cm)	10-24	CHROME	12
BB187S01	3/8" (0.95 cm)	1/4" (.66 cm)	10-24	STAINLESS	100
BB187S01/25	3/8" (0.95 cm)	1/4" (.66 cm)	10-24	STAINLESS	25
BB187S01/12	3/8" (0.95 cm)	1/4" (.66 cm)	10-24	STAINLESS	12
BB187-11	3/8" (0.95 cm)	1/4" (.66 cm)	10-24	BLACK	100
BB187-11/25	3/8" (0.95 cm)	1/4" (.66 cm)	10-24	BLACK	25
BB250-01	1/2" (1.27 cm)	5/16" (.81 cm)	1/4-20	CHROME	100
BB250-01/25	1/2" (1.27 cm)	5/16" (.81 cm)	1/4-20	CHROME	25

STANDARD BARREL NUT PORT INSTALLATION

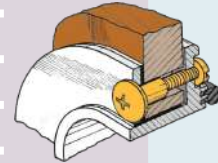

FLUSH MOUNT BARREL NUT

BB187-32F	1/4" (0.64 cm)	1/4" (.66 cm)	10-24	CADMIUM	100
BB187-32F/25	1/4" (0.64 cm)	1/4" (.66 cm)	10-24	CADMIUM	25
BB187-32F/12	1/4" (0.64 cm)	1/4" (.66 cm)	10-24	CADMIUM	12
BB187-31F	3/8" (0.95 cm)	1/4" (.66 cm)	10-24	CADMIUM	100
BB187-31F/25	3/8" (0.95 cm)	1/4" (.66 cm)	10-24	CADMIUM	25
BB187-31F/12	3/8" (0.95 cm)	1/4" (.66 cm)	10-24	CADMIUM	12

FLUSH MOUNT BARREL NUT PORT INSTALLATION

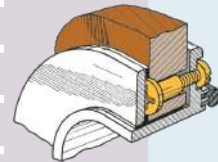

FYI: FOR YOUR SAFETY



C-6 SERIES VENTILATORS are designed as ventilators for cabin spaces and do not replace engine room blowers and exhausts. Dangerous conditions can arise from fuel vapors and fumes including propane, gas, combustion by-products, and flammable material. Appropriate ventilators should be used for those conditions.



UTILITY PUMPS 212A, 212PGA, 212PC, 216 PC, DRUM PUMPS 112FUB36, 336PF3-S, 436PF3-S, SIPHON PUMPS 109 PC and 109A are to be used only for the fluids for which they are designated. Please be careful if using flammable liquids: provide adequate ventilation, wear protective gear and NO SMOKING IN THE PUMPING AREA!



Keep children away. Avoid fire and explosion; read and follow Safety Sheet Information included with pump. **Guidelines for handling flammable liquids can be obtained from the National Fire Protection Agency, Batterymarch Park, Quincy, MA 02269.**

FYI: LEGAL NOTICES

BECKSON®, THIRSTY-MATE® and the trade dress, red and grey colors, and angled outlet sleeve, the "T" shaped pump handle, and the color red applied to the handles of these pumps are registered trademarks of Beckson: Reg. Nos. 2195309; 0693479; 1883322; 2439761; 2466454; and 2486584. Reg U.S. Patent & TM Off.



The Whale Tail logo is a registered trademark of Beckson. The mark BXN® is a registered trademark of Beckson. Thirsty-Mate®, Siphon-Mate®, Vent-o-Mate®, Sea Snap®, Step-Mate®, Hook-Mate® are all Beckson® registered trademarks. All of the other trademarks noted in this catalog are the property of their respective owners.

YOU HAVE ADVANTAGES WHEN YOU BUILD BOATS WITH BECKSON PRODUCTS! TOP OEMs HAVE BEEN USING OUR PRODUCTS FOR OVER SIXTY YEARS.

Beckson has always been a leader in supplying the OEM with quality product specifically manufactured to their specifications. To serve you, we have a knowledgeable and courteous staff, dedicated to marine OEMs. The many benefits of building your boats with Beckson include:

- Special OEM pricing.
- Highest quality, dependable parts.
- Special materials where necessary.
- Special color matches between products.
- Products Bar Coded to your specifications.
- JIT Shipping for your convenience and savings.
- Ports can be supplied with special spigot lengths.
- Assembled or non-assembled products available.
- Private labeling and custom packaging available.
- We maintain parts for all products that we manufacture.
- Special colors and materials are available for all products.

Looking for something you can't find? Give us a call.

Other Uses for Beckson Products

Drink Holders are used in movie theaters and conference rooms, on lounge chairs and in RVs. The Mega™ holders are also used for organizing cleaning materials on maintenance carts and kitchen utensils in galleys.

Ports can be found on many RVs and trucks, as well as utility sheds and garages. One of our round opening ports with cam latches was adapted for use as a butter churn lid; and our round observation port was installed on a small submersible vessel which was piloted to a record-breaking solo dive 6.77 miles into the Mariana Trench in the Pacific Ocean, the deepest place on the planet.

Beckson **Deck Plates and Cover Plates** have also served unconventional purposes—as staff access to museum display cases, and even as part of the stabilizing system for a kayak which made an epic voyage across the Pacific Ocean in 1987. (Story page 28.)

And our **Hinges** are so versatile and tough they can be used nearly anywhere! The interchangeable hinge parts will do the job—and perhaps inspire you to more! What do you have in mind?

DECK ACCESS PLATES & COVER PLATES Pages 14-21

- Certified watertight 4", 6", 8" Pry-out and Screw-out models
- Custom branding on deck plates and cover plates
- Strong and durable
- Deck plate bags specific to your needs
- Range of styles and options
- Custom materials
- Color matches



BECKSON PORTS Pages 22-31

- Thermopane ports
- Special color matches available
- Special spigot lengths
- Choice of Cam or Knob style lockdowns
- Rain Drain and Self Drain styles available
- Matching fixed and opening ports

DRINK HOLDERS Pages 44-45

- Drain or non-drain models available
- Special color matches available
- One and two-step models
- Cup depth range from 1-3/8" to 3-1/4"
- Alternate colors and material quoted upon request



LOW-PROFILE HATCHES Pages 34-35

- Mounts vertical or horizontal
- 1/2 inch closed height
- Opens full 180 degrees
- UV stabilized material
- Invisible fasteners
- One hand operation
- Textured Non-Skid Surface
- Handles and lockable latches available



RAISED HATCHES Pages 36-37

- Flat for level decks
- Cambered flange to fit curved decks
- Vinyl gasket ensures water tightness
- Available with clear deck plate installed
- Available with Vent-O-Mate installed



HINGES Page 49

- Molded with High Grade Marine Plastics
- Will not rust, pit, corrode or deteriorate
- Will withstand salt water and UV rays
- Interchangeable components
- Multiple configurations
- 270 degree operation
- Alternate colors and materials quoted upon request
- Available with offset hinges



BARREL NUTS Page 54

Barrel Nuts, Clips, Cable Ties, Swell Cams



IMPORTANT NOTICE: BECKSON MAKES NO WARRANTIES, EXPRESS OR IMPLIED, INCLUDING BUT NOT LIMITED TO, ANY IMPLIED WARRANTY OF MERCHANTABILITY OR FITNESS FOR A PARTICULAR PURPOSE. User is responsible for determining whether a Beckson product is fit for a particular purpose and suitable for user's method of application.

SOMETHING BECKSON FOR EVERYONE!

WHAT DO YOU NEED?

Look for **NEW!** items, too!

Beckson®

SAFETY

- CERTIFIED DECK PLATES 16-18
- NO-LEAK PORTS 23
- HAND PUMPS 3-13
- STEP-MATE® STEP PADS 47
- GASKETS 20, 28
- DRAIN PLUGS 21
- HOOK-MATE® BOAT HOOKS 47



COMFORT AND CONVENIENCE

- DRINK HOLDERS 43-45
- SEA SNAP® CLOTHESPIN 46
- SOFT EQUIPMENT HOLDERS 42-43
- MEMORY-MATE™ LOG BOOKS 48
- NO-LEAK PORTS 23
- STOWAWAY™ BAGS 18
- HATCHES 33-37



KAYAKS AND CANOES

- HAND PUMPS 6
- CLIPS 54
- DRAIN PLUGS 21
- STOWAWAY™ BAGS 18
- LACING HOOKS 50
- EYE STRAPS 50
- HOOK-MATE® BOAT HOOKS 47

HOLDING IT TOGETHER

- CLIPPER™ CLIPS 53
- CLIPMATE™ 53
- CABLE TIES 50
- HINGES 51
- BARREL NUTS 54
- SEA SNAP® CLOTHESPIN 46
- CLAMPS 10, 11

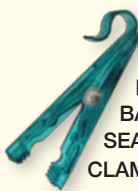

NOT JUST FOR BOATS!

- HAND PUMPS 3-13
- STEP-MATE® STAIR PADS 47
- VENT-O-MATE® VENTS 41
- DRAIN PLUGS 21
- SOFT EQUIPMENT HOLDERS 42-43
- COVER PLATES 19
- CLIPPER™ CLIPS 54
- CABLE TIES 50
- HINGES 51
- HATCHES 33-37
- CHANNEL-MATE™ WINDOW CHANNEL 49
- SWELL CAMS 53
- SEA SNAP® CLOTHESPIN 46
- CLAMPS 10-11
- SHIPMATE™ STAINLESS PICK 46



From Our E-Mail

January 24, 2017

Good afternoon,
If you've ever wondered what the wind capacity is for a Beckson Port Lens, I can tell you. I had 10 Beckson ports with smoked lenses on my 35 ft sailboat, which was on a mooring in a harbor in the Bahamas when Hurricane Matthew drove north as a Category 4 Hurricane.

My boat was 1.35 miles from the eye. It rode out the storm, while others were sunk or broken from their moorings. (One of which hit mine on the starboard side.)

Upon return to the boat after the storm I discovered a combination of fresh and salt water over the floors. Looking for the cause, we found two of the port lenses shattered, though the screens were completely intact. Which leads to the conclusion that the lens burst from the sustained 145 mile winds in a Category 4 Hurricane. All the other ports held, and there was no damage below the water line. Very impressive. The lenses were installed in 1983, original with the boat.

So, the threshold for the port lenses is 145 mph wind sustained for several hours.

Thank you for building such a quality product. I have sealed the broken lens and am making necessary repairs to other areas of the boat. When it ever comes time to repair hatches throughout the vessel, I will certainly be repairing with Beckson hatches and lenses. Keep up the quality work!

Gary Kingsley,
Bahamas

