

**BEP**

# **600-DCSM**

**DC SYSTEMS MONITOR**

**Installation and Operating Instructions**

# 1. Basics

## Features

The 600-DCSM Monitor offers the following features:

- 2.8" 16 bit TFT LCD colour screen
- Auto backlighting on key press. Also controlled by external signal
- 8 programmable inputs for DC Voltage, Tank, Systems In Operation & Pump monitoring
- 2 DC Current Inputs
- Internal calculation of DC Amp hours and remaining battery capacity (using Peukert's equation)
- 4 button backlit user interface
- Onscreen keyboard for easy input of custom labels
- Internal buzzer for high and low alarms and external alarm output 1A rated and protected.

## Specifications

### General

Power Source	8-32 V DC
Max. Current Consumption	140 m/A
Min. Current Consumption	90 m/A (Power Down Mode)
Dimensions (W x H x D)	89mm x 99mm x 19

### Input Specifications

DC Voltage	0-32 V DC
DC Current	0-±50 mV @ ±450 A
Tank	0-5 V DC
Pump	0-32 V DC
Systems in Operation	0-32 V DC
Backlight control input	0-32 V DC
Remote alarm output	1A <sub>MAX</sub> @ 12 V DC Sink to ground

### USB

Specification	USB 2.0 full speed
File System	FAT, FAT32

# Hardware Layout

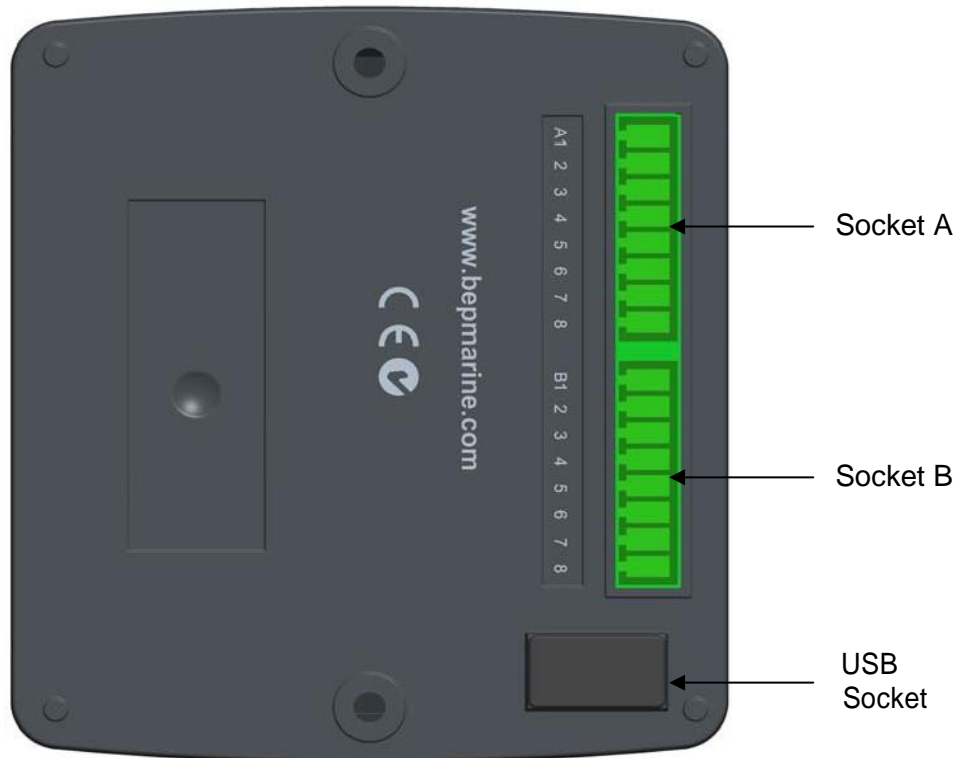
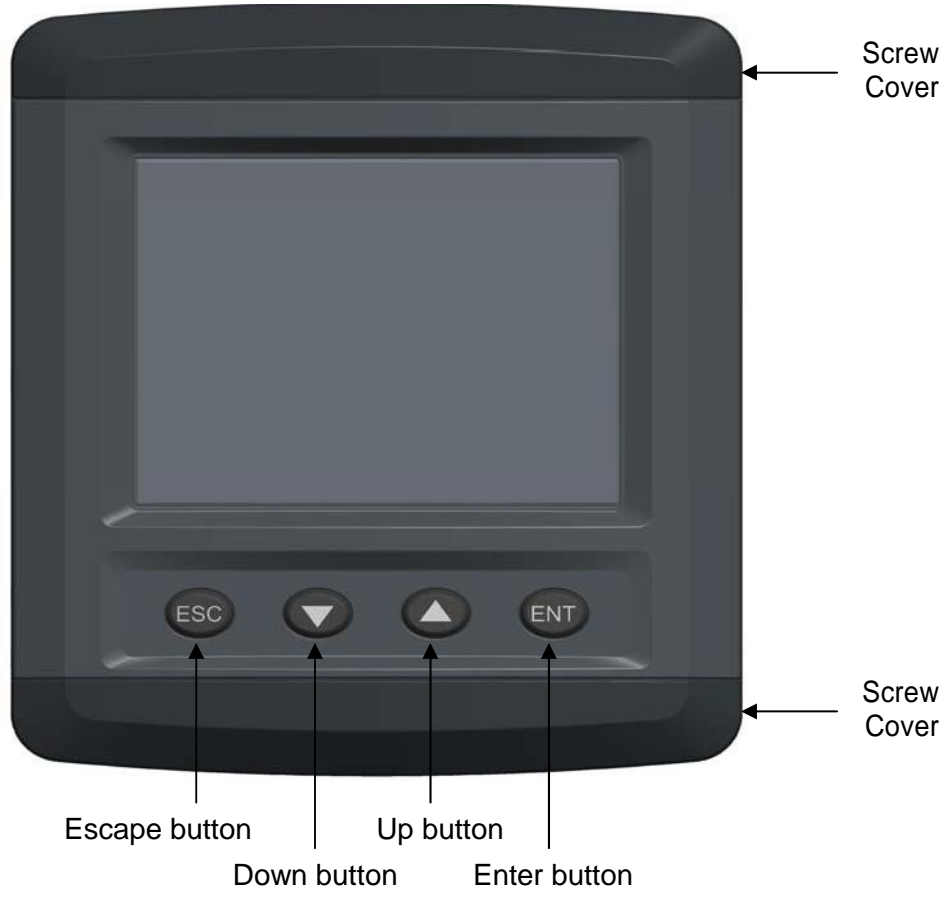

# Button Function

## Escape Button

Exits from the page or menu you are currently on and brings up the previous page or menu.

## Down Button

Moves down in page number or down the list on a menu. When inputting text button moves cursor to the left.

## Up Button

Moves up in page number or up the list on a menu. When inputting text button moves cursor to the right.

## Enter Button

Brings up 'Main menu' from any of the status pages. Enters the desired selection from a menu. Enters selected character on a calibration page.

## Power Up



When first powering up the DCSM the user will be presented with a group of default meter file types to choose from. The table below shows the 4 Default Meter Types with an X showing what inputs are enabled. Please select the Meter Type that is closest to your application:

		<b>Meter Type</b>			
		<b>DCM</b>	<b>DCTLM</b>	<b>TLM</b>	<b>Vessel Status</b>
<b>Pin/Connector Number</b>	<b>B1</b>	X (Volts)	X (Volts)		X (SOM)
	<b>B2</b>	X (Volts)	X (Volts)		X (SOM)
	<b>B3</b>	X (Volts)	X (Volts)		X (SOM)
	<b>B4</b>				X (SOM)
	<b>B5</b>		X (Tank)	X (Tank)	X (SOM)
	<b>B6</b>		X (Tank)	X (Tank)	X (SOM)
	<b>B7</b>		X (Tank)	X (Tank)	X (SOM)
	<b>B8</b>		X (Tank)	X (Tank)	X (SOM)
	<b>Vessel Status</b>				X
	<b>A5-6</b>	X (Amps)	X (Amps)		
	<b>A7-8</b>				
	<b>Battery 1</b>	X	X		
	<b>Battery 2</b>				

The meter will now load the settings and then boot to the Status Page.

Refer to the Settings Chapter on Inputs for more information about Input Types

## Status Page

A Status Page is the first screen that the meter will show after booting. To navigate through the enabled status pages press the 'Up' or 'Down' button.

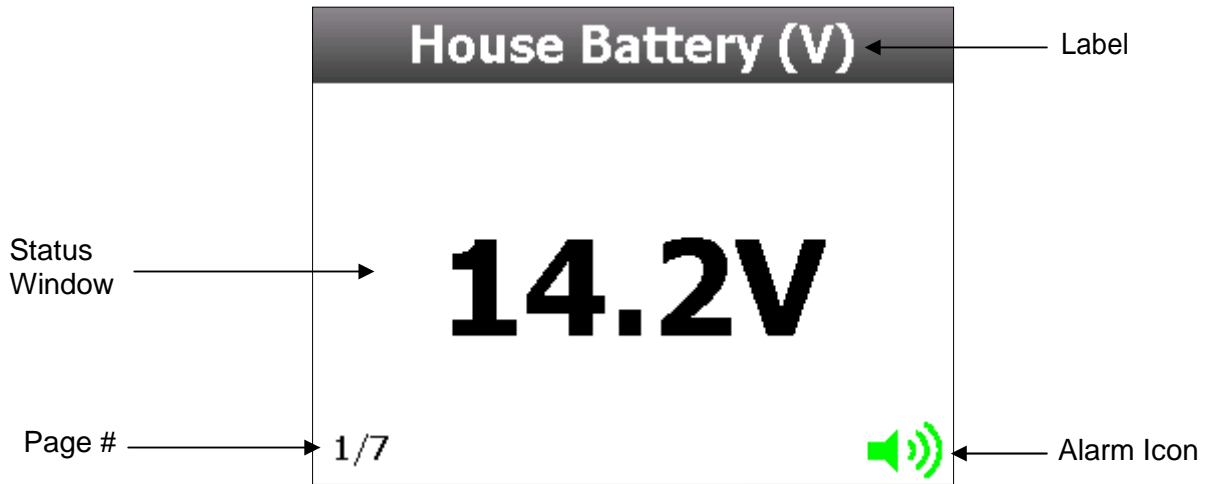

### Label

All inputs have a label assigned to it for identification. It can be chosen from a preset list of labels or custom set using the onscreen keyboard.

### Page Numbers

Every time an input is enabled to a status page it will be assigned a page number.

### Alarm Icon

The alarm icon is a visual warning to show the status of all alarms. Green means no alarm, red means alarming.

For more information on alarms & alarm icons refer to the Alarms Configuration section.

## Onscreen Keyboard

Use the onscreen keyboard to enter text such as custom labels, numerical values for Voltage, Amps and Timer values. The two types of keyboards are listed below:

### Text/Numeric Keyboard (Custom Labels)

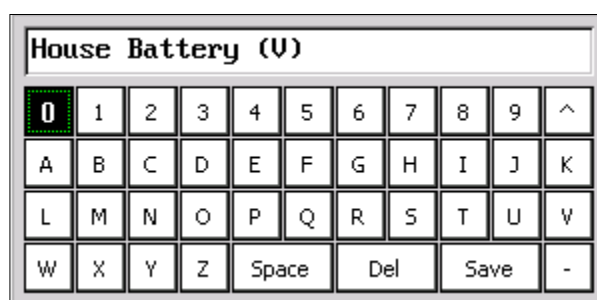

### Step 1

Press the meters **Up** or **Down** button to move the selection box to the character of choice then press the **Enter** button to accept. Any existing labels will be overwritten by first character input.

*Tip. To quickly move selection box through the keyboard press and hold the **Up** or **Down** buttons.*

### Step 2

Repeat Step 1 until the required label is finished. If there are any mistakes select 'Del' to delete the previous character. Note the text will change from Upper to Lower case after the first character is input.



Press this button to toggle between Upper and Lower case text.

### Step 3

Select the **Save** button to accept the desired Label and exit the keyboard screen. If you are not happy with the label, press **Esc** to cancel and revert to the previous label.

Note the label will not be saved until you accept the Save Settings prompt when you exit to the Main Screen.

## Numeric Keyboard (High/Low Levels/Timers)

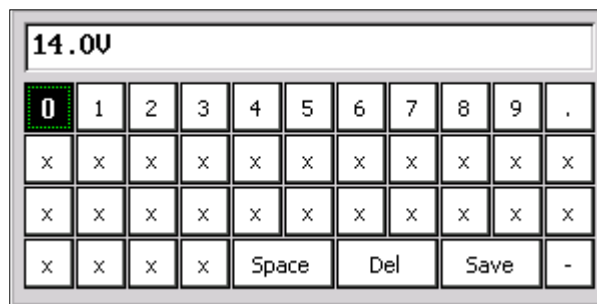

When prompted to change a numerical value for High/Low Limits, Current/Voltage settings, you will see a Numerical keyboard. It is used exactly the same as the Text/Numeric Keyboard. Note, the unit of measure (V,A etc) does not need to be entered. It is set by default.

## Saving

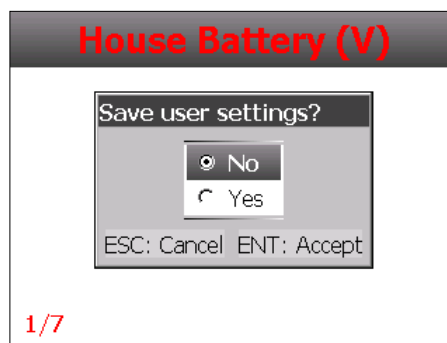

When any meter settings have been changed a save settings prompt will open when exiting to the main screen.

Selecting 'yes' will overwrite the user settings file with these changes, selecting 'no' will keep the changes, however the user settings file will not be overwritten and meter will revert back to last save on power up.

*Note: Refer to the Settings chapter for more information on user settings.*

## Lock/Unlock the Screen

The DCSM has a function to lock the screen, stopping any accidental changes being made to the settings or system. This is indicated by displaying "Locked" in the bottom left hand corner of the screen. All functionality is locked while in this state.

### To Lock/Unlock the DCSM

Press and hold "↓" for 20 seconds to lock the screen

Press and hold "↑" for 20 seconds to unlock the screen



# Dimensions

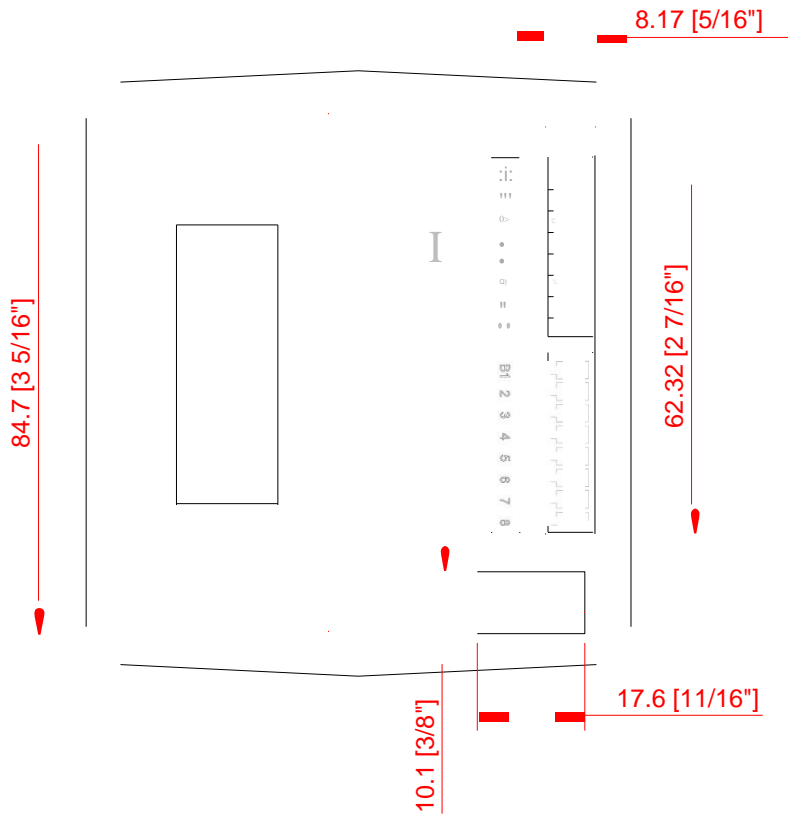
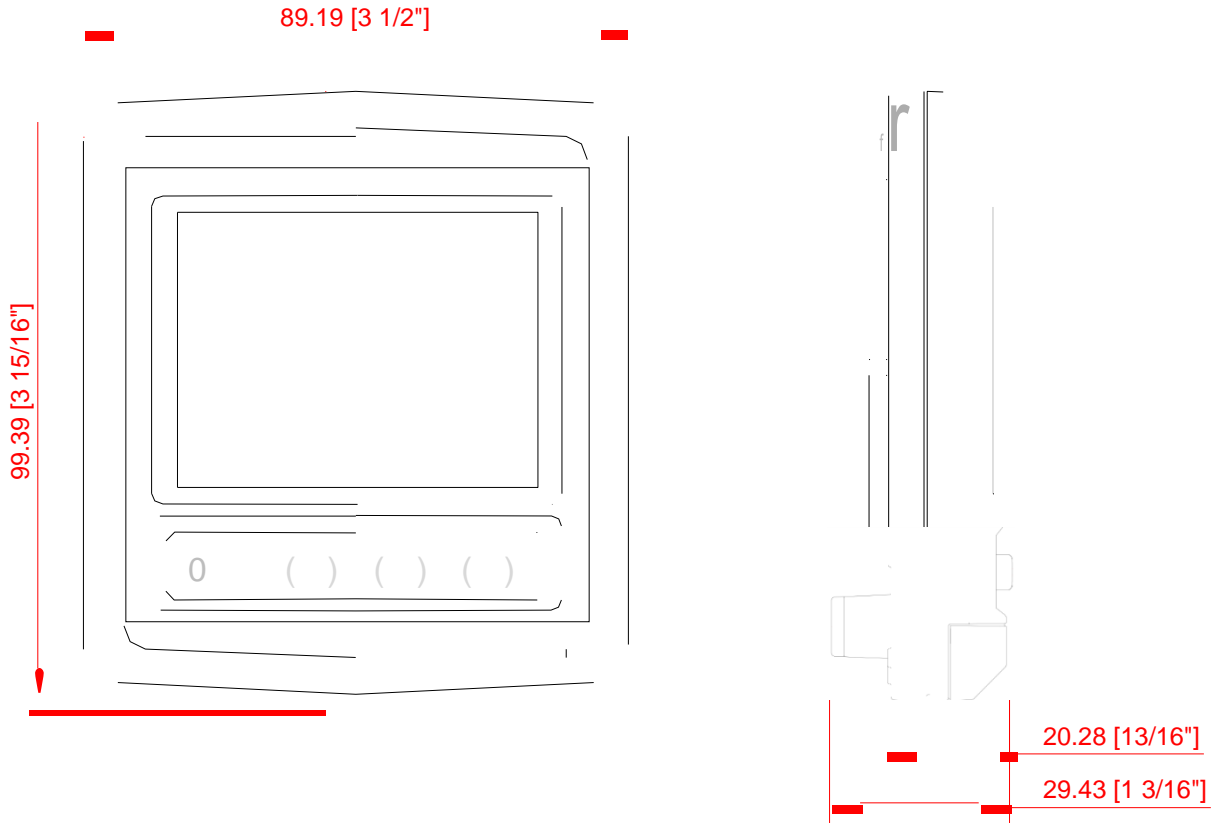



## 2. Installation

### Plug Information

Pin	Type
A1	Positive supply input
A2	Negative supply input
A3	Remote alarm output
A4	Backlight control input
A5	DC Current 1 -
A6	DC Current 1 +
A7	DC Current 2 -
A8	DC Current 2 +
B1	Input 1 (DC Voltage/Pump/Tank/SOM)
B2	Input 2 (DC Voltage/Pump/Tank/SOM)
B3	Input 3 (DC Voltage/Pump/Tank/SOM)
B4	Input 4 (DC Voltage/Pump/Tank/SOM)
B5	Input 5 (DC Voltage/Pump/Tank/SOM)
B6	Input 6 (DC Voltage/Pump/Tank/SOM)
B7	Input 7 (DC Voltage/Pump/Tank/SOM)
B8	Input 8 (DC Voltage/Pump/Tank/SOM)

### Wiring Diagram

The following are 3 basic DCSM wiring diagrams. They are based on the default meter types that are chosen on first power up:

**PLEASE NOTE:** IT IS IMPORTANT TO USE SCREENED 'TWISTED PAIR' CABLE (MINIMUM SIZE 0.25mm) BETWEEN SHUNT AND METER. THIS WILL MINIMISE THE EFFECTS OF EXTERNAL INTERFERENCE ON THE UNIT

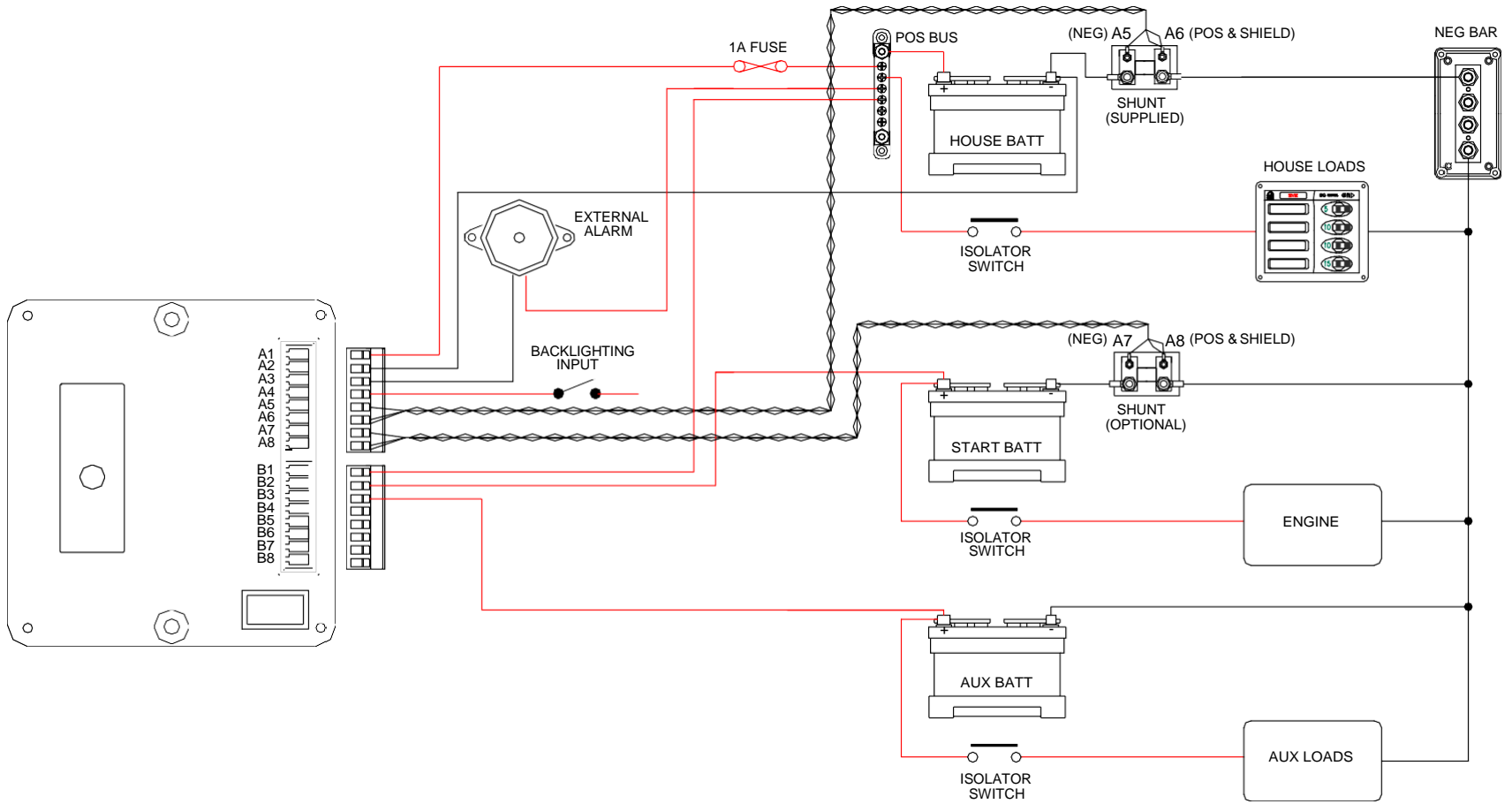

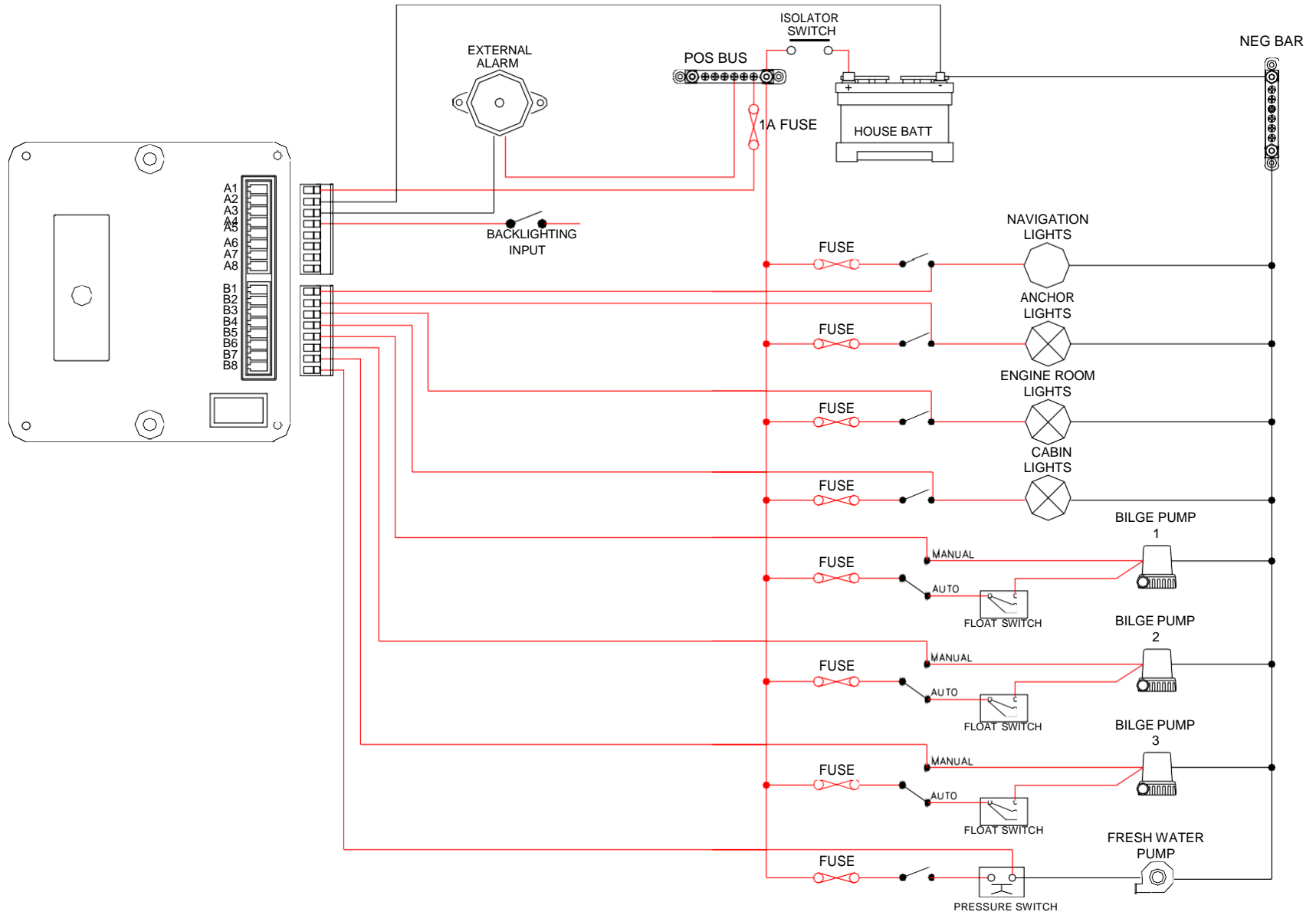

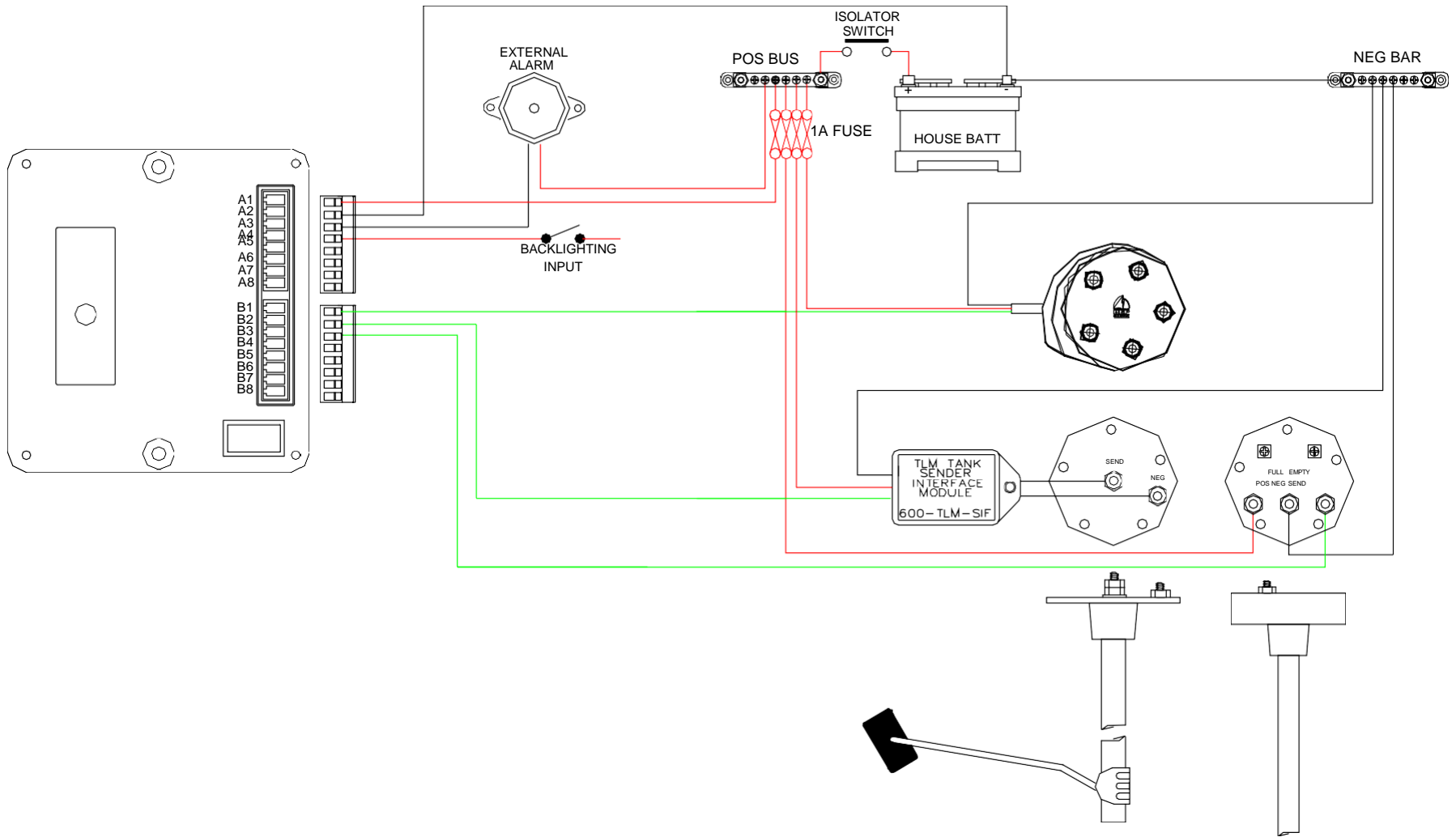

TLM (Tank level Monitoring)

# 3. Configuration

## DC Voltage

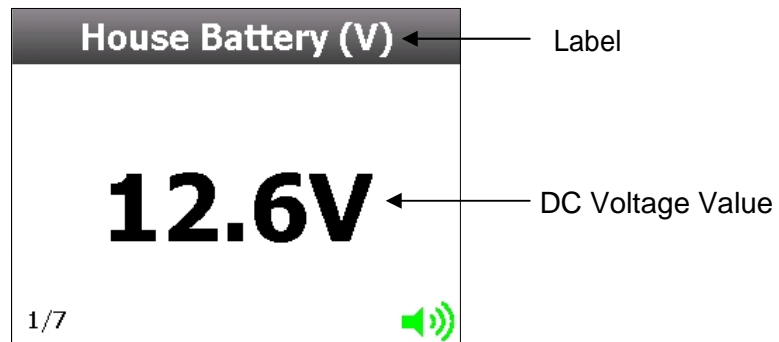

## Calibration

Voltage Calibration is factory set. If you need to alter the calibration follow the steps below:

Go to Main Menu > Setup > Input(s) > 'Choose Voltage Input' > Calibration.

The image shows a 'DC Voltage Calibration' menu with the following data:

DC Voltage Calibration	
Input Voltage	12.5V
Raw	454.00c
Zero	0c
<b>Actual</b>	<b>  0.027533x</b>
Reset Cal	No

### Step 1

Insert a ground wire into the pin of the input you are configuring. Select 'Zero' on the meter and then select 'Yes'.

### Step 2

Remove ground and then wire the Input (DC Positive) into the same pin.

### Step 3

Check battery voltage using a calibrated voltmeter then select 'Actual' and enter the correct voltage and then select 'Save'.

## Settings

Go to Main Menu > Setup > Input(s) > 'Choose Voltage Input' > Settings

DC Voltage Calibration	
Input Voltage	0.0V
Gauge Min	8.0V
Gauge Max	16.0V

### Gauge Min

This is the minimum scale for Gauge View

### Gauge Max

This is the maximum scale for Gauge View

## DC Current

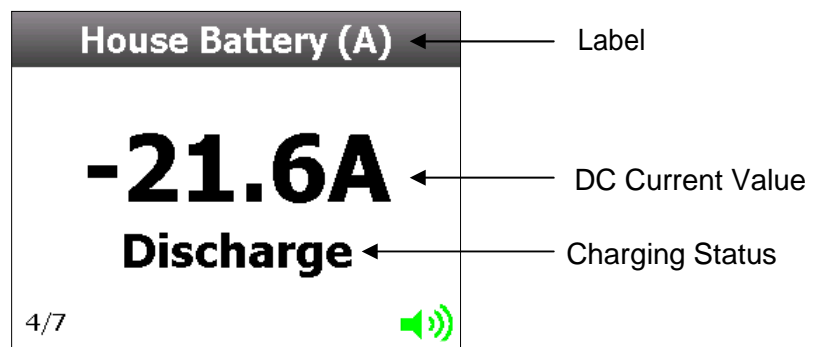

## Calibration

Current Calibration is factory set. If you need to alter the calibration follow the steps below:

Go to Main Menu > Setup > Input(s) > 'Choose Current Input' > Calibration

DC Current Calibration	
Input Current	+21.6A
Raw	149.00c
Zero	0c
Actual	0.144966x
Reset Cal	No

### Step 1

See correct wiring below for shunt connections see Fig:1 :

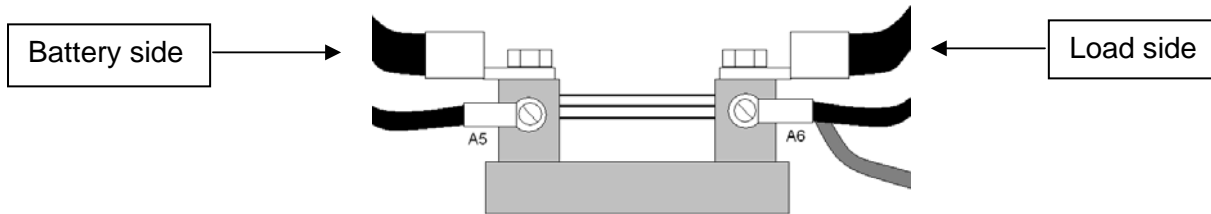

### Step 2

Select 'Zero'. Ensure shunt is wired as Fig.2 below, make sure the zero value is stable and not moving, then select 'Yes' to confirm zero.

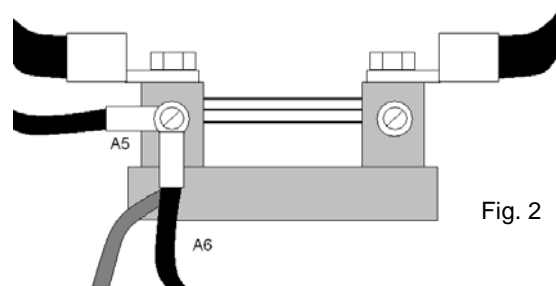

Note: Shorting the shunt out is not acceptable for a zero voltage

Fig. 2

### Step 3

When Zero is complete put wires back to the configuration in Fig.3 below.

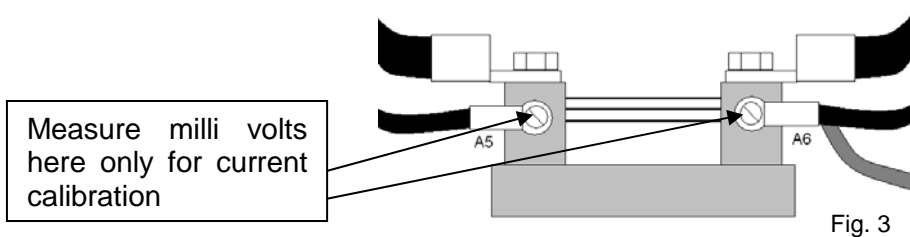

Fig. 3

### Step 4

Apply a constant resistive load to the battery and wait 1 minute, a good example of this is lighting, nav lights, interior lights etc. 120W to 240W should be enough to generate a reasonable current for calibration. A bad example is anchor winch's, invertors or motors.

Measure with a calibrated digital meter set on millivolts the voltage across the shunt. Make sure it is stable and not declining or fluctuating, any change will cause the meter to be calibrated with an error.

Calculate the current to enter into the DCSM meter:

Voltage on mV meter x 9000 = Calibration current value to enter into meter.

Example: 2mV x 9000= 18A

Select 'Actual' and enter the correct current value (with symbols '-' for discharging or '+' for charging) and then select 'Save'.

Make sure you ESC (escape) out of the calibration menu and when prompted to save you do so or your calibration will be lost.

### Settings

Go to Main Menu > Setup > Input(s) > 'Choose Current Input' > Settings

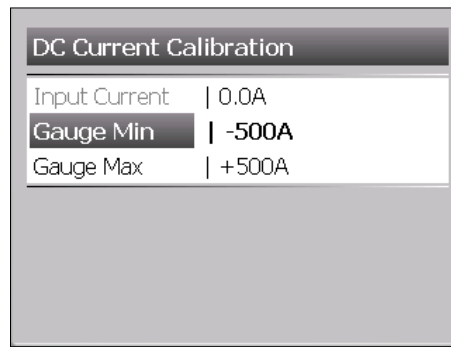

### Gauge Min

This is the minimum scale for Gauge View.

### Gauge Max

This is the maximum scale for Gauge View.

## Battery Capacity

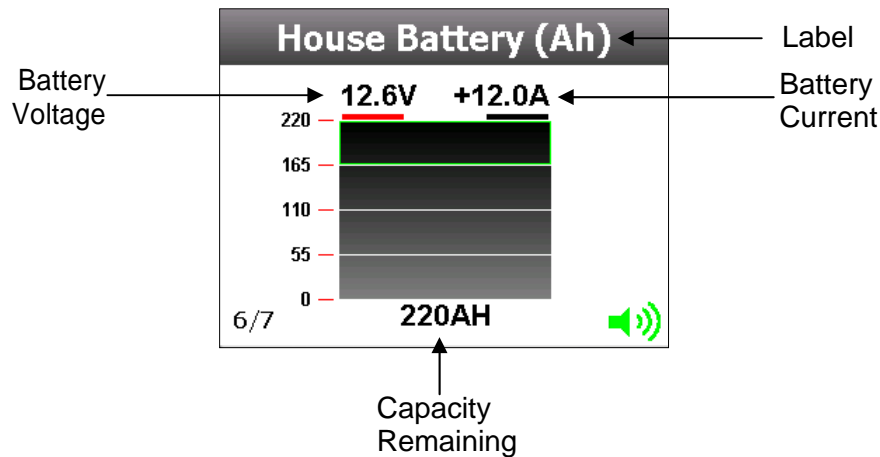

The true capacity of a battery is dependent on the rate of discharge. The faster the rate of discharge, the less total Ah capacity can be delivered. This phenomenon was described mathematically back in 1897 by a researcher named Peukert. He formulated the equation:

C = Is battery capacity at 20hrs discharge  
 A = Is discharge current in Amps  
 T = Is discharge time in hours  
 n = Peukert's Exponent for that battery

Exponent "n" can be calculated for any given battery bank by comparing two discharge cycles. First fully charge battery bank from shore power/genset & discharge at 50% of expected average load (note time and Amps) to 10.5V terminal voltage (12V System). Recharge fully and discharge at 150% of expected average load.

T1 = Time of discharge at 50% average Amp load  
 T2 = Time of discharge at 150% average Amp load  
 A1 = 50% of average Amp load  
 A2 = 150% of average Amp load  
 n = Peukert's Exponent

$$n = \frac{\log T2 - \log T1}{\log A1 - \log A2}$$



Example: 8G4D 180A/Hr Battery

Discharge 1 = 24 hours @ 7.8 Amps

Discharge 2 = 8 hours @ 20.7 Amps

$$n = \frac{\log T2 - \log T1}{\log A1 - \log A2}$$

$$= \frac{\log 8 - \log 24}{\log 7.8 - \log 20.7}$$

$$= \frac{0.90 - 1.38}{0.89 - 1.32}$$

$$= \frac{0.48}{0.43}$$

$$= 1.1$$

Therefore “n” equals 1.1 for this particular battery Bank and is the value entered on the settings page.

**NB: Please be aware adjustments to “n” as small as 0.01 will have a significant effect on the calculated discharge rate. Alter in small steps.**

Calculating exponent “n” from discharge cycles is the only way to achieve an accurate discharge exponent. If you do not want to calculate “n” use the tables below to select a typical “n” for your battery type.

VALVE REGULATED GELLED BATTERIES			
MODEL	VOLTS	20 Hr RATING	n'
8GGC	6	180	1.14
8GU1	12	43	1.20
8GU24	12	70	1.13
8GU27	12	86	1.12
8GU30H	12	95	1.12
84D	12	180	1.11
8G8D	12	225	1.10

ENDURANT (US BATTERIES) FLOODED			
MODEL	VOLTS	20 Hr RATING	n'
R220	6	180	1.24
L16	12	43	1.28
US105	12	70	1.23
US130	12	86	1.24
US240	12	95	1.17

## Setup

Go to Main Menu > Setup > 'Input(s) > 'Select Battery (Ah) Page' > Settings

Battery Calibration	
Voltage Input	0
Current Input	9
Actual Capacity	4.01AH
Max Capacity	220.00AH
Reset Voltage	13.50V
Reset Current	5.00A
Reset Time	5.00min

### Step 1

Ensure both Battery Voltage and Current are calibrated. *Refer to DC Current & DC Voltage Calibration section.*

### Step 2

Check 'Voltage Input' and 'Current Input' settings. They should be linked to the same battery you are calibrating the Capacity for.

### Step 3

Enter the Maximum Capacity for the Battery.

### Step 4

Enter the Peukerts Exponent.

*Note: If the correct Peukerts Exponent is not known or calculated incorrectly it can have a negative effect on the accuracy of the capacity state.*

## Settings

### Voltage Input

This is the reference number of the voltage that is displayed on the Battery Capacity page and also used to perform a capacity reset at a predetermined value and time.

### Current Input

This is the reference number of the current that is displayed on the Battery Capacity Page and also used to perform a capacity reset at a predetermined value and time.

### Actual Capacity

This is the actual battery capacity and will change in relation to the battery state.

### Max Capacity

This is the maximum battery capacity.

### Reset Voltage

If battery voltage reaches this value or higher for the predetermined reset time, capacity will reset to a maximum state.

### Reset Current

If battery current reaches this value or lower for the predetermined reset time, Capacity will reset to a maximum state.

### Reset Time

Timer for resetting battery capacity if reset voltage and/or reset current requirements are met.

### Charge Efficiency

The charge efficiency needs to be adjusted according to the condition of the batteries and temperature.

### Peukerts Exponent

Peukerts exponent or 'n' can be calculated using the formula on the previous page.

### Reset

This reset will put actual battery capacity back to a maximum state

## Tank

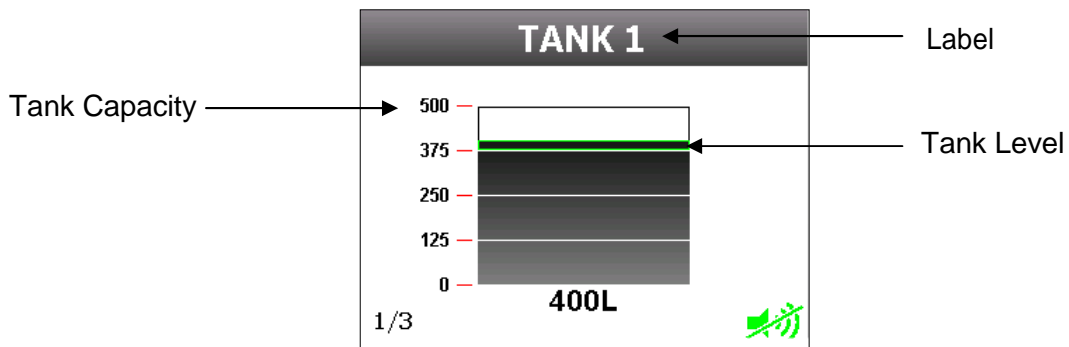

## Setup

Go to Main Menu > Setup > Input(s) > 'Choose Tank Input' > Settings

*Note: Tank inputs are configured for use with 0-5V senders. 10-180Ω and 240-33Ω senders must be used in conjunction with BEP 600-TLM-SIF.*

### Mode: Marking

Tank Calibration	
Volume	200L
Mode	MARKING
Empty	0.00V
12.5%	0.63V
25.0%	1.25V
37.5%	1.88V
50.0%	2.50V

#### Step 1

Enter the tank volume.

#### Step 2

There are 8 increments that need to be set. Divide the total tank volume by 8.

*Example: a 200 litre tank will be measured in 25 litre increments.*

#### Step 3

Start with an empty tank. Put the first increment of fluid calculated in step 2 into the tank. Select '12.5%' and 'Enter' to save the set point.

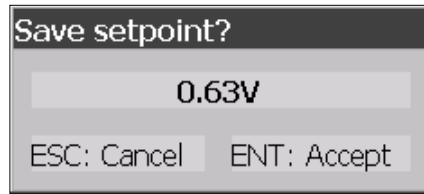

#### Step 4

Add the next increment of fluid calculated in step 2 into the tank. Select '25.0%' and then 'Enter' to save set point.

Repeat the process for 37.5%, 50%, 62.5%, 75%, 87.5% and Full.

#### Mode: Custom

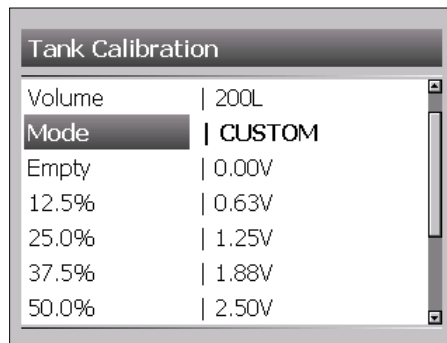

Use custom mode if the set point voltage values are already known from a previous tank meter setup. They can be directly entered without any other calculations.

## Systems In Operation

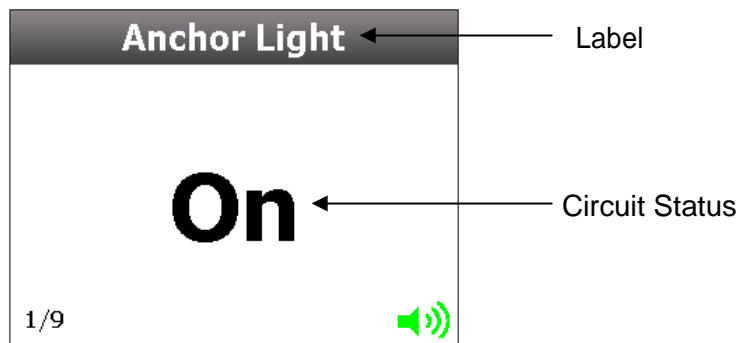

The systems in operation functions of this meter can be used to monitor essential circuits and inform the skipper about the circuit's state. Up to 8 inputs can be used as Systems Operation and they can all be displayed on the Mimic page for quick reference.

## Setup

The systems in operation inputs are factory set. If you need to alter the voltage calibration on any of the inputs see the DC Voltage Configuration section.

## Settings

Go to Main Menu > Setup > Input(s) > 'Choose SOM Input' > Settings

Som Calibration	
Input Voltage	12.0V
<b>Active State</b>	<b>Active High</b>
High Voltage	10.00V
Low Voltage	0.00V
Display on mimic	Yes
Mimic x, y	185, 61
Mimic color	Yellow

### Active State

This setting is how the meter decides the Circuit is on, either in Active High or Active Low.

### High Voltage

The volts value for an Active High State.

### Low Voltage

The volts value for an Active Low State.

### Display on Mimic

Each circuit can have it's own on or off indicator on the Mimic Page. Select 'Yes' to have this displayed.

### Mimic x, y

These are the co-ordinates where the indicator will be displayed on the Mimic page. Use the crosshairs to place the Indicator in the correct position.

### Mimic Colour

There is a wide range of indicator colours to choose from, ensure the chosen colour is not going to clash with the Mimic background image.

## Mimic

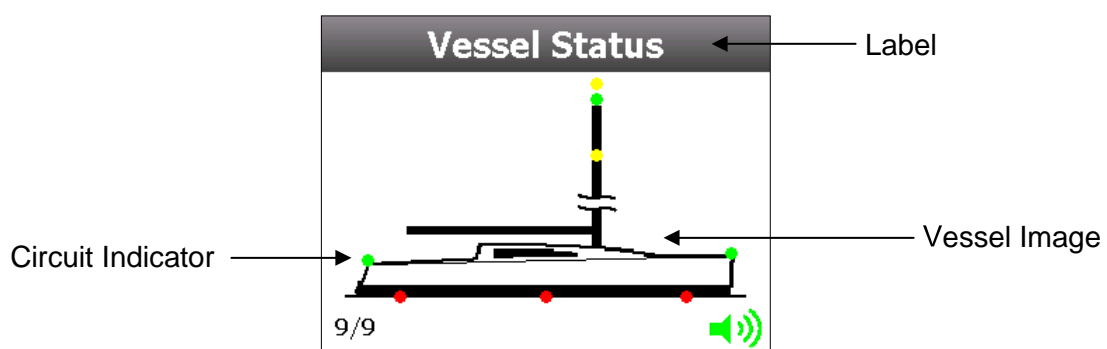

The Mimic page will give the user a view of all systems in operation circuits on a selectable boat image. The 5 default boat images can be chosen from the following:

- Traditional Yacht
- Modern Yacht
- Flybridge
- Sports Cruiser
- Trawler

The user can also upload there own image from a USB Memory stick.

*Note: All circuit indicator's are set on there respective SOM page. Refer to SOM Configuration section.*

## Setup

Go to Main Menu > Setup > Input(s) > 'Choose Mimic Page' > Settings > Image File

Select 'Default List' to choose between one of the default images.

Select 'New File' to upload image from USB device.

*Note: For the meter to recognise a custom image file, it has to be saved in 24 bit .BMP format and sized at 320 x 240 pixels.*

## Pump

Pump activity can be monitored by utilizing one or more of the 8 voltage inputs. Activity is monitored 24 hours, seven days a week. The number of operations and accumulated time of operation is stored for your information. It can be reset to zero when leaving the boat.

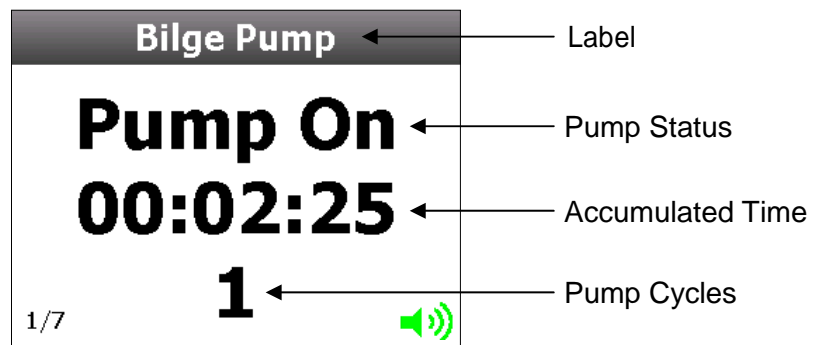

## Setup

Go to Main Menu > Setup > Input(s) > 'Choose Pump Input'

Pump settings are factory set, to enable a pump input just select 'Type' and then choose 'Pump'.

The pump will be all set up to start counting when in Active High state. When the pump goes from an Active High to an Active Low state, it is considered 1 cycle.

## Settings

Go to Main Menu > Setup > Input(s) > 'Choose Pump Input' > Settings

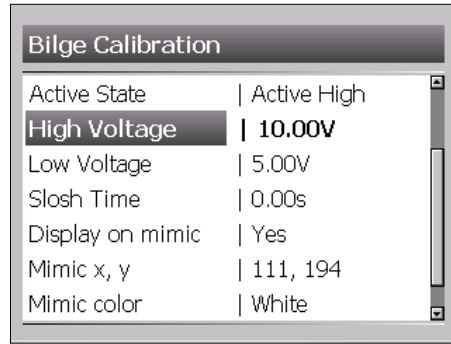

### Active State

The Active State is set to determine when the pump is on, either in Active High or Active low. When the voltage is equal to or greater than 'High Voltage' setting, it is considered Active High. When the voltage is equal to or less than 'Low Voltage' setting, it is considered Active Low.

### High Voltage

The volts value for an Active High state.

### Low Voltage

The volts value for an Active Low state.

### Slosh Time

Liquid sloshing around a pump can cause the pump to quickly turn on and off. The slosh time can be set to avoid recording these cycles.

### Display on Mimic

Each pump can have an on or off indicator on the Vessel Status Page. Select yes to enable the indicator.

### Mimic x, y

These are the co-ordinates where the indicator will be displayed on the Vessel Status page. Use the crosshairs to place the Indicator in the correct position.

### Mimic Colour

There is a wide range of indicator colours to choose from, ensure the chosen colour is not going to clash with the Mimic background image.

### Reset

This will reset the pump cycles and accumulated time back to zero.

## Alarms

All inputs have the ability to have a high or low warning alarm. Depending on what type of meter configuration you are running, some of these alarms will be enabled by default.

### Answering Alarms

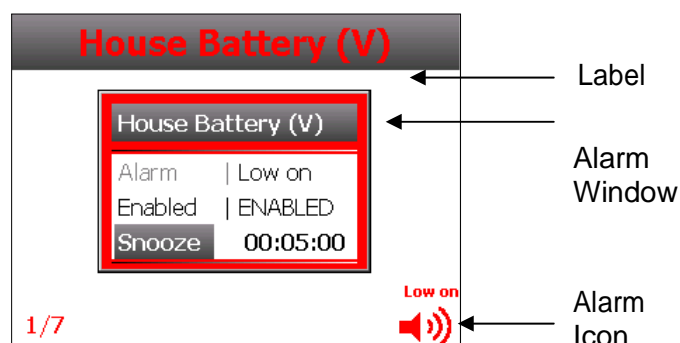

When an alarm is active you will see an Alarm Window for each active alarm and the buzzer/external alarm will sound. The Alarm Window will tell you which input is alarming and what type of alarm it is i.e. Low On or Low Voltage. The label for all alarming circuits will be red also.

To remove the Alarm Window from the Status Page you have 2 options:

### **Disable the alarm**

You will get no further alarms from this input until it is re-enabled.

### **Snooze the alarm**

The alarm will go in to snooze mode for the default time and will pop up again when the timer expires and the input is still in an alarm state.

If there is more than one alarming circuit, a new Alarm Window will pop up after the previous alarm is acknowledged.

*Note: to avoid unwanted alarms on meter start up there is a 20 second delay after status screen is loaded when alarms will not be active.*

## **Alarm Icons**

The Alarm Icon is a global warning and does not refer to any individual alarms. The meaning of the icons is explained below:

### **Alarm Icons**

### **Description**



Alarms Enabled / No Alarm Active



Alarms Enabled / Alarm Active



Alarms Disabled



Alarms Disabled / Muted



Alarms Enabled / Muted

## **Configuring Alarms**

All inputs have two alarm parameters that can be set, a High Level and Low Level. The units will change depending on what type of input is being configured.

*Note: If only 1 alarm is needed, say a Low Level and not a High Level, enter a unit of Zero for the unused alarm.*

## **Global Alarm Settings**

Go to Main Menu > Alarms to see the status of all enabled alarms.



Enabled Alarms Status	
Global alarms	Enabled
House Battery (V)	Low on
Start Battery (V)	Low on
Aux Battery (V)	Low on
House Battery (A)	Off
Start Battery (A)	Off

## Global Alarms

Use this setting to disable or enable all alarms.

*Note: This overwrites all enabled alarms so you will not receive any further warnings until global alarms are enabled again.*

## Input Alarm Settings

Go to Main Menu > Setup > Input(s) > 'Choose Input' > Alarm

Alarm Setup	
Enabled	ENABLED
Type	BEEP
Mute	NO
Snooze	00:00:00
Default Snooze	00:05:00
High Level	15.0V
Low Level	11.0V

### Enabled

Use this setting to disable the alarms for the selected input. All other alarms will remain enabled.

### Type

This is the type of sound the buzzer produces on alarm. It can be a Beep or Constant alarm.

### Mute

Use this setting to mute the alarms for the selected input. All other alarms will remain unmuted.

### Snooze

This is a non selectable option. When alarm is in snooze mode it will show the countdown of remaining snooze time.

### Default Snooze

Use this setting to change the default snooze time for selected input. Default is 5 minutes but can be changed from 1, 5 and 10 minutes or a custom value.

### High Level

This is the High Level Alarm for the chosen circuit. The units will default to the type of input chosen i.e. Volts, Amps.

### Low Level

This is the Low Level Alarm for the chosen circuit. The units will default to the type of input chosen i.e. Volts, Amps.

## 4. Settings

### Display Settings

Choose Main Menu > Setup > Display to access Display Settings

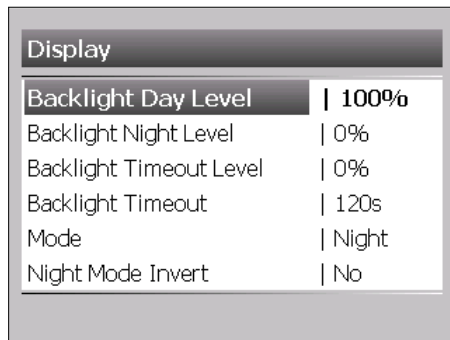

Display	
Backlight Day Level	100%
Backlight Night Level	0%
Backlight Timeout Level	0%
Backlight Timeout	120s
Mode	Night
Night Mode Invert	No

#### Backlight Day Level

The backlighting level for when meter is set to Day Mode. Set as a percentage between 0-100%. 100% being the brightest.

#### Backlight Night Level

The backlighting level for when meter is set to Night Mode. Set as a percentage between 0-100%. 100% being the brightest.

#### Backlight Timeout Level

The backlighting level for when meter is running in Timeout Mode. Set as a percentage between 0-100%. 100% being the brightest.

#### Backlight Timeout

This is the time from last user input to when the backlighting dims to the Timeout Level (set above). A lower value is recommended to reduce current draw when meter is not in use.

#### Mode

Use this option to toggle between Day and Night Modes.

#### Night Mode Invert

When set to Yes, the display colours will invert when changed to Night Mode.

### Status Pages

Choose Main Menu > Setup > Status Pages to access Status Page settings

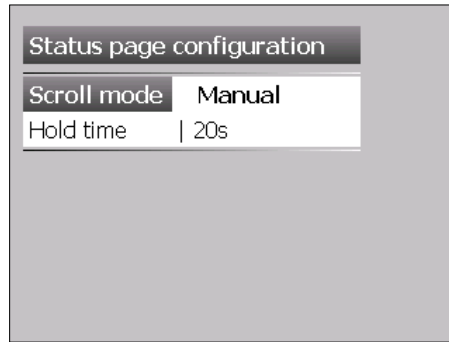

## Scroll Mode

The scroll mode is how the meter changes from one Status Page to the next. Manual mode requires the user to press the Up or Down button to move through pages. Automatic mode will change between pages at a predetermined hold time (see below).

## Hold Time

The hold time is the time it takes for the meter to change from one Status Page to the next in Automatic Scroll mode.

## Inputs

Choose Main Menu > Setup > Input(s) to access Input Settings.

The main input configuration screen shows all inputs with their associated pin/connector number next to it. Enabled inputs are black, disabled inputs are grey.

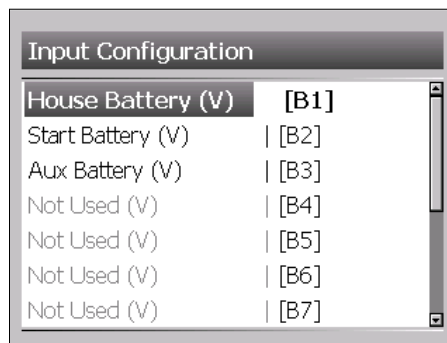

Press Enter on the input you would like to configure. The input settings will vary depending on what type of Input you are using.

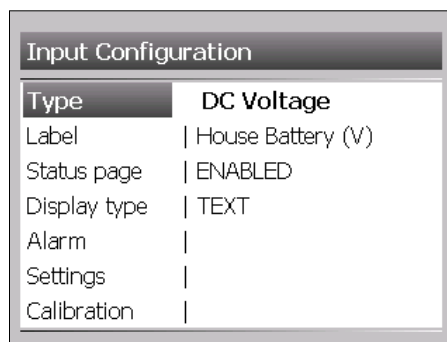

## Type

There are 5 types of inputs that are assigned to specific pins (DC Voltage, DC Current, Pump, Tank & SOM). There are also 2 different page views that take data from designated Inputs and display as Text or Graphics (Mimic & Battery). Below is a Table to show the relation between Page Number, Pin Number and Input Type:

Page	Pin	Input Type
1	B1	DC Voltage/Pump/Tank/SOM
2	B2	DC Voltage/Pump/Tank/SOM
3	B3	DC Voltage/Pump/Tank/SOM
4	B4	DC Voltage/Pump/Tank/SOM
5	B5	DC Voltage/Pump/Tank/SOM
6	B6	DC Voltage/Pump/Tank/SOM
7	B7	DC Voltage/Pump/Tank/SOM
8	B8	DC Voltage/Pump/Tank/SOM
9		Mimic
10	A5-6	DC Current
11	A7-8	DC Current
12		Battery
13		Battery

*Note: Page numbers will change depending on how many inputs are enabled. For instance, if only Inputs B1, B2 & B3 are Enabled, then the Mimic will be on Page 4.*

### Label

The input label can be selected from a list of input specific standard labels, or a custom label using the onscreen keyboard.

### Status Page

Select enabled to have the input shown on a Status Page. Select disabled and the meter will keep all the settings for that input but it will not be shown on a Status Page.

### Display Type

There are 4 Display Types that can be chosen from. Not all Display Types are available on all inputs.

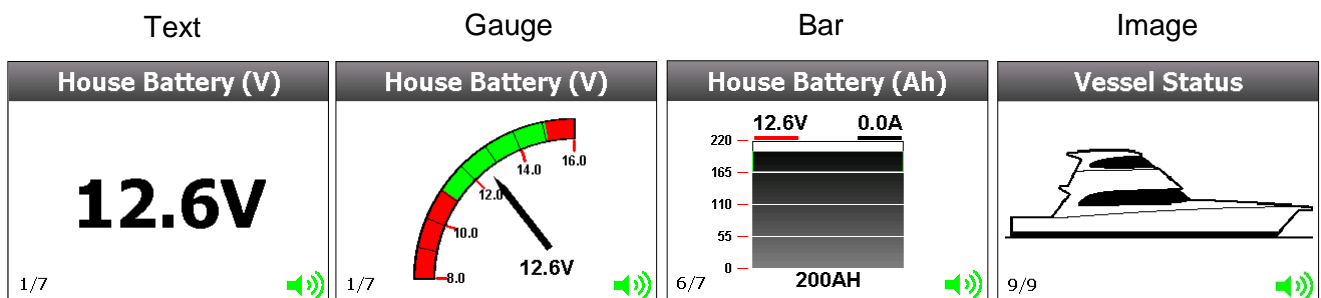

Below is a table showing what Display Types are available for each Input Type

Input Type	Display Type
DC Voltage	Text, Gauge
DC Current	Text, Gauge
Pump	Text
Tank	Text, Gauge, Bar
SOM	Text
Mimic	Text, Image
Battery	Text, Bar

## Alarm

Refer to Alarm Configuration section.

## Settings

The Settings options are specific to the Input Type. Refer to the Configuration section for more detail.

## Calibration

The Calibration options are specific to the Input Type. Refer to the Configuration section for more detail.

## System

Choose Main Menu > Setup > System to access System Settings

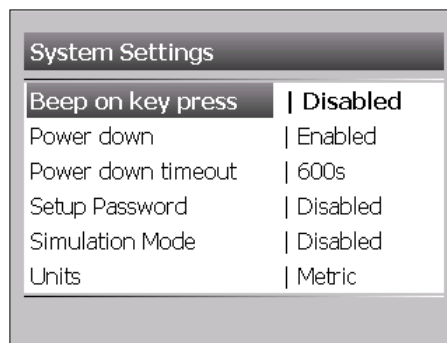

### Beep on Key Press

Selecting disabled will stop the meter from beeping on every key press.

### Power Down

Power Down will put the meter in to a low power state after a predetermined time. This will include shutting down the LCD screen. The meter will exit power down mode at any key press.

### Power Down Timeout

This is the time from last user input to when the meter enters power down mode.

### Setup Password

The password feature will protect the meter from unnecessary modifications. When any settings are modified and the save prompt window opens, the password will need to be entered.

To set up a new password select 'Setup Password' and then 'New Password'. The password will need to be entered twice for confirmation. Once this is done the new password will be set up.

To disable the password select 'Setup Password' and then 'Disable'. The current password will need to be entered again to disable it.

*Note: Passwords are case sensitive*

## Simulation Mode

Simulation Mode is used for demonstration purposes. When in simulation mode the units will change to random values showing moving gauge needles, bar graphs and voltage/current text values.

## Units

The Units of Measure will change how tank values are displayed. It can be chosen from Metric (Litres), English (Gallons) and US (Gallons).

## Utilities

Choose Main Menu > Setup > Utilities to access Utilities Settings

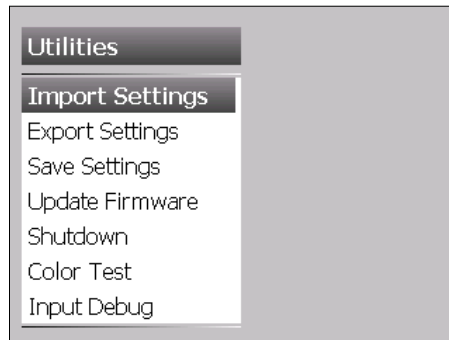

## Import/Export Settings

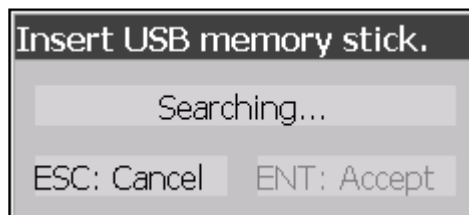

User settings can be saved onto a Memory/Flash USB Device for back up purposes or upgrading other meters.

Insert a supported memory stick into the USB Socket.

## Exporting Settings

Select Export Settings. It will take a few seconds for the meter to search for the device. Once the device has been found select Accept. The user will be prompted to enter the filename. The default filename is 'user.ini' so this filename or a custom filename can be chosen.

*Note: If there is already a file with the same name on the memory stick, please choose another filename.*

## Import Settings

Select Import Settings. Choose the file you would like to use, there may be more than one depending on how many times the settings have been exported. Select Yes to upgrade meter.

*Note: All stored settings will be lost when importing from memory stick so take caution before upgrading.*

## Save Settings

The Save Settings function will save all current changes to the meter settings file.

## Update Firmware

To ensure your meter is using the latest software, please check the BEP Marine website regularly.

To find out the current firmware version choose Main Menu > Setup > About.

To upgrade firmware insert memory stick in to USB socket with preloaded firmware named 'application.tar.gz'. Follow the onscreen prompts until meter has finished upgrading and performed a reboot.

*Note: It is very important not to disconnect power supply from meter during a firmware upgrade as it can cause the meter to become unusable.*

## Shutdown

This option will shut down the meter completely. Turn the meter supply off and then on again for a reboot.

## Colour Test

General colour test for LCD screen.

## Factory Reset

At any time the meter can be restored to a factory state. This can be very helpful if settings have been corrupted or the meter needs to be used in another application i.e. changing a DCM to a SOM.

If the meter will not boot to a status page or the settings become corrupted reboot the meter and hold the Down button. This will bring up the 'Utilities' menu where a Factory reset can be performed.

*Note: Please be aware that all stored settings will be erased when doing a factory reset.*

## Input Debug

Use this function to see a technical overview of all inputs.

# Programming Menu Flow Diagram

