

**BEP**

---

# 600-ACSM

## AC SYSTEMS MONITOR

Installation and Operating Instructions

# 1. Basics

## WARNING AND CAUTION

### WARNING

WARNING refers to possible injury to the user or significant damage to the meter if the user does not follow the procedures.

### CAUTION

CAUTION refers to restrictions and rules with regard to preventing damage.

### WARNING

Verify that all AC sources are disconnected before connecting or disconnecting the current transformer. Failure to do so will generate lethal voltages on the current transformer.

If you are not knowledgeable about electrical systems, have an electrical professional install this unit. The diagrams in these instructions pertain to the installation of the 600-ACSM and not to the overall wiring of the vessel.

If an inverter is installed on the vessel, its power leads must be disconnected at the battery before the unit is installed. Many inverters have a 'sleep mode' in which their voltage potential may not be detectable with measuring equipment.

If an inverter is installed on the vessel, it must be stopped and rendered inoperable before the unit is installed.

Verify that no other DC or AC is connected to the vessels wiring before installing the unit.

If the meter must be removed, connect the current transformer leads together before restoring power to the AC system.

### CAUTION

The back of the unit is not waterproof. Do not install where the back of the meter is exposed to water.

## Features

The 600-ACSM Monitor offers the following features:

- 2.8" TFT LCD 16 Bit colour screen.
- 4 button user interface with white backlighting.
- Voltage monitoring for up to three AC voltage inputs, 0-300V AC RMS
- Frequency of each AC voltage input.
- Current monitoring for up to three AC current inputs, 0-120A AC RMS
- selectable legends eg: Ships Power, Shore Power etc.
- Hi/Low Voltage, Current and Power alarms with adjustable set points and snooze timers.
- Load shedding relay output with adjustable set point times.
- Adjustable backlighting, backlighting on with key press, input for external dimming control.
- Remote alarm output.
- Load shedding relay input.
- Splash proof design.

The 600-ACSM is designed to be surface mounted or recessed into a 2.5mm panel

## Specifications

### General

Power Source	8-32V DC
Max. Current Consumption	140mA
Min. Current Consumption	90mA (Powerdown)

### Input Specifications

AC Voltage	0-300V AC
AC Current	0-120A AC
Backlighting Control Input	0-32V DC
Loadshed Relay Output	1A <sub>MAX</sub> @ 12 V DC Sink to ground
Remote Alarm Output	1A <sub>MAX</sub> @ 12 V DC Sink to ground

### USB

Specification	USB 2.0 full speed
File System	FAT, FAT32

# Hardware Layout

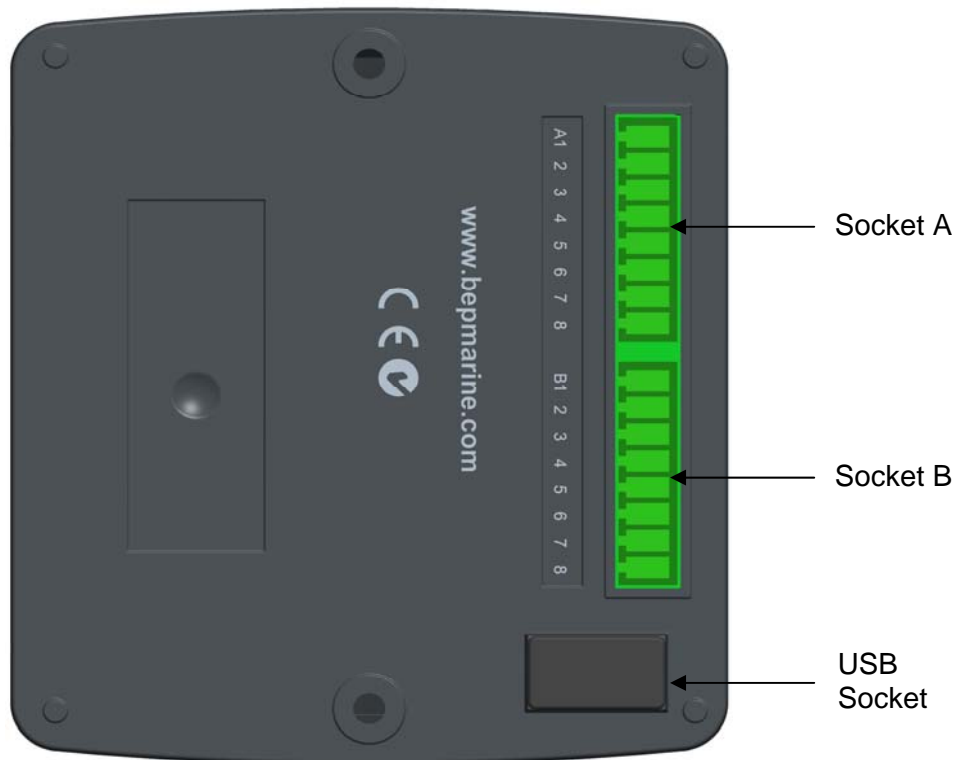
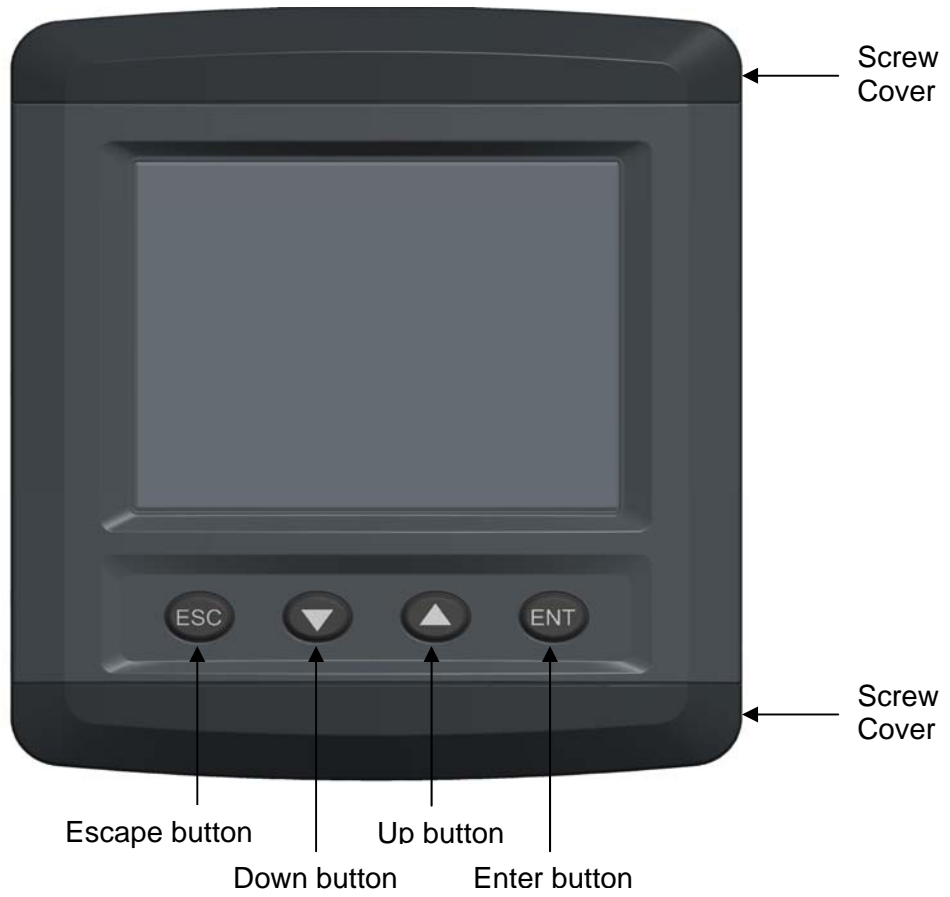

## Button Function

### Escape Button

Exits from the page or menu you are currently on and brings up the previous page or menu.

### Down Button

Moves down in page number or down the list on a menu. When inputting text button moves cursor to the left.

### Up Button

Moves up in page number or up the list on a menu. When inputting text button moves cursor to the right.

### Enter Button

Brings up 'Main menu' from any of the status pages. Enters the desired selection from a menu. Enters selected character on a calibration page.

## Status Page

A Status Page is the first screen that the meter will show after booting. To navigate through the enabled status pages press the '**Up**' or '**Down**' button.



### Label

All inputs have a label assigned to it for identification. It can be chosen from a preset list of labels or custom set using the onscreen keyboard.

### Page Numbers

Every time you enable an input to a status page it will be given a page number.

## Alarm Icon

The alarm icon is a visual warning to show the status of all alarms. Green means no alarm, red means alarming.

For more information on alarms & alarm icons refer to the Alarms Configuration section.

## Onscreen Keyboard

Use the onscreen keyboard to enter text such as custom labels, numerical values for Voltage, Amps and Timer values. The two types of keyboards are listed below:

### Text/Numeric Keyboard (Custom Labels)

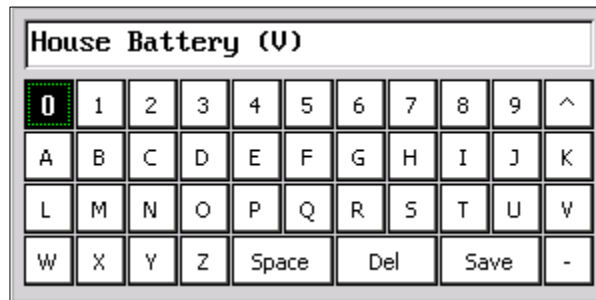

### Step 1

Press the meters **Up** or **Down** button to move the selection box to the character of choice then press the **Enter** button to accept. Any existing labels will be overwritten by first character input.

*Tip. To quickly move selection box through the keyboard press and hold the **Up** or **Down** buttons.*

### Step 2

Repeat Step 1 until the required label is finished. If there are any mistakes select 'Del' to delete the previous character. Note the text will change from Upper to Lower case after the first character is input.



Press this button to toggle between Upper and Lower case text.

### Step 3

Select the **Save** button to accept the desired Label and exit the keyboard screen. If you are not happy with the label, press **Esc** to cancel and revert to the previous label.

Note the label will not be saved until you accept the Save Settings prompt when you exit to the Main Screen.

### Numeric Keyboard (High/Low Levels/Timers)

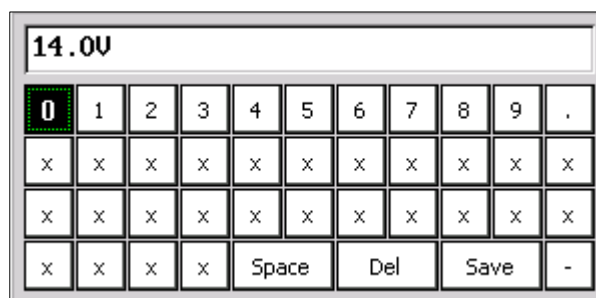

When prompted to change a numerical value for High/Low Limits, Current/Voltage settings, you will see a Numerical keyboard. It is used exactly the same as the Text/Numeric Keyboard. Note, the unit of measure (V,A etc) does not need to be entered. It is set by default.

## Saving

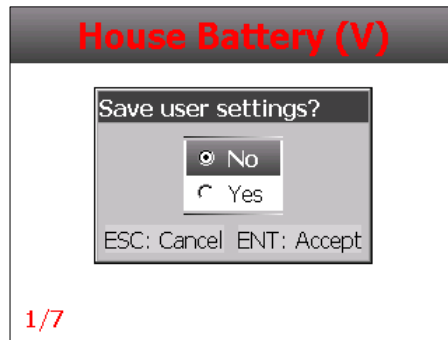

When any meter settings have been changed a save settings prompt will open when exiting to the main screen.

Selecting 'yes' will overwrite the user settings file with these changes, selecting 'no' will keep the changes, however the user settings file will not be overwritten and meter will revert back to last save on power up.

*Note: Refer to the Settings chapter for more information on user settings.*

# Dimensions

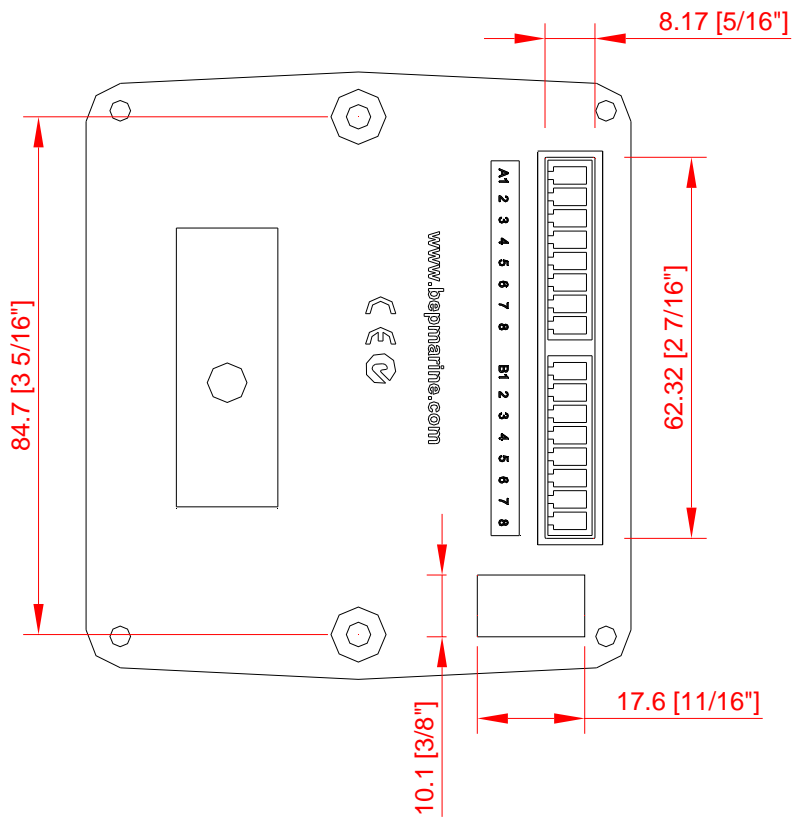
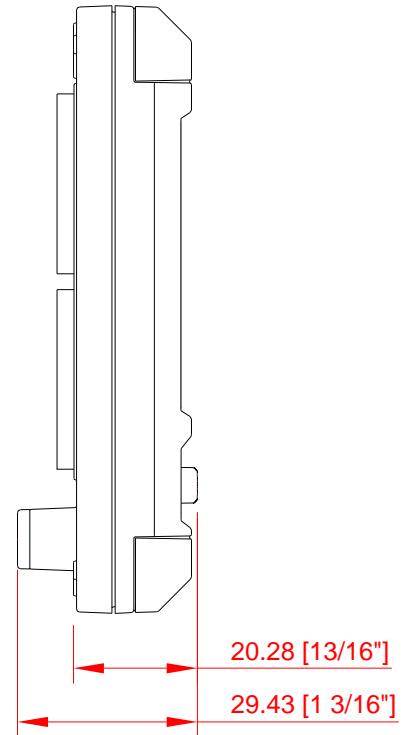
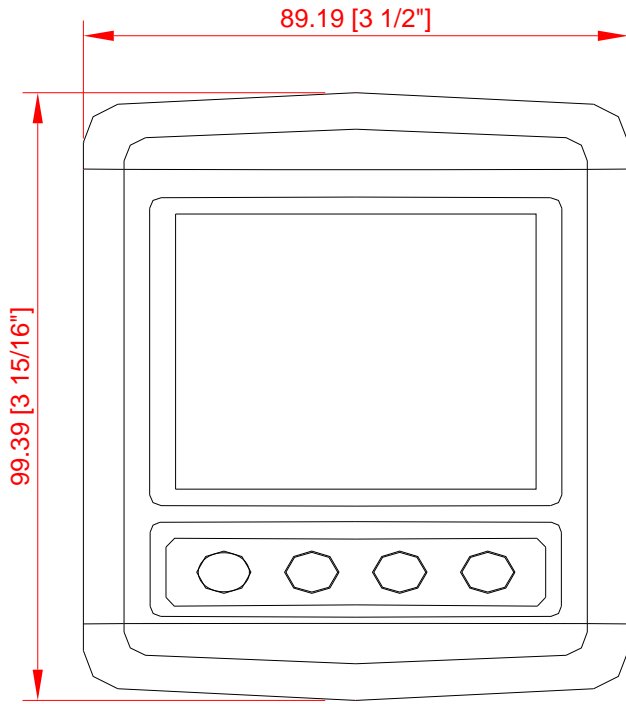



## 2. Installation

### Plug Information.

PIN	FUNCTION
A1	Positive DC supply from battery (8 to 32V DC)
A2	Negative DC supply from battery (8 to 32V DC)
A3	Remote alarm output (1A @ 12V DC)
A4	Backlight Control input (0 to 32V DC)
A5	Load shedding relay input (1A @ 12V DC)
A6	
A7	Current 3, black negative wire CT-10-3
A8	Current 3, red positive wire CT-10-3 (0-120A AC RMS)
B1	
B2	Current 2, black negative wire CT-10-3
B3	Current 2, red positive wire CT-10-3 (0-120A AC RMS)
B4	Current 1, black negative wire CT-10-3
B5	Current 1, red positive wire CT-10-3 (0-120A AC RMS)
B6	Voltage 3, red positive wire AC-VSEN-4 (0-300V AC)
B7	Voltage 2, red positive wire AC-VSEN-4 (0-300V AC)
B8	Voltage 1, red positive wire AC-VSEN-4 (0-300V AC)

# Wiring Diagram

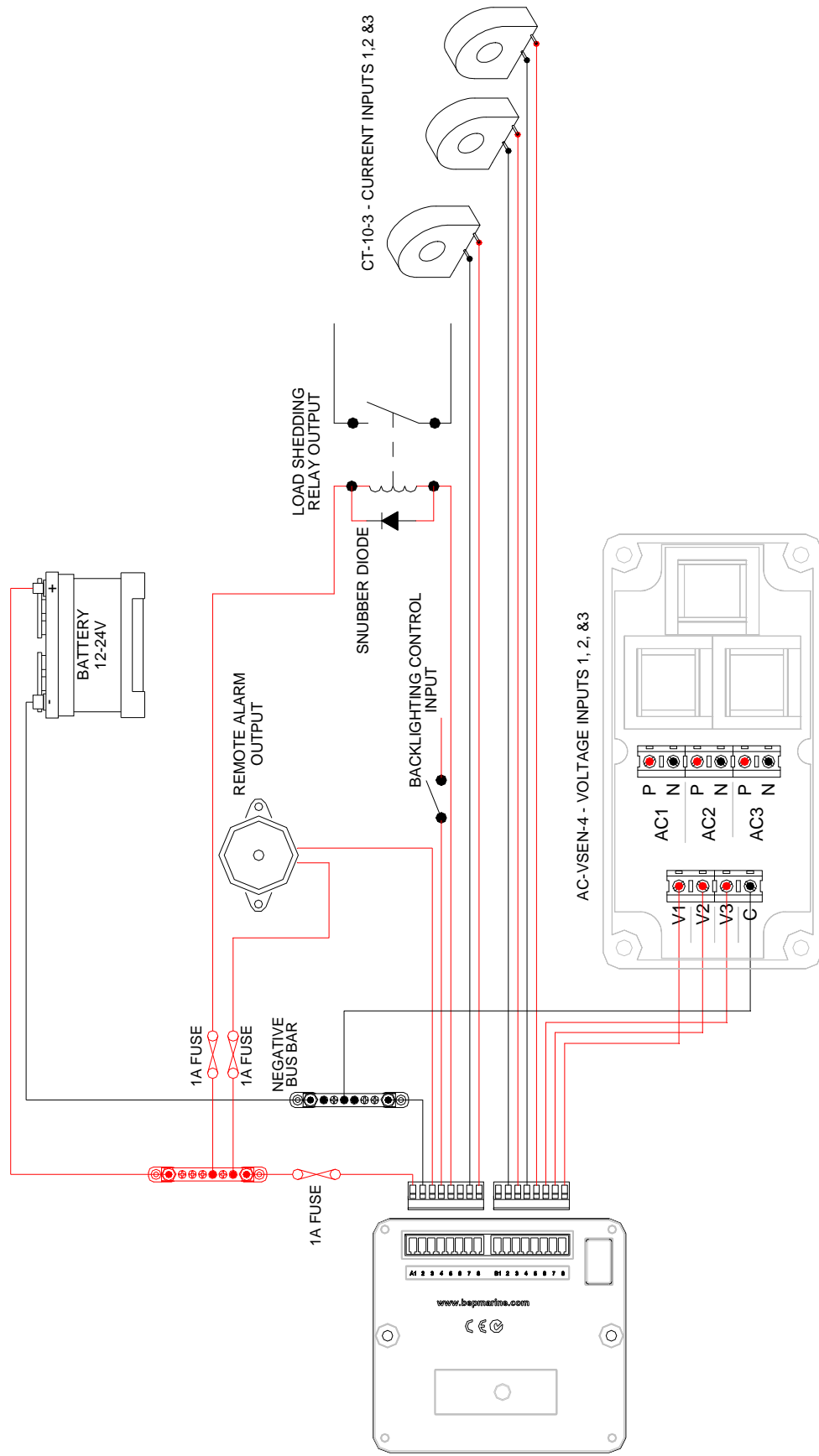

# 3. Configuration

## AC Voltage

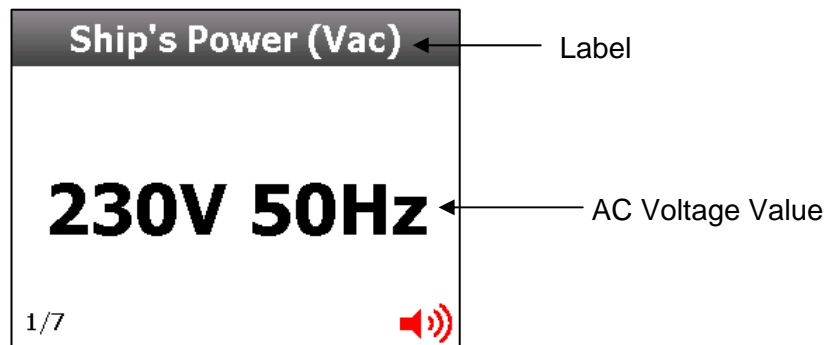

## Voltage Calibration

Voltage Calibration is factory set. If you need to alter the calibration follow the steps below:

Go to Main Menu > Setup > Input(s) > 'Choose Voltage Input' > Calibration.

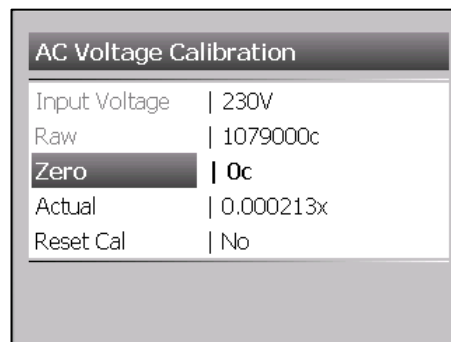

### Step 1

Insert a ground wire into the pin of the input you are configuring. Select 'Zero' on the meter and then select 'Yes'.

### Step 2

Remove ground and then wire the Input (AC Positive) into the same pin.

### Step 3

Check voltage using a calibrated voltmeter, when 'Input Voltage' is in a steady state select 'Actual' and enter the correct voltage and then select 'Save'.

## Settings

Go to Main Menu > Setup > Input(s) > 'Choose Voltage Input' > Set

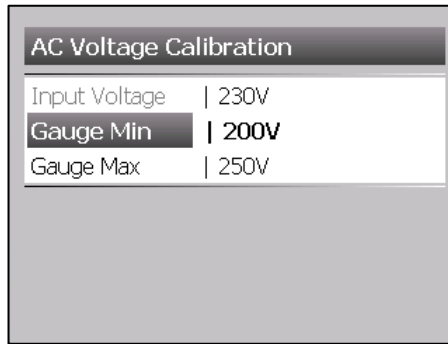

### Gauge Min

This is the minimum scale for Gauge View

### Gauge Max

This is the maximum scale for Gauge View

## AC Current

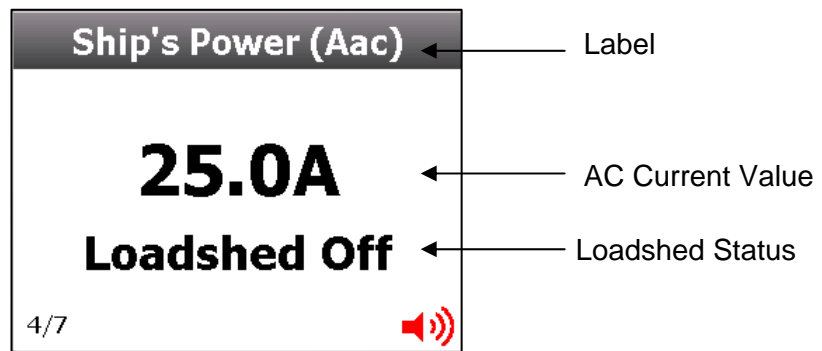

## Current Calibration

Current Calibration is factory set. If you need to alter the calibration follow the steps below:

Go to Main Menu > Setup > Input(s) > 'Choose Current Input' > Calibration

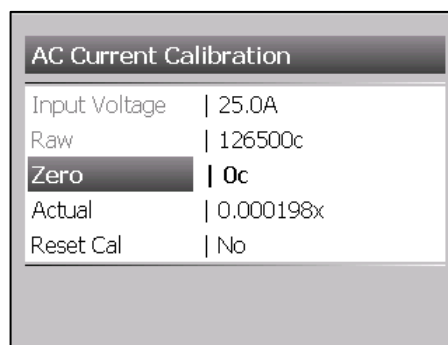

### Step 1

Select 'Zero'. Ensure there is zero current then select 'Yes' to confirm.

### Step 2

Turn on a steady load on the line you are calibrating i.e. lights. The maximum load possible will give the best results. Please wait for at least 10 seconds for the 'Raw' value to settle, then check current draw with a calibrated Ammeter at the CT.

### Step 3

Select 'Actual' and enter the correct current value and then select 'Save'.

### Settings

Go to Main Menu > Setup > Input(s) > 'Choose Current Input' > Settings

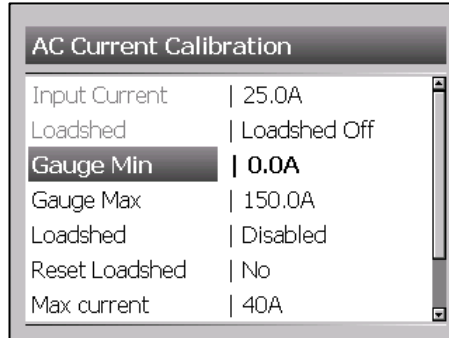

### Gauge Min

This is the minimum scale for Gauge View.

### Gauge Max

This is the maximum scale for Gauge View.

### Configuring Loadshed relay operation.

All three 'Current' status pages have the ability to drive the Loadshed relay output on the back of the meter.

This is provided so the operator can automatically drop a **NON-ESSENTIAL** section of their AC loads. Preventing a current rise to a level that will overload the ships generators and cause the Circuit Breaker to trip and lose power to all AC consumers.

Wire the Loadshed relay as per the 'Wiring Diagram' at the front of the booklet, please note that a snubber diode is required to be fitted across the relay coil for inductive loads.

Each 'Current' status page can be set at a different level but please note the output will be active from the first 'Loadshed' becoming active until the last one clears.

To set the 'Loadshed' value, navigate to, 'Main Menu' > 'Setup' > 'Input' "required current status page" > 'Settings' > 'Max Current'.

A default value of 40A is preset. Select 'Max Current' then enter then required value.

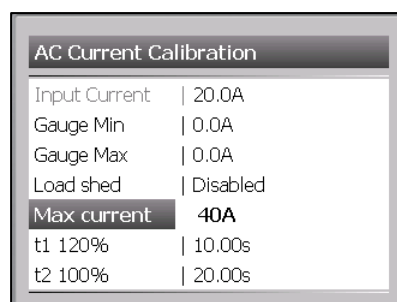

The Load shed current has two timers the first one of which to expire will activate the Load shed relay output.

The timers begin counting at different current levels and continue to count as long as current stays above the set point. If at any point the current drops below the measuring point the timer will reset.

The first t1 begins counting as current rises above 120% of Max current. t2 begins counting when current rises above 100% of Max current.

The counter times are set to default values. These can be changed by the following method.

**Step 1.** From the 'AC Current Calibration' select 't1 120% and/or t2 100%'.

**Step 2.** Use the soft keyboard to enter new timer value.

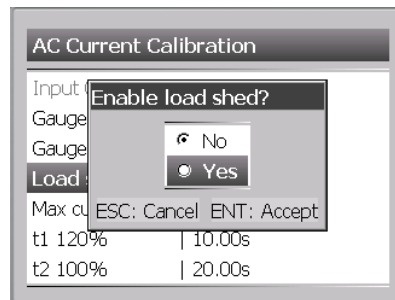

**Step 3.** When both the timers have been set you are able to 'Enable Load Shed' at the 'Load shed' function.

## Alarms

All inputs have the ability to have a high or low warning alarm. Depending on what type of meter configuration you are running, some of these alarms will be enabled by default.

### Answering Alarms

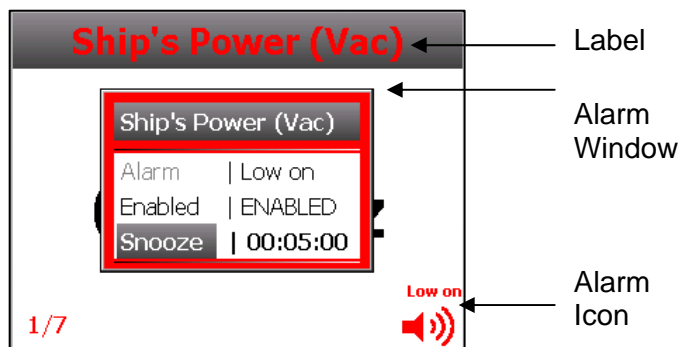

When an alarm is active you will see an Alarm Window for each active alarm and the buzzer/external alarm will sound. The Alarm Window will tell you which input is alarming and what type of alarm it is i.e. Low On or Low Voltage. The label for all alarming circuits will be red also.

To remove the Alarm Window from the Status Page you have 2 options:

#### Disable the alarm

You will get no further alarms from this input until it is re-enabled.

#### Snooze the alarm

The alarm will go in to snooze mode for the default time and will pop up again when the timer expires and the input is still in an alarm state.

If there is more than one alarming circuit, a new Alarm Window will pop up after the previous alarm is acknowledged.



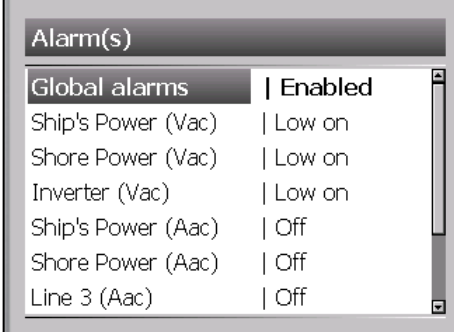

*Note: to avoid unwanted alarms on meter start up there is a 20 second delay after status screen is loaded when alarms will not be active.*



Alarm(s)	
Global alarms	Enabled
Ship's Power (Vac)	Low on
Shore Power (Vac)	Low on
Inverter (Vac)	Low on
Ship's Power (Aac)	Off
Shore Power (Aac)	Off
Line 3 (Aac)	Off

## Alarm Icons

The Alarm Icon is a global warning and does not refer to any individual alarms. The meaning of the icons is explained below:

Icons	Icon Colour	Description
	Green	Alarms Enabled / No Alarm Active
	Red	Alarms Enabled / Alarm Active
	Grey	Alarms Disabled
	Red or Green	Alarms Muted

## Configuring Alarms

All inputs have two alarm parameters that can be set, a High Level and Low Level. The units will change depending on what type of input is being configured.

*Note: If only 1 alarm is needed, say a Low Level and not a High Level, enter a unit of Zero for the unused alarm.*

## Global Alarm Settings

Go to Main Menu > Alarms to see the status of all enabled alarms.

## Global Alarms

Use this setting to disable or enable all alarms.

*Note: This overwrites all enabled alarms so you will not receive any further warnings until global alarms are enabled again.*

## Input Alarm Settings

Go to Main Menu > Setup > Input(s) > 'Choose Input' > Alarm

Alarm	
Enabled	ENABLED
Type	BEEP
Mute	NO
Snooze	00:00:00
Default Snooze	00:05:00
High Level	245V
Low Level	215V

### Enabled

Use this setting to disable the alarms for the selected input. All other alarms will remain enabled.

### Type

This is the type of sound the buzzer produces on alarm. It can be a Beep or Constant alarm.

### Mute

Use this setting to mute the alarms for the selected input. All other alarms will remain unmuted.

### Snooze

This is a non selectable option. When alarm is in snooze mode it will show the countdown of remaining snooze time.

### Default Snooze

Use this setting to change the default snooze time for selected input. Default is 5 minutes but can be changed from 1, 5 and 10 minutes or a custom value.

### High Level

This is the High Level Alarm for the chosen circuit. The units will default to the type of input chosen i.e. Volts, Amps.

### Low Level

This is the Low Level Alarm for the chosen circuit. The units will default to the type of input chosen i.e. Volts, Amps.



# 4. Settings

## Display Settings

Choose Main Menu > Setup > Display to access Display Settings

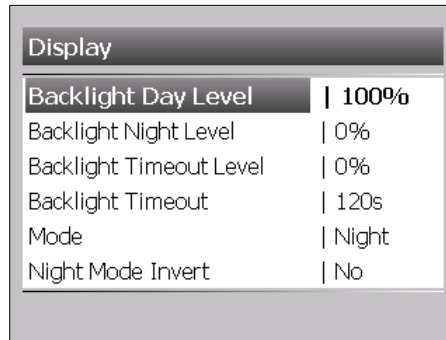

Display	
Backlight Day Level	100%
Backlight Night Level	0%
Backlight Timeout Level	0%
Backlight Timeout	120s
Mode	Night
Night Mode Invert	No

### Backlight Day Level

The backlighting level for when meter is set to Day Mode. Set as a percentage between 0-100%. 100% being the brightest.

### Backlight Night Level

The backlighting level for when meter is set to Night Mode. Set as a percentage between 0-100%. 100% being the brightest.

### Backlight Timeout Level

The backlighting level for when meter is running in Timeout Mode. Set as a percentage between 0-100%. 100% being the brightest.

### Backlight Timeout

This is the time from last user input to when the backlighting dims to the Timeout Level (set above). A lower value is recommended to reduce current draw when meter is not in use.

### Mode

Use this option to toggle between Day and Night Modes.

### Night Mode Invert

When set to Yes, the display colours will invert when changed to Night Mode.

## Status Pages

Choose Main Menu > Setup > Status Pages to access Status Page settings

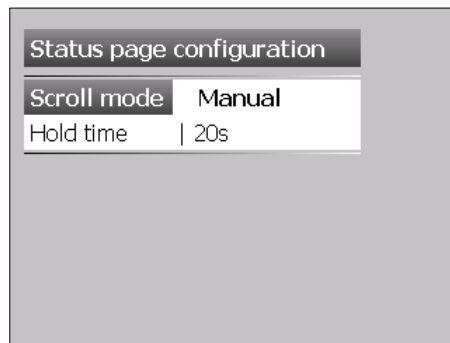

### Scroll Mode

The scroll mode is how the meter changes from one Status Page to the next. Manual mode requires the user to press the Up or Down button to move through pages. Automatic mode will change between pages at a predetermined hold time (see below).

### Hold Time

The hold time is the time it takes for the meter to change from one Status Page to the next in Automatic Scroll mode.

## Inputs

Choose Main Menu > Setup > Input(s) to access Input Settings.

The main input configuration screen shows all inputs with their associated pin/connector number next to it. Enabled inputs are black, disabled inputs are grey.

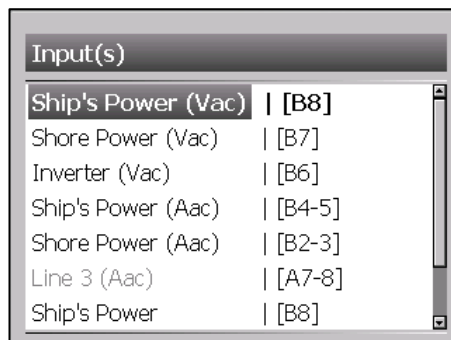

Press Enter on the input you would like to configure. The input settings will vary depending on what type of Input you are using.

Input Configuration	
Type	AC Voltage
Label	Ship's Power (Vac)
Status page	ENABLED
Display type	TEXT
Alarm	
Settings	
Calibration	

### Label

The input label can be selected from a list of input specific standard labels, or a custom label using the onscreen keyboard.

### Status Page

Select enabled to have the input shown on a Status Page. Select disabled and the meter will keep all the settings for that input but it will not be shown on a Status Page.

### Display Type

There are 2 Display Types that can be chosen from. Not all Display Types are available on all inputs.

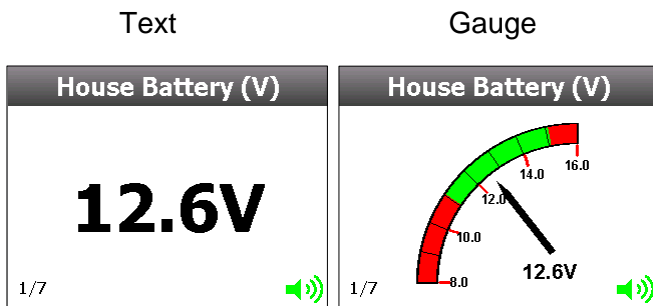

Below is a table showing what Display Types are available for each Input Type

Input Type	Display Type
AC Voltage	Text, Gauge
AC Current	Text, Gauge
Power	Text

### Alarm

Refer to Alarm Configuration section.

### Settings

The Settings options are specific to the Input Type. Refer to the Configuration section for more detail.

### Calibration

The Calibration options are specific to the Input Type. Refer to the Configuration section for more detail.

## System

Choose Main Menu > Setup > System to access System Settings

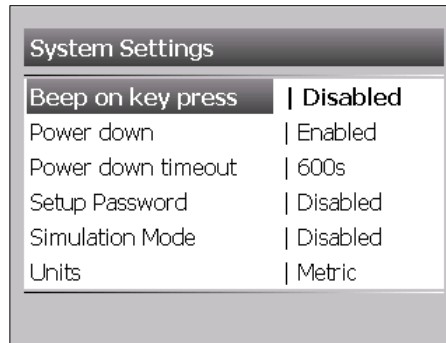

System Settings	
Beep on key press	Disabled
Power down	Enabled
Power down timeout	600s
Setup Password	Disabled
Simulation Mode	Disabled
Units	Metric

### Beep on Key Press

Selecting disabled will stop the meter from beeping on every key press.

### Power Down

Power Down will put the meter in to a low power state after a predetermined time. This will include shutting down the LCD screen. The meter will exit power down mode at any key press.

### Power Down Timeout

This is the time from last user input to when the meter enters power down mode.

### Setup Password

The password feature will protect the meter from unnecessary modifications. When any settings are modified and the save prompt window opens, the password will need to be entered.

To set up a new password select 'Setup Password' and then 'New Password'. The password will need to be entered twice for confirmation. Once this is done the new password will be set up.

To disable the password select 'Setup Password' and then 'Disable'. The current password will need to be entered again to disable it.

*Note: Passwords are case sensitive*

### Simulation Mode

Simulation Mode is used for demonstration purposes. When in simulation mode the units will change to random values showing moving gauge needles, bar graphs and voltage/current text values.

### Units

The Units of Measure will change how tank values are displayed. It can be chosen from Metric (Litres), English (Gallons) and US (Gallons).

## Utilities

Choose Main Menu > Setup > Utilities to access Utilities Settings

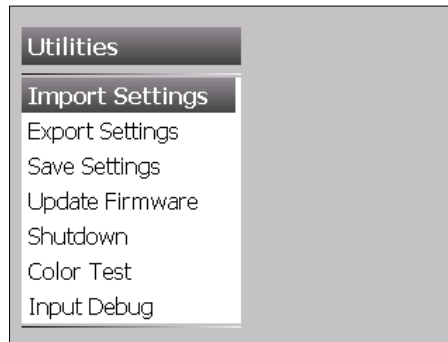

### Import/Export Settings



User settings can be saved onto a Memory/Flash USB Device for back up purposes or upgrading other meters.

Insert a supported memory stick into the USB Socket.

### Exporting Settings

Select Export Settings. It will take a few seconds for the meter to search for the device. Once the device has been found select Accept. The user will be prompted to enter the filename. The default filename is 'user.ini' so this filename or a custom filename can be chosen.

*Note: If there is already a file with the same name on the memory stick, please choose another filename.*

### Import Settings

Select Import Settings. Choose the file you would like to use, there may be more than one depending on how many times the settings have been exported. Select Yes to upgrade meter.

*Note: All stored settings will be lost when importing from memory stick so take caution before upgrading.*

### Save Settings

The Save Settings function will save all current changes to the meter settings file.

### Update Firmware

To ensure your meter is using the latest software, please check the BEP Marine website regularly.

To find out the current firmware version choose Main Menu > Setup > About.

To upgrade firmware insert memory stick in to USB socket with preloaded firmware named 'application.tar.gz'. Follow the onscreen prompts until meter has finished upgrading and performed a reboot.

*Note: It is very important not to disconnect power supply from meter during a firmware upgrade as it can cause the meter to become unusable.*

### Shutdown

This option will shut down the meter completely. Turn the meter supply off and then on again for a reboot.

### Colour Test

General colour test for LCD screen.

### Factory Reset

At any time the meter can be restored to a factory state. This can be very helpful if settings have been corrupted or the meter needs to be used in another application i.e. changing a DCM to a SOM.

If the meter will not boot to a status page or the settings become corrupted reboot the meter and hold the Down button. This will bring up the 'Utilities' menu where a Factory reset can be performed.

*Note: Please be aware that all stored settings will be erased when doing a factory reset.*

### Input Debug

Use this function to see a technical overview of all inputs.

# Programming Menu Flow Diagram

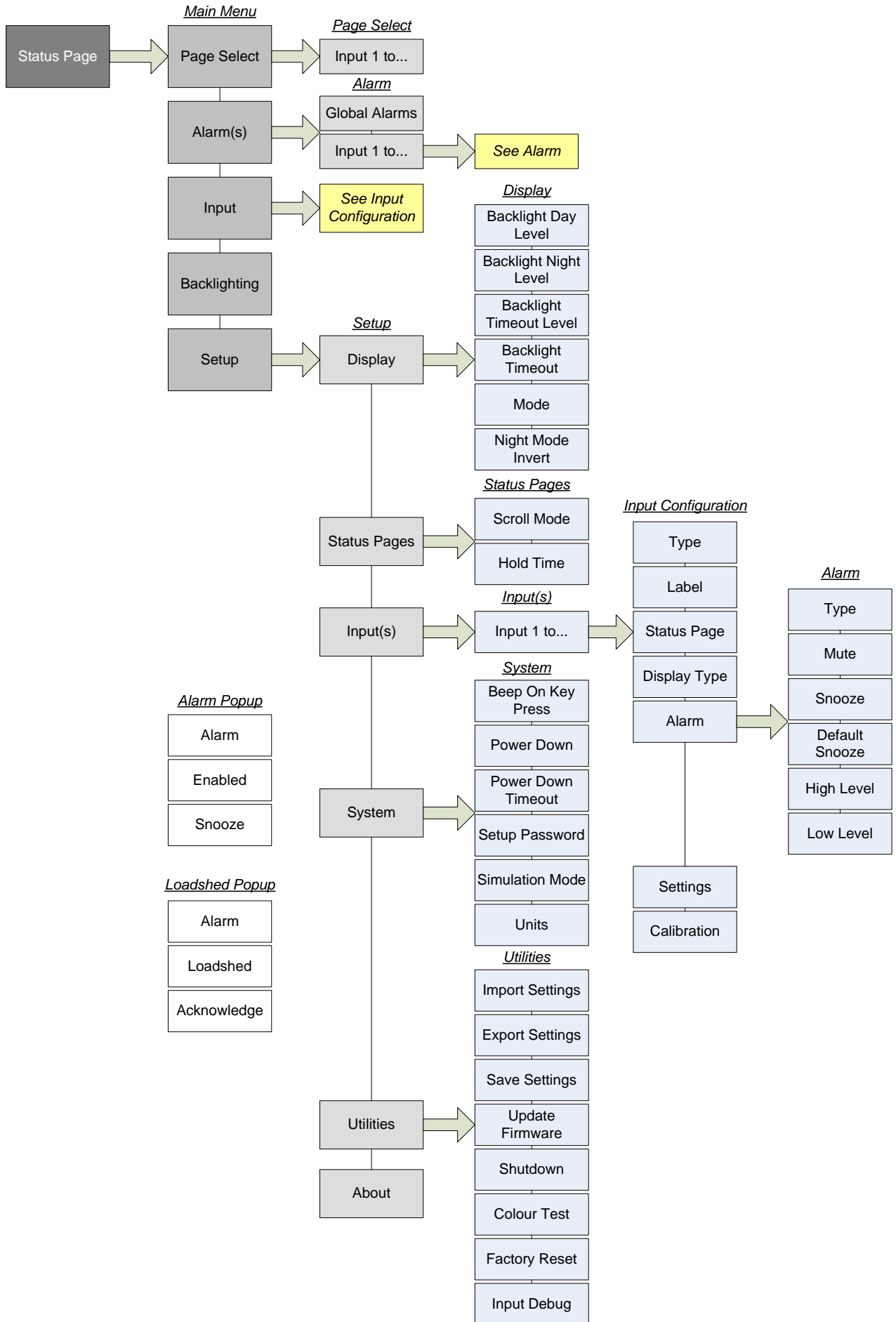



## AC CIRCUIT BREAKER PANELS

[WITHOUT METERS]

### INSTALLATION & OPERATING INSTRUCTIONS

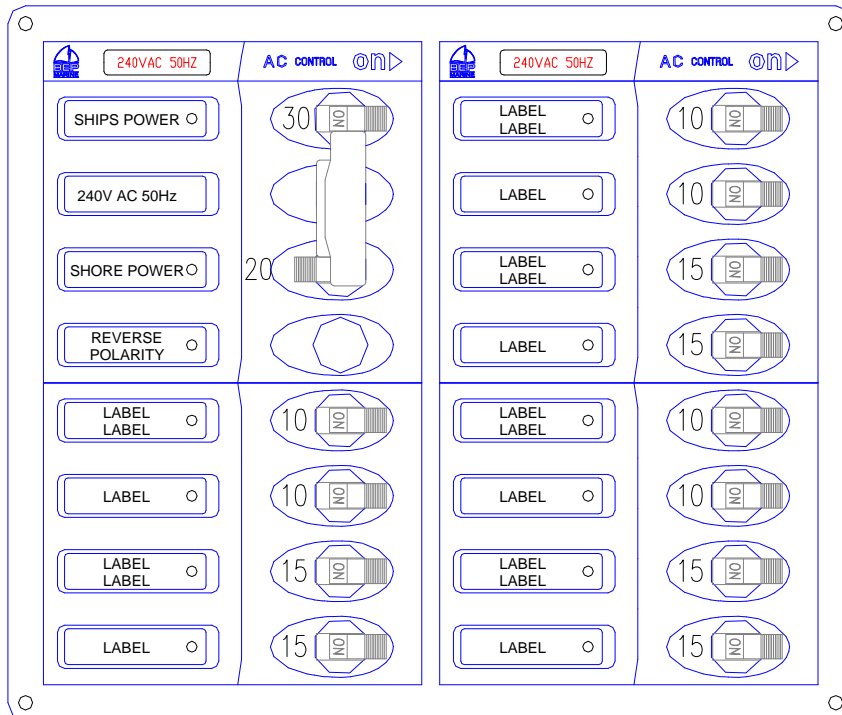



# 1 CIRCUIT BREAKERS

It is very important to note that the primary function of the circuit breaker is to prevent the cabling from overloading and therefore catching fire. In the event of an electrical short, fault or overload, the circuit breaker is designed to protect the boat's electrical system not necessarily the appliance.

Different appliances require different circuit breakers with the manufacturer of the appliance certifying the load, and therefore the size of the circuit breaker required.

All BEP panels are supplied complete with a standard set of circuit breaker sizes and labels. Owners or electrical installers therefore need to choose the most appropriate panel for each application.

Should you require a custom made current rating or label layout these are available for an additional charge. Contact your BEP Marine representative for more details.

Note: breakers must be sized in accordance with cable size.

BEP Marine uses Airpax IEG Magnetic circuit breakers

SINGLE TOGGLE 1-2 & 3 POLE SMALL FRAME CB'S		
Single pole	Double pole	Triple pole
CBS-2.5A-SP 2.5Amps	CBS-2.5A-DP 2.5Amps	CBS-30A-TP 30Amps
CBS-5A-SP 5Amps	CBS-5A-DP 5Amps	CBS-50A-TP 50Amps
CBS-10A-SP 10Amps	CBS-10A-DP 10Amps	D/pole Trip Coil
CBS-15A-SP 15Amps	CBS-15A-DP 15Amps	CBS-15A-DP-TC230 230VAC
CBS-20A-SP 20Amps	CBS-20A-DP 20Amps	CBS-20A-DP-TC230 230VAC
CBS-25A-SP 25Amps	CBS-25A-DP 25Amps	CBS-20A-DP-TC110 110VAC
CBS-30A-SP 30Amps	CBS-30A-DP 30Amps	CBS-30A-DP-TC230 230VAC
CBS-40A-SP 40Amps	CBS-40A-DP 40Amps	CBS-30A-DP-TC110 110VAC
CBS-50A-SP-IG 50Amps	CBS-50A-DP 50Amps	CBS-50A-DP-TC230 230VAC
		CBS-50A-DP-TC110 110VAC
SINGLE TOGGLE 1-2 & 3 POLE LARGE FRAME CB'S		
Single pole	Double pole	Triple pole
CBL-50A-SP 50Amps	CBL-50A-DP 50Amps	CBL-50A-TP 50Amps
CBL-60A-SP 60Amps	CBL-60A-DP 60Amps	CBL-80A-TP 80Amps
CBL-75A-SP 75Amps	CBL-80A-DP 80Amps	CBL-100A-TP 100Amps
CBL-100A-SP100Amps	CBL-100A-DP100Amps	

Small Frame

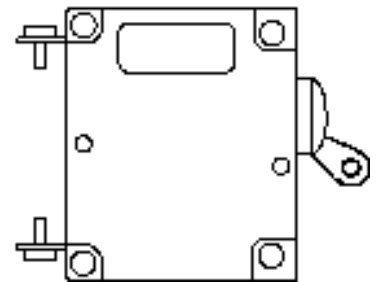

Large Frame

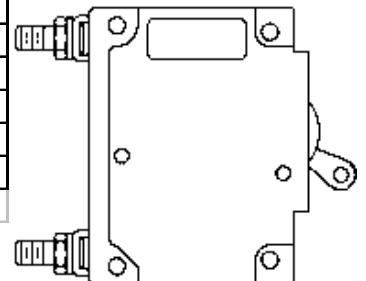

## 2 LABELLING AND REPLACING CIRCUIT BREAKERS

All BEP panels come with a comprehensive set of self-adhesive labels.

To refit or replace a label, unclip the front panel as shown and replace the appropriate label.

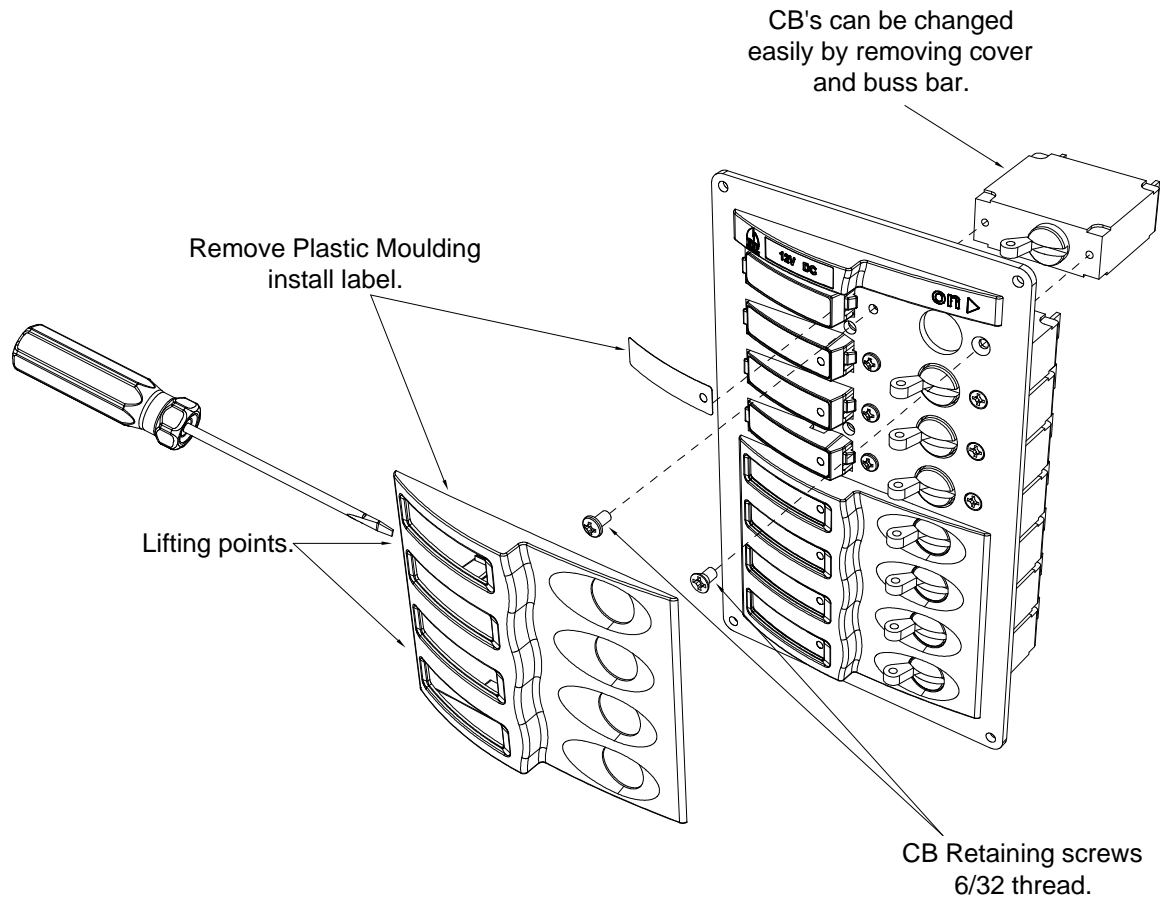

To replace a circuit breaker the front cover of the BEP panel must be removed. This is done by unclipping the front panel and unscrewing the two screws that hold the circuit breaker.

### 3 INSTALLATION (PANEL MOUNTING)

All BEP panels require a 10mm inset on all external edges.

Panels are also supplied with negative bus bars to allow the tidy connection of negative cables at the back of the panel.

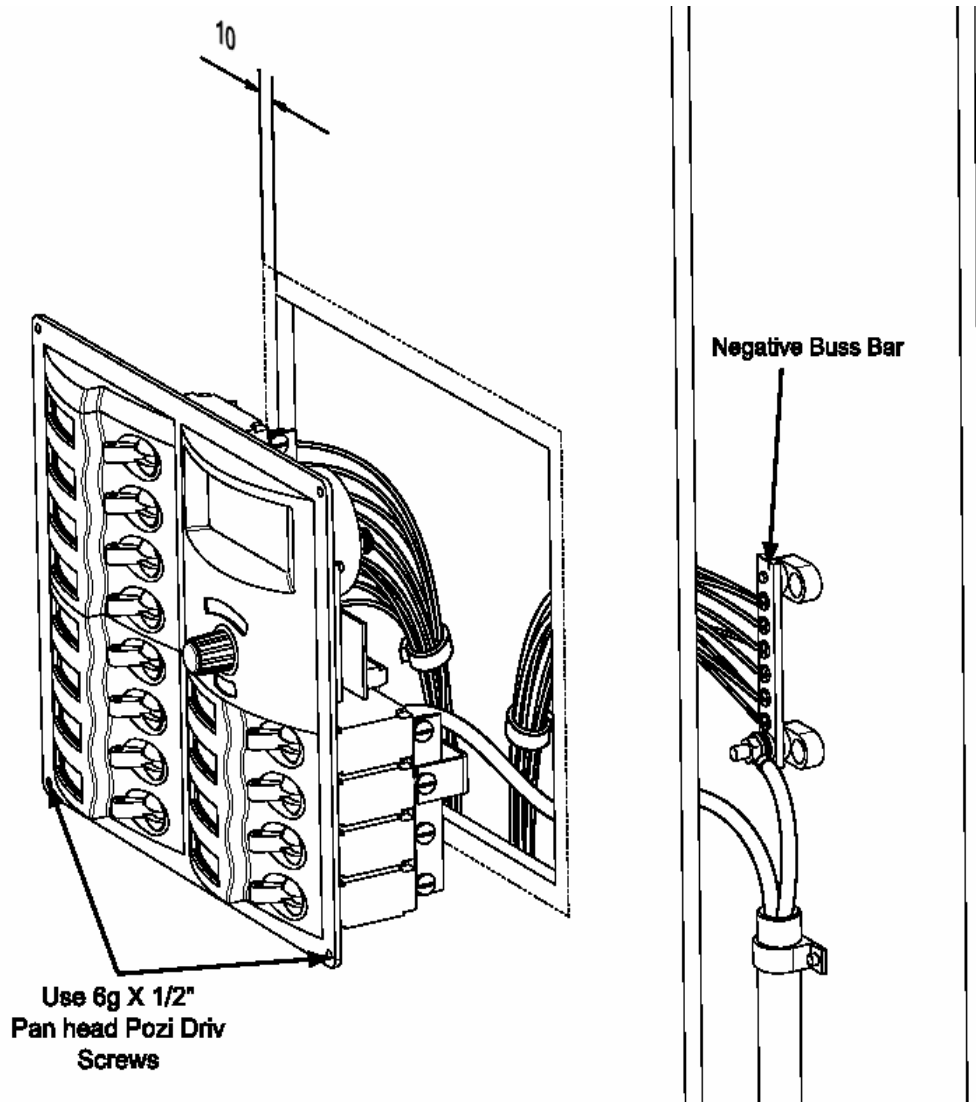

Be sure to allow plenty of space behind the panel for wiring connections and looms. A minimum of 55mm of extra space is strongly recommended.

For example: If the distance to the back of the panel brackets is 70mm be sure to allow at least 125mm ( $70 + 55 = 125$ ).

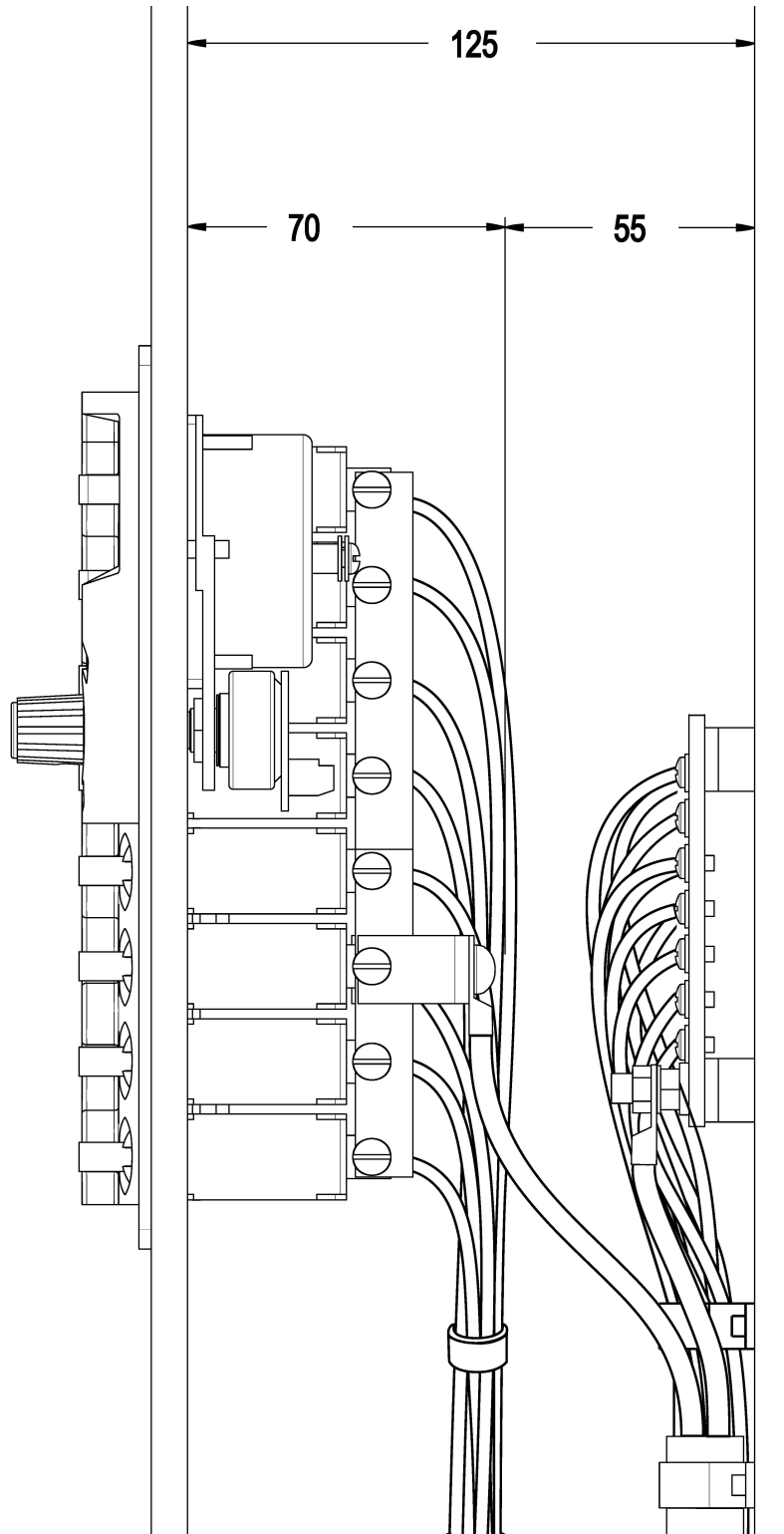

## 4 BACK LIGHTING

All BEP AC and DC panels come with 12 volt DC back lighting. On 24-volt systems, a dropping resistor will be required for the back lighting

Note: The Red Systems On indicators will work on both 12 and 24 volts so therefore do not require a dropping resistor.

## 5 DROPPING RESISTORS

Dropping resistors are used for changing back lighting on 12V panels to 24V

Note: Use ½ watt resistors, select as close to the above sizes as possible.

Panel size	Resistor size
4 way	1K8Ω
8 way	1KΩ
12 way	680Ω
16 way	470Ω
20 way	390Ω
24 way	330Ω
28 way	270Ω
32 way	220Ω
36 way	200Ω

REAR VIEW OF STANDARD PANEL

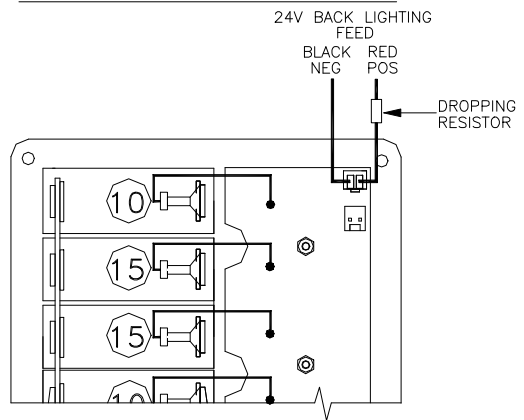

REAR VIEW OF STANDARD PANEL (LARGER THAN 36 WAY)

\* FOR PANELS LARGER THAN 36 WAY USE INDIVIDUAL DROPPING RESISTORS FOR EACH BANK OF BACKLIGHTING. (AS SHOWN BELOW)

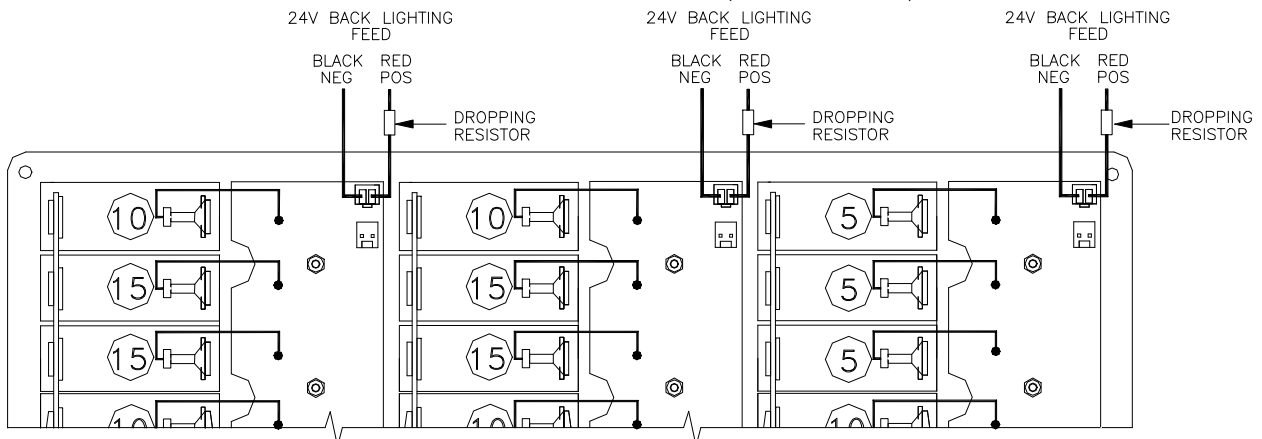

## 6 PANEL WIRING

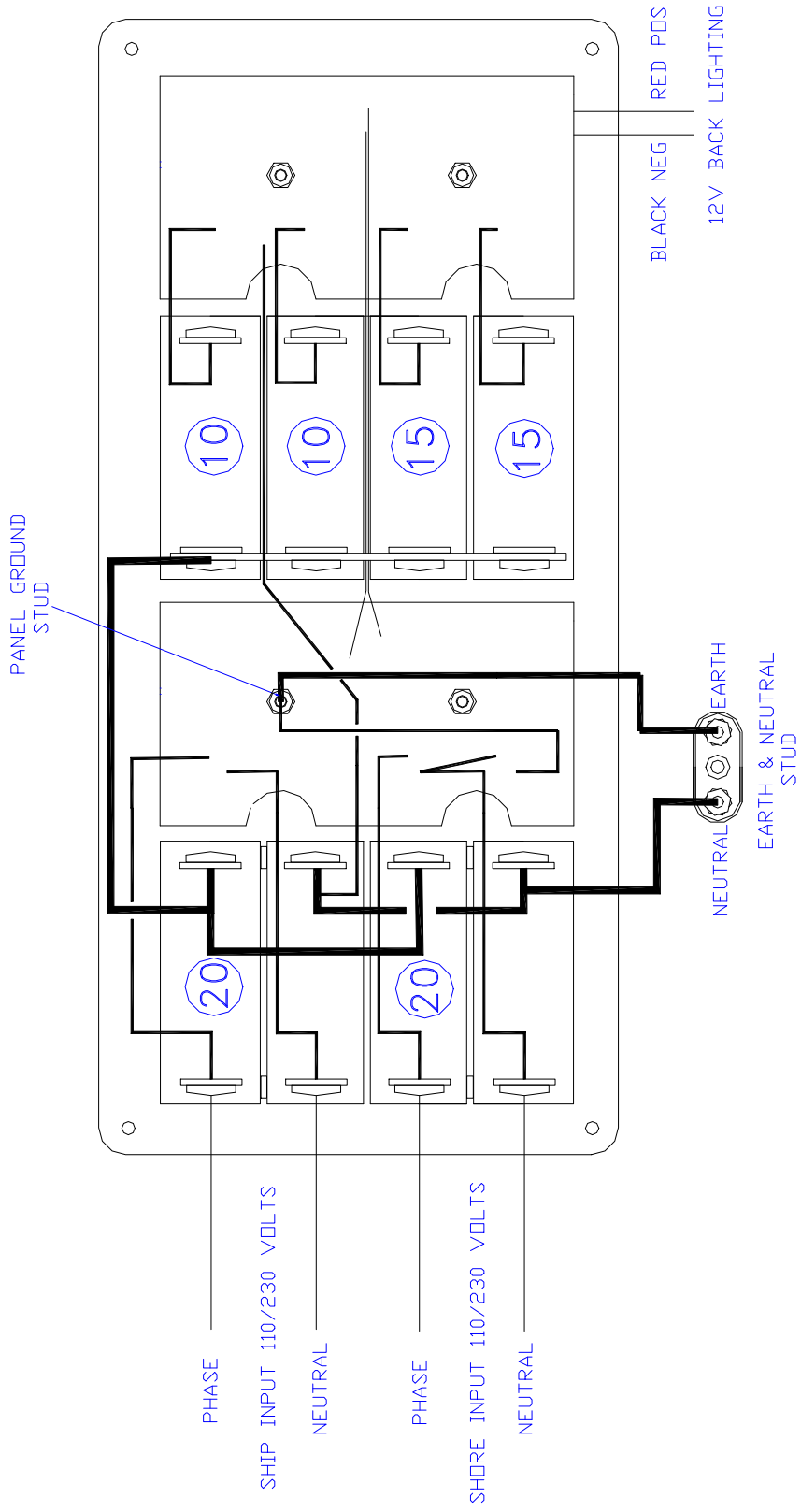

## EXTERNAL RCD WIRING

PLEASE NOTE: DRAWING IS NOT TO BE USED AS A WIRING DIAGRAM  
ITS SOLE PURPOSE IS TO SHOW TRACK BREAKS + RCD CONNECTIONS  
ENSURE A QUALIFIED ELECTRICIAN COMPLETES WIRING

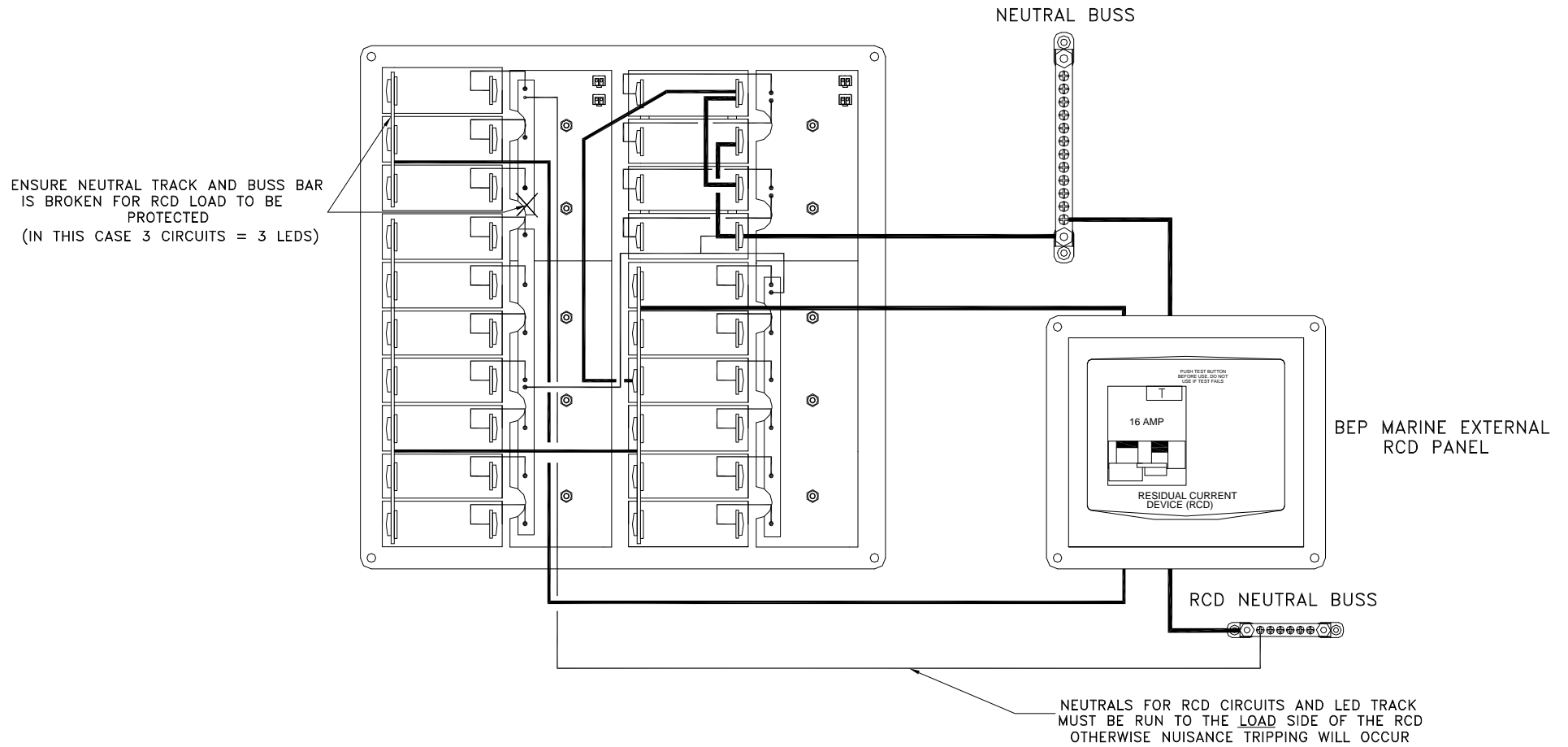

## 7 LABEL SETS

<b>SET 1N</b>	<b>SET 2N</b>	<b>SET 3N</b>	<b>SET 4N</b>	<b>SET 5N</b>	<b>SET 6N</b>	<b>SET 7N</b>
Accessories	Bait Tank Pump	12V Outlets	Aft Lights	AC Mains	AC Mains	Aft Peak Light
Anchor Light	Bilge Pump Aft	24V Outlets	Bedroom/Converter	AC Outlets	Accessories	Deck Flood Lights Aft
Auto Pilot	Bilge Pump Forward	Aft Deck Light	Davit Winch	AC Outlets	Anchor Wash	Deck Flood Lights Fwd
Bilge Pump	Bilge Pump Mid	Bilge Auto Man.	Engine Alterator	Air Conditioning	Automatic	Deck Lights
Cabin Lights	Bilge Pump Port	Bow Lights	Fire System	Battery Charger	Autopilot	Deck Lights Aft
Cabin Lights	Bilge Pump Starboard	Docking Lights	Fish Finder	Cook Top	Auxiliary	Deck Lights Forward
Cockpit Lights	Blower	Emergency Parallel	Fishing Light	Dishwasher	Bilge Auto Manual	Deck Lights Port
Compass Lights	Boarding Light	Engine Alarm	Galley/Bath	Dive Comp	Bilge Lights	Deck Lights Starboard
DC Outlets	Cabin Lights Aft	Engine Blowers	Heater Fans	Dryer	Boom Furl	Fish Room Lights
Depthsounder	Cabin Lights Fwd	Extraction Fan	House Alterator	Frequency	Bridge Lights	Fish Room Pump
Freezer	Cabin Lights Mid	Flood Lights	Intercom	Genset	Burglar Alarm	Fishing Lights
Freshwater Pump	Cabin Lights Port	Fore Deck Light	Load	Heater	Cabin Fan	Fishing Lights Green
GPS	Cabin Lights Starboard	Galley Lt	Locker Light	Hotwater Cylinder	CB Radio	Fishing Lights Red
Instruments	Deck Wash Pump	Generator Lights	Mid Lights	Ice Maker	Cell Phone	Fishing Lights White
LPG Control	Electric Toilet	Holding Tank Pump	Mid Wiper	Inverter	Computer	Fore Deck Light
Mast Light	Engine Room Lights	House Batteries	Mizzen Spreader Light	Inverter Outlets	DC Mains	Foscle Light
Navigation Lights	Fridge	Lazarette Light	Plotter	Microwave	Fuel Transfer	Mast Flood Lights Aft
Saltwater Pump	Horn	Port	Port Wiper	Oven	Galley Fan	Mast Flood Lights Fwd
Shower Drain	Nav Lt's Port	Radio Battery	Preheat	Refrigeration	Hatch Controls	Net Recorder
Spare	Nav Lt's Starboard	Search Light	Sole Light	Reverse Polarity	Hydraulics	Not Under Command
Spotlight	Panel Lights	Starboard	Starboard Wiper	Ships Power	Loud Hailer	NUC Lights
Spreader Light	Radar	Start Batteries	Sub Main	Shore Power	Macerator	Plotter
Steaming Light	Saloon Lights	Step Light	Sump Pump	Trash Compactor	Manual	Port Flood Lights
Stereo	SSB	Strobe Light	Tank Room Lights	TV	Night Lights	Shower Lights
Trim Tabs	Start	Toilet Lt	Toilet Pump	Video	Pelmet Lights	Stbd Flood Lights
VHF	Stern Light	Weather Fax	Towing Light	Washing Machine	Solar Panel	Toilet Fan
Winch	Stop	Windex Light	TV/Stereo	Waste Master	Stove	Toilet Light
Wiper	Tri Light	Window Washers	Walvac	Water Maker	TV Anetnna	Winch Flood Lights



<b>SET 8N</b>	<b>SET 9N</b>	<b>SET 10N</b>	<b>SET 11N</b>	<b>SET 12N</b>	<b>SET 13N</b>	<b>SET 14N</b>
Anchor Light	Boiler / Heater	Air Compressor	Black Tank Pump	24-12V Reducer	Aft Bilge Alarm	210Khz TX
Baragraph Power	Bow Thruster	Air Con Galley	Block Heater	Aerator	Bilge Alarm	33Khz TX
Cabin Fans	DC/DC Converter	Air Con Guest Room	Block Heater Port	Ballast Aft	Bilge Alarm Test	Aft Hold Light
Cabin Fans Aft	Deck Lights Forward	Air Con Master State	Block Heater Starboard	Ballast Control	Bilge Auto	Cockpit Freezer
Cabin Fans Fwd	Decklights Aft	Air Con Pilot House	Central Vacuum	Ballast Fwd	Bilge Lights	Engine Controls
Courtesy Lts	Decklights Mid	Air Con Salon	Compactor	Black Tank Aft	Bilge Manual	Fire Pump
Courtesy Lts Aft	Decklights Upper	Air Con Saloon	Cupboard Heaters	Black Tank Fwd	Bilge Pump Auto/Manual	Fluxgate Compass
Courtesy Lts Fwd	Defroster	Air Con State Room	Engine Heater	Black Water Pump	Fwd Bilge Alarm	Flybridge Freezer
Courtesy Lts Mid	Galley Lights	Air Con V-Berth	Entertainment Centre	Boom Light	High Water Alarm	Fridge/Freezer
Diesel Heater	Grey Water Pump	Air Conditioning	Fresh Water Pump	Bridge Lights	Mid Bilge Alarm	Fuel Gauge
Fire System	Guest State Lights	Air Conditioning 1	Garburator	Bridge Supply	Port Aft Bilge Alarm	Fuel Transfer Port
Fuel Pump	Head Pump 1	Air Conditioning 2	Generator 1	Dining Lights	Port Aft Bilge Auto	Fuel Transfer Stbd
Hailer	Head Pump 2	Air Conditioning 3	Generator 2	Fire Alarm	Port Aft Bilge Manual	Fwd Hold Light
Lectrasan	Master State Lights	Central Vacuum	Heat/Defroster	Flow Alarm	Port Fwd Bilge Alarm	Gantry Lights
Lectrasan Fwd	Nav Lights	Charger Generator	Hot Circ Pump	Interior Lights	Port Fwd Bilge Auto	Holding Tank Port
Lectrasan Stbd	Oil Pump	Charger House	Ice Maker Lower	Luff Light	Port Fwd Bilge Manual	Holding Tank Stbd
Port Engine Controls	Pilot House Lights	Charger Inverter	Ice Maker Upper	Modem	Port Mid Bilge Alarm	Masthead Light
Port Ignition	Saloon Lights	Compactor	Ignition	Nav Area Fan	Port Mid Bilge Auto	Pilot Light Red
Sat Com	Search Light	Engine Room Fans	Inverter 1	Outlets Aft	Port Mid Bilge Manual	Pilot Light White
Shower Light	Spare	Hot Circ Pump	Inverter 2	Outlets Fwd	Stbd Aft Bilge Alarm	Port Fuel Filter
Spare	Spare	Ice Maker Lower	Lazer Plotter	Outlets Mid	Stbd Aft Bilge Auto	Rudder Indicator
Spare	Stereo	Ice Maker Upper	Lighting Inverter	Outlets Port	Stbd Aft Bilge Manual	Stbd Fuel Filter
Spare	Trim Tab Control	Outlets Engine Room	Range Sub Panel	Outlets Stbd	Stbd Fwd Bilge Alarm	Steering
Stabilizer	V-Berth Lights	Outlets External	Refrigerator	Port Engine	Stbd Fwd Bilge Auto	Toilet Aft
Stbd Engine Controls	VHF Lower	Outlets Galley	Telephone System	Riding Light	Stbd Fwd Bilge Manual	Toilet Fwd
Stbd Ignition	VHF Upper	Outlets Lower Deck	TV/Video	Stbd Engine	Stbd Mid Bilge Alarm	Towing Light Amber
Toilet Light	Wash Down Pump	Outlets Upper Deck	Water Circ Pump	Step Lights	Stbd Mid Bilge Auto	Towing Light White
Waste Treatment	Windlass	Water Heater	Zone Valves	Strobe	Stbd Mid Bilge Manual	Tuna Tubes

<b>SET 15N</b>	<b>SET 16N</b>	<b>SET 17N</b>	<b>SET 18N</b>	<b>SET 19N</b>	<b>SET 20N</b>	<b>SET 22N</b>
12v Outlet Flybridge	AC Outlets Aft	24 Hour Circuits	27 Meg	12V Battery Charger	12v Aux Horn	Alarms
24v DC Mains	AC Outlets Aft Cabin	Aft Bilge Pump Auto / Man	Aft Holding Tank	12V Battery Charger	Aft Fridge	CCTV
Arch Lights	AC Outlets Cockpit	Aft Head	Aft Water Heater	24hr Bilge Pump	Alternator	Cockpit Fridge
Bilge Pump Clutch	AC Outlets Deck	Alarm Mute	Cabin Outlets	24V Battery Charger	Anchor Winch	Communications
Bow Bilge High Water	AC Outlets Fwd	Depth / Speed	Cockpit Fridge	Bilge Pump Port Fwd	Bathroom Fan	Control Max 2.0
Cabin Heater	AC Outlets Fwd Cabin	Electronics	DC Mains 1	Bilge Pump Port Mid	Bathroom Outlets	Deck Lights
Compass	AC Outlets Galley	Engine Alarm	DC Mains 2	Bilge Pump Stbd Aft	Bridge Supply	Earth Leakage Lights
Demister	AC Outlets Guest Cabin	Fans	Dehumidifier	Bilge Pump Stbd Fwd	Docking Lights	Emergency Parallel
Dry Head Pump	AC Outlets Mid	Fwd Bilge Pump Auto / Man	DVD	Bilge Pump Stbd Mid	Engine Room Bilge Alarm	Engine Room Main
Engine Clutch Pump	AC Outlets Port	Fwd Head	Engine Blower	Boarding Platform	Fax	Equipment Room
Flybridge Hatch	AC Outlets Salon	Galley / Head Vent	Engine Room Outlets	Bulwark Lights	Fish Finder	Flybridge Lights
Flybridge Wipers	AC Outlets Saloon	Galley Fridge	Entertainment	Bunk Lights	Holding Tank Gauge	Fresh Water Pump Port
Freezer Clutch	AC Outlets Staterooms	Gas Stove	Flybridge Main	Cable Master	Icemaker	Fresh Water Pump Stbd
Fwd Stateroom Lights	AC Outlets Stbd	Gauges	FWD Holding Tank	Desalinator	Inverter/Charger	Genset Start
Greywater Pump 1	AC Outlets Wheelhouse	Head Pump	FWD Water Heater	Dishwasher	Lake Water	Genset Stop
Greywater Pump 2	Aircon Aft Deck	Level Indicator	Galley	Electric Windows	Master Head	Grill
Guest Cabin Stereo	Aircon Aft	Lights	Gas Solenoid	Engine Controls	RCD	Head/Galley Vent
Inmarsat	Aircon Cabin	Mid Bilge Pump Auto / Man	Generator	Macerator	Reset	HF Radio
Instrument Lights	Aircon Fwd	Nav & Inst Lights	GFCI Outlet	Oil Pump	Salon Lights	Ignition Start
Instruments Flybridge	Aircon Fwd Deck	Oil Pressure	Hatch Lifter	Pitch Control	Shaver Outlets	Mid Hold Lights
Instruments Pilothouse	Aircon Helm	Pt Engine	Helm Main	Port Air Con	Sounder	Radio Light
Master Head Lights	Aircon Port	Pt Engine Start / Stop	Hour Meter	Port Engine	Speed	Radios
Nav Area Lights	Aircon Pump	Stb Engine Start / Stop	Laundry	Sonar	Sum Log	Refrigerator
Overhead Lights	Aircon Stbd	Stbd Engine	LPG/Cooktop	Spa	Toilet Port	Reverse Polarity Test
Overhead Saloon Lights	Airhandler Fwd Stateroom	Sum Log	Navigation	Stbd Air Con	Toilet Stbd	UHF Radio
Saloon Wipers	Airhandler Mstr Stateroom	Synchronizer	Range	Stbd Engine	Trolling	VHF Radio
Security System	Airhandler Pilothouse	Water Temp	TV /DVD	Storeroom Lights	TV lift	Wheelhouse Lights
Underfloor Lights	Airhandler Saloon	Windshield	UHF	TV	Wind Instruments	Wine Cooler

<b>SET 23N</b>	<b>SET 24N</b>	<b>SET-25N</b>	<b>SET 26N</b>
Air Con Port	Bedroom Lights	12V DOOR	DC Fridge
Air Con Stbd	Ceiling Lights	12V SPARE	Deck & Courtesy Lights
Berth Lights	Deck Flood Lights	AFT FANS	Electronics overhead panel
Blower	Diesel Heater	AFT TOILET LIGHTS	Engine Room & Lazarette Lights
Cabin Lights Main	Discharge Pump	BLACK WATER DISCHARGE	Engine Room Sump Pump
Cooling Pump 1	Extract Fan	ENGINE ROOM EXHAUST	Genset Charger
Cooling Pump 2	Flybridge Clutch	ENGINE ROOM INTAKE	Head Vent
Discharge	Flybridge Stereo	FWD FANS	High Exhaust Temp Port
Discharge	Fwd Cabin Stereo	FWD TOILET LIGHTS	High Exhaust Temp Stbd
Discharge	Fwd Spot Light	HELM DECK LIGHTS	Lower 12V Mains
Discharge	Gas Heater	HELM FRIDGE	Lower 24V Mains
Emergency Lights	LPG/Cooktop	HIGH WATER BILGE PUMP	Port Electric Head
Gallery Fridge	Macerator Pump	PORT BILGE PUMP AUTO/MANUAL	Port Engine Fault
Helm Lights	Network	PORT ENGINE IGNITION	Port Engine Maintenance
Macerator	Outside Lights	PORT ENGINE START	Port Engine Start/Stop
Master Cabin Lights	Port Cabin Stereo	PORT HEAD	Port & Stbd Cabin Lights
Port Engine Controls	Port Macerator	PORT TOILET LIGHTS	Stbd Electric Head
Port Engine Controls	Reading Lights	PORT VENT	Stbd Engine Fault
Port Engine Controls	Running Lights	SATELLITE	Stbd Engine Maintenance
Quartz Lights	Salon Stereo	SLOW VESSEL MODE	Stbd Engine Start/Stop
Stbd Engine Controls	Stbd Cabin Stereo	STBD BILGE PUMP AUTO/MANUAL	Stereo Inverter
Stbd Engine Controls	Stbd Macerator	STBD ENGINE IGNITION	Upper 12V Mains
Stbd Engine Controls	Underwater Lights	STBD ENGINE START	Upper 24V Mains
Stereo Memory	Wardrobe Lights	STBD HEAD	Vacuum Flush
Storage Bin Pump	Water Gauge	STBD TOILET LIGHTS	Vacuum Pump
Waterblaster	Accommodation	STBD VENT	Wait To Start Port
Air Con Flybridge	Accommodation Lights	SUNROOF	Wait To Start Stbd
Air Con Fwd	Aft Spot Light	TOILET LIGHTS	Windsheild Lift