



BIRD•B•GONE[®] Inc.

PROFESSIONAL BIRD CONTROL PRODUCTS



**LEADING
WITH PROVEN
SOLUTIONS.
GUARANTEED.**

ABOUT BIRD•B•GONE®



WHY BIRD•B•GONE®?

Our people, products, expertise, and training make the difference!

- » Bird•B•Gone® products are humane, effective, and carry industry leading guarantees.
- » The #1 most specified products by architects, engineers, and government agencies.
- » We manufacture the majority of our own products at our facility in the United States.
- » Our products have been used to successfully deter pest birds from high profile locations such as airports, schools, hospitals, military bases, historical buildings and more.
- » Our bird control engineers have a combined 90+ years of hands-on experience.
- » We offer free training and support for all aspects of bird control, including on-site training and technical support.
- » We regularly host a free training course, Bird•B•Gone® University, that teaches everything from quoting a job to product installation.
- » We offer same day and express shipping.
- » Our products are available worldwide through a network of quality distributors.

WHO IS BIRD•B•GONE®?

The industry leader since 1992

Bird•B•Gone®, Inc. is the world's largest manufacturer of professional grade bird deterrents.

Since 1992, our products have helped solve pest bird problems in commercial, industrial, recreational, government and residential settings across the globe.

Our superior products, excellent customer support and cutting-edge innovation have secured our position as the number one manufacturer and supplier of bird control products.

At Bird•B•Gone®, it's more than just bird control products, **IT'S FAITH, FAMILY AND FRIENDS!**

OUR STORY

Julie and I started Bird•B•Gone® in 1992. Since we couldn't afford anything, our first office was in our bedroom. The old oak desk pictured here was our first piece of "office furniture." The desk held our telephone and fax machine. With your kindness and business, we have steadily grown. Today we own and operate our own manufacturing facility which makes and ships our products all over the world. The old oak school desk still occupies the same space in our home as a daily reminder of where we started.



Julie & Bruce Donoho

- » We thank you for your friendship.
- » We thank you for helping us realize our dream.
- » We thank you for your business and will continue to work hard to earn it!



WHY BIRD•B•GONE®?

Why Bird•B•Gone®?	2
Who is Bird•B•Gone®?	2
Our Story	2
Products by Area	4
Products by Pest Bird	5
Bird•B•Gone® University	6
Partner with Bird•B•Gone®	7
Innovation	7
Our Experts	8
Why Bird Control?	9
Two Minute Tuesday	81
Bird•B•Gone® Gives Back	82
Our Clients	83

SPIKE

Stainless Steel Bird Spikes™	12
Mega Spike™	14
Gutter Spike	14
Girder Spike	14
Polycarbonate Bird Spikes™	16
Case Study	19

NETTING

Bird Net 2000™ Heavy Duty Netting	22
No-Knot Netting	26
Installation and Tools	28
Corner Attachments	29
Intermediate Attachments	30
Straining Wire & Cabling	31
Fasteners	31
Hog Rings	32
Accessories for Access & Tools	33
Heavy Duty Bird Control Starter Kit	34
Black Hardware	34
Bat Netting	35
Ultra Net™	35
Pond Netting	36
Flame Net	36
Case Study	37

ELECTRIC TRACK

Bird Jolt Flat Track®	40
Installation Accessories	42
Electric Track Chargers	43
Installation Components	43
Bird Jolt Flat Track® Kit	44
Case Study	45

DETERRENTS

Bird Slope™	48
Bird Slope™ Installation Accessories	49
Bird Wire	50
Bird Wire Hardware	51
Solar Panel Bird Deterrent Kit	52
Instant Repair Patch	53
Bird Spider 360°	54
Bird Chase Super Sonic™	56
Solar Bird Chase Super Sonic™	56
Zon™ Mark IV Bird Scare Cannon™	57
Zon™ Electra Bird Scare Cannon™	57
AgriLaser®	58
Reflect-A-Bird™	59
Case Studies	60-61

TRAP & CAPTURE

Mist Net & Mist Net Kit	64
Sparrow Charmer™	65
Sparrow Capture Trap	65
Professional Bird Traps	66

REPELLENTS

Bird-OFF™ Gel	70
Transparent Bird Gel	71
Bird•B•Gone® Bird Hazer	72
Patriot™ Thermal Fogger	72
Avian Control™	74
EcoBird® 4.0	74
Avian Migrate™	75
Avian Fog Force™ TR	75
Case Study	76

MISCELLANEOUS

Adhesives and Sealants	78
Cleaning Supplies	78
Industrial Spring Clamp	79
Vinyl Strip Doors	79
Bird Net Curtain	79
The Defender™ Premium Vent Cover	79
BeakGuard®	80
Visual & Physical Bird Deterrents	80
Marketing Materials	81
Resource Center	81

PRODUCTS BY AREA

Use this guide to find the right product by the different areas..

EXCLUSION PRODUCTS



Bird netting can be used in heavy nesting areas where birds need to be excluded. Netting can be used in roofs, warehouses, docks, airplane hangars and other enclosures.

Bird Net 2000™ Heavy Duty Netting	22
No-Knot Netting	26
Bat Netting	35
Ultra Net™	35
Flame Net.....	36
Pond Netting.....	36
Bird Slope™	48
Solar Panel Bird Deterrent	52
Instant Repair Patch.....	53
Vinyl Strip Doors.....	79

REDUCTION PRODUCTS



When large numbers of birds take over a building or enclosed space, reduction products may be required before other bird control methods can be installed.

Mist Net & Mist Net Kit	64
Sparrow Charmer™	65
Sparrow Capture Trap.....	65
Professional Bird Traps.....	66

LEDGE PRODUCTS



Exposed ledges include roof lines, parapet walls, window sills, ledges, beams, and other open areas where birds choose to land.

Stainless Steel Bird Spikes™	12
Mega Spike™	14
Gutter Spike	14
Girder Spike	14
Polycarbonate Bird Spikes™	16
Bird Jolt Flat Track®	40
Bird Wire	50
Bird Spider 360°®	54
Bird-OFF™ Gel.....	70
Transparent Bird Gel.....	71

SENSORY PRODUCTS



Sensory products are used when pest birds become a problem in semi-enclosed and wide open spaces like parks, golf courses, airports, vineyards, and agricultural areas.

Sound Deterrents.....	56
ZON™ Mark IV Bird Scare Cannon™	57
ZON™ Electra Bird Scare Cannon™	57
AgriLaser®	58
Reflect-A-Bird™	59
Bird•B•Gone® Bird Hazer	72
Patriot™ Thermal Fogger.....	72
Goose Repellents.....	74
BeakGuard®	80

PRODUCTS BY PEST BIRD

There are many factors to consider when choosing the right bird control product. It is important to do a site evaluation to determine the species of bird, location and the bird's behavior.

Not all products work for every situation and some situations may require multiple products. Choosing the correct product can mean the difference between success and failure.



Our customer support team is a phone call away to assist you in finding the best solution
Call 800.392.6915



PIGEONS

- Bird Spikes 10
- Bird Netting 20
- Electric Track 38
- Bird Slope™ 48
- Bird Wire 50
- Bird Spider 360® 54
- Trapping 62
- Bird Gels 70
- Hazing 72



CROWS

- Bird Spikes 10
- Bird Netting 20
- Electric Track 38
- Super Sonics 56
- Bird Gels 70



GULLS

- Bird Spikes 10
- Electric Track 38
- Bird Slope™ 48
- Bird Spider 360® 54
- Super Sonics 54



GEESE

- Super Sonics 56
- Visual Deterrents 58
- Fogging 72
- Goose Repellents 74



VULTURES & RAPTORS

- Mega Spike 14
- Polycarbonate Bird Spikes™ 16
- Bird Netting 20
- Electric Track 38



SWALLOWS

- Bird Netting 20
- Bird Slope™ 48



SPARROWS

- Bird Netting 20
- Electric Track 38
- Bird Slope™ 48
- Super Sonics 56
- Trapping 62
- Sparrow Charmer™ 65
- Sparrow Capture Trap 67
- Hazing 72



STARLINGS

- Bird Spikes 10
- Bird Netting 20
- Electric Track 38
- Bird Slope™ 48
- Super Sonics 56
- Trapping 62
- Hazing 72
- Fogging 72



WOODPECKERS

- Bird Netting 20
- UltraNet™ 35
- Super Sonics 56
- Visual Deterrents 58
- BeakGuard® 80



GRACKLES

- Electric Track 38
- Bird Gels 70
- Hazing 72
- Fogging 72

BECOME AN AUTHORIZED INSTALLER



*Grow your business with
FREE on-site training*

Earn your Authorized Installer Certificate at Bird•B•Gone® University—a free training course designed to teach the basics of bird control. Classes are taught by our bird control specialists and are held at the Bird•B•Gone® training facility in Santa Ana, California. Those who attend receive a Certificate of Completion which can also be applied as credit hours toward a Pest Control Applicator's License in many states.

As an Authorized Bird•B•Gone® Installer, you will work with the highest quality bird control products and receive the best customer service. Whether you are looking to develop a primary bird control business or wish to add an additional service to your existing business, bird control can be a lucrative way to add extra dollars to your bottom line. We pride ourselves on the personal relationships we build with our customers and are here to assist you in building and growing your bird control business!

Topics include:

- » How to market and make a profit in bird control.
- » Perform a site evaluation.
- » Choose the right product.
- » Quote bird jobs.
- » Install products (hands-on training).
- » Install netting (hands-on training).
- » Avoid problems.
- » Learn to troubleshoot challenges.

Worldwide On-Site Training

At Bird•B•Gone®, our goal is not to “sell” you products, but to position you to make the best quality decisions when it comes to designing, specifying, and installing the right products to fit your job. Our bird control engineers have 90+ years of combined experience and will help you in all aspects of bird control.

Need to train a group of employees? Have a complex bird job? Bird•B•Gone® will provide the expertise necessary to bring success to your job. To schedule on-site training, contact our installation experts at 800.392.6915.

PARTNER WITH BIRD•B•GONE®

Need an Authorized Installer?

If you don't have time, resources, or expertise to solve a bird problem, we can connect you to an Authorized Bird•B•Gone® Installer.

We have trained an extensive network of Authorized Installers who install our line of professional bird control products around the world. Whether it's a commercial, residential or an industrial setting, our installers have the experience to solve your pest bird problem. We work closely with our installers to ensure they are qualified to rid the pest birds and provide exceptional customer service.

Quality Guaranteed

Bird•B•Gone® products go through an extensive quality control process before they leave our warehouse. All products are hand inspected and signed as they are packaged. This allows us to offer the industry's longest guarantees.

- » Stainless Steel Bird Spikes: 10 Years
- » Polycarbonate Bird Spikes: 5 Years
- » Black Bird Net 2000™ Heavy Duty: 10 Years
- » No-Knot Netting: 10 Years
- » Bird Wire: 5 Years
- » Bat Netting: 10 Years

Shipping

Bird•B•Gone® provides the fastest and most efficient shipping in the industry. We manufacture our own products. This enables us to offer customers convenient and expedited shipping options like same-day shipping! We use traceable shipping methods to guarantee your products arrive on time. Wherever you are in the world, Bird•B•Gone® will ship to you!

Specifications & CAD Details

We are the #1 bird control company specified by architects, engineers and government agencies. Since 1992, we have worked with the AEC industry in the design and implementation of effective, humane, and cost efficient bird control solutions.

Specifications, CAD, and BIM details can be found on our website. If you need help specifying bird control on a project, contact our bird control experts to help you choose the right product and place you in contact with an Authorized Installer.



INNOVATION

At Bird•B•Gone®, we make it our business to stay on top of the latest advancements in the bird control industry.

58
PATENTS

We are constantly improving current technologies and developing new products to meet our customers' needs. We strive to provide the most effective, efficient and reliable bird control methods on the market.

Bird•B•Gone® has 58 issued patents worldwide and 35 pending patent applications—the most in the industry!

Some of our outstanding patented products:

- » Bird•B•Gone® invented and patented the original Plastic Bird Spike. This revolutionary bird control tool is one of our best sellers.
- » Bird Jolt Flat Track® received another patent on its innovative anti-arc and trough design.
- » Bird•B•Gone® Stainless Steel Bird Spikes™ patented “bend and crush” design ensures that the spikes stay firmly secure in their base.

Because Bird•B•Gone® is only involved in bird control, we make it our business to stay on top of the latest advancements in the industry. We continue to provide our customers with the products and services that give them a leading edge in bird control.

OUR EXPERTS

More than 90+ years of combined experience in the bird control industry!

A company or organization is only as good as its people and Bird•B•Gone® has the best! Our bird control experts lead the industry. We've seen it all! Everyday we consult with large and small companies worldwide, helping them avoid costly mistakes and create "predictable success."



Mark Gist
31 years experience

"After 30+ years of installing and selling bird control, I joined the Bird•B•Gone® team in 2016. I look forward to supporting, training, and helping our customers grow their bird control business."



Scott Swanson
20 years experience

"Bird•B•Gone® is my home and I consider my customers as my friends. I have worked on amazing projects with some of the smartest people in the industry, giving me the chance to experience things I wouldn't trade for anything."



Jeff Watts
15 years experience

"I deal with a variety of industries on a daily basis. Every day is unique. From architectural jobs to international skyscrapers, I get to help people across the globe create bird-free areas."



Shaun Johnson
7 years experience

"From business owner to homeowner, I enjoy recommending the right product for each customer's situation. It's great to have quality products available through various points of distribution worldwide!"



Chris Fields
12 years experience

"I have the pleasure of working with architects and engineers every day helping them plan for the future. Designing and developing plans to protect old and new structures from bird debris is something I take pride in."



Aron McKay
2 months experience

"With over 10 years of global building industry experience, partnering with architects, engineers, installers, home owners, distributors and retailers, I'm eager to help you get the best solution for your pest bird issue today!"



Bryan Donoho
8 years experience

"It is a privilege to work for a company that promotes personal growth and positive change in the lives of its employees and customers. Whether it be solving a customer's bird problem or facilitating installation trainings, Bird•B•Gone® always seeks to offer more than bird control."



Alan Roniss
3 years experience

"It is always a pleasure helping a customer rid his or her property of pest birds. It doesn't matter if it's a home or a commercial building, Bird•B•Gone® will help you create a bird-free environment."



It's important to take a proactive approach when dealing with pest birds. Birds not only carry and spread disease, but bird feces can corrode building materials.

The build-up of droppings or nesting materials is unsightly and can host parasites like bird mites. In the long run, bird control can save you time and money.

BIRD CONTROL IS AN INVESTMENT

- » Eliminate safety and health hazards - decrease your liability
- » Eliminate the spread of diseases to your employees and patrons
- » Decrease expenses/costs on maintenance and repair
- » Protect your property value
- » Improve and protect your image

Health Risk



Birds, droppings, and nesting materials can carry up to 60 different diseases that can be passed to humans and animals.

Brand Image



Birds on a ledge or sign, or droppings covering a sidewalk will send a message to visitors that the business is careless and should not be trusted.

WHY BIRD CONTROL?

Inventory Damage

Droppings can damage products and contaminate production lines.

Work Stoppages

Employees will not and should not work in areas that are unsafe due to an accumulation of droppings.

Slip and Fall Risk



Droppings can be slippery. If a customer or employee falls they could get seriously injured, and sue the building owner.

Health Code Violations

Pest bird droppings found in food processing plants, restaurants, storage facilities or other areas may violate health codes resulting in fines, legal action, or closures.

Clogged Drains

Droppings and nesting materials regularly clog drains, causing damage during heavy rains.

Property/Equipment Damage



Droppings are acidic and can corrode through paint, roofing materials and fabrics. These will need restoration or complete replacement.

Cost of Cleanup

Businesses that clean up after birds on a daily or weekly basis incur high clean-up costs.

SPIKE

Preventing birds from landing on ledges is an important and crucial step in bird deterrence.

Bird spikes, from Bird•B•Gone®, offer an effective and humane deterrent for larger bird species like pigeons and seagulls. We invented and patented the first plastic bird spike and offer highly durable construction that carries an industry leading Bird•B•Gone® guarantee for all products. Stainless steel bird spikes are virtually invisible and our plastic bird spikes are available in seven colors.

Spikes are easily installed on ledges, roof peaks, I-beams, parapet walls, conduits, signs, flat or curved surfaces. They are designed to blend with a building's color scheme and design. Bird spikes provide a cost effective and long term solution to deter nuisance bird infestations and protect a property from damage.



*Shaun Johnson
Bird Control Expert*

STAINLESS STEEL BIRD SPIKES™

ADVANTAGES & BENEFITS

Bird•B•Gone® Stainless Steel Bird Spikes™ create an uneven surface preventing birds from landing on flat or curved areas. Spikes come pre-assembled in 2' sections and are made of stainless steel pins in a polycarbonate base.

- » #1 specified bird spike by architects contractors and government agencies.
- » The lowest price and the longest guarantee.
- » Virtually invisible.
- » Humane, will not harm birds.
- » Easy to install. Can be glued, screwed, or tied down.
- » Will not cut or injure the installer.
- » Patented "bend and crush" design for permanent installations.
- » 2' (61 cm) lengths. Up to 40 spikes per foot in linear array. Cuts labor time in half.
- » No-nest design. No gap spacing to deter birds from roosting or landing.

DETAILS

BIRD SPECIES	Pigeons, seagulls, or larger birds
WHERE TO USE	Ledges, I-beams, parapet walls, conduits, signs, flat, or curved surfaces
BIRD PRESSURE	Light to Medium
GUARANTEE	10 years
MATERIAL	Stainless steel spikes manufactured into a UV protected polycarbonate base

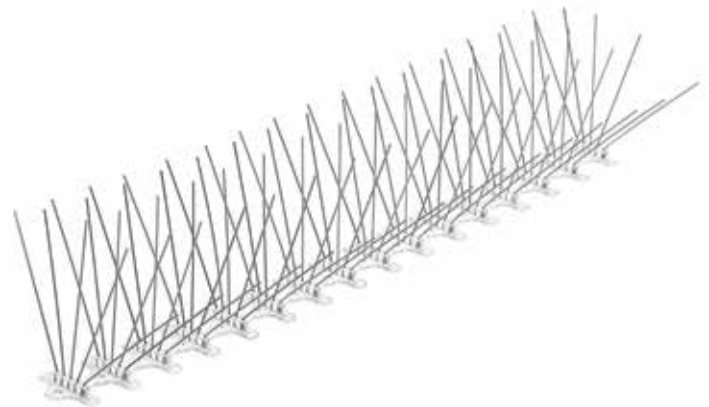

Patented "Bend and Crush" Design

PATENTS

- » US 6250023
- » US 6775950



Bends 360°



1/4" screw holes for easy attachment

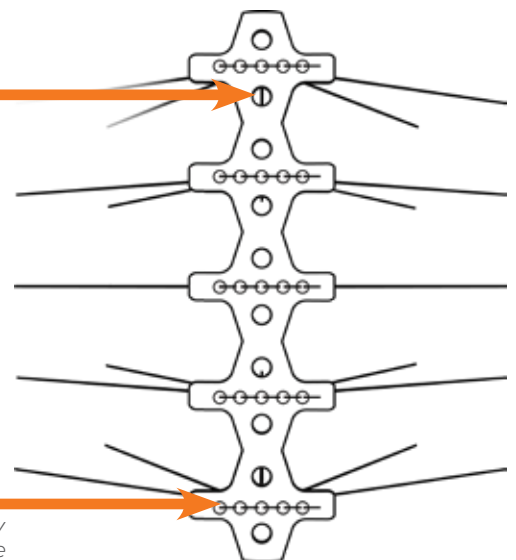

Pins are permanently anchored in the base of the spike.



FEATURES

WIDTH

8"

5"

3"

1"



ITEM #

BBG2001-8

BBG2001-5

BBG2001-3

BBG2001-1

COVERAGE
AREA

7" - 9"
(17.78 cm - 22.86 cm)

4" - 6"
(10.16 cm - 15.24 cm)

2" - 4"
(5.08 cm - 10.16 cm)

1" - 2"
(2.54 cm - 5.08 cm)

PACK SIZE

2' (61 cm) sections
50' (15.24 m) per box

2' (61 cm) sections
50' (15.24 m) per box

2' (61 cm) sections
50' (15.24 m) per box

2' (61 cm) sections
50' (15.24 m) per box

WIDTH

8"

5"

3"

1"

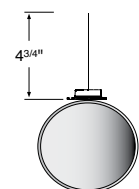
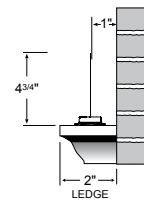
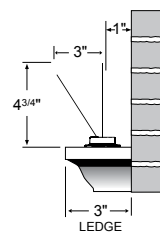
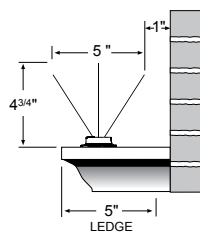
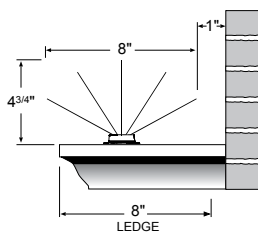

*Attach using common hose clamps, nylon ties and wire lashings.

MEGA SPIKE™

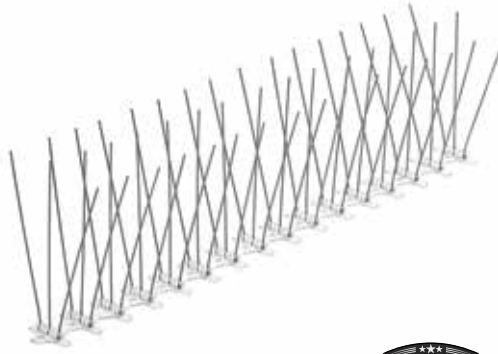

BIRD SPECIES	Pigeons, seagulls, cormorants, vultures, raptors, or larger birds
WHERE TO USE	Ledges, I-beams, parapet walls, conduits, pipes, flat or curved surfaces
MATERIAL	Stainless steel spikes manufactured into a UV protected polycarbonate base
BIRD PRESSURE	Light to Medium
GUARANTEE	10 years

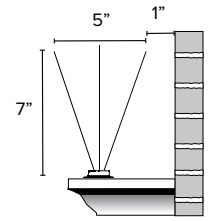

- Tallest bird spike deterrent available
- Will not harm birds
- Stainless steel spikes are virtually invisible
- Easy to install. Can be glued, screwed, or tied down
- 2' (60.96 cm) lengths cuts labor in half

ITEM #	COVERAGE AREA	PACK SIZE
BBG2001-MS7	3" - 7" (7.62 cm - 17.78 cm)	2' (61 cm) sections 50' (15.24 m) per box

GUTTER SPIKE

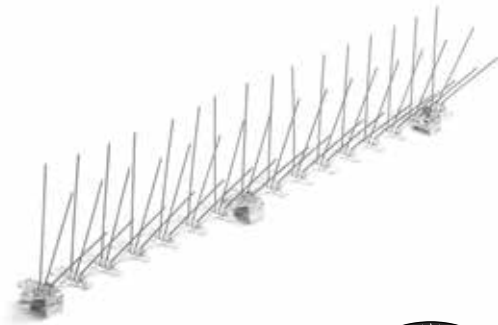

BIRD SPECIES	Pigeons, seagulls, or larger birds
WHERE TO USE	For gutters up to 3/4"
MATERIAL	Stainless steel spikes manufactured into a UV protected polycarbonate base with aluminum clamps
BIRD PRESSURE	Light to Medium
GUARANTEE	10 years



- Prevents birds from landing on gutter ledges and from nesting in gutters
- No need for separate clips or hardware
- Virtually invisible
- 2' (61 cm) lengths cuts labor time in half
- Attached thumb screws make for easy installation

ITEM #	COVERAGE AREA	PACK SIZE
BGS	4" - 6" (10.16 cm - 15.24 cm)	2' (61 cm) sections 50' (15.24 m) per box

GIRDER SPIKE



BIRD SPECIES	Pigeons, seagulls, or larger birds
WHERE TO USE	Adapts to any size girder up to 1" thick
MATERIAL	Stainless steel spikes manufactured into a UV protected polycarbonate base with aluminum clamp
BIRD PRESSURE	Light to Medium
GUARANTEE	10 years



- Prevents birds from landing on steel girders and I-beams
- Fits any girder up to 1" (2.54 cm) thick
- No need for separate clips or hardware
- Ideal where clean up of debris or droppings is not possible
- Attached girder clamps make for easy installation

ITEM #	COVERAGE AREA	PACK SIZE
BBGGDR-3	3" (7.62 cm)	2' (61 cm) sections
BBGGDR-5	5" (12.70 cm)	50' (15.24 m) per box
BBGGDR-8	8" (20.32 cm)	

INSTALLATION



BEFORE



AFTER

PREPARATION



The first step prior to installing bird spikes is to clean and dry the area where spikes will be installed. Bird•B•Gone® offers cleaning supplies to get the job started off right.

See page 78

ADHESION



Surface should be clean and dry before installation. Select width of bird spike based on surface to be covered. Glue, screw, or tie down to surface.

See page 78

POLYCARBONATE BIRD SPIKES™

ADVANTAGES & BENEFITS

- » Lowest cost commercial bird spike.
- » Will not harm birds; virtually invisible.
- » Non-conductive. Will not interfere with electrical or communication transmissions.
- » Durable and super strong.
- » Break-away points, no tools necessary.
- » UV protected and weatherproof. Won't be affected by extreme temperatures -200° F to 310° F (-129° C to 154° C).
- » 2' (61 cm) lengths, cuts labor time in half.
- » Easy to install. No maintenance. Can be glued, screwed, or tied down.

PATENTS

- » US 6250023
- » US 7596910
- » US 7941977
- » US 8191303
- » US 8245435
- » US 8250814
- » US 9260856
- » US 9386764

UNDERSIDE VIEW

Glue trough makes gluing easy

Offset pre-drilled holes for screws or adhesive

Notches break away for smaller pieces

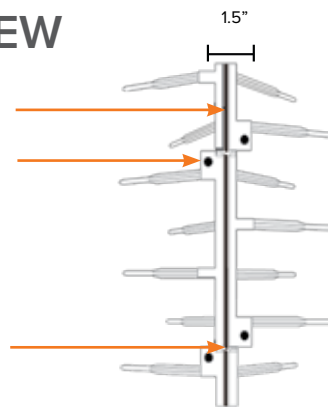

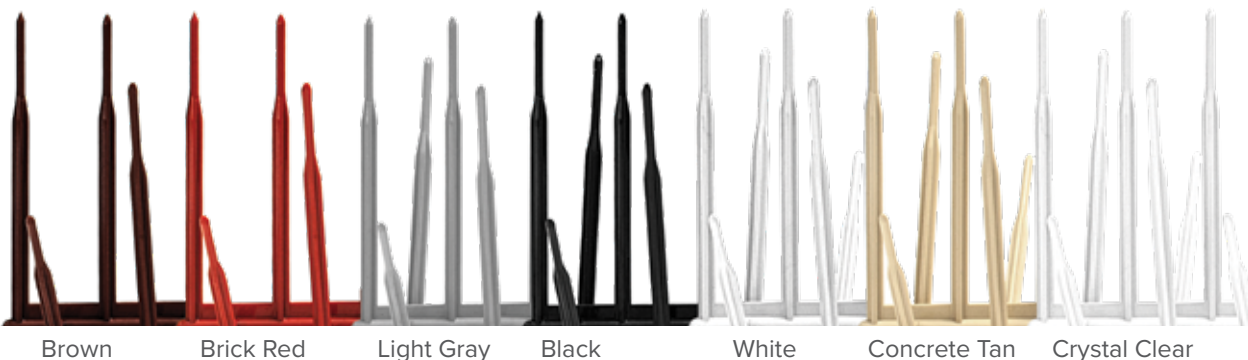

AVAILABLE IN 7 COLORS

Crystal Clear	White	Black	Light Gray
Concrete Tan	Brown	Brick Red	Custom Colors Available





FEATURES

WIDTH	7"	5"	3"
			

ITEM #	BBG2000-7	BBG2000-5	BBG2000-3
COVERAGE AREA	6" - 8" (15.24 cm - 20.32 cm)	4" - 6" (10.16 cm - 15.24 cm)	1" - 4" (2.54 cm - 10.16 cm)
PACK SIZE	2' (61 cm) sections 50' (15.24 m) per box	2' (61 cm) sections 50' (15.24 m) per box	2' (61 cm) sections 50' (15.24 m) per box

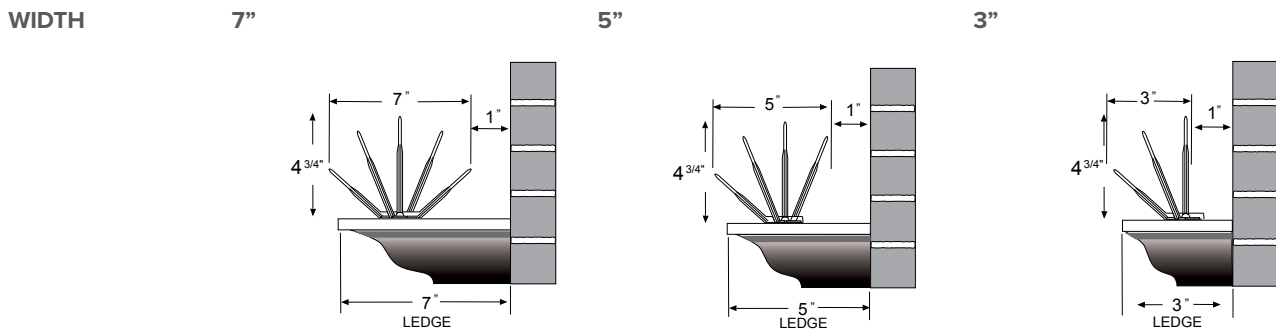

BIRD SPECIES	Pigeons, seagulls, or larger birds
WHERE TO USE	Ledges, I-beams, parapet walls, conduits, signs, flat, or curved surfaces
BIRD PRESSURE	Light to Medium
GUARANTEE	5 years
MATERIAL	UV protected polycarbonate plastic one-piece rigid construction

INSTALLATION

PREPARATION



The first step prior to installing bird spikes is to clean and dry the area where spikes will be installed. Bird•B•Gone® offers cleaning supplies to get the job started off right.

See page 78

ADHESION



Surface should be clean and dry before installation. Select width of bird spike based on surface to be covered. Glue, screw, or tie down to surface.

See page 78



Watch our spike installation video at:
www.birdbgone.com/spikeinstall



Alan Roniss
 Bird Control Expert



BIRD•B•GONE
 Polycarbonate
 Bird Spikes

Patented:
 US 6259623
 US 7596910
 US 7941977

Also Covered Products:
 America's #1 Solution for
 White-rumped Storm Petrel, Black Turnstone,
 1-800-355-8972 www.birdbgone.com

Made in the USA
 PRODUCT CODE # 8902888

CLEAR BLACK
 WHITE BROWN
 GRAY TAN
 CUSTOM

3" (8 cm) WIDE
 5" (13 cm) WIDE
 7" (18 cm) WIDE

2 FT. (61 cm) SECTIONS
 36 FT. (11 m) PER BOX



Bird•B•Gone® partners with an authorized installer to donate and install bird spike to high school in surrounding community.



High school rooftop installation area.



Stainless steel spike installed on rooftop parapet wall.

Bird•B•Gone®, Inc. extended its foundational values of “Faith, Family, and Friends” to include a local high school in the surrounding community. As part of a multi-level service project, Bird•B•Gone® reached out to the school to offer a donation of bird control products and installation services to help resolve an unwanted pigeon presence. Located within the center of the school’s campus, there is an outdoor lunch area that provides both shelter and food for pest birds. With the assistance of a local authorized installer, Kevin Hearne from Zapp Pest Management, Bird•B•Gone® provided and installed bird spikes to deter the birds.

The high bird pressure area was located above the lunch area, within which the students would leave behind left-over portions of food and drinks. The birds would land and rest on the north most building, upon which they were provided both protection as well as a “bird’s-eye” view of the campus. Once the lunch period had ended, the birds would promptly move to the ground and scavenge for the left-over food. With easy access to the three necessary components of living (food, water, and shelter) this campus was a perfect location for pest birds.

“There was a clear presence of the pest birds on this campus, however it was not until we observed and recorded the recurring activity of the birds that we understood the proper way to deal with the problem,” explained Kevin Hearne. “Once we had conducted a proper Bird•B•Gone® instituted Site Evaluation we were prepared to perform the necessary bird exclusion processes including both site cleanup and product installation.”

For this particular bird control job, the process included removing worn-down product, cleaning and sanitizing the installation area, and installing 8-inch Stainless Steel Bird Spikes™ to the ledge using E6100 adhesive.

As a result of this service installation, Bird•B•Gone® excluded the majority of pest birds from the campus, effectively minimizing the pest problem and furthering the exceptional academic environment of the school.

NETTING

Birds can create a major problem for property owners and managers.

For strip malls, warehouses, loading docks, hangars and other large structures, birds can quickly become a very costly nuisance. Birds often nest under awnings, overhangs, open roofs and covered beams in breezeways. One of the most effective and humane ways to keep birds from the property is to create a physical barrier to seal them out with specially designed bird netting.

About Bird•B•Gone®'s Bird Netting

- » Bird•B•Gone® Bird Netting is the #1 specified bird netting by architects and government agencies.
- » The netting is specially fabricated of a tough UV-stabilized polyethylene mesh; rot-proof, waterproof, and flame resistant.
- » Designed to withstand a wide range of temperatures; meets the requirement of ISO 1806 & 9001 Protocol Mesh Test for quality and mesh break strength.
- » Non-conductive, so it can be used around electrical systems and RF transmission systems without worrying about shorts or interference.
- » Available in stock sizes and custom cuts to fit a variety of needs and applications.
- » Available in three mesh sizes and comes in three colors to blend in with the area of installation.
- » Thoroughly inspected, tagged, and signed before leaving Bird•B•Gone's® warehouse.
- » To ensure fast efficient installs, Bird•B•Gone® offers all the necessary hardware for a successful installation.

Once installed, the netting is virtually invisible. Bird•B•Gone® Bird Netting is backed by industry leading guarantees.



BIRD NET 2000™ HEAVY DUTY NETTING

ADVANTAGES & BENEFITS

Bird Net 2000™ Heavy Duty Bird Netting is a polyethylene knotted net used to block birds from entering unwanted areas. Bird Net 2000™ is the most efficient and effective method for excluding birds.

- » #1 specified bird netting by architects contractors and government agencies.
- » The strongest netting at the lowest price.
- » UV-stabilized, rot proof, and waterproof.
- » ISO 1806 and 9001 protocol tested.
- » Available in 3 colors to blend in with area of installation and virtually invisible.
- » Sub-zero stable and 270° F (132° C) melting point.
- » Non-conductive.
- » We offer all the necessary hardware to install bird netting.



FREE

extra foot for
custom cuts!

*All custom
cuts 100 sq. ft.
minimum.





FEATURES

90,000 sq. ft. (8,360 sq. m) of Bird Net 2000™ Heavy Duty Netting installed on canopy at Portland International Airport.

BIRD SPECIES	All birds
WHERE TO USE	Roofs, warehouses, loading docks, airplane hangars, and other enclosures
BIRD PRESSURE	Light, medium, or heavy
GUARANTEE	Black net: 10 years; Stone net: 3 years; White net: 3 years
MATERIAL	UV-stabilized knotted polyethylene net. Flame-resistant, rot-proof, non-conductive, and stable in sub-zero temperatures
DESIGN	Six strands of Polyethylene UV-treated twine. Each strand is 12/100" thick. The filaments are twisted and knotted for ultimate strength and longevity. Pressure stretched and tightened
BURST STRENGTH	ISO 1806 and 9001 Protocol test in excess of 40 lbs. burst/break strength per twisted strand
THERMAL PROPERTIES	High Temp: Melting point in excess of 270° F; Low Temp: Stable to -250° F
ELECTRICAL PROPERTIES	Non-conductive

AVAILABLE COLORS

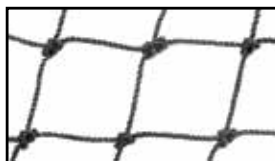

Black



Stone



White

3/4" NETTING - ALL BIRDS

AREA	COLOR	ITEM #
Custom: Includes FREE extra foot*	Black	034BCUSTOM
Custom: Includes FREE extra foot*	Stone	034SCUSTOM
Custom: Includes FREE extra foot*	White	034WCUSTOM
25' x 25' (7.62 m x 7.62 m)	Black	034B25X25
25' x 25' (7.62 m x 7.62 m)	Stone	034S25X25
25' x 25' (7.62 m x 7.62 m)	White	034W25X25
25' x 50' (7.62 m x 15.24 m)	Black	034B25X50
25' x 50' (7.62 m x 15.24 m)	Stone	034S25X50
25' x 50' (7.62 m x 15.24 m)	White	034W25X50
50' x 50' (15.24 m x 15.24 m)	Black	034B50X50
50' x 50' (15.24 m x 15.24 m)	Stone	034S50X50
50' x 50' (15.24 m x 15.24 m)	White	034W50X50
50' x 75' (15.24 m x 22.86 m)	Black	034B50X75
50' x 75' (15.24 m x 22.86 m)	Stone	034S50X75
50' x 75' (15.24 m x 22.86 m)	White	034W50X75
50' x 100' (15.24 m x 30.48 m)	Black	034B50X100
50' x 100' (15.24 m x 30.48 m)	Stone	034S50X100
50' x 100' (15.24 m x 30.48 m)	White	034W50X100
100' x 100' (30.48 m x 30.48 m)	Black	034B100X100
100' x 100' (30.48 m x 30.48 m)	Stone	034S100X100
100' x 100' (30.48 m x 30.48 m)	White	034W100X100
100' x 200' (30.48 m x 60.96 m)	Black	034B100X200
100' x 200' (30.48 m x 60.96 m)	Stone	034S100X200
100' x 200' (30.48 m x 60.96 m)	White	034W100X200



3/4" MESH

All birds

*Travis Merriott, Manufacturing and
Angela Powler, Logistics*



FREE

extra foot for
custom cuts!

*All custom
cuts 100 sq. ft.
minimum.



1 - 1/8" NETTING - STARLINGS AND PIGEONS

AREA	COLOR	ITEM #
Custom: Includes FREE extra foot*	Black	118BCUSTOM
25' x 25' (7.62 m x 7.62 m)	Black	118B25X25
25' x 50' (7.62 m x 15.24 m)	Black	118B25X50
50' x 50' (15.24 m x 15.24 m)	Black	118B50X50
50' x 100' (15.24 m x 30.48 m)	Black	118B50X100
200' x 200' (60.96 m x 60.96 m)	Black	118B200X200



1 1/8" MESH
Starlings and pigeons

2" NETTING - PIGEONS AND SEAGULLS

AREA	COLOR	ITEM #
Custom: Includes FREE extra foot*	Black	200BCUSTOM
Custom: Includes FREE extra foot*	Stone	200SCUSTOM
25' x 25' (7.62 m x 7.62 m)	Black	200B25X25
25' x 25' (7.62 m x 7.62 m)	Stone	200S25X25
25' x 50' (7.62 m x 15.24 m)	Black	200B25X50
25' x 50' (7.62 m x 15.24 m)	Stone	200S25X50
50' x 50' (15.24 m x 15.24 m)	Black	200B50X50
50' x 50' (15.24 m x 15.24 m)	Stone	200S50X50
50' x 100' (15.24 m x 30.48 m)	Black	200B50X100
50' x 100' (15.24 m x 30.48 m)	Stone	200S50X100
100' x 100' (30.48 m x 30.48 m)	Black	200B100X100
100' x 100' (30.48 m x 30.48 m)	Stone	200S100X100
100' x 200' (30.48 m x 60.96 m)	Black	200B100X200
200' x 200' (60.96 m x 60.96 m)	Stone	200S200X200
200' x 200' (60.96 m x 60.96 m)	Black	200B200X200

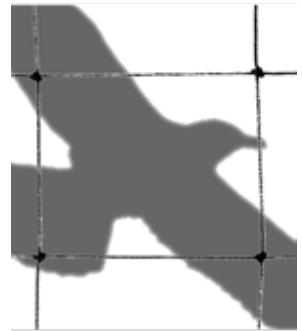

2" MESH
Pigeons and larger



INSTALLATION HELP

Bird-B-Gone® will connect you with a network of Authorized Installers across the globe who professionally install Bird Net 2000™. If you are looking to install netting yourself, our team of bird control engineers can help you with technical assistance and training.

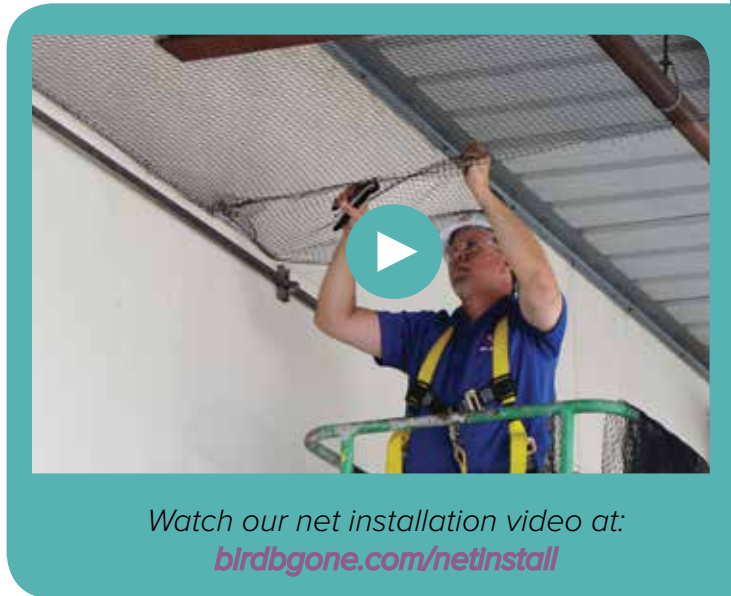

Watch our net installation video at:
birdbgone.com/netinstall

**All custom cuts 100 sq. ft. minimum*

NO-KNOT NETTING

ADVANTAGES & BENEFITS

SOFT ON YOUR HANDS: No-Knot Netting is a heavy duty, flame resistant polypropylene knotless bird net used to block birds from entering unwanted areas. No-Knot Netting is made from a UV-stabilized mesh and excludes all birds. No-Knot Netting is installed in the same manner as the Bird Net 2000™.

- » 3/4" mesh excludes all birds.
- » Super strong, light and easy to install.
- » UV stabilized, rot proof, and waterproof.
- » ISO 1806 and 9001 protocol tested; 40 lb. burst strength.
- » Multi-stranded polypropylene fiber.
- » High resistance to acids and alkalies and non-conductive.
- » Virtually invisible.
- » We offer all the necessary hardware to install bird netting. Uses the same Bird•B•Gone® installation hardware as heavy duty knotted net.



FREE

extra foot for
custom cuts!

*All custom
cuts 100 sq. ft.
minimum.



AREA	COLOR	ITEM #
25' x 25' (7.62 m x 7.62 m)	Black	034BKK25X25
25' x 50' (7.62 m x 15.24 m)	Black	034BKK25X50
50' x 50' (15.24 m x 15.24 m)	Black	034BKK50X50
50' x 75' (15.24 m x 22.86 m)	Black	034BKK50X75
50' x 100' (15.24 m x 30.48 m)	Black	034BKK50X100
Custom: Includes FREE extra foot*	Black	034BKKCUSTOM



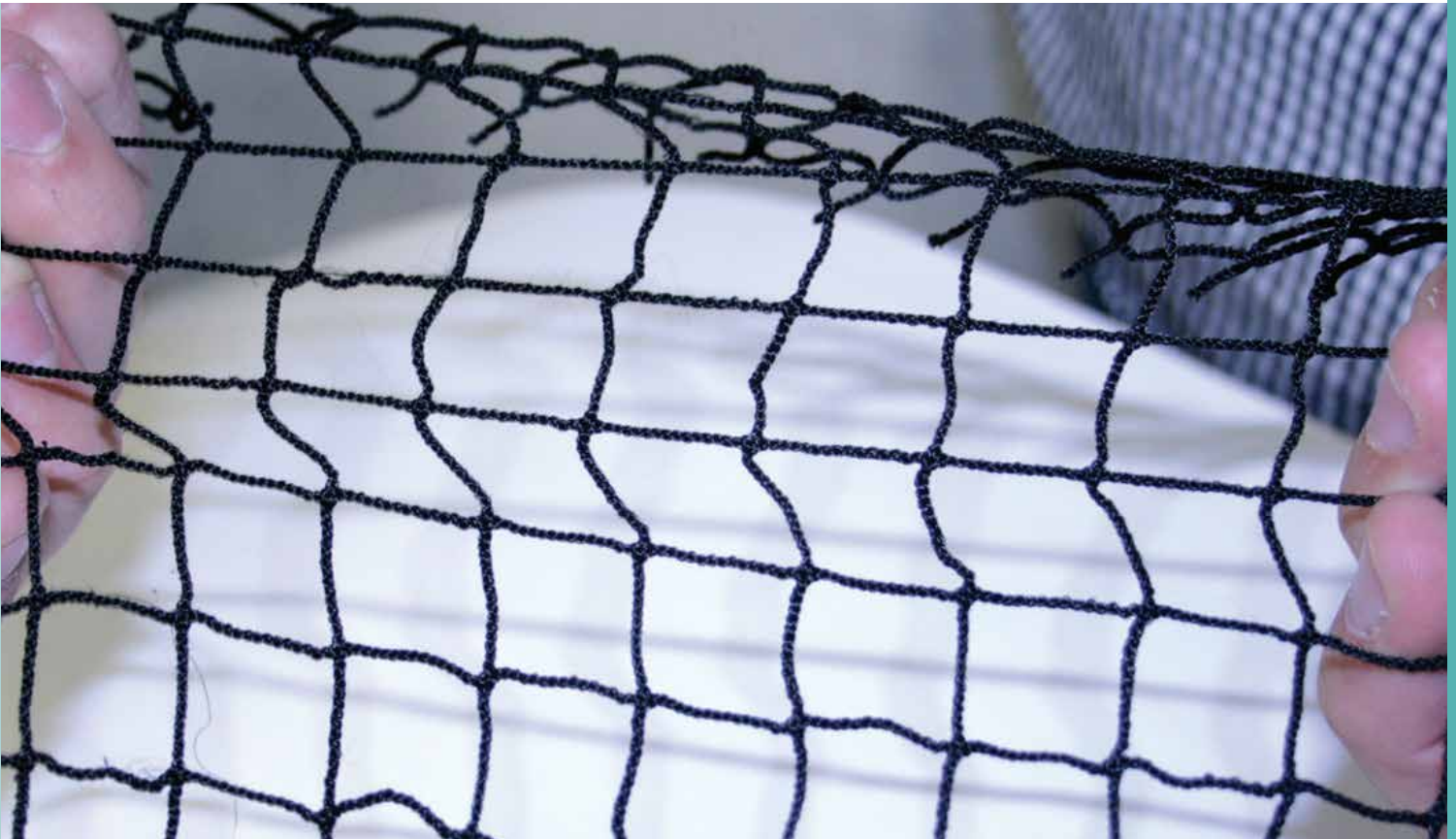

FEATURES

BIRD SPECIES	All birds
WHERE TO USE	Roofs, warehouses, loading docks, airplane hangars, and other exposed enclosures
BIRD PRESSURE	Light, Medium, or Heavy
GUARANTEE	10 years
MATERIAL	UV protected, polypropylene knotted netting
BURST STRENGTH	ISO 1806 and 9001 protocol tested: 40 lbs. burst strength
THERMAL PROPERTIES	High Temp: 320° F to 338 ° F; Low Temp: - 250° F Polypropylene is chemically inert and highly resistant to a wide range of chemicals at ordinary temperatures. Fibers have a high resistance to acids and alkalies. Does not rot or absorb water and will not mildew.
CHEMICAL PROPERTIES	
ELECTRICAL PROPERTIES	Non-conductive



3/4" MESH

All birds

INSTALLATION AND TOOLS

PROPER INSTALLATION OVERVIEW

To properly install a netting system the following steps must be accomplished:

1. Install all anchors using the correct parts for the building material you are attaching to. These will be the foundation for your netting.
2. Run the cable, turnbuckles and ferrules through your attachments and tighten the cable. The tension should be similar to that of a guitar string.
3. Once this is done, you are ready to attach the net to the cable. Attaching the net to the cable is the most time-consuming part of the process.
4. After the net has been installed, add a zipper for access to lighting and plumbing fixtures, safety equipment and such.

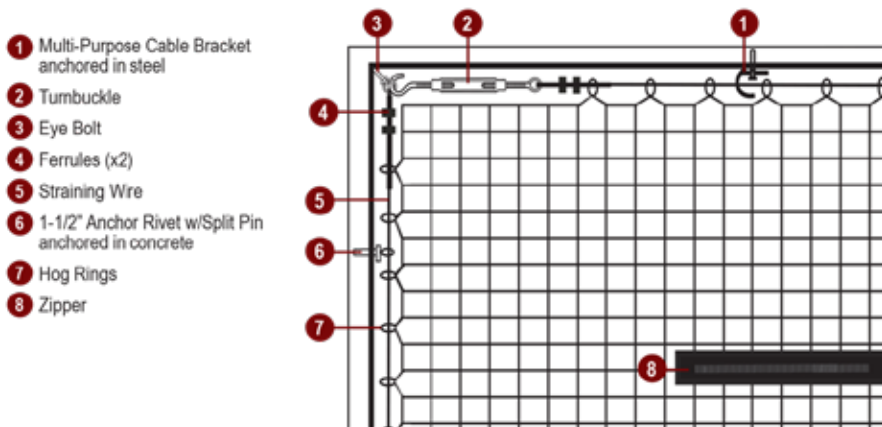

3/4" MESH
All birds

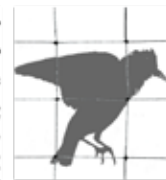

1 1/8" MESH
Starlings
and pigeons

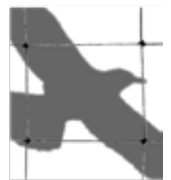



2" MESH
Pigeons and
larger

ANCHORING (CORNER AND INTERMEDIATE ATTACHMENTS)

There are two types of anchors—corner attachments and intermediate attachments.

1. Corner attachments are used where the cable begins and ends, and generally at every 50 feet of cable length. They are under the most pressure and must be the strongest part of the system.
2. Intermediate attachments hold the cable to the structure. They must be installed every at foot to every foot and a half between the corner attachments.

TOOLS





	ITEM	DESCRIPTION	ITEM #	PACK SIZE
	HILTI DX5 AUTOMATIC POWDER- ACTUATED FASTENING TOOL	Use to fasten bird netting hardware into concrete or steel structures, buildings, bridges, and steel beams. Fully automatic, excellent power-to-weight ratio; Low noise level	HILTI-DX5	1 each
	HILTI DX2 POWDER- ACTUATED FASTENING TOOL	Use to fasten bird netting hardware into concrete or steel structures, buildings, bridges, and steel beams. Slim design for accessing tight spaces Designed for speed and easy operation.	HILTI-DX2	1 each
	HILTI .27 CARTRIDGES	Hilti Cartridges are powder activated boosters used in a Hilti gun to secure attachments to steel and concrete. For use with BNMPCB-125HP-C, BNMPCB-125HP-S, and S-Clips	BNHS-27	Bird Net Hilti .27 Booster Loads Red (100 per pack)

ITEM	DESCRIPTION	ITEM #	PACK SIZE
	HILTI DUST REMOVAL HAMMER KIT Helps eliminate dust and increase productivity. Kit includes: (1) Model TE6A22 Cordless Hammer Drill (2) Battery Pack (1) Battery Charger (1) Dust Removal System (1) Soft Bag Drill Bits: (2) 1/2x6, (1) 1/4x6, (1) 3/8x6 (1) Dust Box Assembly	HILTI-TE6A22	1 each















Bryan Donoho
Bird Control Expert

CORNER ATTACHMENTS

ITEM	DESCRIPTION	DETAILS	ITEM #	PACK SIZE
	Net Bolts High load bearing expansion bolts used as corner attachments for masonry, concrete or stone. Drill Bits M6: 10 mm drill bit M8: 13 mm drill bit	Use galvanized Net Bolts with galvanized wire Use stainless steel Net Bolts with stainless steel wire Use M6/Medium Net Bolts for cable runs under 100' (30.48 m) Use M8/Large Net Bolts for cable runs over 100' (30.48 m)	BNM6EB (10/pk) BNM6SSEB (10/pk) BNM8EB (10/pk)	M6 Medium Net Bolt Galvanized M6 Medium Net Bolt Stainless Steel M8 Large Net Bolt Galvanized
	Girder Clamp Used to attach netting to girders.	Can also be used as an intermediate attachment Attach bolt onto flat steel or I-beam For steel up to 3" (7.62 cm) thickness Can be used as corner attachments if drilling is not an option.	BNGCL-3	Girder Clamp - up to 3" (7.62 cm) (10/pack)
	Mini-Net Bolt Corner attachment used for cable runs of less than 20' (6.09 m). Drill Bits 8 mm drill bit	Use galvanized Net Bolts with galvanized wire Use stainless steel Net Bolts with stainless steel wire Use M6/Medium Net Bolts for cable runs under 100' (30.48 m) Use M8/Large Net Bolts for cable runs over 100'	BNMNB-G BNMNB-S	Mini-Net Bolt Galvanized (10/pack) Mini-Net Bolt Stainless Steel (10/pack)
	Eye Bolt w/ Nut Corner attachment for steel I-beams or other thick metals. Drill Bits 8 mm drill bit	Use galvanized Eye Bolts w/ galvanized wire Use stainless steel Eye Bolts w/ stainless steel wire	BNGEB-NUT BNSEB-NUT*	Galvanized Eye Bolt w/Nut (20/pk) Stainless Steel Eye Bolt w/Nut (10/pk)
	Screw Eyes Used as a corner attachment into wood.	Use Large Screw Eyes for runs over 20' (6.1 m) Use Small Screw Eyes for runs under 20' (6.1 m) Use galvanized with galvanized wire Use stainless steel with stainless steel wire	BNLSE-G (100/pk) BNLSE-S (20/pk)* BNSSE-G (100/pk) BNSSE-S (20/pk)*	Large Wood Screw Eye Galvanized Large Wood Screw Eye Stainless Steel Small Wood Screw Eye Galvanized Small Wood Screw Eye Stainless Steel



INTERMEDIATE ATTACHMENTS

ITEM	DESCRIPTION	DETAILS	ITEM #	PACK SIZE
	NET MAGNET	40 lb. pull strength ceramic magnet in steel casing. Best for smaller jobs.	BN200MGNT	2" (3.18 cm) Net Magnet (10/pk)
	MULTI-PURPOSE CABLE BRACKET WITH HILTI PIN	Used to secure cable around the perimeter of the net installation. Can be installed for permanent installation or easy release	BNMPCB-125HP-C BNMPCB-125HP-S	1.25" (3.18 cm) Bracket w/ Hilti pins for concrete (100/pk) 1.25" (3.18 cm) Bracket w/ Hilti pins for steel (100/pk)
	MULTI-PURPOSE CABLE BRACKET	Used to secure cable around the perimeter of the net installation	BNMPCB125-100	1.25" (3.18 cm) Bracket (100/pk)
	NET SPIKES	Used to secure netting into concrete Drill Bits Large Net Spike: 6.5 mm Small Net Spike: 5.0 mm	BNNS-SM BNNS-LG*	Bird Net 3/16" (4.76 mm) Diameter Small Spike (100/pk) Bird Net 1/4" (6.35 mm) Diameter Large Spike (100/pk)
	LAG SCREWS	Used to secure cable around the perimeter of a net installation	BNLS-SSM* BNLS-LGG* BNLS-ASM	Small Steel Lag Screw (100/pk) Large Galvanized Lag Screw (100/pk) Small Lag Screw Anchor (100/pk)
	GIRDER CLIPS	Designed to attach cable to I-beams or steel surfaces 100 per pack	BN116GC BN018GC BN014GC BN012GC	Girder Clip: 1/16" - 1/8" (1.59mm - 3.1mm) Girder Clip: 1/8" - 1/4" (3.17mm - 6.35mm) Girder Clip: 1/4" - 1/2" (6.35mm - 12.7mm) Girder Clip: 1/2" - 3/4" (12.7mm - 19.05 mm)
	S-CLIPS	S-Clips are secured to the perimeter surface on one end and straining wire is strung through the other	BNMSCLP BNMSCLP-PIN-C BNMSCLP-PIN-S	S-Clip (100/pack) S-Clip w/Hilti Pin for concrete (100/pk) S-Clip w/Hilti Pin for steel (100/pk)
	THIN WIRE NET CLIP	Ideal for small net installations that require the net to be removed	BNTWNC-1	Thin Wire Net Clip (100/pack)
	STAINLESS STEEL NET LOOP	Ideal for wood and sheet metal	BNNL	Bird Net Loop (100 per pack)
	SPLIT PINS AND ANCHOR RIVETS	Used on stone or brick surfaces 100 per pack	BN10R BN10SP BN15R BN15SP	1" (2.54 cm) Rivet (100/pk) 1" (2.54 cm) Stainless Steel Split Pin (100/pk) 1.5" (3.81 cm) Rivet (100/pk) 1.5" (3.81 cm) Stainless Steel Split Pin (100/pk)
	2" HEAVY DUTY STEEL CLAMP	Designed for large installations and creates a strong hold on steel and I-beams	BNBCLP-2	2" (5.08 cm) Heavy Duty Steel Clamp (4/pk)
	6" ROOF TILE BRACKET	Used to install netting on roofs that have tiles	BNRTB-600	6" (15.24 cm) Roof Tile Bracket (10/pack)

*Available in 316 steel upon request.

CABLING (STRAINING WIRE)

Once you have installed the corner and intermediate attachments, it is time to run your cable or straining wire. Straining Wire is available in galvanized or stainless steel and in two different thicknesses for different size jobs.



ITEM	DESCRIPTION	DETAILS	ITEM #	PACK SIZE	
	3/32" (2.38 MM) For jobs OVER 50' in length	A perimeter cable to support your netting installation. Use galvanized cable for normal areas of installation. Use 316 grade stainless steel cable for areas near salt water, chemicals, etc.	3/32" Diameter, 7 x 7 Stranded Construction Cable	BNSW500G332 BNSW250G332 BNSW500S332 BNSW250S332	500' (152.40 m) Galvanized 250' (76.20 m) Galvanized 500' (152.40 m) Stainless Steel (316) 250' (76.20 m) Stainless Steel (316)
	1/16" (1.59 MM) For on jobs UNDER 50' in length	Use 316 grade stainless steel cable for areas near salt water, chemicals, etc.	1/16" Diameter, 7 x 7 Stranded Construction Cable	BNSW500G116 BNSW250G116 BNSW500S116 BNSW250S116	500' (152.40 m) Galvanized 250' (76.20 m) Galvanized 500' (152.40 m) Stainless Steel (316) 250' (76.20 m) Stainless Steel (316)
	BIRD NET CABLE CUTTER	A long lasting professional grade tool used to cut heavy duty cable. Durable, high quality tool. Easy to use.	Cuts both 1/16" and 3/32" straining wire.	BNCCT	1 each

FASTENERS

Fasteners are used to secure the cable and tighten the straining wire to prevent sagging or drooping.

Straining wire is attached to the anchors using ferrules. Ferrules are used at the first corner attachment and later at the turnbuckle. Run two ferrules through the end of the cable. Then loop the cable through the first corner attachment and back through the ferrules. Crimp the ferrules twice to lock the cable into place with a ratchet crimp tool.

Run cable through all intermediate attachments and finally through the turnbuckle at the end of the cable run. Turnbuckles are used to tighten your straining wire. Make sure the turnbuckle at the end of the run is fully open before securing and tightening the cable.

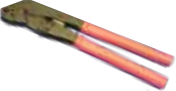
ITEM	DESCRIPTION	DETAILS	ITEM #	PACK SIZE	
	CABLE CLAMPS An alternative method of securing cable (instead of ferrules).	Use galvanized cable clamps for normal installation. Use stainless steel cable clamps for areas near salt water or chemicals, etc.	Runs up to 100' (30.48 m): Use two (2) clamps Runs over 100' (30.48 m): Use three (3) clamps	BNCC-G BNCC-S*	Cable Clamps Galvanized (10/pk) Cable Clamps Stainless (10/pk)
	FERRULES Used to clamp down and secure your straining wire at the ends.	Use aluminum ferrules with galvanized cable. Use copper ferrules with stainless steel cable. For use with Bird Net Ratchet Crimp Tool.	Use 3/32" ferrules with 3/32" cable Use 1/16" ferrules with 1/16" cable	BNF332A* BNF116A* BNF332C* BNF116C*	3/32" (2.38 mm) Aluminum (100/pk) 1/16" (1.58 mm) Aluminum (100/pk) 3/32" (2.38 mm) Copper (100/pk) 1/16" (1.58 mm) Copper (100/pk)
	TURNBUCKLES Used to tighten straining wire to prevent sagging or drooping.	Use galvanized turnbuckles with galvanized wire and aluminum ferrules. Use stainless steel turnbuckles and wire with copper ferrules for installations near salt water, chemicals, etc.	Cable runs under 25' (7.62 m): M5 turnbuckles Cable runs of 25' - 75' (7.62 m - 22.86 m), use M6 turnbuckles Cable runs over 75', use M8 turnbuckles	BNGTS (10/pk) BNGTM (10/pk) BNGTL (10/pk) BNSSTS (10/pk)* BNSSTM (10/pk)* BNSSTL (10/pk)*	M5 Small Galvanized Turnbuckle M6 Medium Galvanized Turnbuckle M8 Large Galvanized Turnbuckle M5 Small Stainless Steel Turnbuckle M6 Medium Stainless Steel Turnbuckle M8 Large Stainless Steel Turnbuckle
	BIRD NET RATCHET CRIMP TOOL	Used for crimping ferrules around straining wire.	Works with ferrules sized 1/16" (1.58 mm) to 3/32" (2.38 mm)	BNRCT-SBHS	1 each

*Available in 316 steel upon request.





HOG RINGING

Once your perimeter is established, netting is attached to the cable using a hog ring tool. This tool loops a metal ring around the net and the cable. You can apply a hog ring every other square when using ¾" netting.

Start on one corner and hog ring on a straight line leaving 2-4 squares of excess mesh. Stay on the same row of mesh or your netting will be uneven at the end. Proceed for about 3 feet and then return to the corner. Hog ring the net in the other direction.

At this point you should have a nice corner of netting attached to the cable. Proceed to finishing one side completely and move along to complete the installation on the remaining sides.

Once your net is installed, trim the excess netting and inspect all attachments for strength.

	ITEM	DETAILS	ITEM #	PACK SIZE
	HOG RING TOOL & HOG RINGS	Use galvanized rings for normal areas of installation Use stainless steel rings near salt water or chemicals Hog Ring Tool holds one cartridge of 50 hog rings.	BNHRT BNHRG BNHRS	Bird Net Hog Ring Tool (1) Galvanized Hog Rings (2,500/bx) Stainless Steel Hog Rings (2,500/bx)
	B14 HOG RING TOOL & HOG RINGS	Our most ergonomic manual hog ring tool Use galvanized rings for normal areas of installation Use stainless steel rings near salt water or chemicals Good for tight spaces	BNHRT-B14 BNHRT-B14-RING-G BNHRT-B14-RING-SS	Bird Net Hog Ring Tool B14 (1) B14 Galvanized Hog Rings (2,500/bx) B14 Stainless Steel Hog Rings (2,500/bx)
	BIRD-B-GONE® PNEUMATIC HOG RING TOOL & HOG RINGS	Lowest Cost Pneumatic Hog Ring Tool Fast operating / saves time and money Uses compressed air for quick & efficient installations. Ideal for large jobs Use stainless steel Hog Rings for areas near salt water, chemicals, etc.	BNHRTPN-AC01CH BNHRPG-AC31CH BNHRPS-AC31CH	Pneumatic Hog Ring Tool (1) Galvanized Hog Rings (10,000/bx) Stainless Steel Hog Rings (10,000/bx)
	STANLEY BOSTITCH PNEUMATIC HOG RING TOOL & HOG RINGS	Fast operating / saves time and money This tool uses compressed air for quick & efficient installations. Ideal for large jobs Use stainless steel Hog Rings for areas near salt water, chemicals, etc.	BNHRTPN (Stanley Item: SC761) BNHRPG* BNHRPS*	Pneumatic Hog Ring Tool (1) Galvanized Hog Rings (10,000/bx) Stainless Steel Hog Rings (10,000/bx) *Hog Rings also fit Stanley tools number SC461 and SC661







ACCESSORIES FOR ACCESS AND TOOLS

After the net has been installed there may be a need to access lighting and plumbing fixtures, safety equipment and such. Installing a zipper offers easy open and close access.

Keep the zipper closed, apply the hog rings to the cloth portion of the zipper, and attach the zipper to the net.

When you are done attaching both sides of the zipper with hog rings, open the zipper and cut the middle strands of net. This creates a hole that can be opened and closed.

ITEM	DESCRIPTION	DETAILS	ITEM #	PACK SIZE
 ZIPPERS	<p>Zippers are installed at areas that will need to be opened, such as under lighting fixtures or A.C. units. Hog rings are used to attach zippers to the net. Available in 7 sizes and 3 colors. Open-ended and custom sizes available.</p>	<p>1' (.30 m) Black 1.5' (.46 m) Black 2' (.61 m) Black 3' (.91 m) Black 4' (1.22 m) Black 6' (1.82 m) Black 8' (2.44 m) Black 10' (3.05 m) Black 1' (.30 m) Stone 3' (.91 m) Stone 6' (1.8 m) Stone 1' (.30 m) White 3' (.91 m) White 6' (1.8 m) White</p>	<p>BNZ-12B BNZ-18B BNZ-24B BNZ-36B BNZ-48B BNZ-72B BNZ-96B BNZ-120B BNZ-12S BNZ-36S BNZ-72S BNZ-12W BNZ-36W BNZ-72W</p>	1 each
 NET CLIPS	<p>Net Clips are installed in areas that will need to be opened such as under lighting fixtures or A.C. units.</p>	<p>3/4" (1.91 cm) Net Clip 2" (5.08 cm) Net Clip</p>	<p>BNNC-034 BNNC-200</p>	100 per pack
 BIRD SCAPE™	<p>Bird Scape™ is a netting accessory that lets trapped birds leave netted off areas. Features a funnel that birds can fly out of, but not back into. Installs directly into bird netting with hog rings.</p>		BNBS-05	1 Bird Scape™ per pack
 LAG SCREW DRIVER	<p>The Lag Screw Driver is a drill attachment used for installing lag screws into wood surfaces. For use with BNLS-SSM and BNLS-LGG.</p>		BNLSD	1 each
 SCREW EYE DRIVER	<p>The Screw Eye Driver is a small drill attachment used for installing Screw Eyes into wood surfaces. For use with all styles of screw eyes.</p>		BNSED	1 each
 SDS MASONRY DRILL BITS	<p>Masonry Drill Bits are used for drilling into concrete, brick, block, stone, or other masonry. Penetrates up to 50% faster than standard masonry bits.</p>	<p>Bird Net Drill Bit (5.0mm x 100mm) Bird Net Drill Bit (6.0mm x 100mm) Bird Net Drill Bit (6.5mm x 100mm) Bird Net Drill Bit (8.0mm x 100mm) Bird Net Drill Bit (10mm x 100mm) Bird Net Drill Bit (12mm x 100mm) Bird Net Drill Bit (14mm x 100mm)</p>	<p>BNDB0500 BNDB0600 BNDB0650 BNDB0800 BNDB0100 BNDB0120 BNDB0140</p>	1 each

HEAVY DUTY BIRD CONTROL STARTER KIT

BIRD NET ITEMS INCLUDED

- (1) Screw Eyes: Galvanized; Lg (25pk)
- (1) Screw Eyes: Galvanized; Sm (25pk)
- (1) Multi-Purpose Cable Bracket: 100pk
- (1) 3/16" Diameter Sm Spike; 100pk
- (1) Thin Wire Net Clip; 100pk
- (1) Hog Rings: Galvanized; 2,500pk
- (1) Net Bolts: Galvanized; Med (10pk)
- (1) Mini Net Bolts: Galvanized; 10pk
- (1) Ferrules: Aluminum; 100pk
- (1) Turnbuckles: Galvanized; Med (10pk)



TOOLS INCLUDED

- (1) Heavy Duty Portable Rolling Tool Box
- (1) Sikaflex® Gray Adhesive Glue Tube
- (1) Screw Eye Driver
- (1) Drill Bit: 12mm x 100mm
- (1) Drill Bit: 5mm x 100m
- (1) Hog Ring Tool
- (1) Lag Screw Driver
- (1) Bird Net Cable Cutter



BIRD WIRE ITEMS INCLUDED

- (1) Stainless 3.5" Steel Posts: 10pk
- (1) Stainless 5" Steel Posts: 10pk
- (1) Stainless Steel Springs: 25pk
- (1) Straining Wire Galvanized 1/16": 250ft
- (1) Glue-On Bases: 50pk
- (1) Nickel-Plated Copper Crimps: 100pk
- (1) Nylon Coated Bird Wire: 328ft

MISCELLANEOUS

- Copper Mesh: 20ft

ITEM #: INST-KIT



Marco Minero, Logistics

BLACK HARDWARE

Black oxide coating now available for net hardware.

- Straining wire
- Turnbuckles
- Multi purpose cable brackets
- Net bolts
- Hog rings



ITEM	DESCRIPTION	ITEM #	PACK SIZE
STRAINING WIRE	1/16" Straining Wire Galvanized Black	BNSW250G116-BLK	250' (76.20 m)
	3/32" Straining Wire Galvanized Black	BNSW250G332-BLK	250' (76.20 m)
	1/16" Straining Wire Stainless Black (316)	BNSW250S116-BLK	250' (76.20 m)
	3/32" Straining Wire Stainless Black (316)	BNSW250S332-BLK	250' (76.20 m)
	1/16" Straining Wire Galvanized Black	BNSW500G116-BLK	500' (152.40 m)
	3/32" Straining Wire Galvanized Black	BNSW500G332-BLK	500' (152.40 m)
	1/16" Straining Wire Stainless Black (316)	BNSW500S116-BLK	500' (152.40 m)
	3/32" Straining Wire Stainless Black (316)	BNSW500S332-BLK	500' (152.40 m)
	CORNER ATTACHMENTS	M6 Medium Net Bolt Galvanized Black	BNM6EB-BLK
M6 Medium Net Bolt Stainless Black		BNM6SSEB-BLK	10 pack
Mini-Net Bolt Galvanized Black		BNMNB-G-BLK	10 pack
INTERMEDIATE ATTACHMENTS	1.25" (3.18 cm) Black Multi-Purpose Cable Bracket w/Hilti pins for concrete	BNMPCB125-100-BLK	100 pack
	1.25" (3.18 cm) Black Multi-Purpose Cable Bracket w/Hilti pins for steel	BNMPCB-HPS-BLK	100 pack
FASTENERS	M8 Large Turnbuckle Galvanized Black	BNGTL-BLK	10 pack
	M6 Medium Turnbuckle Galvanized Black	BNGTM-BLK	10 pack
	M5 Small Turnbuckle Galvanized Black	BNGTS-BLK	10 pack
	M8 Large Turnbuckle Stainless Black	BNSSTL-BLK	10 pack
	M6 Medium Stainless Galvanized Black	BNSSTM-BLK	10 pack
	M5 Small Stainless Galvanized Black	BNSSTS-BLK	10 pack
HOG RINGS	Bird B Gone Pneumatic Zinc Black Hog Rings	BNHRPZ-AC31CH-BLK	10,000/box
	B14 Zinc Black Hog Rings	BNHRT-B14-RINGS-Z-BLK	2,500/box
	Zinc Black Hog Rings	BNHRZ-BLK	2,500/box

ADVANTAGES & BENEFITS

- » Block bats from entering unwanted areas.
- » Long lasting UV protected polyethylene mesh.



WHERE TO USE	Eaves, canopies, attics, bell towers, etc.
MATERIAL	3/8" (9.52 mm) polyethylene knotted black mesh
GUARANTEE	10 years

ITEM #	AREA
BAT-10X10	10' x 10' (3.05 m x 3.04 m)
BAT-25X25	25' x 25' (7.62 m x 7.62 m)
BAT-50X50	50' x 50' (15.24 m x 15.24 m)
BAT-50X100	50' x 100' (15.24 m x 30.48 m)
BAT-CUSTOM	Custom*

*All custom cuts 100 sq. ft. minimum.

ULTRA NET™

ADVANTAGES & BENEFITS

- » Protects plants and crops.
- » Easy to handle and install.
- » 3 sizes of mesh to exclude all birds.
- » Inexpensive one season netting.
- » Available in bulk rolls or small sizes.
- » Lightweight and virtually invisible.

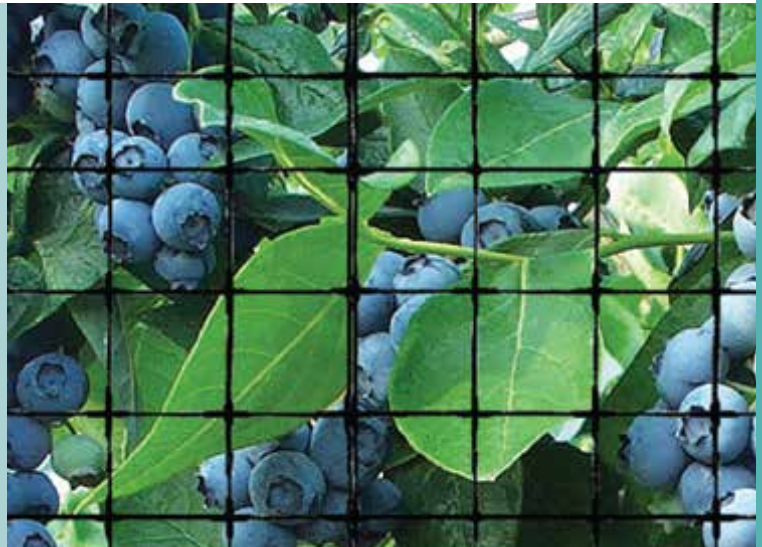

BIRD SPECIES	All birds
WHERE TO USE	Gardens, vineyards, fruit trees, bushes, eaves, orchards, etc.
MATERIAL	UV protected polypropylene

ITEM #	MESH SIZE	AREA
UN-141	1/4" (6.3 mm)	14' x 100' (4.27 m x 30.48 m)
UN-142	1/4" (6.3 mm)	14' x 200' (4.27 m x 60.96 m)
UN-121	1/2" (12.7 mm)	14' x 100' (4.27 m x 30.48 m)
UN-122	1/2" (12.7 mm)	14' x 200' (4.27 m x 60.96 m)
UN-123	1/2" (12.7 mm)	14' x 3,000' (4.27 m x 914.40 m)
UN-341	3/4" (19 mm)	14' x 100' (4.27 m x 30.48 m)
UN-342	3/4" (19 mm)	14' x 200' (4.27 m x 60.96 m)
UN-343	3/4" (19 mm)	14' x 5,000' (4.27 m x 1524 m)

POLY-CLIP

For fast and easy installation of Ultra Net™



ITEM #	PACK SIZE
UNCLIPS-CASE	Case Clips (250 per box)
UNCLIPS-1/2CASE	Half Case Clips (125 per box)

POND NETTING

ADVANTAGES & BENEFITS

- » Most efficient & effective method for excluding birds.
- » Protect water fowl from oil and contaminated water.
- » Prevent costly lawsuits from bird deaths.
- » Durable construction for harsh environments.
- » Break strengths from 116 lbs. to 740 lbs.
- » Available in several mesh sizes from ¾" to 4".
- » Custom sizes; call to order.



FEATURES

BIRD SPECIES	All birds
WHERE TO USE	Tailing ponds, retention ponds, water collection sites, oil pits
GUARANTEE	10 years
MATERIAL	High density UV protected polyethylene knotted netting (HDPE) Nylon pond netting (made in the USA) is also available

FLAME NET

ADVANTAGES & BENEFITS

- » Ideal for use in inside applications such as airplane hangars, large warehouses, and even residential installations.
- » Netting extinguishes itself using a revolutionary red strand of filament.
- » Will stop itself from burning when exposed to open flame.
- » Break strength in excess of 33 lbs.
- » Easily installed with same hardware as Bird Net 2000™
- » Test report available upon request.
- » Industry leading 10 year guarantee.



FEATURES

ITEM #	AREA
034FR50X100	50' x 100'
034FRCUSTOM	Custom* Includes extra free foot

*All custom cuts 100 sq. ft. minimum.



Bird•B•Gone® Gives H-E-B Retailers Net Advantage to Keep Birds Out



Completed installation of Bird Net 2000 Heavy-Duty Netting™.

Headquartered in Texas, H-E-B is one of the largest independent food retailers in the nation. As a pre-emptive measure to keep pigeons and starlings away from outside grocery displays and other areas around H-E-B locations, Gulf States Bird Control installed Bird•B•Gone® Heavy-Duty Bird Netting.

Issues to be addressed: At each of the H-E-B stores, Gulf States Bird Control is installing durable heavy-duty netting in order to protect storefront produce areas. Without netting, these pest birds are free to leave droppings, resulting in potentially hazardous areas for customers.

Product Installed: Bird•B•Gone® Bird Net 2000™ Heavy Duty Netting in ¾-inch mesh and black color.

Challenges to Overcome: Gulf State Bird Control has the experience, tools and hardware necessary for efficient and successful installations on the existing H-E-B stores. However, the main challenge to overcome involved installing the net onto new store locations currently under construction.

Solution: Bird•B•Gone®'s heavy-duty bird netting ensures that the areas on and around the grocery stores are free of pest pigeons and starlings. The highest priority is that the netting keeps produce areas free of disease-carrying bird droppings. Gulf States Bird Control has been using Bird•B•Gone®'s heavy-duty bird netting for over 18 years—with no callbacks. The netting has the ability to withstand a variety of extreme environments. Occasionally, the temperature drops down to as low as 30 degrees in Texas but the netting continues to hold up. The areas on and around H-E-B grocery stores—old and new—are free of pest pigeons and starlings. Produce areas are free of harmful bird droppings. Once Bird•B•Gone® Heavy-Duty Netting goes up, birds stay out.

ELECTRIC TRACK

Many customers face expensive clean-up bills, removing birds and bird droppings from signage, windows, awnings and walkways. Restaurant owners and others who deal with food face fines and shutdowns as health inspectors note evidence of bird droppings in or around their property. Fortunately, there is a solution to the pest bird problem.

Harmlessly “Educates” Pest Birds to Stay Away

Bird•B•Gone® low-profile electric track bird deterrent system prevents birds from landing or nesting in unwanted areas. The unique electrically charged tracks impart a mild electrical shock when birds land on them. The shock will not harm birds, but will condition them to avoid the area.

Multiple Birds, Multiple Locations

The Bird Jolt Flat Track® system is ideal for use in a multitude of applications where pest birds habitually perch and roost. This low-profile solution is ideal for ledges, rooflines, parapet walls, I-beams, eaves, signs, and virtually any flat or curved surface. Electric track is highly effective for all birds including pigeons, sparrows, gulls, starlings, crows and many others.



*Scott Swanson
Bird Control Expert*

BIRD JOLT FLAT TRACK®

ADVANTAGES & BENEFITS

Bird Jolt Flat Track® is a low profile electrical track system which produces a mild electrical “jolt” when birds land on it. It uses copper knitted wire mesh, in a continuous “tube-in-tube” stocking design. This allows for greater conductivity, strength and reliability.

- » The ultimate product for modifying bird behavior.
- » #1 specified electric track by architects and government agencies.
- » Does not harm birds.
- » Patented “anti-arcing” design means the ultimate in safety.
- » Effective for both small and large pest birds.
- » Crush proof; will continue to work even if stepped on by window washers or building maintenance crews.
- » Glue troughs allow for easy installation with construction grade adhesive.
- » Completely flexible; can bend 360°.
- » Low profile and virtually invisible. Only 1/4” (6.35 mm) tall.
- » “Snug-fit” connectors make it the easiest shock system to install.
- » Comes in easy-to-dispense box and can be cut with scissors.
- » Bird Jolt Flat Track® Kits available.

PATENTS

- » US 6250023
- » US 7596910
- » US 7941977
- » US 8191303
- » US 8245435
- » US 8250814
- » US 9032663
- » US 9101127
- » US 9232781
- » AU 2013205241
- » CA 2750218
- » CN 102356699



PATENTED ANTI-ARCING DESIGN

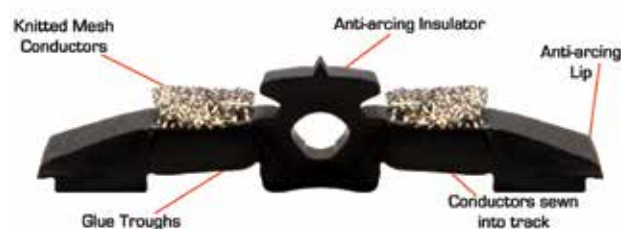



FEATURES

BIRD SPECIES	All birds
WHERE TO USE	Ledges, signs, rooftops, I-beams, parapet walls, conduit, flat or curved surfaces
BIRD PRESSURE	Light, Medium, or Heavy
MATERIAL	Lightweight flexible UV stabilized PVC with copper knitted wire mesh “tube-in-tube” stocking design
DESIGN	Lightweight: 100’ (30.48 m) of track weighs only 16 lbs (7.26 kg)

AVAILABLE COLORS



COLOR	LENGTH	ITEM #
Clear	100’ (30.48 m)	BJFT-CLR
Stone	100’ (30.48 m)	BJFT-STN
Black	100’ (30.48 m)	BJFT-BLK
Gray	100’ (30.48 m)	BJFT-GRY
Red	100’ (30.48 m)	BJFT-RED
Terracotta	100’ (30.48 m)	BJFT-TER

SELECT AND ADHERE THE TRACK

Light Infestation (large birds)

Single row of track at the outer edge(s):

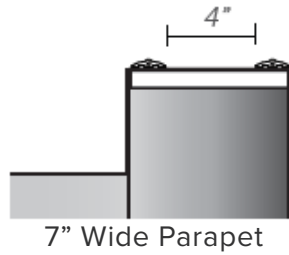
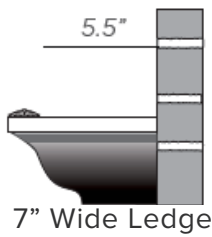

Heavy Infestation (large or small birds)

Multiple rows of track:

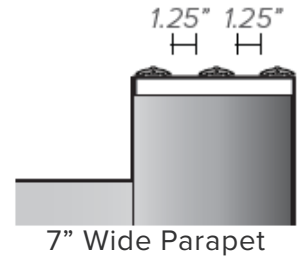
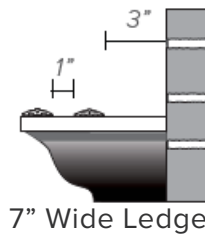





Bird Jolt Flat Track® easily glues in place with construction grade adhesives. Installation requires general knowledge of electrical systems. If you have questions or need an Authorized Installer call us at 800.392.6915.



See page 78

INSTALLATION ACCESSORIES

ITEM	DESCRIPTION	ITEM #	SIZE	COLOR
 SNUG-FIT™ CONNECTORS	Used to connect track to a charger, to branch off in a new direction, or to connect two pieces of track.	BJFT-SFC10	10/pack	Gray
		BJFT-SFC10-BLK	10/pack	Black
 SNUG-FIT™ CORNER CONNECTORS	Used to turn a 90° corner with the Bird Jolt Flat Track®.	BJFT-SFCC	10/pack	Gray
		BJFT-SFCC-BLK	10/pack	Black
 BLUE WIRE CONNECTORS	Used to connect electric track together or to a charger from the Snug-Fit™ Connectors.	BJFT-BCN100	100/pack	Blue
 ANTI-DAMMING RISERS	Used to lift track to prevent water from damming or to install on a surface that is hard to glue onto.	BJFT-ADR	10/pack	Gray
 T-CONNECTORS	Connect track to a charger, to branch off in a new direction, or to connect intersecting track.	BJFT-TC10	10/pack	Gray

CONNECT AND TEST THE TRACK



SOLAR CHARGER

Uses sunlight to supply power to up to 300' of electric track. Completely weatherproof.



DIRECT CHARGER

Plugs into a regular 110v outlet and supplies power up to 500 feet of electric track. If outdoors, use weatherproof box.

DIMENSIONS	9.75" x 6.5" x 6.5" (24.77 cm x 16.51 cm x 16.51 cm)	4.75" x 4.5" x 2.25" (12 cm x 11.5 cm x 5.7 cm)
WEIGHT	3.5 lbs. (1.59 kg)	13.6 oz. (386 g)
AREA	300' (91.44 m) of track	500' (152.4 m) of track
VOLTAGE	Input Voltage: 4 VDC Output Voltage: 7.0 KV (+/-) 20% Open Circuit Voltage, Intermittent DC Output	Input Voltage: 110 - 120VAC Output Voltage: 750 V (+/-) 20% Open Circuit Voltage, Intermittent AC Output
ITEM #	CHG-SLR740	CHG-AC750



INSTALLATION COMPONENTS

ITEM	DESCRIPTION	ITEM #	PACK SIZE
	CONNECTOR LOOPS Used to attach the copper lead-in wire to your charger.	STPWC-10	10
	BILINGUAL WARNING LABELS Placed every 10' to warn people of possible shock. (English/Spanish)	BJFTWRNBI-10	10
	VOLTAGE TESTER Used with the Electric Track systems to test the systems' output voltage.	BJFT-VLT	1
	SOLAR BATTERY REPLACEMENT Battery for the Solar Charger (CHG-SLR740) should be replaced about once a year.	CHG-SLR740BAT	1
	WATERPROOF BOX Protects Direct Chargers from weather when installed outdoors. (Dimensions: 8"x8"x4")	CHG-ACBOX	1

14 GAUGE MARINE GRADE COPPER LEAD-IN WIRE

Used to connect your charger to the electric track systems and also connect sections of track. Available in three colors and three roll sizes.



COLOR	LENGTH	ITEM #
Black	20' (6.10 m)	BJFT-LIW20BLK
Black	50' (15.24 m)	BJFT-LIW50BLK
Black	100' (30.48 m)	BJFT-LIW100BLK
Gray	20' (6.10 m)	BJFT-LIW20GRY
Gray	50' (15.24 m)	BJFT-LIW50GRY
Gray	100' (30.48 m)	BJFT-LIW100GRY
Stone	20' (6.10 m)	BJFT-LIW20STN
Stone	50' (15.24 m)	BJFT-LIW50STN
Stone	100' (30.48 m)	BJFT-LIW100STN

ENSURE SYSTEM SAFETY AND INTEGRITY

BILINGUAL WARNING LABELS



Placed every 10' to warn people of possible shock. (English/Spanish)



ITEM #	PACK SIZE
BJFTWRNBI-10	10

THE BIRD JOLT FLAT TRACK® KIT



The Bird Jolt Flat Track® Kits come in a light-weight, easy-to-dispense box with carrying handle. Each kit contains:

- Bird Jolt Flat Track® (Choose Color) 100' (30.48 m)
- Lead-in Connector Loops (2 each)
- Snug Fit™ Track Connectors (3 each)
- Bilingual Warning Labels (10 each)
- Snug Fit™ Corner Connectors (3 each)
- Blue Wire Connectors (10 each)
- Lead wire and charger sold separately.

COLOR	LENGTH	ITEM #
Gray	100' (30.48 m)	BJFTKIT-GRY
Stone	100' (30.48 m)	BJFTKIT-STN
Terracotta	100' (30.48 m)	BJFTKIT-TER
Black	100' (30.48 m)	BJFTKIT-BLK
Red	100' (30.48 m)	BJFTKIT-RED
Clear	100' (30.48 m)	BJFTKIT-CLR

TWO MINUTE TUESDAY PRO BIRD CONTROL TIPS

Bird-B-Gone® posts quick videos with our bird control tips. Hear from Jeff, Scott and other members of our bird control team on useful, practical tips related to bird control and successful product installations.



Tuesday



Bird•B•Gone® conducts advanced Bird Jolt Flat Track® training in Arizona

A PGA building in Arizona was having pest bird problems. Bird feces and nests were creating unhealthy and hazardous conditions for staff and guests. To make matters worse, a poorly installed net had fallen around the facility's air handlers. As the job posed a number of installation challenges, Chemtech utilized the on-site training option offered by Bird•B•Gone® to:

1. Offer hands-on instruction to team members
2. Highlight and clarify installation techniques
3. Confirm the selected products for the job
4. Ensure that all products are installed properly

Goal of Installation: Prevent birds from landing on horizontal surfaces. Block birds from entering unwanted areas. Remove the old cabling, anchors, and net that were poorly installed and had fallen around the air handlers.



Product Installed: Bird Jolt Flat Track®

To prevent birds from landing on the horizontal surfaces the team chose to install Bird Jolt Flat Track®. Bird Jolt Flat Track® is an electric track system that produces a mild electric shock when birds land on it. The non-intrusive, low profile and patented anti-arching design made this an ideal choice. The electric track system was properly installed in various “high bird pressure” areas and has successfully deterred the birds and kept them away.



Product Installed: Bird Net 2000™

To block birds from entering unwanted areas, the team chose to install the most efficient and effective bird exclusion product, heavy duty black 2 in. mesh bird netting – Bird Net 2000™. The old cabling, anchors and net were removed. New heavy duty netting was properly installed and correctly anchored.

The result: a humane and highly effective bird control installation that keeps birds and their droppings away from the building.

DETERRENTS

Bird•B•Gone® has a wide variety of effective and humane products to deter pest birds.

Physical, visual, and sound deterrents make areas inaccessible, unstable, and uncomfortable for birds, keeping them from landing, roosting or nesting, and forcing them to move on to a new location.

- **Physical deterrents** are ideal for use on flat surfaces in concentrated areas like ledges, parapet walls, windowsills, roof edges, and more.
- **Visual bird deterrents** create distraction zones that confuse the birds causing them to flee the area.
- **Sound deterrents** use bird distress and predatory calls to startle and warn birds so they leave the targeted area.

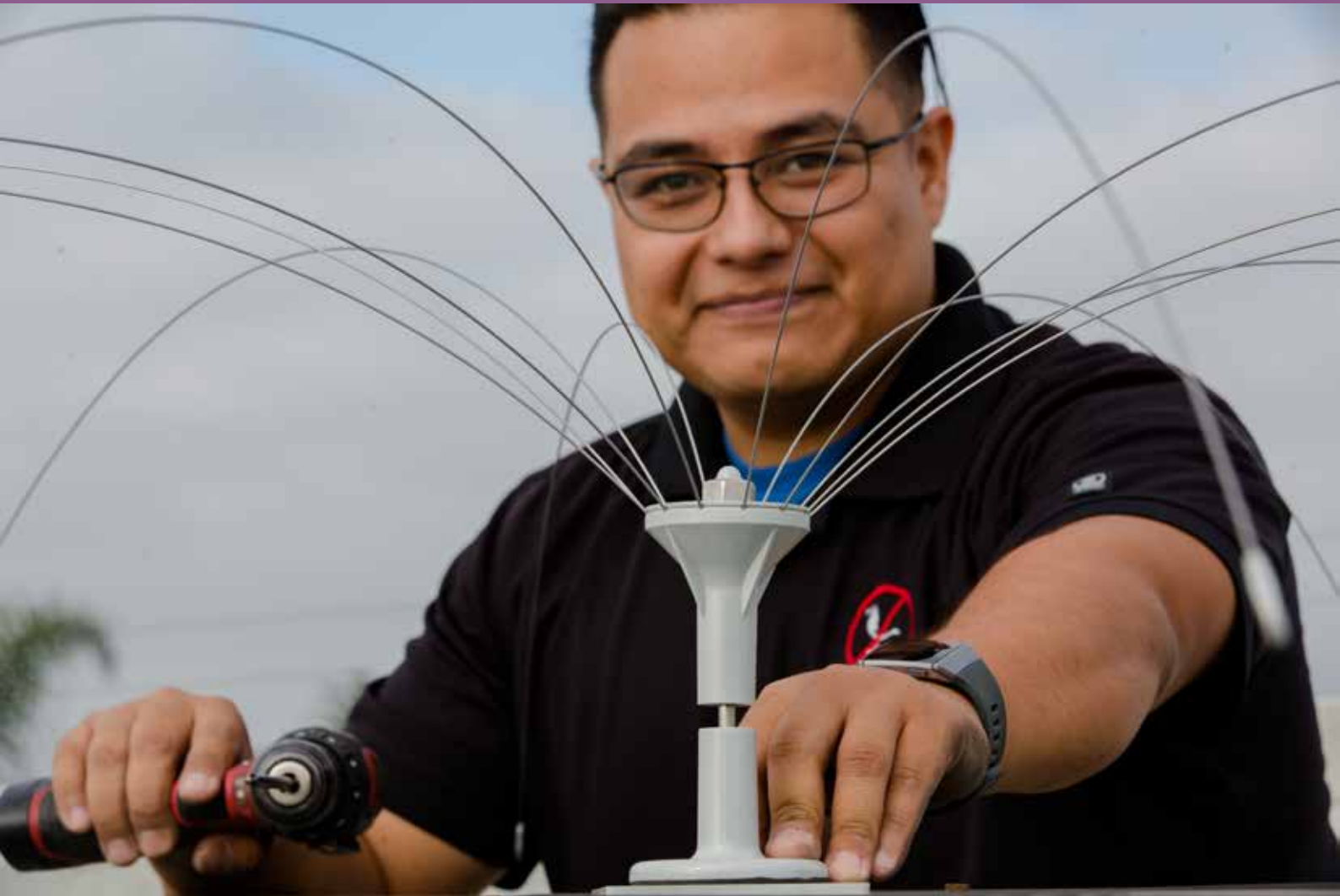

Azael Silva
Quality Control Engineer

BIRD SLOPE™

ADVANTAGES & BENEFITS

The unique design of Bird Slope™ makes it impossible for birds to land or roost on 90° areas like eaves and ledges.

- » Prevents birds from landing and nesting on ledges up to 5.5" (13.97 cm) wide.
- » Unique "Slope Extender" increases coverage for areas up to 10.5" (26.67 cm) wide.
- » Effective for both large and small birds.
- » Ideal for parking garages, I-beams and 90° ledges.
- » Glue trough on underside for easy adhesive application.
- » Easy-to-install End Caps prevent birds from getting behind Slope.
- » Made of a UV-protected outdoor grade PVC plastic.
- » Longest guarantee and lowest cost.
- » Fast installation with 4' (1.22 m) sections.



Bird Slope™ installed under eaves.

PATENTS & FEATURES

» US8640397	BIRD SPECIES	All birds
» US8689497	WHERE TO USE	Ledges, parking garages, I-beams with widths up to 10.5" (26.67 cm)
» US8925256	BIRD PRESSURE	Light, Medium, or Heavy
» US9185900	GUARANTEE	2 years
	MATERIAL	UV protected outdoor grade PVC

COLOR	AREA	ITEM #	PACK SIZE
Gray	5.5" (13.97 cm)	SLP-GRY4	4' (1.22 m) sections 48' (14.63 m) per box
Stone	5.5" (13.97 cm)	SLP-STN4	4' (1.22 m) sections 48' (14.63 m) per box



INSTALLATION



Bird Slope™ installed on window sills.







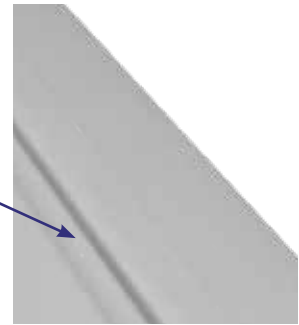

Bird Slope™ Installed in parking garages.

To install: Surface should be clean and dry before installation. Bird Slope covers a 5.5" ledge; for larger ledges Extenders are available. Glue onto surface using glue troughs. End Caps should be installed to prevent birds from getting behind Slope.



See page 78



ITEM	DESCRIPTION	DETAILS	ITEM #	PACK SIZE
 BIRD SLOPE™ EXTENDERS	Bird Slope™ Extenders can be attached to cover ledges between 5.5" to 10.5" wide.	Easily adapts Bird Slope™ to wider ledges (up to 10.5") Extender "snaps on" the top of Bird Slope™	SLPEXT-GRY4 (Gray) SLPEXT-STN4 (Stone)	4' (1.22 m) sections 48' (14.63 m)/box 4' (1.22 m) sections 48' (14.63 m)/box
 BIRD SLOPE™ CONNECTORS	Slope Connectors eliminate gaps between two pieces of Slope.	Connectors available for Bird Slope™ and Slope Extenders Ideal for sloped surfaces. Snap into place	SLPCONGRY-10 SLPCONSTN-10 SLPCONEXTGRY-10 SLPCONEXTSTN-10	Slope Connector: Gray (10 pk) Slope Connector: Stone (10 pk) Extender Connector: Gray (10 pk) Extender Connector: Stone (10 pk)
 MOUNTING CLIPS	Use Mounting Clips to install Bird Slope™ on vertical surfaces.	One clip every 1' (30.48 cm) 20 per pack	SLP-MC20	20 per pack: Clear
 END CAPS	Block birds from entering the open area behind slope.	Simply glue the end cap to each end Available in 2 colors	SLPECAP-GRY SLPECAP-STN	10 per pack: Gray 10 per pack: Stone
 EXTENDER END CAPS	Block birds from entering the area behind extended-width slope.	For use with Bird Slope Extenders™. Glues into place.	SLPEXTCAP-GRY SLPEXTCAP-STN	10 per pack: Gray 10 per pack: Stone

BIRD WIRE

ADVANTAGES & BENEFITS

Bird Wire is a post and wire system that provides an unstable landing area for pigeons, seagulls, or crows. Ideal for areas where aesthetics are a concern, the low-profile Bird Wire involves a series of stainless steel posts supporting nylon coated 316 stainless steel wire that is tensioned between the posts using springs.

- » #1 Bird Wire system specified by architects.
- » CAD details and specifications available at birdbgone.com.
- » Low profile and low visibility.
- » Low maintenance.
- » Ideal for hand rails.
- » Affordable pricing.
- » Industry leading 5 year guarantee.
- » Approved for use on federal and state government structures.







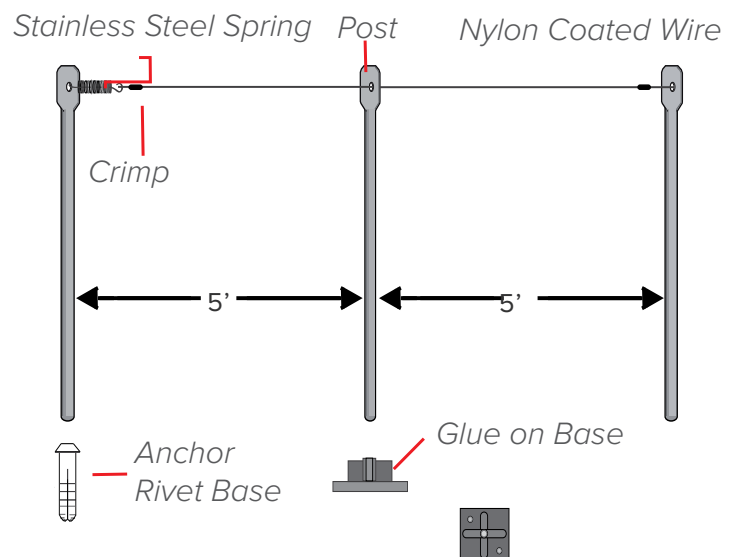
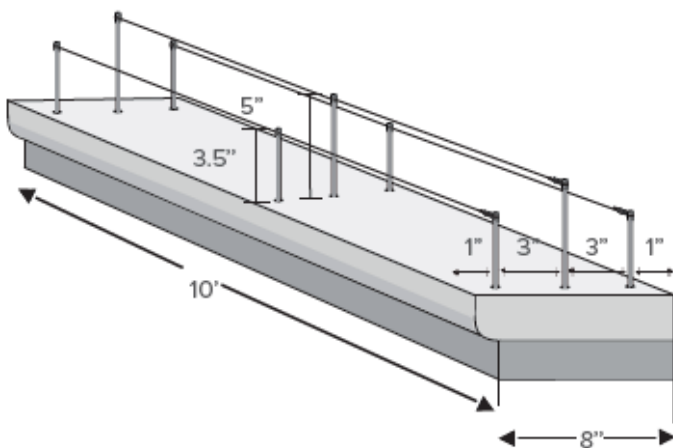



FEATURES

BIRD SPECIES	Pigeons and seagulls
WHERE TO USE	Ledges, signs, rooftops, curved or flat surfaces
BIRD PRESSURE	Light to Medium
GUARANTEE	5 years
MATERIAL	316 Stainless steel wire coated with UV stabilized clear nylon



INSTALLATION

Surface should be clean and dry before installation. Measure surface area to determine how many rows are required. Posts are placed every 5' with a new spring every 10'. Alternate post heights when installing multiple rows.

ITEM	DESCRIPTION	DETAILS	ITEM #	PACK SIZE															
	NYLON COATED BIRD WIRE	Strung between Stainless Steel Posts.	316 Stainless steel wire coated with UV stabilized clear nylon. .045 mm 1 x 7 wire	BWNCW1 BWNCW2	820' (250 m) Roll 328' (100 m) Roll														
	GLUE-ON BASES	Can be screwed or glued onto surfaces where drilling is not an option.	UV protected glass filled nylon. Support Bird Wire post	BWB100 BWB050	Gray Bases (100 per pack) Gray Bases (50 per pack)														
	STAINLESS STEEL POSTS	Used to suspend Bird Wire.	4 mm diameter, 316 marine grade stainless steel posts. Ends are beveled to aid installation into either the anchor rivet or glue-on base	BWSSP60-100 BWSSP60-25 BWSSP50-100 BWSSP50-25 BWSSP45-100 BWSSP45-25 BWSSP35-100 BWSSP35-25	6" (15.24 cm) Post (100 per pack) 6" (15.24 cm) Post (25 per pack) 5" (12.70 cm) Post (100 per pack) 5" (12.70 cm) Post (25 per pack) 4.5" (11.43 cm) Post (100 per pack) 4.5" (11.43 cm) Post (25 per pack) 3.5" (8.89 cm) Post (100 per pack) 3.5" (8.89 cm) Post (25 per pack)														
	NICKEL-PLATED COPPER CRIMPS	Used to secure bird wire to the posts.	Nickel-plated for durability	BWCC-100	Copper Crimps (100 per pack)														
	RAILING CLAMPS	Used to attach Bird Wire system to railings or pipes.	Adjustable clamps with 3.5" (8.89 cm) Bird Wire posts.	BWRC-1 BWRC-2 BWRC-3 BWRC-4 BWRC-4-2 BWRC2P-6	<table border="0"> <tr> <td><i>Clamp Size</i></td> <td><i>Railing Size</i></td> </tr> <tr> <td>1" (2.54 cm) 1 Post (10/pk)</td> <td>3/4" - 1-1/4" (1.91 cm - 3.18 cm)</td> </tr> <tr> <td>2" (5.08 cm) 1 Post (10/pk)</td> <td>1-5/16" - 2-1/2" (3.33 cm - 6.35 cm)</td> </tr> <tr> <td>3" (7.62 cm) 1 Post (10/pk)</td> <td>2-9/16" - 3-1/2" (6.51 cm - 8.89 cm)</td> </tr> <tr> <td>4" (10.16 cm) 1 Post (10/pk)</td> <td>3-9/16" - 4-1/2" (9.05 cm - 11.43 cm)</td> </tr> <tr> <td>4" (10.16 cm) 2 Posts (10/pk)</td> <td>3-9/16" - 4-1/2" (9.05 cm - 11.43 cm)</td> </tr> <tr> <td>6" (15.24 cm) 2 Posts (10/pk)</td> <td>5-1/8" - 6" (13.02 cm - 15.24 cm)</td> </tr> </table>	<i>Clamp Size</i>	<i>Railing Size</i>	1" (2.54 cm) 1 Post (10/pk)	3/4" - 1-1/4" (1.91 cm - 3.18 cm)	2" (5.08 cm) 1 Post (10/pk)	1-5/16" - 2-1/2" (3.33 cm - 6.35 cm)	3" (7.62 cm) 1 Post (10/pk)	2-9/16" - 3-1/2" (6.51 cm - 8.89 cm)	4" (10.16 cm) 1 Post (10/pk)	3-9/16" - 4-1/2" (9.05 cm - 11.43 cm)	4" (10.16 cm) 2 Posts (10/pk)	3-9/16" - 4-1/2" (9.05 cm - 11.43 cm)	6" (15.24 cm) 2 Posts (10/pk)	5-1/8" - 6" (13.02 cm - 15.24 cm)
<i>Clamp Size</i>	<i>Railing Size</i>																		
1" (2.54 cm) 1 Post (10/pk)	3/4" - 1-1/4" (1.91 cm - 3.18 cm)																		
2" (5.08 cm) 1 Post (10/pk)	1-5/16" - 2-1/2" (3.33 cm - 6.35 cm)																		
3" (7.62 cm) 1 Post (10/pk)	2-9/16" - 3-1/2" (6.51 cm - 8.89 cm)																		
4" (10.16 cm) 1 Post (10/pk)	3-9/16" - 4-1/2" (9.05 cm - 11.43 cm)																		
4" (10.16 cm) 2 Posts (10/pk)	3-9/16" - 4-1/2" (9.05 cm - 11.43 cm)																		
6" (15.24 cm) 2 Posts (10/pk)	5-1/8" - 6" (13.02 cm - 15.24 cm)																		
	STAINLESS STEEL SPRINGS	Causes the Bird Wire to be unstable when birds land on it.	316 Grade Stainless Steel Springs. Two sizes available: Standard & Micro	BWSSS-100 BWSSS-50 BWMS1 BWMS1-5	Standard Springs (100 per pack) Standard Springs (50 per pack) Micro Springs (100 per pack) Micro Springs (50 per pack)														
	GUTTER & GIRDER CLAMPS	Used to attach the Bird Wire system to gutters or girders.	Fits I-beams up to 3/4" (1.91 cm) thick.	BWBC00 BWGC00	Bird Wire Beam Clamp (10 per pack) Bird Wire Gutter Clamp (10 per pack)														
	ANCHOR RIVETS	Support Bird Wire posts when drilled into surface.	Use 6.5 mm drill bit	BN10R BN15R	1" (25.4 mm) Anchor Rivet (100/pk) 1.5" (38.1 mm) Anchor Rivet (100/pk)														
	3-POST RIDGE BRACKET	Designed for roof peaks & special installation areas.	Stainless steel brackets perfect for angled surfaces and corners	BW3PRB	3-Post Ridge Bracket (each) (3) 3.5" (8.89 cm) posts														

SOLAR PANEL BIRD DETERRENT KIT

ADVANTAGES & BENEFITS

Rooftop solar panels create an ideal environment for pigeons and other pest birds to nest and roost. The panels provide shade from the hot sun, security from predators, and an easy in-and-out vantage point for birds. The best way to address this problem is to install bird deterrents, when the solar panels are first installed or before the pest birds arrive.

- » The weather-resistant mesh effectively blocks pest birds from nesting and roosting under panels.
- » No drilling required.
- » Mesh is virtually invisible once installed.
- » Clips will not scratch or affect integrity of solar panels.



BIRD SPECIES	All birds
WHERE TO USE	Under solar panels
BIRD PRESSURE	Light, Medium, or Heavy
MATERIAL	UV resistant materials

ITEM	ITEM #	PACK SIZE
Solar Panel Bird Deterrent Kit	SLRKIT-50	(35) Solar Clips (10) 5' x 8" Weather Resistant Mesh Panels
Solar Panel Bird Deterrent Mesh	SLRMESH	100 roll: 8"x100" 1/2"
Solar Panel Bird Deterrent Clips	SLRCLPS-35 SLRCLPS-50 SLRCLPS-100	35 Solar Clips 50 Solar Clips 100 Solar Clips



Durable clips easily install without drilling



Weather Resistant Mesh Panels



100-foot rolls available



Installed Kit

INSTANT REPAIR PATCH

ADVANTAGES & BENEFITS

The Instant Repair Patch is an easy-to-use, UV activated patch that creates long-lasting repairs. This reinforced polyester patch is perfect for making watertight, durable seals on a variety of objects. Repair minor pest entrance points on warehouses, big box stores, homes and other structures to exclude birds and pests from intrusion in unwanted areas.

- » No mixing, measuring, or mess.
- » Will not rot or rust, sandable, can be drilled or taped, accepts paint in 1 hour.
- » Fast curing - in as little as 5 min. depending on UV intensity.
- » Bonds to all surfaces except Polypropylene (PP).



ITEM	ITEM #
Instant Repair Patch - 3" X 6"	PATCH-3X6
Instant Repair Patch - 6" X 9"	PATCH-6X9
Instant Repair Patch - 9" X 12"	PATCH-9X12
UV Flashlight	PATCH-LIGHT

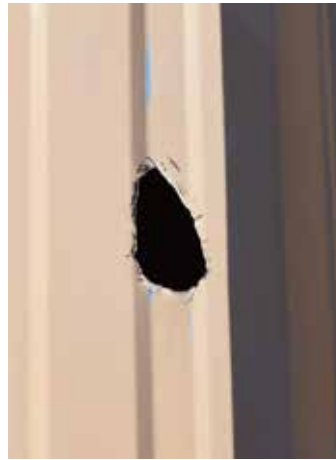

BEFORE



AFTER



3"x6" Instant Repair Patch

UV Flashlight

BIRD SPIDER 360°®

ADVANTAGES & BENEFITS

The Bird Spider 360°® is a humane stand-alone physical bird deterrent that is used to prevent birds from landing. The Bird Spider 360°® can be used in a variety of settings including: Boats, docks, Biminis, light posts, air conditioner units, skylights, dock pilings, and more!

- » Bird Spider 360°® is a visual bird deterrent used to scare large birds away from concentrated areas.
- » This bird deterrent is humane, safe, and will not harm birds.
- » No-tangle "arms" bounce and sway in the wind, creating a visual distraction zone so birds will not want to come near the area.
- » Pre-assembled, easy to install; available in 2 ft., 4 ft., 6 ft., and 8 ft. diameters for optimal coverage.
- » Patented design has been high wind tested – will not break or fall off in high wind areas.
- » Preassembled and easy-to-install.





PATENTS & FEATURES

» US7036278

BIRD SPECIES	Pigeons, seagulls, and larger birds
WHERE TO USE	AC units, street lights, signs, boats, rooftops
BIRD PRESSURE	Light to Medium
MATERIAL	316 marine grade stainless steel "arms" on a UV protected polycarbonate base. Separate PVC base and #10 316 grade screws included.

DIAMETER	AREA	ITEM #
2' (0.61 m)	1'- 2' (0.30 m - 0.61 m)	BS200SPN
4' (1.22 m)	3'- 4' (0.91 m - 1.22 m)	BS400SPN
6' (1.83 m)	4'- 6' (1.22 m - 1.83 m)	BS600SPN
8' (2.44 m)	6'- 8' (1.83 m - 2.44 m)	BS800SPN

INSTALLATION ACCESSORIES

ITEM	DESCRIPTION	DETAILS	ITEM #	PACK SIZE	
	BOAT BASE	Used to install the Bird Spider around masts or spreaders.	Attaches directly to Bird Spider 360° Secures with bungee cords or other tie-down systems.	BSBB2	1 per pack
	SAND BAG BASE	Provides a portable weighted option for boat canvases and Biminis.	Attaches directly to Bird Spider 360° and Repeller 360°™. Hardware included Weighs 6.5 lbs.	BSBB-SB	1 per pack
	RAILING MOUNT	Easily secures Repeller 360° and Bird Spider 360° to railing sizes up to 1.875" thick.	Includes disk and screws for mounting/attachment. Can easily be removed and stowed while sailing or cruising.	RLMNT	1 per pack



Bird Spider 360°® easily glues in place using the included base. The Bird Spider 360°® features long lasting UV protected polycarbonate tips that help the arms bounce and sway in the wind, also prevent scuffing on surfaces.



BIRD CHASE SUPER SONIC™

ADVANTAGES & BENEFITS

The Bird Chase Super Sonic™ is an outdoor sound device used to deter pest birds. Distress and predator calls from 24 types of birds are broadcast for two minutes at ten minute intervals to scare pest birds from large open spaces.

- » Includes goose deterrent sounds.
- » Low cost method of protecting your property.
- » Programmable, you can choose your target bird.
- » UV protected and water resistant.
- » Can be programmed to turn on/off automatically at night.
- » Covers 1 acre. Add additional speakers for coverage up to 5 acres.
- » 30-day unconditional money back guarantee.
- » 100 ft of speaker wire for each speaker.



Super Sonic Speakers (2)
SONIC-SP2



Bird Chase Super Sonic™ Pro Pack 2
IB50-PPII



Bird Chase Super Sonic™ Pro Pack 4
IB50-PPIV

BIRD SPECIES	All birds
WHERE TO USE	Warehouses, rooftops, yards, open lots
BIRD PRESSURE	Light to Medium
ITEM #	ITEM
IB50-PCOM	Bird Chase Super Sonic™
IB50-PPII	Bird Chase Super Sonic™ Pro Pack 2
IB50-PPIV	Bird Chase Super Sonic™ Pro Pack 4
SONIC-SP2	Super Sonic Speakers (2)

SOLAR BIRD CHASE SUPER SONIC™

ADVANTAGES & BENEFITS

The Solar Bird Chase Super Sonic™ is ideal for use in large open spaces where there is no access to a power source. Solar panels charge and store energy to keep the system operating during inclement weather. **To install:** Place unit in sun for 8 hours to charge. Optionally, you can plug unit in and charge for 4 hours. Once it is fully charged, place the unit on a flat surface to receive sun for most of the day for optimal charging. Select the proper bird setting from the menu, adjust volume, and watch birds disappear.

- » Unit powered by sustainable solar energy.
- » Deters birds from large open spaces with recorded bird distress and predator calls.
- » Covers 1 acre.
- » Water resistant – meant for outdoor use.
- » Programmable.
- » Light sensor automatically powers down the deterrent when the sun goes down.



BIRD SPECIES	All birds
WHERE TO USE	Warehouses, rooftops, yards, open lots
BIRD PRESSURE	Light to Medium
ITEM #	ITEM
UR58	Solar Bird Chase Super Sonic™

ZON™ MARK IV BIRD SCARE CANNON™

ADVANTAGES & BENEFITS

Designed to produce a regulated sonic blast to scare pest birds and wildlife, ZON™ Mark IV Birds Scare Cannon™ will protect 1 to 5 acres, depending upon topography. Ideal for use in agricultural fields, vineyards, orchards, airports, or any other large open area where pest birds are problematic.

- » Detonation intervals adjustable from 40 seconds to 30 minutes.
- » Economical – 20 lb. propane tank delivers about 17,000 explosions.
- » Light for easy mobility – weighs only 8.4 kg (18.5 lbs.)
- » Operates in strong wind conditions.
- » Stable frame design prevents movement when detonating.
- » Brass seated electrode with fixed-point setting delivers consistent spark.
- » Optional ZON Tripod raises & rotates cannon for maximum effect and range.



BIRD SPECIES	All birds
WHERE TO USE	Vineyards, orchards, row crops, airports, or other large open spaces.

ITEM #	ITEM
CANNON-MARK	ZON™ Mark IV Bird Scare Cannon™
CANNON-TRIPOD-M	ZON™ Rotating 4-foot Tripod for Mark IV Cannon™

ZON™ ELECTRA BIRD SCARE CANNON™

ADVANTAGES & BENEFITS

- » Built-in timer, multi-shot, automatic, random, on-demand modes, and hose failure protection regulator.
- » Three random modes to eliminate animal tolerance by randomly varying the time after each shot series.
- » Detonation intervals adjustable from 1 to 60 minutes.
- » No moving parts to replace or adjust.
- » Reliable printed circuit board controls gas flow and ignition.
- » Can be mounted on vehicles or vessels for aggressive scare tactics.
- » Stable frame design prevents movement when detonating.
- » Optional ZON Tripod raises & rotates cannon for maximum effect and range.



BIRD SPECIES	All birds
WHERE TO USE	Vineyards, orchards, row crops, airports, or other large open spaces.

ITEM #	ITEM
CANNON-ELECTRA	ZON™ Electra Bird Scare Cannon™
CANNON-TRIPOD-E	ZON™ Rotating 4-foot Tripod for Electra Bird Scare Cannon™

AGRILASER®

AGRILASER® LITE

The Agrilaser® Lite repels birds during lighting conditions of 20.000 Lux or less—conditions comparable to cloudy weather. Birds perceive the laser beam as an approaching physical danger and fly away in search for safer grounds. There is no habituation effect. After consistent use birds will perceive the area as unsafe and will not return.

- » Range up to 1,000 meters
- » Fast and long-lasting results
- » Suitable for repelling most bird species
- » Environmentally and animal friendly



The compact solution to bird nuisance

ITEM	ITEM #
Agrilaser® Lite	
Firm storage box	AGRL-LT
1x 18650 rechargeable Li-ion battery	
Battery charger	

AGRILASER® HANDHELD

The Agrilaser® Handheld comes in three models with different laser output power: Agrilaser® Handheld, Handheld 200 and 500.

Choosing the right model is essential in order to generate a laser projection with sufficient contrast for effective bird dispersal.

- » Range up to 2,500 meters
- » Fast and long-lasting results
- » Suitable for repelling most bird species
- » Animal and environmentally friendly



ITEM	ITEM #
Agrilaser® Handheld 100	AGRL-100HH
Agrilaser® Handheld 200	AGRL-200HH
Agrilaser® Handheld 500	AGRL-500HH

AGRILASER® AUTONOMIC

The Autonomic is a fully automated bird repelling system that provides continuous bird repelling capability after a one-time configuration.

When the Autonomic is operational, birds perceive the system's approaching laser beam as a physical danger and disperse to seek safety. In contrast to conventional deterrent methods, birds will not become accustomed to the Autonomic. They will consider the area as unsafe and will not return.

Why choose Autonomic:

- » 24/7 prevention of bird presence
- » Easy to deploy in many situations
- » Immediate and long-lasting results
- » AC power or solar-energy powered



ITEM	ITEM #
Autonomic 100	AGRL-AUTO-100
Autonomic 200	AGRL-AUTO-200
Autonomic 500	AGRL-AUTO-500
Autonomic mounting frame	AGRL-AUTO-BASE

Content on this page provided by Agrilaser®

REFLECT-A-BIRD™

ADVANTAGES & BENEFITS

Bird-B-Gone® Reflect-a-Bird™ is a silent wind-powered spinning visual bird deterrent that effectively scares birds away. The mirror-like design uses sunlight and wind to create a distraction zone that confuses pest birds causing them to flee the area. For best results, use Reflect-a-Bird™ in conjunction with other visual or physical bird deterrents.

- » Great for use on buildings, boats, and within agricultural settings.
- » Easy to install, extremely effective.
- » Angled design (up to 90 degrees) allows Reflect-a-Bird™ to be installed in various directions.
- » Can be glued, screwed, or tied down to flat surfaces.
- » Weatherproof aluminum and plastic construction.



ITEM #	DIMENSIONS
RFLT-1	12.18" (31 cm) h x 11.34" (28.8 cm) diameter



Bird Wire Installed at Orange County Convention Center

Soon after the construction of the two-million square foot Orange County Convention Center concluded, birds quickly began landing and roosting on the facility's support beams. The new convention center provided both safety and visibility for large birds to roost and avoid predators. Moreover, not only did it offer an accessible roosting area but the convention center also hosted large crowds that would often leave behind excess trash and foods. In order to find a solution, the Orange County Convention Center contacted Bird•B•Gone® for assistance.

Goal of Installation: Prevent birds from landing on the convention center's support beams, thus eliminating the negative aesthetic and health hazards of roosting pest birds.



Orange County Convention Center located in Orlando, FL.



Product Installed: Bird Wire

The bird control solution of choice for this job was Bird•B•Gone's Bird Wire. Bird Wire is the best option for this scenario due to its ability to deter large birds from specific roosting locations. In this case, the pest birds were landing on large support beams throughout the convention center, leaving behind hazardous droppings. In order to protect the support beams, the Bird Wire system needed to cover the full length and width of the beam.



Bird Wire is an anti-perching system that offers both a low cost and low visibility solution for large bird infestations. It has the ability to wrap around a curved surface, such as support beams, and deter pest birds from otherwise challenging areas.

Result: A humane and highly effective Bird Wire installation that prevents birds from landing and roosting on the Orange County Convention Center.



Pest Swallows NOT Allowed on Campus!



Installation of Bird•B•Gone® Bird Slope Panels.

Easily maintained with regular building maintenance.

Every spring, swallows migrate back to North America to build new nests for the coming summer. In recent years, swallows have made a home out of a local high school by building their cup-shaped mud nests under the school's overhangs and ledges.

Issues to be addressed: The birds were leaving scattered droppings on the campus and walkways, causing both defacement and damage to the property as well as a health hazard for students, staff and teachers. The school faced costly maintenance and repairs if no action was taken to discourage the swallows from returning.

Challenges to overcome: Swallows are protected by the Migratory Bird Treaty Act of 1918, making it illegal to intentionally capture, kill or disrupt any migratory bird. Migratory birds must be deterred prior to or after they vacate the nest.

Product Installed: Bird•B•Gone® Bird Slope™

Solution: The building's small eaves made Bird•B•Gone®'s Bird Slope™ an ideal solution for this situation. Bird Slope™ immediately removed the covered corners where swallows like to nest. The product also provided easy future maintenance as the panels can be painted anytime the building is painted. Slope was installed using Bird•B•Gone® mounting clips, easy "snap-on" extenders that allow the panels to cover wider spaces, along with "end caps" which prevent birds from getting behind the sloped panels. The technical team that installed the bird slope panels was properly trained and qualified by Bird•B•Gone®.

Result: The humane, effective bird deterrent kept the swallows from nesting under the school's overhangs and ledges. No more swallows to deface and damage the school buildings. No more swallow-related health hazards for students, staff and teachers.

TRAP AND CAPTURE

When trapping is necessary, Bird•B•Gone® has the widest selection of humane live traps available.

When there are 20 or more pest birds at a job site, trapping may be necessary to reduce the birds before you install a permanent bird control system. Trapping is often overlooked because it can be time consuming and an unpleasant part of the job. If left undone, however, your bird control product installation can be unsuccessful.

Bird•B•Gone's® complete line of professional bird traps come in a variety of sizes to help accommodate the species of pest bird posing a problem, the size of the flock, and the location of where the trap is going to be placed.

Mist Netting is another technique to capture and release birds from enclosed areas. When the netting is hung directly in a bird's flight path, the bird flies into the net, becomes immobile, and makes it easy to remove the bird and set it free outside of the structure.



*Deanna Martinez
Purchasing*

MIST NET

ADVANTAGES & BENEFITS

When the netting is hung directly in a bird's flight path, the bird flies into the net, becomes immobile, and makes it easy to remove the bird and set it free outside of the structure. The Mist Net is a simple, humane way to catch and release birds.

- » Will not harm birds.
- » Made from extremely fine fibers that birds cannot see.
- » Designed to capture multiple birds with 1 net.
- » Available in 4 sizes.
- » Ideal for big box stores, warehouses, grocery stores or other indoor areas where birds are trapped.

BIRD SPECIES	All birds
WHERE TO USE	Warehouses, big box stores, airplane hangars, grocery stores
BIRD PRESSURE	Light to Heavy
MATERIAL	UV protected nylon

ITEM #	NET SIZE
MIST7X10	7' x 10' (2.13 m x 3.05 m)
MIST10X20	10' x 20' (3.05 m x 6.10 m)
MIST10X30	10' x 30' (3.05 m x 9.14 m)
MIST10X40	10' x 40' (3.05 m x 12.19 m)

MIST NET KIT

Our Mist Net Kit contains everything needed to capture and release trapped birds.

- Mist Net - 1 per kit (Choose one size)
- Telescoping Poles - 2 each
- Hook Attachments - 2 each
- Magnet Attachments - 2 each
- Laser Pointer - 1 each
- Carrying Case - 1 each
- Magnet Covers - 2 each
- Sparrow Charmer - 1 each with MISTCAP-KIT-CHRM & MISTCAP-KIT/20-CHRM



Mist Net



Carrying Case



Magnet Attachment







Laser Pointer



Hook Attachment



Two Telescoping Poles

ITEM	DETAILS	ITEM #
	TELESCOPING POLE Use to hang Mist Net: 18' (5.4m)	MISTP18 (One per pack)
	HOOK ATTACHMENT Attaches to Telescoping Pole to hang Mist Nets from ceiling beams	MISTHOOK (One per pack)
	MAGNET ATTACHMENT Attaches to Telescoping Pole to hang Mist Nets from metal ceiling beams	MISTMGNT (One per pack)
	LASER POINTER Use light beam to scare birds into Mist Net	MISTLZR (One per pack)
	CARRYING CASE Convenient for storing and transporting Mist Net components	MISTCS1 (One per pack)
	MAGNET COVER For easy removal of magnet attachment	MISTRCLR (One per pack)

ITEM #	NET SIZE
MISTCAP-KIT	Net: 10' x 30' (3.05 m x 9.14 m)
MISTCAP-KIT/20	Net: 10' x 20' (3.05 m x 6.10 m)
MISTCAP-KIT-CHRM	Net: 10' x 30' (3.05 m x 9.14 m) & Sparrow Charmer
MISTCAP-KIT/20-CHRM	Net: 10' x 20' (3.05 m x 6.10 m) & Sparrow Charmer

SPARROW CHARMER™

ADVANTAGES & BENEFITS

Programmed with Bird•B•Gone®'s proprietary sparrow call; field tested and scientifically proven to attract sparrows into traps.

- » Built-in speaker with push button controls.
- » Plays up to 10 continuous hours.
- » Attracts sparrows up to 2 acres away.
- » Remote control functions up to 150 meters away.
- » Programmable adjustable timer.
- » Rechargeable lithium battery.
- » A perfect add-on to any Mist Net Kit or trap.



BIRD SPECIES	Sparrows
WHERE TO USE	Warehouses, big box stores, airplane hangers, grocery stores
BIRD PRESSURE	Light to Heavy
DIMENSIONS	5" x 2" x 1" (12.7 cm x 5.08 cm x 2.54 cm)
ITEM #	BIRDCALL-SP
PKG INCLUDES	Sparrow Charmer™, Mounting clip, Remote control, USB cord, USB power adapter, power cord

SPARROW CAPTURE TRAP

ADVANTAGES & BENEFITS

The Sparrow Capture Trap is a hanging trap designed for the capture of sparrows with multiple sensory luring capabilities.

- » The perfect tool for control of pesky sparrows.
- » Built to resemble a common birdhouse in order to conceal the trap.
- » Spring-loaded door snaps when a sparrow enters and lands on a perch beneath the opening.
- » Mirror located adjacent to perch to attract sparrows
- » Includes mounting bracket to allow for easy placement.
- » For maximum effect, lure sparrows in with Sparrow Charmer™.
- » Simple assembly; assembles in minutes.



ITEM #	DIMENSIONS
BMP-CAPTURE	Pop up feature: Closed: 12"x6.5"x9"; Open: 18"x6.5"x11"

PROFESSIONAL BIRD TRAPS



COLLAPSIBLE PIGEON TRAP

ITEM #: BMP-PSCP
 Easily to assemble and collapses to 1" (2.54 cm) high
 One door on each side
 Capacity: 18+ pigeons
 14 lbs. (6.35 kg)
 Dimensions: 40" x 22" x 12" (101.60 cm x 55.88 cm x 30.48 cm)

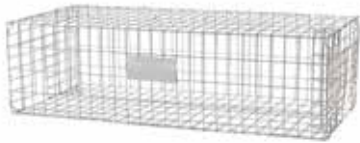

PIGEON MOTEL

ITEM #: BMP-SW-SPM
 Ideal for commercial or residential use
 Two one-way entry doors
 Each door has a door guard
 Easy to store and re-use
 Portable
 Capacity: 6+ birds
 Lightweight 5 lbs. (2.26 kg)
 Dimensions: 24" x 12" x 8" (60.96 cm x 30.48 cm x 20.32 cm)

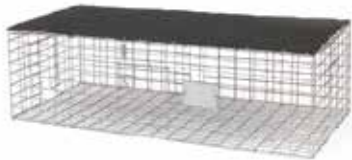

COLLAPSIBLE PIGEON TRAP WITH SHADE

ITEM #: BMP-SW-CP-S
 Four one way entry doors - one on each side
 Easily assembles and collapses to 1" (2.54 cm) high
 Hinged shade screen
 Capacity: 12+ birds
 Lightweight 8 lbs. (3.62 kg)
 Dimensions: 35" x 16" x 8" (88.90 cm x 40.64 cm x 20.32 cm)



LARGE PIGEON TRAP WITH SHADE, FOOD & WATER

ITEM #: BMP-SW-LP-SFW
 One 1-gallon water container and feeder pan
 Six one-way entry doors with door guard
 Divided trap with two access top doors
 Hinged shade screen
 Capacity: 30+ birds
 16 lbs. (7.25 kg)
 Dimensions: 45" x 24" x 10" (116.84 cm x 60.96 cm x 25.4 cm)



PIGEON TRAP WITH SHADE, FOOD & WATER

ITEM #: BMP-SW-SP-SFW
 Three one-way entry doors with door guard
 Centered top access door for easy removal of birds
 Hinged shade screen
 Water container and feeder pan
 Capacity: 12+ birds
 Lightweight: 10 lbs. (4.53 kg)
 Dimensions: 35" x 16" x 8" (88.90 cm x 40.64 cm x 20.32 cm)



SLANTED SURFACE PIGEON TRAP WITH SHADE, FOOD & WATER

ITEM #: BMP-SW-AD-LEGS
 One 1-gallon water container and feeder pan
 Adjustable legs ideal for slanted surfaces
 Six one-way entry doors with door guard
 Heavy slide out galvanized flat pan and fold down landing platforms
 Hinged shade screens
 Capacity: 20+ birds
 23 lbs. (10.43 kg)
 Dimensions: 36" x 24" x 10" (91.44 cm x 60.96 cm x 25.4 cm)



SNAP TRAP

ITEM #: BMP-SW-SNAP-S: 17" x 17" x 2.5" (43.18 cm x 43.18 cm x 6.35 cm)

ITEM #: BMP-SW-SNAP-M: 24" x 24" x 2.5" (60.96 cm x 60.96 cm x 6.35 cm)

Simple to use with proven results.

When bait tray is triggered, a spring loaded nylon net closes over the birds to trap them quickly and safely.

This trap can be mounted on buildings, walls, and trees.

The snap trap is powder coated for rust resistance.



SPARROW TRAP

ITEM #: BMP-SP2C

Two chamber

Bi-level repeating trap

Dual level design eliminates captured feeling by birds

Large capacity (can hold a large number of sparrows)

Lightweight: 4 lbs. (1.81 kg)

Dimensions: 16" x 12" x 8" (40.64 cm x 30.48 cm x 20.32 cm)

Side view



SPARROW TRAP WITH FOOD & WATER

ITEM #: BMP-SW-SSP3-WF

Two top access removal doors

Bi-level eliminates captured feeling by birds

Repeating trap

Easy access to service feed and water station

Six entry funnel doors (three per compartment)

13 lbs. (5.89 kg)

Dimensions: 36" x 24" x 10" (91.44 cm x 60.96 cm x 25.40 cm)



BIRD HOUSE ENGLISH SPARROW TRAP

ITEM #: BMP-BHSPT

Single Bird

Bird-house design naturally attracts English Sparrows. When the Sparrow enters the house and lands to perch, the spring-loaded trap door snaps closed. Once the trap is closed, the fluorescent sticker will show through the hole located on the front trap door to let you know the trap is now occupied.

Dimensions: 9"H x 5"W x 5.5"D



SPARROW SKY TRAP

ITEM #: BMP-SW-SKY

A hanging trap designed for the capture of sparrows and smaller birds in high traffic areas.

Proven V-top entry design enables Sky Trap to hang from the ceiling or sit on a flat surface.

Includes water and feed containers along with a perch to calm birds after capture.

Dimensions: Closed: 24"W x 12"L x 18"H (60.96 cm x 30.48 cm x 45.72 cm)

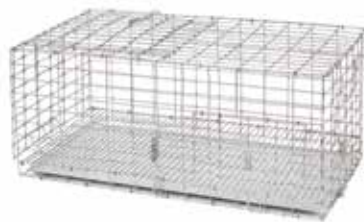

TRANSPORTERS

Medium ITEM #: BMP-SW-TRN-M

Large ITEM #: BMP-SW-TRN-L

Constructed of heavy 14- and 16-gauge welded wire

Carrier collapses to 1" tall for storage

Full wire floor with slide out galvanized flat pan

Medium Capacity: 8+ birds

Large Capacity: 25+ birds

Medium Dimensions: 24" x 12" x 9" (60.96 cm x 30.48 cm x 22.86 cm)

Large Dimensions: 36" x 16" x 9" (91.44 cm x 40.64 cm x 22.86 cm)

TIPS & TRICKS

Use Sparrow Charmer™ to lure sparrows into traps.

REPELLENTS

Bird•B•Gone® offers a number of highly effective and humane bird repellents that are non-toxic to address these problems and keep areas bird free.

Birds Deface and Damage Buildings/Structures

Bird nests and feathers can clog rain gutters and downspouts, leading to roof leaks. This debris can also jam up AC units, window frames and rooftop vents. Bird droppings can deface and damage wood, metal, plastic and stone surfaces. Outdoor light fixtures, security cameras, and dish antennas can only take so much abuse from bird droppings before they begin to fail. The diseases carried by bird droppings can render surfaces unsanitary.

Geese Destroy Lawns, Gardens and Water Features

Pest birds like geese can quickly destroy golf courses, corporate lawns, parks and water features. These large birds can cover an area with unsightly and smelly droppings, which can ruin the aesthetics of a park or garden and contaminate fountains and water features.



*Bird•B•Gone®
Authorized Installer*

BIRD-OFF™ GEL

ADVANTAGES & BENEFITS

Bird-OFF™ Gel is used to keep pest birds off of horizontal surfaces. The unique combination of smells and the sticky sensation on their feet causes birds to stop landing on the surface and leave the area. Bird-OFF™ Gel causes no burning sensation and is safe for installers.

- » Smell and sticky feeling on the feet of birds drives them away.
- » Will not entrap non-targeted species.
- » Lasts up to 1 year per application.
- » Easy to clean up using soap and water.
- » Virtually invisible.



FEATURES

BIRD SPECIES	All birds
WHERE TO USE	Horizontal surfaces including: Ledges, I-beams, parapet walls, conduit, pipes, flat or curved surfaces
BIRD PRESSURE	Light to Medium
MATERIAL	Geraniol White Pepper, Mineral Oil, Silica

ITEM	COVERAGE	ITEM #
Bird-OFF™ Gel (10 tubes/case)	100' (36.58 m) x 3" (7.6 cm)	BOG-CASE
Bird-OFF™ Gel (5 Gallons)	640' (36.58 m) x 3" (7.6 cm)	BOG-5GAL
Caulking Gun (24 oz.)	NA	BOG-APP-GUN
Follow Plate (for 24 oz Gun)	NA	BOG-APP-PLATE

INSTALLATION

To install: 4 inches wide top to bottom – (2, 3, 4 inch distance between waves, depending on bird pressure) **Do not install on a vertical surface.**



Bird-OFF™ Gel
BOG-APP-GUN



Bird-OFF™ Gel
BOG-5GAL

TRANSPARENT BIRD GEL

ADVANTAGES & BENEFITS

Transparent Bird Gel is a sticky gel used to keep pest birds off of horizontal surfaces. Birds can't stand the sticky sensation on their feet and will move on.

- » Creates a sticky surface that birds avoid.
- » Not harmful to birds and people.
- » Designed for pigeons and starlings, not for use for non-targeted species of birds.
- » Lasts up to 6 months outdoors.
- » Effective from 15° F (-9° C) to 200° F (93° C).
- » Virtually invisible.



FEATURES

BIRD SPECIES	Pigeons and Starlings
WHERE TO USE	Horizontal surfaces including: Ledges, I-beams, parapet walls, conduit, pipes, flat or curved surfaces
BIRD PRESSURE	Light to Medium
MATERIAL	Polybutene 93%; Inert 7%

ITEM	COVERAGE	ITEM #
Transparent Bird Gel (12 tubes/case)	120' (36.58 m) x 3" (7.6 cm)	TBG-CASE

INSTALLATION

To install: Gel is applied in a zig-zag pattern about 3" (7.62 cm) high leaving periodic spaces for water drainage. **Do not install on a vertical surface.**



DRIPLESS CAULKING GUN

This ergonomic gun makes installing gels easy.

See page 78



CAULK-ETS3000

BIRD•B•GONE® BIRD HAZER

ADVANTAGES & BENEFITS

Bird•B•Gone® Bird Hazer™ is an affordable and advanced hazing system that releases a fine fog of bird repellent into the air to deter pest birds from large open spaces.

- » Effective for most pest birds including sparrows.
- » Advanced nozzle design distributes fog particle size less than 1 micron.
- » Saves money - uses significantly less liquid repellent than other hazing units.
- » Each Main Control Unit can control up to 6 satellite units to help ensure full perimeter coverage.
- » Designed for indoor and outdoor use.



ITEM	Hazer Main Control Unit
DIMENSIONS	14" x 16" x 6"
WEIGHT (EMPTY)	32 lbs
MATERIAL	Weatherproof NEMA Polycarbonate
SATELLITE DIMENSIONS	14" x 6" x 6" each
SATELLITE WEIGHT (EMPTY)	4 lbs each
TANK SIZE	1 liter each
MATERIAL	Powder-coated metal

HAZER TYPE	ITEM	ITEM #
SPRAY	3 KIT: Includes main control unit and 3 satellite units	HAZR-3KIT-SPRAY
	6 KIT: Includes main control unit and 6 satellite units	HAZR-6KIT-SPRAY
	Hazer Satellite Unit - Spray	HAZR-SU4-SPRAY
VAPOR	3 KIT: Includes main control unit and 3 satellite units	HAZR-3KIT
	6 KIT: Includes main control unit and 6 satellite units	HAZR-6KIT
	Hazer Satellite Unit - Vapor	HAZR-SAT-VAPOR

PATRIOT™ PORTABLE THERMAL FOGGER

ADVANTAGES & BENEFITS

- » Reliable performance.
- » Produces large volumes of fog.
- » The patented Starting System even enables use in areas where poor quality gasoline is all that is available.
- » Designed from over 50 years experience and built to the highest quality standards, the Patriot™ will give superior performance with simplicity and durability.
- » Patented Fuel Priming System eliminates need for pressurized fuel tank.
- » A 12 volt starting system ensures reliable starting even when battery power declines!



ITEM #	FOG-PATRIOT
ITEM	Portable Thermal Fogger
DIMENSIONS	29 x 9 x 18 inches (74 x 24 x 46.4 cm) L x W x H
WEIGHT (EMPTY)	27 lbs (12.5 kg)
FORMULATION TANK	0.85 quarts (0.8 liter)
POWER SUPPLY	Eight 1.5V D size alkaline batteries. Any 12V DC vehicle battery; connect to 12V receptacle to auxiliary battery cable
FOG PARTICLE SIZE	0.5-50 microns



BIRD HAZING

Bird Hazing has proven to be effective in dispersing pest birds where other methods of bird control may be ineffective or impractical. Bird Hazing units efficiently deploy a light fog or haze of bird repellent made with Methyl Anthranilate (a non-toxic, food-grade ingredient). The active ingredient irritates a bird's mucous membranes. Birds find the sensation unpleasant and will subsequently avoid the area. The effect is temporary and will not harm the birds.

WHERE IS BIRD HAZING RECOMMENDED?

Bird Hazing is particularly effective in removing birds from large indoor/outdoor areas, warehouses, aircraft hangars, and plant nurseries. It has been proven effective for driving out pigeons, seagulls, geese, starlings, and many other pest birds. We do not, however, recommend Bird Hazing for buildings that are heavily occupied and have large amounts of foot traffic.

HAZING VS. FOGGING

Bird Hazing is used when birds are a problem in enclosed to semienclosed areas, semi-enclosed docks, and overhangs. A light haze of bird repellent is created through a Bird Haze unit which, depending upon the features of the unit, can often be programmed or set to run in intervals. Bird Fogging is used in wide open areas where birds are a nuisance. Bird control fogs are used against flocks of birds that spend time in parks, golf courses, memorial parks and other large open spaces. The fog is created through the use of either a stationary or hand-held fogging unit. The units generate an aerosol of the Methyl Anthranilate. Foggers produce a "wet fog" that will not penetrate shrubs, so fogging is best used in the open areas that birds fly through or graze in. Fogging should be repeated as often as necessary to keep birds away.

HAZING OR FOGGING?

Used in enclosed and semi-enclosed areas	Used in wide open spaces
Moves birds out of areas where they are roosting and nesting	Moves flocks of birds from open spaces
Creates a small particle mist	Creates a "wet fog"
Depending upon the unit, may be programmed or set to run in intervals	Usually applied with hand-held unit on a scheduled basis

AVIAN CONTROL™

ADVANTAGES & BENEFITS

Avian Control® uses cutting edge technology to efficiently repel undesirable birds without harming the birds, humans or other animals. The repellent is effective against flocking birds (starlings, blackbirds and others), robins, crows and pigeons.

- » Non-lethal and mild enough to use around people and animals.
- » Low cost, effective solution.
- » Simple application via ground, aerial spraying, or fogging.
- » EPA approved for use on numerous crops.
- » For indoor fogging use: Undiluted at a rate not to exceed two (2) fl. oz. per 10,000 cubic ft.
- » For outdoor fogging use: Undiluted at a rate of 12-16 fl. oz. per acre.
- » Recommended spray application rate on turf is 12-42 fl. oz. per acre up to a maximum of 5 gallons per acre.
- » Estimated coverage: 6 acres per gallon on turf; 9 acres per gallon when used with foggers.



GALLON ITEM #	AVN-GAL
HALF GALLON ITEM #	AVN-HALF
WHERE TO USE	Crops, airports, dairy barns, other commercial and residential applications.
ACTIVE INGREDIENT	20% Methyl Anthranilate (MA), methyl 2-aminobenzoate

ECOBIRD® 4.0

ADVANTAGES & BENEFITS

EcoBird® 4.0 was developed as a non-hazardous bird repellent, made from food-grade materials & is a naturally occurring Generally Regarded As Safe (GRAS) product. The active ingredient is a US EPA listed, & FDA Approved, compound used as a food flavoring and fragrance additive. It is a natural component of concord grapes and other plant materials.

- » EPA approved: Safe for indoor and outdoor applications.
- » Non-hazardous bird repellent made from food-grade materials.
- » Does not harm birds, people, or pets.
- » Ecological and economical.
- » For use with mechanical spraying & fogging equipment.
- » For indoor fogging use: Undiluted at a rate not to exceed one (1) fl. oz. per 10,000 cubic ft.
- » For outdoor fogging use: Undiluted at a rate of 6-8 fl. oz. per acre.



EcoBird® is effective for all birds including: Pigeons, geese, grackle, starlings, dove, black birds, swallows, gulls, water fowl & many other birds that have become a nuisance and/or a health hazard in affected areas.

ITEM #	ECOBRD-40
WHERE TO USE	Grain storage and manufacturing facilities, airports and hangars, parking and car wash facilities, landfills, golf courses, and more.
ACTIVE INGREDIENT	40% Methyl Anthranilate

AVIAN MIGRATE™

ADVANTAGES & BENEFITS

Avian Migrate™ is a non-toxic repellent that discourages geese and other birds from congregating on golf courses, parks, athletic fields, airports, vineyards and other areas where birds are grazing. Using a unique patent pending formula, Avian Migrate™ irritates the birds' mucous membranes causing them to avoid the area.

- » Best applied with spray equipment such as garden sprayers or foggers.
- » Contains a breakthrough technology that uses a special colorant, visible only to birds, that let them know that the area has been treated. This teaches unwanted birds to stay away in the future.
- » Does not harm grass, shrubs and other vegetation and is not easily rinsed away by rain or sprinklers.
- » The ingredients are GRAS by the US Food and Drug Administration.



The repellent is effective against geese, mute swans, coots and small birds.

ITEM #	GRGAVN-GAL (Gallon) GRGAVN-HALF (Half Gallon).
WHERE TO USE	Golf courses, parks, athletic fields, airports, vineyards and other areas where birds are grazing
ACTIVE INGREDIENT	14.5% Methyl Anthranilate (MA)

AVIAN FOG FORCE™ TR

ADVANTAGES & BENEFITS.

Avian Fog Force™ TR Bird Repellent is a non-lethal automated time-release aerosol bird repellent. Avian Fog Force™ TR programmable spray mist dispenser cabinets dose the appropriate amounts.

Each dispenser cabinet releases an invisible intermittent aerosol bird repellent mist on a user selected programmable time-release basis. Spray mist dispenser cabinets can be placed strategically in areas where nuisance birds are a problem. Dispenser cabinets are powered by two "D" batteries that last up to six months.

Avian Fog Force™ TR is not available for sale in the state of Alaska, California or Hawaii. Avian Fog Force TR is available for sale to licensed pesticide applicators in the state of New York.



ITEM #	FOG-TR (Canister) FOG-DISP (Dispenser).
WHERE TO USE	Dairy barns, stables, stadiums, marinas, garages and storage buildings, pools and patios, outdoor dining facilities
ACTIVE INGREDIENT	14.5% Methyl Anthranilate (MA)

“

BIRDS IN BUILDINGS

Prior to removing birds from inside a building, birds must first be removed from nesting, roosting, and landing sites on the exterior of the building as well as shoring up any entry points.

For many stores, pest birds, droppings, and nesting materials pose serious health and safety issues which may result in lost revenue and fines. Bird•B•Gone[®] offers a variety of solutions to help you rid pest birds from stores and other large contained areas.

As with all bird control jobs, evaluate the extent and the root of the problem. Identify the bird species and how birds are entering the building (gaps, broken windows, old pipe chases, etc.). All areas should be repaired; bird nests and bird droppings properly removed. Be sure to remove all food, water, and clean-up any spills that would attract birds. As birds often enter through overhead doors, we suggest the installation of Bird•B•Gone[®] Vinyl Strip Doors or Bird•B•Gone[®] Bird Net Curtain to help keep birds out.

Once birds occupy the interior of the building, the most effective method for deterring and removing birds will involve a combination of one or more methods depending upon the situation:

Sparrows and other small birds: We highly recommend Bird•B•Gone[®] Mist Net that can be hung parallel to the point of entry (e.g. loading docks) allowing for the humane capture of multiple birds for proper release. Combine Mist Net with the Bird•B•Gone[®] Sparrow Charmer™, a field tested audio calling device that lures sparrows into netting and traps through the broadcast of Bird•B•Gone[®]'s proprietary sparrow call.

Highly visible and high-traffic locations: Use the Bird•B•Gone[®] Sparrow Sky Trap, a bird trap that can be hung from the ceiling and includes a tray that securely captures droppings or other debris. Combine with Bird•B•Gone[®] Sparrow Charmer™ for maximum results.

Large, “open” indoor/outdoor areas: We recommend the use of Agrilaser[®] Lite and Bird Hazing. Agrilaser[®] Lite repels birds with patented optical technology. Birds perceive the laser beam as an approaching physical danger and fly away in search for safer grounds. After systematic use, the birds will consider the area in which the Agrilaser[®] Lite is used as



unsafe and will not return. Bird Hazing—dispersing a light haze/fog of Methyl Anthranilate (non-toxic, food-grade ingredient) through the air which irritates the birds' mucous membranes causing them to subsequently avoid the area. However, we do not recommend Bird Hazing for buildings that are heavily occupied by people and have large amounts of foot traffic.

Larger birds including pigeons: A combination of Agrilaser[®] Lite, humane trapping, and bird hazing is strongly recommended. To ensure you have the correct traps based upon flock size and location, call our Bird Control Experts at 800.392.6915.

While the removal of pest birds may appear to be a challenge, you can safely remove birds from the premises and prevent them from returning with cooperative personnel and the right combination of products.

Should you require assistance, please contact our Bird Control Experts at 800.392.6915. We will be more than happy to provide you with the assistance needed to ensure you have the right products specified to resolve the bird problem properly and efficiently.



*Bird•B•Gone®
Authorized Installer*

MISCELLANEOUS

Bird•B•Gone® offers additional materials to make your pest and bird control jobs easier, safer and efficient. We can be your one-stop-shop to cut time and hassles.

Adhesives: Many bird control products glue easily into place. Construction grade adhesives should be used to ensure proper installation of bird control products.

Cleaning Supplies: When pest birds gather and roost in, on or near human habitable areas, they can quickly pose a number of health and safety hazards. To help prevent the problems bird droppings can cause, Bird•B•Gone® can recommend the right combination of sanitation products and PPE (Personal Protective Equipment) to get the job done right.

Marketing Materials & Resources: We have marketing and sales materials available to help you get the word out and grow your business. We also offer training videos and professional bird control tips with our Two Minute Tuesday videos to help you with products, installation, safety & sales.

ADHESIVES AND SEALANTS



Sikaflex® Gray Adhesive Glue

Construction grade polyurethane adhesive designed for outdoor use that will not sag, drip or run. Use with Bird Spikes, Bird Jolt Flat Track®, Bird Spider 360™, Bird Slope™ and Bird Wire.

ITEM #	COVERAGE
AD-FLEX-GRY	25' (7.62 m)
AD-FLEX-GRY-CASE	Case of 24 tubes



E6100® Adhesive Glue

E6100 is a unique non-sag, non-flammable industrial adhesive formulated to meet high-performance requirements. Use with Bird Spikes, Bird Jolt Flat Track®, Bird Spider 360™, Bird Slope™, & Bird Wire.

ITEM #	COVERAGE
ADE61	25' (7.62 m)
ADE61-CASE	Case of 12 tubes



ASI-57 Performance Hybrid Sealant/Adhesive

Bonds to a variety of hard-to-bond substrates, non-sag, eco-friendly, and will not shrink. Use with Bird Spikes, Bird Jolt Flat Track®, Bird Spider 360™, Bird Slope™ and Bird Wire.

ITEM #	COVERAGE
AD-57	25' (7.62 m)
AD-57-CASE	Case of 24 tubes



3M® ScotchWeld™

This is a fast curing (20 minutes) ScotchWeld™ epoxy adhesive used to secure the Glue-on Bases, and is ideal for use on surfaces where drilling is not an option.

ITEM #	ITEM
BWQAA-2	ScotchWeld™ (1/pk)
BWQAAP	ScotchWeld™ Applicator (1/pk)
BWQAAN-12	ScotchWeld™ Nozzles (12/pk)



Dripless Caulking Gun

Switch between dripless or standard mode. The grip is designed to keep the wrist in a natural position. Weighs approximately 60% less than comparable guns.

ITEM #	ITEM
CAULK-ETS3000	Dripless Caulking Gun

CLEANING SUPPLIES



3M® 6000 Series Half-Face Respirator

Use proper precautions and protect yourself and your crew from unnecessary contamination and inhalation of dried bird feces.

Refill filter

ITEM	SIZE	ITEM #
Respirator	Medium	RESP-MED
Respirator	Large	RESP-LRG
Refill Filter	(2 Pack)	RESP-REFILL-2



Microcide SQ™ Disinfectant Cleaner

Concentrate w/ Quart Spray Bottle. 8 ounces makes 16 quarts (4 gallons).

ITEM	ITEM #
Disinfectant	DIS-SQ8



Airzyme™ Disinfectant Cleaner

Concentrate w/ Quart Spray Bottle. 8 ounces makes 16 quarts (4 gallons).

ITEM	SIZE	ITEM #
Waste Digester	Gallon	DISAZ-1GAL

INDUSTRIAL SPRING CLAMP



The rugged Bird•B•Gone® industrial clamps have a variety of applications. Chief among these is their use in securing fumigation tents to prevent gas leakage and keep out pets and children.

- 1" grip opening
- Steel jaws for longer tool life
- Heavy duty tempered wire springs for fast, reliable opening and closing
- Point-of-pressure remains near jaw tips for positive clamping
- The spring action in each clamp is designed for one-handed operation, so attaching/detaching is quick and easy

ITEM #	PACK SIZE
CLAMP-IND1-100	100 per pack
CLAMP-10BOX	10 per pack

VINYL STRIP DOORS

- Stop birds from entering buildings, warehouses and loading docks
- Can be used in conjunction with Bird Net 2000™, and other Bird•B•Gone® products
- Custom sizes available
- Complete with hardware and ready to hang

CUSTOM SIZE STRIP DOORS FLAT STRIP

ITEM #	DOOR WIDTH X HEIGHT	% OF OVERLAP
VSD-08CS	8" x .080" (20.32 cm x .20 cm)	50%
VSD-12CS	12" x .120" (30.48 cm x .3048 cm)	66%
VSD-16CS	16" x .160" (40.64 cm x .406 cm)	50%

STANDARD SIZE STRIP DOORS WITH STANDARD FLAT STRIP

ITEM #	DOOR WIDTH X HEIGHT	% OF OVERLAP
VSD-3X7	3' w x 7' h (.914 m x 2.13 m)	50%
VSD-4X8	4' w x 8' h (1.21 m x 2.44 m)	50%
VSD-6X8	6' w x 8' h (1.83 m x 2.44 m)	50%
VSD-8X8	8' w x 8' h (2.44 m x 2.44 m)	50%
VSD-8X10	8' w x 10' h (2.44 m x 3.05 m)	66%
VSD-10X10	10' w x 10' h (3.05 m x 3.05 m)	66%
VSD-12X12	12' w x 12' h (3.66 m x 3.66 m)	66%



BIRD NET CURTAIN

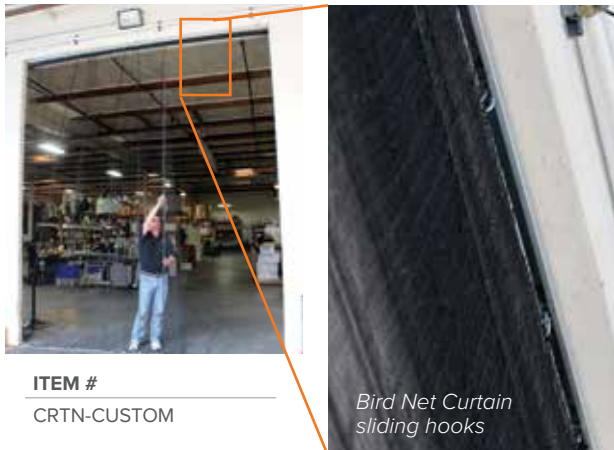

ITEM #
CRTN-CUSTOM

Bird Net Curtain
sliding hooks

Bird Net Curtains enable roll up doors to remain open for ventilation during working hours and significantly reduce the opportunity for birds to enter the building. Each Bird Net Curtain is custom cut based upon your specifications and door frame size.

Choose from three sizes of bird net - 3/4", 1-1/8" & 2" mesh depending upon the type of bird you wish to keep out. Bird Net Curtains easily open and close to allow for in-and-out traffic.

- Keeps birds from entering warehouses, loading docks, and manufacturing plants
- Uses Heavy Duty Bird Net 2000™ hung as a curtain to keep birds out
- Easily installed using the included bird net hardware and industrial curtain track

THE DEFENDER™ PREMIUM VENT COVER



Birds and squirrels can be persistent in making a home inside your house. The Defender™ keeps them out.

- Zinc coated steel delivers lasting protection
- Vertical bars keep creatures out while minimizing lint buildup and make cleaning easy
- Helps hide unsightly vents
- Works on all siding types
- Available in white finish and 2 sizes: 6.5" and 8"

ITEM #	DIMENSIONS
VENT-DFR6-SM	6.5" THE DEFENDER PREMIUM VENT COVER
VENT-DFR8-SM	8" THE DEFENDER PREMIUM VENT COVER

VISUAL & PHYSICAL BIRD DETERRENENTS

REPELLER 360^o™

ITEM #: RPL360

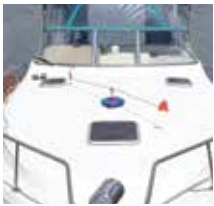

- Uses sustainable wind energy
- Ideal for docks & boats
- UV protected - designed for outdoor use
- Sweeps birds continually in a 6' diameter

SOLAR BIRD REPELLER

ITEM #: RPL-SLR1
ITEM#: RPLR-ARMS (2 Replacement Telescoping Rods)



- Solar powered with rechargeable batteries that store power for use in low or no light
- Sweeps birds continually in a 5' diameter

BIRD SCARE ATTACK SPIDER

ITEM #: ATTK-SPIDER



- Ideal to keep woodpeckers and other pest birds from attacking the sides of your home or business
- Battery operated (not included)
- Sound or vibration activated

FLASH TAPE

ITEM #: MMFT-050: 1" Wide (3-50' rolls)
MMAFT-SIL: 2" Wide (1-150' roll)

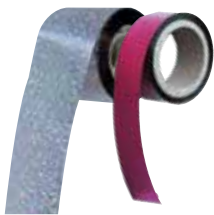

- Iridescent foil tape scares birds away with reflective surface
- Ideal for use in gardens, trees, pool areas, outdoor patios, gazebos, and more

REFLECTIVE SCARE BIRD DIVERTERS

ITEM #: SED-5



- Iridescent foil "predator" eye scares birds away
- Easy to install
- Will not damage trees or plants
- 5 diverters per pack

BIRD-B-GONE® BALLOON

ITEM #: SEB-1



- Inflatable visual scare device
- Confuses birds with life-like reflective "predator" eyes
- Includes flash tape
- Ideal for use in fruit trees, patio covers, pool areas, gazebos, etc.

RED TAIL HAWK

ITEM#:MMRTH1



- Birds identify hawks as predators and will leave the area where the decoy is present
- Easy to install, extremely versatile
- Low-cost effective solution

COPPER MESH

ITEM#: CMS-20 20' (6.10 m)
ITEM#: CMS-100 100' (30.48 m)



- Ideal for roof tiles and open spaces around dryer vents
- Packs tightly into cracks and holes for exclusion of pests and birds

BEAKGUARD®

ITEM#: WPK-BG-BRN (Portabello)
WPK-BG-STN (Sand Stone)
WPK-BG-GRY (Whetstone)
WPK-BG-WHT (Nova White)
WPK-BG-CUSTOM (Custom)



- Environmentally friendly deterrent coating; will not harm woodpeckers
- Easy to apply to almost any surface
- Durable and weather-resistant
- Effective quickly after application
- Custom colors available
- Coverage 180 sq. ft. (16.72 sq. m)

BIRD CONTROL MARKETING

DISPLAY CASE

INTERACTIVE DISPLAY CASE

CUSTOM SELL SHEETS

AUTHORIZED INSTALLER LOGO STICKER



Our display case is the perfect visual tool to bring along when giving a sales presentation on bird control services.

FREE



USB flash drive that contains a digital interactive display case showcasing our products, case studies and specs.

FREE



We offer free customized "sell sheets" you can give to existing or potential customers to let them know you provide bird control as a service.

FREE



When displayed on your vehicle, this waterproof vinyl sticker is perfect for letting customers know you can help them with their bird control needs.

Our goal is not to just sell products, but to help position our customers to make the best quality decisions when it comes to choosing, designing, specifying and installing the right bird control products for your specific bird problem.

We have everything you need for a successful bird job in our online bird control resource center including information on pest birds, the diseases associated with birds, case studies, installation instructions, product literature, architectural specifications and more!

- » Online Installation Videos
- » Two Minute Tuesday Professional Bird Control Tips
- » Product MSDS
- » Product Specifications
- » Product CAD Details
- » BIM Objects
- » Product Literature
- » Installation Instructions
- » Case Studies
- » And More!