

ML-RBS

Remote Battery Switches

PN 7713 / PN 7713B / PN 7713100B
PN 7717 / PN 7717B / PN 7717100B

- Magnetic Latch (ML) - draws very low current continuous and draws moderate current for a very short time when changing state
- Silver alloy contacts provide high reliability for switching live loads
- Manual override provides LOCK OFF capability for servicing and ON/OFF control with or without power
- LED output to remotely indicate switch state
- Tin-plated copper studs for maximum conductivity and corrosion resistance
- Label recesses for circuit identification
- PNs 7713 and 7717 include a Remote Control Switch PN 2155

Specifications

	12V DC	24V DC
Cranking Rating	See table below	See table below
Intermittent Rating	See table below	See table below
Continuous Rating	See table below	See table below
ML-Coil Function	Auto releasing	Auto releasing
Operating Current: Continuous	<13mA @ 25°C nominal voltage	<13mA @ 25°C nominal voltage
Changing Stage (20 ms)	<7A @ 25°C nominal voltage	<4A @ 25°C nominal voltage
Contact Circuit Voltage	16V DC Max.	32V DC Max.
Live Current Switching	300A @ 12V DC—10,000 Cycles	150A @ 24V DC—10,000 Cycles [‡]
Mechanical Endurance	100,000 Cycles	100,000 Cycles
Control Circuit Voltage	9-16V DC	18-32V DC
Terminal Stud Size	3/8"-16	3/8"-16
Maximum Terminal Stud Torque	140 in-lb (15.8 N•m)	140 in-lb (15.8 N•m)
Ring Terminal Size	3/8" (M10)	3/8" (M10)
Terminal Ring Diameter Clearance	1.18" (30 mm)	1.18" (30 mm)

[‡] Predicted performance

Remote Switch PN 2155

Action	SPDT, ON-ON
Seals	Internal & External Gasket Panel Seal
Mounting Hole	0.83"x 1.45" (21.08 mm x 36.83 mm)
LED Rating	100,000 hours half-life
Harness Connector: (select models)	Deutsch DTM Series DTM 06-6S See
Mating Part Requirements	LADD Industries
Receptacle Shell	DTM-04-6P
Wedgelock	WM-6P
Terminal Pins	1060-20-0122
Sealing Plugs	0413-204-2005
Hand Crimp Tooling	DTT-20-0

Regulatory Meets ISO 8846 and SAE J1171 external ignition protection requirements, CE marked, Rated IP66

Wire Size (AWG)	Metric (mm ²)	Cranking 10 sec.	Cranking 1 min.	Intermittent 5 min.	Continuous (UL 1107)
2/0	70	2,000A	750A	400A	225A
4/0	120	2,200A	750A	400A	300A
2x (4/0)	2x (120)	2,500A	1,100A	700A	500A





PN	Termination	Control Circuit	Remote Control Switch Included
7713	Tinned Wires	12V DC	SPDT, ON-ON
7713B	Tinned Wires	12V DC	-
7713100B	Deutsch Connector	12V DC	-
7717	Tinned Wires	24V DC	SPDT, ON-ON
7717B	Tinned Wires	24V DC	-
7717100B	Deutsch Connector	24V DC	-

Overview of Application



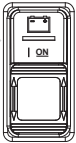

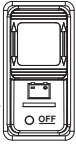

The ML-Series Remote Battery Switch (ML-RBS) provides high-current carrying and switching under load. The ML-RBS should be installed close to the battery to minimize voltage drop to the ML-RBS. Install a single pole double throw (SPDT) or single pole single throw (SPST) control switch in a convenient location near other electrical controls or companionway to allow quick access in the event of an emergency (see Illustration on reverse).*

* Although a SPST switch may be used if desired, use of a SPDT switch improves immunity to inadvertent switching if the switch terminals become damp.

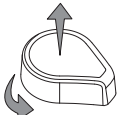
Remote Operation

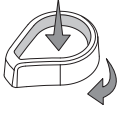
	Remote Switch Operation	ML-RBS Relay State	Remote Control Switch LED
ON	 To connect battery bank to load, or combine battery banks, press remote switch "ON".	 Remote Enabled ON (closed)	ON
OFF	 To disconnect battery bank from load, or isolate battery banks that are connected, press remote switch "OFF".	 Remote Enabled OFF (open)	OFF

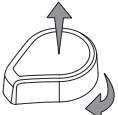
Manual Override Operation

	ML-RBS Operation	ML-RBS Relay State	Remote Control Switch LED
	 To manually disconnect battery bank from load, or isolate battery banks that are connected, rotate manual override knob to the right.	 Manual Override LOCKED-OFF (open)	LED double blinking ON-OFF
	 To manually connect battery bank to load, or combine battery banks that are connected, rotate manual override knob to the left then push down until latched.	 Manual Override ON (closed)	LED double blinking ON-OFF
OFF	 To restore remote switching, manually set the RBS in the "Remote Enabled OFF (open)" position and push remote switch "OFF".	 Remote Enabled OFF (open)	LED OFF

⚠ CAUTION ⚠

- ✓ These instructions are intended to provide assistance with the installation of this product, and are not a substitute for a more comprehensive understanding of electrical systems. We strongly recommend that a competent electrical professional perform the installation of this product.
- ✓ The illustrated wiring diagram represents a common installation and is not meant to be a guide for wiring a specific vessel. The wiring diagram shows a single battery bank installation.
- ✓ Disconnect all negative battery connections before beginning the installation.
- ✓ All unused control wires should be carefully insulated from each other and from accidental contact using heat shrink tubing or electrical tape. External contact or shorting between control wires can lead to malfunction.

Installation Instructions

Mounting

Install as close as possible to battery bank. To avoid corrosion to connecting wires and terminals, mount in a dry and protected location. Avoid mounting directly above vented lead acid batteries so that the Remote Battery Switch is not exposed to corrosive gasses expelled from the batteries.

High Current Primary Circuit Connections (stud terminals A and B)

NOTE: Stud terminals A and B are interchangeable. A battery connection is required on one terminal for device operation

To connect high current circuit wires:

1. Connect the battery bank to one of the stud terminals marked A or B.
2. Connect the load to the other stud terminal marked B or A.
3. Torque the high current terminal stud nuts to 140 in-lbs (15.5 N•m) maximum.

NOTE: If switching an inverter, windlass, bow thruster, etc., the circuit wires must have circuit protection to comply with ABYC guidelines. Wires used for engine starting do not require circuit protection.

Control Circuit Connections (wires contained in the wire harness)

NOTE: The Remote Battery Switch is designed to be controlled by a SPDT or SPST switch. Use minimum 16 AWG wire for the Control Circuits.

To connect the SPDT Remote Control Switch 2155:

1. Connect pin 3 and pin 8 to +12V or +24V Power available when Remote Battery Switch is OFF. (fused)
2. Connect the red control wire to switch pin 2.
3. Connect pin 7 to yellow wire.
4. Connect pin 1 to ground or negative.

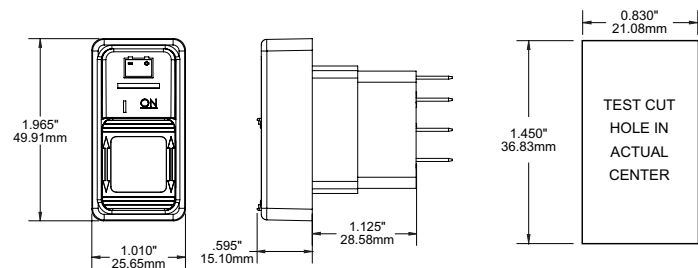

Installation Instructions

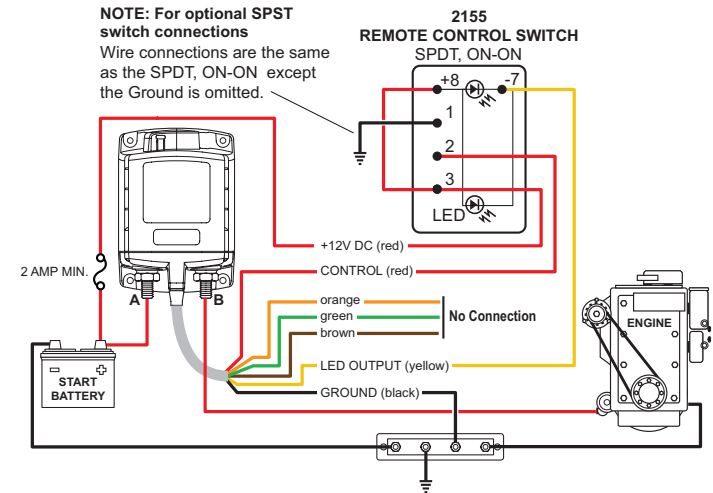

Tinned Wire Termination

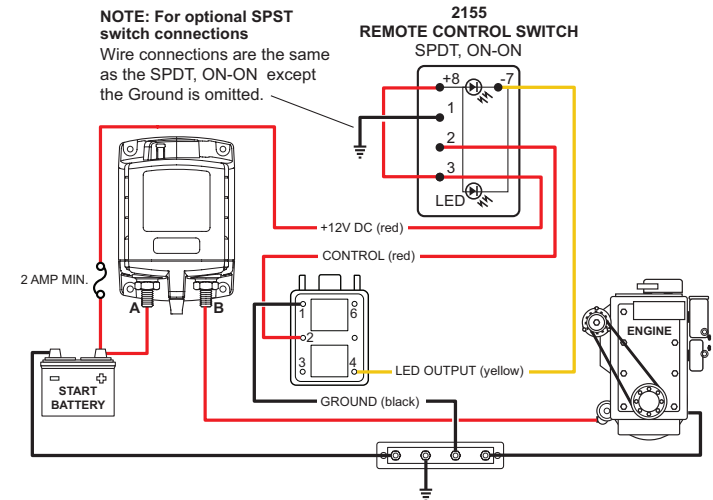

Deutsch DTM Connector Termination

