



Installing A Carver Bimini Top

Carver Bimini Tops are a classy way to protect yourself and your boat from the elements. They also add style and color to your boat. These instructions make assembly and installation easy. Please read them carefully before beginning.

How To Prolong The Life Of Your Bimini Top

- Avoid letting water or snow stand on the top.
- Always travel with top in the stored position.
- Allow Bimini Top to dry thoroughly before folding for storage.

Carver Industries, Inc. Limited Warranty

The materials and workmanship in Carver products are guaranteed to be free of defects at time of manufacture. The length of the warranty is determined by the type of material ordered.

Warranty coverage commences on the original date of purchase. The warranty does not cover normal wear, weather soiling, stains from environmental pollution and/or standing water, cuts from sharp objects, neglect, accident or misuse. The bimini top must be properly installed, utilized and maintained.

If a defect is detected within 12 months of date of purchase, Carver Industries will repair or replace (at its discretion) the product free of charge.

If a defect is detected after 12 months and up to 36 months from date of purchase for three-year warranties, and up to 60 months from date of purchase for five-year warranties, Carver will (at its discretion) repair the defect on a time and material cost basis or replace the product on a pro-rated basis. Carver Industries, Inc. and/or seller provide this warranty in lieu of all other warranties, expressed or implied. Carver Industries, Inc. and/or seller disclaim all liability for special, incidental or consequential damages.

Some states/provinces do not allow limitations on how long an implied warranty lasts, or the exclusion or limitation of special, incidental or consequential damages, so these limitations and exclusions may not apply to you. This warranty gives you specific legal rights. You may also have other rights which vary from state/province to state/province.

Please enclose a note describing the defect and be sure to include your full name and address inside the package.



! Please take extra care when unpacking and assembling your bimini top. Should you need to return the bimini top, it **MUST** be in its original, new condition. The bimini top canvas must be clean and dry, and free of debris (including pet hair). Frame components must not be scratched.

Important: Make sure all parts are included in your Bimini Top package. The quantities listed below are the quantities of parts needed based on the size of the top that was ordered. You may receive additional parts that are not needed for your particular size of bimini top. **! FOR STAINLESS STEEL TOPS AND SQUARE TUBE PONTOON TOPS, PLEASE REFER TO THE SUPPLEMENTAL INSTRUCTIONS ON PAGE 5 WHICH EXPLAIN ALTERNATE PARTS NOT LISTED BELOW.**

PARTS LIST:

Item	Quantities for:			
	2 Bow Tops	3 Bow Tops	4 Bow Tops	4-Bow Square Tube Tops
No. 8 screws, 1/2" length	12	16	20	20
No. 10 screws, 1" length	12	12	12	12
Finish Washers	4	4	4	2
Long, metal side bow sections	2	2	2	2
Medium, metal side bow sections	0	2	2	2
Short, metal side bow sections	2	2	4	4
Center metal cross bow sections (equal length)	2	3	4	4
Black, 1" polypropylene hold-down straps	4	4	4	2
Black, 1" polypropylene adjuster straps (packaged with canvas)	0	2	4	4
Bimini Top Canvas	1	1	1	1
Deck Hinges	2	2	2	2
Eye Straps	4	4	4	2
Optional Storage Boot	1	1	1	1
Brace Kit (pair)	0	0	0	1

Minimum tools needed:

Drill with 9/64" bit, a Phillips head and a flat head screwdriver, pencil.
Also helpful: Tape measure or other measuring device.



No. 8, No. 10 Screws, and Finish Washers

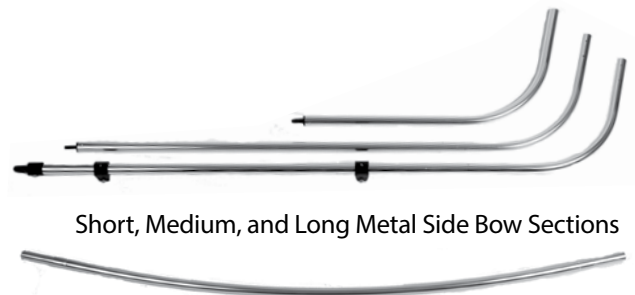

Center Metal Cross Bow Section

INSTRUCTIONS FOR CARVER 2 BOW BIMINI TOP

These instructions show how to assemble the top, with its frame and straps, **starting upside down** and inverting to an upright position when attaching to your boat.

Step 1 Identify the hook shaped, long and short metal side bow sections. Using the long side bow sections and one of the center cross bow sections, assemble the side bow and center bow parts as shown, aligning the pre-drilled holes. Use the 1/2", no. 8 screws to connect the bow parts securely.

Repeat this procedure for the short bow, aligning the pre-drilled holes and securing them with 1/2", no. 8 screws.

Caution: If screw heads become burred, cover heads with duct tape or file down screw heads to avoid damage to canvas.

Step 2 Spread the Bimini Top canvas out on a flat, clean area with the bottom side up. Sewn-in label indicates the bottom, or inside, and the back of the top.

Step 3 With the bows assembled, insert the short bow assembly through the sleeve at the front of top. (This is the sleeve opposite the end with the sewn-in tag.) *Note the position of the single pre-drilled holes on the bow frame. (Holes should be facing toward the middle of the canvas.)*

Insert the long bow assembly through the sleeve at the back of the top (nearest the sewn-in tag). *Again, note the position of the single pre-drilled holes on the long bow frame. (Holes should be facing toward the middle of the canvas.)*

Step 4 Pass looped end of each hold down strap over each end of the bows. Use a no. 8, 1/2" screw to fasten straps to bow frame at each pre-drilled hole position as shown. Position strap over hole and insert screw, with finish washer, through center of strap and into pre-drilled hole.

Step 5 Connect short frame ends to jaw slides on each side of long bow frame. Frame ends can be rotated to align with jaw slides. Jaw slides should allow bows to pivot, but be tight enough to hold securely.

See page 7 of this instruction sheet for mounting the Bimini Top onto your boat.

①

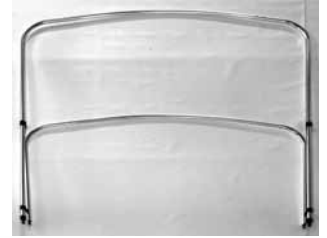
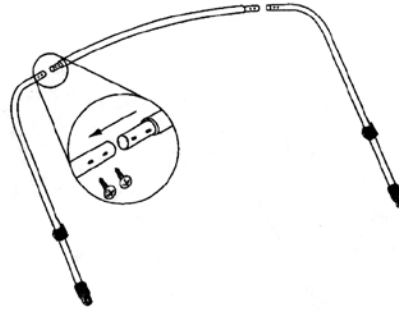

②

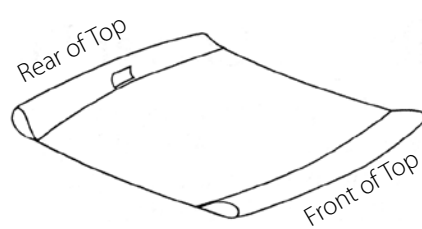

③

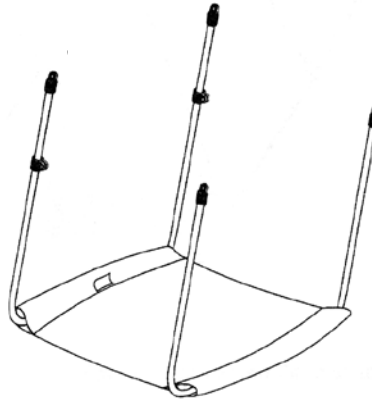

④

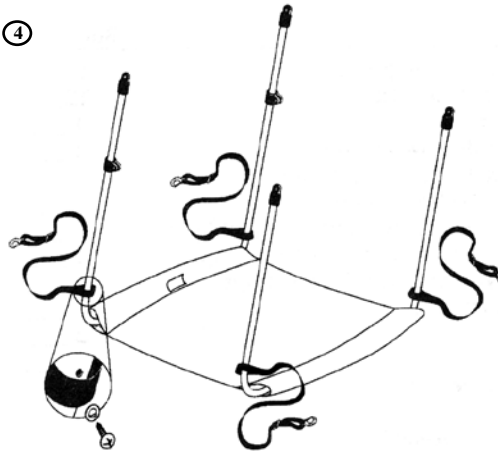

⑤

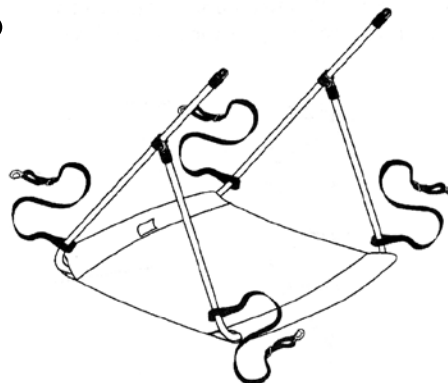

INSTRUCTIONS FOR CARVER 3 BOW BIMINI TOP

These instructions show how to assemble the top, with its frame and straps, **starting upside down** and inverting to an upright position when attaching to your boat.

FOR STAINLESS STEEL TOPS, PLEASE REFER TO THE SUPPLEMENTAL INSTRUCTIONS ON PAGE 5

Step 1 Identify the hook shaped, long, medium, and short metal side bow sections. Using the long side bow side sections, and one of the center cross bow sections, assemble the side bow and center bow parts as shown, aligning the pre-drilled holes. Use the 1/2", no. 8 screws to connect the bow parts securely.

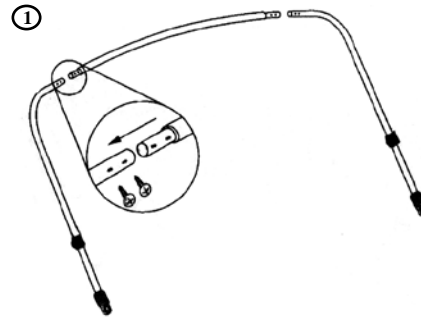

Repeat this procedure for the medium and short bows, aligning the pre-drilled holes and securing them with 1/2", no. 8 screws.

Caution: If screw heads become burred, cover heads with duct tape or file down screw heads to avoid damage to canvas.

Step 2 Spread the Bimini Top canvas out on a flat, clean area with the bottom side up. Sewn-in label indicates the bottom, or inside, and the back of the top.

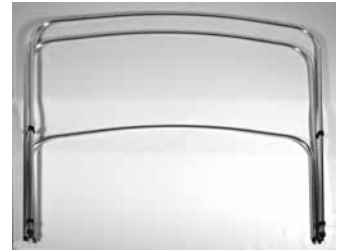
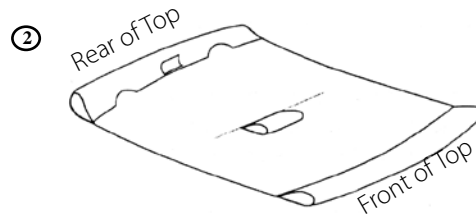

Step 3 With the bows assembled, insert the medium bow assembly through the sleeve at the front of top. (This is the sleeve opposite the end with the sewn-in tag.) *Note the position of the single pre-drilled holes on the bow frame. (Holes should be facing toward the middle of the canvas.)*

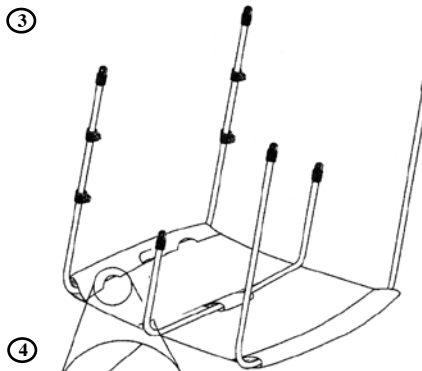

Insert the short bow assembly through the small sleeve in the center of the top and the long bow assembly through the sleeve at the back of the top (nearest the sewn-in tag). *Again, note the position of the single pre-drilled holes on the long bow frame. (Holes should be facing toward the middle of the canvas.)*



Step 4 Pass the buckled end of the adjuster strap through opening in the fabric and around the long bow. Thread looped end through buckle. Attention should be paid to the orientation of the strap and buckle so that the finished piece resembles photo A. Pass the looped end of the strap over the end of the short bow and slide down into position directly across from opening in fabric where buckled end is attached. (See illustration.) Leave at maximum length. Repeat this step for the second strap. See enlargement.

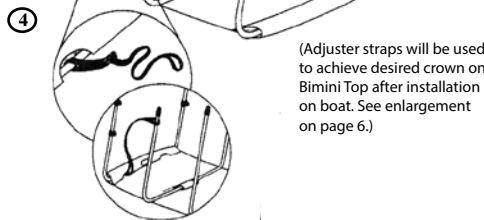

(Adjuster straps will be used to achieve desired crown on Bimini Top after installation on boat. See enlargement on page 6.)



Step 5 Pass looped end of each hold down strap over each end of the long and medium bows. Use a no. 8, 1/2" screw to fasten strap to bow frame at each pre-drilled hole position as shown. Position strap over hole and insert screw, with finish washer, through center of strap and into pre-drilled hole.

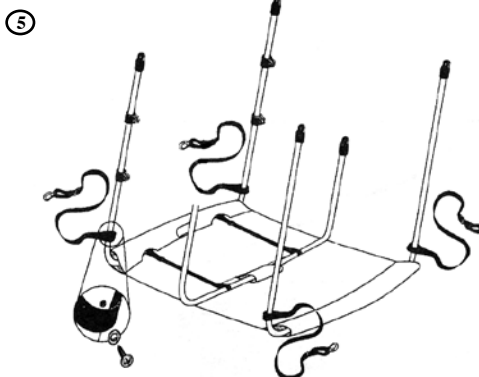

Step 6 Connect short frame ends to jaw slides on each side of long bow frame. Frame ends can be rotated to align with jaw slides. Repeat for medium frame ends as shown. Jaw slides should allow bows to pivot, but be tight enough to hold securely.

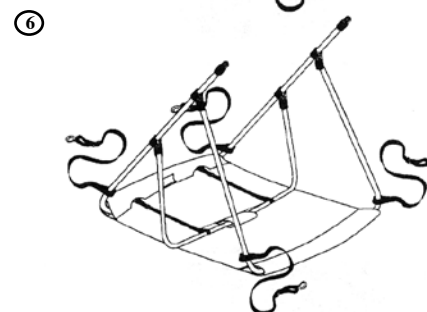

See page 7 of this instruction sheet for mounting the Bimini Top onto your boat.

INSTRUCTIONS FOR CARVER 4 BOW BIMINI TOP

These instructions show how to assemble the top, with its frame and straps, **starting upside down** and inverting to an upright position when attaching to your boat.

FOR STAINLESS STEEL TOPS, PLEASE REFER TO THE SUPPLEMENTAL INSTRUCTIONS ON PAGE 5

Step 1 Identify the hook shaped, long, medium, and short metal side bow sections. Using the long side bow sections, and one of the center cross bow sections, assemble the side bow and center bow parts as shown, aligning the pre-drilled holes. Use the 1/2", no. 8 screws to connect the bow parts securely.

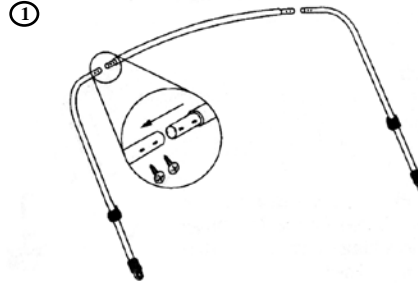

Repeat this procedure for the medium and short bows, aligning the pre-drilled holes and securing them with 1/2", no. 8 screws.

Caution: If screw heads become burred, cover heads with duct tape or file down screw heads to avoid damage to canvas.

Step 2 Spread the Bimini Top canvas out on a flat, clean area with the bottom side up. Sewn-in label indicates the bottom, or inside, and the back of the top.

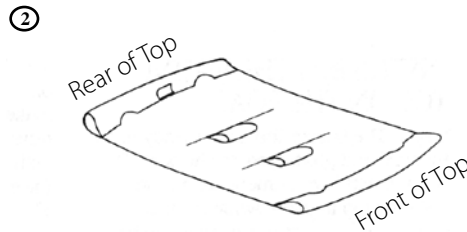

Step 3 With the bows assembled, insert the medium bow assembly through the sleeve at the front of top. (This is the sleeve opposite the end with the sewn-in tag.) *Note the position of the single pre-drilled holes on the bow frame. (Holes should be facing toward the middle of the canvas.)*

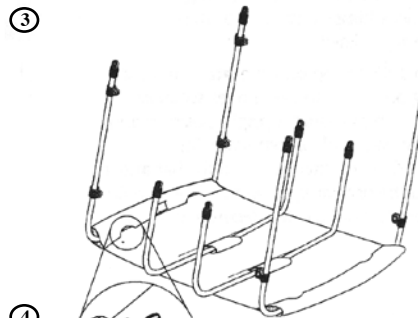

Insert the short bow assemblies through the small sleeves in the center of the top and the long bow assembly through the sleeve at the back of the top (nearest the sewn-in tag). *Again, note the position of the single pre-drilled holes on the long bow frame. (Holes should be facing toward the middle of the canvas.)*



Step 4 Pass the buckled end of the adjuster strap through opening in the fabric and around the long bow. Thread looped end through buckle. Attention should be paid to the orientation of the strap and buckle so that the finished piece resembles photo A. Pass the looped end of the strap over the end of the short bow and slide down into position directly across from opening in fabric where buckled end is attached. (See illustration.) Leave at maximum length. Repeat this step for the second strap then assemble the straps for the front bow. See enlargement.

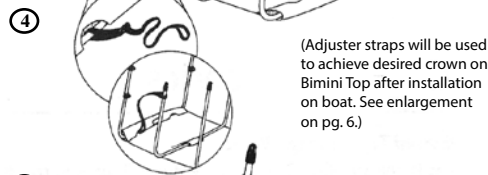

(Adjuster straps will be used to achieve desired crown on Bimini Top after installation on boat. See enlargement on pg. 6.)



Step 5 Pass looped end of each hold down strap over each end of the long and medium bows. Use a no. 8, 1/2" screw to fasten strap to bow frame at each pre-drilled hole position as shown. Position strap over hole and insert screw, with finish washer, through center of strap and into pre-drilled hole.

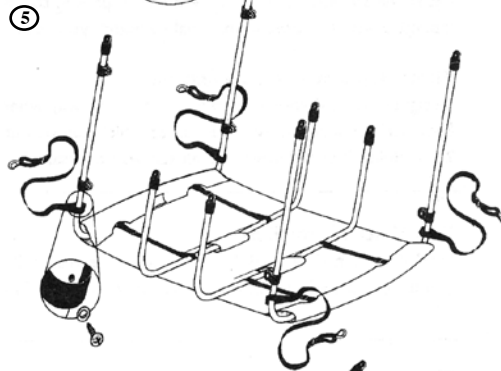

Step 6 Connect short frame ends to jaw slides on each side of long bow frame. Frame ends can be rotated to align with jaw slides. Repeat for medium frame ends as shown. Jaw slides should allow bows to pivot, but be tight enough to hold securely.

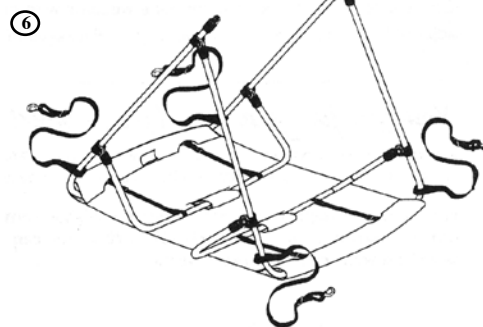

See page 7 of this instruction sheet for mounting the Bimini Top onto your boat.

See page 7 of this instruction sheet for mounting the Bimini Top onto your boat.

Square Tube Pontoon Bimini Top

Follow Instructions for 4-Bow Top
with these exceptions:

Step 7. The long bow has a jaw slide installed to mount the brace kit, instead of the pre-drilled hole for the hold-down strap. (See photo on label.)



Additional Instructions for Buggy-Style Pontoon Top with Tails:

1. To fit tails properly, pull the tails straight down and mark the snap locations onto the rails.
2. Drill 1/8" hole where each snap is marked on the rail. Install supplied screw stud into hole. Repeat for all snaps.
3. Snap tails to the rail.

(Note: the additional hardware (6 screw studs) are included in the fabric package.)

Stainless Steel Frame Supplemental Instructions

The assembly of a stainless steel frame requires the use of rivets instead of screws. For your convenience, a Hand Riveting Tool and all necessary rivets are included with your bimini top. Simple instructions for operating a Hand Riveting Tool are located on the back of the Rivet Tool package. **For your safety, it is highly recommended that you wear safety goggles when operating your Hand Riveting Tool.**

Following the steps provided for a 2, 3 or 4-Bow top, use a 3/16" rivet (provided) where a no. 8, 1/2" screw is specified. Align the pre-drilled holes, place thick end of rivet in hole and nail-end of rivet in rivet tool. Occasionally it may be necessary to tap the rivet in place. Set rivet by compressing handle of rivet tool three times. Rivet will pop and be seated firmly in place. Repeat process at all pre-drilled holes.

Should a rivet seat improperly, it can be drilled out using a 3/16" drill bit. Extra rivets are provided for your convenience.

Caring for your Bimini Top Canvas

To keep your canvas looking its best, regularly brush off any loose dirt with a soft brush and rinse with lukewarm water (100° F maximum). To clean, a solution of lukewarm water and mild natural soap such as Ivory™ may be used. Rinse thoroughly and allow to air dry. The use of detergents is not recommended as it may diminish the water repellent finish on certain fabrics. Never machine wash, dry clean or iron the canvas. To spot clean stubborn soil or stains, a solution of 1/4 cup mild natural soap and 1 cup of bleach per gallon of lukewarm water may be used. Mist the soiled area and clean vigorously with a sponge, soft brush or clean towel. Rinse thoroughly and allow to air dry.

Always fold down and secure bimini top in the stored position when trailering your boat.

Additional Instructions for Adjusting Height of a standard 35" Super Sport or standard 46" 3-Bow Bimini Top.

If you wish to shorten the height of the above style bimini tops, you may do so by carefully drilling out the rivets using a 3/16" drill bit. Take caution as to not damage the eye ends. Cut the desired length from the ends of the long bow (see drawing).

Once the bow has been shortened, re-set the eyes by using a 3/16" drill bit to carefully drill the hole for the rivet. Be sure the eye end is set in the correct position before you drill for the rivet. Use a rivet gun to set the rivet in place. Then follow the remaining instructions listed in the instruction sheet.

Note: Be sure all set screws, fittings and pre-installed hardware are tight.

Use hacksaw to cut the desired length. You can remove up to 10" from this section.

Do not attempt to shorten the short or medium bows.

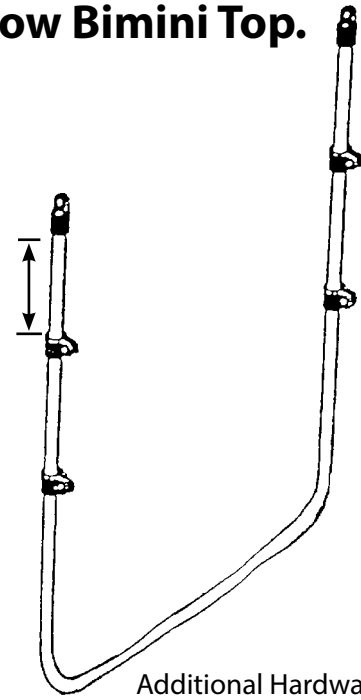

Additional Hardware Included
2 - 3/16" Rivets

How to Adjust the Inside Eye Ends

- Inside Eye Ends will rotate
- Place a soft cloth over the eye end to avoid marring, and carefully turn the Eye End using a pair of pliers.

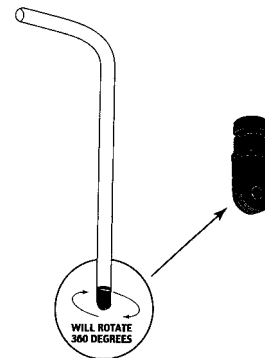

Universal Deck Hinge

with 90-degree stop allows mounting in virtually any position.

Standard Mount with screw heads to the outside as shown.

For alternate mounting positions, variations may apply.



INSTALLING THE BIMINI TOP ON THE BOAT

Step 1. The Bimini Top is now ready to be inverted and positioned on the boat. This is easier with two or more people, one to hold the top in place, while another marks the positions of the hinges to be attached to the gunnel of the boat.

Step 2. Measure the marked position of the hinges carefully to make sure they are exactly opposite each other. If not aligned properly, the top may become warped or damaged and unstable while in use, or look unbalanced.

Step 3. Use a drill with a 9/64" bit to drill the pilot holes for the deck hinges. If drilling into fiberglass hollow out the pilot hole to avoid cracking fiberglass when installing the screws. Secure the deck hinges with 1", no. 10 sheet metal screws provided.

Step 4. Place top on boat, attaching the long bow ends to the hinges securely. Raise top to desired upright position and adjust each hold-down strap. Straps should be adjusted to a length that attaches to the boat at approximately 45° to 60° angles to hold the top securely to boat.

Step 5. Mark the position of the eye straps on the gunnel of the boat, measuring to make sure they are exactly opposite each other on the sides of the boat. Use a drill with a 9/64" bit to drill the pilot holes for the eye straps. Be sure to hollow out the pilot holes with the drill bit if drilling into fiberglass. Secure the eye straps with 1", no. 10 sheet metal screws provided.

Step 6. Attach the snap hook to the eye straps and adjust the hold down straps.

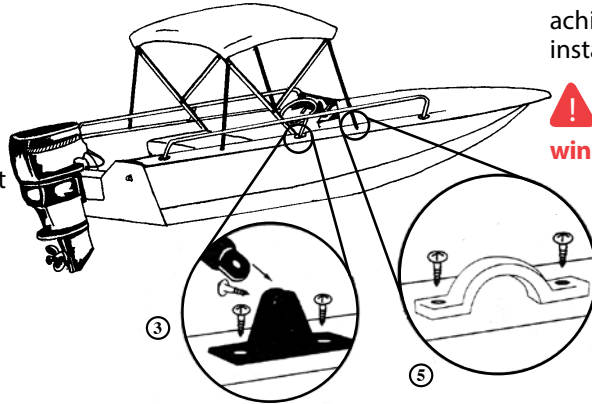

Please Note: The process of assembling the bimini frame may cause the width of the frame to expand or retract at the mounting points. If the frame appears too wide or too narrow when you are ready to mount the top on the boat, simply mount one side and, with minimal force, push or pull the opposite side to fit the mounting point on the gunwale.

Important note to Top Installer/User: Be sure all set screws, fittings and pre-installed hardware are tight.

Desired crown on Bimini Top can be achieved using adjuster straps after installation is complete.

! If mounting your bimini top to a windshield, you may need shorter screws to prevent cracking the windshield.

CAUTION: Always fold down and secure bimini top in the stored position when trailering your boat.

Installing a Carver Brace Kit

Carver Brace Kits are available in:

- Aluminum tubing with Nylon Fittings - Fixed or Adjustable
- Aluminum tubing with Stainless Steel Fittings - Fixed only
- Stainless Steel tubing with Stainless Steel Fittings - Fixed only

All Brace Kit packages contain:

- 2 - Braces
- 2 - 90° Deck Hinges
- 2 - Hinged Jaw Slides w/ screw and bolt
- 4 - #10 x 1" stainless steel screws (for mounting the deck hinges)
- 2 - 3/16" rivets (required only when cutting down braces)

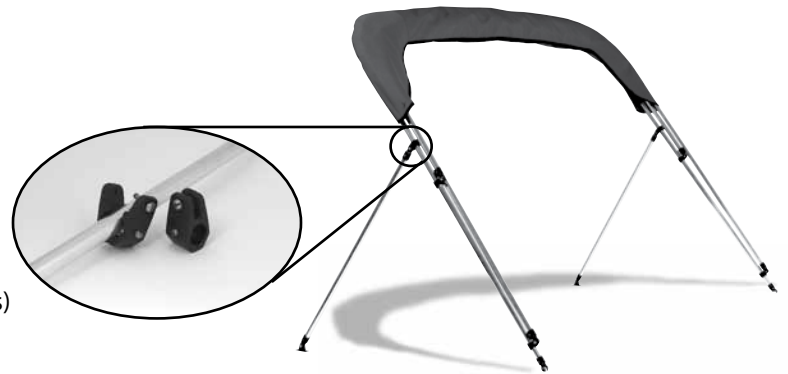

All fixed braces are 48" long. Adjustable braces "telescope" from 22" to 44", the desired length being "set" by a joiner section.

The height of fixed aluminum braces may be adjusted by removing and replacing one eye end on each brace. To remove the eye ends, use a 3/16" drill bit to drill out the rivets. Carefully measure and cut down the tubing to the desired length using a hacksaw. To replace the eye ends, use a 3/16" drill bit to carefully drill the hole for the replacement rivets. Be sure each eye end is set in the correct position before drilling for the rivet. Use a rivet gun to set the rivets in place.

The height of stainless steel braces is best adjusted by moving the mounting location fore or aft on the gunnel (given the hardness of the metal, stainless steel is not easily cut with household tools).

The typical location to attach the braces to the main (long) bow is 2 inches beneath the rear hold down straps.

To attach the braces, the bimini top must be deployed (in its upright position). Carefully measure the exact location for the hinged jaw slide on each side of the main (long) bow and mark with a black marker. Be sure the measurement is identical on port and starboard side. Open the hinged jaw slides and fasten each around the main bow at the marked locations by tightening the screw securely. Insert the braces into the jaw slides by inserting the eye ends and securing tightly with the bolts provided. Once the braces are attached to the main bow, determine the mounting locations for the deck hinges. The typical mounting point will create a 45° to 60° angle with the main (long) bow when the braces are mounted to the gunnel. To mount the deck hinges, refer to Steps 2 and 3 in the **Bimini Top Installation Instructions above.**

Installing a Carver Slide Track Kit

Carver Slide Track Kits are available in 18", 24", 36", 48" and 60" lengths to accommodate virtually any boat and bimini top.

All Slide Track Kit packages contain:

- 2 - Aluminum Slide Tracks
- 2 - Sliding Deck Hinges with combined Slide Locks
- 2 - Side-Mount Sliding Deck Hinges
- 2 - Slide Locks (for use with side-mount hinges)
- 4 - End Caps
- All necessary screws for mounting.
- (All screws are #8 x 1" Stainless Steel).

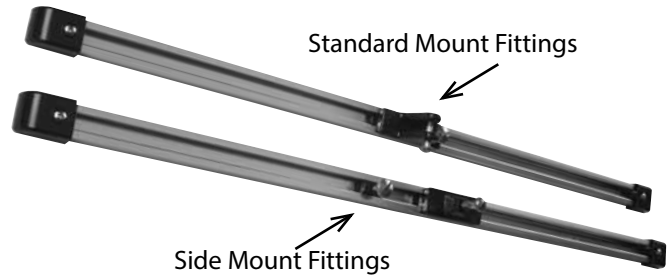

Slide track should be installed on a level surface and may be mounted on top of the gunnel or on the inside of the gunnel (side-mounted).

Determine the location for the slide track. Carefully measure and mark the mounting locations making sure the measurements are identical on port and starboard side so that the tracks will be exactly opposite. Slide tracks are pre-drilled for easy installation.

Use a 1/8" drill bit to drill screw holes. If drilling into fiberglass, it is important to hollow out the drill hole with the drill bit to avoid cracking the fiberglass when screws are tightened. Insert all screws and tighten securely.

Slide the appropriate hinges into the track (combination hinges for standard mount track or side-mount hinges and slide locks for side-mounted track). The locks should be positioned forward of the hinges and tightened to a fixed position. Attach the end caps using the screws provided. The main (long) bow may now be inserted into the track by attaching the eye ends to the deck hinges. Adjust the position of the bimini top by loosening the locks and sliding them into the desired position. Always retighten the slide locks after adjusting the position of the bimini top



Accessories

Bimini Top Storage Boot

Let in the sun. Our 2, 3, and 4 bow Bimini Tops fold together and out of the way in the protective storage boot. Available in material to match your top.



Bimini Top Braces Also available

Designed to hold your top up and out of the way when top is folded and not in use. Each package includes two 7/8" tubes which can be cut to desired lengths, 2 hinged jaw slides, 2 deck hinges, and all screws necessary for mounting. One pair to a package.

Slide Track Kit for Tops

Each aluminum slide track kit includes 2 slide tracks, 2 sliding deck hinges with combined slide locks, 2 side-mount sliding deck hinges with separate slide locks, 4 end caps and all necessary screws for mounting. One pair to each package.



Bimini Top Replacement Hold-Down Straps

Constructed of 1" black polypropylene webbing with heavy nickel-plated brass snap hook and stainless steel adjustable buckle. Available in two lengths. Packed in sets of four.



BETTER COVERS. BETTER SERVICE.

Carver Industries produces quality Boat Covers, Personal Watercraft Covers and Bimini Tops. We take great pride in the craftsmanship and attention to detail that goes into all of our products.





Installing A Carver Bimini Top

Carver Bimini Tops are a classy way to protect yourself and your boat from the elements. They also add style and color to your boat. These instructions make assembly and installation easy. Please read them carefully before beginning.

How To Prolong The Life Of Your Bimini Top

- Avoid letting water or snow stand on the top.
- Always travel with top in the stored position.
- Allow Bimini Top to dry thoroughly before folding for storage.

Carver Industries, Inc. Limited Warranty

The materials and workmanship in Carver products are guaranteed to be free of defects at time of manufacture. The length of the warranty is determined by the type of material ordered.

Warranty coverage commences on the original date of purchase. The warranty does not cover normal wear, weather soiling, stains from environmental pollution and/or standing water, cuts from sharp objects, neglect, accident or misuse. The bimini top must be properly installed, utilized and maintained.

If a defect is detected within 12 months of date of purchase, Carver Industries will repair or replace (at its discretion) the product free of charge.

If a defect is detected after 12 months and up to 36 months from date of purchase for three-year warranties, and up to 60 months from date of purchase for five-year warranties, Carver will (at its discretion) repair the defect on a time and material cost basis or replace the product on a pro-rated basis. Carver Industries, Inc. and/or seller provide this warranty in lieu of all other warranties, expressed or implied. Carver Industries, Inc. and/or seller disclaim all liability for special, incidental or consequential damages.

Some states/provinces do not allow limitations on how long an implied warranty lasts, or the exclusion or limitation of special, incidental or consequential damages, so these limitations and exclusions may not apply to you. This warranty gives you specific legal rights. You may also have other rights which vary from state/province to state/province.

Please enclose a note describing the defect and be sure to include your full name and address inside the package.



! Please take extra care when unpacking and assembling your bimini top. Should you need to return the bimini top, it **MUST** be in its original, new condition. The bimini top canvas must be clean and dry, and free of debris (including pet hair). Frame components must not be scratched.

Important: Make sure all parts are included in your Bimini Top package. The quantities listed below are the quantities of parts needed based on the size of the top that was ordered. You may receive additional parts that are not needed for your particular size of bimini top. **! FOR STAINLESS STEEL TOPS AND SQUARE TUBE PONTOON TOPS, PLEASE REFER TO THE SUPPLEMENTAL INSTRUCTIONS ON PAGE 5 WHICH EXPLAIN ALTERNATE PARTS NOT LISTED BELOW.**

PARTS LIST: Item	Quantities for:			
	2 Bow Tops	3 Bow Tops	4 Bow Tops	4-Bow Square Tube Tops
No. 8 screws, 1/2" length	12	16	20	20
No. 10 screws, 1" length	12	12	12	12
Finish Washers	4	4	4	2
Long, metal side bow sections	2	2	2	2
Medium, metal side bow sections	0	2	2	2
Short, metal side bow sections	2	2	4	4
Center metal cross bow sections (equal length)	2	3	4	4
Black, 1" polypropylene hold-down straps	4	4	4	2
Black, 1" polypropylene adjuster straps (packaged with canvas)	0	2	4	4
Bimini Top Canvas	1	1	1	1
Deck Hinges	2	2	2	2
Eye Straps	4	4	4	2
Optional Storage Boot	1	1	1	1
Brace Kit (pair)	0	0	0	1

Minimum tools needed:

Drill with 9/64" bit, a Phillips head and a flat head screwdriver, pencil.

Also helpful: Tape measure or other measuring device.



No. 8, No. 10 Screws, and Finish Washers

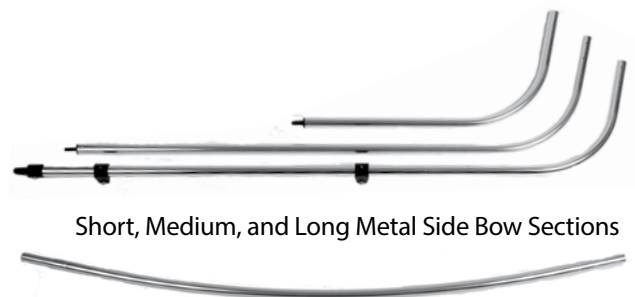

Center Metal Cross Bow Section

INSTRUCTIONS FOR CARVER 2 BOW BIMINI TOP

These instructions show how to assemble the top, with its frame and straps, **starting upside down** and inverting to an upright position when attaching to your boat.

Step 1 Identify the hook shaped, long and short metal side bow sections. Using the long side bow sections and one of the center cross bow sections, assemble the side bow and center bow parts as shown, aligning the pre-drilled holes. Use the 1/2", no. 8 screws to connect the bow parts securely.

Repeat this procedure for the short bow, aligning the pre-drilled holes and securing them with 1/2", no. 8 screws.

Caution: If screw heads become burred, cover heads with duct tape or file down screw heads to avoid damage to canvas.

Step 2 Spread the Bimini Top canvas out on a flat, clean area with the bottom side up. Sewn-in label indicates the bottom, or inside, and the back of the top.

Step 3 With the bows assembled, insert the short bow assembly through the sleeve at the front of top. (This is the sleeve opposite the end with the sewn-in tag.) *Note the position of the single pre-drilled holes on the bow frame. (Holes should be facing toward the middle of the canvas.)*

Insert the long bow assembly through the sleeve at the back of the top (nearest the sewn-in tag). *Again, note the position of the single pre-drilled holes on the long bow frame. (Holes should be facing toward the middle of the canvas.)*

Step 4 Pass looped end of each hold down strap over each end of the bows. Use a no. 8, 1/2" screw to fasten straps to bow frame at each pre-drilled hole position as shown. Position strap over hole and insert screw, with finish washer, through center of strap and into pre-drilled hole.

Step 5 Connect short frame ends to jaw slides on each side of long bow frame. Frame ends can be rotated to align with jaw slides. Jaw slides should allow bows to pivot, but be tight enough to hold securely.

See page 7 of this instruction sheet for mounting the Bimini Top onto your boat.

①

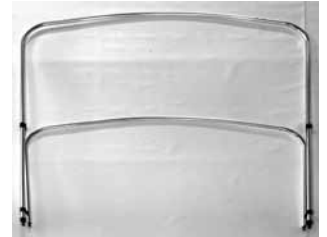
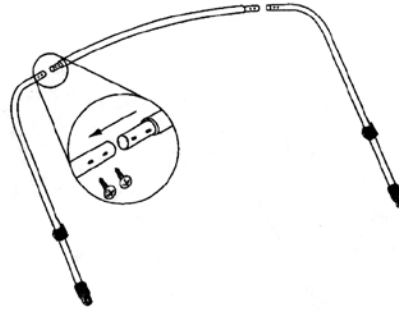

②

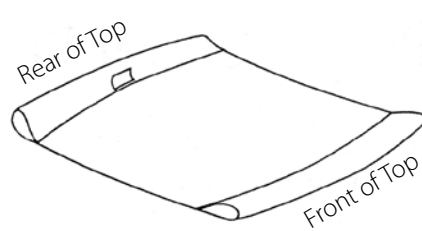

③

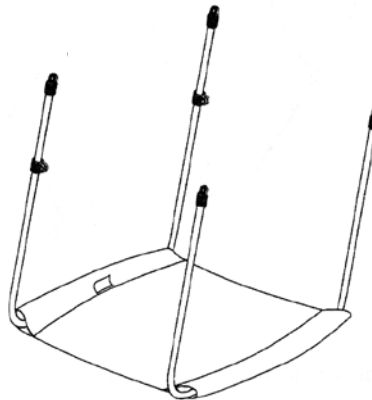

④

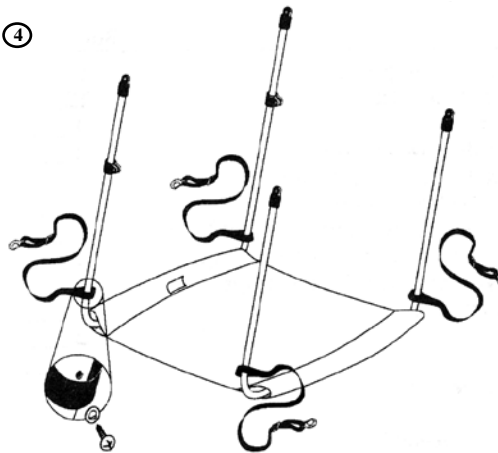

⑤

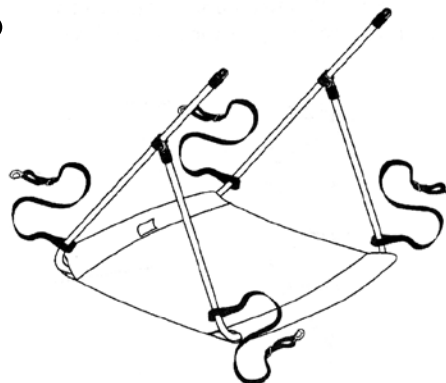

INSTRUCTIONS FOR CARVER 3 BOW BIMINI TOP

These instructions show how to assemble the top, with its frame and straps, **starting upside down** and inverting to an upright position when attaching to your boat.

FOR STAINLESS STEEL TOPS, PLEASE REFER TO THE SUPPLEMENTAL INSTRUCTIONS ON PAGE 5

Step 1 Identify the hook shaped, long, medium, and short metal side bow sections. Using the long side bow side sections, and one of the center cross bow sections, assemble the side bow and center bow parts as shown, aligning the pre-drilled holes. Use the 1/2", no. 8 screws to connect the bow parts securely.

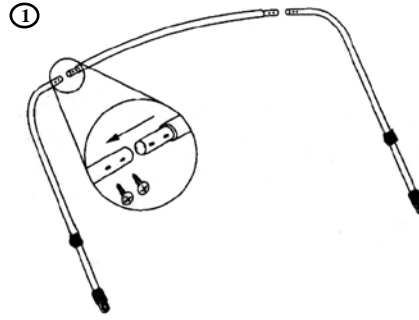

Repeat this procedure for the medium and short bows, aligning the pre-drilled holes and securing them with 1/2", no. 8 screws.

Caution: If screw heads become burred, cover heads with duct tape or file down screw heads to avoid damage to canvas.

Step 2 Spread the Bimini Top canvas out on a flat, clean area with the bottom side up. Sewn-in label indicates the bottom, or inside, and the back of the top.

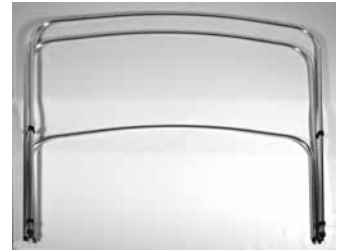
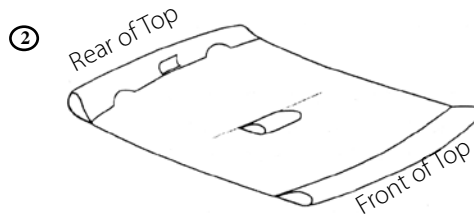

Step 3 With the bows assembled, insert the medium bow assembly through the sleeve at the front of top. (This is the sleeve opposite the end with the sewn-in tag.) *Note the position of the single pre-drilled holes on the bow frame. (Holes should be facing toward the middle of the canvas.)*

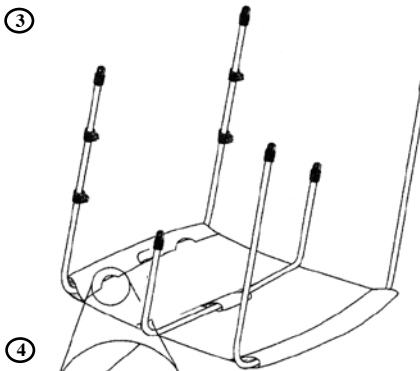

Insert the short bow assembly through the small sleeve in the center of the top and the long bow assembly through the sleeve at the back of the top (nearest the sewn-in tag). *Again, note the position of the single pre-drilled holes on the long bow frame. (Holes should be facing toward the middle of the canvas.)*



Step 4 Pass the buckled end of the adjuster strap through opening in the fabric and around the long bow. Thread looped end through buckle. Attention should be paid to the orientation of the strap and buckle so that the finished piece resembles photo A. Pass the looped end of the strap over the end of the short bow and slide down into position directly across from opening in fabric where buckled end is attached. (See illustration.) Leave at maximum length. Repeat this step for the second strap. See enlargement.

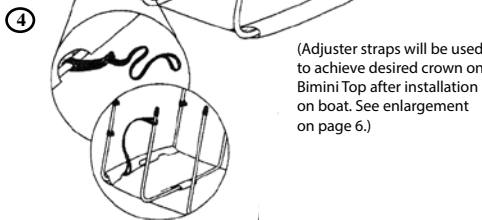

(Adjuster straps will be used to achieve desired crown on Bimini Top after installation on boat. See enlargement on page 6.)



Step 5 Pass looped end of each hold down strap over each end of the long and medium bows. Use a no. 8, 1/2" screw to fasten strap to bow frame at each pre-drilled hole position as shown. Position strap over hole and insert screw, with finish washer, through center of strap and into pre-drilled hole.

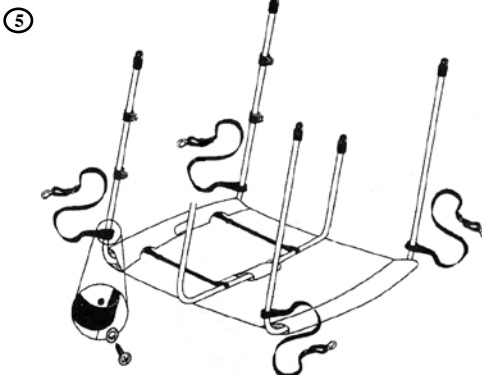

Step 6 Connect short frame ends to jaw slides on each side of long bow frame. Frame ends can be rotated to align with jaw slides. Repeat for medium frame ends as shown. Jaw slides should allow bows to pivot, but be tight enough to hold securely.

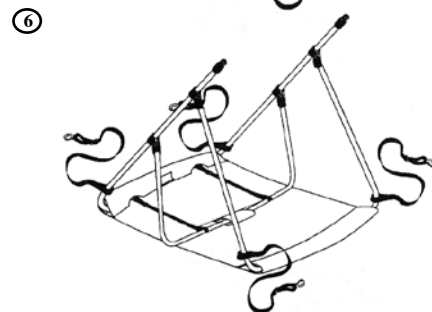

See page 7 of this instruction sheet for mounting the Bimini Top onto your boat.

INSTRUCTIONS FOR CARVER 4 BOW BIMINI TOP

These instructions show how to assemble the top, with its frame and straps, **starting upside down** and inverting to an upright position when attaching to your boat.

FOR STAINLESS STEEL TOPS, PLEASE REFER TO THE SUPPLEMENTAL INSTRUCTIONS ON PAGE 5

Step 1 Identify the hook shaped, long, medium, and short metal side bow sections. Using the long side bow sections, and one of the center cross bow sections, assemble the side bow and center bow parts as shown, aligning the pre-drilled holes. Use the 1/2", no. 8 screws to connect the bow parts securely.

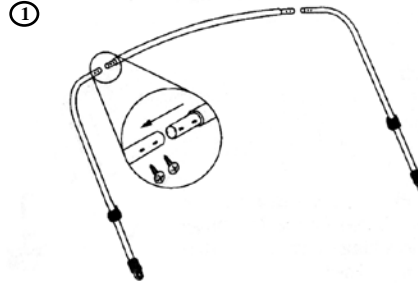

Repeat this procedure for the medium and short bows, aligning the pre-drilled holes and securing them with 1/2", no. 8 screws.

Caution: If screw heads become burred, cover heads with duct tape or file down screw heads to avoid damage to canvas.

Step 2 Spread the Bimini Top canvas out on a flat, clean area with the bottom side up. Sewn-in label indicates the bottom, or inside, and the back of the top.

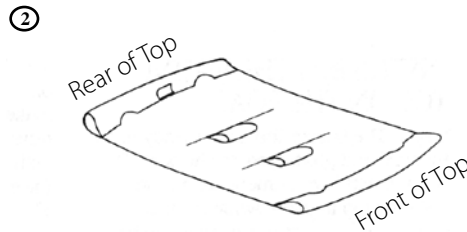

Step 3 With the bows assembled, insert the medium bow assembly through the sleeve at the front of top. (This is the sleeve opposite the end with the sewn-in tag.) *Note the position of the single pre-drilled holes on the bow frame. (Holes should be facing toward the middle of the canvas.)*

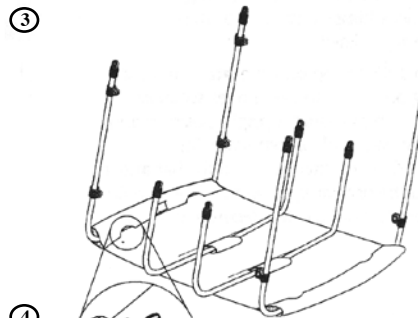

Insert the short bow assemblies through the small sleeves in the center of the top and the long bow assembly through the sleeve at the back of the top (nearest the sewn-in tag). *Again, note the position of the single pre-drilled holes on the long bow frame. (Holes should be facing toward the middle of the canvas.)*

Step 4 Pass the buckled end of the adjuster strap through opening in the fabric and around the long bow. Thread looped end through buckle. Attention should be paid to the orientation of the strap and buckle so that the finished piece resembles photo A. Pass the looped end of the strap over the end of the short bow and slide down into position directly across from opening in fabric where buckled end is attached. (See illustration.) Leave at maximum length. Repeat this step for the second strap then assemble the straps for the front bow. See enlargement.

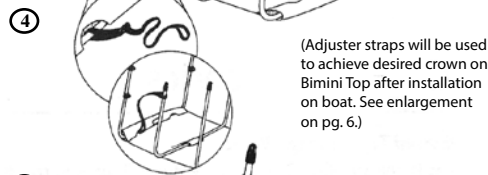

(Adjuster straps will be used to achieve desired crown on Bimini Top after installation on boat. See enlargement on pg. 6.)



Step 5 Pass looped end of each hold down strap over each end of the long and medium bows. Use a no. 8, 1/2" screw to fasten strap to bow frame at each pre-drilled hole position as shown. Position strap over hole and insert screw, with finish washer, through center of strap and into pre-drilled hole.

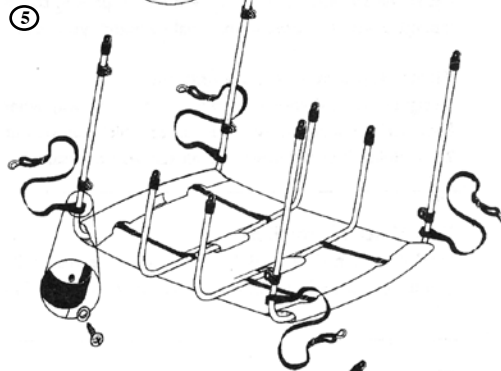

Step 6 Connect short frame ends to jaw slides on each side of long bow frame. Frame ends can be rotated to align with jaw slides. Repeat for medium frame ends as shown. Jaw slides should allow bows to pivot, but be tight enough to hold securely.

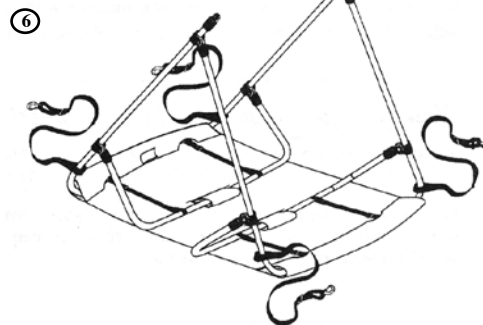

See page 7 of this instruction sheet for mounting the Bimini Top onto your boat.

See page 7 of this instruction sheet for mounting the Bimini Top onto your boat.

Square Tube Pontoon Bimini Top

Follow Instructions for 4-Bow Top
with these exceptions:

Step 7. The long bow has a jaw slide installed to mount the brace kit, instead of the pre-drilled hole for the hold-down strap. (See photo on label.)



Additional Instructions for Buggy-Style Pontoon Top with Tails:

1. To fit tails properly, pull the tails straight down and mark the snap locations onto the rails.
2. Drill 1/8" hole where each snap is marked on the rail. Install supplied screw stud into hole. Repeat for all snaps.
3. Snap tails to the rail.

(Note: the additional hardware (6 screw studs) are included in the fabric package.)

Stainless Steel Frame Supplemental Instructions

The assembly of a stainless steel frame requires the use of rivets instead of screws. For your convenience, a Hand Riveting Tool and all necessary rivets are included with your bimini top. Simple instructions for operating a Hand Riveting Tool are located on the back of the Rivet Tool package. **For your safety, it is highly recommended that you wear safety goggles when operating your Hand Riveting Tool.**

Following the steps provided for a 2, 3 or 4-Bow top, use a 3/16" rivet (provided) where a no. 8, 1/2" screw is specified. Align the pre-drilled holes, place thick end of rivet in hole and nail-end of rivet in rivet tool. Occasionally it may be necessary to tap the rivet in place. Set rivet by compressing handle of rivet tool three times. Rivet will pop and be seated firmly in place. Repeat process at all pre-drilled holes.

Should a rivet seat improperly, it can be drilled out using a 3/16" drill bit. Extra rivets are provided for your convenience.

Caring for your Bimini Top Canvas

To keep your canvas looking its best, regularly brush off any loose dirt with a soft brush and rinse with lukewarm water (100° F maximum). To clean, a solution of lukewarm water and mild natural soap such as Ivory™ may be used. Rinse thoroughly and allow to air dry. The use of detergents is not recommended as it may diminish the water repellent finish on certain fabrics. Never machine wash, dry clean or iron the canvas. To spot clean stubborn soil or stains, a solution of 1/4 cup mild natural soap and 1 cup of bleach per gallon of lukewarm water may be used. Mist the soiled area and clean vigorously with a sponge, soft brush or clean towel. Rinse thoroughly and allow to air dry.

Always fold down and secure bimini top in the stored position when trailering your boat.

Additional Instructions for Adjusting Height of a standard 35" Super Sport or standard 46" 3-Bow Bimini Top.

If you wish to shorten the height of the above style bimini tops, you may do so by carefully drilling out the rivets using a 3/16" drill bit. Take caution as to not damage the eye ends. Cut the desired length from the ends of the long bow (see drawing).

Once the bow has been shortened, re-set the eyes by using a 3/16" drill bit to carefully drill the hole for the rivet. Be sure the eye end is set in the correct position before you drill for the rivet. Use a rivet gun to set the rivet in place. Then follow the remaining instructions listed in the instruction sheet.

Note: Be sure all set screws, fittings and pre-installed hardware are tight.

Use hacksaw to cut the desired length. You can remove up to 10" from this section.

Do not attempt to shorten the short or medium bows.

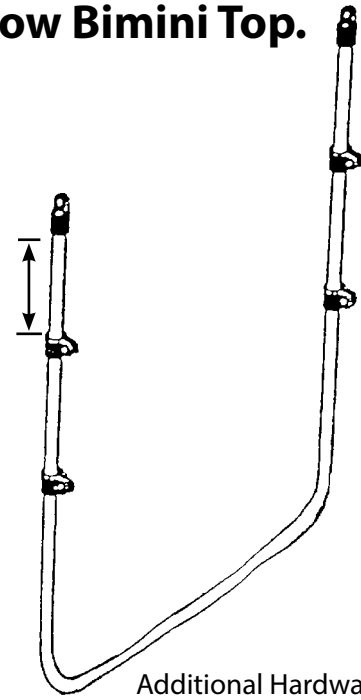

Additional Hardware Included
2 - 3/16" Rivets

How to Adjust the Inside Eye Ends

- Inside Eye Ends will rotate
- Place a soft cloth over the eye end to avoid marring, and carefully turn the Eye End using a pair of pliers.

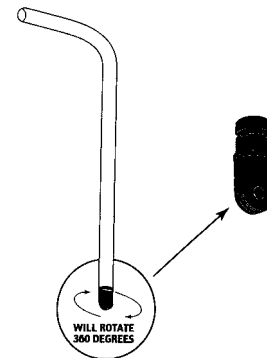

Universal Deck Hinge

with 90-degree stop allows mounting in virtually any position.

Standard Mount with screw heads to the outside as shown.

For alternate mounting positions, variations may apply.



INSTALLING THE BIMINI TOP ON THE BOAT

Step 1. The Bimini Top is now ready to be inverted and positioned on the boat. This is easier with two or more people, one to hold the top in place, while another marks the positions of the hinges to be attached to the gunnel of the boat.

Step 2. Measure the marked position of the hinges carefully to make sure they are exactly opposite each other. If not aligned properly, the top may become warped or damaged and unstable while in use, or look unbalanced.

Step 3. Use a drill with a 9/64" bit to drill the pilot holes for the deck hinges. If drilling into fiberglass hollow out the pilot hole to avoid cracking fiberglass when installing the screws. Secure the deck hinges with 1", no. 10 sheet metal screws provided.

Step 4. Place top on boat, attaching the long bow ends to the hinges securely. Raise top to desired upright position and adjust each hold-down strap. Straps should be adjusted to a length that attaches to the boat at approximately 45° to 60° angles to hold the top securely to boat.

Step 5. Mark the position of the eye straps on the gunnel of the boat, measuring to make sure they are exactly opposite each other on the sides of the boat. Use a drill with a 9/64" bit to drill the pilot holes for the eye straps. Be sure to hollow out the pilot holes with the drill bit if drilling into fiberglass. Secure the eye straps with 1", no. 10 sheet metal screws provided.

Step 6. Attach the snap hook to the eye straps and adjust the hold down straps.

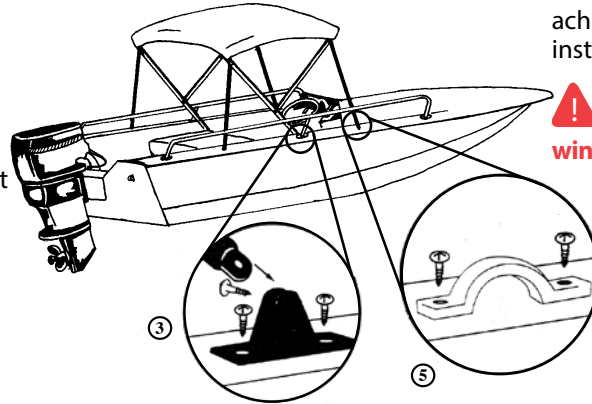

Please Note: The process of assembling the bimini frame may cause the width of the frame to expand or retract at the mounting points. If the frame appears too wide or too narrow when you are ready to mount the top on the boat, simply mount one side and, with minimal force, push or pull the opposite side to fit the mounting point on the gunwale.

Important note to Top Installer/User: Be sure all set screws, fittings and pre-installed hardware are tight.

Desired crown on Bimini Top can be achieved using adjuster straps after installation is complete.

! If mounting your bimini top to a windshield, you may need shorter screws to prevent cracking the windshield.

CAUTION: Always fold down and secure bimini top in the stored position when trailering your boat.

Installing a Carver Brace Kit

Carver Brace Kits are available in:

- Aluminum tubing with Nylon Fittings - Fixed or Adjustable
- Aluminum tubing with Stainless Steel Fittings - Fixed only
- Stainless Steel tubing with Stainless Steel Fittings - Fixed only

All Brace Kit packages contain:

- 2 - Braces
- 2 - 90° Deck Hinges
- 2 - Hinged Jaw Slides w/ screw and bolt
- 4 - #10 x 1" stainless steel screws (for mounting the deck hinges)
- 2 - 3/16" rivets (required only when cutting down braces)

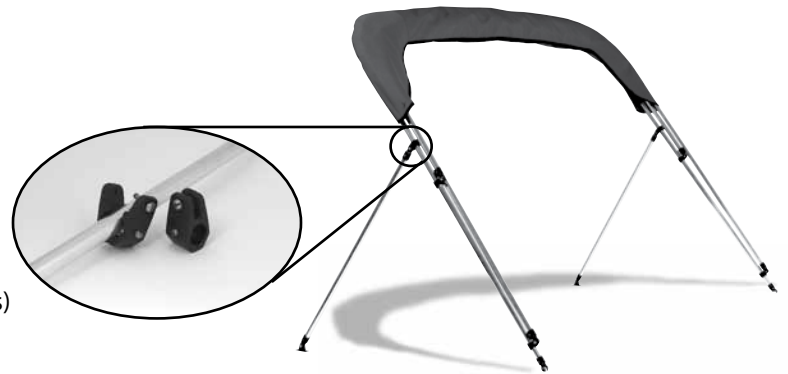

All fixed braces are 48" long. Adjustable braces "telescope" from 22" to 44", the desired length being "set" by a joiner section.

The height of fixed aluminum braces may be adjusted by removing and replacing one eye end on each brace. To remove the eye ends, use a 3/16" drill bit to drill out the rivets. Carefully measure and cut down the tubing to the desired length using a hacksaw. To replace the eye ends, use a 3/16" drill bit to carefully drill the hole for the replacement rivets. Be sure each eye end is set in the correct position before drilling for the rivet. Use a rivet gun to set the rivets in place.

The height of stainless steel braces is best adjusted by moving the mounting location fore or aft on the gunnel (given the hardness of the metal, stainless steel is not easily cut with household tools).

The typical location to attach the braces to the main (long) bow is 2 inches beneath the rear hold down straps.

To attach the braces, the bimini top must be deployed (in its upright position). Carefully measure the exact location for the hinged jaw slide on each side of the main (long) bow and mark with a black marker. Be sure the measurement is identical on port and starboard side. Open the hinged jaw slides and fasten each around the main bow at the marked locations by tightening the screw securely. Insert the braces into the jaw slides by inserting the eye ends and securing tightly with the bolts provided. Once the braces are attached to the main bow, determine the mounting locations for the deck hinges. The typical mounting point will create a 45° to 60° angle with the main (long) bow when the braces are mounted to the gunnel. To mount the deck hinges, refer to Steps 2 and 3 in the **Bimini Top Installation Instructions above.**

Installing a Carver Slide Track Kit

Carver Slide Track Kits are available in 18", 24", 36", 48" and 60" lengths to accommodate virtually any boat and bimini top.

All Slide Track Kit packages contain:

- 2 - Aluminum Slide Tracks
- 2 - Sliding Deck Hinges with combined Slide Locks
- 2 - Side-Mount Sliding Deck Hinges
- 2 - Slide Locks (for use with side-mount hinges)
- 4 - End Caps
- All necessary screws for mounting.
- (All screws are #8 x 1" Stainless Steel).

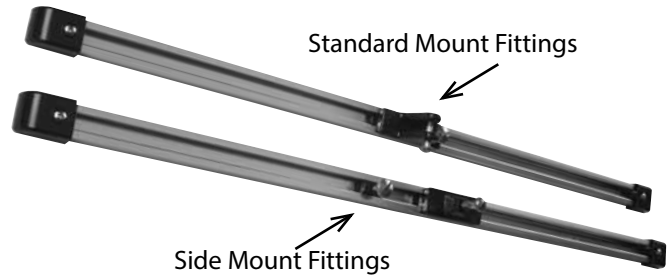

Slide track should be installed on a level surface and may be mounted on top of the gunnel or on the inside of the gunnel (side-mounted).

Determine the location for the slide track. Carefully measure and mark the mounting locations making sure the measurements are identical on port and starboard side so that the tracks will be exactly opposite. Slide tracks are pre-drilled for easy installation.

Use a 1/8" drill bit to drill screw holes. If drilling into fiberglass, it is important to hollow out the drill hole with the drill bit to avoid cracking the fiberglass when screws are tightened. Insert all screws and tighten securely.

Slide the appropriate hinges into the track (combination hinges for standard mount track or side-mount hinges and slide locks for side-mounted track). The locks should be positioned forward of the hinges and tightened to a fixed position. Attach the end caps using the screws provided. The main (long) bow may now be inserted into the track by attaching the eye ends to the deck hinges. Adjust the position of the bimini top by loosening the locks and sliding them into the desired position. Always retighten the slide locks after adjusting the position of the bimini top



Accessories

Bimini Top Storage Boot

Let in the sun. Our 2, 3, and 4 bow Bimini Tops fold together and out of the way in the protective storage boot. Available in material to match your top.



Bimini Top Braces Also available

Designed to hold your top up and out of the way when top is folded and not in use. Each package includes two 7/8" tubes which can be cut to desired lengths, 2 hinged jaw slides, 2 deck hinges, and all screws necessary for mounting. One pair to a package.

Slide Track Kit for Tops

Each aluminum slide track kit includes 2 slide tracks, 2 sliding deck hinges with combined slide locks, 2 side-mount sliding deck hinges with separate slide locks, 4 end caps and all necessary screws for mounting. One pair to each package.



Bimini Top Replacement Hold-Down Straps

Constructed of 1" black polypropylene webbing with heavy nickel-plated brass snap hook and stainless steel adjustable buckle. Available in two lengths. Packed in sets of four.



BETTER COVERS. BETTER SERVICE.

Carver Industries produces quality Boat Covers, Personal Watercraft Covers and Bimini Tops. We take great pride in the craftsmanship and attention to detail that goes into all of our products.



SELECTING A BIMINI TOP

To select a bimini top for your boat you will need to know the length, height and width of top your boat requires.

1. Determine what portion of your boat you want the top to cover. The tops come in 5', 5'6", 6', 8', 9' and 10' lengths.
2. Determine where you want the top mounted. Measure the width between these two points to determine the width of your top. All mounting hardware is included with our tops including universal deck hinges with 90 degree stops to allow mounting in virtually any position.
3. Stand inside your boat and measure the distance in height from the mounting points to the height you desire. This will help you determine how high your top needs to be.

BIMINI TOP CARE & MAINTENANCE

Protect your investment by following these care tips.

- Check all screws and fittings regularly and tighten as needed.
- Be sure the hold down straps are tight. There should be no slack in the hold-down straps when attached to the eye straps on the gunwale.
- When trailering, fold down the bimini top and stow in the storage boot.
- Do not exceed 35 MPH with the bimini top deployed. Be aware of wind speeds.
- To keep your canvas looking its best, regularly brush off any loose dirt with a soft brush and rinse with lukewarm water (100° F maximum). To clean, a solution of lukewarm water and mild natural soap such as Ivory™ may be used. Rinse thoroughly and allow to air dry. The use of detergents is not recommended as it may diminish the water repellent finish on certain fabrics and invite the growth of mildew. Never machine wash, dry clean or iron the canvas. To spot clean stubborn soil or stains, a solution of 1/4 cup mild natural soap and 1 cup of bleach per gallon of lukewarm water may be used. Mist the soiled area and clean vigorously with a sponge, soft brush or clean towel. Rinse thoroughly and allow to air dry. We also recommend the use of 303 Fabric & Vinyl Cleaner to safely remove dirt and difficult stains.
- Regular exposure and cleaning can diminish the water repellency of certain bimini top canvas over time. The water repellent finish used on most bimini top canvas allows water to bead and run off similar to that of a waxed car. When water beading diminishes, we recommend the use of 303 High Tech Fabric Guard after a thorough cleaning to restore the water repellency of your canvas.