

2013



H Marine



2012-2013 Quality Marine
Accessories Catalog



Fellow boaters, fishermen, and industry partners:

Hello and thank you for continuing to consider T-H Marine for your boat parts and accessories. Wow! The past few years have been quite tough for our industry and our country as a whole. The "great recession" caused a drop of well over 50% in traditional power boat retail sales. This astonishing decrease fundamentally altered our industry. The decline in sales bottomed out in late 2011 and as I pen this message, the sales for the first half of 2012 are up around 12%. What a welcome relief to all of us in the great industry!

As the old saying goes, "Tough times don't last, but tough people do." That is also true for tough companies that pay attention to fundamentals and their customers. T-H Marine is proud to have grown substantially faster than the industry the past 3 years. We

have strong financials and we are investing in our business to allow us to serve our customers as the industry and economy improve. We thank you, our dedicated customers, for relying on T-H Marine.

We have a lot of exciting things going on. Please enjoy our 2013 catalog to check out our newest offerings. We have made major moves in a few areas that I would like to highlight: **LED LIGHTING** - We now have a broad line of very high quality, value priced LED lights for virtually all boat lighting applications. If you have not checked out our LED offerings, please do. **BOATING AND FISHING ACCESSORIES** - We have doubled our efforts and our presence at major professional fishing events. As a result, we have had some great ideas turn into great products. We have partnered with some of the top names in professional fishing - like Kevin VanDam and Gerald Swindle - to introduce and market some exciting new items. **ATLAS™ JACK PLATES** - while this is not new, I have to highlight the success we have had in hydraulic jack plates. T-H Marine is now the largest manufacturer of jack plates in the world and we have the dominate market share of boat manufacturers and pro fishermen using our ATLAS™ hydraulic jack plate.

We have also made big investments to improve our communication with our customer base of boat manufacturers, distributors, dealers, and boating consumers. We modernized our logo to have a "web button" look. We launched a brand new website with easy navigation, great graphics and thorough product descriptions. We also built our social media platforms to fully engage with our customers. Our Facebook, Twitter, Google+, and YouTube pages have gained a great following, been a lot of fun, and really plugged us in with the end-users of our products. We invite you to come on over to our social pages and connect with us to have some fun talking about boating and fishing.

Thank you again for allowing T-H Marine to be a part of your success, both in the factory and on the water.

Sincerely,
Jeff Huntley
President





SAMPLES:

Upon request, T-H Marine will ship sample products free of charge for your consideration.

PRICES:

Prices for items in this catalog apply to standard pack quantities only. All orders which do not reflect standard packaging quantities will be rounded to the nearest standard pack. T-H Marine will make every attempt to hold prices constant. Prices are subject to change due to uncontrollable cost increases.

DESIGNS:

All catalog items are subject to change or design improvement at any time during the catalog year.

WARRANTY:

All T-H Marine Supplies, Inc. products are covered by a one year limited warranty to be free from defective material or workmanship.



**ALL PRODUCTS
MADE IN U.S.A.**



New Products for 2012-2013

New Parts.....	Page No.
Blower Vent Grill Cover	24
G-Force Handle	35
G-Force Culling System	35
Oetiker® Stepless® Ear Clamp Kit	38
Oetiker® Hose Clamps.....	38
LED Oblong Courtesy Light.....	41
Slim Line LED Utility Strip Light	41
LED Underwater Light	41
Stainless LED Puck Light.....	42
Recessed LED Puck Light	42
LED Surface Mount Light	42
LED Companion Way Light	43
LED Courtesy Companion Way Light.....	43
LED Rail Light	44
Flush Head LED Livewell Light.....	44
Mini LED Dual Mount Courtesy Light	44
LED Spreader Light	45
LED Flex Strip Rope Light	45
LED Super Spreader Light	45
Robo Cup® Holder/Rod Holder	50
Frame Top Battery Tray	53
Pontoon Gate Latch with Stainless Steel Inserts.....	54
Aqua Clips	58

Each year T-H Marine strives to bring exciting new products to the marine marketplace. This year is no exception. Take a look at this year's newest list of "Problem Solvers." We are excited that this year we have new products that not only solve problems but save labor as well. We are confident that you will find a solution for your needs.



Hatches, Plates & Lids

Lid Locks & Latches	2
Locks & Latches, Slam Latches	
Hatches	3-5
Designer Series™ Access Hatches, Sure Seal™ Access Hatches, Locking, Non-Locking, Vertical Access Doors, Drop In Boxes, Tackle Boxes, Tackle Tray, Organizer, Glove Boxes	
Deck Plates	5-6
Quick Release, Low Profile Twist Out, Screw Out, Pry Out, Screw Down	
Lid Accessories	7
Storage Tubes, Lid Lifts, Hatch Pins, Restraint Straps, Lid Springs	

Performance

Jack Plates	8-11
Atlas™ Series Hydraulic Jack Plates, Atlas™ Series Hot Shot™ Jack Plates, Atlas™ Micro Jacker, Atlas™ Tilt 'N' Trim Units, Z-Lock™ Manual Jack Plate, High Performance, Mechanical, Fixed	
Trim Controls, Performance & Safety	11-15
Wheel Mount, Floor Mount, Transom Mount, Throttle Mount, Foot Throttles, Foot Throttle Mount, Transom Wedges, Emergency Ladder, Outboard Motor Brackets, Engine Accessories, Stabilizers, Ignition Kill Switches, Skegs	

Plumbing & Drain

Plumbing, Aeration & Livewell Accessories	16-20
Quik Plumb™ Plumbing System, EZ Pump™, Brite Plate™ Chrome Plated Parts, Pro Air Pumps, Max-Air™ Venturi, Baitwell Kits, Aerator Controls, Spray Heads, Wash Down/Spray Head Combo, Wash Down Fittings	
Drains & Drain Plugs	20-26
Cockpit Drains & Scuppers, All Purpose/Hatch Drains, Impact Drains, Oval Vents, Floor Drains, Splash Well Drains, Seat Pedestal Drains, Drain Plugs, Overflow Tubes, Livewell Drains, Garboard Drain	
Fittings, Filters & Screens	27
Stainless Steel Mesh, Pump Screens, Drain Filters	
Thru-Hulls	27-29
Straight, Extended Length, Ninety Degree, Threaded, Specialty Filters, Stainless Mesh Screens	
Plumbing Fittings	29
Adapters, Reducers, Elbows, Tees, Gaskets	
Manifold Systems	30
"T" Fittings, Adapter Fittings, Nipple Fittings, Reducer Fittings	
Valves	31
Remote Drain Control, Diverter Valves, Seacock Remote Arm	

Fishing

Custom Rod Organizers and Tubes	32-22
Molded Faceplates, Oval Rod Tubes, OEM Rod Tubes, Mounting Faceplates, Tube End Caps	
Rod Holding Devices	33-34
Rod Holders, Rod Grommets, Flanges, Rod Straps, Rod Holder Drains, Rod Tubes & Racks, Fish Rulers	
Trolling Motor Accessories	41-42
G-Force Handle, G-Force Culling System, Circuit Breaker Kit, Extension Handle, Trolling Motor & Charge Plugs, Foot Control Switches	

Motorwell to Engine and Rigging Accessories	36-40
Zippered Rigging Sleeve, Flex Sleeving, Rigging Flanges & Hose, Hose Clamps & Cable Ties, Hydraulic Hose Stress Fitting, Cable Boots, Reinforcement Rings, & Grommets, Wire Covers, Vent Flanges, Clamps, Wire Hose Hangers, Utility Grommets, Clam Shell Vents	
LED Lighting	41-46
Utility Strips, Companion WayLights , Oblong Courtesy Lights, Stainless Steel and Recessed Puck Lights, Surface Mount with Dome Lights, Rail Lights, Underwater Lights, Utility/Livewell Lights, Mini Dual Mount Courtesy Light, Spreader and Super Spreader Lights, Flex Strip Rope Lights, Shark Eye Lights	
Lighting.....	47
Head Lights, Courtesy Lights, Livewell Lights, Trailer Back-up Lights, Light Holder Clips	
Quick Flush™ Outboard Flushing System.....	48
Holders & Restraint Devices.....	48-52
Seat Pedestal Holders, Utility Flanges, Trailing Clips, Motor Support, Magnetic Wheel Chock, Windshield Fasteners, Prop Retainer, Fuel Container Hold Down, All Purpose Strap, Paddle Keeper, Cooler Mounting Kit, Steer Stop™ Steering Lock, Cup Holders, Motor Stik™ Outboard Motor Support	
Battery Trays.....	52-53
Poly Strap Models, Stainless Steel Rod Models, Combo Models, Related Accessories	
Bungee/Shock Cord, Fuel System and Pontoon Boat Accessories	54-55
Boat Furniture Legs, Saf-T-Latch™, Dead Bolt Gate Latch, Gate Latches, Door Stops Rail Shims, Cleats, Splash Guards, Steering Console Mount, Throttle Control Mount	
Aluminum Boat Mounts/Rub Rail Fittings & Cleat	56
Splash Guards, Steering Console Mount, Throttle Control Mount, End Caps, Butt Splices	
Wash Down Station & Coiled Hoses	57
Boating Accessories.....	57-58
Hose Holder, Vinyl Caps Prop Wrench & Garboard Drain, Winterize Kit, Anchor Retrieval System, Aqua Clips, Grab Handles	
CMC Products.....	59-65
CMC Hydraulic Power Lift Jack Plates, CMC Manual Power Lift Jack Plates, CMC Static Set Back Plates, CMC Accessories, CMC Tilt 'N' Trim Units, CMC Transom Spacers & Clamp Adapters, CMC Breakaway Unit	
Alphabetical Index.....	66-69
Part Number Index	70-72

Rigging

LED Lighting

Marine Accessories

CMC Jack Plates & Trim Units

Indexes



Anchor Handle Locks

- Easy Grip “Two Finger” Handle
- Waterproof “O” Ring Seals
- For Lids Up to 3/4” Thick
- Fits 2-3/8” to 2-1/2” Hole

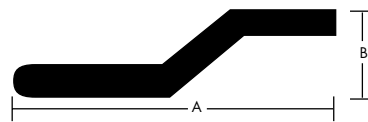

Part #	Type	Body Color	Handle Color	
AL-1	Locking	Black	Black	
ALN-1	Non Locking	Black	Black	
AL-2	Locking	White	White	
ALN-2	Non Locking	White	White	
ALC-1	Locking	Black	Chrome	
ALCN-1	Non Locking	Black	Chrome	
ALC-2	Locking	White	Chrome	
ALCN-2	Non Locking	White	Chrome	
ALS-1	Lock Spacer for Lids Under 1/2” Thick			
Cams/Stainless	Cams/Zinc	Type	“A” (in)	B” (in)
CAM-SSA	CAM-ZA	Straight	2-1/4”	
CAM-SSAXL	CAM-ZAXL	Straight	3”	
CAM-SSC	CAM-ZC	Offset	2-1/4”	1”
CAM-SSCXL	CAM-ZCXL	Offset	3-1/4”	1”



Recessed Locks & Latches

- Water Tight “O” Ring Seal
- Stainless Steel Lift Ring
- For All Type Lids
- Fits 2-3/8” to 2-1/2” Hole

Locking Part #	Non-Locking Part #	Max Lid Thickness	Color
RL-1	NRL-1	3/4”	Black
RL-2	NRL-2	3/4”	White

Deck Lid Slam Latches

- Web Strap Pull Release with 40” Strap
- Unit Ships Complete with Striker
- Models to Orient in 2 Directions



DLSL-1N	Deck Lid Slam Latch – North
DLSL-1S	Deck Lid Slam Latch – South



Nautical Slam Latches

- Low Profile Oval Design
- UV Stable – Corrosion Resistant
- Stainless Steel Striker Plate
- Fits 2” Round Hole

Part #	Material Thickness	Spacer Thickness	Screw Length
NFSL-5-X	1/16” to 7/8”	Skin Packed - All Parts Included	

“X” in Part # denotes color code, use following color codes:
1-Black 2-White 3-Sand

Designer Series™ Access Hatches

- Cam Style Locks Hold Lid Securely
- Positive Lid Seal for Water Tight Fit
- Hidden Fasteners in Frame
- Stainless Steel Hinges Allow Full 180 Degree Opening
- Structurally Engineered “Walk On” Lids
- Six Sizes for All Uses — Vertical or Horizontal
- Four Tackle Centers — Tackle Trays Optional
- Deck Seal Optional

Drop-In boxes on Page 4.



Removable Door

Rope Locker Slot can be installed in any size hatch — Call for ordering information.



Available in:
11"x19"
13"x17"
13"x24"
13"x30"

Part Numbers	Removable Door	Outside	Inside	Cut-Out
HDS-0714-X		7-1/2" x 14-1/4"	4-5/8" x 11-1/4"	5-1/8" x 11-7/8"
HDS-1115-X		11" x 15"	7-5/8" x 11-5/8"	8-1/4" x 12-1/8"
HDS-1119-X	HDS-1119-X-REM	10-7/8" x 18-7/8"	7-5/8" x 15-1/2"	8-1/4" x 16-1/8"
HDS-1317-X	HDS-1317-X-REM	12-7/8" x 16-7/8"	9-5/8" x 13-1/2"	10-1/8" x 14-1/8"
HDS-1324-X	HDS-1324-X-REM	12-7/8" x 23-3/4"	9-5/8" x 20-1/2"	10-1/8" x 21-1/8"
HDS-1330-X	HDS-1330-X-REM	12-7/8" x 29-3/4"	9-5/8" x 26-3/8"	10-1/8" x 27"
HDS-1620-X		16"x20"	12-5/8"x16-5/8"	13-1/8"x17"

"X" in Part # Denotes Color Code: 1=Black 2=Polar White 3=Sand Shell 7=Light Gray



Enlarged view of optional deck seal

Designer Series™ Access Hatch Locking

- Same Features as our Popular Designer Series Hatches
- Now with Stainless Steel Lock – Prevents Unauthorized Access
- Dual Latches and Lid Seal for Watertight Design
- Hidden Fasteners in Frame



Part #	Description	Outside Dim	Inside Dim	Cut Out Dim
HDSL-1115-X	Access Hatch - Locking	11"x15"	7-5/8"x11-5/8"	8-1/4"x12-1/8"
HDSL-1324-X	Access Hatch - Locking	12-7/8"x23-3/4"	9-5/8"x20-1/2"	10-1/8"x21-1/8"

"X" in Part # Denotes Color Code: 1=Black 2=Polar White 3=Sand Shell 7=Light Gray

Designer Series™ Vertical Access Door with Vent

- Slam Latch for Easy Opening and Closing
- Large 16"x20" Size
- Slotted Vent for Air Flow
- Great for Battery Compartments
- Stainless or Molded Latches

Available

Part #	Description	Outside Dim	Inside Dim	Cut Out Dim
HDDS-1620-"X"LV	Access Door w/Vent	16"x20"	12-5/8"x16-5/8"	13-1/8"x17"

"X" in Part # Denotes Color Code: 1=Black 2=Polar White 3=Sand Shell 7=Light Gray





GDS40714-X

Designer Series™ Glove Boxes

- Cam Lock – Holds Lid Securely
- Positive Lid Seal for Water Tight Fit
- Stainless Steel Hinges
- Hidden Fasteners in Frame
- Push Button Lock with Lift Tab
- Easy to Open – Locks Securely
- Prevents Unauthorized Access
- Hidden Fasteners in Frame



GDSL-0714-1

Part #	Description	Outside Dim	Inside Dim	Cut Out Dim
GDS4-0714-X	Glove Box – Non Locking	7-1/2"Wx14"L	4-5/8"Wx11-1/4"L	5-1/2"Wx12"L
GDSL-0714-1	Locking Glove Box-Black	5-1/2"Deep	5" Deep	
GDSL-0714-2	Locking Glove Box-White			

"X" in Part # Denotes Color Code: 1=Black 2=Polar White 3=Sand Shell 7=Light Gray



Designer Series™ Tackle Centers

Part # (No Trays)	Part # (w/ Trays)	Description
TDS-0714-X	TDS-0714-2T-X	7"x14" Tackle Center – Fits Two 3600 Trays – 10" Deep
TDS-1115-X	TDS-1115-3T-X	11"x15" Tackle Center – Fits Three 3600 Trays – 10" Deep
TDS-1317-X	TDS-1317-4T-X	13"x17" Tackle Center – Fits Four 3600 Trays – 10" Deep
TDS-1330-X	TDS-1330-4T-X	13"x30" Tackle Center – Fits Four 3600 Trays – 10" Deep

"X" in Part # Denotes Color Code: 1=Black 2=Polar White 3=Sand Shell 7=Light Gray



Sure-Seal™ Access Hatches

- Easy Access to Horizontal or Vertical Storage
- Watertight – Lid Overlaps Frame
- Dual Seals – Lid and Frame
- No Visible Fasteners
- Corrosion Free Integrated Hinge
- 180 Degree Door Opening
- Available in Lockable Version



Part Numbers

Dimensions

Locking	Non-Locking	Outside	Inside	Cut-Out
HATL-1115-x	HAT-1115-x	10-3/4" x 15"	7-3/8" x 11-1/4"	8-3/4" x 12-5/8"
HATL-1317-x	HAT-1317-x	12-3/4" x 17-3/4"	9-5/16" x 14-3/16"	10-1/2" x 15-1/8"
HATL-1324-x	HAT-1324-x	13 x 23-1/4"	9-1/2" x 19-5/8"	11 x 20-7/8"
HATL-1330-x	HAT-1330-x	13-1/4" x 30-3/4"	10" x 27-1/4"	11-1/4" x 28-1/2"

"X" in Part # Denotes Color Code - 1=Black 2=Polar White 3=Sand Shell 7=Light Gray



Tackle Tray Boxes

- Vacuum formed Tackle Centers
- Includes Sure-Seal™ Hatch
- Popular Plano Style Trays



TBOX-1115-x	Box with 11" x 15" Hatch – Without Trays – 9" Deep*
TBOX-1115-3T-x	Box with 11" x 15" Hatch – With 3 Trays – 9" Deep*
TBOX-1317-x	Box with 13" x 17" Hatch – Without Trays – 11" Deep*
TBOX-1317-3T-x	Box with 13" x 17" Hatch – With 3 Trays – 11" Deep*
TTRAY-3600	Tray Only for TBOX-1115 – 11" x 7" x 1-3/4"
TTRAY-3700	Tray Only for TBOX-1317 – 14" x 8-3/4" x 2"

"X" in Part # Denotes Color Code - 1=Black 2=Polar White 3=Sand Shell 7=Light Gray

*See SureSeal™ Access Hatch dimensions on previous page for length, width and cutout

Drop-In Storage Boxes

- Store Tackle or Gear – Stays Dry
- Vacuum Formed Storage Containers
- For Designer Series™ and Sure-Seal™ Hatches
- Easily Drops Into Frame – Easy to Remove
- Mounting Clips Attach to Frame

Part #	Hatch Series	Fits Size	Depth
BDS-1115-9-DP	Designer Series™	11" x 15"	9"
BDS-1324-12-DP	Designer Series™	13" x 24"	12"
BOX-1115-6	Sure Seal™	11" x 15"	6"
BOX-1115-10	Sure Seal™	11" x 15"	10"
BOX-1324-9	Sure Seal™	13" x 24"	9"
BOX-1324-12	Sure Seal™	13" x 24"	12"



*See Designer Series™ on pg. 3 or Sure Seal™ on previous page for dimensions

Port Light – 3"x10"

- Opening Style with Polycarbonate Lens
- UV Stable Plastic Resin – Chemical Resistant
- Custom Seal Provides Watertight Design
- Available in Smoke or Clear Lens – With or Without Screen
- Matching Trim Ring

Part #	Description	Outside Dim	Inside Dim	Cut Out Dim
DSPL-0310-2-X-Y	Port Light – 3"x10"	5-3/4"x12-1/2"	3"x9-3/4"	3-1/2"x10-1/4"

X = Color Y=Screen or No



Quick Release Deck Plate

- Cam Hatch Holds Secure
- Hidden Fasteners in Ring
- Gripper in Lid Prevents Rotation
- Easy to Open & Close
- Textured Finish



Part #	Description	Outside	Inside	Cut-Out
DPCAM-6-"X"	Quick Release Deck Plate 6" Dia	8"	5-1/8"	6-1/4"
DPCAM-8-"X"	Quick Release Deck Plate 8" Dia	10"	7-1/8"	8-1/4"

"X" in Part # Denotes Color Code - Use the Following Codes
 1=Black 2=Polar White
 3=Sand Shell 7=Light Gray

Low Profile Twist-Out Deck Plates

- Quick Twist-Out Lid – Fast Access
- Smooth Low Profile Lid – Overlaps Frame
- Hidden Fasteners Provide Smooth Look
- "O" Ring for Watertight Design

Textured	Smooth	Description
DPSLP-4-X	DPSLP-4S-X	Twist-Out Deck Plate – 4"
DPSLP-5-X	DPSLP-5S-X	Twist-Out Deck Plate – 5"
DPSLP-6-X		Twist Out Deck Plate – 6"
DPSLP-8-X		Twist Out Deck Plate – 8"

"X" in Part # Denotes Color Code: 1=Black 2=Polar White 3=Sand Shell 7=Light Gray





Sure-Seal™ Deck Plates

- Watertight – Lid Overlaps Frame
- Positive “O” Ring Seal
- Total UV & Chemical Stability
- No Visible Mounting Fasteners
- Lids Available Textured, Smooth or Diamond* Finish



Part Numbers					Dimensions		
Screw-Out Style		Pry-Out Style			(Diameter in inches)		
Textured	Smooth	Textured	Smooth	Diamond	Outside	Inside	Cut-Out
DPS-4-X	DPS-4S-X	N/A	N/A	N/A	5-3/4"	4"	4-1/2"
DPS-6-X	DPS-6S-X	DPP-6-X	DPP-6S-X	DPP-6D-X	8"	6"	6-1/4"
DPS-8-X	DPS-8S-X	DPP-8-X	DPP-8S-X	DPP-8D-X	10"	8"	8-1/4"
DPOVAL-6D-X**		OD: 15-3/8" x 8-1/2"		ID: 13-1/8" x 6-1/8"	CO: 14-1/8" x 7-1/8"		

"X" in Part # Denotes Color Code - 1=Black 2=Polar White 3=Sand Shell 7=Light Gray

*Diamond Finish available in Pry Out only

**Oval available in color codes 2 & 3 only



Designer Series™ Screw Down Deck Plates

- Tough Non-Corrosive Poly Material
- Flanged to Fit Hole Securely
- Textured Top – Smooth Tapered Edges

Black	White	Description
DSSDP-1-1	DSSDP-1-2	Screw Down Deck Plate – 6" OD
DSSDP-2-1	DSSDP-2-2	Screw Down Deck Plate – 8" OD



Screw Down Deck Plates

- Strong Super Tough Poly
- Inexpensive Alternative to Screw-Out Plates
- Attractive Matte Finish

Size (O.D.)	Part Number Based on Color of Deck Plate			Sure Seal Color Match
	Black	Off-White	Fish White	
5-5/8"	SDP-1	SDP-1W	SDP-1FW	SDP-1-x
8"	SDP-2	SDP-2W	SDP-2FW	SDP-2-x
10"	SDP-3	SDP-3W	SDP-3FW	SDP-3-x

"X" Denotes Color Code - use Sure-Seal™ Deck Plate color codes on page 6.



Sure-Seal™ Versatubes™

- Clear PVC Storage Tubes
- Includes Sure-Seal™ 4" Deck Plate
- Protects Valuables – Keys, Flares, Charts, etc.

Available with 12 volt female Marinco™ power plug in 8" or 12" lengths.

VT-8-X	8" Length	Replace "X" with Color Codes from Sure-Seal™ Deck Plate Info as shown above.
VT-12-X	12" Length	
VT-27-X	27" Length	

Lid & Hatch Support Springs

- Stainless Spring Steel
- Deflects to Close
- Supports 10 to 20 lb. Lids

Part #	Size	Description	Supports
LS-1	7/16" x 8-1/2" L	Formed Wire Ends	10 lbs
LS-2	7/16" x 8-1/2" L	Molded Nylon Ends	10 lbs
LS-2C	7/16" x 8-1/2" L	LS-2 w/Restraint Cable	10 lbs
LS-3	7/16" x 8-1/2" L	Offset Stainless ends	10 lbs
HS-1	5/8" x 12" L	Molded Nylon Ends	20 lbs
HS-1C	5/8" x 12" L	HS-1 w/Restraint Cable	20 lbs
HS-3C	5/8" x 12" L	HS-1C w/Stronger Cable	20 lbs

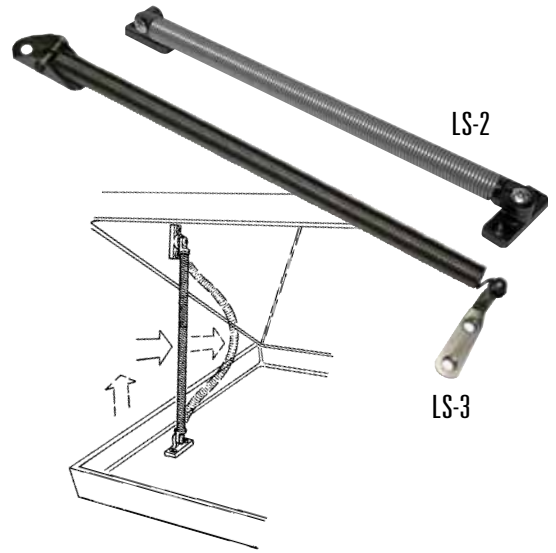

Lid Lifts

- Injection Molded Poly
- Bottom Cup Prevents Water from Entering Box
- Large 3-Finger Opening on LLR's
- Easy to Install



Black #	White #	Off-White #	Outside	Hole Size
LL-1	LL-2		2-3/4" x 2-3/4"	2-1/8"
LLM-1	LLM-2	LLM-3	2-1/4" x 2-1/4"	1-5/8"
LLR-1	LLR-2	LLR-3	3-1/2" x 2-1/4"	2 ea. 1-1/2"

Door Restraint Straps

- Restrains Doors, Hatches & Lids
- PVC Coated Stainless Steel Cable
- Stainless Steel "Eye" Ends
- Supports Up To 250 lbs

Part #	Description	Length
DRS-7	Door Restraint Strap	7"
DRS-9	Door Restraint Strap	9"
DRS-1	Door Restraint Strap	13"
DRS-16	Door Restraint Strap	16"
DRS-20	Door Restraint Strap	20"
DRS-36	Door Restraint Strap	36"

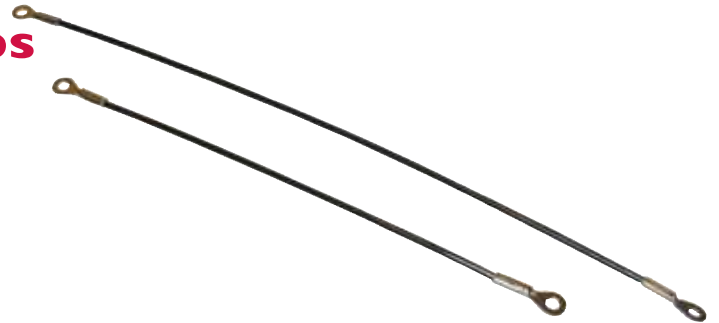

• Custom straps available. Call for details.

Hatch Lift Pins

- Strong Flexible Molded Material
- No Rattles, Corrosion or Heat Absorption
- Stainless Steel Lock Nut

Part #	Description	Color
HP-1	Hatch Lift Pins	Black

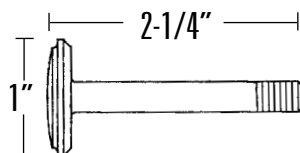

Atlas™ Series Hydraulic Jacking Plates



Atlas™ is an all new design to meet the demands of today's high performance outboards. This one piece design featuring the innovative Rod and Slot lifting system will handle the stresses from the heaviest and most powerful V6 outboards, 300hp or less, on the market today. All of the hydraulics are built into the jack eliminating the necessity of installing pumps and reservoirs inside the transom. This all new hydraulic unit is fast too...lifting from bottom to top in 8 seconds!



Check out these features:

- Self Contained Hydraulics • Fast – 8 second Lift Time
- Rod and Slot Lifting Design • High Tech Polymer Rods
- Easy to Install – Easy to Service
- Installs in Half the Time of Comparable Jacks
- Available in 4" – 6" – 8" – 10" & 12" Setback Models
- Lifetime Warranty on Frame & 3 Years on Hydraulics

Part #	Description	Setback
AHJ-4V-DP	Atlas Series™ Hydraulic Jack Plate	4"
AHJ-6V-DP	Atlas Series™ Hydraulic Jack Plate	6"
AHJ-8V-DP	Atlas Series™ Hydraulic Jack Plate	8"
AHJ-10V-DP	Atlas Series™ Hydraulic Jack Plate	10"
AHJ-12V-DP	Atlas Series™ Hydraulic Jack Plate	12"

PERFORMANCE

Atlas™ Series Digital Position Gauge Kit



- All Digital Readout
- Each Number Indicates 1/4" Rise
- Numbers from 0 to 20
- All Atlas™ Jacks are Pre-drilled to Fit
- Black Face and Stainless Steel Face Gauges Available



FAGK-1-DP	Atlas™ Gauge Kit	Black Face	Fits 4" & 8" Models
FAGK-2-DP	Atlas™ Gauge Kit	Black Face	Fits 6"-10" & 12" Models
FAGK-1SS-DP	Atlas™ Gauge Kit	Stainless Steel Face	Fits 4" & 8" Models
FAGK-2SS-DP	Atlas™ Gauge Kit	Stainless Steel Face	Fits 6"-10" & 12" Models

Atlas™ Series Hot Shot™ Hole Shot Plates

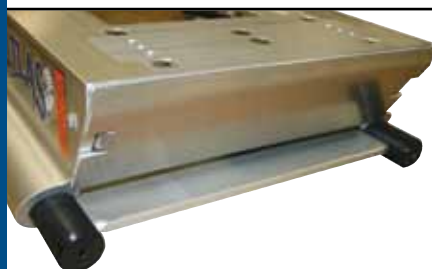

- Models to Fit All Atlas™ Jacks
- Provides Improved Hole Shot
- Reduces Water Drag at Take Off
- Reduces Porpoising

Part #	Fits This Model
AHJHSP-4V-DP	AHJ-4V-DP
AHJHSP-6V-DP	AHJ-6V-DP
AHJHSP-8V-DP	AHJ-8V-DP
AHJHSP-10V-DP	AHJ-10V-DP
AHJHSP-12V-DP	AHJ-12V-DP

Atlas Micro Jacker™

- Perfect for Shallow Water Skiffs and Flat Boats
- Lightest on Market – 23 lbs
- Smallest Footprint Available – 14-5/8”W x 11-1/2”H
- Strong, Fast Actuator – 8 Seconds Top to Bottom
- 90 Hp Outboards Max
- Optional Clamp-on Motor Adapter

Part #	Description
AHJM-4-DP	Atlas Micro Jacker™ Small Outboard Hydraulic Jack
AHJM-CMA-DP	Micro Jacker Clamp-on Motor Adapter



Atlas™ Tilt ‘N’ Trim Units



THT-135C

- Affordable Power Tilt ‘N’ Trim
- Electric Hydraulic Action
- Easy Tilting – No Back Strain

THT-130C Features

- Rated for 130hp or Less
- 90 Degrees of Tilt & Trim
- Standard BIA Bolt Hole Pattern
- Adaptor Kit for Clamp-On Motors
- 6” Setback

THT-35C Features

- Rated for 35hp or Less
- Designed for Clamp-On or Bolt-On Motors
- 84 Degrees of Tilt & Trim
- Engine Mounting Surface is 11” Wide
- 5-1/2” Setback



THT-130C

Part #	Description	Weight (lbs)
THT-35C-DP	Tilt ‘N’ Trim Unit for 35hp or Less	24
THT-130C-DP	Tilt ‘N’ Trim Unit for 130hp or Less	39
THT-130CGK-DP	Tilt ‘N’ Trim Unit for 130hp or Less. W-Position Gauge Kit	40
I3022	Clamp-On Motor Adapter for THT-130C Tilts	

Hydro-Jacker HS™ High Speed Hydraulic Jacking Plates

- High Speed – Top to Bottom in 7 Seconds
- High Tensile Aluminum Alloy – 7/8” Thick in Critical Areas
- 5” Vertical Lift – 7-1/2” Total Height
- Salt Water Tested and Proven
- All V6 Engines – 300hp Max

Part #	Description	Weight (lbs)
HYJ-6HSC-DP	High Speed Hydraulic Jacking Plate	6” Set Back
HYJ-10HSC-DP	High Speed Hydraulic Jacking Plate	10” Set Back





Hydro-Jacker™ Hydraulic Jacking Plates

- Full Self Contained Hydraulic Pump
- Angled to Allow for Full Engine Tilt
- Plates Available in 6" and 10" Setback
- Full 5" Vertical Rise
- All V6 Engines – 300hp Max

Part #	Description
HYJ-6C-DP	Hydro-Jacker™ – 6" Setback
HYJ-10C-DP	Hydro-Jacker™ – 10" Setback



Gauge Kit for Hydro-Jacker™ Jacks

- Safe and Convenient Position Indicator
- Dash Mount Gauge and Toggle Switch
- Weather Proof Gauge
- Fits All Hydro-Jacker™ Models 2010 and later

Part #	Description
6077	Gauge Kit for Hydro-Jacker™ Jacks



Z-Lock™ Manual Jack Plates

- Exclusive Z-Lock Design Provides Maximum Strength
- Prevents Side Slippage and Movement
- Easily Adjusts Up or Down with Center Bolt
- Full 1/2" Aluminum Material for Strength
- Handles All V6 Outboards – 300hp Max

Part #	Description	Setback
JPZ-6-DP	Z-Lock™ Jack Plate	6"
JPZ-8-DP	Z-Lock™ Jack Plate	8"
JPZ-10-DP	Z-Lock™ Jack Plate	10"



Z-Lock™ Hot Shot™ Hole Shot Plates

- Improved Hole Shot
- Reduces Drag on Take Off
- Helps With Porpoising

Part #	Description	Fits
JPZHSP-6	Hot Shot™ Hole Shot Plate	JPZ-6-DP
JPZHSP-8	Hot Shot™ Hole Shot Plate	JPZ-8-DP
JPZHSP-10	Hot Shot™ Hole Shot Plate	JPZ-10-DP

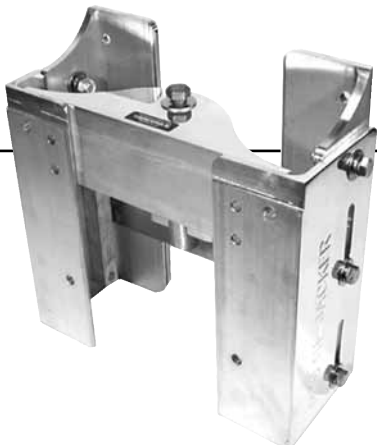

Pro Hi-Jacker™ Jack Plates

- High Strength Aluminum – 3/8" Thick
- One-Piece Design – Top Adjust
- Locking Bars Allow One Wrench Adjust
- Maximum 150 HP Outboards
- 4" Vertical Adjustment

JP-6PW-DP	Pro Hi-Jacker™ Jack Plates	6" setback, aluminum
JP-ADJ-BOLT	Center Adjustment Bolt & Collar – All Models	

Hi-Jacker™ Jack Plate

- 3/8" Aluminum – Two Piece Design
- Natural Aluminum Finish
- Dual Stainless Steel Adjustment Rods
- Maximum 150 HP Outboards
- 6" Setback – 4" Vertical Lift

Part #	Description
JP-1A-DP	Hi-Jacker™ Jack Plate – Aluminum



Hi-Jacker™ Fixed Jack Plate

- Inexpensive Short Transom Fix
- Solid 3/8" Aluminum Extrusion
- 3-Engine Mount Holes – 2-Transom Holes
- Total Vertical of 5-1/2 Inches – 4" Setback
- Max HP – 150

Part #	Description
JP-4FA-DP	Hi-Jacker™ Fixed Jack Plate

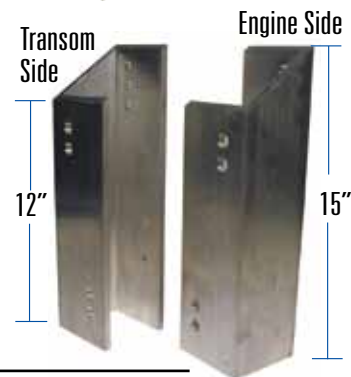

Mini-Jacker™

- "Clamp Style" Small Outboard Jack Plate
- Cast Aluminum Bracket
- Marine Grade Transom Block
- 4" Setback – 3" Vertical
- Max Wt – 150lbs – Max HP-35

Part #	Description
MJ-1-DP	Mini-Jacker™ – For Outboards Only

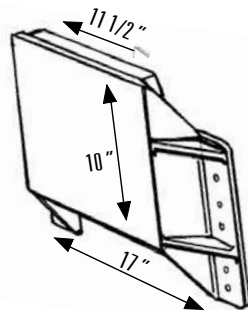

Bolt Kit for Jack Plates

- For Mounting Outboard to Plate
- Kit Contains: 4 each 1/2" – 13 x 3" long bolts – stainless steel
- 4 each 1/2" – 13 lock nuts – brass with nylon insert
- 8 each 1/2" – flat washers – stainless steel

Part #	Description
BK-1-DP	Jack Plate Bolt Kit - Brass nuts w/ nylon insert



Outboard Motor Brackets

- Lifts Auxiliary Outboards with Ease
- Aluminum Bracket – Stainless Steel Spring
- Great for Kicker Motors
- Sturdy Molded Mounting Block

Part #	Description	Max HP	Max Wt (lbs)
KMB-8-DP	Outboard Motor Bracket	8	59
KMB-12-DP	Outboard Motor Bracket	12	82
KMB-20-DP	Outboard Motor Bracket	20	115





Emergency Reboarding Ladder

- Easily Rotates and Drops Down Into Ladder Position
- Meets NMMA Regs for Reboarding Ladders
- Strong All-Aluminum Design
- Snaps Up Securely into Slot When Not in Use
- Non-Slip Material on Both Steps



Part #	Description
EBL-1	Reboarding Ladder – Fits All Atlas™ Jack Plates
EBL-1-DP	Reboarding Ladder – Fits All Outboards – Port Side
EBL-2-DP	Reboarding Ladder – Fits All Outboards – Starboard Side



FingerFlex™

The Ultimate in Trim Control for Hydraulic Helms

- No Wheel Removal Required
- Wrap Around Bracket Installs in Minutes
- Positive Clicking Technology for Positive Touch
- Also Operates Power Jack Plates



Part #	Description
FFTB-1-DP	FingerFlex™ Bezel Mount, Single
FFTB-2-DP	FingerFlex™ Bezel Mount, Dual



Steering Wheel Trim Control

- Rugged Urethane Coiled Cord
- Weatherproof Rubber Booted Switches
- Mounts Easily to Steering Wheel Spokes

Part #	Description
ST-1	Steering Wheel Trim Control – 50 AMP



Transom Trim Control

- Puts Tilt & Trim Control Anywhere
- Weatherproof Control Switches
- Can Also Operate Power Jack Plates

Part #	Description
TTC-1	Transom Trim Control – 50 AMP



Hot Trim™ Floor Mounted Trim Control

- Foot Operated Tilt & Trim Control
- Weatherproof Control Switches
- Prewired Matte Black Unit

Part #	Description
HT-1	Hot Trim™ Floor Mounted Trim Control – 50 AMP

Trim Handle

- Puts Tilt & Trim Control Directly Onto Throttle Lever
- Weatherproof 50 Amp Switches
- Fits Pre 1979 OMC Control Handles

Part #	Description
EJT-I-DP	Trim Handle – 50 AMP

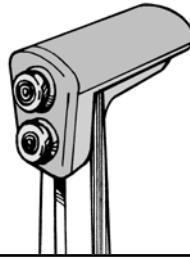

Hot Foot™ Pro Top Load Foot Throttle

- Improved Safety & Throttle Control
- Attractive Full Color Pedal Graphics
- Topside Cable Connections
- Patented Idle Stop for FICHT & Optimax
- Stainless Steel Hardware with Teflon Bushings
- Requires Longer Throttle Cable (Not Included)



HF-IT-DP	Fits Johnson, Evinrude, Mercury & Mariner
HF-ICT-DP	Fits Honda, Yamaha, Chrysler & Suzuki
HFS-I-DP	Replacement Spring (all models)



Cable not included.

Hot Foot™ Foot Throttle

- Number One Throttle on Market for Over 20 Years
- Provides Added Safety & Performance
- All Cast Aluminum – Stainless Steel Hardware
- Nylon & Teflon Bushings on all Critical Pivot Points
- Patented Idle Stop for FICHT & Optimax Engines
- Requires Longer Throttle Cable (Not Included)



HF-IT-DP	Universal Model – Fits All Marine Engines
HFS-I-DP	Replacement Spring (all models)



Cable not included.

Hot Foot™ Slide Mount

- Easy Adjustment of Hot Foot™
- Stainless Steel Fasteners & Release Pin
- Allows 5" of Slide Adjustment

Part #	Description
HFM-I	Hot Foot™ Slide Mount



Transom Wedges

- Fits All Standard 4-Bolt Patterns
- Full Contact Between Engine & Transom
- 2-1/4" W – 11-1/4" L – 1-1/16" to 3/16" Thickness

TW-2	Transom Wedges – 1 Pair – 5 Degrees Positive Tuck
TW-3	Reverse Transom Wedge – 1 Pair – 5 Degrees Positive Tilt





Transom Spacers

- Adds 2" of Setback to Any Jack Plate
- Fits Any Standard 4-Bolt Pattern
- Includes Four 4-1/2" Stainless Bolts & Brass Nuts

Part #	Description
TS-I-DP	Transom Spacers



Nose Cone

- Reduces Drag
- Cast Aluminum
- Weld on or Epoxy

Part #	Description
NC-I-DP	Nose Cone

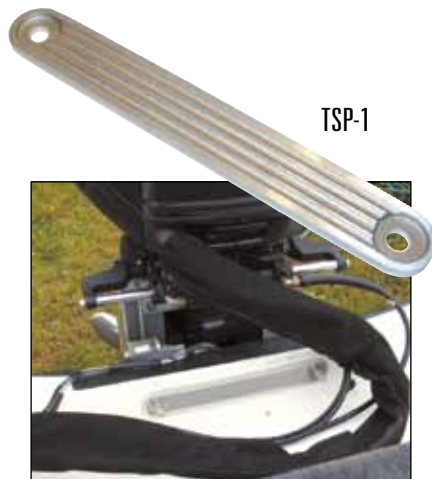
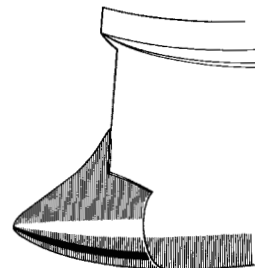

TSP-1

Transom Support Plates

- Distributes Stress of Engine Bolts
- High Quality Cast Aluminum
- Call for Customizing Program
- All Plates – 3/8" Thick

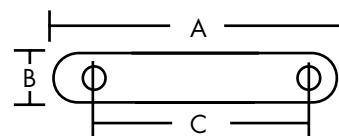

Part #	Description	A	B	C
TSP-1	Top Bolt Holes – Standard	15"	2"	13"
TSP-2	Lower Bolt Holes – Standard	12"	2"	10"
TSP-1C	Top Bolt Holes – Std & Custom	15"	2"	13"
TSP-1CP	Top Bolt Holes – Std – Custom & Painted	15"	2"	13"
TSP-3	Top Holes – XWide	15"	2-1/2"	13"
TSP-7	For Yamaha 350 - four bolt holes	15-1/4"	3-3/4"	12-3/8"



TSP-7

Plate can be customized with Logo and/or background painting. Call for details.



Replacement Skegs

- Solid Cast Aluminum
- Welds to Lower Units
- Easily Cut to Shape

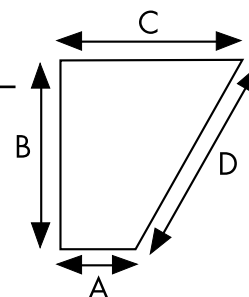

Part #	A	B	C	D
RS-1-DP	5-1/2"	6"	10-1/4"	9"
RS-2-DP	4-1/2"	5-3/4"	9-1/2"	10"
RS-3-DP	4"	4-1/4"	7-1/2"	7"
RS-4-DP	3-1/2"	6-1/2"	9-1/4"	10-1/2"

Torque Tab

- Counters Torque Pressure on Wheel
- Inexpensive & Easy to Install
- Cast Aluminum – Stainless Hardware

Part #	Description
TAB-I-DP	Torque Tab

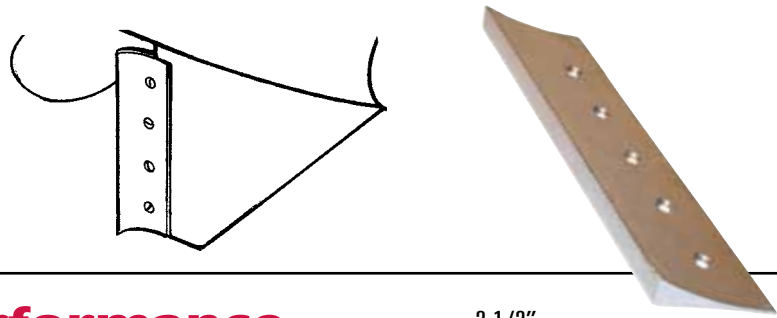

Hydro-Tail™ Performance Stabilizer

- Planes Quicker – Reduces Cavitations
- One Piece Unit for Strength
- Fits All Outboards & Stern Drives

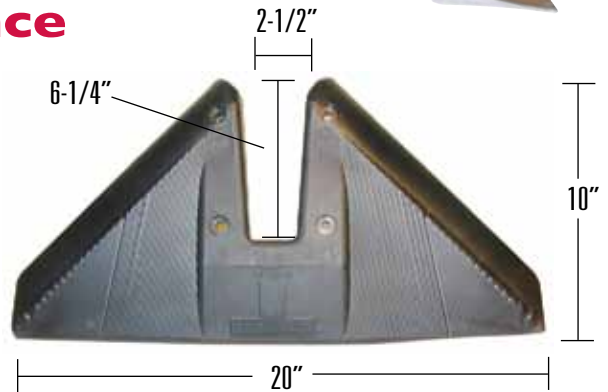
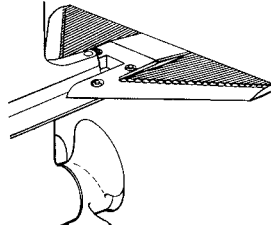

Part #	Description
HYD-I-DP	Hydro-Tail™ Performance Stabilizer

Saf-T-Stop™ Ignition Kill Switches

- Meets All Requirements of Emergency Stop Switches
- Coiled Lanyard
- Isolated Circuits on Dual Units to Prevent Feedback
- Mounts Anywhere – Requires 1-1/2" Hole

KS-1	Saf-T-Stop™ Ignition Kill Switch	Single Outboard
KS-2	Saf-T-Stop™ Ignition Kill Switch	Single I/O
KS-12	Saf-T-Stop™ Ignition Kill Switch	Dual Outboard
KS-22	Saf-T-Stop™ Ignition Kill Switch	Dual I/O
L-4	Saf-T-Stop™ Ignition Kill Switch	Replacement Lanyard



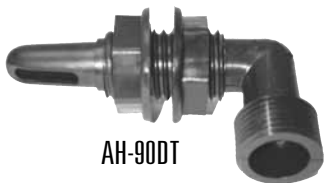

AH-90DT



TH-90DT

MAV-2KDT

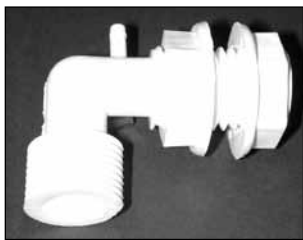

Quik Plumb™ — Marine Plumbing System

- Quick Connect Threaded Fittings & Valves
- Hand Tighten – No Tools Needed
- Leak Proof Sealing Gaskets
- Allows “Bench Building” of Plumbing Systems
- Time & Labor Savings
- All Parts Fit 3/4” Marine Hose

Part #	Description
DTA-750	Female Adaptor – Straight
DTA-7590	Female Adaptor – 90 Degree
AH-90DT	Aerator Spray Head – 90° - Side Mount
RDV-2DT	Remote Drain Valve
DVO-1DT	3-Way Diverter Valve
TH-750DT	3/4” Thru Hull – Straight – Black
TH-752DT	3/4” Thru Hull – Straight – White
TH-90DT	3/4” Thru Hull – 90° - Double Nut
MAV-2KDT	Max-Air™ Venturi Fitting
APD-190FDT	Flat Head Drain – 1-1/8” Throat – 3/4” Barb



DTA-750

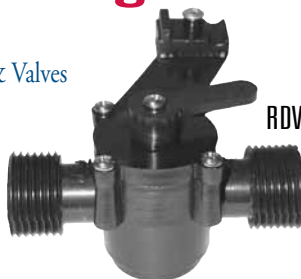

RDV-2DT



TH-750DT



APD-190FDT



PAS-1

Pro-Air System – Livewell Aeration

- Provides Long Lasting Oxygen Rich Air
- Easy Mount for Fixed or Portable Tanks
- Dual Outlets Can Aerate Two Livewells at Once
- 12 Volt DC Pump is Potted & Waterproof
- Fine Mesh Screen or Air Stones
- Pump Capacity – Approx. 30 Gals.
- Draws Only 1/4 AMP

Part #	Description
PAS-1	Complete Kit – w/Air Stones
PAS-2	PAS-1 – No Switch
PAP-1	Pump Only
T-1	System Tubing – 500’ Roll – 1/8”

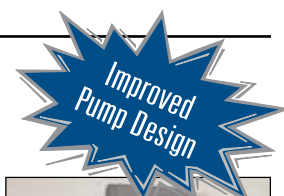
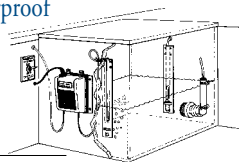

PAS-3



MAV-2K

MAX-AIR™ Livewell Venturi

- Most Efficient Aeration System Available
- Injects Air Low Into Livewell
- Fits 3/4” Hose

Part #	Description
MAV-2	MAX-AIR™ Venturi Fitting Only
MAV-2K	MAX-AIR™ Venturi Kit With Face Plate
MAV-2KT	MAX-AIR™ Venturi With Face Plate and 6’ Tubing
MAV-FACEPLATE	Replacement Faceplate

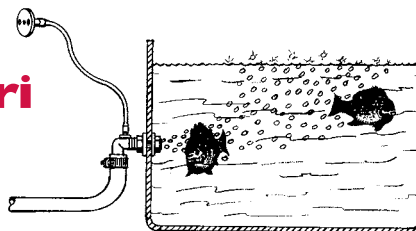

EZ-Pumps™

- UV Stable and Rust Resistant
- 3 Sizes Fits Most Installations
- Easy Installation - No Drilling or Running Hoses
- Screen and Pick-up All in One
- Gives the Tournament Angler an Edge Over the Competition
- Upgrade Your Present System Inexpensively
- Keep Fish and Bait Alive Longer
- Active Bait Gets You More Strikes
- Prevents Livewell System Air Lock
- Hassle Free Livewell Operation
- Extends Battery Life
- Fish in Stealth Mode



Part #	Description	Length (A)	Intake (B)	Size	Color
EZ-BLK-1	EZ Pump	4-3/4"	1" to 3-1/2"	Long	Black
EZ-WHT-1	EZ Pump	4-3/4"	1" to 3-1/2"	Long	White
EZ-SND-1	EZ Pump	4-3/4"	1" to 3-1/2"	Long	Sand
EZ-BLK-2	EZ Pump	3-3/8"	1" to 2-1/2"	Medium	Black
EZ-WHT-2	EZ Pump	3-3/8"	1" to 2-1/2"	Medium	White
EZ-SND-2	EZ Pump	3-3/8"	1" to 2-1/2"	Medium	Sand
EZ-BLK-3	EZ Pump	2-1/4"	1" to 1-3/16"	Short	Black
EZ-WHT-3	EZ Pump	2-1/4"	1" to 1-3/16"	Short	White
EZ-SND-3	EZ Pump	2-1/4"	1" to 1-3/16"	Short	Sand

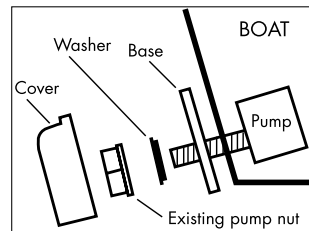
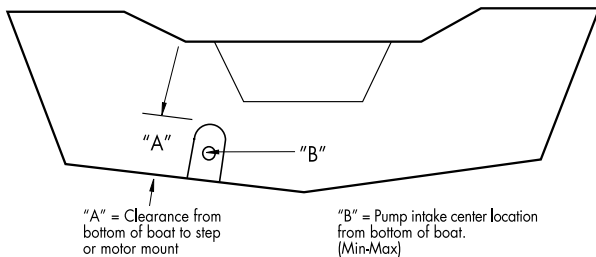

Water Scoop

- Provides Fresh Water to Livewells While Underway
- Pressure Relief Holes Prevent Overpowering Pumps
- Can Be Used With Standard Aerator Pump

Part #	Description
WS-1	Water Scoop

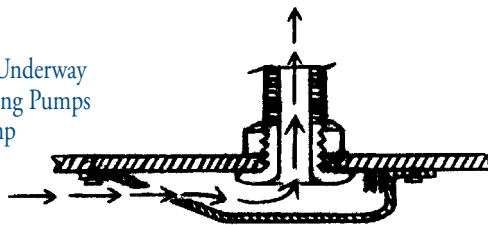

Automatic Aerator Control

- Turns Pumps On & Off Automatically
- Solid State Aerator Timer – Fully Adjustable
- 10 Amp Fully Waterproof Circuitry
- Handles High Capacity Pump Current Draw
- Requires 3" Round or 2-1/2" Square Hole
- Auto Spray (On) Time – 45 seconds
- Auto Delay (Off) Time – 45 seconds (min)– 5-1/2 min (max)

Part #	Description
AAC-I-DP	Automatic Aerator Control



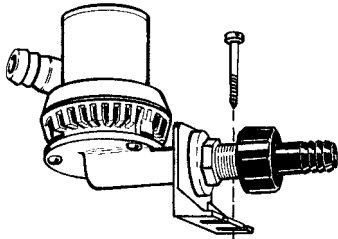

Aerator Pump Bracket

- Molded Aerator Pump Support
- 1-1/8" Pump Mounting Hole

Part #	Description
PB-90	Right Angle Bracket



Bait Tank Plumbing Kit

- Complete Kit for Plumbing Fixed or Portable Tanks
- Detailed Installation Instructions Included
- Kit Contains:
 - ODT-190 90° Overflow Drain Tube
 - TH-1202 1-1/8" Thru-Hull Drain Fitting
 - AHV-2 Aerator Spray Head w/Shut-off Valve
 - DAH-90 Directional Aerator Head for Current
 - TEE-3/4 Tee Fitting to Connect Both Heads to Pump

Part #	Description
BWK-2	Complete Baitwell Kit



*See page 57 for Hoses and Wash Down Stations



Wash Down Fittings

- Injection Molded – Rust Proof
- Standard Garden Hose Threads
- Protective Cap w/ Retainer
- Flange is 2-1/4" dia. – Fits 1-1/4" Hole
- Fits 3/4" Hose

WDV-1	Wash Down Fitting	Straight with Shut-off Valve	Black
WDV-1CP	Wash Down Fitting	Straight with Shut-off Valve	Chrome
WDV-90	Wash Down Fitting	90 Degree with Shut-off Valve	Black
WD-1	Wash Down Fitting	Straight without Shut-off Valve	Black
WD-1CP	Wash Down Fitting	Straight without Shut-off Valve	Chrome
AHVWD-90	Washdown Fitting/Aerator Spray Head*		Black
AHVWD-92	Washdown Fitting/Aerator Spray Head*		White

*See below for details.



Aerator Spray Head/Wash Down Combos

- Single Fitting Handles Both Jobs
- Positive Action Shut-Off Valve
- Multi-Directional Spray Head

Part #	Description
AHVWD-90	Aerator Spray Head/Wash Down Fitting - Black
AHVWD-92	Aerator Spray Head/Wash Down Fitting - White



Brite Plate™ Chrome Plated Fittings

- Look of Stainless – Price of Plastic
- Strong Plating Process Strengthens Parts
- Five Step Metal Bonding Process
- Won't Flake, Chip or Easily Scratch
- For Above Waterline Use



Straight	90 Degree	Extended Length	Description	Hose Size
TH-750CP	TH-7590CP	TH-750XLCP	Thru-Hull	3/4"
TH-1200CP	TH-1290CP	TH-1200XLCP	Thru-Hull	1-1/8"
TH-1890CP		Thru-Hull Short	1-1/8"	
TH-1500CP	TH-1590CP	TH-1500XLCP	Thru-Hull	1-1/2"
RFTH-2BCP	Recessed Flapper Scupper Thru Hull			
RF-1CP	Rigging Flange			

See page 28 for dimensions. Note: Recommend use of silicone sealant or neoprene gaskets only — see page 29



Directional Livewell Fill Fitting

- Protects Delicate Bait
- Provides Directional Current
- 90 Degree Design
- Allows Full Flow from Pump



Part #	Description
TH-DFR-7590	Livewell Directional Fill Fitting – 3/4" Barb – Black
TH-DFR-7592	Livewell Directional Fill Fitting – 3/4" Barb – White
TH-DFR-1290	Livewell Directional Fill Fitting – 1-1/8" Barb – Black
TH-DFR-1292	Livewell Directional Fill Fitting – 1-1/8" Barb – White

Directional Flow Aerator Heads

- Creates Circular Current
- Keeps Baitfish Alive
- Max Wall Thickness – 5/8"
- Fits 3/4" Hose



DAH-45



DAHI-118

Part #	Description	Hose Dia.
DAH-90	Directional Flow Head, 90 Degrees	3/4"
DAH-45	Directional Flow Head, 45 Degrees	3/4"
DAHI-118	Adjustable Flow Head	—
APD-190FT	Fitting for DAHI-118	3/4"
TH-1890T	Fitting for DAHI-118	1-1/8"



APD-190FT

Aerator Spray Heads



AH-90



AHV-1



AH-1



AHV-90/AHV-1890



AHV-2



AHV-92

Part #	Description	Shut-off	A	B	C
AH-1	Fixed Flange – Black	No	3/4	1-1/16	3/8
AH-90	Double Nut – Black	No	3/4	1-1/16	5/8
AH-92	Fixed Flange – White	No	3/4	1-1/16	5/8
AHV-1	Fixed Flange – Black	Yes	3/4	1-1/16	3/8
AHV-90	Screw On Valve – Black	Yes	3/4	1-1/16	3/4
AHV-2	Fixed Flange – White	Yes	3/4	1-1/16	3/4
AHV-92	Fixed Flange – White	Yes	3/4	1-1/16	5/8
AHV-1200	Screw On Valve – Straight	Yes	1-1/8	1-1/4	1-5/8
AHV-1890	Screw-On Valve – 90°	Yes	1-1/8	1-1/4	3/4

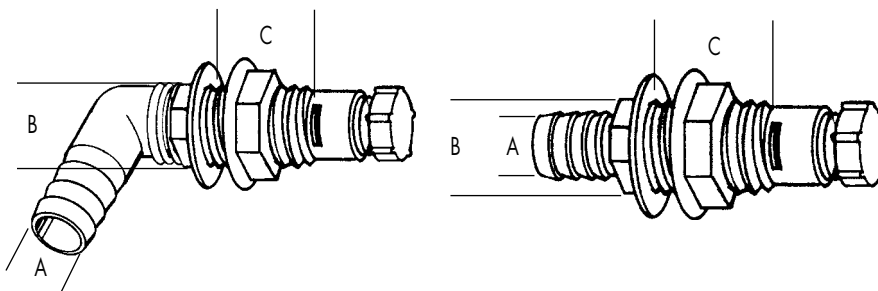

Foaming Hole Plugs



- Knock In Design – Easy to Install
- Ridged Flange Locks Tightly
- 2-1/4" OD – 1-3/4" Hole

Part #	Description
FHP-2RG	Foaming Hole Plug – Off White



Cockpit Drains

- Tapered or Flat Head Designs
- Complete Drainage for Cockpit Areas
- Flush Fit Drop-in Screens
- 90° & White Only

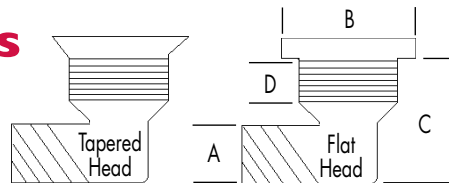

Part #	A	B	C	D	Head	Style
TH-1992	1-1/2"	2-3/8"	3"	1"	Tapered	Open Drain
TH-1992S	1-1/2"	2-3/8"	3"	1"	Tapered	Removable Screen
TH-1992BHS	1-1/2"	2-3/8"	3"	1"	Flat	Big Head w/Screen
TH-1992R	1-1/2"	2-3/8"	3"	1"	Tapered	Debris Bar Insert
TH-1992FH	1-1/2"	2-3/8"	3"	1"	Flat	Open Drain
TH-1992FHS	1-1/2"	2-3/8"	3"	1"	Flat	Removable Screen
TH-1992FHR	1-1/2"	2-3/8"	3"	1"	Flat	Debris Bar Insert
TH-2092	2"	2-1/2"	4"	1"	Tapered	Open Drain
TH-2092S	2"	2-1/2"	4"	1"	Tapered	Removable Screen
TH-2092R	2"	2-1/2"	4"	1"	Tapered	Debris Bar Insert

Deck Drain Thru-Hulls With Grille

- Prevents Objects From Passing Thru Drain
- Excellent Shower Drain
- Fits 1-1/2" Hose

TH-1502G	Straight, White
TH-1592G	90°, White
FG-150	Grill for 1-1/2" Thru Hull



Flow-Max™ Ball Scuppers

- Replaces Worn Out Flapper Scuppers
- 70% More Drainage Than Competitive Models
- New Twist-Off Feature for Clearing Debris
- Retrofits All Hole Patterns
- Stainless Steel Lock Screw for Safety
- Seal Slotted to Fit Over 1-1/4" Motorwell Tube

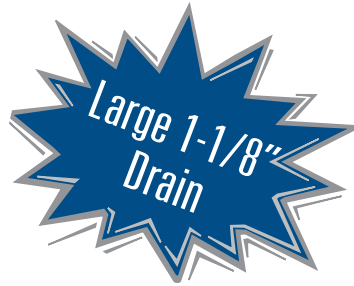

Part #	Description
FMS-1-0	Flow-Max™ Ball Scupper - Clear 3" dia. x 2-1/2" h

Cockpit Scupper Drains

- Check Ball Inside Prevents Water Backup
- Molded From High Strength Material – UV Stabilized
- Top Screen Removable for Cleaning
- Leaf Guard Top Screen Optional (Add PLG to Part #)

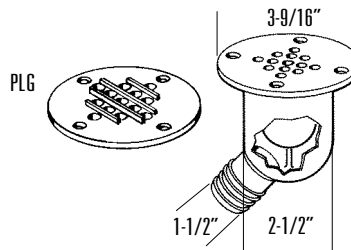

Part #	Description	Color	Hose Dia.
CSD-92	90° Outlet	White	1-1/2"
CSD-90	90° Outlet	Oyster	1-1/2"

Inline Scupper

- Three Sizes Available
- Prevents Backwash
- Chemical Resistant Materials
- Thermo-Plastic Flapper

Part #	Hose Size	Description
ILS-750	3/4"	Double Barb Inline Scupper – Black
ILS-1200	1-1/8"	Double Barb Inline Scupper – Black
ILS-1500	1-1/2"	Double Barb Inline Scupper – Black



Large Rectangular Scuppers

- Quickly Drains Decks
- For Decks Above Waterline
- Maximum Drainage for Larger Boats
- Easily Clears Debris
- Fits 2" x 5-1/2" Hole



LRS-2	Rectangular Scupper – White
LRS-3	Rectangular Scupper – Sand



Duckbill Scuppers

- Tough Thermoplastic Flapper
- Seals Tight Under Water Pressure
- Easy to Install Over Drain Tubes
- 1-13/16" ID and 2-3/4" OD

DBS-2	Duckbill Scupper – Wht/Wht
DBS-2B	Duckbill Scupper – Blk/Wht



Flush Mount Scupper Adapters

- Mounts Over 1" to 1-1/4" Drain Tubes
- Grooved Inside to Fit Over Drain Flange

SA-1	Flush Mount Scupper Adapters Black/Black Flapper
SA-2	Flush Mount Scupper Adapters White/White Flapper
SA-2B	Flush Mount Scupper Adapters White/Black Flapper
SA-3	Flush Mount Scupper Adapters Sand/Sand Flapper



Flapper Scupper Repair Kit

- Repairs Most Scuppers
- Kit Contains: 2 each 1-5/8" – 1-7/8" & 2-1/4" Flappers
- Keepers and Stainless Fasteners



Part #	Description	Color
FSRK-1-DP	Flapper Scupper Repair Kit	Black
FSRK-2-DP	Flapper Scupper Repair Kit	White

- Low Profile Heads for Complete Drainage
- Thermo-Plastic Flapper Won't Curl
- Flapper Impervious to Sun or Chemicals



Recessed Flapper Scupper Drains

Push-Together Scuppers

- Mating Rib Design Snaps Together
- Outside Flange Diameter – 2-15/16"
- Installs in 1-7/8" Hole

Part #	Item	Hull Thickness	Color
RFS-1	Push-Together Scupper	1-1/2 to 3-5/8"	Black
RFS-2	Push-Together Scupper	1-1/2 to 3-5/8"	White
RFS-1L	Push-Together Scupper	2-1/2 to 4-3/4"	Black
RFS-2L	Push-Together Scupper	2-1/2 to 4-3/4"	White

Recessed Threaded Thru-Hull Scuppers

- Fits Hulls Up To 3-1/2" Thick (XS Models Fit 1-3/8" Hulls)
- Barbed to Fit 1-1/2" or 2" Hose

RFTH-1	Fits 1-1/2" Hose; Black/Black Flapper
RFTH-2	Fits 1-1/2" Hose; White/White Flapper
RFTH-2B	Fits 1-1/2" Hose; White/Black Flapper
RFTH-2BCP	Fits 1-1/2" Hose; Chrome/Black Flapper
RFTH-2002B	Fits 2" Hose; White/Black Flapper
RFTH-1XS	Fits 1-1/2" Hose; Black Short Thread
RFTH-2XS	Fits 1-1/2" Hose; White Short Thread
RFSPA-1502	Spacer – Fits 1-1/2" RFTH Series Scuppers
RFSPA-2000	Spacer – Fits 2" RFTH Series Scuppers

Recessed Flapper Scupper Drains continued on next page...

Recessed Flapper Scupper Drains

Flex Flange Thru-Hull Drain

- Unique Flexible Flange
- Allows Near Total Drainage
- 1-1/2" Hose Barb
- Easily Connects to Scuppers

Part #	Description
TH-1502FF	Flex Flange Drain – 1-1/2"



Splash Well Drains

- Molded High Strength Material
- Flexible to Prevent Breakage
- Push Together for Secure Fit
- Brite Plate Chrome Models



Black #	White #	Chrome #	CMax Thickness	Hole
SWD-1	SWD-1W		1-7/8" to 3-1/8"	1"
SWD-2	SWD-2W		7/8" to 2-1/4"	1"
SWD-3	SWD-3W	SWD-3WCP	2-3/4" to 4-1/2"	1-1/4"
SWD-4	SWD-4W	SWD-4WCP	1/2" to 3"	1-1/4"
SWD-5			2-3/4" to 12"	1-1/4"



All Purpose Drains/ Hatch Drains

- Low Profile Flat or Concave Head for Complete Drainage
- Requires 1-3/8" Hole

Black #	White #	Description	"A"	"B"	"C"	"D"
APD-1	APD-2	Straight - Concave	1-3/4"	3/4"	3/4"	2"
APD-190	APD-290	90 Degree - Concave	1-3/4"	1/2"	3/4"	2"
APD-190FT	—	90 Degree - Flat - Threaded	1-7/8"	7/8"	3/4"	2-1/4"
APD-190F	APD-290F	90 Degree - Flat	1-7/8"	7/8"	3/4"	2-1/4"
APD-118	—	Straight - Concave	1-3/4"	3/4"	1-1/8"	2"
PP-118		Plug Fits All Purpose Drains				

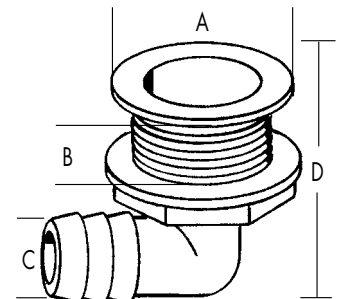

Impact & Push-In Drains

- Low Profile Head for Complete Drainage
- Easily Push Into Place

Part #	Description	Dia.	Length	Color
PD-1	Push-In Drain	3/8"	1-1/16"	Black
PD-2	Push-In Drain	3/8"	1-1/16"	White
IPD-580	Impact Drain	5/8"	1/2"	Black
IPD-582	Impact Drain	5/8"	1/2"	White
IPD-582-BARB	Impact Drain w/Barb	5/8"	1/2"	White
IPD-1000	Impact Drain	1"	3/4"	Black
IPD-1000-5	Impact Drain	1"	5-1/8"	Black
IPD-1002	Impact Drain	1"	3/4"	White



Push-In Drains

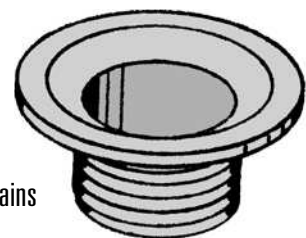

Impact Drains



Seat Pedestal Drains

- Marine Grade Vinyl – Slide On
- Requires 1/4" Tubing

SPD-1	Seat Pedestal Drain	Fits 1-1/4" Pedestal
SPD-2.25	Seat Pedestal Drain	Fits 2-1/4" Pedestal
SPD-2.75	Seat Pedestal Drain	Fits 2-3/4" Pedestal

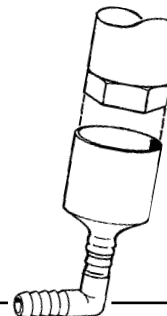

Floor Drain – Lid Pulls

- Combination Drain with Lid Pull
- Perfect for Ski Lockers & Hatches
- 5-5/8" Dia. – Fits 4" Hole

FDP-4T	Floor Drain/Pull, Tan
FDP-4WS	Floor Drain/Pull, Off-white, Sand



Blower Vent Grill Cover



- Fits Standard Vent Hose Sizes
- Maximum Air Flow
- Molded of UV Stabilized Poly

Part #	Description	Size	Color
RVG-3-1	Blower Vent Cover	3"	Black
RVG-3-2	Blower Vent Cover	3"	White
RVG-3-3	Blower Vent Cover	3"	Sand Shell
RVG-4-1	Blower Vent Cover	4"	Black
RVG-4-2	Blower Vent Cover	4"	White
RVG-4-3	Blower Vent Cover	4"	Sand Shell



Oval Vents

- Poly Material Resists UV
- Great for Engine Compartments and Blowers
- Maximum Air Flow Design



Black	White	Description	Outside Dim	Cut Out Dim
CVGS-1	CVGS-1FW	Oval Vent	4"x6-1/2"	2-7/8"x5-3/8"
CVGL-1	CVGL-1FW	Oval Vent	4-1/2"x11-3/8"	3-3/8"x10-1/4"



Floor Drains

- Drain with Flange for Secure Fit

OD Dia.	Cut Out	Black	White	Fish White
4-1/4"	2-1/2"	FD-2	FD-2W	FD-2FW
5-5/8"	4"	FD-4	FD-4W	FD-4FW

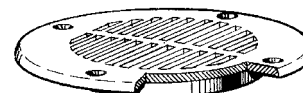

Louvered Vent Covers

- Deflects Rain & Eliminates "See-Thru"
- 5-5/8" OD – Flange Fits Into 4" Hole

OD Dia.	Cut Out	Black	Fish White	Sand
5-5/8"	4"	LV-1	LV-1FW	LV-1S

Overflow Drains With Filter

- Filter Prevents Baitfish or Debris from Passing Thru
- Thru-Hull Style Overflow – Fits 1-1/2" Hose

TH-1502F	Overflow Drain	Straight, White
TH-1592F	Overflow Drain	90 Degree, White
FF-150	Overflow Drain	Filter Only



Overflow Drain Tubes

Push In Tubes

- Fits Securely Into Drains
- Flexible Marine Vinyl Seals

ODT-1	Fits 1-1/8" Drain – Straight – 12"L
ODT-190	Fits 1-1/8" Drain – 90° – 12"L
ODTS-1	Filter Screen for ODT-1 & 190
ODT-2	Fits 1-1/2" Drain – Straight – 18"L with screen
ODT-290	Fits 1-1/2" Drain – 90° – 18"L with screen
ODTS-2	Filter Screen for ODT-2 & 290

NOTE: Any tube above can be cut to custom lengths. Specify length by adding to part number (inches) (ie: "ODT-1-8" = eight inches)



Screw In Tubes

- Threaded Seal – Cannot Be Knocked Out
- Unscrew Half Way to Expose Drain Holes

ODT-1-12TW	Fits 1-1/8" Threaded Drain – Straight – 12"L
ODT-1-12GSTW	Fits 1-1/8" Threaded Drain – With Top Screen Glued – 12"L
ODT-2T	Fits 1-1/2" Threaded Drain – w/Screen - Straight – 18"L

Threaded Drains

- Threaded to Fit Screw-In Tubes Above

TH-1200T	Thru-Hull Drain – 1-1/8" Barb – Straight
TH-1200XLT	Thru-Hull Drain – 1-1/8" Barb – Xtra Long
TH-1290T	Thru-Hull Drain – 1-1/8" Barb – 90°
TH-1890T	Thru-Hull Drain – 1-1/8" Barb – Short 90°
TH-1502T	Thru-Hull Drain – 1-1/2" Barb – Straight White
TH-1592T	Thru-Hull Drain – 1-1/2" Barb – 90° White
APD-190FT	Low Profile Drain – 3/4" Barb – Flat Top – 90°

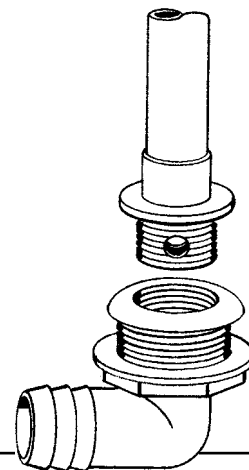

Push-In Plug for Drains

- Stops Water in Livewell or Baitwell Drains
- Marine Grade Molded Vinyl
- Double Rings for Positive Seal

PP-150	Push-In Plug for 1-1/2" Thru-Hull Drains
PP-118	Push-In Plug for 1-1/8" Thru-Hull and All Purpose Drains
PP-125	Push-In Plug for 1-1/4" Thru-Hull Drains

PP-150



PP-118





Drain Plugs

- Screw-In Plug – Stays With Boat
- Flange 1-1/2" x 2" – Fits 1" Hole
- Tough Nylon Material – "O" Ring Seal

DP-1	Drain Plug	Black
DP-2	Drain Plug	White
DPS-1	Drain Plug Stem Only	Black



Garboard Drain Plug & Base

- Chrome Brass
- Salt Water & UV Resistant
- 9/16" Plug
- Fits 1" Hole

GDP-1	Garboard Drain Plug Only
GDP-ICB	Garboard Drain Plug & Base



Livewell Overflow Tube/ Utility Storage Clips

- Two Sizes to Fit 7/8" or 1-1/2" Tubes
- Mounts Anywhere – Holds Securely
- Holds Nav Light Poles, Overflow Tubes, Etc.

Part #	Description	Fits
ULC-1	Utility Storage Clips	ODT-1 or any 7/8" Tube
UC-1	Utility Storage Clips	ODT-2 or any 1-1/2" Tube



Aerator Filter Domes

- Protects Pumps From Debris
- Twist-Off to Clean
- Mounts Behind Standard Thru-Hulls

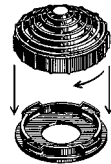

Part #	Description	Hole I.D.	Application
AFD-2	Aerator Filter Dome	1"	Fits 3/4" Thru-Hull or Pump
AFD-118	Aerator Filter Dome	1-5/8"	Fits Top of 1-1/2" Thru-Hull
AFD-118P	Aerator Filter Dome	1-3/8"	Fits 1-1/8" Thru-Hull



Aerator Filter

- Protects Pumps From Debris
- Screws On Over Pump Intake Fitting
- Fits Over 3/4" or 1-1/8" Fittings
- Available with Snap-On Mount

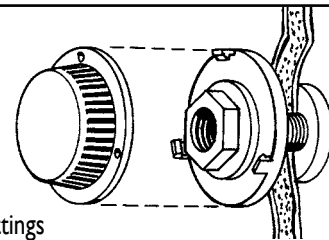

Part #	Description	Fits Fittings
AF-1	Aerator Filter	3/4" or 1-1/8"
AFM-1	Aerator Filter With Mount	3/4"



Bait Well Filter w/ Mount

- Fits Over Bait Well Drains
- Mounts Behind Drain Fitting
- Prevents Ingestion of Bait Fish

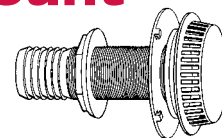

Part #	Description	Fits
BWF-1	Bait Well Filter	Fits 1-1/2" Thru-Hull

Thru-Hull Not Included

Stainless Steel Wire Mesh Strainers

- Protects Pumps From Debris or Bait Fish
- Formed Wire Mesh – Molded PVC Threaded Base

Part #	Fits	Threads
AS-1	Aerator Pump Intake	3/4" – 14
AS-2	TH-1, 1XL, 90, 92 Thru-Hulls	1" – 8

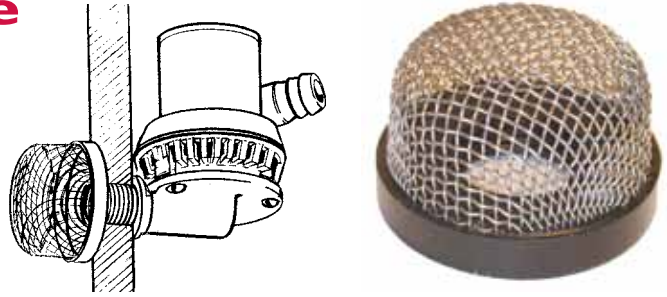

Miniature Stainless Aerator Screens

- Pushes Snug Into Thru-Hull Fittings
- Easily Removed for Cleaning
- For Recirc Systems or Drains

ASM-4	Fits TH-3S Only
ASM-5	Fits 1-1/8" Thru-Hull Fittings & All APD's
ASM-6	Fits TH-7590 & TH-7592



Thru-Hull Strainer Mounts

- Threaded to Fit AS-1 Stainless Screen
- Flange Allows Flush Fit – No Outside Nut
- Fits 3/4" Hose

Part #	A	B	Description
THSM-1	1-3/4"	4"	Fitting Mount
THSM-1XL	3"	4-1/2"	Long Fitting
THSM-1KIT	1-3/4"	4"	Mount & Screen
AS-1	—	—	Screen Only

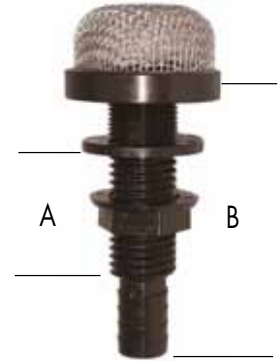

CeaCap™ Bulkhead Pass-Thru Fitting

- Watertight Seal for Cables, Tubing or Wires
- Self-Attaching – No Hardware Needed
- Turn Down Washer Included
- Fits 3/4" Hole – Slot is 1/4" dia.

TH-CC-1	CeaCap™ Bulkhead Pass-Thru Fitting – Black
TH-CC-2	CeaCap™ Bulkhead Pass-Thru Fitting – White



Overflow Fittings with Filters

- Prevents Drain Clogs
- Twist-Off to Clean
- Fits 1-1/2" ID Hose

TH-1500AFD	Overflow Fitting	Straight
TH-1590AFD	Overflow Fitting	90 Degree
PP-150	Push Plug for Overflow	

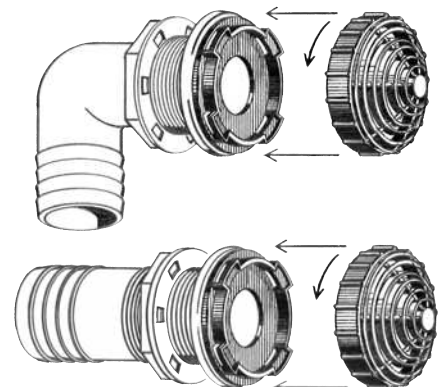



Thru-Hull Fittings

- High Quality UV and Chemical Resistant Virgin Polypro
- Sized to Fit All Marine Hose
- 90° Features Finished Head & Pass-Around Nut

STRAIGHT FITTINGS

Thru-Hull Dimensions Chart – Straight (inches)

Part # Black	Part # White	A	B	C	D	E
TH-500	TH-502	1-1/2	3-1/16	1-3/4	1/2	1
TH-650	TH-652	1-5/8	3-3/8	1-3/4	5/8	1
TH-750	TH-752	1-1/2	3-1/16	1-3/4	3/4	1
TH-1000	TH-1002	1-7/8	3-1/2	1-5/8	1	1-3/8
TH-1200	TH-1202	1-7/8	3-1/2	1-3/4	1-1/8	1-3/8
TH-1500	TH-1502	2-7/8	3-1/2	1-3/4	1-1/2	2
TH-1500XS	TH-1502XS	2-7/8	2-3/4	1	1-1/2	2
TH-750XL	TH-752XL	1-3/4	4-1/2	3	3/4	1
TH-1200XL	TH-1202XL	1-7/8	5-3/8	3-3/8	1-1/8	1-3/8
TH-1500XL	TH-1502XL	2-7/8	5-3/8	3-1/4	1-1/2	2

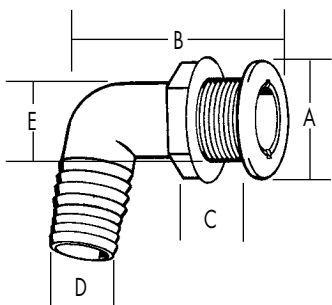
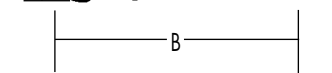
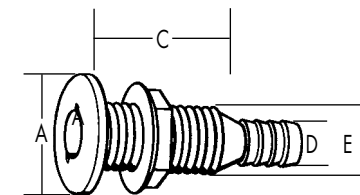

TH-752BHF — White
 • Bulkhead Pass Thru
 • Double 3/4" Barbs

90 DEGREE FITTINGS

Thru-Hull Dimensions Chart – 90 Degree (inches)

Part # Black	Part # White	A	B	C	D	E
TH-7590	TH-7592	1-1/2	2-1/2	1	3/4	1
TH-1290	TH-1292	1-7/8	3-1/2	1-1/8	1-1/8	1-3/8
TH-1890	TH-1892	1-7/8	2-1/4	3/4	1-1/8	1-3/8
TH-1590	TH-1592	2-7/8	4-1/4	1-5/8	1-1/2	2

Specialty Thru-Hull Fittings

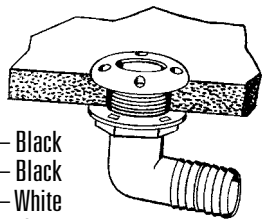

TH-7590S — Black
 TH-1290S — Black
 TH-1292S — White
 • Spanner Head
 • Low Clearance

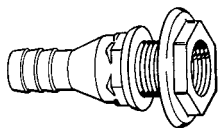

TH-1 — Standard
 TH-1XL — Long
 • Fixed Flange
 • Outside Nut

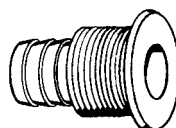

TH-3S — Black
 • Flat Head
 • Total Drainage
 • Requires No Sump

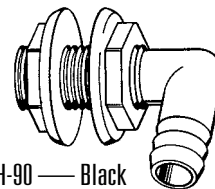

TH-90 — Black
 TH-92 — White
 • Double Nut
 • 90 Degree

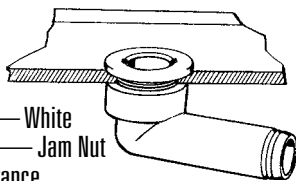

TH-1502S2 — White
 TH-1502S2N — Jam Nut
 • Tight Clearance
 • Two Piece Fitting
 • With or w/o Jam Nut

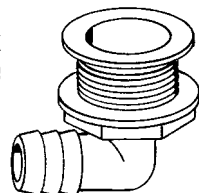

APD-190F — Black
 APD-290F — White
 • Flat Head
 • Total Drainage
 • Requires No Sump

SPECIALTY FITTINGS

Thru-Hull Dimensions Chart – Specialty Fittings (inches)

Part # Black	Part # White	A	B	C	D	E
TH-1	—	1-9/16	2-3/4	3/8	3/4	1
TH-1XL	—	1-9/16	3-1/8	1-1/4	3/4	1
TH-3S	—	1-1/2	2	1	3/4	1
TH-90	TH-92	1-5/8	2-5/8	7/8	3/4	1
TH-7590S	—	1-5/8	2-5/8	7/8	3/4	1
—	TH-752BHF	3/4	4-3/4	2	3/4	1
TH-1290S	TH-1292S	2-3/8	3-1/4	7/8	1-1/8	1-3/8
—	TH-1502S2	2-7/8	3	3/4	1-1/2	1-7/8
—	TH-1502S2N	2-7/8	3-3/4	3/4	1-1/2	1-7/8
APD-190F	APD-290F	1-7/8	2-3/8	3/4	3/4	1-3/8

Thru-Hull Washer/ Gaskets

- Water Tight Seal for Thru-Hulls
- Eliminates Need for Messy Sealant
- Gaskets Compress Flat/Almost Invisible

Part #	Type	Material	Fitting Size
THW-1	Washer	Molded Neoprene Rubber	5/8" - 3/4"
THW-750	Gasket	Closed Cell Neoprene Foam	3/4"
THW-1200	Gasket	Closed Cell Neoprene Foam	1-1/8"
THW-1500	Gasket	Closed Cell Neoprene Foam	1-1/2"



Plumbing Fittings

FA-3/4	Female Adapter – Straight – Gray
	Hose I.D.: 3/4"
	Threads: Female Straight 3/4" – 14



FA-90



FA-90	Female Adapter – 90 Degree – White
	Hose I.D.: 3/4"
	Threads: Female Straight 3/4" – 14

FA-3/4

Elbows	
ELL - 1/4	90° Elbow, 1/4" Hose I.D.
ELL - 3/4	90° Elbow, 3/4" Hose I.D.
ELL-118	90° Elbow, 1-1/8" Hose I.D.



ELL-3/4

Tee-Reducing	
	Size – Black
TEE-150	Hose I.D.: 1-1/2" – 3/4" – 1-1/2"
TEE-250	Hose I.D.: 1-1/8" – 3/4" – 1-1/8"
TEE-350	Hose I.D.: 1-1/2" – 1-1/8" – 1-1/2"



TEE-150

Tees	
	Size – Black
TEE-1/8	TEE, 3 way, 1/8" Hose I.D.
TEE-3/8	TEE, 3 way, 3/8" Hose I.D.
TEE-5/8	TEE, 3 way, 5/8" Hose I.D.
TEE-3/4	TEE, 3 way, 3/4" Hose I.D.
TEE-118	TEE, 3 way, 1-1/8" Hose I.D.
TEE-112	TEE, 3 way, 1-1/2" Hose I.D.



TEE-112

Y-Fitting	
	Size – Black
Y-118	Y-Fitting, 3 Way, 1-1/8" Hose
Y-750	Y-Fitting, 3 Way, 3/4" Hose
Y-630	Y-Fitting, 3 Way, 5/8" Hose



TEE-118

Manifold Systems



“T” Fittings

- Glass Filled Polymer
- Less Expensive than Brass
- Four Sizes for Multiple Flow Rates

MS-3TT34	“T” Fitting – 3 Way 3/4” FNPT
MS-3TT100	“T” Fitting – 3 Way 1” FNPT
MS-3TT112	“T” Fitting – 3 Way 1-1/2” FNPT
MS-3TT114	“T” Fitting – 3 Way 1-1/4” FNPT



Adapter Fittings

- Converts from Pipe Threads to Hose Barbs
- Tough Glass Filled Polymers
- 5 Sizes Fits Most Applications

MS-3A1234	Adapter Fitting – 1/2” MPT to 3/4” Barb
MS-3A34	Adapter Fitting – 3/4” MPT to 3/4” Barb
MS-3A10034	Adapter Fitting – 1” MPT to 3/4” Barb
MS-3A11434	Adapter Fitting – 1-1/4” MPT to 3/4” Barb
MS-3A112	Adapter Fitting – 1-1/2” MPT to 1-1/2” Barb



Nipple Fittings

- Connects Sea Cocks to Manifolds
- Male National Pipe Threads on Each End
- 4 Sizes to Fit Most Systems

MS-3M34	Nipple Fitting – 3/4” MPT to 3/4” MPT
MS-3M100	Nipple Fitting – 1” MPT to 1” MPT
MS-3M114	Nipple Fitting – 1-1/4” MPT to 1-1/4” MPT
MS-3M112	Nipple Fitting – 1-1/2” MPT to 1-1/2” MPT



Reducer Fittings

- Reduces from Male to Female National Pipe Threads
- Connects Pumps to Manifolds
- 3 Sizes Makes Most Connections

MS-3RBI0034	Reducer Fitting – 1” MPT to 3/4” FPT
MS-3RBI1434	Reducer Fitting – 1-1/4” MPT to 3/4” FPT
MS-3RBI1234	Reducer Fitting – 1-1/2” MPT to 3/4” FPT



90 Degree Elbow Fittings

MS-3EL1234	Elbow Fitting – 1/2” MPT to 3/4” Hose Barb
MS-3EL34	Elbow Fitting – 3/4” MPT to 3/4” Hose Barb
MS-3EL1238	Elbow Fitting – 1/2” MPT to 3/8” Hose Barb

Seacock Remote Operation Arm

- Operate Seacock from Deck
- Stainless Steel Arm
- Custom Lengths Available
- Mounting Bracket Available

SEACOCK-18.5	Seacock Remote Operation Arm – 18.5” Length
SEACOCK-24	Seacock Remote Operation Arm – 24” Length
SCB-527	Seacock Arm Mounting Bracket – 4” Length



Remote Drain Controls

- Drain Livewell From Cockpit
- Stainless Steel Vinyl Jacket Cable
- Fits 3/4” or 1-1/2” Hose

Part #	Control Panel	Hook Up	Hose Size
RDC-1	Flat Panel	Parallel to Hose	3/4”
RDC-190	Flat Panel	90° to Hose	3/4”
RDCF-1	Flush Mount	Parallel to Hose	3/4”
RDCF-190	Flush Mount	90° to Hose	3/4”
RDSL-1	Single Lever	Parallel – 1 Valve	3/4”
RDDL-1	Dual Lever	Parallel – 2 Valves	3/4”
RDV-2		Valve Only	3/4”

Cable Lengths Available: • Flush Mount; 4’, 8-1/2’, 10’ & 12’
 • Push-Pull; 8-1/2’, 10’ • Lever Mount: 7’, 8-1/2’, & 10’
 ADD CABLE LENGTH TO PART NUMBER

SEE PAGE 16 FOR QUIK PLUMB™ VALVES.

RDDL-1
Dual Lever

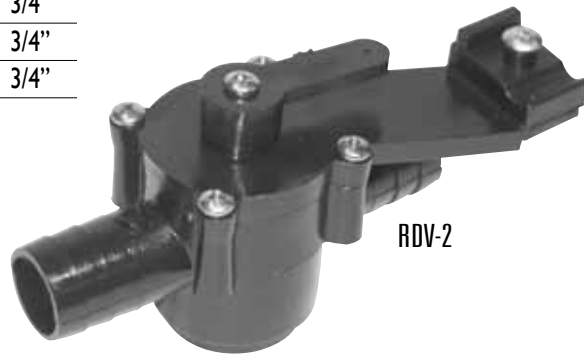

RDV-2

Remote Diverter Valves

- Diverts Water to Two Systems from One Pump
- Control Two Systems From Cockpit
- Fits 3/4” Hose

Part #	Control Panel	Functions
DV-1	Flat Push-Pull	Baitwell/Washdown
DVF-1	Flush Rotary	Fill/Recirculate
DVF-2	Flush Rotary	Recirculate/Pumpout
DVF-3	Flush Rotary	Baitwell/Washdown
DVO-1	None	Diverter Valve Only

Cable Lengths Available:
 • Flush Mount; 4’, 8-1/2’, 10’ & 12’
 • Push-Pull; 8-1/2’, 10’
 • Lever Mount: 7’, 8-1/2’, & 10’

ADD CABLE LENGTH TO PART NUMBER

• Custom function face plates available — Call for information.

SEE PAGE 16 FOR QUIK PLUMB™ VALVES.



DVO-1



DV-1

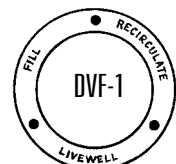

DVF-1

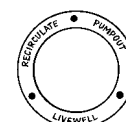

DVF-2



DVF-3



Custom Rod Organizers

- Starboard™ Custom Plates
- Oval Shaped Rod Tubes for Better Rod Eye Fit
- Heavy Walled PVC Tubes
- Custom OEM Designs, Sizes & Number of Tubes
- Vinyl Caps Available to Fit All Tubes
- Call for Details on Ordering

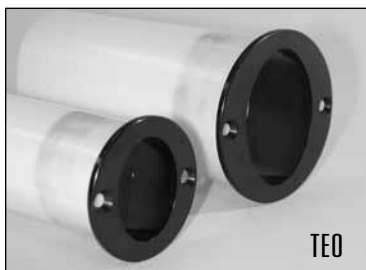

Custom Rod Tubes

- Rod Tubes Available in Oval and Round Shapes
- Various Mounting Flanges Available
- Vinyl Caps Available to Fit All Tubes (Add -WCI to end of part # to have installed)

Part #	Description	Dia.	Hole Size	Max Length
TEO-2.50-1-"X"	Med Oval Rod Tube w/Black Flange	2.30"	2-1/2"	80"
TEO-2.50-2-"X"	Med Oval Rod Tube w/White Flange	2.30"	2-1/2"	80"
TEO-2.50-3-"X"	Med Oval Rod Tube w/Sand Flange	2.30"	2-1/2"	80"
TEO-3.00-1-"X"	Lg Oval Rod Tube w/Black Flange	3.00"	3"	80"
TEO-3.00-2-"X"	Lg Oval Rod Tube w/White Flange	3.00"	3"	80"
TEO-3.00-3-"X"	Lg Oval Rod Tube w/Sand Flange	3.00"	3"	80"
TE-1GT-"X"	Round 2.250" Dia. Tube w/Black Flange			
TE-1FWGT-"X"	Round 2.250" Dia. Tube w/White Flange			
TE-1SGT-"X"	Round 2.250" Dia. Tube w/Sand Flange			
PH-3FWGT-"X"	Round 2.60" Dia. Tube w/White Flange			
PH-3SGT-"X"	Round 2.60" Dia. Tube w/Sand Flange			

"X" = Length of Tube Desired in Inches

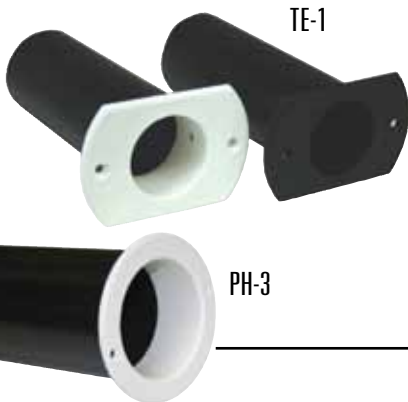

Rod Tubes & Vinyl Caps

Part #	Description	Dia.	Hole Size	Max Length
GT-1.375-"X"	Sm Round Rod Tube w/Rolled Top	1.375"	1-3/8"	43"
GT-1.700-"X"	Med Round Rod Tube w/Rolled Top	1.70"	1-3/4"	60"
GT-2.250-"X"	Lg Round Rod Tube w/Rolled Top	2.25"	2-1/4"	80"
VCAP-1.375	Vinyl Cap – Fits 1.375" Tubes	1-3/8"	n/a	n/a
VCAP-1.687	Vinyl Cap – Fits 1.70" Tubes	1-11/16"	n/a	n/a
VCAP-2.125	Vinyl Cap – Fits 2.50" Tubes	2-1/8"	n/a	n/a

"X" = Length of Tube Desired in Inches

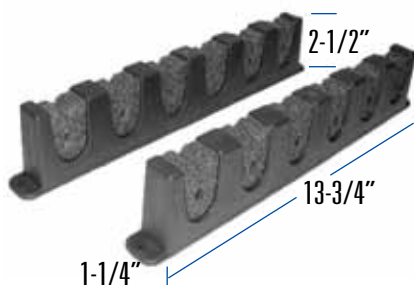

Rod Storage Holders

- Mounts Horizontally or Vertically
- Foam Insert Holds Rods Securely
- Holds up to 6 Rods

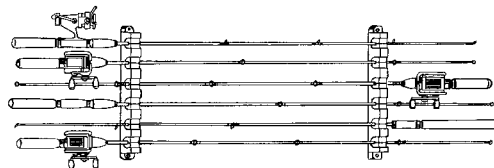

FRH-1	Foam Rod Holder	Bulk, Single
FRH-1P-DP	Foam Rod Holder	Packaged Pair

Rod Grommets

- Flexible Marine Vinyl
- Protects Rod Tips or Butts
- Also Great for Boat Hooks, Gaffs, etc.

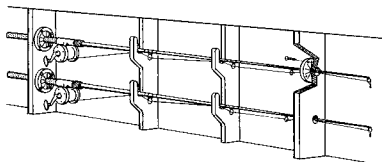

Part Numbers			Dimensions (inches)	
Black	White	Fish White	O.D.	Max Hole Size
UG-1	UG-1W	UG-1FW	3-3/8	2-3/8
UG-2	UG-2W	UG-2FW	2-3/4	1-3/4
UG-3	UG-3W	UG-3FW	4	3

Rod Tube Ends

- Tapered Inside to Protect Rod Tips
- Opening is 1-7/8" ID – Requires 2" Hole
- Fits Inside 2" PVC Pipe

Part #	Description	Color	Fits
TE-1	Tube End	Black	GT-2.250
TE-1W	Tube End	Oyster	GT-2.250
TE-1FW	Tube End	Fish White	GT-2.250
PH-3	Tube End for 2-5/8" pvc	Black	GT-2.60
PH-30	Tube End for 2-5/8" pvc	Oyster	GT-2.60
TEO-2.50	Oval Tube Flange		See pg. 32 for details



Rod Tamer™ Rod Straps

- Holds Rods Securely – Can't Snag Hooks
- Polyurethane Cord – UV & Chemical Resistant
- Non-Corrosive Molded Ends and Hooks

Gunwale Mount

- Retracts Into Gunwale When Unused
- Requires 3/4" Hole

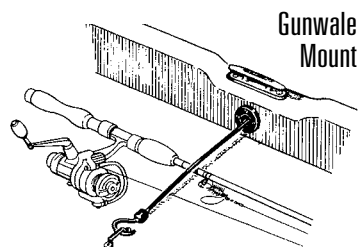

Deck Mount

- Strap End Mounts Directly to Deck

RHDN-1	Rod Tamer™	12" Gunwale Mount, Small Hook
RHDN-2	Rod Tamer™	18" Gunwale Mount, Small Hook
RHD-1	Rod Tamer™	12" Gunwale Mount, Holds Up to 3 Rods
RHD-2	Rod Tamer™	18" Gunwale Mount, Holds Up to 6 Rods
RT-14	Rod Tamer™	12" Deck Mount, Holds Up to 4 Rods
RT-18	Rod Tamer™	18" Deck Mount, Holds Up to 7 Rods

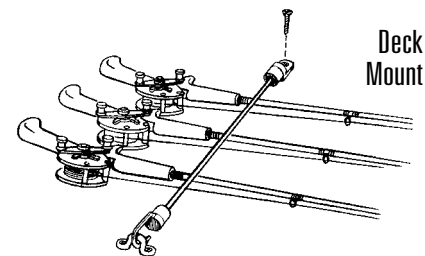

Rod Holder Drain Caps

- Molded Marine Vinyl Drain Cap
- Accepts 3/8" Tubing (Not Included)

Part #	Description	Fits
RHBD-1	Rod Holder Drain Cap	All T-H Rod Holders
RHBD-2SS	Rod Holder Drain Cap	Most Stainless Steel Rod Holders
RHBD-2SST	Rod Holder Drain Cap	Most Stainless Steel Rod Holders, w/Tee

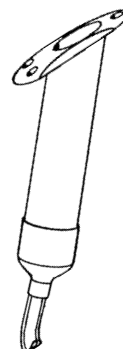



Rod Racks

- UV Stabilized Polypro Tubes with Reel Slots
- High Density Polyethylene Racks
- Knife and Pliers Holders on All Racks
- Stainless Steel Mounting Hardware

Rack Color	Tube Color	Two Rack Part #	Three Rack Part #
Black	Black	RHRB-2B	RHRB-3B
White	White	RHRW-2W	RHRW-3W
Fish White	Fish White	RHRFW-2FW	RHRFW-3FW



Rod Holders

- Durable UV Stabilized Tubes
- One-Piece Design for Easy Installation
- Rod Index in Bottom of All Models
- Units are 8-3/4" L and 1-1/2" ID
- "Rocket Launcher" Style with Reel Slot
- Standoffs Allow Individual Mounting
- Available Without Standoffs for Rack Mounts
- New Oval Head Shape
- Molded for UV Resistance
- Textured for Appearance
- 9-1/2" Long – Fits 2" Hole

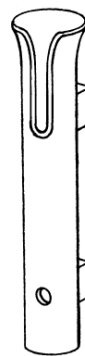

RHSF-3



Description	Black	White	Off-White
Angled 30°	RH-1	RH-1FW	RH-1W
Flat Top	RH-2	RH-2FW	RH-2W
Removable Standoffs	RHS-3B	RHS-3FW	RHS-3W
No Standoffs	RH-3B	RH-3FW	RH-3W
Fixed Standoffs	RHSF-3B	RHSF-3FW	RHSF-3W
Angled Top - Oval Head	RH-4	RH-4FW	RH-4W

Trolling Motor Mount

- Cast Aluminum Bracket – Marine Wood Mounting Block
- Designed for Clamp-on Type Electric Trolling Motors

Important: Maximum trolling motor thrust of 36 pounds.

Motor must be removed and stowed before operating boat or trailering. Not designed for outboards of any horsepower.



Part	Description
TMM-1-DP	Trolling Motor Mount

Trolling Motor Circuit Breaker Kit

- Protects Trolling Motors from Damage
- Contains 50 Amp Circuit Breaker
- 3' of 8-Gauge Wire to Battery
- Kit Includes Mounting Box, Fasteners & Second Ring Terminal for Attaching Trolling Motor Wire



Part	Description
CBBK-1-DP	Trolling Motor Circuit Breaker Kit

Endorsed by:



Gerald Swindle
B.A.S.S. Elite Pro

G-Force Handle

Trolling Motor Replacement Lift & Release Cord

- Stops Cord & Handle Breakage
- Full Grip Cushioned Handle
- Stainless Steel Cable – Nylon Jacket
- Fits Most Trolling Motors
- Hook & Loop Restraint Strap

NEW!!

Part #	Description	Color
GFH-IR-DP	Replacement Trolling Motor Cord	Red
GFH-IG-DP	Replacement Trolling Motor Cord	Gray



G-Force Culling System

Quick and Accurate Tournament Culling System

- Handle Fish Only Once
- Aluminum Balance Beam
- Stainless Steel Hooks
- Color Coded Buoys

Part #	Description
GFC-I-DP	Tournament Fish Culling System

NEW!!

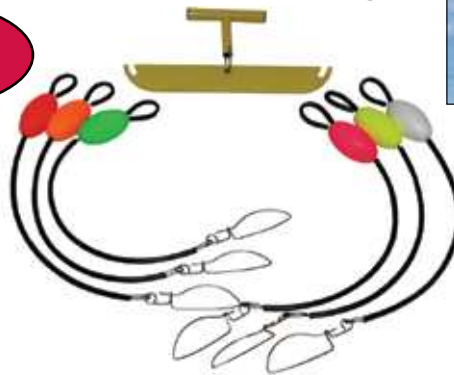

Trolling Motor & Charger Power Plugs

- Heavy Duty Use – Handles High Amps
- Water Tight Seal – Gold Contacts
- Original Equipment on Ranger® Boats
- Easily Handles 12 or 24 Volt Systems

Part #	Description
TMBMP-I	Trolling Motor Male Plug – Black
TMRCP-I	Battery Charger Male Plug – Red
TMFR-I	Female Base Receptacle – Black



Sure Foot™ Trolling Motor Switches

- Foot Control Switch for Electric Trolling Motors
- Rated to 50 AMPS D.C.
- 15° Tilt Angle for Ease of Operation

FCS-1	Sure Foot™ Trolling Motor Switch
FCS-2	Sure Foot™ Trolling Motor Switch with Flip Lever for Continuous "ON"



The Extender

- Extension Handle for Electric Trolling Motors
- Easily Installs on 1" or 1-1/8" Diameter Shaft
- Cast Aluminum w/Stainless Steel Shaft
- Shaft Adjusts from 0"-30" Long

Part #	Description
EX-I-DP	Extension Handle

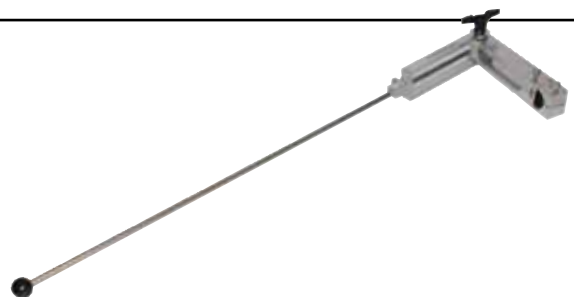
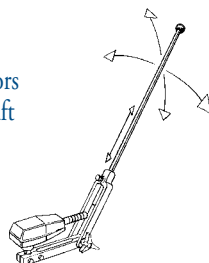



Zippered Rigging Sleeves

- Zips On and Off to Protect Cables and Hoses
- Rugged Sunbrella® – Weather & UV Resistant
- Ends are Secured with Cable Ties

ZRS-1	Zippered Rigging Sleeve	48" Black
ZRS-2	Zippered Rigging Sleeve	28" Black
ZRS-5	Zippered Rigging Sleeve	60" Black



T-H Flex™ Sleeving

- Lightweight Sleeving – Protects Wire, Cables and Hoses
- Braided from High Temperature Yarns
- Expands Up to Four Times its Normal Diameter

Dia.	O.E.M. Part #	Spool Size	Distributor Part #	Spool Size
1/4"	FLXB-25	500'	FLX-25-DP	100'
1/2"	FLXB-50	500'	FLX-50-DP	100'
3/4"	FLXB-75	500'	FLX-75-DP	100'
1-1/4"	FLXB-125	500'	FLX-125-DP	50'
1-1/2"	FLXB-150	500'	FLX-150-DP	50'
2"	FLX-200-DP	50'	FLX-200-DP	50'



Bulkhead Strain Relief Hose Kit

- Distributes Strain From Bends in Hose
- Water Tight Gripper Fitting — No Leaks
- Great for Hydraulic Steering Hose
- Bulkhead Fitting Has Flange for Protection
- Flange is 2-3/4" Dia. & Requires 1-1/4" Installation Hole

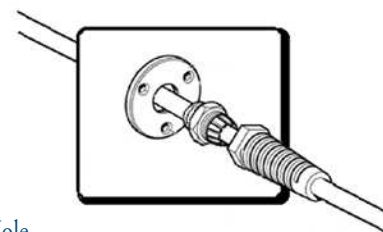

BSR-1K	Bulkhead Strain Relief Hose Kit
BSR-1K-CB	Bulkhead Strain Relief – Chrome Brass Base

Must be Installed Prior to Attaching End Fittings



RFFHP-1

RFHU-1

Typical Installation shown. Fuel Hose not included.

Rigging Flange with Fuel Hose Port & Rigging Flange Hose Union

- Completes Professional Rigging Installation
- Complies with ABYC-NMMA Specs
- Split Design of Union Allows Installation on Pre-Rigged Boats
- Fuel Hose Port Fits Type "A" Hose and Hose Union Fits Type "A" and "B" Hose
- Installs with T-H Marine Rigging Hose

Black	White	Description
RFHU-1	RFHU-2	Rigging Flange Hose Union
RFFHP-1	RFFHP-2	Rigging Flange with Fuel Hose Port



Tri-Shape Rigging Flange

- Hose Fits Over Flange and Into Base
- Designed to Prevent Water Leaks
- Fits 2" Hole

RFT-I	Rigging Flange Only
RFT-IKIT	Rigging Flange, Stainless Hose Clamps, 4' Rigging Hose



Rigging, Flange, Hose Kits

- Protects Cables, Hoses and Wiring from Elements
- Molded Polypropylene Flange Threaded to Retain Hose
- Vinyl Cap Provides Closure for the Engine End of Hose
- Kit Includes Flange & Four (4) Feet of Rigging Hose
- Two Size Flanges for 2" and 2-1/2" Hose

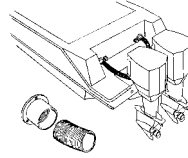

Component	Size	Black #	White #	Chrome#
Flange	Fits 2" Hose	RF-1	RF-2	RF-ICP
Flange	Fits 2-1/2" Hose	RF-2.5-1		
Hose	2"x50 ft.	RFH-1	RFH-2	
Hose	2-1/2"x50 ft.	RFH-2.5-1		
Rigging Flange & Hose Kit				
RFK-1-DP	Black 2" Rigging Flange & 4 ft. Black Hose			
RFK-1-CP-DP	Chrome 2" Rigging Flange & 4 ft. Black Hose			



Contact us for information on cut-to-length kits.

Nylon Cable Ties

Part # (100/Pack)	Part # (1000/Pack)	Length (Inches)	Description
004B-C	004B-M	4"	Cable Tie
055B-C	055B-M	5-5/8"	Cable Tie
007B-C	007B-M	7-1/2"	Heavy Duty Cable Tie
075B-C	075B-M	7-1/2"	Screw Mount Cable Tie
075B-RAD-C	075B-RAD-M	7-1/2"	Radiused Cable Tie
008B-C	008B-M	8"	Cable Tie
011B-C	011B-M	11"	Cable Tie
014B-C		14"	Cable Tie
145B-C	145B-M	14"	Screw Mount Cable Tie
145BHD-C		14"	Heavy Duty Screw Mount Cable Tie



Stainless Steel Hose Clamps

Part #	Item	Hose Size (OD)
HC-4	Stainless Steel Hose Clamps	7/32" to 5/8"
HC-6	Stainless Steel Hose Clamps	3/4" to 7/8"
HC-8	Stainless Steel Hose Clamps	7/16" to 1"
HC-10	Stainless Steel Hose Clamps	7/16" to 1-1/16"
HC-12	Stainless Steel Hose Clamps	7/16" to 1-1/4"
HC-16	Stainless Steel Hose Clamps	1 1/16" to 1-1/2"
HC-24	Stainless Steel Hose Clamps	1" to 2"
HC-28	Stainless Steel Hose Clamps	1-1/4" to 2-1/4"



Oetiker® Stepless® Ear Clamp Kit

NEW!!

- Great for Shop or Rigging Work
- Contains 10 ea. of the 15 Most Needed Sizes (See Chart Below)
- Complete with Connection Tool

Part #	Description
18500000	Stepless® Clamp Rigging Kit



Oetiker® Stepless® Ear Hose Clamps

- Forms a Full 360 Degree Circle
- Tongue and Groove Interlock Design
- Fast Clamping with Tool
- No Leaks Around Hose
- Stainless Steel
- 100 ea. per Bag

Part#	Description	Size	Included in Kit
16700001	Stainless Steel Stepless® Ear Clamp	5.8 – 7.0mm	Y
16700004	Stainless Steel Stepless® Ear Clamp	7.8 – 9.5mm	Y
16700006	Stainless Steel Stepless® Ear Clamp	8.8 – 10.5mm (3/8)	Y
16700007	Stainless Steel Stepless® Ear Clamp	9.6 – 11.3mm	Y
16700010	Stainless Steel Stepless® Ear Clamp	10.8 – 13.3mm	Y
16700011	Stainless Steel Stepless® Ear Clamp	11.0 – 13.8mm (1/2)	Y
16700012	Stainless Steel Stepless® Ear Clamp	11.5 – 14.0mm	Y
16700013	Stainless Steel Stepless® Ear Clamp	12.0 – 14.5mm	Y
16700016	Stainless Steel Stepless® Ear Clamp	13.2 – 15.7mm	Y
16700017	Stainless Steel Stepless® Ear Clamp	14.5 – 17.0mm (5/8)	Y
16700020	Stainless Steel Stepless® Ear Clamp	15.3 – 18.5mm	Y
16700024	Stainless Steel Stepless® Ear Clamp	17.8 – 21.0mm (3/4)	Y
16700031	Stainless Steel Stepless® Ear Clamp	22.4 – 25.6mm (1)	Y
16700037	Stainless Steel Stepless® Ear Clamp	26.9 – 30.1mm	Y
16700040	Stainless Steel Stepless® Ear Clamp	28.4 – 31.6mm	Y
16705000	Stainless Steel Stepless® Ear Clamp	34.9 – 38.1mm (1-1/2)	Y
16705989	Stainless Steel Stepless® Ear Clamp	37.8 – 41.0mm	Y
14100118	Standard Jaw Pincer Pliers		Y

Oetiker® Hose Clamps

- Clamp On – Quick & Secure
- Single Ear – All Stainless Steel
- Full Size Range for All Marine Hose

Part Number	Description	Nominal Size	Part Number	Description	Nominal Size
15500070	101R	25/64"	15500019	316R	1-1/4"
15500000	105R	3/8"	15500020	331R	1-5/16"
15500001	113R	7/16"	15500021	346R	1-3/8"
15500003	133R	1/2"	15500022	361R	1-7/16"
15500006	140R	35/64"	15500023	376R	1-15/32"
15500007	145R	9/16"	15500024	381R	1-1/2"
15500008	157R	5/8"	15500030	470R	1-13/16"
15500009	170R	11/16"	15500031	485R	1-7/8"
15500010	185R	23/32"	15500032	500R	1-15/16"
15500011	198R	3/4"	15500033	615R	2"
15500012	210R	13/16"			
15500013	226R	7/8"			
15500014	241R	15/16"			
15500015	256R	1"			
15500016	271R	1-1/16"			
15500017	286R	1-1/8"			
15500018	301R	1-3/16"			

OETIKER CLAMP INSTALLATION TOOLS

Item No.	Part Description
14100118	Standard Jaw Pincers (formerly 1098)
14100083	Side Jaw Pincers (formerly 1099)

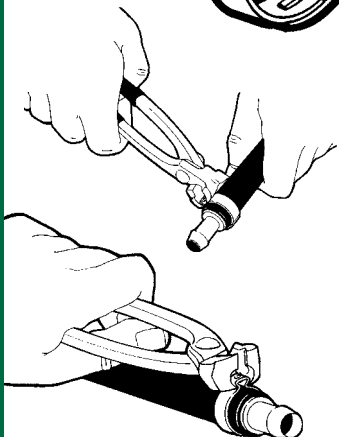
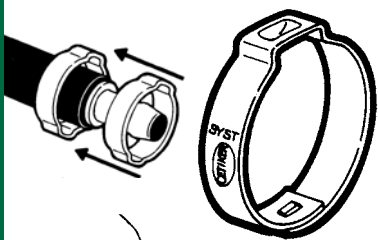

Wire/Hose Hanger

- Secures Wiring Harness or Hoses
- Can Be Glassed In or Screwed Down
- Fits Standard Cable Ties
- Molded – Non Corrosive



WHH-1 Wire/Hose Hanger

WHH-1KIT-DP Kit consists of: 10 Ea. Hangers - Cable Ties - Double Stick Tape

Decorative Wire Cover

- Covers Wire Pass-Thru Holes
- Provides a Finished Look for Wiring

Part # Description

DWC-1 Decorative Wire Cover



Vent Hose Flanges

- Fits 3" or 4" I.D. Wire Supported Vent Hose
- Barbs Prevent Hose from Slipping Off

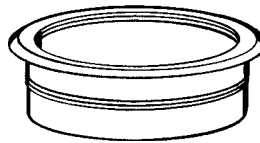

Black # Sand # Description

VHF-3 VHF-3WS Vent Hose Flange, 3"

VHF-4 VHF-4WS Vent Hose Flange, 4"

Cable Boot Grommets

- Protects Cables, Hoses and Wires from Chafing
- Flange Fits into Pass-Thru Hole
- Cable Boot Snaps into Grommet

Black #	White #	Fits
CBG-2	CBG-2W	CB-2
CBG-1	CBG-1W	CB-1
CBG-4	CBG-4W	CB-4



Reinforcing Rings for Cable Boots

Black #	White #	Fits
CBR-1	CBR-1W	CB-1
CBR-2	CBR-2W	CB-2
CBR-4	CBR-4W	CB-4



Cable Boots

- Finishes & Protects Pass Thru Hole for Wires & Cables
- Rugged Marine Vinyl — Resists UV, Gasoline and Oil
- Cable Tie Snugs Around Wires and Cables

Black #	White #	Fish White #	Size
CB-2	CB-2W	CB-2FW	2" Boot
CB-1	CB-1W	CB-1FW	3" Boot
CB-4	CB-4W	CB-4FW	4-1/2" Boot





Cable Boot - Split with Ring

- Split Design – Installs Without Cable or Wire Removal
- Split Mounting Ring Included
- Graduated Boot Rings Can Be Cut to Fit Bundle Size

Part #	Description
CBS-1-DP	Cable Boot – Split – 3-1/2" - W-Ring
CBS-4-DP	Cable Boot – Split – 4-1/2" - W-Ring



Rope Grommets

- Fits 3" Hole
- Prevents Chafing
- Molded Poly
- Flange Diameter – 3-7/8"

RG-1	Rope Grommet – Black
RG-1FW	Rope Grommet – White



UG-3

UG-2



Utility Grommets

- Protects Items Passing Thru Bulkheads, Braces or Stringers
- Marine Grade Flexible Vinyl

Part Numbers			Dimensions (inches)	
Black	White	Fish White	O.D.	Max Hole Size
UG-1	UG-1W	UG-1FW	3-3/8	2-3/8
UG-2	UG-2W	UG-2FW	2-3/4	1-3/4
UG-3	UG-3W	UG-3FW	4	3



UG-1



Oval Grommet

- Provides Protection for Cables and Wiring
- Requires 1-1/2" x 3" Hole

Part #	Description
OG-1	Oval Grommet



Clam Shell Vents

- An Economical Alternative for Metal Clam Shells
- Molded Vents — UV and Weather Resistant

Black #	White #	Hole Size
CS-1	CS-2	9/16 x 1-7/8"
CSS-1	CSS-2	7/16 x 7/8"



Proven to attract bait fish during night trips and add ambiance to any vessel.

High Intensity LED Underwater Lights

Affordable and Totally Waterproof

These waterproof, high-intensity LED underwater lights are designed to be used above or below the water line. A broad flood light effect is created by the engineered optics of the convex light face. Compared to other LED models, this 600 lumen light has greater light output and a wider aperture.

- Surface Mount or Small Hole for Wiring
- 6 Super Bright LED's (600 Lumens)
- Lower Amperage Draw and Longer Life than Conventional Bulbs
- 100,000 Hour Life
- No High Heat Like Most other Underwater Lights
- White, Blue or Green Illumination
- Also Suggested for Transoms, Trim-Tabs and T-Tops
- Stainless Steel Hardware Included
- Dimensions: Surface Size: 3.5" x 1.5"
Height: 1.2" with Mounting Spacer or 0.7" without Spacer

LED-51866	Underwater LED Light	600 Lumens	6 White LEDs
LED-51867	Underwater LED Light	600 Lumens	6 Blue LEDs
LED-51868	Underwater LED Light	600 Lumens	6 Green LEDs



LED Oblong Courtesy Lights

Provides Attractive Light Anywhere

Attractive stainless steel bezel courtesy lights can be used virtually anywhere. The bright polished stainless provides a very rich look. They are great for accent lighting, step, task, compartment, cabinet or courtesy lighting.

- Surface Mount
- Hidden Fasteners
- Three Bright LEDs Provide Excellent Brilliance
- Engineered Lens Directs Light Downward to Avoid Light from Shining into the Eyes
- Circuit Board Completely Sealed in Epoxy to Resist Water, Corrosion and Vibration
- Super Long Life LEDs - Up to 100,000 Hours
- Polished 316 Stainless Steel Bezel
- 1" W x 2.25" L
- Available LED colors: White, Red and Blue

LED-51823	Oblong Courtesy Light	3 Blue LEDs
LED-51824	Oblong Courtesy Light	3 Red LEDs
LED-51825	Oblong Courtesy Light	3 White LEDs



Slim Line LED Utility Strip Lights

Long Lasting Strip Light is a Multi Purpose Solution

Excellent for lighting or decorating interior and exterior of boats, RVs and other vehicles.

- Submersible - 100% Waterproof - Can be Used Virtually Anywhere
- Surface Mounting for Easy Installation
- Low Amp Draw For Longer Battery Life
- Clear Lens Provides Maximum Light

LED-51800	Slim Line Strip Light	4"	6 White LEDs
LED-51801	Slim Line Strip Light	4"	6 Blue LEDs
LED-51803	Slim Line Strip Light	4"	6 Red LEDs
LED-51805	Slim Line Strip Light	6"	12 White LEDs
LED-51806	Slim Line Strip Light	6"	12 Blue LEDs
LED-518010	Slim Line Strip Light	8"	18 White LEDs
LED-518011	Slim Line Strip Light	8"	18 Blue LEDs

- Three Lengths (4", 6", and 8") Cover any Application
- 4" LED colors available: White, Blue, and Red
- 6" LED colors available: White, Blue
- 8" LED colors available: White, Blue



Stainless LED Puck Lights

Clean Looking - Excellent Brilliance

Highly polished 304 stainless steel housing offers a rich, clean look. Ideal for use in boats and RVs as a ceiling, courtesy or task light. Clear Polycarbonate engineered lens optics provides uniform and wide angle illumination.

- Great for Lighting under Cabinets, Cockpits, Headliners and Compartments
- Polished Stainless Steel Bezel
- Surface Mounts on any Flat Surface
- Hidden Fasteners
- Circuit Board Completely Sealed in Epoxy to Resist Water, Corrosion and Vibration
- LEDs Feature Super Long Life Span of up to 50,000 Hours
- 3" and 4" Diameter Sizes Fit Most Needs
- LED Colors Available: White, Blue and Red (3" only)

LED-51827 Puck Light
3" Dia - 4 Warm White LEDs

LED-51828 Puck Light
3" Dia - 4 Blue LEDs

LED-51897 Puck Light
3" Dia. - 4 Red LEDs

LED-51831 Puck Light
4" Dia - 6 Warm White LEDs

LED-51832 Puck Light
4" Dia - 6 Blue LEDs

Recessed LED Puck Lights

Low Profile LED Lights - Smooth Look

Ideal for cabin and compartment lighting in boats and RVs. Three bezel colors offer a shiny look and the clear PC lens, with engineered optics, provides uniform and comfortable illumination.

- Great for Under Cabinets, Rod Lockers, Utility Bins, Etc
- Recessed Mounting Gives Clean Profile Look
- Circuit Board Completely Sealed in Epoxy to Resist Water, Corrosion and Vibration
- Low Amp Draw for Longer Battery Life
- Hidden Fasteners
- 3" Diameter - 6 Brite LEDs
- Requires 2" Diameter Hole
- Black, White & Chrome Bezels Come with Each Light
- LED Colors Available: White, Blue, and Red

LED-51847 Recessed 3" LED Puck Flood
3-Bezels - 6 White LEDs

LED-51848 Recessed 3" LED Puck Flood
3-Bezels - 6 Red LEDs

LED-51847 Recessed 3" LED Puck Flood
3-Bezels - 6 Blue LEDs

LED Surface Mount Dome Light

Easy Mount LED Dome Light with Switch

Clear PC Lens pattern is uniquely designed to distribute the illumination to a wide beam angle of no less than 120°.

- Surface Mount - Easy Installation
- Ideal for Interior Use in Boats, RVs and Other Applications
- Circuit Board Completely Sealed in Epoxy to Resist Water, Corrosion and Vibration
- UV Stable White Housing Resists Color Fading
- Low Power Draw
- Hidden Fasteners
- On/Off Rocker Switch on Bezel
- Super Flux (P4) Type LEDs, Super Bright, Long Life Span up to 100,000 Hours
- Two Models: 15 White LEDs or 9 White / 6 Red LEDs (for night vision)
- Red/White Combo Model has 6 Red and 9 White LEDs

LED-51829 Dome Light w/Switch
4" Dia
15 Cool White LEDs

LED-51830 Dome Light w/Switch
4" Dia
6 Red / 9 White LED Combination

T-H Marine introduces its new line of LED Lights!



LED Companion Way Lights

Light Pathways, Steps and Utility Boxes Economically

- Opaque PC Lens Produces Warm Glow
- Circuit Board Completely Sealed in Epoxy to Resist Water, Corrosion and Vibration
- Low Current Draw, Super Long Life Span up to 100,000 Hours
- Easy Surface Mount
- Fasteners Included
- Bezel Colors Available: Black, White, Chrome Plated
- Dimensions: 2.6" Long x 1.3" Wide



LED-51816	Companion Way LED Light	Black Plastic Bezel	2 White LEDs
LED-51819	Companion Way LED Light	White Plastic Bezel	2 White LEDs
LED-51818	Companion Way LED Light	White Plastic Bezel	2 Red LEDs
LED-51822	Companion Way LED Light	Chrome Bezel	2 White LEDs
LED-51820	Companion Way LED Light	Chrome Bezel	2 Blue LEDs



LED Courtesy Companion Way Light

Recessed Courtesy Companion Way Lights Provide Light In a Variety of Uses

- LED Square Courtesy Light / Companion Way Light- 2.25" x 2.25"
- Great for Compartments, Rod Lockers, Gear Bins, etc.
- Lights a Pathway or Storage Area
- LEDs - Low Power - Long Life (up to 100,000 hours)
- Frosted PC lens
- 3 LEDs Provide Excellent Illumination
- Circuit Board Completely Sealed in Epoxy to Resist Water, Corrosion and Vibration
- Available Bezel Colors: Black and White
- Hidden Fastener Models Provide Clean, No Screw-head Exposed Installation

LED-51894 Courtesy Companion Way LED Light
White Plastic Bezel - 3 White LEDs - hidden fasteners

LED-51891 Courtesy Companion Way LED Light
Black Plastic Bezel - 3 White LEDs - hidden fasteners

LED-51876 Courtesy Companion Way LED Light
White Plastic Bezel - 3 White LEDs - exposed fasteners



LED Rail Light

Rotating LED Rail Light

This series of the lights features a rotating axis design to adjust the light to any desired direction.

- Circuit Board Coated with Conformal Coating to Resist Moisture, Corrosion and Vibration
- Surface Mount
- Powder Coated Aluminum Extrusion Rail with Molded Mounting Ends
- Light Rotates to Direct Light Where You Want It
- Frosted Lens Pattern for Uniform Light Distribution
- Super Bright, Efficient, Long Lasting LEDs (up to 100,000 hours)
- Low Power Draw
- Easy to Install Anywhere
- Available in 6" (12 LED) and 12" (24 LED)



LED-51857	LED Rail Light w/Switch 6" L - 12 Cool White LEDs	Rotating
LED-51858	LED Rail Light w/Switch 12" L - 24 Cool White LEDs	Rotating



LED-51874 Livewell / Utility Light White LED
LED-51875 Livewell / Utility Light Blue LED

Flush Head LED Livewell Lights

Totally Waterproof Light Can be Mounted Underwater

Also great for accent and courtesy lighting! Waterproof, super bright LED designed for livewells, lockers or compartments. Can be used above or below water level with through wall mounting. Also great for accent lighting.

- Great for Livewell Illumination - 100% Waterproof
- Light up High Moisture Areas Without Worry
- Compact Size Mounts Anywhere
- Low Amp Draw for Longer Battery Life
- Super Life Span up to 100,000 Hours
- Impact Resistant Lens with Wide Viewing Angle
- Requires 1" Hole
- 1 LED with Diffuser Lens
- Low Power Draw - Miniscule Heat
- Pigtail Connection, 12V

Mini LED Dual Mount Courtesy Light

All Purpose Dual Mount LED Courtesy Lights Mount Anywhere Light is Needed

These mini utility lights use three LEDs to accent the cabin with soft light. They mount vertically or horizontally for low-profile placement on steps, companionways, under cabinets, compartments and more. Low heat, low amp draw, noncorrosive, shock-resistant and water-resistant.

- Can be Mounted to Face Down, Up or Out
- 3 Bright LEDs
- Very Low Amp Draw
- Versatile Use Anywhere Light is Needed
- Fixture Dimensions: 2-1/8" L x 5/8" H x 1/2" W
- Stainless Steel Fasteners Included



LED-51880 Mini LED Light Dual Mount 3 White LEDs



LED Spreader Light

Powerful 10 LED Spreader Light Illuminates the Night

Fill your cockpit or boat deck with bright light with very little current draw.

- See Off the Transom or Into the Deck When Fishing at Night
- Ten (10) High Intensity LEDs • 1000 Lumens of Light Output
- Great for New Installations or Replacing 55W Halogen Flood Lights
- Power Consumption 80% Lower than Incandescent Lights
- Die-cast Aluminum Housing, Powder Coated White
- Optical Grade Lens • Operating Voltage: 10-30V DC
- Completely Sealed with Waterproof Rating: IP67
- Super Long Life up to 30,000 Hours
- Housing Color: White • Mounting Bracket and Hardware: 316 Stainless Steel
- Simple, Single Bolt Installation

LED-51888 Spreader Light 10 LEDs White Housing



Flex Strip LED Rope Lights

Add Wow to Your Boat

- Can Be Cut to Lengths
- Moisture and Water Resistant
- Strong 3M Mounting Tape on Back
- Available in 1 ft., 2 ft., 4 ft. & 6 ft. Strips
- LED Colors: White, Blue, Red & Green

LED-51946	Flex Strip Rope Lights	12"	White LED
LED-51947	Flex Strip Rope Lights	12"	Blue LED
LED-51948	Flex Strip Rope Lights	12"	Red LED
LED-51949	Flex Strip Rope Lights	12"	Green LED
LED-51950	Flex Strip Rope Lights	24"	White LED
LED-51951	Flex Strip Rope Lights	24"	Blue LED
LED-51952	Flex Strip Rope Lights	24"	Red LED
LED-51965	Flex Strip Rope Lights	24"	Green LED
LED-51953	Flex Strip Rope Lights	48"	White LED
LED-51954	Flex Strip Rope Lights	48"	Blue LED
LED-51955	Flex Strip Rope Lights	48"	Red LED
LED-51966	Flex Strip Rope Lights	48"	Green LED
LED-51956	Flex Strip Rope Lights	72"	White LED
LED-51957	Flex Strip Rope Lights	72"	Blue LED



LED Super Spreader Light

Blazing Illumination Turns Night Into Day

Flood your boat deck with bright and smooth illumination to make low light or night fishing safer and easier.

- Five (5) Super High Intensity 1W LEDs
- 1150 Lumens of Light Output
- Great for New Installations or replacing 55W Halogen Flood Lights
- Provide Smooth, Bright, Even Light to the Entire Boat Deck
- Power Consumption 80% Lower than Incandescent Lights
- Die-cast Aluminum Housing, Powder Coated White
- Optical grade PMMA lens
- Operating Voltage: 10-30V DC
- Color Temperature: 6000K
- Completely Sealed with Waterproof Rating: IP67
- Super Long Life up to 30,000 Hours (30% longer than competition)
- Housing Color: White
- Mounting Bracket and Hardware: 316 Stainless Steel
- Simple, Single Bolt Installation

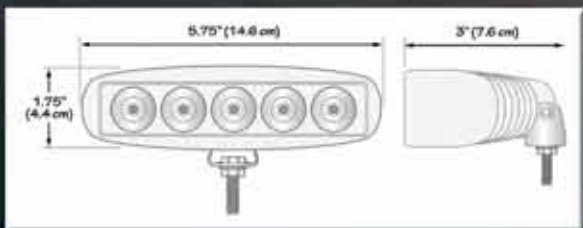

LED-51914 LED Super Spreader™ 5 LED 1150 Lumen



Shark Eye Nav Lights

- Available in LED or Incandescent Models
- Meets ABYC A-16 & USCG 1 NM
- NMMA Type Accepted
- Stainless Steel Base – Tin Wire
- Green Lens and Red Lens in Set
- Each Light is 7-1/2”L and 2-1/4”W



SEL-1LED-DP LED Shark Eye Lights – One Pair

SEL-1-DP Incandescent Shark Eye Lights – One Pair



LWL-1

Livewell/Courtesy Lights LED & Incandescent Models

- Totally Waterproof
- Can Mount Underwater
- Neoprene Sealing Gasket Included
- LED Models Only
- Bright 3-Element LED Bulb
- Bayonet Style Bulb

Incandescent Models

Part #	Item	Type
LWL-1	Livewell/Courtesy Light	3 Watt
CLB-1	Replacement Bulb for LWL-1	194 Wedge Type



LWL-1P-LED

LED Models

Part #	Description	Hole Size
LWL-1P-LED	Livewell/Courtesy Light – LED – Potted	1”
LWLM-1P-LED	Mini Livewell/Courtesy Light – LED – Potted	5/8”



Courtesy Lights LED & Incandescent Models

- Molded Flush Mounts
- UV & Weather Resistant
- Models With Protective Lens
- LED Models Only
- Bright 3-Element LED Bulb
- 194 Wedge Type Bulb

Incandescent Models

Black	White	OffWhite	Description	Face Size	Hole Size
CL-1	CL-2		Courtesy Light – No Lens	2-3/4” Sq	2-1/8”
CLM-1	CLM-2	CLM-3	Mini Courtesy Light – No Lens	2-1/4” Sq	1-3/4”
CLML-1	CLML-2	CLML-3	Mini Courtesy Light – With Lens	2-1/4” Sq	1-3/4”
CLS-1	Momentary ON-OFF Switch – All Models				
CLB-1	Replacement Bulb – 194 Wedge Type – Incandescent Only				

LED Models

White	Amber	Red	Description	Face Size	Hole Size
CL-1LED	CL-1LED-A	CL-1LED-R	LED Light – Black Face – No Lens	2-3/4” Sq	2-1/8”
CL-2LED	CL-2LED-A	CL-2LED-R	LED Light – White Face – No Lens	2-3/4” Sq	2-1/8”
CLM-1LED	CLM-1LED-A	CLM-1LED-R	Mini LED Light – Black Face – No Lens	2-1/4” Sq	1-3/4”
CLM-2LED	CLM-2LED-A	CLM-2LED-R	Mini LED Light – White Face – No Lens	2-1/4” Sq	1-3/4”
CLML-1LED	CLML-1LED-A	CLML-1LED-R	Mini LED Light – Black Face – w/Lens	2-1/4” Sq	1-3/4”
CLML-2LED	CLML-2LED-A	CLML-2LED-R	Mini LED Light – White Face – w/Lens	2-1/4” Sq	1-3/4”
LEDBULB-1	LEDBULB-1A	LEDBULB-1R	Replacement Bulbs for Above Models		

Courtesy Light Switch

- Push Button Switch
 - Momentary Action
- Allows for Mounting in Channel Under Lids



Headlights

- Sealed Beams with 110,000 Candle Power
- Durable, Rubber Housing – Weather-proof & Shock Resistant
- Kit Includes Two Lamps, Switch Panel and Mounting Hardware
- Each Light is 4-3/8" Dia.

HL-I-DP	Head Light Kit
HLRB-I	Head Light Replacement Bulb

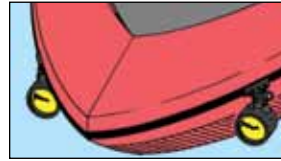

Headlight Mounting Bracket

- Brackets Mount the Headlight Directly to the Rub Rail or Gunnel of Boat
- Kit Contains Two Mounting Brackets and Hardware for Mounting to Boat

Part #	Description
HLB-I-DP	Headlight Mounting Bracket

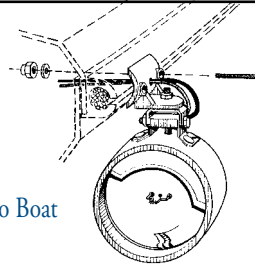

Light Clips

- Secure and Stow Navigation Lights
- Fits All Standard 7/8" Navigation Light Poles

ULC-1	Light Clips – Black
ULC-2	Light Clips – White



Oval Courtesy Lights

- Built In Switch – Push Lens for "On/Off"
- 12 Volt – 5 Watt – Tin Wire
- Oval Hole – 3-1/4" x 2-1/8"
- Flange Overall – 5" x 3-1/8"

Light	Mount Only	Description
OCL-1	OCLR-1	Oval Courtesy Light – Black
OCL-2	OCLR-2	Oval Courtesy Light – White



Trailer Backing Light

- Molded Polycarbonate Lens, Bright 21 Candle Power Bulb
- Wires Directly into the Trailer Harness for Power
- Head Diameter is 1-7/8" and Requires a 1-3/8" Hole

Part #	Description
TBL-I	Trailer Backing Light



2 Sided Mounting Pad
Antenna



Main
Engine

Wiring for Optional Installation



Two Way Boat Alarm

- Shock Sensor Detects Intruders
- Alerts you up to 3000 Yards when Activated
- Two Way Remote Alerts with Sound, Light & Vibration
- Up to 3000 Yards Response and 1000 Yards Transmit
- 128 db Alarm Horn
- Waterproof Main Engine
- Shock Sensor with Sensitivity Adjustment
- Easy Installation



Siren

Remote

TWA-I-DP	Two Way Alarm System – Complete Set
TWAR-I-DP	Two Way Alarm – Additional Remote Control Unit



Quick Flush™ — Outboard Flush Kits

- Snaps On – Quickly Flushes Salt or Sand from Outboard
- Slide Valve Stays on Engine Permanently – “O” Ring Sealed
- No More Fighting Garden Hose to Connect to Engine
- Kit Contains: Slide Valve – Quick Connect – Rubber Washer
- Fits All Outboards with Flushing Port



Patented 5,671,906

Part #	Item	Application
QF-1K	Complete Kit	Johnson – Evinrude*
QF-2K	Complete Kit	Merc/Yamaha/Other
QFV-1	Slide Valve	Johnson – Evinrude*
QFV-2	Slide Valve	Merc/Yamaha/Other
QFC-1	Connector for Hose	Fits All Slide Valves

*Inspection Stream Hole in Valve



Double Flusher

- Flush Twin Outboards at the Same Time
- Connection Ends for Male or Female Connectors
- Convenient Valve Turns Water On or Off or Adjusts Pressure
- Saves Time and Water



Part #	Description
DFMK-1-DP	Double Flusher – Twin Outboard Flushing Kit

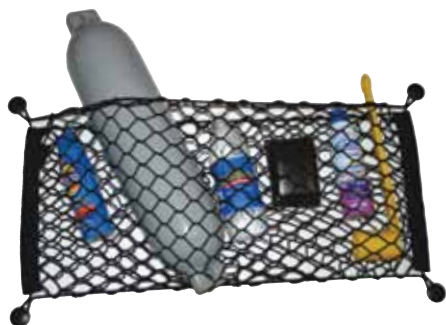

Boat Cargo Nets

- Stows Gear Securely
- Strong Woven Netting
- Bungee Cord Around Perimeter
- Includes Mounting Buttons
- Three Sizes to Choose From

Part #	Description	Size (L x W)
BCN-1-DP	Boat Cargo Net – Small	11" x 11"
BCN-2-DP	Boat Cargo Net – Medium	11" x 25"
BCN-3-DP	Boat Cargo Net – Large	22" x 28"

Pedestal Holders

- Safely Stores Most Seat Pedestals
- Prevents Damage While Underway or Trailing

RH-2P	Enclosed Pedestal Holder	1-11/16" ID	Black
PH-1	Surface Mount Holder	1-1/2" ID	Black
PH-2	Surface Mount Holder	1-3/4" ID	Black
PH-3	Surface Mount Holder	2-1/2" ID	Black
PH-3FW	Surface Mount Holder	2-1/2" ID	White
PH-3S	Surface Mount Holder	2-1/2" ID	Sand

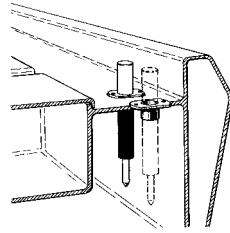

Utility Flanges

- Protects Cables, Wires, Hoses or Rods
- Flange Protects Inside of Pass Thru

Black #	White #	Sand #	Sizes
PH-1	—	—	1-1/2" I.D.
PH-2	—	—	1-3/4" I.D.
PH-3	PH3-FW	PH-3S	2-1/2" I.D.
TE-1	TE-1W	TE-1S	2-1/4" I.D.



Trailing Clips

- Protects Stern Drive Units while Trailing or Storing
- Increase the Life of the O-Rings, Internal Seals, and Valve in the Hydraulic System
- Resistant to UV Rays, Gasoline, Oil and Other Marine Chemicals
- Fits all Stern Drives with 3/4" Hydraulic Rams

Part #	Description
TC-1-DP	Trailing Clips, Pair – 12" Length

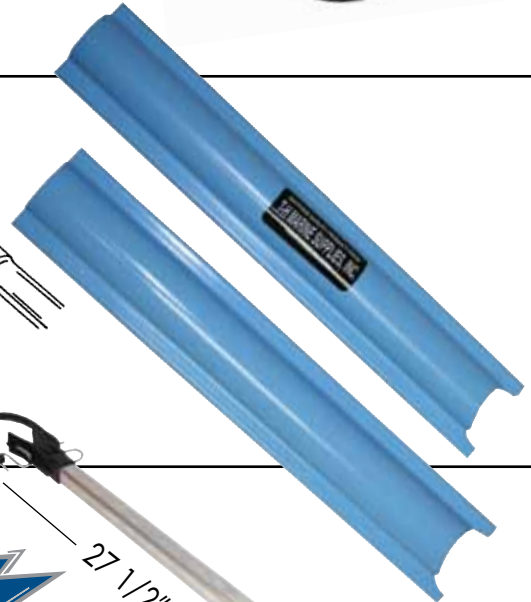
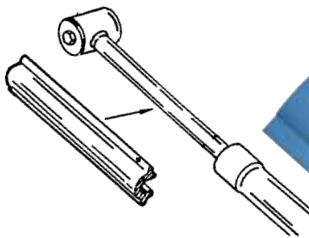

Adjustable Motor Support

- Protects Transoms from Stress of Engine when Trailing
- Extends to 46-1/2" for Boats with Jack Plates
- Heavy Wall Aluminum Tubing for Strength

Part #	Description
AMS-1-DP	Adjustable Motor Support

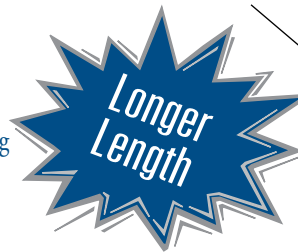

Motor Stik™

- Fits Over Trim Rams
- Supports Your Outboard While Trailing
- Takes the Pressure Off of Hydraulic System
- Most Outboards 150hp and Up
- Strong Aluminum Tubing with Molded Ends
- Salt or Fresh Water

Part #	Description
MSS-1	Outboard Motor Supports
MSS-1CD	Counter Display – 8 units

Outboard Motor Support



NEW!!



Robo Cup® Holder/ Rod Holder

- Powerful Spring-Loaded Rubberized Jaws Instantly Attach
- Securely Holds Two Cups or Rods
- No Tools Required – Squeeze and Attach
- Bottom Cap Screws Off for Rod Holder



Part#	Description	Color
ROBCP-1-DP	Robo Cup® Portable Caddy	Black
ROBCP-2-DP	Robo Cup® Portable Caddy	White



Cup Holder

- Resistant to UV, Breakage and Chemicals
- Short Cup Holder has Drain Holes on Bottom
- Large Cup Holder Accepts 3/8" I.D. Hose for Drainage

Black #	White #	Off-White #	Tan#	A	B	C
LCH-1	LCH-1W	LCH-1WS	LCH-1T	4-1/4"	4-5/16"	4-1/4"
LCH-2	LCH-2W	LCH-2WS	LCH-2T	1-7/8"	4-3/16"	3-5/8"

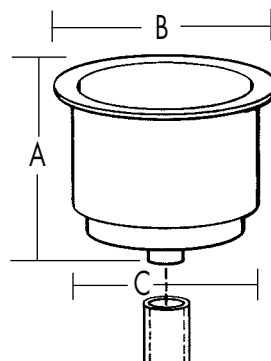

Stainless Steel Cup Holder

- Top Quality Stainless Steel
- Full 3-3/4" Diameter – Fits Most Existing Cup Holes
- Drain Fits 3/8" Hose

Part #	Item	A	B	C
LCH-ISS	Stainless Steel Cup Holder	3-3/4"	4-3/8"	3-3/4"

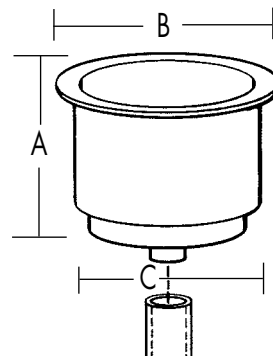

Windshield Fastener

- Makes Installing and Removing the Windshield Simple
- Base Mounts to the Boat and the Quick Twist Fastener Passes Thru Windshield
- Great for Preventing Broken Windshields in Shipping, Installation and for Cleaning

WSH-1	Windshield Fastener – Wing Nut Head
WSH-1F	Windshield Fastener – Flush Mount Slotted Head

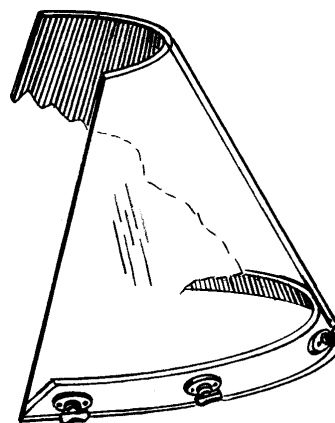

Fuel Container Hold-Down Kit

- Securely Holds Portable Fuel Tanks Up to 62" in Circumference
- Quick Release Buckles for Quick & Easy Removal
- Kits Includes: Two 62" Poly Straps, Four Footman Loops w/ Hardware



Part #	Description
FCH-I	Fuel Container Hold-Down Complete Kit

Cooler Mounting Kit

- Secures Any Size Cooler to Deck
- Recessed Fasteners Allow Full In-corner Mounting
- Nylon Bungee Straps – Stainless Steel Center Hook
- Kit Contains Four Corner Brackets and Two Bungee Straps



CMK-I	Complete Cooler Mounting Kit
CMB-IS	Single Cooler Corner Bracket
STRAP-I2BWS	Single Cooler Mount Strap

All Purpose Holding Strap

- Tough 62" Polypropylene Strap Secures Any Loose Article
- Quick Release Buckle Makes Removal a Snap
- Two Footman Loops and Stainless Hardware Included



Part #	Description
APS-I	All Purpose Holding Strap Complete Kit

Paddle Keeper

- Unique Concept for Paddle Storage
- Holds Paddle Either Vertical, Horizontal or Overhead

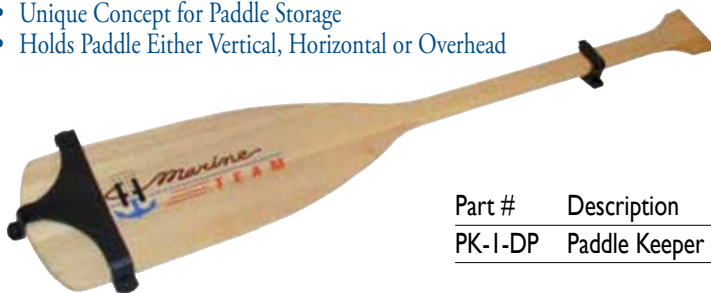

Part #	Description
PK-I-DP	Paddle Keeper

Prop Stop™ — Spare Prop Retainer

- Secures Spare Propeller in Any Location
- Holds Any Size Propeller and its Thrust Washers
- Tough Graphite Retaining Rod

PRB-I	Prop-Stop™ Rod and Base
PRR-I	Prop-Stop™ Rod Only

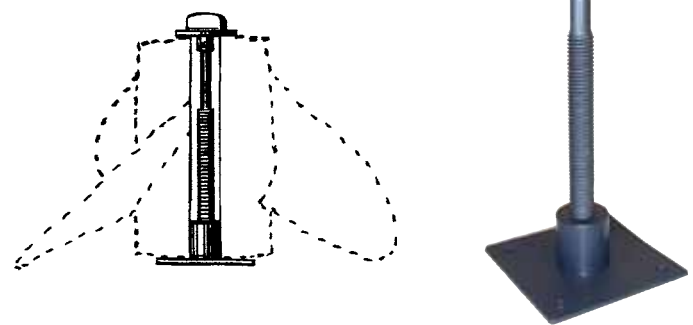



Steer-Stop™ Steering Lock

- Locks Hydraulic Steering when Trailing
- Clips onto Hydraulic Steering Rams
- Keeps Engine Straight and Prevents Damage to Transom Savers

SS-1 Steer-Stop™ Steering Lock Set – 4”

SS-2 Sea Star Pro Steering – 5”

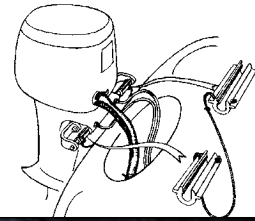

Battery Holder Tray for Optima® Batteries

- Shaped Inserts Fit Both Optima® D27M and D31M Series
- Rugged Poly Tray with 8 Mounting Slots
- Poly Strap with Stainless Steel Buckle
- Resistant to UV and Corrosion

Part #	Description
NBH-31-SSC-OPT	Battery Tray for Optima® Batteries



Battery Holder Accessories

Part #	Description
BS-1	Replacement Battery Strap w/Poly Buckle
BS-1-42SS	Replacement Battery Strap w/Stainless Steel Buckle
BCB-1S	Replacement Hardware for Stainless Steel Rod Models – Cross Bar, Rods & Hardware
NBHI-1	Battery Holder Insert – Converts 27 Series Tray to Fit a 24 Series



Dual Battery Holder Tray

- Holds Two Series 27 Deep Cycle Batteries
- No Wasted Space – Two Batteries Side by Side
- Patented Poly Strap with Quick Release Buckle
- Meets All NMMA Specs for Battery Retention

Part #	Length	Width	Height
DBH-27P	14-1/2”	13-1/8”	1”

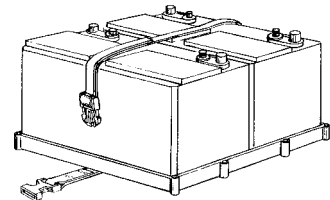

Battery Holder Tray w/ Stainless Steel Buckle

- Quality “316” Stainless Buckle
- Meets All NMMA Specs
- Designed to Fit Tight Spaces
- Recessed Mounts – No Tabs

Stainless Buckle	Battery Series	Length (Inside)	Width (Inside)	Width (Outside)	Height
NBH-24-SSC	24	10-5/8”	7”	8”	1”
NBH-27-SSC	27	12-1/2”	7”	8-1/2”	1”
NBH-31-SSC	29/31	13”	7”	8-1/8”	1”

Frame Top Battery Tray

NEW!!

Frame Top Holds Batteries Securely

- Top Frame Encompasses Entire Battery Perimeter
- Easy Adjust Knobs
- Thick Base Holds Heaviest Batteries
- Recessed Fasteners
- Available in Series 24 and 27
- Stainless Steel Rods Resist Corrosion

BHF-24S Frame Top Battery Tray 24 Series

BHF-27S Frame Top Battery Tray 27Series



Combo Battery Trays

- Clip System – Fits Series 24 & 27
- Poly Strap & Stainless Rod Models
- Resistant to Acid & Gasoline

NBHC-247P Combo Battery Tray – 24/27 Poly Strap

NBHC-247S Combo Battery Tray – 24/27 SS Rod



Battery Holder Trays

- Meets All NMMA Specs
- Rugged Hi-Strength Poly Material
- Quick and Easy to Install

Poly Strap	Battery Series	Length (Inside)	Width (Inside)	Width w/tabs (Outside)	Height
BH-24P	24	11-1/8"	7-1/4"	8-5/8"	1"
BH-27P	27	12-3/8"	7-1/4"	8-5/8"	1"
BH-31P	29/31	13"	7-1/4"	8-5/8"	1"

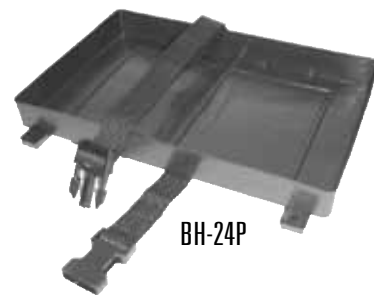

BH-24P

Space Saver Battery Holder Trays

- Fits into Tightest Spaces
- Meets All NMMA Specs
- Recess Mounting Wells – No Tabs
- Patented Poly Strap Models or Stainless Steel Rod Models
- Quick Release Buckle on Poly Strap

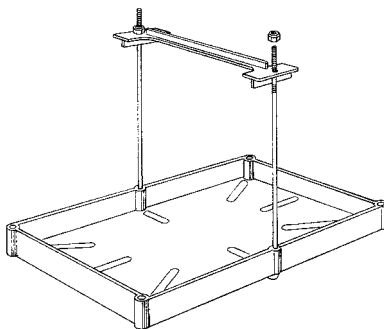

Poly Strap	Stainless Rods	Battery Series	Length (Inside)	Width (Inside)	Width (Outside)	Height
NBH-24P	NBH-24S	24	10-5/8"	7"	8"	1'
NBH-27P	NBH-27S	27	12-1/2"	7"	8-1/2"	1'
NBH-31P	NBH-31S	29/31	13"	7"	8-1/8"	1'



NBH-27S



NBH-27P

Bungee Shock Cord



Bungee/Shock Cords

- Components Needed to Construct Custom Straps for any Application
- Components are Offered Separately or Can Be Purchased as a Custom Part
- Contact T-H Marine for Custom Strap Production to Meet Your Specifications

Part #	Description	Size	Color
--------	-------------	------	-------

STRAPS

BCORD-14B	Bungee/Shock cord	1/4" x 500'	Black
BCORD-14BW	Bungee/Shock cord	1/4" x 500'	Black & White
BCORD-516B	Bungee/Shock cord	5/16" x 500'	Black
PCORD-14B	Polyurethane cord	1/4" - 280'	Black

HOOKS

RTHOOK-1	Hook	For 1/4"	Black
RTSM-1	Screw mount	For 1/4"	Black

EYES

EYE-1	Molded eye strap	1/2" ID	Black
EYESS-1	Stainless steel eye	3/8" ID	Stainless
FL-1	Footmans loop, molded	1" ID	Black

RTHOOK-1



RTSM-1



FL-1



EYE-1/EYESS-1



Pontoon Gate Latch w/ Stainless Steel Inserts

NEW!!

- Stainless Steel Inserts for Strength – Meets ABYC H31 Specs
- Inserts Completely Encased in Molded Poly for Esthetics and Anti-Rattling
- Single Hole Installation Saves Labor Time
- Can Be Opened From Front or Back
- Fits 1-1/8" & 1-1/4" Square Tubing

Part #	Description	Color
GLSS-2	Pontoon Gate Latch w/ Stainless Steel Inserts	Gray

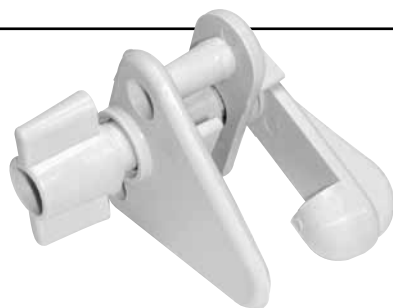

Pontoon Gate Latch

- Entire Unit Installs on Gate Only
- Molded Nylon for Strength – No Rattle
- Operates on Right or Left Hinged Gates
- Fits 1", 1-1/8" & 1-1/4" Square Tubing

GL-1	Gate Latch	Black
GL-2	Gate Latch	Gray

NOTICE: NOT DESIGNED AS A SAFETY OR LOAD BEARING DEVICE.

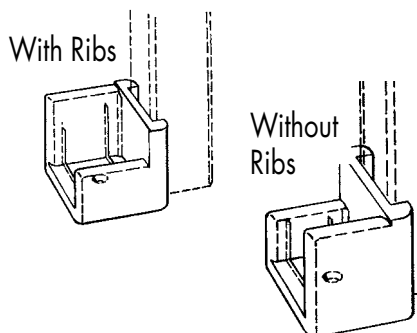
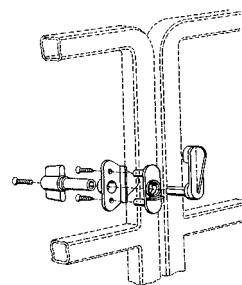

Pontoon Door Stops

- Molded Anti-Rattle Stop
- Ribbed Models Snap Around Tube
- Fits up to 1-1/4" Square Tubing

Gray	Black	Type	Hinge
DS-1R	DS-1RB	W/Ribs	Right
DS-1L	DS-1LB	W/Ribs	Left
DS-2R	DS-2RB	No Ribs	Right
DS-2L	DS-2LB	No Ribs	Left

NOTICE: NOT DESIGNED AS A SAFETY OR LOAD BEARING DEVICE.



Pontoon Saf-T-Latch™

- Dead Bolt Gate Latch & Stops
- Designed as Load Bearing Device
- Constructed from Super Tough Nylon
- Meets ABYC Specs H41.6.3.5 & H41.6.3.6

DBGL-IG	Saf-T-Latch™ – Dead Bolt Gate Latch Kit
DBBS-IG	Dead Bolt Barrel Sleeve Only
DBAS-IG	Dead Bolt Alignment Stop
PFFG-IG	Pontoon Finger Pincher Guard – Gray

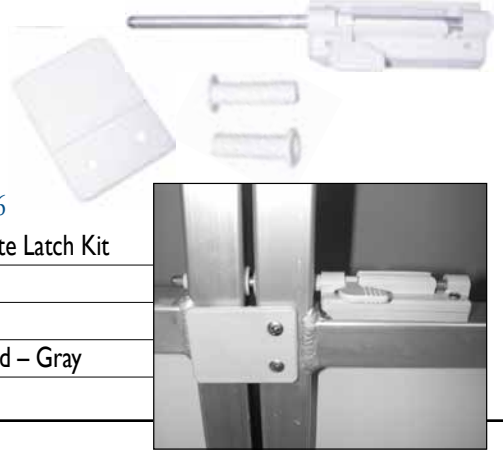

Pontoon Gate Holders

- Holds Gates In Open Position
- Will Not Break, Rattle or Corrode
- Fits Up To 1-1/4" Square Tubing

GH-IB	Pontoon Gate Holder	Black
GH-IG	Pontoon Gate Holder	Gray

**NOTICE: NOT
DESIGNED
AS A SAFETY OR
LOAD BEARING
DEVICE.**

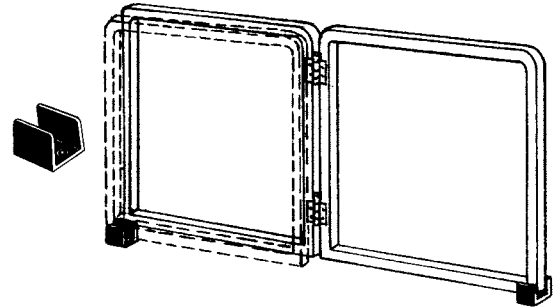

Pontoon Rail Shims

- Uniformly Raises Rails Off of the Deck
- Unique Slotted Design for Easy Installation
- Eliminates Difficult Alignment of Shims
- Three Thicknesses Available



SPA-250G	Pontoon Rail Shim – 1/4" Thick	Gray
SPA-375G	Pontoon Rail Shim – 3/8" Thick	Gray
SPA-500G	Pontoon Rail Shim – 1/2" Thick	Gray

Fuel Splash Guards

- Directs Fuel Splash Away From Boat
- Great on Rolled Edge or Aluminum Boats

Part #	Fill Type	Width	Length
FSG-1	Vent or Round	4- 1/4"	6-1/8"
FSG-1XL	Vent or Round	4- 1/4"	7-5/8"
FSG-2	Round Fill	4- 1/4"	6-1/8"
FSG-2XL	Round Fill	4- 1/4"	7-5/8"
FSG-3	Fits Perko # 1319	4- 1/4"	6-1/8"
FSG-3XL	Fits Perko # 1319	4- 1/4"	7-5/8"
FSG-6-39	Vent or Round	7"	6"
FSG-7	Vent or Round	6-5/8"	4"
FSG-8	Vent or Round	4-3/8"	5-1/4"

- Contact us for Part # on ANY Fill.

FSG-1, 2 & 3



FSG-6-39

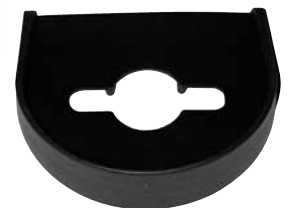



Molded Nylon Cleats

- Tough Nylon & Molded for Strength & UV Resistance

CLEAT-3	Nylon Cleat	3" Black
CLEAT-4.5	Nylon Cleat	4-1/2" Black
CLEAT-6	Nylon Cleat	6" Black
CLEAT-8	Nylon Cleat	8" Black
CLEAT-10	Nylon Cleat	10" Black

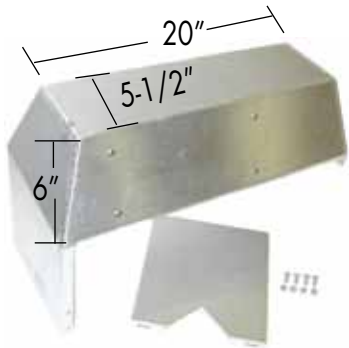

Steering Console Mount

- Thick .090 Welded Aluminum
- Wood Reinforced Wheel Mount Area
- Adjustable Height 10" to 20"

Part #	Description
SCM-2-DP	Steering Console Mount

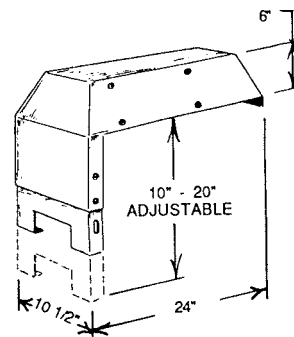

Throttle Control Mount

- Solid .090 Aluminum
- Great for Aluminum Boats

Part #	Description
TCM-1-DP	Throttle Control Mount

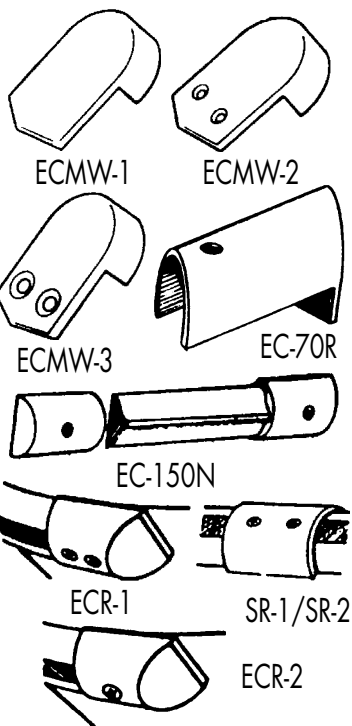
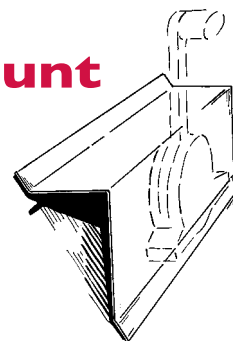

Rub Rail Fittings

- Fits Aluminum or Rubber Rails
- Non-Corrosive Molded Ends

EC-150N	For 1-1/2" Wide Aluminum Molding w/Vinyl Insert	Black
ECR-1	For 1-1/2" Wide Rubber Molding w/Insert	Black
ECR-1W	For 1-1/2" Wide Rubber Molding w/Insert	White
ECR-2	For 1-3/4" Wide Rubber Molding w/Insert	Black
SR-1	Butt Splice for 1-1/4" to 1-1/2" Rub Rail, 2-1/4" Long	Black
SR-1W	Butt Splice for 1-1/4" to 1-1/2" Rub Rail, 2-1/4" Long	White
SR-2	Butt Splice for 1-3/4" to 2" Rub Rail, 3" Long	Black
SR-6	Butt Splice for 2" Rub Rail, 6" Long	Black
ECMW-1	End Cap Motor Well for 1-3/4" Wide Molding	Black
ECMW-2	End Cap Motor Well for 1-3/4" Wide Molding	Black
ECMW-2W	End Cap Motor Well for 1-3/4" Wide Molding	White
ECMW-3	End Cap Motor Well for 1-1/4" Wide Molding	Black
EC-70R	Fits 2" Rub Rail, Right End	Black
EC-70L	Fits 2" Rub Rail, Left End	Black
TEC-1	Trim End Cap, 1/2" to 5/8" Trim	Black

Wash Down Hose Holder Station

- Surface Mount Affixes Anywhere on Deck
- Complete with 25' Wash Down Hose and Nozzle
- Keeps Decks Neat and Safe
- Comes with 5' of Supply Hose to Attach to Wash Down Fitting or Directly to Supply Pump
- Drain Holes in Bottom of Hose Compartment
- Available with White or Blue Hose

WDHH-25B-C-DP Hose Holder With Blue Hose & Nozzle

WDHH-25W-C-DP Hose Holder with White Hose & Nozzle

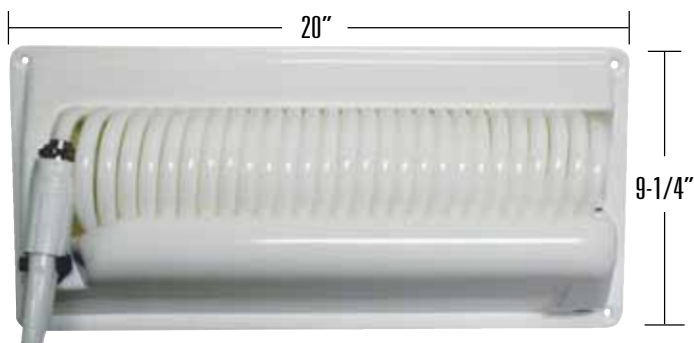

Wash Down Station & Hose

- 1/2" Coiled Poly Hose
- UV & Chemical Resistant
- Non Corrosive Hose Fittings & Nozzles
- Station Includes Storage Tube & Screw-Out Cover

Part #	Description
WDSB-"X"- "Y"	Wash Down Station w/15' Blue Hose & Choice of Cover Color & Nozzle Type
WDSW-"X"- "Y"	Wash Down Station w/15' White Hose & Choice of Cover Color & Nozzle Type
WDH-15B-"Y"	Wash Down Hose Only – 15' w/Choice of Nozzle – Blue Hose
WDH-25B-"Y"	Wash Down Hose Only – 25' w/Choice of Nozzle – Blue Hose
WDH-15W-"Y"	Wash Down Hose Only – 15' w/Choice of Nozzle – White Hose
WDH-25W-"Y"	Wash Down Hose Only – 25' w/Choice of Nozzle – White Hose
WDN-1	Nozzle Only – Pistol Grip Style
WDN-2	Nozzle Only – Straight Style

"X" = Color Code: 1=Black 2=Polar White 3=Sand Shell "Y" = Nozzle Code: A=No Nozzle B=Pistol Nozzle C=Straight Nozzle

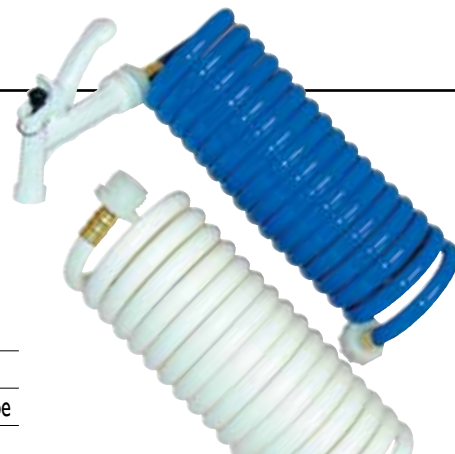

Stick 'N' Spray™ Hose Holder

- Large Suction Cup Holds Firmly in Place
- Hose Stays Where You Put It
- Frees Both Hands for Washing Operation
- Nozzle Adjusts From Stream to Spray to Off

Part #	Description
HHSC-I-DP	Stick 'N' Spray™ Hose Holder



Winter-EZE™ Stern Drive Winterizing System

Don't winterize your boat...WINTER-EZE™ it!

- Molded Reservoir Fits Around Stern Drive Unit Below Pump Intake
- Fill With Water and Start Engine – Run to Open Thermostat
- Add Antifreeze to Reservoir – Pump Pulls Antifreeze into Engine

Part #	Description
WEZ-I-DP	Winter-EZE™ for Mercruiser Alpha I/Os

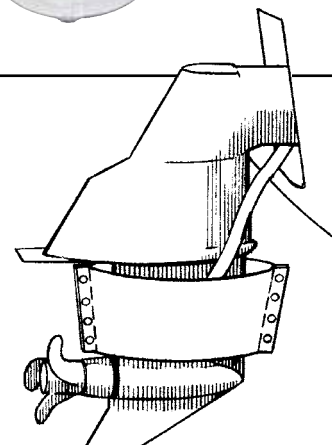



Anchor Master™ Anchor Retrieval System

- Use Boat's Power to Raise Anchor
- Slip Ring Onto Anchor Line – Attach Buoy Line
- Run Boat Into Current Away From Anchor Set
- Buoy Provides Resistance – Anchor Raises
- 12" Buoy – Stainless Ring & Snap – Rope

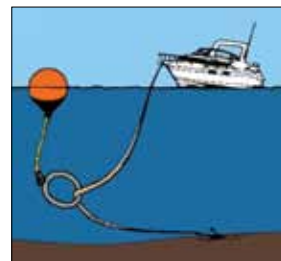

Part #	Description	Rope Type
AR-1-DP	Complete Anchor Master™ System*	Poly
AR-1N-DP	Complete Anchor Master™ System*	Tw Nylon
AR-0-DP	Anchor Master™ Without Buoy	
ARO-1-DP	Stainless Anchor Ring Only	

* Handles up to 20 lb. Fluke Style Anchors



Aqua Utility Clips

- Holds Any Item Securely
- Rugged Poly Resists Sun & Salt
- Stainless Steel Spring
- Fits Standard 7/8" Rail

NEW!!



AUC-2	Aqua Utility Clips	White	Bulk – Each
AUC-9	Aqua Utility Clips	Blue	Bulk – Each
AUC-2PR-DP	Aqua Utility Clips	White	Packaged – 1 pair
AUC-9PR-DP	Aqua Utility Clips	Blue	Packaged – 1 pair



Grab Handles

- Molded – UV Resistant
- Textured for Sure Grip
- Hidden Fasteners



Part #	Description	Color
GHB-1	Grab Handle	Black
GHB-1FW	Grab Handle	Fish White
GHB-1T	Grab Handle	Tan
GHB-1G	Grab Handle	Graphite

Marine Grade Vinyl Caps

- Protects Bolt & Screw Threads
- Large Sizes Fit Rod Tubes



Part #	Diameter	Length
VCAP-.250	1/4"	1/2"
VCAP-.500	1/2"	1/2"
VCAP-1.375	1-3/8"	1-1/2"
VCAP-1.687	1-11/16"	1-1/2"
VCAP-2.125	2-1/8"	1-1/2"

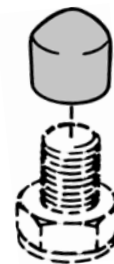

Prop Master™ Propeller Wrench

- Fits All 1-1/16" Prop Nuts (40hp & up)
- Rugged Nylon Resists Stripping
- 9/16" Garboard Drain Socket on Back
- Non-Corrosive in Salt Environment

Part #	Description
PMW-1	Prop Master™ Propeller Wrench

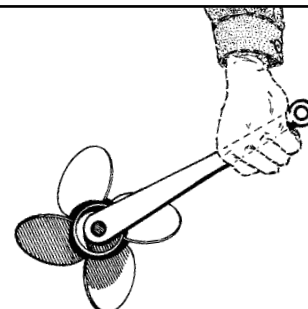

PRODUCT INSERT



QUALITY PRODUCTS | PRECISION MACHINING





Hydraulic Power-Lift® Transom Jacks



The High Speed Power-Lift is the newest addition to the product line. The model PL-65HS High Speed Power-Lift will raise V-6 300 h.p. and smaller outboard motors in approximately 8 seconds which is twice as fast as the regular PL-65 that has been in the market since 1982. Ideal for those who want a jack plate for high speed positioning of their outboard motor.

5.5" SET-BACK	10" SET-BACK
MODEL PL-65HS	MODEL PL-65-10HS
#65301 - w/ gauge	#61301 - w/ gauge
#65302 - w/o gauge	#61302 - w/o gauge

MOUNTING HARDWARE INCLUDED WITH CMC LIFTS.
*The Model PL-65 is rated for V-6 and smaller motors. Not designed for V-8 motors or racing applications. See Model PL-65SS.

Accessories



The optional position indicator is sealed and drip proof and mounts in the dash for safe and convenient height determination. The indicator features an up-down toggle switch as standard equipment. The sending unit is completely sealed and waterproof.

CUSTOM WASHER PLATES

The top washer plate can be custom engraved with no minimum order. Up to 16 characters can be engraved.

#20000



TRANSOM WASHER PLATES

Made of strong 3/8" 6061 T6 alloy aluminum (not cast aluminum), the CMC transom washer can eliminate bolts "biting" into transoms and can more evenly distribute loads on high performance engines. Hole centers: Top Plate - 12 7/8" Bottom Plate - 9 7/8"

Top Washer Plate #20022
Bottom Washer Plate #20032



Our most popular model, the PL-65 is rated for V-6 and smaller motors and provides 5" of vertical travel. It is not designed for V8 motors or racing applications. See model PL-65SS.



**5 1/2" SET-BACK
MODEL PL-65***
#65001 - w/ gauge
#65002 - w/o gauge

**10" SET-BACK
MODEL PL-65-10**
#61001 - w/ gauge
#61002 - w/o gauge



MODEL PL-65SS
#65201 - w/ gauge

The same rugged lift system as our PL-65 units with the addition of 1/2" stainless steel motor rails that give this jack the strength and power to lift V6 and V8 engines of 300hp max. The solid stainless rails have no castings or welds to break making this the strongest jack in our lineup. The roller assembly contains a stainless steel 3/4" pin with aluminum-bronze alloy rollers for less friction, longer wear and virtually no binding.

With CMC, there is no need for a hydraulic tank, motor, pump and hoses inside your boat!

TRANSOM WEDGES/SET BACK SPACERS

These 2 degree wedges are designed to give extra positive or negative trim. The wedges are used as an aid for boats with an insufficient transom angle or for boats having planing problems at low speed. Our unique design of the CMC Transom Wedges allows you to also use them as set back spacers, by simply inverting 2, 4, and 6 sets. Hole design fits the same pattern as the Power-Lift transom bracket and standard motoring mounting.

SIZE: 1/2" x 4" x 11 1/4" #20122



TRIM BUTTON SWITCH

This weatherproof trim button switch is made of molded black plastic with raised white letters. It can easily be wired to the PT-130 Power Tilt and Trim or Power-Lift wire assemblies.

#20220



WATER PRESSURE GAUGE

The water pressure gauge is sealed and drip proof and is mounted in the dash of the boat. The gauge registers from 0 – 30 P.S.I.

#20320



Manual Power-Lift[®] Transom Jacks

Manual Features:

- One Piece Design
- Made of 6061 T6 extruded aluminum alloy
- Stainless steel fasteners for maximum strength and durability
- Centrally located adjustment screw for positive alignment
- 5 1/2" Set Back from Transom
- 5" Vertical Adjustment
- Designed to fit standard B.I.A. bolt pattern without drill holes or making modifications in the boat or motor.



10" SET-BACK MODEL ML-65-10[®]
#61012



5 1/2" SET-BACK
MANUAL ML-65[®]
#65012



MANUAL ML-65SS
#65212

The ML-65 and the 4 and 5 1/2" set back plates are rated for V-6 and smaller motors. They are not designed for V8 or racing applications.

The ML-65SS is rated for V-8's and racing applications and is equipped with stainless steel motor rails.

With CMC, you can adjust your Power-Lift from the top or bottom!

The CMC manual Power-Lift provides the added convenience of adjusting from the top or the bottom. Most competitive brands can only be adjusted from the top.



TWO-PIECE DESIGN

The two-piece adjustable manual has 5 inches of slot adjustment at the motor mounting bracket and 1 1/2 inches of adjustment at the transom bracket.

5 1/2" Set Back #55012[®]
4" Set Back #40012[®]

Static Set Back Plates



The 7 INCH STATIC SET BACK PLATE

has 1 1/2 inches of adjustment at the transom bracket and 1 inch of adjustment on the motor bracket. The dimension from the top of the transom to the top of the motor side is 3 1/2 inches.

#70012*



The 9 INCH STATIC SET BACK PLATE

also has 1 1/2 inches of adjustment at the transom and 1 inch of adjustment on the motor bracket. The dimension from the top of the transom to the top of the motor side is 5 3/4 inches.

#90012*

MOUNTING HARDWARE INCLUDED WITH #70012, #90012, AND 65213 BUT NOT WITH #50012.

* These Models are rated for V-6 and smaller motors. Not designed for V-8 motors or racing applications.

The 5 INCH VERTICAL EXTENSION

allows the motor to be mounted 5 inches higher than the standard mounting on the transom. It is a must for conversion from prop to jet drive.

Another application includes mounting the 5 inch vertical extension on the hydraulic Power-Lift to raise the motor higher on shallow running boats that are equipped with tunnel extensions.

#50012*

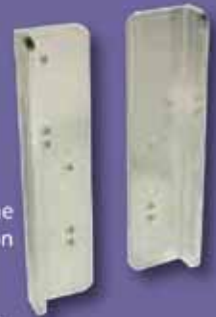

The 2-1/2 INCH STATIC SET BACK PLATE

has 1 1/2 inches of adjustment at the transom. It is most commonly used in conjunction with the manual or hydraulic Power-Lift to give a total of 8 inches of set back.

#65213*



Transom Jack Specifications

ITEM	DESCRIPTION	MOTOR HP RATING	TRAVEL	SET BACK	OPERATION	CONSTRUCTION	FASTENERS	DIMENSIONS	PRODUCT WEIGHT
61002	PL-65-10 w/o gauge	Up thru V-6	5"	10"	12V Elec Hydraulic	Extruded 6061-T6 Alum. Alloy	Stainless Steel	18-1/8"W x 16-1/2"H	56#
65002	PL-65 w/o gauge	Up thru V-6	5"	5 1/2"	12V Elec Hydraulic	Extruded 6061-T6 Alum. Alloy	Stainless Steel	18-1/8"W x 16-1/2"H	45#
65201	PL-65SS w/gauge	Up thru V-8	5"	5 1/2"	12V Elec Hydraulic	S.S. Motor Rails & 6061-T6 Alum.	Stainless Steel	18-1/8"W x 15-1/2"H	67#
65213	2-1/2" Set Back	Up thru V-6	1-1/2"	2-1/2"	Static	Extruded 6061-T6 Alum. Alloy	Stainless Steel	15-1/8"W x 13-5/8"H	11#
65012	ML-65	Up thru V-6	5"	5 1/2"	Manual	Extruded 6061-T6 Alum. Alloy	Stainless Steel	18-1/8"W x 15-1/2"H	32#
61012	ML-65-10	Up thru V-6	5"	10"	Manual	Extruded 6061-T6 Alum. Alloy	Stainless Steel	18-1/8"W x 15-1/2"H	43#
65212	ML-65SS	Up thru V-8	5"	5 1/2"	Manual	S.S. Motor Rails & 6061-T6 Alum.	Stainless Steel	18-1/8"W x 15-1/2"H	56#
55012	2-PC. Manual	Up thru V-6	5"	5 1/2"	Manual	Extruded 6061-T6 Alum. Alloy	Stainless Steel	18-1/8"W x 15-1/2"H (Mounted)	23#
40012	2-PC. Manual	Up thru V-6	5"	4"	Manual	Extruded 6061-T6 Alum. Alloy	Stainless Steel	18-1/8"W x 15-1/2"H (Mounted)	20#
70012	Static Set Back	Up thru V-6	3 1/2"	7"	Static	Extruded 6061-T6 Alum. Alloy	Stainless Steel	18-1/8"W x 15-1/2"H (Mounted)	30#
90012	Static Set Back	Up thru V-6	5 3/4"	9"	Static	Extruded 6061-T6 Alum. Alloy	Stainless Steel	18"W x 15-1/2"H (Mounted)	27#
50012	5" Vertical Ext.	Up thru V-6	5"	1/2"	Static	Extruded 6061-T6 Alum. Alloy	Stainless Steel	5"W x 20-1/2"H (Mounted)	14#

Specifications subject to change without notice.



Electric Hydraulic Tilt N' Trim

You Get Power Tilt & Trim, Better Boat Handling, More Speed, Lower Fuel Consumption and No More Back Strain!



PT-130 FEATURES:

- Rated for 130 H.P. and Smaller Motors.
- 6" Set Back to Enhance Boat Stability and Performance.
- 20° of Trim and a Total of 90° of Tilt and Trim.
- 1/2" 6061 T6 Extruded Aluminum Construction with Stainless Steel Fasteners.
- Electric Hydraulic Actuator Rated at 7853 lbs. of Thrust!
- Standard B.I.A. Bolt Hole Pattern.
- Convenient Adapter Kit Available for Clamp-on Motors.
- Four Stainless Steel Motor Mounting Bolts Included.



PT-35 FEATURES:

- Rated for 35 H.P. and Smaller Motors.
- 5 1/2" Set Back to Enhance Boat Stability and Performance.
- 84° of Trim and Tilt.
- 1/4" 6061 T6 Extruded Aluminum Construction with Stainless Steel Fasteners.
- Electric Hydraulic Actuator Rated at 7853 lbs. of Thrust!
- Accommodates Clamp-on or Bolt-on Motors Without the Need of an Adapter.
- Weighs Only 24 Pounds!

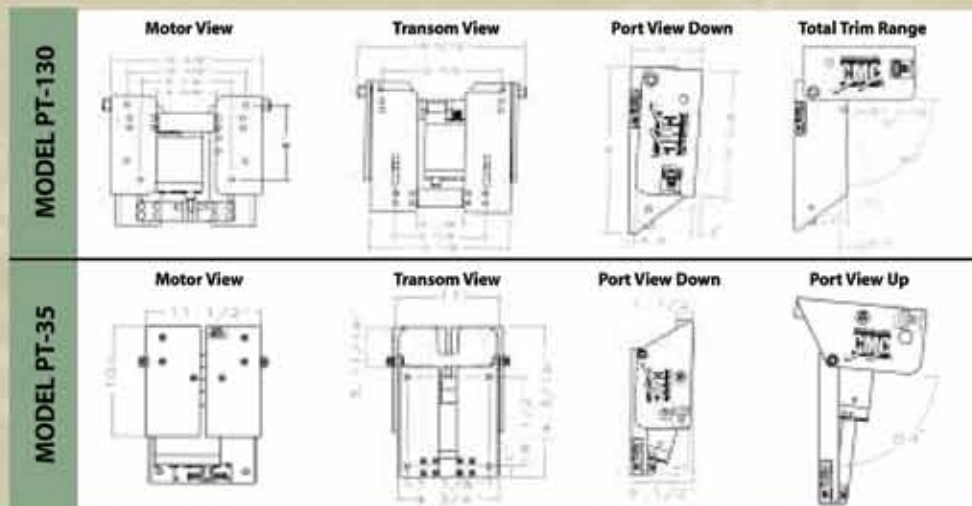

* The inside dimension of the motor mounting area of the PT-35 is 11 inches. Before ordering, please make sure that the maximum width of the clamp mounting feet and/or mounting bolts of the motor that must fit into this area does not exceed this 11 inch limit. Refer to the transom view drawings. Mounting bolts are not included with the PT-35.

TRANSOM CLAMP MOTOR ADAPTER

For installation of motors mounted with transom clamps, an adapter kit is available from CMC. This adapter kit is made for quick and easy installation of these type motors. The photo above shows this adapter on a PT-130 with a transom clamp motor. #13022



The optional tilt and trim gauge (not available with the PT-35) is sealed and drip proof and mounts in the dash of the boat for safe and convenient height determination. The sending unit is completely sealed and waterproof, which eliminates any moisture problems. The up-down toggle switch is standard equipment.

TRANSOM SPACER FOR PONTOON BOAT

The transom on some pontoon boats are inset with an aluminum lip along the sides. To conveniently mount the PT-130 to this type transom, this transom spacer is available. The transom spacers are 1 inch thick allowing you to mount the PT-130 without interference with the 1/2" to 3/4" lip around the transom on some pontoon boats. #13032



CMC BREAKAWAY UNIT

The CMC BA-130 Breakaway unit is designed for duck hunters and/or fisherman that use their boat in shallow stumpy areas. It allows small boats and motors to slide over submerged logs or debris at low speeds to get to a downed bird or your favorite fishing hole.

The BA-130 is rated for outboard motors up to a maximum of 130 H.P. The unit is mounted between the boat transom and the outboard motor. It is designed to help minimize damage to the outboard motor and boat transom only when an obstruction is encountered while running at speeds under 5 M.P.H. in the forward direction. As it encounters an obstruction momentum causes motor to deflect and rotate up to 45 degrees to slide over the obstruction. A drawbar spring is incorporated in the unit to help return the motor to its normal position while operating in the reverse direction at low R.P.M. The BA-130 is not designed to encounter obstructions while the boat is being operated in the reverse direction.

The unit is pre-drilled with the standard B.I.A. hole pattern. For motors that have clamps with thumb screws, CMC part # 13022 Transom Clamp Adapter is required. Product weight is 28 pounds (shipping weight is 33 pounds).



Tilt N' Trim Specifications

ITEM	DESC.	MOTOR HP RATING	TRAVEL	SET BACK	OPERATION	CONSTRUCTION	FASTENERS	PROD WT
13001	PT-130 w/gauge	10 HP thru 130 HP	90° Trim and Tilt	6"	12V Elec Hydraulic	Extruded 6061-T6 Alum. Alloy	Stainless Steel	40#
13002	PT-130 w/o gauge	10 HP thru 130 HP	90° Trim and Tilt	6"	12V Elec Hydraulic	Extruded 6061-T6 Alum. Alloy	Stainless Steel	39#
52100	PT-35	35 HP & Smaller	84° Trim and Tilt	5 1/2"	12V Elec Hydraulic	Extruded 6061-T6 Alum. Alloy	Stainless Steel	24#

Specifications subject to change without notice.

Alphabetical Index

A

Access Covers	5-7
Access Door - Designer Series	3
Access Hatches	3-4
Access Hatches, Designer Series	3
Adjustable Motor Support	49
Aeration Fitting, Directional	19
Aeration Kits, Baitwell	18
Aeration/Livewell Systems	19
Aerator Control	17
Aerator Filter	26
Aerator Head	19, 20
Aerator Pump Brackets	18
Aerator Pump Screens	27
Aerator Spray Head/ Wash Down Fitting	18
Aerator Screens	27
Aerator Timer	17
Aerator, Max-Air Venturi	16
Aerator, Pro-Air	16
Air Pump Aeration	16
Alarm - Two Way	48
All Purpose Drains	23
All Purpose Drains, Flat Head	23
All Purpose Strap	51
Anchor Handle Locks & Latches	2
Anchor Retriever	58
Aqua Clips / Utility Clips	58
Arm, Seacock Remote	31
Atlas™ Hydraulic Jack Plates	8
Atlas Micro Jacker™	9
Atlas Micro Jacker™ - Clamp on Adapter	9
Atlas™ Tilt 'N' Trim Units	9
Automatic Aerator Control	17

B

Bait Well Filter	26
Bait Well Kits	18
Ball Scupper	21
Battery Holder for Optima	52
Battery Holders	52-53
Battery Tray Accessories	52
Battery Tray, Frame Top	53
Battery Trays	52-53
Battery Trays - Combo 24-27 Ser.	53
Boat Cargo Nets	48
Boat Engine Winterizer	57
Bolt Caps	58
Bolt Kit, Jack Plate	11
Boots, Cable	39
Boxes - Drop In & Tackle Tray	4
Brackets, Cooler Mounting	51
Brite Plate Chrome Plated Parts	19
Brite Plate Chrome - Splash Well Drain	24
Bulb, Courtesy Light Replacement	46
Bulb, Headlight Replacement	47
Bulb - LED Replacement	46
Bulkhead Pass-Thru Fitting	28
Bulkhead Strain Relief Kit	36
Bungee/Shock Cord Material	54
Butt Splices	56

C

Cable Boot Rings	39
Cable Boots	39
Cable Boot Grommets	39
Cable Boot - Split	40
Cable Pass-Thru Grommets	39
Cable Ties	37
Cams, Anchor Lock, Zinc & Stainless	2
Cam Lock Deck Plates	5
Caps, Black Vinyl	33, 58
Cargo Nets	48
CeaCap™ Bulkhead Fitting	27

Chrome Plated Parts	19
Circuit Breaker Kit, Trolling Motors	34
Clam Shell Vents	40
Clamp-On Outboard Adapter for Micro Jacker™	9
Clamps, Hose	37, 38
Cleats	56
Clips, Aqua/Utility	58
Clips, Navigation Light	47
Clips, Trailering	49
CMC Jack Plates	59-65
CMC Tilt 'N' Trim Units	59-65
Cockpit Drain	20-21
Cooler Mounting Kit	51
Courtesy Lights	46-47
Courtesy Lights - LED Models	44, 46
Courtesy Lights - Oval w/Switch	47
Courtesy Light Switch	46
Cover, Wire	39
Covers, Access	5-6
Covers, Vent	24
Culling System, G-Force	35
Cup Holders	50
Cup Holder, Robo Cup	50
Cup Holder, Stainless Steel	50

D

Deck Drains	20-21
Deck Lid Slam Latch	2
Deck Plates	5, 6
Deck Plates, Low Profile Twist Out	5, 6
Deck Plates, Quick Release Cam	5
Decorative Wire Covers	39
Designer Series Hatches	3
Digital Gauge Kits for Atlas™ Series Jacks	8
Directional Flow Aerator Heads	19
Door Latch	2
Door Stops	54
Door Strap	7
Double Flusher	48
Drain Caps, Rod Holders	33
Drain Control Valves	31
Drain Filter	21, 25
Drain Plug	25, 26
Drain Tube	25
Drain Tubes, Livewell Overflow	25
Drain, All Purpose	23
Drain, All Purpose, Threaded	23
Drain, Cockpit	20
Drain, Deck	20
Drain, Flapper Scupper	21-22
Drain, Flex Flange	23
Drain, Floor	24
Drain, Hatch	23
Drain, Impact	23
Drain, Push-In	23
Drain, Rod Holder	33
Drain, Scupper	21-22
Drain, Seat Pedestal	24
Drain, Splash Well	23
Drop In Boxes	5
Dual Battery Tray	52
Duckbill Scupper	22

E-F

Elbow Fittings	29
Emergency Reboarding Ladder	12
End Caps	58
Engine Flush Kits	48
Engine Jacks	8-11
Extension Handle	35
Eye Straps	54
EZ Pump™ - Advanced Water Pick Up System	17

Fastener, Windshield	50
Filter, Aerator	26
Filter, Bait Well	26
Filter, Drain	21, 25
Filter, Overflow Drain	25
FingerFlex, Trim Control for Hydraulic Steering	12
Finger Pincher Guard, Pontoon	55
Fishing Accessories Section	32-35
Fishing Rod Holders	32-34
Fitting, CeaCap™	27
Fittings, Bulkhead Pass-Thru	27
Fittings, Hose	28
Fittings, Plumbing	28, 30
Fittings, Rub Rail	56
Fittings, Thru-Hull	28
Fittings, Wash Down	18
Flange, Rigging	19, 37
Flange – Rigging Hose Union	37
Flange – Rigging w/Fuel Hose Port	37
Flange – Tri Shape Rigging	37
Flange, Utility	40
Flange, Vent Hose	39
Flex Sleeving	36
Flex Strip Rope, LED Lights	45
Floor Drain	24
Floor Drain/Lid Pull Combo	24
Flow-Max™ Ball Scupper	21
Flusher for Twin Outboards	48
Foam Rod Holders	32
Foaming Hole Plug	20
Foot Control Switch	35
Foot Throttle	13
Foot Throttle Mount	13
Foot Trim Controls	12
Footman's Loops	54
Fuel Container Hold-Down	51
Fuel Splash Guard	55

G

G-Force Handle	35
G-Force Culling System	35
Garboard Drain Plug	26
Garboard Drain Wrench	58
Gaskets for Thru Hulls	29
Gate Holder	55
Gate Latches	54-55
Gate Latch, Pontoon, Saf-T-Stop™	55
Gauge Kit for Hydro Jacker Jacks	10
Glove Box, Designer Series	4
Glove Box, Locking	4
Grommet, Cable Boot	39
Grommet, Cable Pass-Thru	39
Grommet, Oval	40
Grommet, Rope	40
Grommet, Rod	32
Grommet, Utility	40
Grab Handles	58

H

Handle, G-Force	35
Handles, Grab	58
Hatch Drain	23
Hatch Lift Pin	7
Hatch Spring	7
Hatches, Designer Series	3
Hatches - Designer Series - Locking	3
Hatches, Plates & Lids Section	2-7
Head Light Brackets	47
Head Lights	47
Hi-Jacker Jack Plates	11
Holder, Battery	52-53
Holder, Cup	50
Holder, Navigation Light	47
Holder, Pedestal	49
Holder, Pontoon Gate	54-55

Holder, Rod	32-33
Holder, Spare Propeller	51
Holders - Oval Top	34
Hole Shot Plate, Hot Shot™	9
Hooks for Shock Cord	54
Hose Clamps	37
Hose Clamps, Oetiker	38
Hose Elbows	29
Hose Flange, Ventilation	48
Hose Holder - Stick 'N' Spray	57
Hose Reducers	29
Hose Tees	29
Hose, Rigging	37
Hose, Coiled Wash Down	57
Hot Foot™ Slide Mount	13
Hot Shot™ Hole Shot Plates for Atlas™ Series Jack	9
Hot Shot™ Hole Plates for Z-Lock	10
Hot Trim Foot Trim Control	12
Hot Foot™ Throttle	13
Hydraulic Hose Strain Relief Fitting	36
Hydraulic Jack Plate	8-11
Hydraulic Jack Plate, High Speed	8-11
Hydro-Jacker™ Hydraulic Jack Plate	10
Hydro-Jacker HS™ – Hi Speed Hydraulic Jack Plate	9
Hydro-Jacker™ Gauge Kit	10
Hydro-Tail Stabilizer	15
Hose/Wire Hanger	39

I-J-K-L

Ignition Cutoff Switch	15
Impact Drains	23
Inline Scupper	21
I/O Winterizer	57
Jack Plate - Atlas Micro Jacker™	9
Jack Plate Hardware	11
Jack Plate, Hole Shot Plate, Hot Shot™	8
Jack Plate - Hydraulic – High Speed	9
Jack Plate, Hydro-Jacker™ Hydraulic Jack Plate	10
Jack Plates	8-11
Jack Plates - Manual - Z-Lock	10
Kill Switch	15
Kill Switch Lanyard	15
Ladder - Emergency Reboarding	12
Large 3-Finger Lid Lift	7
Latches, Gate	54-55
Latches, Large Lid Slam	2
Latches, Lid	2
LED Bulb – Replacements	46
LED Companion Way Light	43
LED Courtesy Companion Way Light	43
LED Courtesy Light – Black Face	46
LED Lighting	41-46
LED Livewell Light	46
LED Mini Courtesy Light	46
LED Oblong Courtesy Light	41
LED Rail Light	44
LED Spreader Light	45
LED Super Spreader Light	45
LED Underwater Light	41
LED – Flex Strip Rope Light	45
LED – Flush Head Livewell Light	44
LED – Mini Dual Mount Courtesy Light	44
LED – Recessed Puck Light	42
LED – Slim Line Utility Strip Light	41
LED – Stainless Puck Light	42
LED Surface Mount Dome Light	42
Lid Accessories	2-7
Lid Latches	2
Lid Lifts	7
Lid Lifts – Large 3-Finger	7
Lid Locks	2
Lid Pull/Floor Drain Combo	24
Lid Spring	7
Lid Strap	7
Lift Pin, Hatch	7
Lifts, Lid	7

Light Clips47
 Lights, Courtesy44, 46, 47
 Lights, Head Lights47
 Lights, Livewell46
 Lights – Shark Eye Navigation Set46
 Lights, Trailer Backing47
 Liners Hatch5
 Livewell Drain Tubes26
 Livewell Fitting, Directional19, 20
 Livewell Light46
 Livewell Lights – LED Models46
 Livewell Light, Mini LED46
 Livewell Overflow / Utility Storage Clips26
 Livewell, Remote Drain31
 Lock, Hydraulic Steering52
 Locks, Lid2
 Low Clearance Thru-hull28

M-N-O

Manifold System Parts30
 Marine Accessories Section47-58
 Max-Air Venturi Aerator16
 Mini-Jacker11
 Motor Stik™ - Outboard Motor Support49
 Motor Support49
 Motor Support, I/O49
 Motor Support, Outboard49
 Mounts, Cooler51
 Narrow Mount Battery Trays52-53
 Nav Lights - Shark Eye LED46
 Navigation Light Set – Shark Eye Style46
 Nose Cones14
 Nozzles, Wash Down57
 Organizer, Rod Storage32
 Oetiker® Hose Clamps38
 Oetiker® Hose Clamp Kit38
 Oetiker® Stepless® Ear Hose Clamps38
 Outboard Flush Kits48
 Oval Courtesy Light w/Switch47
 Oval Deck Plates6
 Oval Grommet40
 Overflow Drain Thru-Hull25
 Overflow Drain Tubes25
 Overflow Fittings25

P-Q

Paddle Keeper51
 Pedestal Holders49
 Performance and Safety Items8-15
 Pickup, Water17-18
 Plates, Jacking8-11
 Plug, Drain25
 Plug, Foaming Hole20
 Plug, Thru-Hull25
 Plumbing & Drain Section16-31
 Plumbing Fittings16, 29, 30
 Pontoon Door Stop54
 Pontoon Finger Pincher Guard55
 Pontoon Gate Holder54-55
 Pontoon Gate Latch54-55
 Pontoon Rail Shims55
 Pro-Air System16
 Pro Hi-Jacker Jack Plates10
 Prop-Master Wrench58
 Propeller Retainer51
 Propeller Wrench58
 Pump Bracket18
 Push-In Drain23
 Push-In Aerator Screens27
 Quick Flush, Outboard Flush Kit48
 Quik Plumb™ Threaded Plumbing Parts16
 Quick Release Deck Plates5

R

Radiused Cable Ties37
 Ranger Style Trolling Motor Plugs35
 Reboarding Ladder12
 Recessed Scupper Drain22
 Rectangular Scupper21
 Reducer, Hose29
 Reducer Fittings, Manifold30
 Reducing Tee Fittings29
 Remote Diverter Valve31
 Remote Drain Valve31
 Remote Seacock Arm31
 Replacement LED Bulb46
 Retriever, Anchor58
 Reverse Transom Wedge – 1 Pair13
 Rigging Flange19, 37
 Rigging Flange, Chrome Plated19, 37
 Rigging Flange, Tri-Shape37
 Rigging Flange Hose Union36
 Rigging Flange w/Fuel Port36
 Rigging Hoses36-37
 Rigging Sleeve, Zippered36
 Robo Cup® Holder/Rod Holder50
 Rod Grommets33
 Rod Hold-Down Strap33
 Rod Holder Drain Caps33
 Rod Holders32-34
 Rod Holder - Robo Cup®50
 Rod Port Light5
 Rod Racks33
 Rod Storage Holders, Foam32
 Rod Storage Organizers32
 Rod Storage Tubes32
 Rod Straps, Retracting Poly33
 Rod Tamer Straps33
 Rod Tube End33
 Rope Grommet40
 Rub Rail Fittings56

S

Saf-T-Stop™ Pontoon Dead Bolt Gate Latch55
 Scoop, Water Pickup17
 Screen, Aerator26
 Screen, Drain26
 Screw Down Plates - Designer Series6
 Scupper, Ball21
 Scupper Drain21-22
 Scupper, Duckbill22
 Scupper, Flapper-Type21-22
 Scupper, Inline21
 Scupper, Large Rectangular21
 Scupper, Recessed Thru-Hull22
 Scupper, Recessed Thru-Hull Chrome19
 Scupper, Repair Kit22
 Scupper, Transom Drain, Flat Bottom23
 Seat Pedestal Drain24
 Seacock Remote Arm31
 Shark Eye Nav Lights, LED46
 Shark Eye Navigation Light Set46
 Shims, Pontoon Rail54
 Shock Cord54
 Skeg, Replacement14
 Slam Latch – Large Deck Lids2
 Sleeving, Flex36
 Spacers, Transom14
 Spanner Head Thru-Hull28
 Spare Propeller Retainer51
 Splash Guard, Fuel55
 Splash Well Drain – Brite Plate Chrome23
 Splash Well Drain Tube23
 Spray Heads18-20
 Springs, Hatch and Lid7
 Stabilizers15
 Stainless Steel Cup Holder50

Steering Console Mount.....	56
Steering Wheel Trim.....	12
Steer-Stop™ Hydraulic Steering Lock.....	52
Stick 'N' Spray Hose Holder.....	57
Storage Tubes.....	7
Strainer, Aerator.....	26, 27
Strain Relief Fitting.....	36
Strap, All Purpose.....	51
Strap, Battery Tray.....	52
Straps, Lid or Door.....	7
Straps, Rod.....	33
Support, Motor.....	49
Sure Foot - Foot Switch.....	35
Sure Seal™ Hatches.....	4
Sure Seal™ Deck Plates.....	6
Switch, Courtesy Light.....	46
Switch, Foot Control.....	35
Switch, Kill.....	15

T

Tackle Tray Organizer.....	4
T-H FLEX.....	36
Tee Fittings.....	29
Threaded Plumbing Parts.....	16
Throttle Control Mount.....	56
Throttle, Hot Foot.....	12
Thru-Hull Fittings.....	28
Thru-Hull Chrome Plated Fittings.....	19
Thru-Hull Gaskets.....	29
Thru-Hull Plug.....	24
Thru-Hull Strainer Mount.....	27
Thru-Hull Washer.....	29
Thru-Hulls, Chrome Plated.....	19
Thru-Hulls, Extended.....	28
Thru-Hulls, Ninety Degree.....	28
Thru-Hulls, Straight.....	28
Thru-Hulls, Threaded.....	25
Thru-Hulls, Unique.....	28
Ties, Cable and Wire.....	37
Timer, Aerator.....	17
Tilt N' Trim Units - Atlas™.....	9
Torque Tabs.....	15
Trailer Backing Lights.....	47
Trailer Clips.....	49
Transom Drain, Flat w/Scupper.....	23
Transom Spacers.....	14
Transom Support Plate.....	14
Transom Trim Control.....	12
Transom Wedges.....	13
Transom Wedges - Reverse - 5 Degree Tilt.....	13
Trays, Battery.....	52-53
Tri Shape Rigging Flange.....	37
Trim Controls.....	12
Trim, Foot Trims.....	12
Trim, Handle Trim.....	12
Trim, Steering Wheel.....	12
Trim, Transom Mount.....	12
Trolling Motor Accessories.....	34, 35
Trolling Motor Circuit Breaker Kit.....	34
Trolling Motor Mount.....	34
Trolling Motor Power Plugs.....	35
Tube Ends, Rod.....	33
Tube, Rod Storage.....	32
Tube, Storage.....	6
Two-Way Boat Alarm.....	48

U-V-W-X-Y-Z

Utility Grommet.....	40
Utility Light Clip.....	47
Valve, Diverter.....	31
Valve, Drain Control.....	37
Valve, Drain Control, Threaded.....	16
Valve, Replacement.....	31
Vent, Clam Shell.....	40
Vent Grill Cover, Blower.....	24
Vent Covers.....	24
Vent Hose Flange.....	39
Vents - Oval.....	24
Venturi Aerator.....	16
Venturi Aerator, Threaded.....	16
Versatubes.....	6
Vinyl Caps.....	32, 58
Wash Down/Aerator Spray Head Fitting.....	18
Wash Down Coiled Hose & Nozzles.....	57
Wash-Down Fitting.....	18
Washdown Hose Holder w-25' Hose & Nozzle.....	57
Wash Down Station w/ Hose.....	57
Washer, Thru-Hull.....	29
Water Pick-Up System, EZ Pump™.....	17
Water Scoop Pickup.....	17
Wedge - Transom.....	13
Windshield Fastener.....	50
WINTER-EZE(TM).....	57
Winterizer, I/O Engine.....	57
Wire Covers.....	39
Wire/Hose Hanger.....	39
Wire Ties.....	39
Wiring Accessories.....	39-40
Wrench, Propeller.....	50
Y-Fitting.....	29
Z-Lock Hot Shot™ Hole Shot Plates.....	10
Z-Lock Manual Jack Plates.....	10
Zippered Rigging Sleeve.....	36

PART #	PAGE	PART #	PAGE	PART #	PAGE	PART #	PAGE
FA-3/4	29	HC-28	37	LED-51824-DP	41	MS-3RB11434	30
FA-90	29	HDDS-1620-"X"LV	3	LED-51825-DP	41	MS-3TT100	30
FAGK-1-DP	8	HDS-0714-"X"	3	LED-51827-DP	42	MS-3TT112	30
FAGK-2-DP	8	HDS-1115-"X"	3	LED-51828-DP	42	MS-3TT114	30
FAGK-ISS-DP	8	HDS-1119-"X"	3	LED-51897-DP	42	MS-3TT34	30
FAGK-2SS-DP	8	HDS-1119-"X"-REM	3	LED-51831-DP	42	MSS-1	49
FCH-1	51	HDS-1317-"X"	3	LED-51832-DP	42	MSS-1CD	49
FCS-1	35	HDS-1317-"X"-REM	3	LED-51829-DP	42	NBH-24-SSC	52
FCS-2	35	HDS-1324-"X"	3	LED-51830-DP	42	NBH-27-SSC	52
FD-2	24	HDS-1324-"X"-REM	3	LED-51847-DP	42	NBH-31-SSC	52
FD-2W	24	HDS-1330-"X"	3	LED-51848-DP	42	NBH-24P	53
FD-2FW	24	HDS-1330-"X"-REM	3	LED-51849-DP	42	NBH-27P	53
FD-2T	24	HDS-1620-"X"	3	LED-51857-DP	44	NBH-31P	53
FD-4	24	HDSL-1115X	3	LED-51858-DP	44	NBH-24S	53
FD-4W	24	HDSL-1324X	3	LED-51866-DP	41	NBH-27S	53
FD-4FW	24	HF-1-DP	13	LED-51867-DP	41	NBH-31S	53
FD-4T	24	HF-1CT-DP	13	LED-51868-DP	41	NBH-31-SSC-OPT	53
FDP-4T	24	HF-1T-DP	13	LED-51874-DP	44	NBHC-247P	53
FDP-4WS	24	HFM-1	13	LED-51875-DP	44	NBHC-247S	53
FF-150	25	HFS-1-DP	13	LED-51876-DP	43	NBHI-1	53
FFTb-1	12	HHSC-1-DP	57	LED-51880-DP	44	NC-1-DP	14
FFTb-2	12	HL-1-DP	47	LED-51888-DP	45	NFSL-1-X	2
FG-150	25	HLB-1-DP	47	LED-51891-DP	43	NFSL-1-X	2
FHP-2RG	20	HLRB-1	47	LED-51894-DP	43	NFSL-3-X	2
FL-1	54	HP-1	7	LED-51914-DP	45	NFSL-4-X	2
FLX-25-DP	36	HP-2	7	LED-51946	45	NFSL-5-X	2
FLX-50-DP	36	HP-3	7	LED-51947	45	NRL-1	2
FLX-75-DP	36	HS-1	7	LED-51948	45	NRL-2	2
FLX-125-DP	36	HS-1C	7	LED-51949	45	OCL-1	47
FLX-150-DP	36	HS-3C	7	LED-51950	45	OCL-1	47
FLX-200-DP	36	HT-1	12	LED-51951	45	OCLR-1	47
FLXB-25	36	HYD-1-DP	15	LED-51952	45	OCLR-2	47
FLXB-50	36	HYJ-6C-DP	10	LED-51965	45	ODT-1	25
FLXB-75	36	HYJ-10C-DP	10	LED-51953	45	ODT-1-??-GSTW	25
FLXB-125	36	HYJ-6HSC-DP	9	LED-51954	45	ODT-1-??-TW	25
FLXB-150	36	HYJ-10HSC-DP	9	LED-51955	45	ODT-190-??	25
FMS-1-0	21	ILS-1500 (Replaces ILS-1)	21	LED-51966	45	ODT-190	25
FRH-1	32	ILS-1200	21	LED-51956	45	ODT-2	25
FRH-1P-DP	32	ILS-750	21	LED-51957	45	ODT-2??	25
FRSK-1-DP	22	IPD-1000	23	LEDBULB-1	46	ODT-2T	25
FSG-1	55	IPD-1000-5	23	LEDBULB-1A	46	ODT-2T??	25
FSG-1XL	55	IPD-1002	23	LEDBULB-1R	46	ODT-290	25
FSG-2	55	IPD-580	23	LL-1	7	ODT-290-??	25
FSG-2XL	55	IPD-582	23	LL-2	7	ODTS-1	25
FSG-3	55	IPD-582-BARB	23	LLM-1	7	ODTS-2	25
FSG-3XL	55	JP-1A-DP	11	LLM-2	7	OG-1	40
FSG-6-39	55	JP-4FA-DP	11	LLM-3	7	PAP-1	16
FSG-7	55	JP-6PW-DP	10	LLR-1	7	PAS-1	16
FSG-8	55	JP-ADJ-BOLT	10	LLR-2	7	PAS-2	16
FSRK-1-DP	22	JPZ-6-DP	10	LLR-3	7	PAS-3	16
GDP-1	26	JPZ-8-DP	10	LRS-2	21	PB-90	18
GDP-1-CB	26	JPZ-10-DP	10	LRS-3	21	PCORD-14B	54
GDS4-0714-X	4	JPZHSP-6	10	LS-1	7	PD-1	23
GDSL-0714-1	4	JPZHSP-8	10	LS-2	7	PD-2	23
GDSL-0714-2	4	JPZHSP-10	10	LS-2C	7	PPG-1G	55
GFC-1-DP	35	KMB-8-DP	11	LS-3	7	PH-1	49
GFH-1R-DP	35	KMB-12-DP	11	LV-1	24	PH-2	49
GFH-1G-DP	35	KMB-20-DP	11	LV-1FW	24	PH-3	33,49
GH-1B	55	KS-1	15	LV-1S	24	PH-3FW	32,49
GH-1G	55	KS-2	15	LWL-1	46	PH-3S	32,49
GHB-1	58	KS-12	15	LWL-1P-LED	46	PH-3-Y-X	32
GHB-1FW	58	KS-22	15	LWLM-1P-LED	46	PH-3O	33
GHB-1T	58	L-4	15	MAV-2	16	PK-1-DP	51
GHB-1G	58	LCH-1	50	MAV-2K	16	PL-65	61
GL-1	54	LCH-1SS	50	MAV-2KDT	16	PL-65HS	62
GL-2	54	LCH-1T	50	MAV-2KT	16	PL-65SS	61
GLSS-2	54	LCH-1W	50	MAV-FACEPLATE	16	PL-65-10	61
GT-1.375	32	LCH-1WS	50	MJ-1-DP	11	PL-65-10HS	61
GT-1.700	32	LCH-2	50	ML-65	66	PMW-1	58
GT-2.250	32	LCH-2W	50	ML-65-10	66	PP-118	23,25
HAT-1115-X	4	LCH-2WS	50	ML-65SS	66	PP-125	25
HAT-1317-X	4	LCH-2T	50	MS-3A10034	30	PP-150	25,27
HAT-1324-X	4	LED-51800-DP	41	MS-3A112	30	PRB-1	51
HAT-1330-X	4	LED-51801-DP	41	MS-3A11434	30	PRR-1	51
HATL-1115-X	4	LED-51803-DP	41	MS-3A1234	30	PT-35	64
HATL-1317-X	4	LED-51805-DP	41	MS-3A34	30	PT-130	64
HATL-1324-X	4	LED-51806-DP	41	MS-3EL1234	30	QF-1K	48
HATL-1330-X	4	LED-51810-DP	41	MS3EL34	30	QF-2K	48
HC-4	37	LED-51810-DP	41	MS-3EL1238	30	QFC-1	48
HC-6	37	LED-51811-DP	41	MS-3M100	30	QFV-1	48
HC-8	37	LED-51816-DP	43	MS-3M112	30	QFV-2	48
HC-10	37	LED-51819-DP	43	MS-3M114	30	RDC-1	31
HC-12	37	LED-51818-DP	43	MS-3M34	30	RDC-190	31
HC-16	37	LED-51820-DP	43	MS-3RB10034	30	RDCF-1	31
HC-24	37	LED-51822-DP	43	MS-3RB11234	30		
		LED-51823-DP	41				

PART #	PAGE	PART #	PAGE	PART #	PAGE	PART #	PAGE
RDCF-190	31	RVG-4-2	24	TEO-2.50-Y-X	32,33	THSM-1KIT	27
RDCF-250	31	RVG-4-3	24	TEO-3.00-Y-X	32,33	THT-35C-DP	9
RDDL-1	31	SA-1	22	TH-1	28	THT-130C-DP	9
RDSL-1	31	SA-2	22	TH-1XL	28	THT-130CGK-DP	9
RDV-150	31	SA-2B	22	TH-1000	28	THW-1	29
RDV-2	31	SA-3	22	TH-1002	28	THW-1200	29
RDV-2DT	16	SCB-527	31	TH-1200	28	THW-1500	29
RF-1	37	SCM-2-DP	56	TH-1200CP	19	THW-750	29
RF-1CP	19,37	SDP-1	6	TH-1200T	25	TMBMP-1	35
RF-2	37	SDP-1-X	6	TH-1200XL	28	TMFR-1	35
RF-2.5-1	37	SDP-1FW	6	TH-1200XLC	19	TMM-1-DP	34
RFFHP-1	36	SDP-1S	6	TH-1200XLT	25	TMRCP-1	35
RFFHP-2	36	SDP-1T	6	TH-1202	28	TS-1-DP	14
RFH-1	37	SDP-1W	6	TH-1202XL	28	TSP-1	14
RFH-2	37	SDP-2	6	TH-1290	28	TSP-2	14
RFH-2.5-1	37	SDP-2-X	6	TH-1290CP	19	TSP-1C	14
RFHU-1	36	SDP-2FW	6	TH-1290S	28	TSP-1CP	14
RFHU-2	36	SDP-2S	6	TH-1290T	25	TSP-3	14
RFK-1-DP	37	SDP-2T	6	TH-1292	28	TSP-7	14
RFK-1CP-DP	37	SDP-2W	6	TH-1292S	28	TTC-1	12
RFS-1	22	SDP-3	6	TH-1500	28	TTRAY-3600	4
RFS-1L	22	SDP-3-X	6	TH-1500AFD	27	TTRAY-3700	4
RFS-2	22	SDP-3FW	6	TH-1500CP	19	TW-2	13
RFS-2L	22	SDP-3T	6	TH-1500XL	28	TW-3	13
RFT-1	37	SDP-3W	6	TH-1500XLC	19	TWA-1-DP	48
RFT-1KIT	37	SEACOCK-18.5	31	TH-1500XS	28	TWAR-1-DP	48
RFTH-1	22	SEACOCK-24	31	TH-1502	28	UC-1	26
RFTH-1XS	22	SEL-1-DP	46	TH-1502F	25	UG-1	33,40
RFTH-2	22	SEL-1LED-DP	46	TH-1502FF	23	UG-1W	40
RFTH-2XS	22	SPA-250G	55	TH-1502G	21	UG-1FW	40
RFTH-2002B	22	SPA-375G	55	TH-1502S2	28	UG-2	33,40
RFTH-2B	19	SPA-500G	55	TH-1502S2N	28	UG-2FW	33
RFTH-2BCP	19,22	SPD-1	24	TH-1502T	25	UG-2W	33
RFSPA-1502	22	SPD-2.25	24	TH-1502XL	28	UG-3	33,40
RFSPA-2000	22	SPD-2.75	24	TH-1502XS	28	UG-3FW	33
RG-1	40	SR-1	56	TH-1590	28	UG-3W	33
RG-1FW	40	SR-1W	56	TH-1590AFD	27	ULC-1	26,47
RH-1	34	SR-2	56	TH-1590CP	19	ULC-2	47
RH-1FW	34	SR-6	56	TH-1592	28	VCAP-250	58
RH-1W	34	SS-1	52	TH-1592F	25	VCAP-500	58
RH-2	34	SS-2	53	TH-1592G	21	VCAP-1.375	32,58
RH-2FW	34	ST-1	13	TH-1592T	25	VCAP-1.687	32,58
RH-2P	49	STRAP-12BWS	51	TH-1890	28	VCAP-2.125	32,58
RH-2W	34	SWD-1	23	TH-1890CP	19	VHF-3	39
RH-4	34	SWD-1W	23	TH-1890T	19,31	VHF-3VWS	39
RH-4FW	34	SWD-2	23	TH-1892	28	VHF-4	39
RH-4W	34	SWD-2W	23	TH-1992	20	VHF-4WS	39
RHBD-1	33	SWD-3	23	TH-1992BHS	20	VT-8-X	6
RHBD-2SS	33	SWD-3W	23	TH-1992FH	20	VT-12-X	6
RHBD-2SST	33	SWD-3WCP	23	TH-1992FHR	20	VT-27-X	6
RHD-1	33	SWD-4	23	TH-1992FHS	20	WD-1	18
RHD-2	33	SWD-4WCP	23	TH-1992R	20	WD-1CP	18
RHDN-1	33	SWD-4W	23	TH-1992S	20	WDH-15B-"Y"	57
RHDN-2	33	SWD-5	23	TH-2092	20	WDH-15V-"Y"	57
RHRB-2B	34	T-1	16	TH-2092R	20	WDH-25B-"Y"	57
RHRB-3B	34	TAB-1	15	TH-2092S	20	WDH-25V-"Y"	57
RHRFW-2FW	34	TBL-1	47	TH-35	28	WDHH-25B-C-DP	57
RHRFW-3FW	34	TBOX-1115-X	4	TH-500	28	WDHH-25W-C-DP	57
RHRW-2W	34	TBOX-1115-3T-X	4	TH-502	28	WDN-1	57
RHRW-3W	34	TBOX-1317-X	4	TH-650	28	WDN-2	57
RH-3B	34	TBOX-1317-3T-X	4	TH-652	28	WDSB-"X"-"Y"	57
RH-3FW	34	TC-1-DP	49	TH-750	28	WDSW-"X"-"Y"	57
RH-3W	34	TCM-1-DP	56	TH-750CP	19	WDV-90	18
RHS-3B	34	TDS-0714-"X"	4	TH-750DT	16	WDV-1	18
RHS-3FW	34	TDS-1115-"X"	4	TH-750XL	28	WDV-1CP	18
RHS-3W	34	TDS-1317-"X"	4	TH-750XLC	19	WEZ-1-DP	57
RHSF-3B	34	TDS-1330-"X"	4	TH-752	28	WHH-1	39
RHSF-3FW	34	TDS-0714-2T-"X"	4	TH-752-BHF	28	WHH-1KIT-DP	39
RHSF-3W	34	TDS-1115-3T-"X"	4	TH-752DT	16	WS-1	17
RL-1	2	TDS-1317-4T-"X"	4	TH-752XL	28	WSH-1	50
RL-2	2	TDS-1330-4T-"X"	4	TH-7590	28	WSH-1F	50
ROBCP-1-DP	50	TE-1	32,49	TH-7590CP	19	Y-118	29
ROBCP-2-DP	50	TE-1FW	32	TH-7590S	28	Y-630	29
RS-1-DP	14	TE-1S	32,53	TH-7592	28	Y-750	29
RS-2-DP	14	TE-1W	32,53	TH-90	28	ZRS-1	36
RS-3-DP	14	TEC-1	56	TH-90DT	16	ZRS-2	36
RS-4-DP	14	TEE-1/8	29	TH-92	28	ZRS-5	36
RT-14	33	TEE-1/2	29	TH-CC-1	27		
RT-18	33	TEE-1/8	29	TH-CC-2	27		
RTHOOK-1	54	TEE-150	29	TH-DFR-1290	19		
RTSM-1	54	TEE-250	29	TH-DFR-1292	19		
RVG-3-1	24	TEE-350	29	TH-DFR-7590	19		
RVG-3-2	24	TEE-3/4	29	TH-DFR-7592	19		
RVG-3-2	24	TEE-3/8	29	THSM-1	27		
RVG-4-1	24	TEE-5/8	29	THSM-1XL	27		