

Daniamant

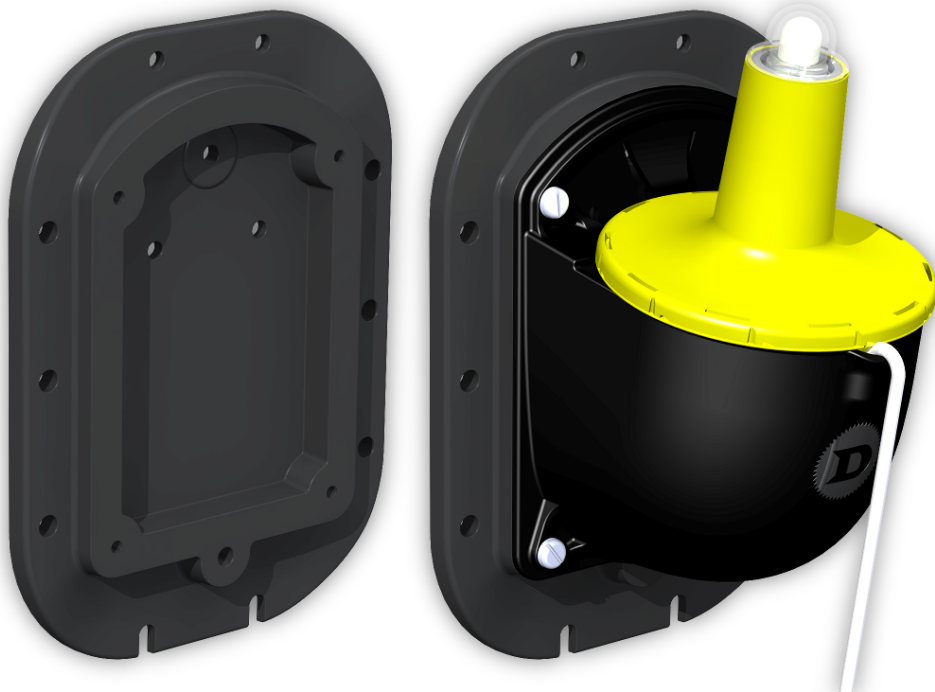

L160, L161, L162 and L163 Mounting Adapter Plate

Installation and Maintenance Instructions



Description

This Mounting Adapter Plate is designed to aid fitting the L160, L161, L162 or L163 bracket using the holes from an existing L40, L41B, L120 or L90 lifebuoy light bracket.

Installation

Remove the existing mounting bracket. If the original fixings are in a serviceable condition, they can be re-used, otherwise replace with new similar fixings.

Align the Mounting Adapter plate with the existing holes, and fix. Make sure that the plate is the correct way up. Refer to the picture on the front of this manual.

Attach the L160, L161, L162 or L163 bracket using the supplied self tapping screws.

Complete the installation in accordance with the instructions supplied with the lifebuoy light.

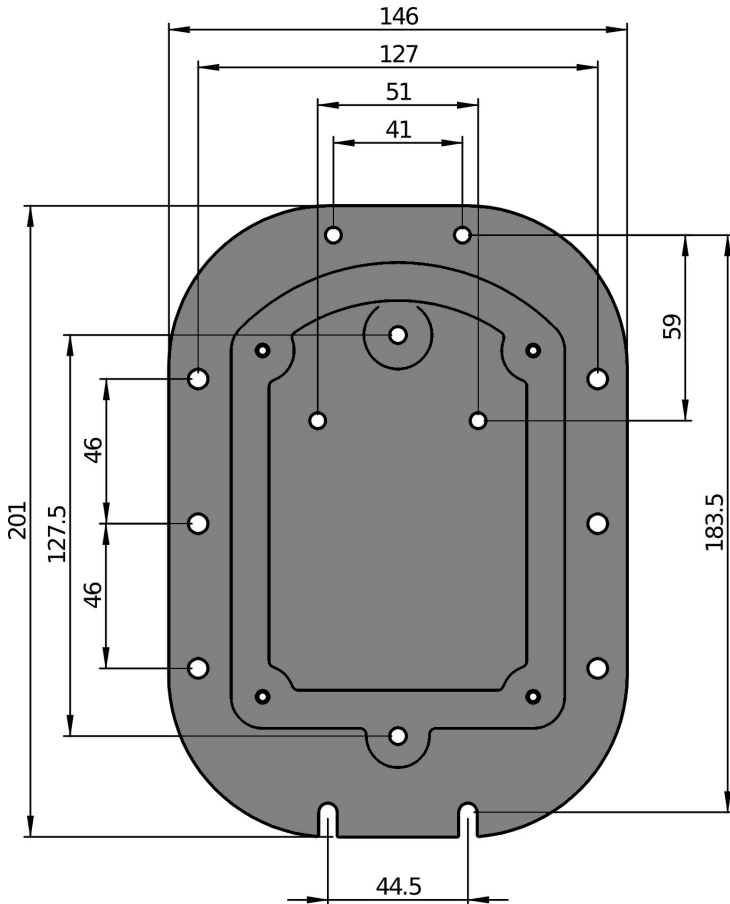

Maintenance

As part of the regular service of the attached lifebuoy light, an inspection of the Mounting Adapter Plate should be conducted.

Make sure that the lifebuoy light bracket is firmly attached to the adapter plate, and that the adapter plate is firmly affixed to the supporting structure.

If any fixing has become loose or damaged, then it needs to be made good. Also, if the adapter plate is damaged such that it would impair its function, then it should be replaced.