

Daniamant



L6A-Ex Lifejacket Light

Installation and Maintenance Instructions



Description

The L6A-Ex is a flashing lifejacket light which is activated by a water sensor.



Installation

The L6A-Ex lifejacket light is for use on all types of lifejackets.

The L6A-Ex light is supplied with a fixing clip. The clip is intended to be placed behind a strip of lifejacket material or reflective tape; the light is secured by pressing it into the clip. An illustration showing a typical attachment method is shown opposite.

It is the responsibility of the lifejacket manufacturer to ensure that the light is attached securely and is in the correct position on the lifejacket to provide maximum visibility when the wearer is in the water. The sensor attached to the light must be secured to the lifejacket in a position such that it is immersed when the lifejacket is in use.

Operation

The L6A-Ex light is switched on automatically when the sensor is immersed in water; no user action is required.

Maintenance

Routine service

L6A-Ex units are maintenance free, but the following checks should be made annually:

1. Inspect light for signs of damage or corrosion.
2. Test the light by immersing the sensor in water. The light must flash. Remove the sensor from the water and dry it. The light must stop flashing.

Ensure that the sensor is in the “closed” position, as shown below.

Life

The life of the L6A-Ex batteries is five years from the date of manufacture; the expiry date is shown on the label affixed to the L6A-Ex. On expiry the light should be removed by carefully cutting the securing tape, or by cutting the plastic securing clip, and a new L6A-Ex fitted.

Switching

IMO regulations require that a flashing light can be switched off. Accordingly, for approval purposes the light may be extinguished by rotating the two halves of the sensor body, as shown below.

WARNING: the light will not operate when the sensor is “open”; operation requires that the sensor is “closed” AND immersed in water. Other than for testing, the sensor must always be in the “closed” position. Do not tamper with the sensor.



L6A-Ex ON
“Closed”



L6A-Ex
OFF
“Open”

Safety

L6A lights contain Lithium cells. These must be handled correctly:

- Do not dismantle battery pack
- Do not make any external electrical connection
- Do not recharge
- Do not incinerate

Store between -30°C and $+65^{\circ}\text{C}$

The lifejacket light is housed within a plastic enclosure and may be susceptible to electrostatic charging. Precautions shall be taken to ensure that electro static charging cannot occur.

Health and Safety information

Daniamant lithium-powered marine safety light systems have a design life of 5 years. The batteries are hermetically sealed pressurised primary Lithium/Manganese cells, and as supplied are electrically protected by a solid state device, and are environmentally protected by a moulded plastic housing. In this condition the units pose no definable hazard to health.

Information on the composition and behaviour of these products is contained in the Product Safety Data Sheet.

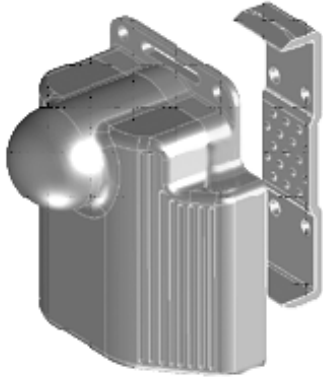

Diagrammatic illustration of L6A-Ex light and fixing clip separated to show material path

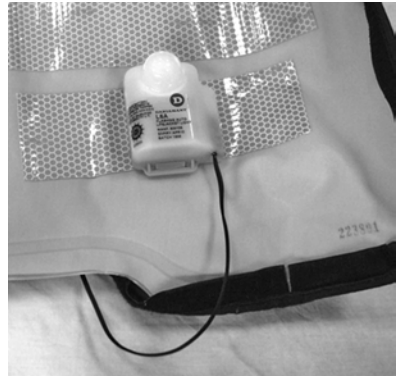

Example of L6A-Ex light fitted to jacket



Example of sensor taped to back strap of lifejacket to ensure immersion

Product Disposal Instructions

Daniamant's Survivor Location Lights contain batteries as well as electrical and electronic components, and must therefore be segregated from the domestic waste stream and recycled. Disposing of this product correctly will help save valuable resources and prevent any potential negative effects on human health and the environment, which could otherwise arise from inappropriate waste handling. Daniamant's lights are marked with the symbol below which conveys that this waste must be treated separately from household waste.



To ensure compliance with the WEEE and Battery Regulations, the Survivor Location Lights placed on the market in the UK or Denmark should be returned to Daniamant in the UK or Denmark, or deposited in your nearest WEEE Designated Collection Facility, operated by your Local Authority.





Product Labels

USCG: 161.112/8210 & SOLAS

MANF.: JUN19 EXP.: MAY24
BATCH: DAN000000
TC: LRTC 0000107



0038
2019



LIFEJACKET LIGHT



Daniamant

ITS11ATEX27239
IECEX ITS 11.0008
Ex ia IIB T3 Gb



II2G
-35°C < Ta < +65°C

CE2575

LITHIUM BATTERY DO NOT INCINERATE RECHARGE
OR TAMPER - WARNING - POTENTIAL ELECTROSTATIC
CHARGING HAZARD - SEE INSTRUCTIONS
MADE BY DANIAMANT LTD. PORTSMOUTH U.K.