



2019\*2020  
**CUSTOM MADE**  
—TOURNAMENT GRADE—



#imakemyowntackle

WHEN PRIDE IS ON THE LINE





Do-it Corporation is a 60-year-old company that is recognized as a world leader in tackle-making equipment. We have built this reputation by manufacturing the highest quality fishing tackle molds in the industry. Our process for building lure and soft plastics molds is highly refined and unique to our own company. We hold ourselves to higher standards and it shows when you fish with one of our products.

Beyond molds, we pride ourselves on carrying the highest-quality products and accessories available on the market. There are a lot of lower-quality items we could carry in our product line. We won't fish with them, so why would we try to sell them to you? Quality matters.

**Our Mission:** To provide every customer with the highest quality tackle-making equipment available.

**Our Commitment:** Do-it is committed to providing quality products, value, service and customer satisfaction to tackle makers all over the world.



World Leader  
in Tackle Craft



**WARNING:** Melting lead and casting lead objects will expose you and others in the area to lead, which is known to cause birth defects, other reproductive harm, and cancer. See instructions on Reducing Exposure supplied with product.

Imperial to Metric Conversion:  
1 oz. = 28.35 grams  
Metric to Imperial Conversion:  
1 gram = .035273 oz.

**GETTING STARTED**  
**4**



**HAND POURED TACKLE**  
**97**



**JIG & WEEDLESS JIG MOLDS**  
**7-30**



**KITS/REPLACEMENT**  
**98 and 102**



**LURE MOLDS**  
**31-39**



**GEAR**  
**99-101**



**SINKER MOLDS**  
**40-47**



**DO-IT SOFT BAITS-LURE MOLDS**  
**103-127**



**SPECIAL PURPOSE MOLDS**  
**48-49**



**SOFT BAITS-PLASTISOL & ADDITIVES**  
**128**



**HOOKS**  
**50-69**

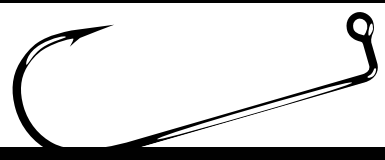

**SOFT BAITS-GLITTER & COLORANTS**  
**129-131**



**ACCESSORIES**  
**70-96**



**SOFT BAITS-ACCESSORIES**  
**132-133**



**Components** 70

**Blade & Spoon Decals** 78

**Wire Forms & Buzz Blades** 71

**Finishing Supplies & Paints** 79-84

**Wire Forms & Spinner Jig Forms** 72

**Hair, Tails & Skirts** 85-91

**Blades** 73-75

**Fiberguards & Weedguards** 92

**Rings, Clevises, Bodies** 76

**Tools** 93-94

**Rings, Beads, Eyes** 77

**Melting Equipment** 95-96

**SOFT BAITS-KITS**  
**134**



**SOFT BAITS-ESSENTIAL SERIES**  
**135-139**





# BULK LEAD FROM DO-IT

Looking for a reliable source of high quality lead for casting? These ingots are 99.9% pure soft lead. Excellent for those harder to cast jigs and sinkers. The cost of these ingots include freight and may be shipped separate from your remaining order. ⚠

| Size   | Item No. |
|--------|----------|
| 5 lbs  | 7900     |
| 10 lbs | 7901     |

\*Shipped in the USA



## IT'S EASY & INEXPENSIVE TO MAKE YOUR OWN TACKLE

Order the molds and all the accessories that meet the demands of your sport fishing environment.



Melting equipment that suits your needs (pages 95-96)

Molds to match your fishing strategy (pages 7-49)

Appropriate safety equipment



Ample lead supply







# OUR CHARTS GIVE YOU WHAT YOU NEED TO KNOW

Use our charts as your guide to choosing the appropriate mold and accessories for your fishing strategy.

|    | 1        | 2         | 3                | 4      | 5      | 6          | 7           | 8        | 9<br>10                   |     |     |     |
|----|----------|-----------|------------------|--------|--------|------------|-------------|----------|---------------------------|-----|-----|-----|
|    | Item No. | Model No. | Type             | Insert | Collar | Hook Style | Model Group | Cavities | Sizes (oz.)<br>Hook Sizes |     |     |     |
| 12 | 1090     | JKS-1090Y | Weedless Sparkle | FG-30  | Ball   | 410<br>413 | Assorted    | 4        | 1/4                       | 3/8 | 1/2 | 5/8 |
|    |          |           |                  |        |        |            |             |          | 1/0                       | 2/0 | 3/0 | 4/0 |

**1 Item No.**  
The catalog number that helps us track what you want.

**2 Model No.**  
The mold as described in the copy.

**3 Type**  
Description of the casting you'll produce.

**4 Insert**  
The wire, fiberguard or other part or parts that are required by this mold.

**5 Collar**  
A description of the tying collar. See below to learn the advantages of each collar type.

**6 Hook Style**  
Models are designed to accept specified styles. See the hook section for detailed descriptions.

**7 Model Group**  
The arrangement of cavities by sizes. Select the group that best suits your production needs, as described below.

Assorted: One cavity of each of the sizes listed.

Combination: Cavities in two of the most popular sizes.

Production: Several cavities of the same size to maximize production speed.

Pro-Series: Minimum sprue gates designed with commercial tackle manufacturers in mind.

**8 Cavities**  
The number of cavities in the model.

**9 Sizes (oz.)**  
The approximate weight in ounces of the castings produced.

**10 Hook Sizes**  
Listed below each weight size is the size of hooks the mold is designed to accept in the cavity.

## COLLAR DESIGNS

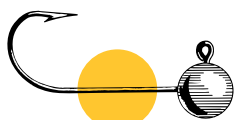

### NO COLLAR

Preferred by many who tie flies and other experienced lure makers. One of the more difficult collars to wrap, but uses a minimum of material.

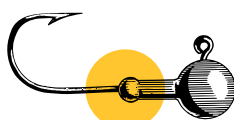

### BALL COLLAR

Easy to tie, especially for beginners. The ball on the end prevents a loose wrap from slipping off the collar, provides a natural stop for the thread wrap, and imparts a slight flare to the material being tied.

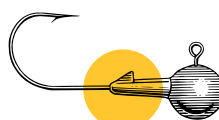

### BARB COLLAR

Made to secure plastic bodies on the jig. Barbs positioned on the collar opposite the hook are called Reverse Barbs.

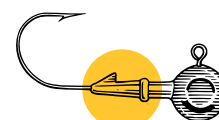

### RING AND BARB COLLAR

The ring and barb collar gives you the option of attaching soft plastic tails or tying on dressings like silicone skirt material or bucktail.



### HOLDER COLLAR

An all-purpose collar made to hold plastic bodies and rubber skirts. It is also easy to tie material on the holder collar.

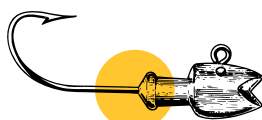

### FLAIR COLLAR

A thick collar made to flair bucktail, crimped nylon or other wrapped and tied material.

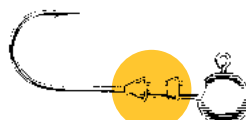

### DOUBLE HOLDER

Preferred by professional fishermen fishing the newer, softer plastics. Built to allow tying materials or dressings to be attached.

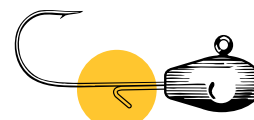

### WIRE KEEPER

The wire style keeper is the ultimate in plastic holding power. Fewer plastics slipping down the collar means more casts, more chances at your favorite lunker and maybe even a few dollars saved in lost plastics.



## Note to Saltwater Fishermen

Salt eats away at metal. Before you head out in saltwater, be sure to select molds that will accommodate hooks plated to withstand the corrosive effects of salt. To make it easy, we've identified these molds with a saltwater-drop icon.

# ARROWHEAD JIG

Put this jig in your quiver for a successful catch. The resemblance of the flat tapered head to a stone arrowhead is no mere coincidence. The streamlined shape pierces strong currents. Sleek, flat-sided jig heads give more action to paddle tail grubs and shad bodies than do wider and bulkier head designs.

| Item No. | Model No.  | Type          | Collar | Hook Style             | Model Group | Cavities           | Sizes (oz.)<br>Hook Sizes       |     |
|----------|------------|---------------|--------|------------------------|-------------|--------------------|---------------------------------|-----|
|          |            |               |        |                        |             |                    |                                 |     |
| 3045     | AHB-6-3812 | Arrowhead Jig | Barb   | 630<br>635             | Combination | 6<br>(3 each size) | 3/8                             | 1/2 |
|          |            |               |        |                        |             |                    | 1/0                             | 2/0 |
| 3046     | AHB-4-341  | Arrowhead Jig | Barb   | 630, 635<br>410 or 413 | Combination | 4<br>(2 each size) | 3/4                             | 1   |
|          |            |               |        |                        |             |                    | 3/0 or 4/0 (#630)<br>4/0 (#410) |     |



Barbed collar holds plastic bodies securely

# ASPIRIN-HEAD JIG

Our prescription for cutting through H2O – the flat sides of the Aspirin-Head Jig. These flat sides also permit placement of stick-on decal lure eyes on the jig head. Size 2.5 Stick-On Lure Eyes fit all weights of Aspirin-Head Jigs; Size 4 eyes can be used on 3/16 oz. and above; Size 5 eyes will fit on 1/2 oz. and larger. The Aspirin-Head's barb collar loves plastics.

| Item No. | Model No. | Collar | Hook Style | Model Group | Cavities | Sizes (oz.)<br>Hook Sizes |     |      |     |     |     |     |
|----------|-----------|--------|------------|-------------|----------|---------------------------|-----|------|-----|-----|-----|-----|
|          |           |        |            |             |          |                           |     |      |     |     |     |     |
| 3337     | AJ-7-A    | Barb   | 570<br>575 | Assorted    | 7        | 1/16                      | 1/8 | 3/16 | 1/4 | 3/8 | 1/2 | 5/8 |
|          |           |        |            |             |          | 2                         | 1   | 1/0  | 2/0 | 3/0 | 4/0 | 4/0 |



Designed with a forward balance

# BANANA JIG

No monkey business. The strategic placement of the hook eye allows the head to pull over branches, rocks and other snags. The forward center of weight gives the Banana Jig a unique nose diving action. This snag resistant jig is popular in both fresh and saltwater.

| Item No. | Model No. | Collar | Hook Style    | Model Group | Cavities | Sizes (oz.)<br>Hook Sizes |       |       |     |
|----------|-----------|--------|---------------|-------------|----------|---------------------------|-------|-------|-----|
|          |           |        |               |             |          |                           |       |       |     |
| 1052     | JY-4-A    | Ball   | 570<br>575    | Assorted    | 4        | 1/8                       | 1/4   | 3/8   | 1/2 |
|          |           |        |               |             |          | 1/0                       | 2/0   | 3/0   | 4/0 |
| 1054     | JYS-4-A   | Ball   | 630<br>635    | Assorted    | 4        | 1/8                       | 1/4   | 3/8   | 1/2 |
|          |           |        |               |             |          | 1/0                       | 2/0   | 3/0   | 4/0 |
| 1055     | JYS-1055L | Ball   | 410<br>413    | Assorted    | 4        | 3/4                       | 1     | 1-1/2 | 2   |
|          |           |        |               |             |          | 4/0                       | 5/0   | 6/0   | 7/0 |
| 3308     | JYS-3-X   | Ball   | 34184<br>Only | Assorted    | 3        | 2                         | 2-1/2 | 3     |     |
|          |           |        |               |             |          |                           | 8/0   |       |     |

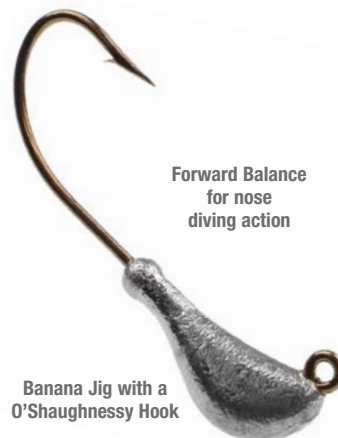

Forward Balance for nose diving action

Banana Jig with a O'Shaughnessy Hook

# BULLET JIG

The Bullet Jig is a center balance jig with a tapered head. It smoothly shoots through the water attracting a variety of fish species.

| Item No. | Model No.  | Collar | Hook Style | Model Group | Cavities                  | Sizes (oz.)<br>Hook Sizes |            |     |     |     |     |
|----------|------------|--------|------------|-------------|---------------------------|---------------------------|------------|-----|-----|-----|-----|
|          |            |        |            |             |                           |                           |            |     |     |     |     |
| 1028     | JB-7-48    | Ball   | 570<br>575 | Combination | 7<br>(4 of 1/8, 3 of 1/4) | 1/8                       | 1/4        |     |     |     |     |
|          |            |        |            |             |                           | 4 or 2                    | 2 or 1     |     |     |     |     |
| 3361     | BHB-8-3216 | Barb   | 570<br>575 | Combination | 8<br>(4 each size)        | 1/32                      | 1/16       |     |     |     |     |
|          |            |        |            |             |                           | 6                         | 4          |     |     |     |     |
| 1059     | BHB-1059   | Barb   | 570<br>575 | Combination | 7<br>(4 of 1/8, 3 of 1/4) | 1/8                       | 1/4        |     |     |     |     |
|          |            |        |            |             |                           | 2 or 1                    |            |     |     |     |     |
| 3182     | BHB-3182   | Barb   | 570<br>575 | Combination | 6<br>(3 each size)        | 3/8                       | 1/2        |     |     |     |     |
|          |            |        |            |             |                           | 2/0 or 3/0                | 3/0 or 4/0 |     |     |     |     |
| 3299     | JBS-6-A    | Barb   | 630<br>635 | Assorted    | 6                         | 1/8                       | 1/4        | 3/8 | 1/2 | 3/4 | 1   |
|          |            |        |            |             |                           | 1                         | 1/0        | 2/0 | 3/0 | 4/0 | 5/0 |



Ball Collar provides a natural stop for tying



Barb Collar secures plastic bodies



# BAT JIG

In a class all its own and aimed at paper mouths slabs near you. The Bat Jig was specifically designed to be fished in thick brush to avoid hang-ups while at the same time providing a superior hook up percentage over other brush pile jigs. Cory "Bat Man" Batterson who lives and breathes crappies was essential in the design and engineering process, and is proud to say this will be the staple of his dipping presentation. The uniqueness of this jig, lies in marriage of the short shank Do-it Wacky hook and superior head design that avoids snagging brush but also makes for perfect roof of the mouth hook ups.



| Item No. | Model No. | Type    | Collar       | Hook Style | Model Group | Cavities | Sizes (oz.) Hook Sizes |       |         |         |         |         |         |
|----------|-----------|---------|--------------|------------|-------------|----------|------------------------|-------|---------|---------|---------|---------|---------|
|          |           |         |              |            |             |          | 1/32                   | 1/24  | 1/16    | 3/32    | 1/8     | 3/16    | 1/4     |
| 3504     | BAT-7-A   | Bat Jig | Holder WB400 | 785        | Assorted    | 7        | 6                      | 6     | 6       | 6       | 6       | 6       | 6       |
|          |           |         |              |            |             |          | 2 eye                  | 2 eye | 2.5 eye | 2.5 eye | 2.5 eye | 2.5 eye | 2.5 eye |
|          |           |         |              |            |             |          |                        |       |         |         |         |         |         |

# BULLET NOSE JIG

The Bullet Nose Jig is designed to gun down saltwater species by using the Eagle Claw Style 413 Jig Hooks. The double barb collar is excellent for holding plastic shrimp bodies and other thick plastics. Style 410 hooks can be used for freshwater applications. Model BDB-3-X is designed to use the extra strong Mustad style 34184 8/0 jig hooks.

| Item No. | Model No.  | Type            | Collar      | Hook Style    | Model Group | Cavities                  | Sizes (oz.) Hook Sizes |       |     |     |     |
|----------|------------|-----------------|-------------|---------------|-------------|---------------------------|------------------------|-------|-----|-----|-----|
|          |            |                 |             |               |             |                           | 1/8                    | 1/4   | 3/8 | 1/2 | 3/4 |
| 3228     | BDB-5-A    | Bullet Nose Jig | Double Barb | 410<br>413    | Assorted    | 5                         | 1                      | 1/0   | 2/0 | 3/0 | 4/0 |
| 3229     | BDB-6-48   | Bullet Nose Jig | Double Barb | 410<br>413    | Combination | 6<br>(3 each size)        | 1/8                    |       | 1/4 |     |     |
| 3230     | BDB-5-3812 | Bullet Nose Jig | Double Barb | 410<br>413    | Combination | 5<br>(3 of 3/8, 2 of 1/2) | 1/8                    |       | 1/4 |     |     |
| 3231     | BDB-3-LA   | Bullet Nose Jig | Double Barb | 410<br>413    | Assorted    | 3                         | 1                      | 1-1/2 | 2   |     |     |
| 3310     | BDB-3-X    | Bullet Nose Jig | Double Barb | 34184<br>Only | Assorted    | 3                         | 2-1/2                  | 3     | 4   |     |     |
|          |            |                 |             |               |             |                           |                        | 8/0   |     |     |     |



Standard Balance

# CHUB JIG

Fish see a well-dressed chubby creature as somebody they would like to take out for a bite. Chomp! With its baitfish-shaped head and swollen belly, the chub jig will interest any predator.

| Item No. | Model No. | Type | Collar | Hook Style | Model Group | Cavities | Sizes (oz.) Hook Sizes |      |     |      |     |
|----------|-----------|------|--------|------------|-------------|----------|------------------------|------|-----|------|-----|
|          |           |      |        |            |             |          | 1/32                   | 1/16 | 1/8 | 3/16 | 1/4 |
| 3294     | JCH-5-A   | Chub | Barb   | 570<br>575 | Assorted    | 5        | 1/32                   | 1/16 | 1/8 | 3/16 | 1/4 |
|          |           |      |        |            |             |          | 8                      | 4    | 2   | 1    | 1/0 |
| 3311     | JCHS-L    | Chub | Barb   | 630<br>635 | Assorted    | 5        | 1/4                    | 3/8  | 1/2 | 3/4  | 1   |
|          |           |      |        |            |             |          | 1/0                    | 2/0  | 3/0 | 4/0  | 5/0 |



Chub Jig can accommodate the extra long O'Shaughnessy hook

Tapered head "swims" through water

# CRAPPIE JIG

Fill up the live well that is. And no matter how you pronounce this species, we all agree that crappies are tasty. Shrewd fishermen know that the horizontal, semi-flat shape helps the crappie jig fall slower and flutter more than most other jigs, so it's also successful for other panfish.

| Item No. | Model No. | Type        | Collar | Hook Style | Model Group | Cavities           | Sizes (oz.) Hook Sizes |      |
|----------|-----------|-------------|--------|------------|-------------|--------------------|------------------------|------|
|          |           |             |        |            |             |                    | 1/32                   | 1/16 |
| 3227     | JC-6-1632 | Crappie Jig | None   | #33903     | Combination | 6<br>(3 each size) | 10                     | 8    |
|          |           |             |        |            |             |                    |                        |      |



Designed without a collar for fly tying.

Accommodates a Crimped Popper Bug Hook See Crimped hooks on page 50

# DARTER JIG

The Darter Jig darts through the water similar to a Bullet Jig, but uses larger hook sizes and features a standard balance for all-around use.

| Item No. | Model No.  | Type       | Collar | Hook Style | Model Group | Cavities                  | Sizes (oz.)<br>Hook Sizes |     |
|----------|------------|------------|--------|------------|-------------|---------------------------|---------------------------|-----|
|          |            |            |        |            |             |                           |                           |     |
| 3362     | DTR-6-1618 | Darter Jig | Barb   | 570<br>575 | Combination | 6<br>(3 each size)        | 1/16                      | 1/8 |
|          |            |            |        |            |             |                           | 2/0                       | 3/0 |
| 3363     | DTR-5-1438 | Darter Jig | Barb   | 570<br>575 | Combination | 5<br>(3 of 1/4, 2 of 3/8) | 1/4                       | 3/8 |
|          |            |            |        |            |             |                           | 3/0 or 4/0                |     |



Accommodates the larger hooks that can handle Bass!

# EGG HEAD JIG

This "thinking man's" jig is known for its versatility. The tapered egg shape cuts current, resists snags in rocks, and slides into tube skirts better than roundhead jigs.

| Item No. | Model No. | Collar      | Hook Style | Model Group | Cavities | Sizes (oz.)<br>Hook Sizes |     |     |     |     |     |
|----------|-----------|-------------|------------|-------------|----------|---------------------------|-----|-----|-----|-----|-----|
|          |           |             |            |             |          |                           |     |     |     |     |     |
| 3330     | EGJ-6-A   | Ring & Barb | 570<br>575 | Assorted    | 6        | 1/16                      | 1/8 | 1/4 | 3/8 | 1/2 | 5/8 |
|          |           |             |            |             |          | 2                         | 1   | 1/0 | 2/0 | 3/0 | 4/0 |



Ring and barb collar can be dressed with tied material or soft plastics

# ERIE JIG

This jig was based on the Erie Rig lure, a weight forward spinner popularized in Lake Erie waters. We adapted that legendary lure several decades ago with the first Do-it® Erie Jig Mold, Model JE-6-A, which has been often imitated by major lure manufacturers. The Erie Jig has been and remains one of the most effective jig designs for walleye fishing in the world.

| Item No. | Model No. | Type                 | Collar | Hook Style     | Model Group | Cavities                  | Sizes (oz.)<br>Hook Sizes |     |          |     |     |     |
|----------|-----------|----------------------|--------|----------------|-------------|---------------------------|---------------------------|-----|----------|-----|-----|-----|
|          |           |                      |        |                |             |                           |                           |     |          |     |     |     |
| 3020     | EHB-6-A   | Erie Jig             | Barb   | 570<br>575     | Assorted    | 6                         | 1/8                       | 1/4 | 3/8      | 1/2 | 5/8 | 3/4 |
|          |           |                      |        |                |             |                           | 2                         | 1   | 1/0      | 2/0 | 3/0 | 4/0 |
| 3021     | EHB-7-48  | Erie Jig             | Barb   | 570<br>575     | Combination | 7<br>(4 of 1/8, 3 of 1/4) | 1/8                       |     | 1/4      |     |     |     |
|          |           |                      |        |                |             |                           | 1 or 2                    |     | 1 or 1/0 |     |     |     |
| 3194     | EHB-4-1   | Erie Jig             | Barb   | 570<br>575     | Production  | 4                         | 1                         |     |          |     |     |     |
|          |           |                      |        |                |             |                           | 4/0                       |     |          |     |     |     |
| 1032     | JE-6-A    | Erie Jig             | Ball   | 570<br>575     | Assorted    | 6                         | 1/8                       | 1/4 | 3/8      | 1/2 | 5/8 | 3/4 |
|          |           |                      |        |                |             |                           | 2                         | 1   | 1/0      | 2/0 | 3/0 | 4/0 |
| 1035     | JES-6-A   | Erie Jig Heavy Hooks | Ball   | 630<br>635     | Assorted    | 6                         | 1/8                       | 1/4 | 3/8      | 1/2 | 5/8 | 3/4 |
|          |           |                      |        |                |             |                           | 2                         | 1   | 1/0      | 2/0 | 3/0 | 4/0 |
| 3295     | JNE-5-A   | Live Bait Erie Jig   | None   | 571<br>570-575 | Assorted    | 5                         | 1/16                      | 1/8 | 1/4      | 3/8 | 1/2 |     |
|          |           |                      |        |                |             |                           | 1                         | 1   | 1/0      | 1/0 | 1/0 |     |

Designed for center and stand-up balance



Barb Collar with an Aberdeen Hook

Ball Collar with an Aberdeen Hook



Live Bait Erie Jig with no Collar





# FLAT HEAD JIG

This jig overcomes the upswell currents and gets down where the “Big Ones” play. River fishermen find the Flat Head Jig ideal for reaching fish below locks and dams. Saltwater fishermen find the thin flat shape allows lighter weights to reach deeper depths.

| Item No. | Model No. | Type          | Collar | Hook Style | Model Group | Cavities | Sizes (oz.)<br>Hook Sizes |     |       |     |     |
|----------|-----------|---------------|--------|------------|-------------|----------|---------------------------|-----|-------|-----|-----|
|          |           |               |        |            |             |          | 1/4                       | 3/8 | 1/2   | 5/8 | 3/4 |
| 1038     | JF-5-A    | Flat Head Jig | Ball   | 570<br>575 | Assorted    | 5        | 1                         | 1/0 | 2/0   | 3/0 | 4/0 |
| 1039     | JFS-5-A   | Flat Head Jig | Ball   | 630<br>635 | Assorted    | 5        | 3/8                       | 1/2 | 5/8   | 3/4 | 1   |
| 3306     | JFS-3-LA  | Flat Head Jig | Ball   | 413<br>635 | Assorted    | 3        | 1-1/2                     | 2   | 2-1/2 |     |     |
| 3315     | JFS-2-43  | Flat Head Jig | Ball   | 34184      | Assorted    | 2        | 3 oz                      |     | 4 oz  |     |     |
|          |           |               |        |            |             |          | 8/0                       |     |       |     |     |



Flat Head Jig designed with center balance 570 Hook

Flat Head Jig with standard balance O'Shaughnessy Hook

# FLAT GRUB JIG

Flat sides mean more water flow along the head of the Flat Grub Jig. This gives you the best wiggle action for paddle-type grubs or shad bodies to attract game fish in fresh or saltwater. Deep eye sockets accommodate our 5/32" stick-on lure eye.

| Item No. | Model No. | Type          | Collar | Hook Style | Model Group | Cavities | Sizes (oz.)<br>Hook Sizes |     |     |     |     |     |
|----------|-----------|---------------|--------|------------|-------------|----------|---------------------------|-----|-----|-----|-----|-----|
|          |           |               |        |            |             |          | 1/8                       | 1/4 | 3/8 | 1/2 | 5/8 | 3/4 |
| 3285     | JG-6-A    | Flat Grub Jig | Barb   | 630<br>635 | Assorted    | 6        | 1                         | 1/0 | 2/0 | 3/0 | 4/0 | 5/0 |



Deep eye sockets accommodate 5/32" stick-on lure eye See page 77

# FOOTBALL JIG

The Football jig scores big for bottom fishing and as a probing tool. The wide-shaped head prevents the lure from fumbling on its side. Instead, this “all-star” drags along the bottom with the hook always remaining upright. Line pressure causes the jig to stand up, poised for a strike, ready to tackle its prey. Plus, the broad face helps transmit signals up the line about changes in bottom features. What a sport! Ideal for bass, walleye and trout.

| Item No. | Model No. | Collar | Hook Style | Model Group | Cavities | Sizes (oz.)<br>Hook Sizes |     |     |     |     |     |     |
|----------|-----------|--------|------------|-------------|----------|---------------------------|-----|-----|-----|-----|-----|-----|
|          |           |        |            |             |          | 1/16                      | 1/8 | 1/4 | 3/8 | 1/2 | 3/4 | 1   |
| 3055     | FBB-7-A   | Barb   | 570<br>575 | Assorted    | 7        | 4                         | 1   | 1/0 | 2/0 | 3/0 | 4/0 | 4/0 |
| 3210     | FBB-18    | Barb   | 570<br>575 | Production  | 7        | 1/8                       |     |     |     |     |     |     |
|          |           |        |            |             |          | 1 or 1/0                  |     |     |     |     |     |     |
| 3211     | FBB-14    | Barb   | 570<br>575 | Production  | 7        | 1/4                       |     |     |     |     |     |     |
|          |           |        |            |             |          | 1/0 or 2/0                |     |     |     |     |     |     |
| 3212     | FBB-38    | Barb   | 570<br>575 | Production  | 7        | 3/8                       |     |     |     |     |     |     |
|          |           |        |            |             |          | 1/0 or 2/0                |     |     |     |     |     |     |
| 3213     | FBB-12    | Barb   | 570<br>575 | Production  | 5        | 1/2                       |     |     |     |     |     |     |
|          |           |        |            |             |          | 3/0                       |     |     |     |     |     |     |
| 3214     | FBB-34    | Barb   | 570<br>575 | Production  | 5        | 3/4                       |     |     |     |     |     |     |
|          |           |        |            |             |          | 4/0                       |     |     |     |     |     |     |
| 3215     | FBB-1     | Barb   | 570<br>575 | Production  | 5        | 1                         |     |     |     |     |     |     |
|          |           |        |            |             |          | 4/0                       |     |     |     |     |     |     |



Football Jig with barb collar and standard balance.

# FOOTBALL SWING JIG

Take the fish deep in their own yard with a football shaped head and a loose swinging worm hook following behind. This heavy hitter has all the advantages of a football jig with the added action provided by the swinging hook that imparts more movement to the trailer while taking the leverage away from a hooked fish. All this adds up to a very versatile head that accommodates nearly any plastic bait and flat out catches fish.



| Item No. | Model No. | Insert | Hook Style | Model Group | Cavities | Sizes (oz.) Hook Sizes |      |     |      |       |           |
|----------|-----------|--------|------------|-------------|----------|------------------------|------|-----|------|-------|-----------|
|          |           |        |            |             |          | 1/8                    | 3/16 | 1/4 | 5/16 | 3/8   | 7/16      |
| 3498     | FBB-6-SWG | WJI450 | 38104BLN   | Assorted    | 6        | 2/0 - 8/0              |      |     |      |       |           |
| 3503     | FBB-5-SWG | WJI600 | 38104BLN   | Assorted    | 5        | 1/2                    | 5/8  | 3/4 | 1    | 1 1/4 | 2/0 - 8/0 |

# GARY YAMAMOTO SWIMMING JIG

There is only one Gary Yamamoto, so when he came to us with a design we knew it would be something good. It is. Engineered to be fished with the paddle tailed Swimming Senko, this is a true finesse bait. Gary fishes it with a slow bump and lift technique, others like a slow steady swimming retrieve. It's unique design lends itself to a variety of plastics and fishing situations.



| Item No. | Model No. | Type         | Collar | Hook Style       | Model Group | Cavities | Sizes (oz.) Hook Sizes |         |         |         |         |
|----------|-----------|--------------|--------|------------------|-------------|----------|------------------------|---------|---------|---------|---------|
|          |           |              |        |                  |             |          | 1/16                   | 1/8     | 3/16    | 1/4     | 5/16    |
| 3441     | RGY-5-SAG | Swimming Jig | Barb   | Gamaksatsu V-eye | Assorted    | 5        | 2/0-4/0                | 2/0-4/0 | 2/0-4/0 | 2/0-4/0 | 2/0-4/0 |

A note to manufacturers: It would be a violation of trademark law to utilize the Yamamoto name or likeness in any commercial sale of products from these molds.

# GRAVE DIGGER JIG

The Grave Digger is one of the most unique jigs you will ever fish. With its unique shovel-head design, the head portion dives down bumping the bottom (aka Grave Digging), thereby mimicking the action of a feeding minnow. Note also that this same action makes the jig resistant to snags.



| Item No. | Model No. | Type             | Collar | Hook Style   | Model Group | Cavities | Sizes (oz.) Hook Sizes |     |     |     |  |
|----------|-----------|------------------|--------|--------------|-------------|----------|------------------------|-----|-----|-----|--|
|          |           |                  |        |              |             |          | 1/8                    | 1/4 | 3/8 | 1/2 |  |
| 3423     | CGD-4     | Grave Digger Jig | Barb   | 570, 575 571 | Assorted    | 4        | 1                      | 1/0 | 2/0 | 3/0 |  |

# LARVA JIG

Fish love to dine on the harmless developing larva, so we designed this jig to mimic its falling action. The forward position of the hook eye makes the Larva Jig more snag resistant, even when ice fishing. Outfit with feathers or plastic tubular jig skirts to lure crappie and panfish. Accommodates the #33903 Crimped Popper Bug Hook (see page 50).



Larva Jig can be outfitted with feathers or tubular-jig skirt

| Item No. | Model No. | Type      | Tube Skirt Size   | Hook Style | Model Group | Cavities        | Sizes (oz.) Hook Sizes |      |      |     |  |
|----------|-----------|-----------|-------------------|------------|-------------|-----------------|------------------------|------|------|-----|--|
|          |           |           |                   |            |             |                 | 1/32                   | 1/16 | 3/32 | 1/8 |  |
| 3216     | TUBE-L    | Larva Jig | 1-1/2" small dia. | 33903      | Combination | 8 (2 each side) | 8                      | 6    | 6    | 4   |  |

# LIVE BAIT JIG

This classic jig is designed to be tipped with minnow, leech or other live bait. A special style 571 short shank hook is used to keep the bait close in for enhanced action and hooking ability.



#3433

Live Bait Jig uses short shank hook. See page 58

#0 Wire Eye

| Item No. | Model No. | Type          | Collar  | Hook Style | Model Group | Cavities | Sizes (oz.) Hook Sizes |     |     |     |     |     |
|----------|-----------|---------------|---------|------------|-------------|----------|------------------------|-----|-----|-----|-----|-----|
|          |           |               |         |            |             |          | 1/16                   | 1/8 | 1/4 | 3/8 | 1/2 |     |
| 3245     | LBJ-5-A   | Live Bait Jig | Tapered | 571        | Assorted    | 5        | 1                      | 1   | 1/0 | 1/0 | 1/0 |     |
| 3433     | LBS-6-A   | Live Bait Jig | Tapered | 571        | Assorted    | 6        | 1/16                   | 1/8 | 1/4 | 3/8 | 1/2 | 5/8 |
|          |           |               |         |            |             |          | 1/0                    | 1/0 | 1/0 | 1/0 | 1/0 |     |



# HOT LIPS JIG

Say "Open Wide" to saltwater game fish with a Hot Lips Jig. This basic bullet style with a wide mouth can be accented with red paint to mimic an injured fish. This jig features protruding eyes, flair collar for tying bucktail and strong O'Shaughnessy style hooks.

| Item No. | Model No. | Type         | Collar | Hook Style           | Model Group | Cavities | Sizes (oz.)<br>Hook Sizes |          |       |     |     |     |
|----------|-----------|--------------|--------|----------------------|-------------|----------|---------------------------|----------|-------|-----|-----|-----|
|          |           |              |        |                      |             |          | 1/8                       | 1/4      | 3/8   | 1/2 | 5/8 | 3/4 |
| 3041     | JLS-6-A   | Hot Lips Jig | Flair  | 630, 635<br>410, 413 | Assorted    | 6        | 1                         | 1/0      | 2/0   | 3/0 | 4/0 | 5/0 |
|          |           |              |        |                      |             |          | 3/4                       | 1        | 1-1/2 |     |     |     |
| 1044     | JLS-3-A1  | Hot Lips Jig | Flair  | 410, 413<br>635      | Assorted    | 3        | 5/0                       | 6/0      | 7/0   |     |     |     |
|          |           |              |        |                      |             |          | 2 oz                      | 2-1/2 oz | 3 oz  |     |     |     |
| 3273     | JLS-3-XL  | Hot Lips Jig | Flair  | 34184<br>91715       | Assorted    | 3        | 8/0                       |          |       |     |     |     |
|          |           |              |        |                      |             |          | 4 oz                      | 5 oz     |       |     |     |     |
| 3342     | JLS-2-45  | Hot Lips Jig | Flair  | 91715                | Assorted    | 2        | 9/0                       |          |       |     |     |     |



# MINNOW HEAD JIG

If it looks like a minnow and acts like a minnow... it is a minnow to your catch. Combine this tapered head jig with small shad bodies and other plastics to fill up the live well. Item #3421, #3422 & #3500 have recessed area for stick-on lure eyes for a more life-like appearance.

#1084, #1085 & #1086  
Designed with barb collar and standard balance



| Item No. | Model No.   | Type            | Collar          | Hook Style | Model Group | Cavities                  | Sizes (oz.)<br>Hook Sizes |         |       |       |            |         |         |  |
|----------|-------------|-----------------|-----------------|------------|-------------|---------------------------|---------------------------|---------|-------|-------|------------|---------|---------|--|
|          |             |                 |                 |            |             |                           | 1/48                      | 1/32    | 1/16  | 1/8   | 3/16       | 1/4     | 3/8     |  |
| 1084     | JM-7-A      | Minnow Head Jig | Barb            | 570<br>575 | Assorted    | 7                         | 6                         | 4       | 2     | 1     | 1/0        | 2/0     | 3/0     |  |
|          |             |                 |                 |            |             |                           | 1/32                      | 1/16    | 1/8   | 3/16  | 1/4        | 3/8     |         |  |
| 1085     | JM-8-1632   | Minnow Head Jig | Barb            | 570<br>575 | Combination | 8<br>(4 each size)        | 1/32                      |         |       |       | 1/16       |         |         |  |
|          |             |                 |                 |            |             |                           | 4                         |         |       |       | 2 or 4     |         |         |  |
| 1086     | JM-7-48     | Minnow Head Jig | Barb            | 570<br>575 | Combination | 7<br>(4 of 1/8, 3 of 1/4) | 1/8                       |         |       |       | 1/4        |         |         |  |
|          |             |                 |                 |            |             |                           | 1                         |         |       |       | 2/0        |         |         |  |
| 3421     | JME-7-A1    | Minnow Head Jig | Barb            | 570<br>575 | Assorted    | 7                         | 1/48                      | 1/32    | 1/16  | 1/8   | 3/16       | 1/4     | 3/8     |  |
|          |             |                 |                 |            |             |                           | 6                         | 4       | 2     | 1     | 1/0        | 2/0     | 3/0     |  |
|          |             |                 |                 |            |             |                           | 1.5 eye                   | 1.5 eye | 2 eye | 2 eye | 2.5 eye    | 2.5 eye | 3 eye   |  |
| 3422     | JME-8-1632A | Minnow Head Jig | Barb            | 570<br>575 | Combination | 8<br>(4 each size)        | 1/32                      |         |       |       | 1/16       |         |         |  |
|          |             |                 |                 |            |             |                           | 4                         |         |       |       | 2 or 4     |         |         |  |
|          |             |                 |                 |            |             |                           | 1.5 eye size              |         |       |       | 2 eye size |         |         |  |
| 3500     | JMWB-7-A    | Minnow Head Jig | Holder<br>WB400 | 570<br>575 | Assorted    | 7                         | 1/48                      | 1/32    | 1/16  | 1/8   | 3/16       | 1/4     | 3/8     |  |
|          |             |                 |                 |            |             |                           | 6                         | 4       | 2     | 1     | 1/0        | 2/0     | 3/0     |  |
|          |             |                 |                 |            |             |                           | 1.5 eye                   | 1.5 eye | 2 eye | 2 eye | 2.5 eye    | 2.5 eye | 2.5 eye |  |

# POPEYE JIG

Just like a "pop-eyed frog," the Popeye Jig gets its name from the protruding eyes on each side of its head. Paint these "eyes" for a more life-like appearance. Popeye Jigs are usually dressed with bucktail and are very popular with saltwater fishermen along many parts of the eastern coast.

| Item No. | Model No. | Type       | Collar | Hook Style | Model Group | Cavities | Sizes (oz.)<br>Hook Sizes |     |       |     |     |  |
|----------|-----------|------------|--------|------------|-------------|----------|---------------------------|-----|-------|-----|-----|--|
|          |           |            |        |            |             |          | 1/4                       | 3/8 | 1/2   | 3/4 | 1   |  |
| 1042     | JIS-5-A   | Popeye Jig | Ball   | 630<br>635 | Assorted    | 5        | 2/0                       | 3/0 | 4/0   | 5/0 | 6/0 |  |
|          |           |            |        |            |             |          | 1-1/2                     | 2   | 2-1/2 | 3   |     |  |
| 1082     | JIS-4-L   | Popeye Jig | Ball   | 635<br>413 | Assorted    | 4        | 7/0                       |     |       |     |     |  |
|          |           |            |        |            |             |          | 3/8                       |     |       |     |     |  |
| 3333     | JIS-4-38X | Popeye Jig | Ball   | 91715      | Production  | 4        | 7/0                       |     |       |     |     |  |



Wide, flat foot slows the descent

The ball collar is easy to tie even for beginners

# ROUND HEAD JIG – HEAVY HOOKS

Prize catches require your most serious equipment. No wimpy hooks will do. These jigs can handle the no-nonsense O'Shaughnessy hooks that have the length and strength to bring in the winners. Additional Models Listed Under Pro-Series. See page 22.

| Item No. | Model No.  | Hook Style | Model Group | Cavities                  | Sizes (oz.) Hook Sizes |       |     |     |     |
|----------|------------|------------|-------------|---------------------------|------------------------|-------|-----|-----|-----|
|          |            |            |             |                           | 1/8                    | 1/4   | 3/8 | 1/2 | 5/8 |
| 1023     | JRS-5-A    | 630<br>635 | Assorted    | 5                         | 1/8                    | 1/4   | 3/8 | 1/2 | 5/8 |
|          |            |            |             |                           | 1/0                    | 2/0   | 3/0 | 4/0 | 5/0 |
| 1063     | JRS-1063   | 630<br>635 | Combination | 8<br>(4 each size)        | 1/16                   |       |     | 1/8 |     |
|          |            |            |             |                           | 4                      |       |     | 2   |     |
| 1024     | JRS-7-48   | 630<br>635 | Combination | 7<br>(4 of 1/8, 3 of 1/4) | 1/8                    |       |     | 1/4 |     |
|          |            |            |             |                           | 1                      |       |     | 1/0 |     |
| 1025     | JRS-5-3812 | 630<br>635 | Combination | 5<br>(2 of 1/2, 3 of 3/8) | 3/8                    |       |     | 1/2 |     |
|          |            |            |             |                           | 3/0                    |       |     | 4/0 |     |
| 3326     | RHO-5-A    | 410<br>413 | Assorted    | 5                         | 3/8                    | 1/2   | 5/8 | 3/4 | 1   |
|          |            |            |             |                           | 1/0                    | 2/0   | 3/0 | 4/0 | 5/0 |
| 3327     | RHO-4-LA   | 410<br>413 | Assorted    | 4                         | 1                      | 1-1/2 | 2   | 3   |     |
|          |            |            |             |                           | 5/0                    | 6/0   | 7/0 | 7/0 |     |
| 3376     | RHO-3XL    | 34184      | Assorted    | 3                         | 4                      |       | 5   | 6   |     |
|          |            |            |             |                           | 8/0                    |       |     |     |     |



Round Head Jig — All with Barb Collar, O'Shaughnessy Hooks and Standard Balance



Round Head Jig — Ring & Barb Collar, Strong 60-Degree O'Shaughnessy Jig Hooks

# ROUND HEAD JIG – STAGGERED BARB COLLAR

A popular lure for pan fisherman. This double-barb collar style is designed to tightly secure the small 1.5" and 2" hollow plastic tube skirts. The upper barb is short, wide and blunt to hold the small hollow skirts tightly to the head or to add gripping power to solid soft plastic tails.

| Item No. | Model No.  | Collar         | Model Group | Cavities           | Sizes (oz.) Hook Sizes |               |
|----------|------------|----------------|-------------|--------------------|------------------------|---------------|
|          |            |                |             |                    | 1/32                   | 1/16          |
| 3351     | RDB-8-1632 | Staggered Barb | Combination | 8<br>(4 each size) | 1/32                   | 1/16          |
|          |            |                |             |                    | 6 or 4                 | 4 or 2        |
| 3352     | RDB-8-M2   | Staggered Barb | Combination | 8<br>(4 each size) | 3/32                   | 3/16          |
|          |            |                |             |                    | 4 or 2                 | 1 or 1/0      |
| 3353     | RDB-8-48   | Staggered Barb | Combination | 8<br>(4 each size) | 1/8                    | 1/4           |
|          |            |                |             |                    | 2, 1 or 1/0            | 1, 1/0 or 2/0 |



570 or 575 Hooks

Round Head Jig — Staggered Barb Collar Aberdeen Hooks

# ROUND HEAD JIG – STEELHEAD

Anybody who has been on the receiving end of a beating by an oversized trout, knows that bending hooks are not your friend. Not an issue when you build your own. If you are looking for a jig with small weight and extra strong hook ... look no further.

| Item No. | Model No. | Hook Style | Model Group | Cavities           | Sizes (oz.) Hook Sizes |      |       |         |     |     |
|----------|-----------|------------|-------------|--------------------|------------------------|------|-------|---------|-----|-----|
|          |           |            |             |                    | 1/32                   | 1/16 | 1/8   | 1/4     | 3/8 | 1/2 |
| 3424     | STL-6-A   | 630<br>635 | Assorted    | 6                  | 1/32                   | 1/16 | 1/8   | 1/4     | 3/8 | 1/2 |
|          |           |            |             |                    | 1                      | 1/0  | 2/0   | 3/0     | 4/0 | 5/0 |
| 3468     | STL-8S-A  | 32833      | Assorted    | 8<br>(2 each size) | 1/64                   | 1/32 | 1/16  | 1/8     |     |     |
|          |           |            |             |                    | 10                     | 8    | 6     | 4       |     |     |
| 3469     | STL-8M-A  | 32833      | Assorted    | 8<br>(2 each size) | 1/16                   | 1/8  | 3/16  | 1/4     |     |     |
|          |           |            |             |                    | 4                      | 2    | 1-1/0 | 1/0-2/0 |     |     |



#3424  
630 - 635 Hooks



#3468 & #3469  
32833 Hook

Round Head Jig — No Collar, Strong O'Shaughnessy Jig Hooks



# ROUND HEAD JIG – WIRE KEEPER

The wire style keeper is the ultimate in plastic holding power. Fewer plastics slipping down the collar means more casts, more chances at your favorite lunker and maybe even a few dollars saved in lost plastics.

Also fits Owner style 5318 hooks.

| Item No. | Model No.   | Collar      | Model Group | Insert | Hook Style      | Cavities | Sizes (oz.)<br>Hook Sizes |      |     |      |     |      |
|----------|-------------|-------------|-------------|--------|-----------------|----------|---------------------------|------|-----|------|-----|------|
|          |             |             |             |        |                 |          | 1/32                      | 1/16 | 1/8 | 3/16 | 1/4 | 5/16 |
| 3484     | CRJ-6-WBA   | Wire Keeper | Holder      | WB400  | 570/575<br>5318 | 6        | 1/32                      | 1/16 | 1/8 | 3/16 | 1/4 | 5/16 |
|          |             |             |             |        |                 |          | 6                         | 4    | 1   | 1/0  | 1/0 | 2/0  |
| 3506     | CRJ-8-3224  | Wire Keeper | Combination | WB400  | 570/575         | 8        | (4) 1/32 (4) 1/24         |      |     |      |     |      |
|          |             |             |             |        |                 |          | 4 or 6                    |      |     |      |     |      |
| 3507     | CRJ-8-16332 | Wire Keeper | Combination | WB400  | 570/575         | 8        | (4) 1/16 (4) 3/32         |      |     |      |     |      |
|          |             |             |             |        |                 |          | 4 or 6                    |      |     |      |     |      |



Wire Form WB400  
see page 71

# SHAD DART JIG

A slant-faced, tapered jig that's named for migrating mid-Atlantic shad. The slanted head gives it a rising, "darting" action when the rod tip is raised.

| Item No. | Model No. | Type          | Collar | Hook Style | Model Group | Cavities                  | Sizes (oz.)<br>Hook Sizes |      |     |        |     |     |     |
|----------|-----------|---------------|--------|------------|-------------|---------------------------|---------------------------|------|-----|--------|-----|-----|-----|
|          |           |               |        |            |             |                           | 1/32                      | 1/16 | 1/8 | 1/4    | 3/8 | 1/2 | 3/4 |
| 3031     | JD-7-A    | Shad Dart Jig | None   | 570<br>575 | Assorted    | 7                         | 1/32                      | 1/16 | 1/8 | 1/4    | 3/8 | 1/2 | 3/4 |
|          |           |               |        |            |             |                           | 6                         | 4    | 2   | 1      | 1/0 | 2/0 | 3/0 |
| 3032     | JD-8-3264 | Shad Dart Jig | None   | 570<br>575 | Combination | 8<br>(4 each size)        | 1/64                      |      |     | 1/32   |     |     |     |
|          |           |               |        |            |             |                           | 8 or 10                   |      |     | 6 or 8 |     |     |     |
| 3360     | JD-8-1618 | Shad Dart Jig | None   | 570<br>575 | Combination | 8<br>(4 each size)        | 1/16                      |      |     | 1/8    |     |     |     |
|          |           |               |        |            |             |                           | 6 or 4                    |      |     | 2 or 1 |     |     |     |
| 1031     | JD-7-48   | Shad Dart Jig | None   | 570<br>575 | Combination | 7<br>(4 of 1/8, 3 of 1/4) | 1/8                       |      |     | 1/4    |     |     |     |
|          |           |               |        |            |             |                           | 2                         |      |     | 2/0    |     |     |     |



Shad Dart is typically tied with hair or feathers  
See page 85

# SHAD HEAD JIG

This streamlined jig head slices water like butter, even when you're up against strong currents. Soft plastics are well secured to the "Ring & Barb" collar, but this jig can also be finished with tied material.

| Item No. | Model No. | Type          | Collar      | Hook Style | Model Group | Cavities | Hook Sizes |     |       |     |     |
|----------|-----------|---------------|-------------|------------|-------------|----------|------------|-----|-------|-----|-----|
| 3115     | SHB-5-A   | Shad Head Jig | Ring & Barb | 630<br>635 | Assorted    | 5        | 1/4        | 3/8 | 1/2   | 3/4 | 1   |
|          |           |               |             |            |             |          | 1/0        | 2/0 | 3/0   | 4/0 | 5/0 |
| 3328     | SHB-3-L   | Shad Head Jig | Ring & Barb | 635        | Assorted    | 3        | 1          |     | 1-1/2 |     | 2   |
|          |           |               |             |            |             |          | 5/0        |     | 6/0   |     | 7/0 |
| 3329     | SHB-2-43  | Shad Head Jig | Ring & Barb | 91715      | Assorted    | 2        | 3          |     | 4     |     |     |
|          |           |               |             |            |             |          | 8/0        |     | 9/0   |     |     |

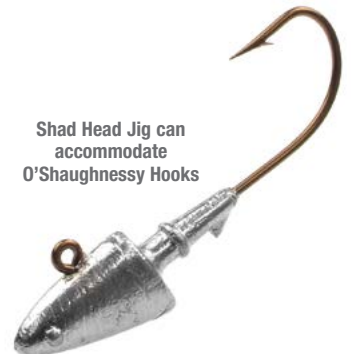

Shad Head Jig can accommodate O'Shaughnessy Hooks

# SPEARHEAD JIG

The sleek shape of the Spearhead Jig gives it a low water resistance. An excellent design for use below dams and other turbulent areas.

| Item No. | Model No. | Type          | Collar | Hook Style | Model Group | Cavities | Sizes (oz.)<br>Hook Sizes |     |          |     |               |
|----------|-----------|---------------|--------|------------|-------------|----------|---------------------------|-----|----------|-----|---------------|
| 3017     | JSP-5-A   | Spearhead Jig | Ball   | 630<br>635 | Assorted    | 5        | 1/4                       | 3/8 | 1/2      | 3/4 | 1             |
|          |           |               |        |            |             |          | 1                         | 1/0 | 1/0      | 2/0 | 3/0           |
| 3018     | JSP-3-L   | Spearhead Jig | Ball   | 630<br>635 | Assorted    | 3        | 1                         |     | 1-1/2    |     | 2             |
|          |           |               |        |            |             |          | 2/0, 3/0                  |     | 3/0, 4/0 |     | 4/0, 5/0, 6/0 |
| 3019     | JSP-2-43  | Spearhead Jig | Ball   | 635        | Assorted    | 2        | 3                         |     | 4        |     |               |
|          |           |               |        |            |             |          | 6/0                       |     | 7/0      |     |               |



Spearhead Jig offers low water resistance.

# SHAD HEAD RIG JIG

Fish alone or pair with an umbrella rig. Use Mustad Style 32886 Grass/Flippin Hook 30 degree round bend forged hook.

| Item No. | Model No. | Insert | Hook Style | Model Group | Cavities | Sizes (oz.) Eye Size Hook Sizes |      |     |      |     |      |
|----------|-----------|--------|------------|-------------|----------|---------------------------------|------|-----|------|-----|------|
|          |           |        |            |             |          | 1/8                             | 3/16 | 1/4 | 5/16 | 3/8 | 7/16 |
| 3499     | SHWB-6-A  | WB400  | 32886      | Assorted    | 6        | 2                               | 2    | 2.5 | 2.5  | 2.5 | 2.5  |
|          |           |        |            |             |          | 3/0                             |      |     | 4/0  |     |      |
|          |           |        |            |             |          |                                 |      |     |      |     |      |



Recessed eye sockets for stick-on lure eyes

# SHAKE-IT JIG

Whether you call it an "Alabama Rig", "Finesse Rig" or "Shakey Rig" this simple system has been lighting up the tournament trail. This mold design allows you to incorporate either the Flat Eye 60° Mustad 32798 or the Gamakatsu 604. Pick your favorite plastic, rig it Texas-style with the hook hid in the plastic, and finesse the big boy in.

| Item No. | Model No. | Collar      | Model Group | Cavities | Hook Style | Sizes (oz.) Hook Sizes |         |         |         |         |         |
|----------|-----------|-------------|-------------|----------|------------|------------------------|---------|---------|---------|---------|---------|
|          |           |             |             |          |            | 1/16                   | 1/8     | 3/16    | 1/4     | 5/16    | 3/8     |
| 3430     | SRH-6-A   | Ring & Barb | Assorted    | 6        | 604        | 2/0-3/0                | 2/0-3/0 | 3/0-4/0 | 3/0-4/0 | 3/0-4/0 | 3/0-4/0 |
|          |           |             |             |          | 32798BLN   | 3/0-4/0                | 3/0-4/0 | 4/0-5/0 | 4/0-5/0 | 4/0-5/0 | 4/0-5/0 |
| 3446     | SRH-6-14  | Ring & Barb | Production  | 6        | 604        | 1/4                    |         |         |         |         |         |
|          |           |             |             |          | 32798BLN   | 3/0-4/0                |         |         |         |         |         |
| 3447     | SRH-6-316 | Ring & Barb | Production  | 6        | 604        | 3/16                   |         |         |         |         |         |
|          |           |             |             |          | 32798BLN   | 3/0-4/0                |         |         |         |         |         |
| 3448     | SRH-6-18  | Ring & Barb | Production  | 6        | 604        | 1/8                    |         |         |         |         |         |
|          |           |             |             |          | 32798BLN   | 3/0-4/0                |         |         |         |         |         |
|          |           |             |             |          | 32798BLN   | 4/0-5/0                |         |         |         |         |         |



# SPIRE POINT JIG

Shaped like a modern rifle bullet, the Spire Point Jig is designed for trolling, casting and jigging. Larger sizes (8 oz. and up) require both a straight big game fish hook (Style 34081) and a brass wire eye.

| Item No. | Model No. | Collar | Stick-on Lure Eye | Hook Style | Model Group | Cavities | Sizes (oz.) Hook Sizes & Insert |     |       |     |     |  |
|----------|-----------|--------|-------------------|------------|-------------|----------|---------------------------------|-----|-------|-----|-----|--|
|          |           |        |                   |            |             |          | 1/8                             | 1/4 | 3/8   | 1/2 | 3/4 |  |
| 3279     | SPI-5-A   | Flair  | None              | 410<br>413 | Assorted    | 5        | 2                               | 1/0 | 2/0   | 3/0 | 4/0 |  |
|          |           |        |                   |            |             |          | 1                               |     | 1-1/2 |     | 2   |  |
| 3280     | SPI-3-L   | Flair  | 5/32" Size 2.5    | 410<br>413 | Assorted    | 3        | 5/0                             |     | 6/0   |     | 7/0 |  |
|          |           |        |                   |            |             |          | 3                               |     | 4     |     |     |  |
| 3281     | SPI-2-43  | Flair  | 1/4" Size 4       | 34184      | Assorted    | 2        | 8/0                             |     |       |     |     |  |
|          |           |        |                   |            |             |          | 5                               |     | 6     |     |     |  |
| 3282     | SPI-2-56  | Flair  | 9/32" Size 5      | 34184      | Assorted    | 2        | 8/0                             |     |       |     |     |  |
|          |           |        |                   |            |             |          | 8                               |     |       |     |     |  |
| 3283     | SPI-1-8B  | Flair  | 9/32" Size 5      | 34081      | Single      | 1        | 10/0 plus #3 Brass Eye*         |     |       |     |     |  |
|          |           |        |                   |            |             |          | 12                              |     |       |     |     |  |
| 3284     | SPI-1-12B | Flair  | 3/8" Size 6       | 34081      | Single      | 1        | 12/0 plus #3 Brass Eye*         |     |       |     |     |  |
|          |           |        |                   |            |             |          | 16                              |     |       |     |     |  |
| 3381     | SPI-1-16B | Flair  | 3/8" Size 6       | 34081      | Single      | 1        | 12/0 plus #3 Brass Eye*         |     |       |     |     |  |
|          |           |        |                   |            |             |          | 20                              |     |       |     |     |  |
| 3382     | SPI-1-20B | Flair  | 3/8" Size 6       | 34081      | Single      | 1        | 12/0 plus #3 Brass Eye*         |     |       |     |     |  |



The collar "flairs" bucktail or crimped nylon

Straight big game fish hook #3 brass wire eye see page 70



# SPARKIE JIG

Our special forward balance design allows the Sparkie Jig to pull over snags. The wide head shape will not let the jig tip to the side when it rests on the bottom. This enables the lure to be used with a slider method as well as regular jigging action.



410-413 Jig Hook  
See page 59

The wide head and forward balance keep the jig upright

| Item No. | Model No. | Type        | Collar | Hook Style | Model Group | Cavities | Hook Sizes |     |       |     |     |     |     |
|----------|-----------|-------------|--------|------------|-------------|----------|------------|-----|-------|-----|-----|-----|-----|
|          |           |             |        |            |             |          | 1/16       | 1/8 | 3/16  | 1/4 | 3/8 | 1/2 | 5/8 |
| 1080     | JKS-1080A | Sparkie Jig | Ball   | 410<br>413 | Assorted    | 7        | 4          | 2   | 1     | 1/0 | 2/0 | 3/0 | 4/0 |
|          |           |             |        |            |             |          | 3/4        | 1   | 1-1/2 |     |     |     |     |
| 1081     | JKS-1081L | Sparkie Jig | Ball   | 410<br>413 | Assorted    | 3        | 4/0        | 5/0 | 6/0   |     |     |     |     |

# STYLE "9" SHAD HEAD JIG

Catch your limit by 9:00 a.m. with this jig. This triangular version of the Shad Head excels in tough currents, so you'll beat the clock. Staggered barb securely holds plastic shad bodies and other thick plastic bodies.

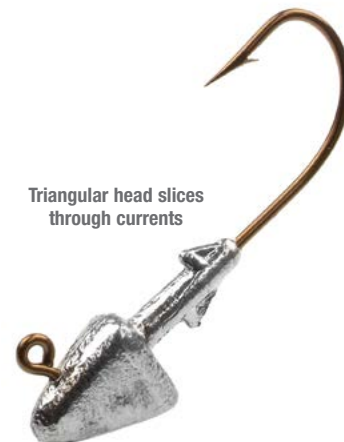

Triangular head slices through currents

| Item No. | Model No.  | Collar         | Hook Style | Shad Body Size | Model Group | Cavities           | Sizes (oz.) Hook Sizes |       |       |
|----------|------------|----------------|------------|----------------|-------------|--------------------|------------------------|-------|-------|
|          |            |                |            |                |             |                    | 1/4                    | 3/8   | 2/0   |
| 3235     | SH9-6-1438 | Staggered Barb | 635        | 3"             | Combination | 6<br>(3 each size) | 1/4                    | 3/8   | 2/0   |
| 3236     | SH9-4-1234 | Staggered Barb | 635        | 4"             | Combination | 4<br>(2 each size) | 1/2                    | 3/4   | 4/0   |
| 3237     | SH9-4-115  | Staggered Barb | 635        | 6"             | Combination | 4<br>(2 each size) | 1                      | 1-1/2 | 7/0   |
| 3354     | SH9-3-LA   | Staggered Barb | 91715      | 6"-9"          | Assorted    | 3                  | 1-1/2                  | 2     | 2-1/2 |
| 3355     | SH9-2-43   | Staggered Barb | 91715      | 6"-9"          | Assorted    | 2                  | 3                      | 4     | 8/0   |

# SWIMBAIT HEAD

The ergonomic head design of Do-It's SwimBait Head is the perfect marriage for paddletail swimbaits and is the newest addition to Do-It's growing line of soft plastic and Jig molds. The SwimBait Head gives the tackle-crafting junky the ability to customize it his way. The mold can be used with a variety of hook sizes and styles. Customize your jigs with your favorite oversized 90 degree jig hooks and bring your swimbaits to life by adding 3-D stick on eyes. Big paddletail swimbaits fit like a glove and stay there with the double barbed collar.

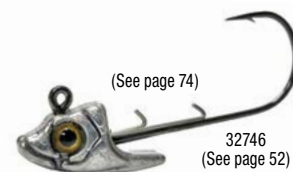

(See page 74)

32746  
(See page 52)  
32786  
(See page 51)

| Item No. | Model No. | Collar                    | Hook Style  | Model Group | Cavities | Sizes (oz.) Hook Sizes Stick-On Lure Eye |     |       |       |     |
|----------|-----------|---------------------------|---|-------------|----------|--|-----|-------|-------|-----|
|          |           |                           |   |             |          | 1/4                                      | 3/8 | 1/2   | 5/8   | 3/4 |
| 3523     | SBH-5-A   | WDB-1000<br>(See page 74) | 32746 or Similar 90 Degree Hooks<br>(See page 52) | Assorted    | 5        | 4/0                                      | 5/0 | 5/0   | 6/0   | 6/0 |
|          |           |                           |   |             |          | 2.5                                      | 2.5 | 4     | 4     | 4   |
|          |           |                           |   |             |          | 3/4                                      | 1   | 1-1/4 | 1-1/2 |     |
| 3524     | SBH-4-LA  | WDB-1000<br>(See page 74) | 32786BLN<br>(See page 51)                         | Assorted    | 4        | 4  | 5   | 5     | 5     |     |

# DINER SHINER

The Diner Shiner's unique profile and detail make this one of the most realistic baitfish imitations on the market. Your choice of your favorite 90 degree Aberdeen jig hook and the ability to pour them with or without wire keeper gives you full capability to customize it your way. Choose your favorite 3D Stick on eyes to really bring your jigs to life.



| Item No. | Model No. | Collar                  | Hook Style  | Model Group | Cavities | Sizes (oz.) Hook Sizes Stick-On Lure Eye |     |      |     |      |     |
|----------|-----------|-------------------------|---|-------------|----------|--|-----|------|-----|------|-----|
|          |           |                         |   |             |          | 1/16                                     | 1/8 | 3/16 | 1/4 | 5/16 | 3/8 |
| 3520     | DSJ-6-A   | WB-400<br>(See page 71) | 570 575 or Similar 90 Degree Hooks                | Assorted    | 6        | 2  | 2.5 | 2.5  | 2.5 | 2.5  | 2.5 |
|          |           |                         |   |             |          | 4  | 2   | 1    | 1/0 | 2/0  | 3/0 |
|          |           |                         |   |             |          | 3/8                                      | 1/2 | 5/8  | 3/4 | 1    |     |
| 3526     | DSJ-5-A   | WB-800<br>(See page 71) | 32746 or Similar 90 Degree Hooks<br>(See page 52) | Assorted    | 5        | 3/0                                      | 4/0 | 5/0  | 5/0 | 6/0  |     |
|          |           |                         |   |             |          | 2.5                                      | 4   |      |     |      |     |

# STAND UP HD JIG

The heavy-diameter version of the Stand Up Jig is made to accept the strong O'Shaughnessy hooks. Saltwater fishermen prefer the slow falling design of this flat-footed jig. Use a corrosion resistant hook if you're heading into saltwaters.

| Item No. | Model No. | Type            | Collar | Hook Style | Model Group | Cavities | Sizes (oz.) Hook Sizes |       |     |     |     |
|----------|-----------|-----------------|--------|------------|-------------|----------|------------------------|-------|-----|-----|-----|
|          |           |                 |        |            |             |          | 1/8                    | 1/4   | 3/8 | 1/2 | 3/4 |
| 3297     | SUHD-5-A  | Stand Up HD Jig | Barb   | 410        | Assorted    | 5        | 1                      | 2/0   | 3/0 | 4/0 | 5/0 |
|          |           |                 |        | 413        |             |          | 1                      | 2/0   | 3/0 | 4/0 | 5/0 |
| 3341     | SUHD-3-LA | Stand Up HD Jig | Barb   | 410        | Assorted    | 3        | 1                      | 1-1/2 | 2   |     |     |
|          |           |                 |        | 413        |             |          | 5/0                    | 6/0   | 7/0 |     |     |

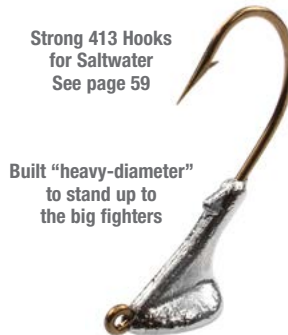

Strong 413 Hooks for Saltwater See page 59  
Built "heavy-diameter" to stand up to the big fighters

# TIP UP JIG

Intended for Walleye fishing, the name of the lure is descriptive of its action. This special stand up design will rotate to an upright position even if the jig lands on its side. A flat base with barb collar permits plastic grubs to fit up tight. Tip Up Jigs more closely approximate the familiar round head jig performance characteristics than do other stand up jig designs. For best tip up rotation, use the hook sizes and styles recommended for each size.

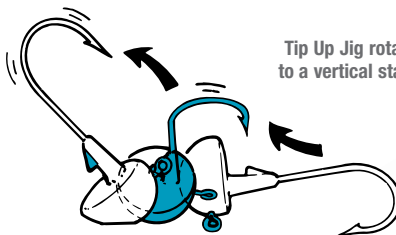

Tip Up Jig rotates to a vertical stance

| Item No. | Model No. | Type       | Collar       | Hook Style | Model Group | Cavities | Sizes (oz.) Hook Sizes |      |     |      |     |      |
|----------|-----------|------------|--------------|------------|-------------|----------|------------------------|------|-----|------|-----|------|
|          |           |            |              |            |             |          | 1/8                    | 3/16 | 1/4 | 5/16 | 3/8 | 7/16 |
| 3267     | TUJ-6-A   | Tip Up Jig | Reverse Barb | 570        | Assorted    | 6        | 6                      | 4    | 1   | 1/0  | 1/0 | 2/0  |
|          |           |            |              | 575        |             |          | 1/8                    | 3/16 | 1/4 | 5/16 | 3/8 | 7/16 |



# TAPERED TUBE SKIRT JIG

This style jig head is designed for speed loading into hollow plastic tubular jig skirts. Speed loading permits skirt collar changes without untying the jig from the line. These lures are easy to make and require no painting or finishing work.

| Item No. | Model No. | Type              | Tube Skirt Size       | Hook Style | Model Group | Cavities   | Sizes (oz.) Hook Sizes |      |     |      |     |      |
|----------|-----------|-------------------|-----------------------|------------|-------------|------------|------------------------|------|-----|------|-----|------|
|          |           |                   |                       |            |             |            | 1/32                   | 1/16 | 1/8 | 3/16 | 1/4 | 5/16 |
| 3217     | TUBE-TA   | Tube Jig Style TA | 1-1/2" Small Dia.     | 570        | Combination | 8 (4 each) | 6                      | 4    |     |      |     |      |
|          |           |                   |                       | 575        |             |            | 1/32                   | 1/16 |     |      |     |      |
| 3232     | TUBE-TT32 | Tube Jig Style TA | 1-1/2" Small Dia.     | 570        | Production  | 8          | 6 or 4                 |      |     |      |     |      |
|          |           |                   |                       | 575        |             |            | 1/32                   |      |     |      |     |      |
| 3233     | TUBE-TT16 | Tube Jig Style TA | 1-1/2" Small Dia.     | 570        | Production  | 8          | 6 or 4                 |      |     |      |     |      |
|          |           |                   |                       | 575        |             |            | 1/16                   |      |     |      |     |      |
| 3218     | TUBE-TC   | Tube Jig Style TC | 2-1/2" - 4" Med. Dia. | 570        | Assorted    | 5          | 2/0 or 3/0             |      |     |      |     |      |
|          |           |                   |                       | 575        |             |            | 1/8                    | 3/16 | 1/4 | 5/16 | 3/8 |      |
| 3364     | TUBE-TC18 | Tube Jig Style TC | 2-1/2" - 4" Med. Dia. | 570        | Production  | 6          | 2/0 or 3/0             |      |     |      |     |      |
|          |           |                   |                       | 575        |             |            | 1/8                    |      |     |      |     |      |
| 3365     | TUBE-TC14 | Tube Jig Style TC | 2-1/2" - 4" Med. Dia. | 570        | Production  | 6          | 2/0 or 3/0             |      |     |      |     |      |
|          |           |                   |                       | 575        |             |            | 1/4                    |      |     |      |     |      |
| 3366     | TUBE-TC38 | Tube Jig Style TC | 2-1/2" - 4" Med. Dia. | 570        | Production  | 6          | 2/0 or 3/0             |      |     |      |     |      |
|          |           |                   |                       | 575        |             |            | 3/8                    |      |     |      |     |      |
| 3219     | TUBE-TX   | Tube Jig Style TX | 2-1/2" - 4" Med. Dia. | 410        | Assorted    | 5          | 2/0 or 3/0             |      |     |      |     |      |
|          |           |                   |                       | 413        |             |            | 1/8                    | 3/16 | 1/4 | 5/16 | 3/8 |      |

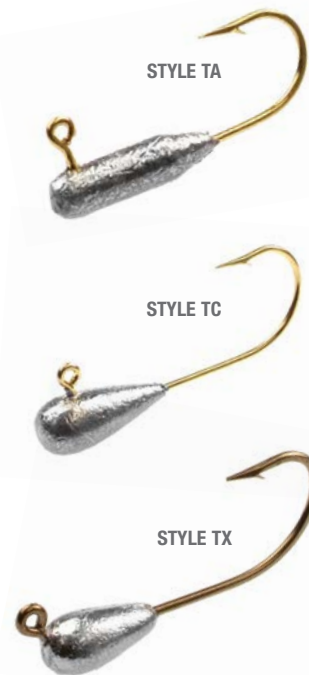

# SPEED LOADING A TAPERED TUBE SKIRT JIG

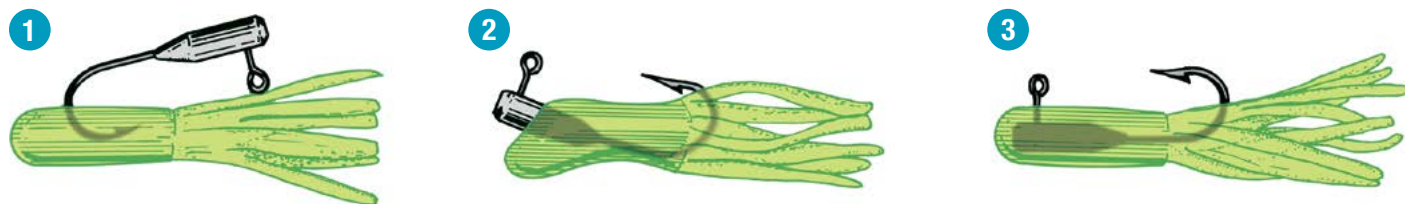



# SWM JIG

The SWM Jig is a swimming type jig whose wobble action is especially successful in attracting fish. Style 2190B hooks have been specially developed for use with SWM jigs made with DO-it® Molds. These jigs may be painted and fished without dressing or can be tipped with live bait for an even more effective lure. Cast, troll, or jig vertically with this versatile bait jig.



| Item No. | Model No. | Type    | Collar | Hook Style | Model Group | Cavities | Sizes (oz.) Hook Sizes |     |     |
|----------|-----------|---------|--------|------------|-------------|----------|------------------------|-----|-----|
|          |           |         |        |            |             |          | 1/8                    | 1/4 | 3/8 |
| 3242     | SWM-3-A   | SWM Jig | None   | 2190B      | Assorted    | 3        | 4                      | 1/0 | 2/0 |
|          |           |         |        |            |             |          | 1/8                    | 1/4 | 3/8 |

# STYLE "H" JIG

The "H" stands for a "helluva" jig. So versatile, it attracts both fresh and saltwater game fish. The swollen, pregnant belly stabilizes the lure as it cuts through the water. Recessed eye sockets accommodate stick-on decal eyes. The ball collars can be tied with bucktail or other material. Style "H" with barb collars permit easy attachment of plastic tails, grubs or bodies.



| Item No. | Model No. | Type                       | Collar      | Stick-on Eye   | Hook Style        | Model Group | Cavities | Sizes (oz.) Hook Sizes |     |       |     |     |
|----------|-----------|----------------------------|-------------|----------------|-------------------|-------------|----------|------------------------|-----|-------|-----|-----|
|          |           |                            |             |                |                   |             |          | 3/8                    | 1/2 | 5/8   | 3/4 | 1   |
| 3335     | BTH-5-A   | Style "H" Bucktail Jig     | Ball        | 5/32" Size 2.5 | 630, 635 410, 413 | Assorted    | 5        | 2/0                    | 3/0 | 3/0   | 4/0 | 5/0 |
|          |           |                            |             |                |                   |             |          | 3/8                    | 1/2 | 5/8   | 3/4 | 1   |
| 3305     | BTH-3-L   | Style "H" Bucktail Jig     | Ball        | 1/4" Size 4    | 635 410-413       | Assorted    | 3        | 1-1/2                  | 2   | 2-1/2 |     |     |
|          |           |                            |             |                |                   |             |          | 5/0                    | 6/0 | 7/0   |     |     |
| 3319     | PGH-5-A   | Style "H" Plastic Grub Jig | Barb        | 5/32" Size 2.5 | 630-635 410-413   | Assorted    | 5        | 2/0                    | 3/0 | 3/0   | 4/0 | 5/0 |
|          |           |                            |             |                |                   |             |          | 3/8                    | 1/2 | 5/8   | 3/4 | 1   |
| 3320     | PGH-3-L   | Style "H" Plastic Grub Jig | Barb        | 1/4" Size 4    | 635 410-413       | Assorted    | 3        | 1-1/2                  | 2   | 2-1/2 |     |     |
|          |           |                            |             |                |                   |             |          | 5/0                    | 6/0 | 7/0   |     |     |
| 3321     | PGH-2-43  | Style "H" Plastic Grub Jig | Ring & Barb | 9/32" Size 5   | 34184 Only        | Assorted    | 2        | 3 oz                   |     | 4 oz  |     |     |
|          |           |                            |             |                |                   |             |          | 8/0                    |     |       |     |     |

# TEARDROP JIG

The teardrop design places most of this jig's weight in a far forward position. The weight distribution gives this lure a good tracking or swimming action on retrieve and a "bombing" nose-first fall when jigged.



| Item No.            | Model No. | Collar            | Hook Style   | Model Group | Cavities | Sizes (oz.) Hook Sizes |       |       |       |            |         |            |
|---------------------|-----------|-------------------|--------------|-------------|----------|------------------------|-------|-------|-------|------------|---------|------------|
|                     |           |                   |              |             |          | 1/16                   | 1/8   | 1/4   | 3/8   | 1/2        | 5/8     |            |
| 3287                | JT-6-A    | Holder            | 570 575      | Assorted    | 6        | 2                      | 1     | 1/0   | 2/0   | 3/0        | 4/0     |            |
|                     |           |                   |              |             |          | 1/16                   | 1/8   | 1/4   | 3/8   | 1/2        | 5/8     |            |
| 3301                | JTS-5-A   | Holder            | 630 635      | Assorted    | 5        | 1/0                    | 2/0   | 3/0   | 4/0   | 5/0        |         |            |
|                     |           |                   |              |             |          | 1/4                    | 3/8   | 1/2   | 3/4   | 1          |         |            |
| 3486 Needs Wireform | JT-7-WBA  | WB400 Wire Keeper | 570/575 5318 | Assorted    | 7        | 1.5 eye                | 2 eye | 2 eye | 2 eye | 2.5 eye    | 2.5 eye | 2.5 eye    |
|                     |           |                   |              |             |          | 1/16                   | 1/8   | 3/16  | 1/4   | 5/16       | 3/8     | 1/2        |
|                     |           |                   |              |             |          | 2                      | 1     | 1/0   | 1/0   | 2/0 or 3/0 | 3/0     | 3/0 or 4/0 |

# LARGE TEARDROP JIG

The Teardrop shape has long been a favorite of river fishermen. The bait tracks well in heavy current, dives nose first, and delivers a plastic to fish in a way so natural that hardly a fish in the system can resist T-Boning it. This larger version (5/8 – 1 1/2 Ounces) now allows a fishermen to get down deep to fish heavy current high winds or cast swimbaits a mile. Pour these up with wire keepers to keep plastics and live bait in place and from sliding down the hook shank. Make it rain on your favorite body of water today with the Large Teardrop Jig from Do-It.



| Item No. | Model No. | Collar            | Hook Style | Model Group | Cavities | Sizes (oz.) Hook Sizes Stick-On Lure Eye |     |     |       |       |
|----------|-----------|-------------------|------------|-------------|----------|--|-----|-----|-------|-------|
|          |           |                   |            |             |          | 5/8                                      | 3/4 | 1   | 1 1/4 | 1 1/2 |
| 3505     | JT-5-WBA  | WB400 Wire Keeper | 32746      | Assorted    | 5        | 4/0                                      | 4/0 | 5/0 | 5/0   | 6/0   |
|          |           |                   |            |             |          | 2.5                                      | 2.5 | 4   | 4     | 5     |
|          |           |                   |            |             |          | 5/8                                      | 3/4 | 1   | 1 1/4 | 1 1/2 |

# ULTRA MINNOW JIG

Start with our center balanced "Style H" design and add a holder collar, gill plates, fins, lips, scales and recessed eyes with pronounced brow and you have the ultimate in detail. #3384 will also accept Eagle Claw 410, 413, 630 or 635 series in the following sizes: 1/2 oz. - 2/0, 3/4 oz. - 3/0, 1 oz. - 4/0, and 1-1/2 oz. - 5/0. Item 3389 will also accept Eagle Claw 570/575 series hooks in the following sizes: 1/8 oz. - 1, 1/4 oz. - 1/0, 3/8 oz. - 2/0, 1/2 oz. - 3/0 and 5/8 oz. - 4/0.



Recessed Eye Sockets for 2D or 3D Lure Eyes  
See page 77

| Item No. | Model No. | Type             | Collar | Stick-on Eye                                | Hook Style     | Model Group | Cavities | Sizes (oz.) Hook Sizes |     |     |       |     |
|----------|-----------|------------------|--------|---|----------------|-------------|----------|------------------------|-----|-----|-------|-----|
|          |           |                  |        |   |                |             |          | 1/2                    | 3/4 | 1   | 1-1/2 |     |
| 3384     | SHR-4-M   | Ultra Minnow Jig | Holder | 5/32" Size 2.5                              | 32786BLN       | Assorted    | 4        | 2/0                    | 3/0 | 4/0 | 5/0   |     |
| 3389     | SHR-5-A   | Ultra Minnow Jig | Holder | 5/32" Size 2.5                              | Gamakatsu 604  | Assorted    | 5        | 1/8                    | 1/4 | 3/8 | 1/2   | 5/8 |
|          |           |                  |        |   |                |             |          | 1/0                    | 2/0 | 3/0 | 4/0   | 5/0 |
| 3417     | SHR-3-L   | Ultra Minnow Jig | Holder | 9/32" Size 5<br>9/32" Size 5<br>3/8" Size 6 | 34184<br>91715 | Assorted    | 3        | 2                      | 3   | 4   |       |     |
|          |           |                  |        |   |                |             |          | 8/0                    |     |     |       |     |
| 3473     | SHR-3-568 | Ultra Minnow Jig | Holder | 3/8" Size 6                                 | Mustad 91715   | Assorted    | 3        | 5                      | 6   | 8   |       |     |
|          |           |                  |        |   |                |             |          | 9/0                    |     |     |       |     |

# TUBE SKIRT JIG

Just slip these jig heads inside hollow plastic tube skirts and go fishing. No painting or finishing necessary. Tube skirt jigs are designed for a friction fit inside the designated skirt sizes.

| Item No. | Model No. | Type     | Tube Skirt Size     | Hook Style | Model Group | Cavities           | Sizes (oz.) Hook Sizes |      |     |
|----------|-----------|----------|---------------------|------------|-------------|--------------------|------------------------|------|-----|
|          |           |          |                     |            |             |                    | 1/32                   | 1/16 |     |
| 3070     | TUBE-S    | Tube Jig | 1-1/2" Small Dia.   | 570<br>575 | Combination | 8<br>(4 each size) | 6 or 4                 |      |     |
| 3071     | TUBE-M    | Tube Jig | 2-1/2"-4" Med. Dia. | 570<br>575 | Combination | 6<br>(2 each size) | 1/8                    | 1/4  | 3/8 |
|          |           |          |                     |            |             |                    | 1/0, 2/0, 3/0          |      |     |



# TUBE & TAIL JIG

A versatile Bass and game fish lure with a special design for rigging in many ways. It can be inserted inside tube skirts or a plastic tail can be attached to the back. Both plastic bodies can be combined to make a truly soft and doubly effective bait. A "holder" collar will also accept rubber skirts and tie on dressings.

| Item No. | Model No. | Type            | Tube Skirt Size | Hook Style | Model Group | Cavities           | Sizes (oz.) Hook Sizes |     |     |     |     |
|----------|-----------|-----------------|-----------------|------------|-------------|--------------------|------------------------|-----|-----|-----|-----|
|          |           |                 |                 |            |             |                    | 1/8                    | 1/4 | 3/8 | 1/2 | 3/4 |
| 3268     | TUBE-G    | Tube & Tail Jig | Holder          | 570<br>575 | Assorted    | 5                  | 4/0                    |     |     |     |     |
| 3072     | TUBE-U    | Tube & Tail Jig | Barb            | 630<br>635 | Combination | 6<br>(3 each size) | 1/8                    | 1/4 |     |     |     |
|          |           |                 |                 |            |             |                    | 1/0 or 2/0             |     |     |     |     |

TUBE-G  
"Holder" Collar  
570 or 575 Hooks



TUBE-U  
"Barb" Collar  
630 or 635 Hooks



# WOBBLE JIG

Slow drift through the feeding zone with a side to side wobble.

| Item No. | Model No. | Hook Style | Model Group | Cavities | Sizes (oz.) Hook Sizes |     |     |     |
|----------|-----------|------------|-------------|----------|------------------------|-----|-----|-----|
|          |           |            |             |          | 1/16                   | 1/8 | 1/4 | 3/8 |
| 3494     | CWJ-4     | 570<br>575 | Assorted    | 4        | 4                      | 1   | 1/0 | 2/0 |





# WORM NOSE JIG

Rigging a plastic worm to a jig makes an effective lure. Small, sharp hooks are used in this lure, so small they are undetected by the fish as it inhales the worm. The fish can actually hook itself when it tries to spit this lure out. Choose between double barb collar or the Screw-Loc to lock your plastic in place.

| Item No. | Model No. | Type      | Collar                   | Model Group | Cavities | Hook Style | Sizes (oz.)<br>Hook Sizes |     |      |     |      |         |
|----------|-----------|-----------|--------------------------|-------------|----------|------------|---------------------------|-----|------|-----|------|---------|
|          |           |           |                          |             |          |            | 3/32                      | 1/8 | 3/16 | 1/4 | 5/16 |         |
| 3183     | WORM-A    | Worm Nose | Double Barb              | Assorted    | 5        | 570        | 3/32                      | 1/8 | 3/16 | 1/4 | 5/16 |         |
|          |           |           |                          |             |          | 575        | 2                         | 1   | 1/0  | 2/0 | 2/0  |         |
| 3472     | WRM-6-SLA | Worm Nose | No Collar with Screw-Loc | Assorted    | 6        | 570        | 1/16                      | 1/8 | 3/16 | 1/4 | 5/16 | 3/8     |
|          |           |           |                          |             |          | 575        | 2                         | 1   | 1/0  | 2/0 | 3/0  | 4/0     |
|          |           |           |                          |             |          | 5318       | #1                        | 1/0 | 2/0  | 3/0 | 4/0  | 4/0-5/0 |

Note: #3472 requires Screw-Loc.



# WALLEYE JIG

So you're going after the picky "pickerel." Grab this lure. Its head is designed to resist snags on rocky bottoms, and gets in where others can't! The tapered, wedge-shaped Walleye Jig slips between stones that would hang up a typical round head jig. Item #3418 has been re-designed with a ring and barb collar and a recessed area for stick-on lure eyes (page 77).



| Item No. | Model No. | Type        | Collar      | Hook Style | Model Group | Cavities           | Sizes (oz.)<br>Hook Sizes |         |         |          |            |            |            |
|----------|-----------|-------------|-------------|------------|-------------|--------------------|---------------------------|---------|---------|----------|------------|------------|------------|
|          |           |             |             |            |             |                    | 1/16                      | 3/32    | 1/8     | 1/4      | 3/8        | 1/2        | 5/8        |
| 1065     | WHB-7-A   | Walleye Jig | Barb        | 570<br>575 | Assorted    | 7                  | 1/16                      | 3/32    | 1/8     | 1/4      | 3/8        | 1/2        | 5/8        |
|          |           |             |             |            |             |                    | 4                         | 2       | 1       | 1/0      | 2/0        | 3/0        | 4/0        |
| 1067     | WHB-48C   | Walleye Jig | Barb        | 570<br>575 | Combination | 8<br>(4 each size) | 1/8                       |         |         | 1/4      |            |            |            |
|          |           |             |             |            |             |                    | 2 or 1                    |         |         | 1 or 1/0 |            |            |            |
| 1071     | JW-7-A2   | Walleye Jig | Ball        | 570<br>575 | Assorted    | 7                  | 1/16                      | 3/32    | 1/8     | 1/4      | 3/8        | 1/2        | 5/8        |
|          |           |             |             |            |             |                    | 4                         | 2       | 1       | 1/0      | 2/0        | 3/0        | 4/0        |
| 3418     | WHJ-7-AR  | Walleye Jig | Ring & Barb | 570<br>575 | Assorted    | 7                  | 1/16                      | 3/32    | 1/8     | 1/4      | 3/8        | 1/2        | 5/8        |
|          |           |             |             |            |             |                    | 4 or 6                    | 2 or 4  | 1 or 2  | 1/0 or 1 | 2/0 or 3/0 | 3/0 or 4/0 | 4/0 or 3/0 |
|          |           |             |             |            |             |                    | 2.5 eye                   | 2.5 eye | 2.5 eye | 2.5 eye  | 2.5 eye    | 4 eye      | 4 eye      |

# WEIGHTED HOOK JIG

Swimbait are all the rage these days. With lots of different plastics and hook choices out there, we built our mold to fit as many different options as possible for you. Integrating our own geometrical design, you will find that our bait maximizes hook setting and creates a true running, well balanced bait.

| Item No. | Model No.  | Type              | Model Group | Cavities | Hook Style | Sizes (oz.)<br>Hook Sizes |                   |          |         |
|----------|------------|-------------------|-------------|----------|------------|---------------------------|-------------------|----------|---------|
|          |            |                   |             |          |            | 1/16                      | 1/8               | 3/16     | 1/4     |
| 3454     | SMB-4S-EWG | Weighted Hook Jig | Assorted    | 4        | 243        | 3/0-4/0                   | 3/0-5/0           | 3/0-5/0  | 3/0-5/0 |
|          |            |                   |             |          | 744        | 2/0-5/0                   | 2/0-6/0           | 2/0      | 6/0     |
|          |            |                   |             |          | 38104      | 3/0                       | 3/0-4/0           | 4/0-5/0  | 4/0-5/0 |
|          |            |                   |             |          | 91768BLN   | 1/16                      | 1/8               | 3/16     | 1/4     |
| 3456     | SMB-4-MTD  | Weighted Hook Jig | Assorted    | 4        | 3/0-4/0    | 3/0-5/0                   | 3/0-5/0           | 3/0-5/0  |         |
|          |            |                   |             |          | 3455       | SMB-3L-MTD                | Weighted Hook Jig | Assorted | 3       |
| 3455     | SMB-3L-MTD | Weighted Hook Jig | Assorted    | 3        | 91768      | 6/0-7/0                   | 7/0-8/0           | 7/0-8/0  |         |
|          |            |                   |             |          | 6/0        | 8/0                       | 8/0               |          |         |



For Hitching Post  
See page 71



# RANDY HOWELL SHAKY HEAD SERIES

2014 Bassmaster Classic Champion, Randy Howell, has teamed up with Do-it Molds to bring you the all new Randy Howell Shaky Head Series. If Randy could only own a handful of jigs to make a living fishing tournaments all across the country with, one of those jigs would certainly be a Shaky Head, and it was with that in mind that Do-it and Randy teamed up to design a pair of Signature Series molds that would produce some of the finest quality Shaky Heads on the market. Available in the Magnum size or the Finesse size, these jigs offer just the right combination of size shape and hook to bring the big ones topside.

## RANDY HOWELL FINESSE SHAKY HEAD

The Randy Howell Finesse Shaky Head features a reverse barb lead collar that holds a worm perfectly in place. The Gamakatsu 111 placement in the mold has been fine tuned and placed to maximize hook up percentages and allow the angler to perfectly present a Shaky Head worm to get the most action possible. Finesse those subtle biters with the Randy Howell Finesse Shaky Head in sizes 1/8th up to 3/8's and round out your limit today.

| Item No. | Model No. | Collar | Model Group | Cavities | Hook Style                    | Sizes (oz.)<br>Hook Sizes |         |         |         |         |
|----------|-----------|--------|-------------|----------|-------------------------------|---------------------------|---------|---------|---------|---------|
|          |           |        |             |          |                               | 1/18                      | 3/16    | 1/4     | 5/16    | 3/8     |
| 3508     | RHF-5-A   | Barb   | Assorted    | 5        | Gamakatsu Style 111 Jig Hooks | 3/0-5/0                   | 3/0-5/0 | 3/0-5/0 | 3/0-5/0 | 3/0-5/0 |
|          |           |        |             |          |                               |                           |         |         |         |         |



## RANDY HOWELL MAGNUM SHAKY HEAD

Framed around a Gamakatsu 7/0-8/0 604 round bend heavy wire hook the Randy Howell Magnum Series Shaky Head is meant for some serious power finesse fishing. The unique designed head that comes in sizes 3/8's all the way up to 1 1/4 is the ultimate jig for power finesse fishing ledges at your favorite body of water. Much like the Finesse version, the Magnum presents a big worm straight up every time. This jig also features a reverse barb collar that holds a worm in place yet leaves ample hook gap for powerful hook sets. When it comes to power finesse fishing...Make it a Magnum.

| Item No. | Model No. | Collar | Model Group | Cavities | Hook Style  | Sizes (oz.)<br>Hook Sizes |         |         |         |         |
|----------|-----------|--------|-------------|----------|---|---------------------------|---------|---------|---------|---------|
|          |           |        |             |          |   | 3/8                       | 1/2     | 3/4     | 1       | 1 1/4   |
| 3509     | RHM-5-A   | Barb   | Assorted    | 5        | Gamakatsu Style 604 Round Bend Heavy Wire Jig Hooks | 7/0-8/0                   | 7/0-8/0 | 7/0-8/0 | 7/0-8/0 | 7/0-8/0 |
|          |           |        |             |          |   |                           |         |         |         |         |



## MIDWEST FINESSE JIG

Do-It molds has engineered a mold that makes one of the hottest baits in bass fishing. Do-It's new Midwest Finesse Jig Mold can make up to 6 sizes of the popular stand up jig many refer to as the Ned Rig. From 1/16th up to 1/4 oz and all the sizes in between the Midwest Finesse is a must have jig mold to add to your arsenal. The Midwest Finesse Head works great with Do-It's Gary Yamamoto Senko line of molds and has a wire keeper that helps keep the plastic securely seated up against the head without sliding.

| Item No. | Model No. | Collar            | Model Group | Cavities | Hook Style            | Sizes (oz.)<br>Hook Sizes |      |     |      |      |     |
|----------|-----------|-------------------|-------------|----------|-----------------------|---------------------------|------|-----|------|------|-----|
|          |           |                   |             |          |                       | 1/16                      | 3/32 | 1/8 | 5/32 | 3/16 | 1/4 |
| 3513     | MFJ-6-A   | WB400 Wire Keeper | Assorted    | 6        | Owner Hook Style 5313 | #1 or 1/0                 |      |     |      |      |     |
|          |           |                   |             |          |                       |                           |      |     |      |      |     |



Do-it Wire Keeper Form WB400 Item #2609 (.026 wire dia.) See page 71

## POISON SWINGTAIL JIG

Framed around our ever popular Poison Tail Jig, but with the added benefits of a swinging style hook, the Poison Swingtail is sure to give you an edge on the water. The Poison Swingtail is one of few swing style jigs on the market that feature a holding style collar which is great for both tying bucktail and easily attaching silicone/rubber skirts. The STW Wire forms allow you to easily attach any of your favorite hooks to stick those lunker largemouth. Swing in the big ones with the Poison Swingtail.

| Item No. | Model No. | Collar | Model Group | Cavities | Hook Style                 | Sizes (oz.)<br>Eye Size |     |                    |
|----------|-----------|--------|-------------|----------|----------------------------|-------------------------|-----|--------------------|
|          |           |        |             |          |                            | 1/8                     | 1/4 | 3/8                |
| 3517     | PST-6-A   | Holder | Assorted    | 6        | Swingtail Wire form STW130 | 1/8" Size 2 Eye         |     | 5/32" Size 2.5 Eye |
|          |           |        |             |          |                            | 1/2                     |     | 1                  |
|          |           |        |             |          | Swingtail Wire form STW155 | 5/32" Size 2.5 Eye      |     | 1/4" Size 4 Eye    |
|          |           |        |             |          |                            |                         |     |                    |



Do-it Swingtail Wire Form STW130 Item #2625 and #2626 STW155 Item #2627 and #2628 See page 74

# PRO-SERIES

Our Do-it® MOLD PRO-SERIES is designed to meet the volume production requirements of commercial tackle manufacturers. Pro-Series models will save considerable production time when hundreds or thousands of a single size must be cast. Each model in this series features multiple

identical cavities. The pouring gates of the Pro-Series are minimal sized which requires more ideal pouring conditions (lead alloy, temperature, pouring method) than the standard gating used on other models, but has the advantage of very quick and clean sprue removal.

## PRO-100 SERIES

Round Head Jig with Ball Collar  
570 - 575 Hooks & Standard Balance

| Item No. | Size | Cavities | Hook Sizes |
|----------|------|----------|------------|
| 1240     | 1/32 | 7        | 6          |
| 1241     | 1/16 | 7        | 6 or 4     |
| 1242     | 1/8  | 7        | 1 or 2     |
| 1243     | 1/4  | 7        | 1/0        |



## PRO-101 SERIES

Round Head Jig without Collar  
570 - 575 Hooks & Standard Balance

| Item No. | Size | Cavities | Hook Sizes |
|----------|------|----------|------------|
| 1249     | 1/32 | 7        | 8 or 6     |
| 1250     | 1/16 | 7        | 6 or 4     |
| 1251     | 1/8  | 7        | 1/0 or 2/0 |
| 1252     | 1/4  | 7        | 2/0        |



## PRO-102 SERIES

Round Head Jig with Tapered Barb Collar  
570 - 575 Hooks & Standard Balance

| Item No. | Size | Cavities | Hook Sizes |
|----------|------|----------|------------|
| 1256     | 1/32 | 7        | 6          |
| 1257     | 1/16 | 7        | 4          |
| 1258     | 1/8  | 7        | 1 or 1/0   |
| 1259     | 1/4  | 7        | 2/0        |



## PRO-103 SERIES

Round Head Jig with Ball Collar  
630-635 Hooks & Standard Balance

| Item No. | Size | Cavities | Hook Sizes |
|----------|------|----------|------------|
| 1265     | 1/8  | 7        | 1 or 1/0   |
| 1266     | 1/4  | 6        | 1/0 or 2/0 |
| 1268     | 3/8  | 5        | 3/0        |



## PRO-104 SERIES

Round Head Jig with Barb Collar  
630-635 Hooks & Standard Balance

| Item No. | Size | Cavities | Hook Sizes |
|----------|------|----------|------------|
| 1271     | 1/8  | 7        | 1 or 1/0   |
| 1272     | 1/4  | 6        | 1/0 or 2/0 |
| 1274     | 3/8  | 5        | 3/0        |



## PRO-106 SERIES

Round Head Jig with Ring & Barb Collar  
630-635 Hooks & Standard Balance

| Item No. | Size | Cavities | Hook Sizes |
|----------|------|----------|------------|
| 1261     | 1/8  | 7        | 1/0 or 2/0 |
| 1262     | 1/4  | 6        | 2/0 or 3/0 |
| 1263     | 3/8  | 5        | 4/0        |



# ULTRA PRECISION SEMI-CUSTOM MOLDS

Semi-Custom ultra precise molds are designed to exacting standards for professional use. Very small jigs require molds made to extremely tight tolerances. These molds are completely machined from our blank mold frame using a computer-controlled mill. Each cavity, hook receptacle and pouring gate is individually milled to perfect alignment and fit. Pouring gates are designed for the professional

with minimum opening to permit quick and clean sprue twist off. Minimum gates make pressure casting from a bottom-pour lead furnace mandatory with these molds. Semi-Custom models are exceptionally accurate and precise. The investment in these molds can be quickly recovered through increased productivity when producing small jigs in commercial quantities.

## SEMI-CUSTOM ROUND HEAD JIG

No Collar  
570-575 Size #10 Hooks

| Item No. | Size  | Cavities | Hook Sizes |
|----------|-------|----------|------------|
| 64       | 1/64  | 10       | 10 or 12   |
| 80       | 1/80  | 10       | 10 or 12   |
| 100      | 1/100 | 10       | 10 or 12   |



## SEMI-CUSTOM ROUND HEAD JIG

Plain Collar  
570-575 Size #10 Hooks

| Item No. | Size | Cavities | Hook Sizes |
|----------|------|----------|------------|
| 65       | 1/64 | 10       | 10 or 12   |
| 81       | 1/80 | 10       | 10 or 12   |





# ROUND HEAD JIG

Our vote for the Most Valuable Player in your line-up. The Round Head Jig is the most popular all-around head style used in all water types in the world. Probably responsible

Additional Models Listed Under Pro-Series. See page 22

## 570 or 575 Hooks

**Round Head Jig — All with Ball Collar, Aberdeen Hooks and Standard Balance.**

| Item No. | Model No. | Model Group | Cavities                  | Sizes (oz.)<br>Hook Sizes |      |     |     |      |     |     |  |
|----------|-----------|-------------|---------------------------|---------------------------|------|-----|-----|------|-----|-----|--|
|          |           |             |                           | 1/32                      | 1/16 | 1/8 | 1/4 | 5/16 | 3/8 | 1/2 |  |
| 1001     | JR-7-A    | Assorted    | 7                         | 1/32                      | 1/16 | 1/8 | 1/4 | 5/16 | 3/8 | 1/2 |  |
|          |           |             |                           | 6                         | 4    | 2   | 1   | 1/0  | 2/0 | 3/0 |  |
| 1002     | JR-8-1632 | Combination | 8<br>(4 each size)        | 1/32                      |      |     |     | 1/16 |     |     |  |
|          |           |             |                           | 6                         |      |     |     | 4    |     |     |  |
| 1061     | JR-1061   | Combination | 8<br>(4 each size)        | 1/16                      |      |     |     | 1/8  |     |     |  |
|          |           |             |                           | 4                         |      |     |     | 2    |     |     |  |
| 1003     | JR-8-48   | Combination | 8<br>(4 each size)        | 1/8                       |      |     |     | 1/4  |     |     |  |
|          |           |             |                           | 1                         |      |     |     | 1/0  |     |     |  |
| 1004     | JR-6-3812 | Combination | 6<br>(3 each size)        | 3/8                       |      |     |     | 1/2  |     |     |  |
|          |           |             |                           | 2/0                       |      |     |     | 3/0  |     |     |  |
| 1005     | JR-5-5834 | Combination | 5<br>(3 of 5/8, 2 of 3/4) | 5/8                       |      |     |     | 3/4  |     |     |  |
|          |           |             |                           | 4/0                       |      |     |     | 4/0  |     |     |  |



## 570 or 575 Hooks

**Round Head Jig — All with No Collar, Aberdeen Hooks and Standard Balance**

| Item No. | Model No.  | Model Group | Cavities                  | Hook Style | Sizes (oz.)<br>Hook Sizes |      |      |      |      |         |
|----------|------------|-------------|---------------------------|------------|---------------------------|------|------|------|------|---------|
|          |            |             |                           |            | 1/80                      | 1/64 | 1/32 | 1/16 | 1/8  | 1/4     |
| 1015     | JNR-6-A    | Assorted    | 6                         | 570        | 1/80                      | 1/64 | 1/32 | 1/16 | 1/8  | 1/4     |
|          |            |             |                           | 575        | 10                        | 8    | 6    | 4    | 1    | 1/0     |
| 1016     | JNR-8-1632 | Combination | 8<br>(4 each size)        | 570        | 1/32                      |      |      |      | 1/16 |         |
|          |            |             |                           | 575        | 6                         |      |      |      | 4    |         |
| 1062     | JNR-1062   | Combination | 8<br>(4 each size)        | 570        | 1/16                      |      |      |      | 1/8  |         |
|          |            |             |                           | 575        | 4                         |      |      |      | 2    |         |
| 1017     | JNR-7-48   | Combination | 7<br>(4 of 1/8, 3 of 1/4) | 570        | 1/8                       |      |      |      | 1/4  |         |
|          |            |             |                           | 575        | 1                         |      |      |      | 2/0  |         |
| 1018     | JNR-6-3812 | Combination | 6<br>(3 each size)        | 570        | 3/8                       |      |      |      | 1/2  |         |
|          |            |             |                           | 575        | 3/0                       |      |      |      | 4/0  |         |
| 3471     | JNR-6-SLA  | Assorted    | 6                         | 570        | 1/16                      | 1/8  | 3/16 | 1/4  | 5/16 | 3/8     |
|          |            |             |                           | 575        | #2                        | #1   | 1/0  | 2/0  | 3/0  | 4/0     |
|          |            |             |                           | 5318       | #1                        | 1/0  | 2/0  | 3/0  | 4/0  | 4/0-5/0 |

Note: #3471 requires Screw-Loc see page 71



# ROUND HEAD JIG – GAMAKATSU HOOKS

We went and took the most popular jig head design known to man and fit it around one of the sharpest and strongest hooks man can build. By special request, we stepped up the hook size for the cavity weight so you can have all the lip-gripping power you will need. We also added a special double holder style collar designed to better hold the new softer plastics. Will also accept Eagle Claw 570-575 hooks in the following sizes: 1/32 oz. - 2, 1/16 oz. - 1, 1/8 oz. - 1/0, 1/4 oz. - 2/0, 3/8 oz. - 3/0, 1/2 oz. - 4/0 and 5/8 oz. - 4/0.



| Item No. | Model No. | Type       | Collar        | Hook Style    | Model Group | Cavities | Sizes (oz.)<br>Hook Sizes |      |     |     |     |     |     |  |
|----------|-----------|------------|---------------|---------------|-------------|----------|---------------------------|------|-----|-----|-----|-----|-----|--|
|          |           |            |               |               |             |          | 1/32                      | 1/16 | 1/8 | 1/4 | 3/8 | 1/2 | 5/8 |  |
| 3388     | GRC-7-A   | Round Head | Double Holder | Gamakatsu 604 | Assorted    | 7        | 1/32                      | 1/16 | 1/8 | 1/4 | 3/8 | 1/2 | 5/8 |  |
|          |           |            |               |               |             |          | 1                         | 1/0  | 2/0 | 3/0 | 4/0 | 5/0 | 6/0 |  |

# ROUND HEAD JIG – TAPERED BARB COLLAR

These gentle barbs are easy on the body, so your soft plastics will be less likely to tear. That means you can be the absolute “terror” of the waters that much longer. Tapered Barb Collar - Barbs are wider and not as sharp as the traditional “spike” barbs - Same holding power in SOLID soft plastic bodies, but much less likely to tear.

## 570 or 575 Hooks

### Round Head Jig — Tapered Barb Collar, Aberdeen Hooks and Standard Balance.

| Item No. | Model No.  | Model Group | Cavities           | Sizes (oz.)<br>Hook Sizes |      |     |               |      |     |     |
|----------|------------|-------------|--------------------|---------------------------|------|-----|---------------|------|-----|-----|
|          |            |             |                    | 1/32                      | 1/16 | 1/8 | 1/4           | 5/16 | 3/8 | 1/2 |
| 1019     | RHB-7-A    | Assorted    | 7                  | 1/32                      | 1/16 | 1/8 | 1/4           | 5/16 | 3/8 | 1/2 |
|          |            |             |                    | 6                         | 4    | 2   | 1             | 1/0  | 2/0 | 3/0 |
| 1020     | RHB-8-1632 | Combination | 8<br>(4 each size) | 1/32                      |      |     | 1/16          |      |     |     |
|          |            |             |                    | 6                         |      |     | 4             |      |     |     |
| 1060     | RHB-1060   | Combination | 8<br>(4 each size) | 1/16                      |      |     | 1/8           |      |     |     |
|          |            |             |                    | 2                         |      |     | 1             |      |     |     |
| 3350     | RHB-6-1816 | Combination | 6<br>(3 each size) | 1/16                      |      |     | 1/8           |      |     |     |
|          |            |             |                    | 2/0 or 3/0                |      |     |               |      |     |     |
| 1021     | RHB-8-48   | Combination | 8<br>(4 each size) | 1/8                       |      |     | 1/4           |      |     |     |
|          |            |             |                    | 2, 1 or 1/0               |      |     | 1, 1/0 or 2/0 |      |     |     |
| 1022     | RHB-6-3812 | Combination | 6<br>(3 each size) | 3/8                       |      |     | 1/2           |      |     |     |
|          |            |             |                    | 2/0 or 3/0                |      |     |               |      |     |     |
| 3101     | RHB-8-32   | Production  | 8                  | 1/32                      |      |     |               |      |     |     |
|          |            |             |                    | 6                         |      |     |               |      |     |     |
| 3102     | RHB-8-16   | Production  | 8                  | 1/16                      |      |     |               |      |     |     |
|          |            |             |                    | 4 or 2                    |      |     |               |      |     |     |
| 3116     | RHB-8-332  | Production  | 8                  | 3/32                      |      |     |               |      |     |     |
|          |            |             |                    | 4 or 2                    |      |     |               |      |     |     |
| 3103     | RHB-8-18   | Production  | 8                  | 1/8                       |      |     |               |      |     |     |
|          |            |             |                    | 1 or 1/0                  |      |     |               |      |     |     |
| 3117     | RHB-8-316  | Production  | 8                  | 3/16                      |      |     |               |      |     |     |
|          |            |             |                    | 1 or 1/0                  |      |     |               |      |     |     |
| 3104     | RHB-7-14   | Production  | 7                  | 1/4                       |      |     |               |      |     |     |
|          |            |             |                    | 1 or 1/0                  |      |     |               |      |     |     |
| 3118     | RHB-6-516  | Production  | 6                  | 5/16                      |      |     |               |      |     |     |
|          |            |             |                    | 1/0                       |      |     |               |      |     |     |
| 3105     | RHB-6-38   | Production  | 6                  | 3/8                       |      |     |               |      |     |     |
|          |            |             |                    | 2/0, 3/0 or 4/0           |      |     |               |      |     |     |
| 3106     | RHB-6-12   | Production  | 6                  | 1/2                       |      |     |               |      |     |     |
|          |            |             |                    | 2/0, 3/0 or 4/0           |      |     |               |      |     |     |
| 3107     | RHB-6-58   | Production  | 6                  | 5/8                       |      |     |               |      |     |     |
|          |            |             |                    | 2/0, 3/0 or 4/0           |      |     |               |      |     |     |



## 570 or 575 Hooks

### Round Head Jig — All with Tapered Reverse Barb Collar, Aberdeen Hooks and Standard Balance

| Item No. | Model No. | Model Group | Cavities            | Sizes (oz.)<br>Hook Sizes |      |        |        |         |           |
|----------|-----------|-------------|---------------------|---------------------------|------|--------|--------|---------|-----------|
|          |           |             |                     | 1/80                      | 1/64 | 1/32   | 1/16   | 1/8     | 1/4       |
| 3119     | RVB-6-SA  | Assorted    | 6                   | 1/80                      | 1/64 | 1/32   | 1/16   | 1/8     | 1/4       |
|          |           |             |                     | 10                        | 8    | (6, 4) | (4, 2) | 1 (1/0) | 1/0 (2/0) |
| 3120     | RVB-3120A | Assorted    | 6                   | 1/8                       | 1/4  | 3/8    | 1/2    | 3/4     | 1         |
|          |           |             |                     | 1                         | 1/0  | 2/0    | 3/0    | 3/0     | 4/0       |
| 3121     | RVB-SM2   | Combination | 10<br>(5 each size) | 1/64                      |      |        | 1/32   |         |           |
|          |           |             |                     | 8                         |      |        | 6      |         |           |
| 3108     | RVB-5-34  | Production  | 5                   | 3/4                       |      |        |        |         |           |
|          |           |             |                     | 3/0 or 4/0                |      |        |        |         |           |
| 3109     | RVB-5-1   | Production  | 5                   | 1                         |      |        |        |         |           |
|          |           |             |                     | 3/0 or 4/0                |      |        |        |         |           |



# DO-IT SCREW-LOC SERIES

Some fads are here and gone before you even know about it. Others like the Screw-Loc stick around and turn into mainstream. We custom built the Do-it Screw-Loc so it has the best diameter and flexibility for today's plastics. We turned around and built the molds for the most popular of styles, being carefully aware of the angle of the screw-loc to hook points, balance and the eventual need for paints and top coats. Put these in the arsenal and...hey...when you are leading the tournament trail, try not to forget the ones who got you there. Do-it Screw-Loc, page 71.

## SHAKE-IT WITH SCREW-LOC

Nothing fancy about this rig...Just plain shake it with the 90° Gamakatsu 604 Hook.

| Item No. | Model No.  | Hook Style | Model Group | Cavities | Sizes (oz.)/Hook Sizes |         |         |         |         |         |
|----------|------------|------------|-------------|----------|------------------------|---------|---------|---------|---------|---------|
|          |            |            |             |          | 1/16                   | 1/8     | 3/16    | 1/4     | 5/16    | 3/8     |
| 3449     | SRH-6G-SLA | 604        | Assorted    | 6        | 1/0-3/0                | 2/0-3/0 | 3/0-4/0 | 3/0-4/0 | 4/0-5/0 | 4/0-5/0 |
|          |            |            |             |          |                        |         |         |         |         |         |



## SHAKE-IT WITH SCREW-LOC, FLAT EYE

Just like above but with the Mustad 60° 32798 Flat Eye Hook.

| Item No. | Model No.  | Hook Style | Model Group | Cavities | Sizes (oz.)/Hook Sizes |         |         |         |         |         |
|----------|------------|------------|-------------|----------|------------------------|---------|---------|---------|---------|---------|
|          |            |            |             |          | 1/16                   | 1/8     | 3/16    | 1/4     | 5/16    | 3/8     |
| 3450     | SRH-6M-SLA | 32798BLN   | Assorted    | 6        | 3/0-4/0                | 3/0-4/0 | 4/0-5/0 | 4/0-5/0 | 4/0-5/0 | 4/0-5/0 |
|          |            |            |             |          |                        |         |         |         |         |         |



## TIP UP WITH SCREW-LOC

We started with our remarkable Tip Up Jig design and incorporated the screw-loc. Throw a worm on this flat bottom jig and watch it stand up off the bottom ready to strike.

| Item No. | Model No. | Hook Style | Model Group | Cavities | Sizes (oz.)/Hook Sizes |         |     |      |         |         |
|----------|-----------|------------|-------------|----------|------------------------|---------|-----|------|---------|---------|
|          |           |            |             |          | 1/8                    | 3/16    | 1/4 | 5/16 | 3/8     | 7/16    |
| 3451     | TUJ-6-SLA | 604        | Assorted    | 6        | 1/0                    | 1/0-2/0 | 2/0 | 3/0  | 4/0-5/0 | 4/0-5/0 |
|          |           |            |             |          |                        |         |     |      |         |         |



## FOOTBALL JIG WITH SCREW-LOC

With its ability to wobble twitch and not fall over, this design reigns supreme in the finesse world. Get the livewell going.

| Item No. | Model No. | Hook Style | Model Group | Cavities | Sizes (oz.)/Hook Sizes |     |     |     |     |     |
|----------|-----------|------------|-------------|----------|------------------------|-----|-----|-----|-----|-----|
|          |           |            |             |          | 1/16                   | 1/8 | 1/4 | 3/8 | 1/2 | 5/8 |
| 3453     | FBB-6-SLA | 32798BLN   | Assorted    | 6        | 3/0                    | 3/0 | 4/0 | 4/0 | 5/0 | 5/0 |
|          |           |            |             |          |                        |     |     |     |     |     |



## TROKAR ROUND HEAD JIG WITH SCREW-LOC

Finesse shake-it jig with a flat bottom for a standup presentation.

| Item No. | Model No. | Hook Style     | Model Group | Cavities | Sizes (oz.)/Hook Sizes |      |     |      |     |
|----------|-----------|----------------|-------------|----------|------------------------|------|-----|------|-----|
|          |           |                |             |          | 1/8                    | 3/16 | 1/4 | 5/16 | 3/8 |
| 3492     | RFT-5-ATK | TK800<br>TK805 | Assorted    | 5        | 3/0                    | 3/0  | 4/0 | 4/0  | 5/0 |
|          |           |                |             |          |                        |      |     |      |     |



## TROKAR FOOTBALL HEAD JIG WITH SCREW-LOC

This football is flat on purpose.

| Item No. | Model No. | Hook Style | Model Group | Cavities | Sizes (oz.)/Hook Sizes |     |     |     |     |
|----------|-----------|------------|-------------|----------|------------------------|-----|-----|-----|-----|
|          |           |            |             |          | 1/8                    | 1/4 | 3/8 | 1/2 | 5/8 |
| 3493     | FBS-5-ATK | TK815      | Assorted    | 5        | 4/0                    | 4/0 | 4/0 | 4/0 | 4/0 |
|          |           |            |             |          |                        |     |     |     |     |



## MANIC MULLET JIG

Our latest edition to our saltwater mold lineup featuring 60 degree hooks, a triple disc collar for holding soft plastics and oversized eye sockets and slim profile that rolls producing flash and vibration the Manic Mullet is sure to turn some heads. In addition to being a great saltwater jig the Manic Mullet makes for a killer swimbait head for a variety of freshwater species. Largest eye size listed below.

| Item No. | Model No. | Hook Style | Model Group | Cavities | Sizes (oz.)<br>Hook Sizes<br>2D or 3D Stick-on Lure Eye Size |         |         |         |     |
|----------|-----------|------------|-------------|----------|--|---------|---------|---------|-----|
|          |           |            |             |          | 3/16   | 1/4     | 5/16    | 3/8     | 1/2 |
| 3531     | MMT-5-A   | 32786      | Assorted    | 5        | 1/0-2/0  | 2/0-3/0 | 3/0-4/0 | 4/0-5/0 |     |
|          |           |            |             |          |  |         |         |         |     |
|          |           |            |             |          | 1/4  | 9/32    | 5/16    | 3/8     |     |





# FREESTYLE JIG

The new 6 cavity Freestyle Jig Mold is built on a 90 degree aberdeen frame and teamed up with Do-It's WB400 wire keeper to hold both plastics and live bait. The light-wire hook options, 90 degree line tie, and oversized eye sockets for 2 or 3D stick on lure eyes make the new Freestyle Jig the ultimate finesse jig for fishing minnow like plastics on clean, high-pressured bodies of water. In addition to being a great finesse jig for bass, the multiple sizes from 3/16 up to 1/2 ounce make for a killer crappie or walleye jig.

**NEW SIZE!**

| Item No. | Model No. | Collar                  | Hook Style                 | Model Group | Cavities | Sizes (oz.)<br>Hook Sizes<br>Stick-On Lure Eye |      |      |      |        |      |   |
|----------|-----------|-------------------------|----------------------------|-------------|----------|--|------|------|------|--------|------|---|
|          |           |                         |                            |             |          | 3/16   | 1/4  | 5/16 | 3/8  | 7/16   | 1/2  |   |
| 3525     | FST-6-A   | WB-400<br>(See page 71) | 5318-<br>5313,<br>570, 575 | Assorted    | 6        | 3/16   | 1/4  | 5/16 | 3/8  | 7/16   | 1/2  |   |
|          |           |                         |                            |             |          | 3/0  |      | 4/0  |      | 5/0    |      |   |
|          |           |                         |                            |             |          | 2.5  | 4    |      |      | 4 or 5 |      |   |
| 3528     | FST-6-SA  | WB-400<br>(See page 71) | 5318,<br>570, 575<br>32750 | Assorted    | 6        | 3/16   | 5/32 | 1/8  | 3/32 | 1/16   | 1/32 |   |
|          |           |                         |                            |             |          | 3/0  | 2/0  | 1/0  | 1    | 2      | 4    |   |
|          |           |                         |                            |             |          | 2.5  |      |      |      |        |      | 2 |
|          |           |                         | 3/16                       |             |          | 5/32   | 1/8  | 3/32 | 1/16 | 1/32   |      |   |
|          |           |                         | 3/0                        |             |          | 2/0  | 1/0  |      | 1    | 2      |      |   |
|          |           |                         | 2.5                        |             |          |  |      |      | 2    |        |      |   |



## CALL OUT THE WEED WACKERS!

### FIBERGUARDS

These bundles of plastic filaments are simple, effective weed and brush guards. Fiberguard length can be adjusted to fit a specific lure. You may think that we've been way too generous with the length, but it was our plan all along. Go ahead, trim the guard to fit. You'll get over the guilt. We did.

- FG-40 Fiberguards have large 5/32" diameter bases. These guards are very stiff and used with heavy jigs.
- FG-30 Fiberguards have 1/8" diameter bases. These are the most popular size with a variety of stiffness ratings.
- FG-12 Fiberguards have a 5/64" diameter base and are used for lighter applications.
- FG-9 Fiberguards are light duty with 1/16" diameter bases.



Fiberguards, page 92

### BASE HOLE PIN

Although direct molding is the most popular way to attach a fiberguard, some tackle makers prefer to epoxy the weedguard in place. In some models, a steel base hole pin can be molded in place. A hole is formed when this pin is removed. Epoxy holds the weedguard inside the pin cavity. Note: Only 1/8" (FG-30) and 5/32" (FG-40) fiberguard models have provisions for base hole pins. One reusable pin per cavity is supplied with qualified models.



Additional Base Hole Pins, page 102

## THE POISON TAIL JIG

Like the venomous scorpion, this highly evolved jig sits poised to deliver a toxic strike at its prey. The wide protrusion of the head with a flat bottom provides extreme stability and balance to this design. The pronounced brow and recessed eyes serve to anger and entice its prey. And when he bites, the Poison Tail Jig bites back with the Mustad Modified Wide-Gap Impact Hook, digging in with stinging hooksets – faster and more powerful than other jigs you have tried. Add the Poison Tail to your arsenal, and get ready to latch onto the big catch.



**ULTRA POINT**  
Mustad

| Item No. | Model No. | Type            | Insert                                  | Collar        | Stick-on Eye   | Hook Style      | Model Group | Cavities | Sizes (oz.)<br>Hook Sizes |     |     |
|----------|-----------|-----------------|---|---------------|----------------|-----------------|-------------|----------|---------------------------|-----|-----|
| 3419     | PTJ-3-AFM | Poison Tail Jig | FG-30                                   | Disk & Holder | 5/32" size 2.5 | Mustad 91768BLN | Assorted    | 3        | 1/2                       | 3/4 | 1   |
|          |           |                 |   |               |                |                 |             |          | 3/0                       | 4/0 | 5/0 |
| 3420     | PTJ-3-AFS | Poison Tail Jig | FG-12 (for 1/8)<br>FG-30 (for 1/4, 3/8) | Disk & Holder | 5/32" size 2.5 | Mustad 91768BLN | Assorted    | 3        | 1/8                       | 1/4 | 3/8 |
|          |           |                 |   |               |                |                 |             |          | 1/0                       | 2/0 | 3/0 |

## SNOOTIE JIG

Just like that girl in high school, this wedged bottom jig has a turned up nose and beautiful eyes. This head design fishes well in heavy cover and creates a unique fall action. Be wary of being hooked by this vixen, because it has a Mustad 60° bend, wide gap, needle point, black nickel hook – an unforgiving hook sure to break a fish's heart.

| Item No. | Model No. | Insert | Collar | Stick-on Eye   | Hook Style | Model Group | Cavities | Sizes (oz.) Hook Sizes |      |     |
|----------|-----------|--------|--------|----------------|------------|-------------|----------|------------------------|------|-----|
| 3371     | SNT-3-AYS | FG-30  | Ball   | 5/32" size 2.5 | 32786 BLN  | Assorted    | 3        | 1/8                    | 3/16 | 1/4 |
|          |           |        |        |                |            |             |          | 1/0                    | 2/0  | 3/0 |
| 3372     | SNT-3-AYM | FG-30  | Ball   | 5/32" size 2.5 | 32786 BLN  | Assorted    | 3        | 3/8                    | 1/2  | 5/8 |
|          |           |        |        |                |            |             |          | 4/0                    | 5/0  | 6/0 |

1/8" x 1" Base Hole Pin (one per cavity included)



## WACKY HEAD JIG

Unless you've been living under a rock, you've at least heard of a wacky rig. This jig will allow you to get down there where they're hanging out and dare them to eat. Fine wire weedguard to keep you out of the sticks and a super sharp Do-it hook will put them in the live well every time.

| Item No. | Model No. | Insert | Collar | Hook Style | Model Group | Cavities | Sizes (oz.) Hook Sizes |      |     |      |     |
|----------|-----------|--------|--------|------------|-------------|----------|------------------------|------|-----|------|-----|
| 3480     | WCK-5-AWG | WWG-12 | None   | Do-it 785  | Assorted    | 5        | 1/16                   | 3/32 | 1/8 | 3/16 | 1/4 |
|          |           |        |        |            |             |          | 2 or 6                 |      |     |      |     |



WWG-12 Wire Weedguard See page 92

## WEEDLESS ROUND JIG

Papa loves the Round Head Jig. Never in his wildest imagination did he think the design could be improved. It has. We added a Mustad 60° flat eye, wide gap, needle point, black nickel hook. The hook point will remain upright rather than rotating to the side. Attach anything on the ring and barb collar, and you've made it into the 21st century and quite possibly the winner's circle.

| Item No. | Model No. | Type               | Insert | Collar      | Hook Style | Model Group | Cavities | Sizes (oz.) Hook Sizes |      |      |
|----------|-----------|--------------------|--------|-------------|------------|-------------|----------|------------------------|------|------|
| 3373     | RWR-3-AYS | Weedless Round Jig | FG-30  | Ring & Barb | 32798 BLN  | Assorted    | 3        | 1/8                    | 3/16 | 1/4  |
|          |           |                    |        |             |            |             |          | 3/0                    |      |      |
| 3374     | RWR-3-AYM | Weedless Round Jig | FG-30  | Ring & Barb | 32798 BLN  | Assorted    | 3        | 5/16                   | 3/8  | 7/16 |
|          |           |                    |        |             |            |             |          | 4/0                    |      |      |
| 3375     | RWR-3-AYL | Weedless Round Jig | FG-30  | Ring & Barb | 32798 BLN  | Assorted    | 3        | 1/2                    | 9/16 | 5/8  |
|          |           |                    |        |             |            |             |          | 5/0                    |      |      |

1/8" x 1" Base Hole Pin (one per cavity included)



## WEEDLESS BALL JIG – FIBERGUARD

The Weedless Ball Jig is designed to accept fiberguard weed and brush guards. Weedless Ball Jigs enable fishermen to spend more time fishing brush piles and weedbeds instead of freeing snags.

| Item No. | Model No.   | Insert     | Collar       | Hook Style | Model Group | Cavities        | Sizes (oz.) Hook Sizes Inserts |      |       |       |       |
|----------|-------------|------------|--------------|------------|-------------|-----------------|--------------------------------|------|-------|-------|-------|
| 3317     | RVB-5-AF    | FG-9 FG-12 | Reverse Barb | 570 575    | Assorted    | 5               | 1/32                           | 1/16 | 1/8   | 1/4   | 3/8   |
|          |             |            |              |            |             |                 | 6                              | 4    | 1     | 1/0   | 2/0   |
|          |             |            |              |            |             |                 | FG-9                           | FG-9 | FG-12 | FG-12 | FG-12 |
| 3241     | RVB-6-1632F | FG-9       | Reverse Barb | 570 575    | Combination | 6 (3 each size) | 1/32                           |      | 1/16  |       |       |
|          |             |            |              |            |             |                 | 6                              |      | 4     |       |       |

Not designed to use with Base Hole Pins



# BULLET BASS JIG

This point tapered bullet-type head uses Eagle Claw's premium, heavy-duty Lazer L2221 hook with the eye in a far forward position. Because of these features, this jig tends to slip through weed clogged areas like no other weedless jig.

L2221 Hook  
See Page 58



| Item No. | Model No. | Type            | Insert           | Collar | Hook Style | Model Group | Cavities | Sizes (oz.)<br>Hook Sizes |     |     |
|----------|-----------|-----------------|------------------|--------|------------|-------------|----------|---------------------------|-----|-----|
|          |           |                 |                  |        |            |             |          | 1/4                       | 3/8 | 1/2 |
| 3248     | BBJ-3-AY  | Bullet Bass Jig | FG-30            | Ball   | L2221      | Assorted    | 3        | 5/0                       |     |     |
| 3251     | BBJ-3-LF  | Bullet Bass Jig | FG-40<br>FG-40HB | Ball   | L2221      | Assorted    | 3        | 5/8                       | 3/4 | 7/8 |
|          |           |                 |                  |        |            |             |          | 5/0                       |     |     |

1/8" x 1" Base Hole Pin (one per cavity included)

# ARKY STYLE JIG

No kidding, the 3199 flipping jig in 1/8 oz. uses the sharp 570 or 575 style Aberdeen jig hooks. Voted Mr. Popular by its classmates, a very useful all-purpose Bass jig. The 3387 utilizes our new double holder collar and the premium Mustad 32798 turned eye, wide gap, black nickel hook, making it the ideal choice to pull over the snags and still grab a hold of Mr. Bucket Mouth. The 3489 is designed to use the cold forged steel Trokar hook. Base hole pins are provided for those who prefer to glue the fiberguard in place.

#3199



#3489



| Item No.   | Model No. | Type           | Insert | Collar        | Hook Style | Model Group | Cavities | Sizes (oz.)<br>Hook Sizes |     |     |
|--|-----------|----------------|--------|---------------|------------|-------------|----------|---------------------------|-----|-----|
|  |           |                |        |               |            |             |          | 1/8                       | 4/0 |     |
| 3199   | ARK-18Y   | Arky Style Jig | FG-30  | Ball          | 570<br>575 | Production  | 4        |                           |     |     |
| 3064   | ARK-3-AY  | Arky Style Jig | FG-30  | Ball          | 730        | Assorted    | 3        | 1/4                       | 3/8 | 1/2 |
|  |           |                |        |               |            |             |          | 3/0                       | 4/0 | 5/0 |
| 3387   | ARK-3-AFC | Arky Style Jig | FG-30  | Double Holder | 32798      | Assorted    | 3        | 1/4                       | 3/8 | 1/2 |
|  |           |                |        |               |            |             |          | 3/0                       | 4/0 | 5/0 |
|  3489 | ARK-3-ATK | Arky Style Jig | FG-30  | Double Holder | TK800      | Assorted    | 3        | 1/4                       | 3/8 | 1/2 |
|  |           |                |        |               |            |             |          | 3/0                       | 4/0 | 5/0 |

1/8" x 1" Base Hole Pin (one per cavity included)

# BASS JIG

This weedless jig offers streamlined snag resistance in a highly stable design to get down where the "fat" ones live.

| Item No. | Model No. | Insert | Collar | Hook Style | Model Group | Cavities | Sizes (oz.)<br>Hook Sizes |     |     |
|----------|-----------|--------|--------|------------|-------------|----------|---------------------------|-----|-----|
|          |           |        |        |            |             |          | 1/4                       | 3/8 | 1/2 |
| 3066     | BASS-3-AY | FG-30  | Ball   | 730        | Assorted    | 3        | 5/0                       |     |     |
|          |           |        |        |            |             |          | 3/0                       | 4/0 | 5/0 |

1/8" x 1" Base Hole Pin (one per cavity included)



# STYLE "S" BASS JIG

The "S" Bass Jig is wide and stable, yet will slip through heavy cover (just like Superman!) without hanging up. If resting on the bottom, the hook remains upright and does not turn on its side.

| Item No. | Model No. | Insert | Collar | Hook Style | Model Group | Cavities | Sizes (oz.)<br>Hook Sizes |      |      |
|----------|-----------|--------|--------|------------|-------------|----------|---------------------------|------|------|
|          |           |        |        |            |             |          | 5/16                      | 7/16 | 9/16 |
| 3316     | JKS-3-AY  | FG-30  | Ball   | 730        | Assorted    | 3        | 5/0                       |      |      |
|          |           |        |        |            |             |          | 3/0                       | 4/0  | 5/0  |

1/8" x 1" Base Hole Pin (one per cavity included)





## WEEDLESS CASTING JIG

If you are looking for a true weedless swimming jig that tracks straight and runs evenly along your choice of depths, then this is your jig. The unique attributes of a 30 degree hook position forward on a carefully balanced bullet style head and properly positioned fiberguard create a bait that begs to be ripped through the water column at your favorite honey hole. Step up to this truly different weedless swimming jig.

| Item No. | Model No. | Insert | Collar      | Hook Style | Model Group | Cavities | Sizes (oz.) Hook Sizes |         |         |
|----------|-----------|--------|-------------|------------|-------------|----------|------------------------|---------|---------|
| 3465     | SMJ-3-SF  | FG-30  | Ring & Barb | 32886BLN   | Assorted    | 3        | 1/8                    | 3/16    | 1/4     |
|          |           |        |             |            |             |          | 3/0                    | 3/0     | 3/0-4/0 |
|          |           |        |             |            |             |          | 1.5 eye                | 2 eye   | 2 eye   |
| 3466     | SMJ-3-MF  | FG-30  | Ring & Barb | 32886BLN   | Assorted    | 3        | 5/16                   | 3/8     | 1/2     |
|          |           |        |             |            |             |          | 3/0-4/0                | 4/0-5/0 | 4/0-5/0 |
|          |           |        |             |            |             |          | 2 eye                  | 2 eye   | 2.5 eye |

1/8" x 1" Base Hole Pin (one per cavity included)



## WEEDLESS BANANA JIG

Weedless Banana Jigs are somewhat slimmer and narrower than similar Bass jigs. This can be advantageous in situations where enhanced snag resistance is important. The improved design accommodates several popular Bass jig hooks, including 630, 410 and 730. The 630 styles specify a smaller hook size than the 410 or 730.

| Item No. | Model No. | Insert | Collar | Model Group | Cavities | Hook Style | Sizes (oz.) Hook Sizes |     |     |     |
|----------|-----------|--------|--------|-------------|----------|------------|------------------------|-----|-----|-----|
| 3312     | BAN-4-AY  | FG-30  | Ball   | Assorted    | 4        | 630-635    | 3/16                   | 1/4 | 3/8 | 1/2 |
|          |           |        |        |             |          |            | 2/0                    | 2/0 | 3/0 | 4/0 |
|          |           |        |        |             |          |            | 410-413-730            | 3/0 | 3/0 | 4/0 |

1/8" x 1" Base Hole Pin (one per cavity included)



## WEEDLESS BRUSH JIG

We have wrapped a lot of technology in this weedless wonder. We started with surrounding the eye with lead to minimize any snagging points. We carefully positioned the hook to give the best angle for powerful hook sets as are needed in the thickest cover. We flattened the bottom to allow for a balanced stand-up presentation. Combined with the Mustad Ultra-Point Hook, you have one of the most effective baits to chase the big boys in the roughest cover.

| Item No. | Model No. | Insert | Collar      | Hook Style | Model Group | Cavities | Sizes (oz.) Hook Sizes |     |       |
|----------|-----------|--------|-------------|------------|-------------|----------|------------------------|-----|-------|
| 3459     | BSH-3-LA  | FG-30  | Ring & Barb | 32786BLN   | Assorted    | 3        | 5/8                    | 3/4 | 1 oz. |
|          |           |        |             |            |             |          | 4/0                    | 5/0 | 6/0   |
| 3467     | BSH-3-SA  | FG-30  | Ring & Barb | 32786BLN   | Assorted    | 3        | 1/4                    | 3/8 | 1/2   |
|          |           |        |             |            |             |          | 3/0                    | 3/0 | 4/0   |

1/8" x 1" Base Hole Pin (one per cavity included)



## FLIPPING JIG

A snag resistant design using the special wide throat super-strong 730 style hooks. The 730 hooks are designed to maximize hooking power. When pork rind is added to the jig, flipping jigs are super Bass lures.

| Item No. | Model No. | Insert | Collar | Hook Style | Model Group | Cavities | Sizes (oz.) Hook Sizes |     |     |
|----------|-----------|--------|--------|------------|-------------|----------|------------------------|-----|-----|
| 3060     | FLIP-3-AY | FG-30  | Ball   | 730        | Assorted    | 3        | 1/4                    | 3/8 | 1/2 |
|          |           |        |        |            |             |          | 3/0                    | 4/0 | 5/0 |

1/8" x 1" Base Hole Pin (one per cavity included)



# WEEDLESS SPARKIE JIG

A very snag resistant design incorporating the Sparkie head with a weedguard. The combination of the 410 jig hook and fiberguard make the Weedless Sparkie a great lure for taking tough fish in heavy cover.

| Item No. | Model No. | Insert | Collar | Hook Style | Model Group | Cavities | Sizes (oz.) Hook Sizes |     |     |     |
|----------|-----------|--------|--------|------------|-------------|----------|------------------------|-----|-----|-----|
|          |           |        |        |            |             |          | 1/4                    | 3/8 | 1/2 | 5/8 |
| 1090     | JKS-1090Y | FG-30  | Ball   | 410        | Assorted    | 4        | 1/0                    | 2/0 | 3/0 | 4/0 |
|          |           |        |        | 413        |             |          |                        |     |     |     |

1/8" x 1" Base Hole Pin (one per cavity included)



# WEEDLESS FOOTBALL JIG

The Football head has gained popularity as a bottom probing jig. The wide shape of this head style prevents it from tipping to the side, so the hook can always remain upright. Line pressure will cause the jig to stand up, poised for a strike. Its broad face helps transmit signals up the line about changes in bottom features. Item #3434 takes a stronger fiberguard than the 3318 and also fits both the Mustad Flat-eye 32798 and 32786 hooks. The flat bottomed football item 3487 uses the surgically sharpened Trokar hook.

| Item No. | Model No.  | Insert           | Collar      | Hook Style | Model Group | Cavities | Sizes (oz.) Hook Sizes |         |         |         |
|----------|------------|------------------|-------------|------------|-------------|----------|------------------------|---------|---------|---------|
|          |            |                  |             |            |             |          | 1/4                    | 3/8     | 1/2     | 3/4     |
| 3318     | FBW-4-AF   | FG-12<br>FG-12HB | Ring & Barb | 570        | Assorted    | 4        | 3/0 or 4/0             |         |         |         |
|          |            |                  |             | 575        |             |          |                        |         |         |         |
| 3431     | FBB-3H-AF  | FG-30            | Ring & Barb | 32786BLN   | Assorted    | 3        | 3/4                    | 1       | 1-1/2   |         |
|          |            |                  |             |            |             |          | 4/0                    | 5/0     | 6/0     |         |
| 3434     | FBB-4H-AFM | FG-30            | Ring & Barb | 32786BLN   | Assorted    | 4        | 1/8                    | 1/4     | 3/8     | 1/2     |
|          |            |                  |             | 32798BLN   |             |          | 1/0                    | 2/0     | 3/0     | 4/0     |
| 3432     | FBB-3M-AFM | FG-30            | Ring & Barb | 32798BLN   | Assorted    | 3        | 1/2                    | 3/4     | 1       |         |
|          |            |                  |             |            |             |          | 4/0-5/0                | 4/0-5/0 | 4/0-5/0 |         |
| 3487     | FBB-4T-ASU | FG-30            | Ring & Barb | TK800      | Assorted    | 4        | 1/4                    | 3/8     | 1/2     | 3/4     |
|          |            |                  |             |            |             |          | 3/0                    | 3/0     | 4/0     | 5/0     |
| 3501     | FWB-4M-ASU | FG-30<br>WB800   | Holder      | 32786BLN   | Assorted    | 4        | 1/4                    | 3/8     | 1/2     | 3/4     |
|          |            |                  |             |            |             |          | 3/0                    | 3/0     | 4/0     | 4/0-5/0 |

For 3431, 3434, 3432 & 3501: 1/8" x 1" Base Hole Pin (one per cavity included) 3318 and 3487 are not designed for base hole pins

Ring & Barb Collar Attach  
Rubber Skirts, Soft  
Plastics or Both

#3318 with  
90 degree eye

#3434 with  
flat eye

#3501



# TROKAR PRO SWIM JIG – FIBERGUARD

This is a life saver. Pro Swimming capabilities with a surgically sharpened cold forged steel Trokar Hook.

| Item No. | Model No. | Type            | Insert | Collar           | Hook Style | Model Group | Cavities | Sizes (oz.) Hook Sizes |       |         |
|----------|-----------|-----------------|--------|------------------|------------|-------------|----------|------------------------|-------|---------|
|          |           |                 |        |                  |            |             |          | 1/4                    | 3/8   | 1/2     |
| 3495     | SPJ-3-ATK | Pro-Swim<br>Jig | FG-30  | Double<br>Holder | TK-805     | Assorted    | 3        | 3/0                    | 4/0   | 5/0     |
|          |           |                 |        |                  |            |             |          | 2 eye                  | 2 eye | 2.5 eye |
|          |           |                 |        |                  |            |             |          |                        |       |         |

1/8" x 1" Base Hole Pin (one per cavity included)



Stick-on Eyes  
See page 77

## CASTING AND VERTICAL JIGGING LURES

These “bad boys” are molded around a single stainless steel wire form for added strength. Send these guys out to play... each is designed for its own unique style of drop and flutter jigging action.

### CASTING SPOON LURE

Hang this long, thin spoon on your rig for smooth casting and realistic action. Add reflective tape along the flat sides to mimic “fish scale” shine and catch the eye of a hungry one.

| Item No. | Model No. | Type          | Insert             | Hook Style             | Model Group   | Cavities | Sizes (oz.)<br>Wire Form Used<br>Hook Sizes |        |       |        |
|----------|-----------|---------------|--------------------|------------------------|---------------|----------|---|--------|-------|--------|
|          |           |               |                    |                        |               |          | 1/4   | 1/2    | 3/4   | 1      |
| 3177     | CC-4-A    | Casting Spoon | CC-Forms           | 35517<br>3551<br>7790X | Assorted      | 4        | CC-14                                       | CC-12  | CC-34 | CC-100 |
|          |           |               |                    |                        |               |          | Sizes 8, 6, 4 or 2                          |        |       |        |
| 3178     | CC-2-L    | Casting Spoon | CC-Forms           | 35517<br>3551<br>7790X | Assorted      | 2        | 1-1/2                                       | 2      |       |        |
|          |           |               |                    |                        |               |          | CC-150                                      | CC-200 |       |        |
|          |           |               |                    |                        |               |          | Sizes 4 or 2                                |        |       |        |
| 3264     | CC-1-3    | Casting Spoon | CC-300<br>CC-Forms | 35517<br>3551          | Single Cavity | 1        | 3   |        |       |        |
|          |           |               |                    |                        |               |          | CC-300                                      |        |       |        |
|          |           |               |                    |                        |               |          | 2   |        |       |        |
| 3265     | CC-1-4    | Casting Spoon | CC-400<br>CC-Forms | 35517<br>3551          | Single Cavity | 1        | 4   |        |       |        |
|          |           |               |                    |                        |               |          | CC-400                                      |        |       |        |
|          |           |               |                    |                        |               |          | 2   |        |       |        |
| 3266     | CC-1-6    | Casting Spoon | CC-600<br>CC-Forms | 35517<br>3551          | Single Cavity | 1        | 6   |        |       |        |
|          |           |               |                    |                        |               |          | CC-600                                      |        |       |        |
|          |           |               |                    |                        |               |          | 2/0 or 4/0                                  |        |       |        |



Long, lean shape for smooth casting

CC-Forms  
See page 72

### JIGGING SPOON

Capture the attention of certain species... notably the Striped Bass. Cleverly designed with one flat side and one tapered “keel-shaped” side for a wiggling action irresistible to fish. This “heavy-weight” can reach the bottom of deep water. Add an in-line swivel and you have a most effective retriever. On a fast uptake the lure will have an extreme wiggling, spinning action simulating a frightened minnow to generate a vicious strike.

| Item No. | Model No. | Type          | Insert             | Hook Style             | Model Group | Cavities | Sizes (oz.)<br>Wire Form Used<br>Hook Sizes |       |       |
|----------|-----------|---------------|--------------------|------------------------|-------------|----------|---|-------|-------|
|          |           |               |                    |                        |             |          | 5/8   | 1-1/8 | 1-3/8 |
| 1203     | JS-3-A    | Jigging Spoon | Jigging Spoon Form | 35517<br>3551<br>7790X | Assorted    | 3        | 1-JSF                                       | 2-JSF | 3-JSF |
|          |           |               |                    |                        |             |          | 4 or 2 Recommended                          |       |       |

Tapered “keel” shape for wigggle action



Jigging Spoon Form  
See page 72

### HAMMERED SPOON

A vital “tool” in your tackle box. The hammered pattern simulates fish scales and gill plates for an illusion of an accessible shad snack. A wire form molded inside the lure gives it the necessary fish fighting strength you need to bring in the trophies! Alter its dropping speed and action by bending the soft lead spoon. Note: This lure must be molded by “ladle pouring” with SOFT LEAD ONLY!

| Item No. | Model No. | Type           | Insert       | Hook Style | Model Group | Cavities | Sizes (oz.)<br>Hook Sizes |
|----------|-----------|----------------|--------------|------------|-------------|----------|---------------------------|
| 3291     | HS-3-34   | Hammered Spoon | HS-34 Forms  | 3551       | Production  | 3        | 3/4                       |
|          |           |                |              |            |             |          | 2 or 4                    |
| 3286     | HS-3-1    | Hammered Spoon | HS-100 Forms | 3551       | Production  | 3        | 1                         |
|          |           |                |              |            |             |          | 2 or 4                    |

Hammered texture tells ‘em their shad snack has arrived



HS-form inside for fighting strength  
See page 72



# DIAMOND LURE

Nothing cuts like a diamond. And that holds true for the Diamond Lure as it slices through the water whether you're trolling, jigging or casting. This jewel works equally well in fresh or saltwater.

| Item No. | Model No. | Type         | Insert             | Hook Style               | Model Group      | Cavities | Sizes (oz.)<br>Wire Form Used<br>Hook Sizes |       |        |        |
|----------|-----------|--------------|--------------------|--------------------------|------------------|----------|---|-------|--------|--------|
|          |           |              |                    |                          |                  |          | 1/4   | 1/2   | 3/4    | 1      |
| 3204     | DJ-4-A    | Diamond Lure | CC-Forms           | 35517<br>3551 -<br>7790X | Assorted         | 4        | CC-14                                       | CC-12 | CC-34  | CC-100 |
|          |           |              |                    |                          |                  |          | 8, 6, 4 or 2                                |       |        |        |
| 3205     | DJ-2-L    | Diamond Lure | CC-Forms           | 35517<br>3551 -<br>7790X | Assorted         | 2        | 1-1/2                                       |       | 2      |        |
|          |           |              |                    |                          |                  |          | CC-150                                      |       | CC-200 |        |
|          |           |              |                    |                          |                  |          | 4 or 2                                      |       |        |        |
| 3206     | DJ-1-3    | Diamond Lure | CC-300<br>CC-Forms | 35517<br>3551            | Single<br>Cavity | 1        | 3   |       |        |        |
|          |           |              |                    |                          |                  |          | CC-300                                      |       |        |        |
|          |           |              |                    |                          |                  |          | 2/0   |       |        |        |
| 3207     | DJ-1-4    | Diamond Lure | CC-400<br>CC-Forms | 35517<br>3551            | Single<br>Cavity | 1        | 4   |       |        |        |
|          |           |              |                    |                          |                  |          | CC-400                                      |       |        |        |
|          |           |              |                    |                          |                  |          | 2/0   |       |        |        |
| 3208     | DJ-1-6    | Diamond Lure | CC-600<br>CC-Forms | 35517<br>3551            | Single<br>Cavity | 1        | 6   |       |        |        |
|          |           |              |                    |                          |                  |          | CC-600                                      |       |        |        |
|          |           |              |                    |                          |                  |          | 4/0   |       |        |        |



## BLADE BAITS

Just as the name says, these lures are made from a metal blade. Bring your "blades" out when vertical jigging for schooling fish such as Walleye or Bass. Blade Baits are also used for trolling and casting. Lures made with "ZB" series blanks have attachment points to offer adjustable balance and vibrations.

## SHAD BLADE

The most wily of all Bass or Walleye will strike at this lure. The wide flat head together with the metal blade provide erratic action when the lure is jerked sharply or allowed to drop in free fall.

| Item No. | Model No. | Type       | Insert | Stick-On Lure Eye | Hook Style             | Model Group                  | Cavities | Sizes (oz.)<br>Hook Sizes |     |
|----------|-----------|------------|--------|-------------------|------------------------|------------------------------|----------|---------------------------|-----|
| 3277     | ZS-4-S    | Shad Blade | ZB-S   | 5/32"<br>Size 2.5 | 3551<br>35517<br>7790X | Combination<br>(2 each size) | 4        | 1/4                       | 3/8 |
|          |           |            |        |                   |                        |                              |          | 8, 6, or 4                |     |
| 3278     | ZS-4-M    | Shad Blade | ZB-M   | 5/32"<br>Size 2.5 | 3551<br>35517<br>7790X | Combination<br>(2 each size) | 4        | 1/2                       | 3/4 |
|          |           |            |        |                   |                        |                              |          | 6, 4 or 2                 |     |



## STYLE ZV VIBRATING LURE

Think of it as the lure that knows "fish speak." Fish, especially hard-to-reach schooling fish, respond to vibrations for their next meal. Versatile enough to be used for jigging, casting and trolling. Style ZV Vibrating Lures shimmy through the water – sending out a "dinner's ready" call to everything from river Smallmouth to suspended Walleye and Largemouth Bass.

| Item No. | Model No. | Type | Insert       | Stick-On Lure Eye | Hook Style             | Model Group                  | Cavities | Sizes (oz.)<br>Insert Sizes<br>Hook Sizes |      |        |        |      |
|----------|-----------|------|--------------|-------------------|------------------------|------------------------------|----------|---|------|--------|--------|------|
| 3331     | ZV-5-A    | ZV   | ZB-S<br>ZB-M | 5/32"<br>Size 2.5 | 3551<br>35517<br>7790X | Assorted                     | 5        | 1/4                                       | 3/8  | 1/2    | 5/8    | 3/4  |
|          |           |      |              |                   |                        |                              |          | ZB-S                                      | ZB-S | ZB-M   | ZB-M   | ZB-M |
|          |           |      |              |                   |                        |                              |          | 8 or 6                                    |      |        | 4 or 2 |      |
| 3332     | ZV-4-24   | ZV   | ZB-S<br>ZB-M | 5/32"<br>Size 2.5 | 3551<br>35517<br>7790X | Combination<br>(2 each size) | 4        | 1/4                                       |      | 1/2    |        |      |
|          |           |      |              |                   |                        |                              |          | ZB-S                                      |      | ZB-M   |        |      |
|          |           |      |              |                   |                        |                              |          | 8 or 6                                    |      | 4 or 2 |        |      |

Recessed eye sockets for 5/32"  
decal or 3-D lure eyes application



Vibrating Lure Blank  
See page 74

# ULTRA MINNOW BLADE

Do-It is offering another option for those that are looking for a large profile blade bait and want the ability to Do-It their way. The Ultra Minnow Blade from Do-It is a great new addition to the blade world and has a larger profile than most blades on the market right now. The ultra minnow head style on the bow of this bait give it an excellent vibration. Use #4 split ring.



Do-it AVLB-32  
Vibrating Lure Blanks  
See page 74

| Item No. | Model No. | Type         | Stick-On Lure Eye   | Hook Style             | Model Group | Cavities | Sizes (oz.) Stick-On Lure Eye |     |        |        |
|----------|-----------|--------------|---------------------|------------------------|-------------|----------|-------------------------------|-----|--------|--------|
|          |           |              |                     |                        |             |          | 3/4                           | 1   | 1 -1/4 | 1 -1/2 |
| 3518     | UMB-4-LA  | Minnow Blade | 2.5-4 sized 2D & 3D | Mustad TR78NP #2 or #4 | Assorted    | 4        | 2.5                           | 2.5 | 4      | 4      |

# SPINNER JIGS

The spinner design is snag-resistant and the blade flutters, vibrates, and flashes to draw attention and trigger strikes. Bass often hit a spinner jig as a reflex action, making Spinner Jigs a top choice for Bass and other game fish.

# BANANA SPINNER JIG

The unique banana shape and forward center of weight allow this jig to skim over vegetation and rocks, so you can avoid frustrating entanglements. The weighted banana belly helps stabilize the lure when used with plastic twisting tails.

Designed for use with prebent wire forms  
See page 72

| Item No. | Model No. | Type               | Insert                  | Hook Style | Model Group | Cavities | Sizes (oz.) Hook Sizes |         |
|----------|-----------|--------------------|-------------------------|------------|-------------|----------|------------------------|---------|
|          |           |                    |                         |            |             |          | 1/4                    | 3/8     |
| 3322     | SJY-2-Y   | Banana Spinner Jig | RW-35 WSJ-35 Wire Forms | 253 L255   | Assorted    | 2        | 4/0                    | 4/0     |
|          |           |                    |                         |            |             |          | 1/2                    | 5/8     |
| 3323     | SJY-2-M   | Banana Spinner Jig | RW-40 WSJ-40 Wire Forms | 253 L255   | Assorted    | 2        | 4/0-5/0                | 4/0-5/0 |



Ring & Barb Collar  
Attach Rubber Skirts,  
Soft Plastics, or Both

# TAIL SPINNER LURES

Tail Spinner lures have earned a strong reputation as effective producers of Largemouth Bass and schooling fish. That's because the vibrations of the spinner blade are transferred to the lure providing terrific action.

| Item No. | Model No. | Type                  | Insert           | Stick-On Lure Eye | Hook Style  | Model Group | Cavities | Sizes (oz.) Hook Sizes |     |        |     |
|----------|-----------|-----------------------|------------------|-------------------|-------------|-------------|----------|------------------------|-----|--------|-----|
|          |           |                       |                  |                   |             |             |          | 3/8                    | 1/2 | 5/8    | 3/4 |
| 1205     | TS-4-A1   | Tail Spinner          | WTS-28 Wire Form | 5/32" Size 2.5    | 7790X 35517 | Assorted    | 4        | 8, 6, 4 or 2           |     |        |     |
| 3246     | TSH-4-A   | Tail Spinner          | WTS-28 Wire Form | 5/32" Size 2.5    | 7790X 35517 | Assorted    | 4        | 1/2                    | 5/8 | 3/4    | 7/8 |
|          |           |                       |                  |                   |             |             |          | 6 or 8                 |     | 4 or 2 |     |
| 1213     | TSM-5-38  | Cut Face Tail Spinner | WTS-28 Wire Form | Up to Size 5      | 7790X 35517 | Production  | 5        | 3/8                    |     |        |     |
|          |           |                       |                  |                   |             |             |          | 8, 6, or 4             |     |        |     |



Tail Spinner #1205

Cut Face Tail Spinner #1213

Tail Spinner Form  
See page 72

# CRAPPIE SPINNER

There's no gambling here – this small spinner jigs catches big crappies. This lure features a slim head design with a swollen belly for stability. It is built with a .029 wire form for increased vibrations and a small but strong Style 455 hook. The wire and hook combination are light enough for a proper Crappie bait, yet strong enough to handle a good size Bass.

| Item No. | Model No. | Type            | Insert      | Hook Style | Model Group | Cavities | Sizes (oz.) Hook Sizes |        |
|----------|-----------|-----------------|-------------|------------|-------------|----------|------------------------|--------|
|          |           |                 |             |            |             |          | 1/16                   | 1/8    |
| 3288     | SJ-CRP    | Crappie Spinner | RW-29 Forms | 455        | Assorted    | 2        | 6 or 4                 | 2 or 1 |



Holder Collar  
Attach Rubber Skirts  
or Soft Plastics

# BUZZ-KEEL BUZZBAIT

This uniquely designed bait gives you more control than any other buzz bait you have in the tackle box. The wide thin body gets on plane in a hurry and allows you ultimate control in steering the bait back to the boat. The keel shape allows for true tracking and just enough pull to keep the blades running perfect at any speed. Put your limit in the boat with this high powered tool.

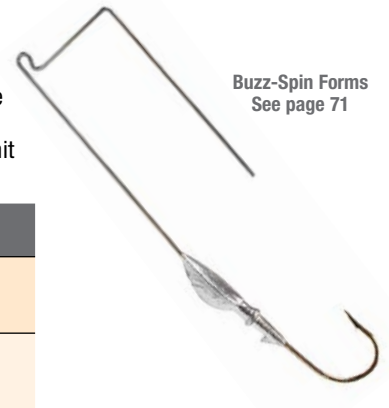

Buzz-Spin Forms  
See page 71

| Item No. | Model No.  | Type      | Insert                     | Hook Style            | Model Group | Cavities | Sizes (oz.)<br>Hook Sizes |     |
|----------|------------|-----------|----------------------------|-----------------------|-------------|----------|---------------------------|-----|
|          |            |           |                            |                       |             |          |                           |     |
| 3457     | BZK-2-3812 | Buzz-Spin | WBS-3812<br>Buzz-Spin Form | 253<br>L255<br>32608N | Assorted    | 2        | 3/8                       | 1/2 |
|          |            |           |                            |                       |             |          | 3/0 or 4/0                |     |
| 3458     | BZK-2-48   | Buzz-Spin | WBS-18<br>WBS-045          | 253<br>L255<br>32608N | Assorted    | 2        | 1/8                       | 1/4 |
|          |            |           |                            |                       |             |          | 2/0 or 3/0                |     |

# BULLET SPINNER JIG

For all around use, the Bullet style is hard to beat. It shoots through the water, blasting by weeds and brush.

| Item No. | Model No. | Type                     | Insert                          | Collar | Hook Style  | Model Group | Cavities | Sizes (oz.)<br>Wire Form Used<br>Hook Sizes |     |                  |     |
|----------|-----------|--------------------------|---------------------------------|--------|-------------|-------------|----------|---|-----|------------------|-----|
|          |           |                          |                                 |        |             |             |          |   |     |                  |     |
| 1214     | SJ-4B-A   | Bullet<br>Spinner<br>Jig | Spinner Jig<br>Forms or<br>Wire | Ball   | 253<br>L255 | Assorted    | 4        | 1/8   | 1/4 | 3/8              | 1/2 |
|          |           |                          |                                 |        |             |             |          | .035 Wire                                   |     | .040 - .041 Wire |     |
|          |           |                          |                                 |        |             |             |          | 1/0   | 2/0 | 3/0              | 4/0 |
| 3226     | SJ-3B-L   | Bullet<br>Spinner<br>Jig | Spinner Jig<br>Forms or<br>Wire | Ball   | 253<br>L255 | Assorted    | 3        | 3/4   | 1   | 1-1/8            |     |
|          |           |                          |                                 |        |             |             |          | .040 - .041 Wire Form                       |     |                  |     |
|          |           |                          |                                 |        |             |             |          | 4/0 or 5/0                                  |     |                  |     |



Ball-type collar secures  
rubber skirts  
or tie-on lure dressing

# BULLET SPINNER JIG - SJB SERIES

Designed to be made with prebent wire forms. The two-cavity arrangement makes molding faster and easier than with the three- and four-cavity models making the same parts. The SJB series also adapts readily to most bottom-pour furnaces.

| Item No. | Model No. | Type                  | Insert                       | Collar | Hook Style  | Model Group | Cavities | Sizes (oz.)<br>Wire Form Used<br>Hook Sizes |     |            |  |
|----------|-----------|-----------------------|------------------------------|--------|-------------|-------------|----------|---|-----|------------|--|
|          |           |                       |                              |        |             |             |          |   |     |            |  |
| 3324     | SJB-2-B   | Bullet<br>Spinner Jig | RW-35<br>RW-40<br>Wire Forms | Ball   | 253<br>L255 | Assorted    | 2        | 1/4   | 3/8 |            |  |
|          |           |                       |                              |        |             |             |          | .035 RW-35                                  |     | .040 RW-40 |  |
|          |           |                       |                              |        |             |             |          | 2/0-3/0                                     |     | 3/0-4/0    |  |
| 3325     | SJB-2-M   | Bullet<br>Spinner Jig | RW-40<br>WSJ-40              | Ball   | 253<br>L255 | Assorted    | 2        | 1/2   | 5/8 |            |  |
|          |           |                       |                              |        |             |             |          | 4/0 - 5/0                                   |     | 4/0 - 5/0  |  |



Spinner Jig Forms  
See page 72

# BUZZ-SPIN LURE

Dare the "Big Boys" – the Bass, Northern and Muskies– to come up to the surface and meet you on your own terms. The Buzz-Spin Lure features a flat, heart-shaped body designed to keep the lure at the surface when used with a delta blade. The retrieve is started as soon as the lure hits the water. The delta blade churns the water at the surface creating a commotion that is a "sure-fired" fish attraction. A very effective lure on suspended game fish such as Bass, Northern and Muskies. Note: Designed for ladle pouring — not intended for use with bottom-pour lead furnaces.

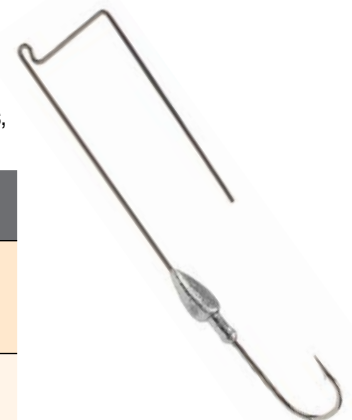

| Item No. | Model No.  | Type      | Insert                        | Collar | Hook Style  | Model Group | Cavities | Sizes (oz.)<br>Wire Form Used<br>Hook Sizes |     |         |  |
|----------|------------|-----------|-------------------------------|--------|-------------|-------------|----------|---|-----|---------|--|
|          |            |           |                               |        |             |             |          |   |     |         |  |
| 1216     | BSJ-2-48   | Buzz-Spin | Buzz-Spin<br>Forms            | Ball   | 253<br>L255 | Combination | 2        | 1/8   | 1/4 |         |  |
|          |            |           |                               |        |             |             |          | WBS-18                                      |     | WBS-045 |  |
|          |            |           |                               |        |             |             |          | 1/0   |     | 2/0     |  |
| 1217     | BSJ-2-3812 | Buzz-Spin | Buzz-Spin<br>Form<br>WBS-3812 | Ball   | 253<br>L255 | Combination | 2        | 3/8   | 1/2 |         |  |
|          |            |           |                               |        |             |             |          | WBS-3812                                    |     |         |  |
|          |            |           |                               |        |             |             |          | 3/0 or 4/0                                  |     |         |  |



# ULTRA MINNOW SPINNER JIG

Modeled after our extremely popular and effective Ultra Minnow Jig, this high tech spinnerbait is sure to deliver huge fish in the live well. Recessed eyes will accept the 5/32" stick-on style eye.

| Item No. | Model No. | Insert                    | Collar | Hook Style      | Model Group | Cavities | Sizes (oz.)<br>Hook Sizes<br>Wire Form Used |              |       |
|----------|-----------|---------------------------|--------|-----------------|-------------|----------|---|--------------|-------|
|          |           |                           |        |                 |             |          |   |              |       |
| 3405     | SJU-3-SA  | Spinner Jig Forms or Wire | Holder | 253 L255 32608N | Assorted    | 3        | 1/4   | 3/8          | 1/2   |
|          |           |                           |        |                 |             |          | 2/0   | 3/0          | 4/0   |
|          |           |                           |        |                 |             |          | .035  | .040 or .041 |       |
| 3406     | SJU-3-MA  | RW-40 WSJ-40 Wire forms   | Holder | 253 L255 32608N | Assorted    | 3        | 5/8   | 3/4          | 1 oz. |
|          |           |                           |        |                 |             |          | 4/0 or 5/0                                  |              |       |



# STYLE "C" SPINNER JIG

Style "C" gives you a wide range of weight options. Use heavier sizes to fish deeper and cast farther so you reach the game fish you seek. Style "C" series is designed to use prebent wire forms. Style "C1" has a trim belly, while Style "C2" has a hefty belly. Mold cavities individually or together.

| Item No. | Model No. | Type                                   | Insert                 | Hook Style | Model Group | Cavities | Sizes (oz.)<br>Wire Form Used<br>Hook Sizes |           |  |
|----------|-----------|--|------------------------|------------|-------------|----------|---|-----------|--|
|          |           |  |                        |            |             |          |   |           |  |
| 3302     | SJ-C1-S   | Style C1 Spinner Jig                   | RW-29 Forms            | 455        | Assorted    | 2        | 1/16  | 1/8       |  |
|          |           |  |                        |            |             |          | 4 or 6                                      | 2 or 1    |  |
| 1226     | SJ-2-C    | 1/4 Style C1 3/8 Style C2 Spinner Jigs | RW-35 RW-40 Wire Forms | 253 L255   | Assorted    | 2        | 1/4   | 3/8       |  |
|          |           |  |                        |            |             |          | .035 Form                                   | .040 Form |  |
|          |           |  |                        |            |             |          | 3/0-4/0                                     | 4/0-5/0   |  |
| 3303     | SJ-C2-M   | Style C2 Spinner Jig                   | RW-40 WSJ-40           | 253 L255   | Assorted    | 2        | 1/2   | 5/8       |  |
|          |           |  |                        |            |             |          | 4/0 or 5/0                                  |           |  |
| 3304     | SJ-C2-L   | Style C2 Spinner Jig                   | RW-40 WSJ-40           | 253 L255   | Assorted    | 2        | 3/4   | 1         |  |
|          |           |  |                        |            |             |          | 4/0 or 5/0                                  |           |  |



# STYLE "H" SPINNER JIG

This spinner jig has a long and narrow head resembling a bait fish with a swollen belly. Predatory game fish think that's easy pickings for dinner. Model SJ-3H-L takes up to 5/32" stick-on eyes and model SJ-3H-X accepts 9/32" eyes.

| Item No. | Model No. | Type                  | Insert                    | Collar | Hook Style  | Model Group | Cavities | Sizes (oz.)<br>Hook Sizes<br>Wire Form Used |                  |       |
|----------|-----------|-----------------------|---------------------------|--------|-------------|-------------|----------|---|------------------|-------|
|          |           |                       |                           |        |             |             |          |   |                  |       |
| 3240     | SJ-3H-SA  | Style "H" Spinner Jig | Spinner Jig Forms or Wire | Ball   | 253 L255    | Assorted    | 3        | 1/4   | 3/8              | 1/2   |
|          |           |                       |                           |        |             |             |          | 2/0   | 3/0              | 4/0   |
|          |           |                       |                           |        |             |             |          | .035 Wire                                   | .040 - .041 Wire |       |
| 3221     | SJ-3H-L   | Style "H" Spinner Jig | Spinner Jig Forms or Wire | Ball   | 253 L255    | Assorted    | 3        | 5/8   | 3/4              | 1 oz. |
|          |           |                       |                           |        |             |             |          | 4/0 or 5/0                                  |                  |       |
|          |           |                       |                           |        |             |             |          | .040 - .041 Wire or Form                    |                  |       |
| 3368     | SJ-3H-X   | Style "H" Spinner Jig | Spinner Jig Forms or Wire | Ball   | L255 32608N | Assorted    | 3        | 1-1/2                                       | 2                | 2-1/2 |
|          |           |                       |                           |        |             |             |          | 5/0 or 6/0                                  |                  |       |
|          |           |                       |                           |        |             |             |          | .040 - .041 Wire Form                       |                  |       |



#3240 has protruding eyes for paint application

# EAR BALL LURE

This little ball provides so many possibilities. It happens to be one of the most popular jig heads in Eastern Europe. Rigged with a split ring, this bait has a swinging hook with tons of action. Tip with floating plastic or even live bait to get more movement than any other jig can provide. Another popular option is to attach a bucktail dressed treble hook. You can also use it as a sinker as a weighted 3-Way rig.



| Item No. | Model No. | Type      | Insert                                 | Model Group | Cavities | Sizes    |            |          |          |          |         |        |  |
|----------|-----------|-----------|--|-------------|----------|----------|------------|----------|----------|----------|---------|--------|--|
|          |           |           |  |             |          | 16g      | 14g        | 12g      | 10g      | 8g       | 6g      | 4g     |  |
| 3410     | EBL-7-A   | Ball Lure | #0 Stainless Steel Eyes                | Assorted    | 7        | 9/16 oz  | 1/2 oz     | 7/16 oz  | 3/8 oz   | 1/4 oz   | 3/16 oz | 1/8 oz |  |
|          |           |           |  |             |          | 18g      | 20g        | 22g      | 24g      | 26g      |         |        |  |
| 3411     | EBL-5-MA  | Ball Lure | #0 Stainless Steel Eyes                | Assorted    | 5        | 5/8 oz   | 11/16 oz   | 3/4 oz   | 7/8 oz   | 15/16 oz |         |        |  |
|          |           |           |  |             |          | 28g      | 32g        | 36g      | 40g      |          |         |        |  |
| 3412     | EBL-4-LA  | Ball Lure | #1 Brass Wire Eyes                     | Assorted    | 4        | 1 oz     | 1-1/8 oz   | 1-1/4 oz | 1-1/2 oz |          |         |        |  |
|          |           |           |  |             |          | 44g      | 48g        | 52g      | 56g      |          |         |        |  |
| 3413     | EBL-4-XL  | Ball Lure | #1 Brass Wire Eyes                     | Assorted    | 4        | 1-1/2 oz | 1-11/16 oz | 1-7/8 oz | 2 oz     |          |         |        |  |
|          |           |           |  |             |          | 2 oz     | 3 oz       | 4 oz     | 6 oz     | 8 oz     |         |        |  |
| 3479     | EBL-5-XLF | Ball Lure | #2 Brass Wire Eyes<br>#5 Crane Swivels | Assorted    | 5        | 2 oz     | 3 oz       | 4 oz     | 6 oz     | 8 oz     |         |        |  |

# HORSE HEAD - PONY HEAD JIGS

When on the tournament trail in search of Crappies, Walleye or Bass, hitch up a Horse or Pony Head Jig to your rig as an efficient spinner and jig combination. The lure's head, with its long and drooping nose, resembles a horse's head, hence the name. And it doesn't hurt that the shape looks like a larva to the fish. The slim shape of the jig's head design minimizes the chance of snags in rocks and brush, yet maximizes the flow of water around the lure to turn the spinner blade. Fish strike at the flashing blade which strategically trails near the hook of this great lure.

**Our Tip for Swivels:** Your lures will be more effective if the swivels turn freely and this means keeping them free of paint. A painted swivel may not rotate, thereby reducing the blade action to that of only a flutter. Carefully paint the jigs with a small brush and avoid getting paint on the swivel. If you spray paint the lures, be sure to cover the swivel. A small diameter plastic drinking straw can be cut to length and slipped over the swivel to protect it from paint.

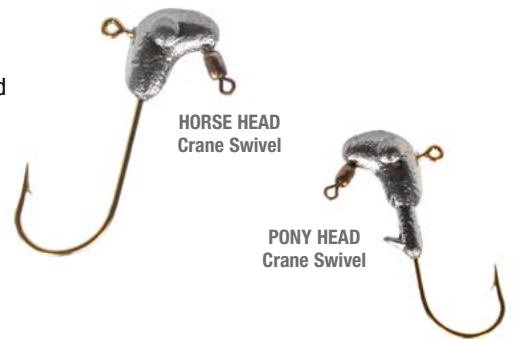

| Item No. | Model No. | Type           | Insert              | Collar | Hook Style | Model Group | Cavities           | Sizes (oz.)<br>Hook Sizes |      |      |      |      |     |
|----------|-----------|----------------|---------------------|--------|------------|-------------|--------------------|---------------------------|------|------|------|------|-----|
|          |           |                |                     |        |            |             |                    | 1/48                      | 1/32 | 1/16 | 1/8  | 3/16 | 1/4 |
| 1220     | JH-6-A    | Horse Head Jig | No. 12 Crane Swivel | None   | 570<br>575 | Assorted    | 6                  | 8                         | 6    | 4    | 1    | 1/0  | 2/0 |
|          |           |                |                     |        |            |             |                    | 1/32                      | 1/16 | 1/8  | 3/16 | 1/4  |     |
| 1221     | JH-8-1632 | Horse Head Jig | No. 12 Crane Swivel | None   | 570<br>575 | Combination | 8<br>(4 each size) | 6                         | 4    | 1/0  | 2/0  |      |     |
|          |           |                |                     |        |            |             |                    | 1/32                      | 1/16 | 1/8  | 3/16 | 1/4  |     |
| 1224     | PHB-5-A   | Pony Head Jig  | No. 12 Crane Swivel | Barb   | 570<br>575 | Assorted    | 5                  | 1/32                      | 1/16 | 1/8  | 1/4  | 3/8  |     |
|          |           |                |                     |        |            |             |                    | 6                         | 4    | 1/0  | 1/0  | 2/0  |     |
| 3201     | PHB-16    | Pony Head Jig  | No. 12 Crane Swivel | Barb   | 570<br>575 | Production  | 6                  | 1/16                      | 1/8  | 3/16 | 1/4  |      |     |
|          |           |                |                     |        |            |             |                    | 4                         | 1/0  | 2/0  |      |      |     |
| 3202     | PHB-18    | Pony Head Jig  | No. 12 Crane Swivel | Barb   | 570<br>575 | Production  | 5                  | 1/8                       | 1/4  | 3/8  | 1/2  |      |     |
|          |           |                |                     |        |            |             |                    | 1 or 2                    | 1/0  | 2/0  |      |      |     |
| 3203     | PHB-14    | Pony Head Jig  | No. 12 Crane Swivel | Barb   | 570<br>575 | Production  | 5                  | 1/4                       | 3/8  | 1/2  | 5/8  |      |     |
|          |           |                |                     |        |            |             |                    | 1, 1/0 or 2/0             | 1/0  | 2/0  |      |      |     |

## SPECIAL NOTICE TO COMMERCIAL LURE MANUFACTURERS:

On January 16, 1990, the Blakemore Sales Company obtained a U.S. Trademark registration for the shape of a lure resembling those made from our Horse Head and Pony Head lure molds. Lures of this shape have been made and marketed by many different companies, both large and small, for many decades prior to and continuing through the date of registration. They have long been known generically as "horse head jigs" or "pony head jigs." We thus do not believe the shape can now be a valid trademark belonging to a single company. The validity of this trademark registration has not been tested in court, so the commercial sale of these lures could involve claims against you. As with castings made from any model, the right to use Do-it® Molds to make tackle for commercial use is left for you to determine, and we make no warranty or other representations of any kind with respect to your right to do so.

# SEA HORSE JIG

A larger version of the popular Horse Head Jig, the Sea Horse uses the strong hooks you need to land Striped Bass and other large game fish. The bent down portion of the head serves as both an attachment point for the spinner blade and a stabilizing rudder to keep the torque of the rotating blade from turning this jig to its side.

| Item No. | Model No. | Type          | Insert            | Collar      | Hook Style | Model Group | Cavities | Sizes (oz.)<br>Hook Sizes |     |       |     |
|----------|-----------|---------------|-------------------|-------------|------------|-------------|----------|---------------------------|-----|-------|-----|
| 1227     | PHC-4-A   | Sea Horse Jig | #10 Crane Swivels | Ring & Barb | 630<br>635 | Assorted    | 4        | 1/4                       | 3/8 | 1/2   | 5/8 |
|          |           |               |                   |             |            |             |          | 2/0                       | 2/0 | 3/0   | 4/0 |
| 1228     | PHC-3-L   | Sea Horse Jig | #7 Crane Swivels  | Ring & Barb | 630<br>635 | Assorted    | 3        | 3/4                       | 1   | 1-1/2 |     |
|          |           |               |                   |             |            |             |          | 4/0                       | 5/0 | 6/0   |     |



Ring & Barb Collar attaches tied material or plastic bodies

## HORSE HEAD - PONY HEAD - SEA HORSE COMPONENT GUIDE

| Lure Size       | 1/48 | 1/32 | 1/16 | 1/8 | 1/4 | 3/8 | 1/2 | 3/4 | 1 | 1-1/2 |
|-----------------|------|------|------|-----|-----|-----|-----|-----|---|-------|
| Split Ring Size | 0    | 0    | 0    | 0   | 0   | 0   | 1   | 1   | 1 | 1     |
| Blade Size      | 00   | 00   | 00   | 0   | 1   | 1   | 2   | 2   | 2 | 3     |

Larger blade sizes can add more flash, but may require slower jiggling speed for lure stabilization.

# FLUTTER LURE

Deep jiggling is all the rage and our flutter lure mold allows you to customize your own lures for all types of tackle and a wide range of species. Our unique geometrical design creates the all enticing "flutter" that triggers the fish to bite. Solid wire inserts running completely through the lure provide great strength but still allow you to custom bend the lure to your designed flutter pattern.

| Item No. | Model No. | Type        | Model Group | Cavities | Sizes (oz.) |     |     |   |
|----------|-----------|-------------|-------------|----------|-------------|-----|-----|---|
| 3460     | FRS-4-A   | Flutter Jig | Assorted    | 4        | 1/4         | 1/2 | 3/4 | 1 |
| 3461     | FRS-2-23  | Flutter Jig | Combination | 2        | 2           |     | 3   |   |
| 3462     | FRS-1-4   | Flutter Jig | Single      | 1        | 4           |     |     |   |
| 3463     | FRS-1-5   | Flutter Jig | Single      | 1        | 5           |     |     |   |
| 3464     | FRS-2-79  | Flutter Jig | Combination | 2        | 7           | 9   |     |   |



Wire Form Page 72

## FLUTTER LURE COMPONENT GUIDE

| Lure Size (oz.)      | 1/4  | 1/2  | 3/4  | 1     | 2        | 3        | 4        | 5          | 7        | 9        |
|----------------------|------|------|------|-------|----------|----------|----------|------------|----------|----------|
| Hook Size            | 8    | 4    | 1    | 1     | 1/0, 2/0 | 2/0, 3/0 | 4/0, 5/0 | 5/0, 7/0   | 7/0, 9/0 | 7/0, 9/0 |
| Wire Form            | FL14 | FL12 | FL34 | FL100 | FL200    | FL300    | FL400    | FL500      | FL700    | FL900    |
| Eye Size (page 77)   | 1.5  | 2    | 2.5  | 2.5   | 2.5      | 4        | 5        | 5          | 5        | 6        |
| Solid-Ring (page 77) | #4   | #4   | #5   | #5    | #6.5     | #6.5     | #6.5     | #6.5, #7.5 | #7.5, #9 | #7.5, #9 |
| Split-Ring (page 76) | #4   | #4   | #5   | #6    | #7       | #7, #8   | #8, #9   | #8, #9     | #10, #11 | #10, #11 |

# LURE BODY

This tried-and-true body doesn't need any fancy name. It's a Lure Body, and that pretty much says it all. But what the name doesn't describe is the great flexibility this body offers. Lure bodies make effective weighted spinners that attract the attention of Bass or other game fish. Or, use a Lure Body alone as a streamlined slip sinker for a smooth descent through the water. Either way, the Lure Body is your choice. One core shaft per cavity is included in each mold.

| Item No. | Model No. | Insert              | Hook Style          | Model Group | Cavities | Sizes (oz.)<br>Hook Sizes |      |     |     |     |
|----------|-----------|---------------------|---------------------|-------------|----------|---------------------------|------|-----|-----|-----|
| 3225     | LB-5-A    | S-040<br>Core Shaft | 3551<br>Treble Hook | Assorted    | 5        | 1/32                      | 1/16 | 1/8 | 1/4 | 3/8 |
|          |           |                     |                     |             |          | Optional                  |      |     |     |     |



Use the Lure Body alone as a slip sinker

Extra core shafts See page 102



# MINNOW SPOON

Much like the Shad Spoon, this tool solves the riddle of how to get where the fish are and waste no time getting there. If you like fishing drops with a good all purpose lure...this is your new baby. Elongated body and tapers make for a great presentation.

| Item No. | Model No. | Insert              | Eye Size    | Model Group | Cavities | Sizes (oz.) Wire Form Used |        |        |
|----------|-----------|---------------------|-------------|-------------|----------|----------------------------|--------|--------|
|          |           |                     |             |             |          | 3/4                        | 1      | 1-1/2  |
| 3485     | GMS-3-A   | CC Style Wire Forms | 1/4" Size 4 | Assorted    | 3        | CC-100                     | CC-150 | CC-200 |
|          |           |                     |             |             |          |                            |        |        |



# SHAD BAIT LURE

Whether it's the unique wobble action when you are trolling, the style of the drop and flutter when you are jigging or the tuned wiggle upon a retrieved cast, this lure has all the versatility you could hope for. The details of a swollen belly, lips, gill plates, fins, recessed eyes and a lateral line make this gem appear to come to life in the water. Try tweaking the tail a bit to change the action when you want to trigger your next pole bender. Item 3392 produces the same casting as 3383 but without the Brass Eye.



| Item No. | Model No. | Type           | Insert   | Eye Size       | Hook Style    | Model Group | Cavities | Sizes (oz.) Hook Sizes |       |       |
|----------|-----------|----------------|--|----------------|---------------|-------------|----------|------------------------|-------|-------|
|          |           |                |  |                |               |             |          | 4                      | 6     |       |
| 3383     | SBL-2-46B | Shad Bait Lure | CC-600 #1 Brass Eye                                | 9/32" Size 5   | 35517<br>3551 | Combination | 2        | 4                      | 6     |       |
|          |           |                |  |                |               |             |          | 6-2/0                  | 2-4/0 |       |
| 3391     | SBL-3-M   | Shad Bait Lure | CC-34<br>CC-100<br>CC-150                          | 5/32" Size 2.5 | 35517<br>3551 | Assorted    | 3        | 3/4                    | 1     | 1-1/2 |
|          |           |                |  |                |               |             |          | 8                      | 6     | 4     |
| 3392     | SBL-2-46  | Shad Bait Lure | CC-600   | 9/32" Size 5   | 35517<br>3551 | Combination | 2        | 4                      | 6     |       |
|          |           |                |  |                |               |             |          | 6-2/0                  | 2-4/0 |       |
| 3407     | SBL-3-MB  | Shad Bait Lure | CC-34<br>CC-100<br>CC-150<br>#0 Stainless Wire Eye | 5/32" Size 2.5 | 35517<br>3551 | Assorted    | 3        | 3/4                    | 1     | 1-1/2 |
|          |           |                |  |                |               |             |          | 8                      | 6     | 4     |

# SHAD SPOON

Tired of spoons with no weight, we were, so we brought out an old school favorite. If you're looking for something you can throw a country mile or get down quick and wobbles like mad, here is your answer.

| Item No. | Model No. | Insert              | Eye Size    | Model Group | Cavities | Sizes (oz.) Wire Form Used |        |        |
|----------|-----------|---------------------|-------------|-------------|----------|----------------------------|--------|--------|
|          |           |                     |             |             |          | 3/4                        | 1      | 1-1/2  |
| 3482     | SJS-3-A   | CC Style Wire Forms | 1/4" Size 4 | Assorted    | 3        | CC-34                      | CC-100 | CC-150 |
|          |           |                     |             |             |          |                            |        |        |



# SLIP JIG LURE

This jig is basically a sliding worm weight. Finish your Slip Jig like a bass jig and fish it Texas style with a plastic worm. Slips easily through heavy cover and has more fish appeal than a standard Texas rig.

Slip Jig features a tying collar to add a skirt or reel rubber



| Item No. | Model No. | Insert          | Model Group | Cavities | Sizes (oz.) |      |     |     |     |      |
|----------|-----------|-----------------|-------------|----------|-------------|------|-----|-----|-----|------|
| 3196     | SLIP-6-A  | PWR-16 Pull Pin | Assorted    | 6        | 1/8         | 3/16 | 1/4 | 3/8 | 1/2 | 9/16 |

# TROLLING LURE

Similar design to the Slip Jig, the weighted portion of this bait slips freely through vegetation. The trolling lure especially excels in saltwater. A flair collar blouses bucktail or synthetic lure dressing to give a full look with less material. Features larger core diameter for heavier test line.



Fishing line threads through 3/32" diameter hole

| Item No. | Model No. | Insert           | Collar | Hook Style | Model Group | Cavities | Sizes (oz.) |     |     |   |
|----------|-----------|------------------|--------|------------|-------------|----------|-------------|-----|-----|---|
| 3255     | TL-4-A    | PEG-332 Pull Pin | Flair  | Optional   | Assorted    | 4        | 1/2         | 5/8 | 3/4 | 1 |

PEG-332 Pull Pin Included With Mold

# ULTRA RIG UMBRELLA

Create your own feeding frenzy with this umbrella rig capable of fishing up to 5 lures.



Ultra Rig Wire Form  
Item No. 5860  
See page 75

| Item No. | Model No. | Type         | Insert               | Eye Size       | Model Group | Cavities | Sizes (oz.) |      |     |     |     |
|----------|-----------|--------------|----------------------|----------------|-------------|----------|-------------|------|-----|-----|-----|
| 3496     | AUR-5-A   | Umbrella Rig | Ultra Rig wire forms | 5/32" Size 2.5 | Assorted    | 5        | 3/8         | 7/16 | 1/2 | 5/8 | 3/4 |

# HERRING HEAD UNDERSPIN

It's no longer a secret that underspin baits catch big fish when other baits don't. They can be deadly on finicky fish in the winter months. Now you can make your very own Herring Heads in all of your favorite sizes and dress them up to your liking. Fished fast or slow the Herring Head adds the flash and spin that it takes to entice strikes. The new Do-it WEY 525 wire form allows you to attach high quality swivels to ensure the blades spin at even the slowest of retrieves. The Herring/Minnow style head does a great job portraying a bait fish. Paint them up to match the forage at your favorite lake and build them from 1/8th all the way up to 5/8 with Gamakatsu 604 round bend heavy wire hooks. It's time to add the Herring Head to your jigging arsenal today.



WEY525 Wire Form Item No. 2621 & 2622  
See page 75  
WEY375 Wire Form Item No. 2623 & 2624  
See page 75

| Item No. | Model No. | Type      | Insert           | Collar      | Model Group | Cavities | Hook Style                                       | Sizes (oz.)<br>Hook Sizes<br>2D or 3D Stick-on Lure Eye Size |         |                 |            |                    |     |
|----------|-----------|-----------|------------------|-------------|-------------|----------|--|--|---------|-----------------|------------|--------------------|-----|
|          |           |           |                  |             |             |          |  | 1/8  | 1/4     | 3/8             | 1/2        | 5/8                |     |
| 3510     | HHU-5-A   | Underspin | WEY525 Wire Form | Ring & Barb | Assorted    | 5        | Gamakatsu 604 Round Bend Wire Jig Hooks          | 3/0  | 4/0-5/0 | 4/0-5/0         | 4/0-5/0    | 4/0-5/0            |     |
|          |           |           |                  |             |             |          |  | 5/32" Size 2.5 Eye   |         |                 |            |                    |     |
|          |           |           |                  |             |             |          |  |  |         |                 |            |                    |     |
| 3514     | HHU-6-SA  | Underspin | WEY375 Wire Form | Ring & Barb | Assorted    | 6        | Eagle Claw Style 570 or 575 Aberdeen Jig Hooks   | 1/16   | 3/32    | 1/8             | 5/32       | 3/16               | 1/4 |
|          |           |           |                  |             |             |          |  | 4  | 2       | 1               | 1/0        | 2/0-1/0            | 2/0 |
|          |           |           |                  |             |             |          |  | 3/32" Size 1.5 Eye   |         | 1/8" Size 2 Eye |            | 5/32" Size 2.5 Eye |     |
| 3515     | HHU-4-LA  | Underspin | WEY525 Wire Form | Ring & Barb | Assorted    | 4        | Mustad Style 32786 60 Degree Wide Bend Jig Hooks | 3/4  | 1       | 1 1/4           | 1 1/2      |                    |     |
|          |           |           |                  |             |             |          |  | 5/0  |         | 6/0             | 6/0 or 7/0 |                    |     |
|          |           |           |                  |             |             |          |  | 9/32" Size 5 Eye   |         |                 |            |                    |     |

# BANK SINKER

Bank on this sinker to lower your line to new depths, and you'll pull 'em in like chump change... in fresh or saltwater.

Hexagon sides resist rolling in currents



Tapered for fewer snags

| Item No. | Model No. | Type        | Model Group   | Cavities | Sizes (oz.) |     |     |     |     |     |   |       | Size No. On Sinker |
|----------|-----------|-------------|---------------|----------|-------------|-----|-----|-----|-----|-----|---|-------|--------------------|
|          |           |             |               |          | 1/8         | 1/4 | 3/8 | 1/2 | 3/4 | 7/8 | 1 | 1-1/2 |                    |
| 1101     | BK-8-A    | Bank Sinker | Assorted      | 8        | 1/8         | 1/4 | 3/8 | 1/2 | 3/4 | 7/8 | 1 | 1-1/2 | Yes                |
| 1102     | BK-4-L    | Bank Sinker | Assorted      | 4        | 2           |     | 3   |     | 4   |     | 5 |       | Yes                |
| 1103     | BK-2-X    | Bank Sinker | Combination   | 2        | 6           |     |     |     | 8   |     |   |       | Yes                |
| 3481     | BK-2-79   | Bank Sinker | Combination   | 2        | 7           |     |     |     | 9   |     |   |       | Yes                |
| 1165     | BK-1-10   | Bank Sinker | Single Cavity | 1        | 10          |     |     |     |     |     |   |       | Yes                |
| 1166     | BK-1-12   | Bank Sinker | Single Cavity | 1        | 12          |     |     |     |     |     |   |       | Yes                |
| 1104     | BK-1-14   | Bank Sinker | Single Cavity | 1        | 14          |     |     |     |     |     |   |       | Yes                |
| 1167     | BK-1-16   | Bank Sinker | Single Cavity | 1        | 16          |     |     |     |     |     |   |       | Yes                |
| 3269     | BK-1-18   | Bank Sinker | Single Cavity | 1        | 18          |     |     |     |     |     |   |       | Yes                |
| 3271     | BK-1-20   | Bank Sinker | Single Cavity | 1        | 20          |     |     |     |     |     |   |       | Yes                |
| 3272     | BK-1-24   | Bank Sinker | Single Cavity | 1        | 24          |     |     |     |     |     |   |       | Yes                |
| 1191     | BK-9-38   | Bank Sinker | Production    | 9        | 3/8         |     |     |     |     |     |   |       | Yes                |
| 1192     | BK-8-12   | Bank Sinker | Production    | 8        | 1/2         |     |     |     |     |     |   |       | Yes                |
| 1193     | BK-7-34   | Bank Sinker | Production    | 7        | 3/4         |     |     |     |     |     |   |       | Yes                |
| 1105     | BK-6-1    | Bank Sinker | Production    | 6        | 1           |     |     |     |     |     |   |       | Yes                |
| 1194     | BK-6-112  | Bank Sinker | Production    | 6        | 1-1/2       |     |     |     |     |     |   |       | Yes                |
| 1106     | BK-4-2    | Bank Sinker | Production    | 4        | 2           |     |     |     |     |     |   |       | Yes                |
| 3173     | BK-3173   | Bank Sinker | Production    | 4        | 2-1/2       |     |     |     |     |     |   |       | Yes                |
| 1107     | BK-4-3Z   | Bank Sinker | Production    | 4        | 3           |     |     |     |     |     |   |       | Yes                |
| 1108     | BK-3-4    | Bank Sinker | Production    | 3        | 4           |     |     |     |     |     |   |       | Yes                |
| 1109     | BK-3-5    | Bank Sinker | Production    | 3        | 5           |     |     |     |     |     |   |       | Yes                |

# STORM SINKER

Surf casting sinker with extra teeth for a better hold.

| Item No. | Model No.  | Type   | Insert            | Model Group | Cavities | Sizes (oz.) |   |   | Size No. On Sinker |
|----------|------------|--------|-------------------|-------------|----------|-------------|---|---|--------------------|
|          |            |        |                   |             |          | 2           | 3 | 4 |                    |
| 3408     | STM-3-234B | Sinker | #2 Brass Wire Eye | Assorted    | 3        | 2           | 3 | 4 | Yes                |
| 3409     | STM-2-56B  | Sinker | #2 Brass Wire Eye | Combination | 2        | 5           |   | 6 | Yes                |



# WORM NOSE SINKER

For that finesse fishing fan that wants to add that little bit of weirdness that makes 'em go wild. Slide this weight into one of both ends of a wacky rigged worm and drive them nuts. Use your imagination to make them all certifiable.

| Item No. | Model No. | Type             | Model Group | Cavities | Sizes (oz.) |     |      |     |      |     | Size No. On Sinker |
|----------|-----------|------------------|-------------|----------|-------------|-----|------|-----|------|-----|--------------------|
|          |           |                  |             |          | 1/16        | 1/8 | 3/16 | 1/4 | 5/16 | 3/8 |                    |
| 3474     | WNS-6-A   | Worm Nose Sinker | Assorted    | 6        | 1/16        | 1/8 | 3/16 | 1/4 | 5/16 | 3/8 | Yes                |



# BELL SINKER

Bell Sinkers are teardrop shaped to cast smoothly and resist snags on the retrieve. Designed with a molded eye, these beauties can be produced quickly and inexpensively. Now that's a common-sense solution that rings out loud and clear.

| Item No. | Model No. | Type        | Model Group | Cavities                  | Sizes (oz.) |     |     |     |       |   |       | Size No. On Sinker |     |
|----------|-----------|-------------|-------------|---------------------------|-------------|-----|-----|-----|-------|---|-------|--------------------|-----|
|          |           |             |             |                           | 1/8         | 1/4 | 3/8 | 1/2 | 5/8   | 1 | 1-1/2 |                    | 2   |
| 1114     | BE-8-A    | Bell Sinker | Assorted    | 8                         | 1/8         | 1/4 | 3/8 | 1/2 | 5/8   | 1 | 1-1/2 | 2                  | Yes |
| 1116     | BE-9-S2   | Bell Sinker | Combination | 9<br>(5 of 3/8, 4 of 5/8) | 3/8         |     |     | 5/8 |       |   |       | Yes                |     |
| 1117     | BE-8-M2   | Bell Sinker | Combination | 8<br>(4 each size)        | 1           |     |     |     | 1-1/2 |   |       |                    | Yes |

Molded eye requires no insert





# BASS CASTING - SWIVEL BELL SINKER

Battle with the Bass, not your line! Bass Casting or Swivel Bell sinkers feature a molded-in swivel, so you don't become the frustrated "twisted" fisherman.



Molded in swivel enhances line control  
See page 70

| Item No. | Model No. | Type                | Insert            | Model Group | Cavities                  | Sizes (oz.) |     |     |     |     |   |       |   | Size No. On Sinkers |     |
|----------|-----------|---------------------|-------------------|-------------|---------------------------|-------------|-----|-----|-----|-----|---|-------|---|---------------------|-----|
|          |           |                     |                   |             |                           | 1/8         | 1/4 | 3/8 | 1/2 | 5/8 | 1 | 1-1/2 | 2 |                     |     |
| 1110     | BC-8-A    | Bass Casting Sinker | #7 Barrel Swivel  | Assorted    | 8                         |             |     |     |     |     |   |       |   |                     | Yes |
| 1112     | BC-9-S2   | Bass Casting Sinker | #7 Barrel Swivel  | Combination | 9<br>(5 of 3/8, 4 of 5/8) |             |     | 3/8 |     |     |   | 5/8   |   |                     | Yes |
| 1113     | BC-8-M2   | Bass Casting Sinker | #7 Barrel Swivel  | Combination | 8<br>(4 each size)        |             |     | 1   |     |     |   | 1-1/2 |   |                     | Yes |
| 3259     | BC-3-345  | Bass Casting Sinker | #3 Barrel Swivel  | Assorted    | 3                         |             | 3   |     |     | 4   |   | 5     |   |                     | Yes |
| 3260     | BC-2-68   | Bass Casting Sinker | #3 Barrel Swivel  | Combination | 2                         |             |     | 6   |     |     |   | 8     |   |                     | Yes |
| 3261     | BC-2-1012 | Swivel Bell Sinker  | 1/0 Barrel Swivel | Combination | 2                         |             |     | 10  |     |     |   | 12    |   |                     | Yes |
| 3262     | BC-2-1416 | Swivel Bell Sinker  | 1/0 Barrel Swivel | Combination | 2                         |             |     | 14  |     |     |   | 16    |   |                     | Yes |
| 3263     | BC-1-20   | Swivel Bell Sinker  | 1/0 Barrel Swivel | Single      | 1                         |             |     |     |     | 20  |   |       |   |                     | Yes |
| 3256     | BC-9-12   | Bass Casting Sinker | #7 Barrel Swivel  | Production  | 9                         |             |     |     |     | 1/2 |   |       |   |                     | Yes |
| 3257     | BC-9-34   | Bass Casting Sinker | #7 Barrel Swivel  | Production  | 9                         |             |     |     |     | 3/4 |   |       |   |                     | Yes |
| 3258     | BC-8-1    | Bass Casting Sinker | #7 Barrel Swivel  | Production  | 8                         |             |     |     |     | 1   |   |       |   |                     | Yes |
| 3314     | BC-5-2    | Bass Casting Sinker | #7 Barrel Swivel  | Production  | 5                         |             |     |     |     | 2   |   |       |   |                     | Yes |

# BELL SINKER WITH BRASS EYELETS

One of the most popular sinker designs ingeniously combined with a tough and smooth brass wire eyelet. The results are a strengthened sinker, reduction of line abrasion and the ability to attach a snap or a snap swivel.

Brass Wire Eye reduces line abrasion  
See page 70



Teardrop shape casts smoothly

| Item No. | Model No. | Type        | Insert            | Model Group | Cavities | Sizes (oz.) |     |     |     |     |     |   |       | Size No. On Sinkers |     |
|----------|-----------|-------------|-------------------|-------------|----------|-------------|-----|-----|-----|-----|-----|---|-------|---------------------|-----|
|          |           |             |                   |             |          | 1/8         | 1/4 | 3/8 | 1/2 | 5/8 | 3/4 | 1 | 1-1/2 |                     | 2   |
| 1169     | BL-9-AB   | Bell Sinker | #1 Brass Wire Eye | Assorted    | 9        |             |     |     |     |     |     |   |       |                     | Yes |
| 3338     | BL-3-345B | Bell Sinker | #2 Brass Wire Eye | Assorted    | 3        |             |     | 3   |     |     | 4   |   | 5     |                     | Yes |
| 3339     | BL-2-68B  | Bell Sinker | #2 Brass Wire Eye | Combination | 2        |             |     | 6   |     |     |     | 8 |       |                     | Yes |

# BOTTOM BOUNCER SINKER

Bounce over obstructions that would snag most other sinkers. Our Bottom Bouncer is a modern snagless-type sinker. The slender shape of the lead body and wire extending through it permits the Bottom Bouncer to bump and bounce over obstructions. The bait and hook trail safely above and behind as the stainless steel wire springs over rocks.

Note: This lure must be molded by "ladle pouring" with SOFT LEAD ONLY!

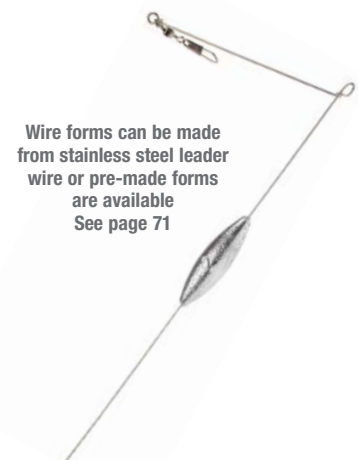

Wire forms can be made from stainless steel leader wire or pre-made forms are available  
See page 71

| Item No. | Model No. | Type           | Insert           | Model Group | Cavities | Sizes (oz.) |     |     |     |     | Size No. On Sinkers |
|----------|-----------|----------------|------------------|-------------|----------|-------------|-----|-----|-----|-----|---------------------|
|          |           |                |                  |             |          | 1/8         | 1/4 | 3/8 | 1/2 | 5/8 |                     |
| 3223     | BTM-5-SA  | Bottom Bouncer | .035 Wire WBB-35 | Assorted    | 5        |             |     |     |     |     | Yes                 |
| 3307     | BTM-5-M   | Bottom Bouncer | .035 Wire WBB-35 | Assorted    | 5        |             |     |     |     |     | Yes                 |
| 3224     | BTM-3-L   | Bottom Bouncer | .041 Wire WBB-40 | Assorted    | 3        |             |     |     |     |     | Yes                 |

# CANNON BALL SINKER



Round shape for a fast descent

Cannon Balls drop faster and straighter than other sinkers. Load your rig with these round sinkers and shoot your lure down to the depths you need.

| Item No. | Model No.  | Type               | Insert            | Model Group | Cavities    | Sizes    |          |           |          | Size No. On Sinkers |
|----------|------------|--------------------|-------------------|-------------|-------------|----------|----------|-----------|----------|---------------------|
| 3184     | CB-10-S2B  | Cannon Ball Sinker | #1 Brass Wire Eye | Combination | 10 (5 each) | 1/2 oz   |          | 3/4 oz    |          | Yes                 |
| 3185     | CB-4-AB    | Cannon Ball Sinker | #1 Brass Wire Eye | Assorted    | 4           | 1 oz     | 2 oz     | 3 oz      | 4 oz     | Yes                 |
| 3435     | CB-4-154B  | Cannon Ball Sinker | #1 Brass Wire Eye | Assorted    | 4           | 1-1/2 oz | 2-1/2 oz | 3-1/2 oz. | 4-1/2 oz | Yes                 |
| 3186     | CB-3-456B  | Cannon Ball Sinker | #2 Brass Wire Eye | Assorted    | 3           | 4 oz     |          | 5 oz      | 6 oz     | Yes                 |
| 3187     | CB-2-810B  | Cannon Ball Sinker | #2 Brass Wire Eye | Combination | 2           | 8 oz     |          | 10 oz     |          | Yes                 |
| 3188     | CB-2-1216B | Cannon Ball Sinker | #2 Brass Wire Eye | Combination | 2           | 12 oz    |          | 16 oz     |          | Yes                 |
| 3414     | CB-2-23LF  | Cannon Ball Sinker | #3 Brass Wire Eye | Combination | 2           | 2 lbs    |          | 3 lbs     |          | Yes                 |
| 3415     | CB-2-45LF  | Cannon Ball Sinker | #3 Brass Wire Eye | Combination | 2           | 4 lbs    |          | 5 lbs     |          | Yes                 |

## CANNON BALL SINKER SIZE CHART

| Weight Size      | 1/2 oz. | 3/4 oz. | 1 oz. | 1.5 oz | 2 oz. | 2.5 oz. | 3 oz. | 3.5 oz. | 4 oz. | 4.5 oz. | 5 oz. | 6 oz. | 8 oz. | 10 oz. | 12 oz. | 16 oz. | 2 lbs. | 3 lbs. | 4 lbs. | 5 lbs. |
|------------------|---------|---------|-------|--------|-------|---------|-------|---------|-------|---------|-------|-------|-------|--------|--------|--------|--------|--------|--------|--------|
| Approx. Diameter | .55"    | .62"    | .66"  | .76"   | .83"  | .90"    | .96"  | 1.02"   | 1.05" | 1.10"   | 1.14" | 1.20" | 1.35" | 1.43"  | 1.54"  | 1.69"  | 2.11"  | 2.42"  | 2.67"  | 2.88"  |

# CLAW SINKER

When you're angling in heady waters, the Claw Sinker hangs on like a grappling hook...even under very swift currents. Pre-made wire forms are not available, but you can make forms using galvanized wire found at your hardware store.



Claw Sinker grabs on in fast waters

| Item No. | Model No.  | Type        | Insert                  | Model Group | Cavities | Sizes (oz.) |    |   | Size No. On Sinkers |
|----------|------------|-------------|-------------------------|-------------|----------|-------------|----|---|---------------------|
| 3275     | CLAW-3-234 | Claw Sinker | 18 to 20 Ga. Galv. Wire | Assorted    | 3        | 2           | 3  | 4 | Yes                 |
| 3243     | CLAW-2-X   | Claw Sinker | 14 to 16 Ga. Galv. Wire | Combination | 2        | 5-1/2       |    | 8 | Yes                 |
| 3274     | CLAW-2-910 | Claw Sinker | 14 to 16 Ga. Galv. Wire | Combination | 2        | 9           | 10 |   | Yes                 |

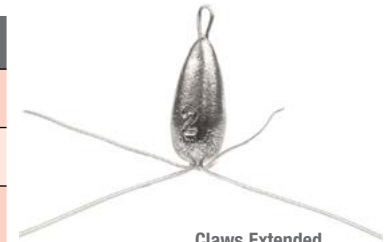

Claws Extended

# CRESCENT SINKER

Shaped like a crescent moon and designed as an in-line sinker, the Crescent Sinker acts as a keel to prevent rotation and line twists. Optional swivels may be added to each brass wire eye for added performance.

Acts as a keel for added line control



Brass wire eye prevents line abrasion See page 70

| Item No. | Model No. | Type            | Required Insert   | Optional Insert             | Model Group | Cavities | Sizes (oz.) |       |   | Size No. On Sinkers |     |
|----------|-----------|-----------------|-------------------|-----------------------------|-------------|----------|-------------|-------|---|---------------------|-----|
| 1180     | CR-4-AB   | Crescent Sinker | #1 Brass Wire Eye | #7 Crane Swivel #2 B-Chain  | Assorted    | 4        | 1           | 1-1/2 | 2 | 3                   | Yes |
| 1181     | CR-45B    | Crescent Sinker | #2 Brass Wire Eye | 1/0 Crane Swivel #3 B-Chain | Combination | 2        | 4           |       | 5 | Yes                 |     |
| 1182     | CR-6B     | Crescent Sinker | #2 Brass Wire Eye | 1/0 Crane Swivel #3 B-Chain | Single      | 1        | 6           |       |   | Yes                 |     |

Optional swivels for added performance See page 70



# EGG - SLIP SINKER

“Slip” by your fish undetected. The line will slip through the Egg or Slip sinker, so the fish will not feel the weight of the sinker when it picks up the bait. The hook settles more quickly without the sinker’s resistance. Plus, the fish can’t use the sinker’s weight to help throw the hook when breaking water. This fish won’t be the one that “got away.”



Fish won't detect the Egg Sinker until it's too late

| Item No. | Model No.  | Type       | Insert           | Model Group | Cavities                   | Sizes (oz.) |     |     |     |     |   |       |   |   |     | Size No. On Sinker |
|----------|------------|------------|------------------|-------------|----------------------------|-------------|-----|-----|-----|-----|---|-------|---|---|-----|--------------------|
|          |            |            |                  |             |                            | 1/8         | 1/4 | 3/8 | 1/2 | 3/4 | 1 | 1-1/2 | 2 | 3 |     |                    |
| 1170     | EG-9-A     | Egg Sinker | PEG-332 Pull Pin | Assorted    | 9                          |             |     |     |     |     |   |       |   |   |     | Yes                |
| 1173     | EG-5-LA    | Egg Sinker | PEG-332 Pull Pin | Assorted    | 5                          | 1           |     | 2   |     | 3   |   | 4     |   | 5 | Yes |                    |
| 1174     | EG-2-68    | Egg Sinker | PEG-332 Pull Pin | Combination | 2                          |             |     | 6   |     |     |   | 8     |   |   | Yes |                    |
| 1171     | EG-14-48   | Egg Sinker | PEG-332 Pull Pin | Combination | 14<br>(7 each size)        |             |     | 1/8 |     |     |   | 1/4   |   |   | Yes |                    |
| 1172     | EG-11-1412 | Egg Sinker | PEG-332 Pull Pin | Combination | 11<br>(6 of 1/4, 5 of 1/2) |             |     | 1/4 |     |     |   | 1/2   |   |   | Yes |                    |
| 1121     | EG-9-M2    | Egg Sinker | PEG-332 Pull Pin | Combination | 9<br>(5 of 3/8, 4 of 3/4)  |             |     | 3/8 |     |     |   | 3/4   |   |   | Yes |                    |
| 1122     | EG-6-L2    | Egg Sinker | PEG-332 Pull Pin | Combination | 6<br>(3 each size)         |             |     | 1   |     |     |   | 1-1/2 |   |   | Yes |                    |
| 3252     | EG-3-2     | Egg Sinker | PEG-332 Pull Pin | Production  | 3                          |             |     |     |     | 2   |   |       |   |   | Yes |                    |
| 3253     | EG-3-3     | Egg Sinker | PEG-332 Pull Pin | Production  | 3                          |             |     |     |     | 3   |   |       |   |   | Yes |                    |
| 3254     | EG-3-4     | Egg Sinker | PEG-332 Pull Pin | Production  | 3                          |             |     |     |     | 4   |   |       |   |   | Yes |                    |
| 3378     | EG-2-1012  | Egg Sinker | PEG-316 Pull Pin | Combination | 2                          |             |     | 10  |     |     |   | 12    |   |   | Yes |                    |
| 3380     | EG-2-1416  | Egg Sinker | PEG-316 Pull Pin | Combination | 2                          |             |     | 14  |     |     |   | 16    |   |   | Yes |                    |

PEG-332 Pull Pin Included With Molds under 10 oz. PEG-316 Pull Pin included with models over 10oz.

# FLAT BANK SINKER

The Flat Bank Sinker gives you an edge in thick cover and fast waters. The low profile stays the course when other sinker styles might be pushed or rolled.

| Item No. | Model No. | Type             | Model Group | Cavities | Sizes (oz.) |     |    |       |   | Size No. On Sinker |
|----------|-----------|------------------|-------------|----------|-------------|-----|----|-------|---|--------------------|
|          |           |                  |             |          | 1/2         | 3/4 | 1  | 1-1/2 | 2 |                    |
| 3379     | FLB-5-A   | Flat Bank Sinker | Assorted    | 5        | 1/2         | 3/4 | 1  | 1-1/2 | 2 | Yes                |
| 3356     | FLB-3-L   | Flat Bank Sinker | Assorted    | 3        | 3           |     | 4  |       | 5 | Yes                |
| 3357     | FLB-2-68  | Flat Bank Sinker | Combination | 2        |             | 6   |    | 8     |   | Yes                |
| 3358     | FLB-1-10  | Flat Bank Sinker | Single      | 1        |             |     | 10 |       |   | Yes                |
| 3359     | FLB-1-12  | Flat Bank Sinker | Single      | 1        |             |     | 12 |       |   | Yes                |



Flat sides resist rolling in moving waters

# NO SNAG SINKER

No one can promise “no snags,” but this design comes darn close. So thin and flat, it seems to glide through snags when retrieved so you can spend time enjoying the thrill of the catch.

| Item No. | Model No. | Type           | Model Group | Cavities | Sizes (oz.) |     |       |     |   | Size No. On Sinker |
|----------|-----------|----------------|-------------|----------|-------------|-----|-------|-----|---|--------------------|
|          |           |                |             |          | 3/8         | 1/2 | 5/8   | 7/8 | 1 |                    |
| 1123     | NS-5-A    | No Snag Sinker | Assorted    | 5        | 3/8         | 1/2 | 5/8   | 7/8 | 1 | Yes                |
| 1124     | NS-3-A    | No Snag Sinker | Assorted    | 3        | 1           |     | 1-1/2 |     | 2 | Yes                |
| 3343     | NS-2-43   | No Snag Sinker | Combination | 2        |             | 3   |       | 4   |   | Yes                |

Glides through the undercover



# NO ROLL SINKER (WITH WIRE EYES)

We’ve put a new twist on our popular No Roll Sinker with two new mold additions featuring molded in brass wire eyes. No more re-tying simply change out the weights and get back to fishing. Two new molds covering a range of sizes from 3oz up to 8oz.

| Item No. | Model No. | Type           | Insert            | Model Group | Cavities | Sizes (oz.) |   |   | Size No. On Sinker |
|----------|-----------|----------------|-------------------|-------------|----------|-------------|---|---|--------------------|
|          |           |                |                   |             |          | 3           | 4 | 5 |                    |
| 3529     | NR-2-68B  | No Roll Sinker | #2 Brass Wire Eye | Assorted    | 2        | 6           | 8 |   | Yes                |
| 3530     | NR-3-345B | No Roll Sinker | #1 Brass Wire Eye | Assorted    | 3        | 3           | 4 | 5 | Yes                |





# NO ROLL SINKER

The flat, low profile does not drift with the current, so your line stays in place. A CP332 Core Pin for each cavity is included. Core pins can be stripped away immediately in the mold or later after the extracted parts have cooled. Extra CP332 parts are available to increase molding speed.



Tear drop shape resists snags

| Item No. | Model No. | Type           | Insert         | Model Group | Cavities | Sizes (oz.) |       |     |     |   | Size No. On Sinkers |
|----------|-----------|----------------|----------------|-------------|----------|-------------|-------|-----|-----|---|---------------------|
|          |           |                |                |             |          | 1           | 1-1/2 | 2   | 3   |   |                     |
| 3244     | NR-4-A    | No Roll Sinker | CP332 Core Pin | Assorted    | 4        | 1           | 1-1/2 | 2   | 3   |   | Yes                 |
| 3385     | NR-3-345  | No Roll Sinker | CP332 Core Pin | Assorted    | 3        | 3           | 4     |     | 5   |   | Yes                 |
| 3386     | NR-2-68   | No Roll Sinker | CP332 Core Pin | Combination | 2        | 6           |       | 8   |     |   | Yes                 |
| 3527     | NR-5-SA   | No Roll Sinker | CP332 Core Pin | Combination | 5        | 3/8         | 1/2   | 5/8 | 3/4 | 1 | Yes                 |

# PENCIL SINKER

Write a few great "Fish Stories" with the versatile Pencil Sinker. Can be used as an in-line sinker with double brass wire eyes or as a bottom bumper-type sinker using only one eye.



Brass Wire Eye Page 70

| Item No. | Model No. | Type                       | Insert            | Model Group | Cavities | Sizes (oz.) Diameter and Length (inches) |             |           |
|----------|-----------|----------------------------|-------------------|-------------|----------|--|-------------|-----------|
|          |           |                            |                   |             |          | 1-1/4                                    | 1-3/4       | 2-1/2     |
| 1164     | P-3-AB    | Pencil Sinker w/ Brass Eye | #1 Brass Wire Eye | Assorted    | 3        | 3/8" x 1.9"                              | 3/8" x 2.6" | 3/8" x 4" |
|          |           |                            |                   |             |          |  |             |           |

# PINCH-ON SINKER

Pinch-On Sinkers are very easy to attach and remove from the line. The ears of the sinker are simply folded over the line, which gives the Pinch-On a streamlined shape when attached. It is important to use only soft lead when casting Pinch-On Sinkers to ensure that the ears will bend easily.



Pinch-On Sinker attaches easily to your line.

| Item No. | Model No. | Type            | Insert     | Model Group | Cavities | Sizes (oz.) |      |     |       |     |       | Size No. On Sinkers |     |
|----------|-----------|-----------------|------------|-------------|----------|-------------|------|-----|-------|-----|-------|---------------------|-----|
|          |           |                 |            |             |          | 1/16        | 3/32 | 1/8 | 3/16  | 3/8 | 1/2   |                     | 5/8 |
| 1126     | PO-7-A    | Pinch-On Sinker | B-40 Blade | Assorted    | 7        | 1/16        | 3/32 | 1/8 | 3/16  | 3/8 | 1/2   | 5/8                 | Yes |
| 3313     | PO-4-L    | Pinch On Sinker | B-40 Blade | Assorted    | 4        | 3/4         |      | 1   | 1-1/4 |     | 1-1/2 |                     | Yes |

B-40 Blade Included With Mold

# PYRAMID SINKER

The Pyramid Sinker excels in strong currents with any bottom condition. The pyramid tends to bury itself if the bottom is soft. On hard bottoms, the flat sides will prevent the pyramid from rolling with the current.



Pointed base can bury itself in soft terrain

Brass wire eye for less line abrasion See page 70

| Item No. | Model No.  | Type                        | Insert            | Model Group | Cavities | Sizes (oz.) |       |   |       |   | Size No. On Sinkers |
|----------|------------|-----------------------------|-------------------|-------------|----------|-------------|-------|---|-------|---|---------------------|
|          |            |                             |                   |             |          | 1           | 1-1/2 | 2 | 2-1/2 | 3 |                     |
| 3165     | PM-5-AB    | Pyramid Sinker w/ Brass Eye | #1 Brass Wire Eye | Assorted    | 5        | 1           | 1-1/2 | 2 | 2-1/2 | 3 | Yes                 |
| 3166     | PM-4-1B    | Pyramid Sinker w/ Brass Eye | #1 Brass Wire Eye | Production  | 4        |             |       | 1 |       |   | Yes                 |
| 3167     | PM-3-2B    | Pyramid Sinker w/ Brass Eye | #1 Brass Wire Eye | Production  | 3        |             |       | 2 |       |   | Yes                 |
| 3168     | PM-3-3B    | Pyramid Sinker w/ Brass Eye | #2 Brass Wire Eye | Production  | 3        |             |       | 3 |       |   | Yes                 |
| 3169     | PM-3-4B    | Pyramid Sinker w/ Brass Eye | #2 Brass Wire Eye | Production  | 3        |             |       | 4 |       |   | Yes                 |
| 3369     | PM-2-56B   | Pyramid Sinker w/ Brass Eye | #2 Brass Wire Eye | Combination | 2        |             | 5     |   | 6     |   | Yes                 |
| 3370     | PM-2-810B  | Pyramid Sinker w/ Brass Eye | #2 Brass Wire Eye | Combination | 2        |             | 8     |   | 10    |   | Yes                 |
| 3521     | PM-2-1214B | Pyramid Sinker w/ Brass Eye | #3 Brass Wire Eye | Combination | 2        |             | 12    |   | 14    |   | Yes                 |
| 3522     | PM-2-1618B | Pyramid Sinker w/ Brass Eye | #3 Brass Wire Eye | Combination | 2        |             | 16    |   | 18    |   | Yes                 |

# DOWNRIGGER BALL SINKER

Precision engineered, this 2-piece mold is designed to give you a straight running ball. You will need your bench vise to stabilize the mold as well as heavier casting equipment (p. 96). If you are looking to protect your boat finish and minimize the electrofield, try coating the balls with a multi-purpose rubber coating (e.g. Plasti Dip®) which can be found at your local hardware store.

| Item No. | Model No. | Type                   | Insert               | Model Group | Cavities | Sizes (lb.) | Size No. On Sinkers |
|----------|-----------|------------------------|----------------------|-------------|----------|-------------|---------------------|
| 3425     | DRB-1-8   | Downrigger Ball Sinker | Downrigger Wire Eyes | Single      | 1        | 8           | Yes                 |
| 3426     | DRB-1-10  | Downrigger Ball Sinker | Downrigger Wire Eyes | Single      | 1        | 10          | Yes                 |
| 3427     | DRB-1-12  | Downrigger Ball Sinker | Downrigger Wire Eyes | Single      | 1        | 12          | Yes                 |
| 3452     | DRB-1-15  | Downrigger Ball Sinker | Downrigger Wire Eyes | Single      | 1        | 15          | Yes                 |



2 Down Rigger wire eyes used See page 70



Special casting equipment. See page 96

# RIVER SINKER

No need to go with the flow. These large donut-shaped sinkers hold their own against the currents in rivers, tidal flats, coastal areas and surf. The low profile and raised outer edges of the River Sinker prevent the rolling or tumbling that you'd expect under these conditions.

| Item No. | Model No. | Type         | Insert            | Model Group | Cavities | Sizes (oz.) |       |     | Size No. On Sinkers |
|----------|-----------|--------------|-------------------|-------------|----------|-------------|-------|-----|---------------------|
| 3276     | RS-6-S2   | River Sinker | #1 Brass Wire Eye | Combination | 6        | 1           | 1-1/2 | Yes |                     |
| 3179     | RS-3-234  | River Sinker | #2 Brass Wire Eye | Assorted    | 3        | 2           | 3     | 4   | Yes                 |
| 3180     | RS-2-56   | River Sinker | #2 Brass Wire Eye | Combination | 2        | 5           | 6     | Yes |                     |
| 3181     | RS-2-810  | River Sinker | #2 Brass Wire Eye | Combination | 2        | 8           | 10    | Yes |                     |

Donut shape resists currents



# ROUND FLAT SINKER

A flat design stays put no matter what rushes by. Enhanced with a brass eye to reduce line abrasion and make it easy to add a snap or a snap swivel.

| Item No. | Model No. | Type                    | Insert            | Model Group | Cavities | Sizes (oz.) |       |       |     |     | Size No. On Sinkers |
|----------|-----------|-------------------------|-------------------|-------------|----------|-------------|-------|-------|-----|-----|---------------------|
| 3174     | RF-5-AB   | Round Flat w/ Brass eye | #1 Brass Wire Eye | Assorted    | 5        | 1/4         | 3/8   | 1/2   | 3/4 | 1   | Yes                 |
| 3175     | RF-4-LB   | Round Flat w/ Brass eye | #1 Brass Wire Eye | Assorted    | 4        | 1-1/4       | 1-1/2 | 1-3/4 | 2   | Yes |                     |

Round shape slips by the weeds

Brass wire eye for less line abrasion See page 70



# REMOVABLE SPLIT SHOT

This Split Shot has "teeth" so you can crimp the sinker on your line or pinch the "ears" to remove it. Use pure or soft lead to mold these bendable sinkers.

| Item No. | Model No. | Type                 | Insert | Model Group | Cavities                     | Sizes (oz.) Sizes (no.) |      |      |     |
|----------|-----------|----------------------|--------|-------------|------------------------------|-------------------------|------|------|-----|
| 3170     | RM-1438   | Removable Split Shot | None   | Combination | 15<br>(8 of 1/4, 7 of 3/8)   | 1/4                     | 3/8  |      |     |
|          |           |                      |        |             |                              | #2                      | #1   |      |     |
| 3171     | RM-1618   | Removable Split Shot | None   | Combination | 20<br>(11 of 1/16, 9 of 1/8) | 1/16                    | 1/8  |      |     |
|          |           |                      |        |             |                              | #7                      | #4   |      |     |
| 3172     | RM-20-S4  | Removable Split Shot | None   | Assorted    | 20<br>(5 each size)          | 1/32                    | 1/16 | 3/32 | 1/8 |
|          |           |                      |        |             |                              | #8                      | #7   | #5   | #4  |



pinch the "ears" to remove

# SPLIT SHOT

The round Split Shot is one of this country's most used sinkers because of the ease in which it can be attached to the line. That is, it's easy once you know the secret, which is to just grip the sinker with pliers from behind the split and squeeze the two ends of the slot in toward each other. The Split Shot will spread apart and release the line without damage.



| Item No. | Model No. | Type       | Insert     | Model Group | Cavities                     | Sizes (oz.) |     |
|----------|-----------|------------|------------|-------------|------------------------------|-------------|-----|
| 1127     | SS-20-M2  | Split Shot | B-40 Blade | Combination | 20<br>(11 of 1/16, 9 of 1/8) | 1/16        | 1/8 |
| 1128     | SS-15-L2  | Split Shot | B-40 Blade | Combination | 15<br>(8 of 1/4, 7 of 3/8)   | 1/4         | 3/8 |

B-40 Blade Included With Mold

# IN-LINE TROLLING SINKER

When you're on the trail of the school you marked, the In-Line Trolling Sinker's streamlined shape slips through the water with minimal resistance.



Optional Crane swivel helps prevent kinked lines  
See page 70

| Item No. | Model No.  | Type           | Required Insert   | Optional Insert             | Model Group | Cavities | Sizes (oz.) |     |    |       | Size No. On Sinkers |
|----------|------------|----------------|-------------------|-----------------------------|-------------|----------|-------------|-----|----|-------|---------------------|
| 3138     | INT-4-AB   | In-Line Sinker | #1 Brass Wire Eye | #7 Crane Swivel #1 B-Chain  | Assorted    | 4        | 1/2         | 3/4 | 1  | 1-1/2 | Yes                 |
| 3139     | INT-3-234B | In-Line Sinker | #1 Brass Wire Eye | #5 Crane Swivel #2 B-Chain  | Assorted    | 3        | 2           | 3   | 4  |       | Yes                 |
| 3334     | INT-345B   | In-Line Sinker | #2 Brass Wire Eye | #5 Crane Swivel #2 B-Chain  | Assorted    | 3        | 3           | 4   | 5  |       | Yes                 |
| 3140     | INT-2-68B  | In-Line Sinker | #2 Brass Wire Eye | 1/0 Crane Swivel #3 B-Chain | Combination | 2        | 6           |     | 8  |       | Yes                 |
| 3141     | INT-12B    | In-Line Sinker | #3 Brass Wire Eye | 1/0 Crane Swivel #3 B-Chain | Single      | 1        |             | 12  |    |       | Yes                 |
| 3142     | INT-16B    | In-Line Sinker | #3 Brass Wire Eye | 1/0 Crane Swivel #3 B-Chain | Single      | 1        |             | 16  |    |       | Yes                 |
| 3475     | INT-2-2024 | In-Line Sinker | #3 Brass Wire Eye | 1/0 Crane Swivel #3 B-Chain | Combination | 2        | 20          |     | 24 |       | Yes                 |
| 3476     | INT-1-32   | In-Line Sinker | #3 Brass Wire Eye | 1/0 Crane Swivel #3 B-Chain | Single      | 1        |             | 32  |    |       | Yes                 |
| 3477     | INT-1-48   | In-Line Sinker | #3 Brass Wire Eye | 1/0 Crane Swivel #3 B-Chain | Single      | 1        |             | 48  |    |       | Yes                 |
| 3478     | INT-1-64   | In-Line Sinker | #3 Brass Wire Eye | 1/0 Crane Swivel #3 B-Chain | Single      | 1        |             | 64  |    |       | Yes                 |
| 3488     | INT-10B    | In-Line Sinker | #2 Brass Wire Eye | 1/0 Crane Swivel #3 B-Chain | Single      | 1        |             | 10  |    |       | Yes                 |

# TROLLING SINKER

Successful trolling is all about line control. Crane swivels molded in at each end of this streamlined In-Line Trolling Sinker eliminate twisted or kinked lines.

Streamline shape improves overall line control



| Item No. | Model No. | Insert          | Model Group | Cavities | Sizes (oz.) |     |       |     |     | Size No. On Sinkers |
|----------|-----------|-----------------|-------------|----------|-------------|-----|-------|-----|-----|---------------------|
| 3149     | STR-5-A   | #7 Crane Swivel | Assorted    | 5        | 1/4         | 3/8 | 1/2   | 5/8 | 3/4 | Yes                 |
| 3150     | STR-4-MED | #7 Crane Swivel | Assorted    | 4        | 3/4         | 1   | 1-1/2 | 2   |     | Yes                 |

# KEEL TROLLING WEIGHT

Much like a keel on a boat's hull, we've added a keel to the B-Chain trolling sinker to further increase the sinker's stability. Requires two "B-Chain" swivels per sinker.

The keel adds stability for more control



| Item No. | Model No. | Type        | Insert     | Model Group | Cavities | Sizes (oz.) |     |     |   | Size No. On Sinkers |
|----------|-----------|-------------|------------|-------------|----------|-------------|-----|-----|---|---------------------|
| 3128     | KWC-4-A   | Keel Weight | #1 B-Chain | Assorted    | 4        | 3/8         | 1/2 | 5/8 | 1 | Yes                 |
| 3129     | KWC-2-MA  | Keel Weight | #2 B-Chain | Combination | 2        | 1-1/2       | 2   |     |   | Yes                 |

B-Chain Swivels  
See page 70



# WORM RIG SINKER

Get in where they feed! The Worm Rig Sinker is used in weed beds, where it prevents the plastic worm from snagging or tearing. This sliding sinker has a small-sized hole for use with monofilament line. Streamlined shape makes for easier retrieval.



**NOTE: Worm Rig Sinkers DO NOT have a hollow base.**

| Item No. | Model No. | Type            | Insert          | Model Group | Cavities            | Sizes (oz.) |     |      |     |      |      |      |     |     |  |
|----------|-----------|-----------------|-----------------|-------------|---------------------|-------------|-----|------|-----|------|------|------|-----|-----|--|
| 3222     | WR-9-A    | Worm Rig Sinker | PWR-16 Pull Pin | Assorted    | 9                   | 3/32        | 1/8 | 3/16 | 1/4 | 5/16 | 3/8  | 7/16 | 1/2 | 5/8 |  |
| 1140     | WR-10-M2  | Worm Rig Sinker | PWR-16 Pull Pin | Combination | 10<br>(5 each size) | 1/4         |     |      |     |      | 3/16 |      |     |     |  |

PWR-16 Pull Pin Included With Mold

# WALKING SINKER

Outwits the Walleye's legendary fickleness. Designed and balanced to pivot to its heel and let the line slide through the eye so smoothly that a fish will feel no unnatural sinker drag when it picks up the bait. Its shape is streamlined and rock and snag resistant. It will not roll in current like rounded slip sinkers.



Walking Sinker is designed to pivot to its heel

| Item No. | Model No. | Type           | Model Group | Cavities | Sizes (oz.) |     |      |     |     |     |     |   |       |       | Size No. On Sinkers |
|----------|-----------|----------------|-------------|----------|-------------|-----|------|-----|-----|-----|-----|---|-------|-------|---------------------|
| 1175     | WS-10-A   | Walking Sinker | Assorted    | 10       | 1/8         | 1/4 | 5/16 | 3/8 | 1/2 | 5/8 | 3/4 | 1 | 1-1/4 | 1-1/2 | Yes                 |
| 1177     | WS-9-14   | Walking Sinker | Production  | 9        | 1/4         |     |      |     |     |     |     |   |       |       | Yes                 |
| 1141     | WS-8-38   | Walking Sinker | Production  | 8        | 3/8         |     |      |     |     |     |     |   |       |       | Yes                 |
| 1178     | WS-8-12   | Walking Sinker | Production  | 8        | 1/2         |     |      |     |     |     |     |   |       |       | Yes                 |
| 1142     | WS-7-34   | Walking Sinker | Production  | 7        | 3/4         |     |      |     |     |     |     |   |       |       | Yes                 |

# DROP-SHOT SINKERS

Drop-shot rigging puts the weight at the end of the line. The hook and bait are tied above. The bait can be set at a determined distance above the bottom. The #7 Do-It® Line Grip Swivel has a V-shape in the eye to grip the line without tying. Drop-shot Sinkers can easily be replaced or adjusted. Should it become snagged, the sinker pulls off the line, but the hook remains. Because of its shape, the Round Drop-shot Sinker is ideal for soft bottoms and the Finesse Drop-shot is best for rocky bottoms or areas of high vegetation.



Do-It Line Grip Swivel See page 70

| Item No. | Model No. | Type                     | Insert                    | Model Group | Cavities           | Sizes (oz.) |      |     |      |     |     |     |     |    |    | Size No. On Sinkers |
|----------|-----------|--------------------------|---------------------------|-------------|--------------------|-------------|------|-----|------|-----|-----|-----|-----|----|----|---------------------|
| 3367     | DSS-8-M4  | Round Drop-Shot Sinker   | #7 Do-It Line Grip Swivel | Combination | 8<br>(2 each size) | 1/8         | 1/4  |     |      | 3/8 |     | 1/2 |     |    | No |                     |
| 3377     | FDS-8-A   | Finesse Drop-Shot Sinker | #7 Do-It Line Grip Swivel | Assorted    | 8                  | 1/32        | 1/16 | 1/8 | 3/16 | 1/4 | 3/8 | 1/2 | 5/8 | No |    |                     |
| 3442     | FDS-8-18  | Finesse Drop-Shot Sinker | #7 Do-It Line Grip Swivel | Production  | 8                  | 1/8         |      |     |      |     |     |     |     |    |    | No                  |
| 3443     | FDS-8-316 | Finesse Drop-Shot Sinker | #7 Do-It Line Grip Swivel | Production  | 8                  | 3/16        |      |     |      |     |     |     |     |    |    | No                  |
| 3444     | FDS-8-14  | Finesse Drop-Shot Sinker | #7 Do-It Line Grip Swivel | Production  | 8                  | 1/4         |      |     |      |     |     |     |     |    |    | No                  |
| 3445     | FDS-8-38  | Finesse Drop-Shot Sinker | #7 Do-It Line Grip Swivel | Production  | 8                  | 3/8         |      |     |      |     |     |     |     |    |    | No                  |

# TEARDROP DROP-SHOT WEIGHT

There's probably not a presentation out there more versatile than drop shottin' and the Teardrop Drop-Shot weight is just that, VERSATILE! The tapered head makes it extremely snag-resistant, not to mention aerodynamic allowing anglers to cast it a country mile. The large surface area at the bottom of the weight does a great job of maintaining bottom contact and making noise while fully exposed #7 Do-It line grip swivels reduce the threat of line twist with two points of rotation rather than one like most drop shot weights on the market. In all of your favorite sizes from 1/16th up to 1 ounce these weights come stamped with the weight right on the side of the weight itself for easy recognition. Drop a Drop-shot on the big one today with Teardrop Drop-Shot Weights from Do-It!



| Item No. | Model No. | Type                  | Insert                    | Model Group | Cavities | Sizes (oz.) |     |      |     |      |     |     |     |     |   |
|----------|-----------|-----------------------|---------------------------|-------------|----------|-------------|-----|------|-----|------|-----|-----|-----|-----|---|
| 3511     | TDF-10-A  | Finesse Drop-Teardrop | #7 Do-It Line Grip Swivel | Assorted    | 10       | 1/16        | 1/8 | 3/16 | 1/4 | 5/16 | 3/8 | 1/2 | 5/8 | 3/4 | 1 |

## SNAG WEIGHT

A weighted treble hook, or a Snag Weight, is used to retrieve objects from the bottom. Where legal, it is also used to catch fish by snagging. The weight directly on the hook provides good casting characteristics and holds your line in the water. Check local fishing regulations for legality.

Adds ballast when fishing for objects



Treble Hook Style 3551  
See page 55

| Item No. | Model No. | Type        | Insert                      | Model Group | Cavities | Size (oz.) |
|----------|-----------|-------------|-----------------------------|-------------|----------|------------|
| 1145     | 2/0 Snag  | Snag Weight | 2/0 Treble Hook Style 3551  | Production  | 4        | 1/2        |
| 1146     | 4/0 Snag  | Snag Weight | 4/0 Treble Hook Style 3551  | Production  | 3        | 1          |
| 1156     | 5/0 Snag  | Snag Weight | 5/0 Treble Hook Style 3551  | Production  | 3        | 1          |
| 1147     | 6/0 Snag  | Snag Weight | 6/0 Treble Hook Style 3551  | Production  | 3        | 1-1/4      |
| 1148     | 8/0 Snag  | Snag Weight | 8/0 Treble Hook Style 3551  | Production  | 2        | 1-1/2      |
| 1149     | 10/0 Snag | Snag Weight | 10/0 Treble Hook Style 3551 | Production  | 2        | 2-1/2      |

## SLING SHOT PELLET MOLDS

Make inexpensive ammo for your sling shot quickly and easily with these molds. Many shotgun reloaders use the smaller sizes as buckshot.



Sling Shot Pellet

| Item No. | Model No. | Type              | Model Group | Cavities                     | Size (diameter) |      |
|----------|-----------|-------------------|-------------|------------------------------|-----------------|------|
|          |           |                   |             |                              | Size (oz.)      |      |
| 1152     | BB-20-M2  | Sling Shot Pellet | Combination | 20<br>(11 of 1/10, 9 of 1/6) | .31"            | .38" |
|          |           |                   |             |                              | 1/10            | 1/6  |
| 1153     | BB-15-L2  | Sling Shot Pellet | Combination | 15<br>(8 of 1/4, 7 of 3/8)   | .44"            | .50" |
|          |           |                   |             |                              | 1/4             | 3/8  |

## KEEL-HOOK DECOY WEIGHT (J-STYLE)

This weight will save you time, eliminate decoy bag tangles and prevent decoy paint wear. It hooks to the decoy's keel and is easily removed even while wearing gloves on those cold, dark mornings. Decoys that are easy out + easy in = more time to hunt. Uses neoprene tubing.

Component attachments: 2 plastic O-rings; 3 -C style Hog Rings; 1 - 10" neoprene tubing.



| Item No. | Model No. | Type           | Group    | Cavities | Size (oz.) |     |
|----------|-----------|----------------|----------|----------|------------|-----|
| 3483     | JDA-3-468 | J-style weight | Assorted | 3        | 4          | 6 8 |

## KEEL WEIGHT TUBING

Tension straps to keep your lines tangle free.

| Item No. | Quantity |
|----------|----------|
| 5473     | 12 pack  |



#5473

## C-RING

| Item No. | Quantity |
|----------|----------|
| 5470     | 25 pack  |



#5470

## RUBBER TUBING

10 inch.

| Item No. | Quantity |
|----------|----------|
| 5471     | 12 pack  |

## PLASTIC RING

| Item No. | Quantity |
|----------|----------|
| 5472     | 25 pack  |



#5472



## STRAP DECOY ANCHOR - INGOT MOLD

This one-piece, three-cavity mold makes either strap type duck decoy anchors or lead ingots. There are two different levels of fill in each cavity. When making duck decoy anchors, use soft lead and fill the cavity only to the first (lower) level to make six ounce flexible strap anchors. Fill the mold up to the second (top) level to make lead ingots weighing up to sixteen ounces. A melter and a ladle with capacity to hold a minimum six ounces of lead are required. An electric Hot-Pot melter/ladle also works well. This mold is not intended to be used with bottom pour furnaces.



| Item No. | Cavities |
|----------|----------|
| 1885     | 3        |

## DECOY ANCHOR WEIGHTS

These anchor weights have been an old standard of duck hunters everywhere for years. The mushroom shape is best in soft bottom areas. The pyramid shape is favored in hard bottom locations where it has less tendency to roll with a current.

| Item No. | Model No. | Type                  | Model Group | Cavities | Size (oz.) |   |   | Size No. on Weights |
|----------|-----------|-----------------------|-------------|----------|------------|---|---|---------------------|
| 3309     | MDA-3-456 | Mushroom Decoy Anchor | Assorted    | 3        | 4          | 5 | 6 | Yes                 |
| 1198     | MDA-2-8   | Mushroom Decoy Anchor | Production  | 2        | 8          |   |   | Yes                 |
| 1199     | DAP-2-6   | Pyramid Decoy Anchor  | Production  | 2        | 6          |   |   | Yes                 |



Mushroom decoy anchor

Pyramid decoy anchor

## WRAP-AROUND DECOY ANCHOR

This is the answer to the problem of moving decoys between different depths of water. Line is wrapped around the body of the anchor. It can be easily set for any depth by tightly wrapping the line off around one of the ears. A weight of this type eliminates retying the line during a change in water depths.

| Item No. | Model No. | Type                     | Model Group | Cavities | Size (oz.) |
|----------|-----------|--------------------------|-------------|----------|------------|
| 1154     | DAW-1-7   | Wrap-Around Decoy Anchor | Single      | 1        | 7          |



## BLANK MOLDS FOR CUSTOM DESIGNS

After a great season of sports fishing, haven't we all thought we might have stumbled on a new solution for a jig, lure or sinker. Unfortunately the Do-It Corporation cannot produce custom work, so we created the Blank Mold. Your local tool and die or machine shop can create a custom cavity for the Blank Mold based on your design. We recommend getting a quote for this service before ordering your blank mold, as custom machine shop work can be pricier than you'd imagine.

| Item No. | Model No.     | Mold Face Dimensions      | Depth         |                 |
|----------|---------------|---------------------------|---------------|-----------------|
| 1155     | Blank Mold    | 4-5/8" long x 2-1/8" wide | 1-1/8" closed | 9/16" each side |
| 3416     | Blank Mold LF | 7" long x 3" wide         | 2" closed     | 1" each side    |





# MUSTAD BIG GAME FISH HOOKS

Forged to be tough enough for the big game. Seaworthy enough to handle the salt.



| Big Game Hook Sizes                 | 8/0   | 10/0  | 12/0  |
|-------------------------------------|-------|-------|-------|
| Mustad Style 34184<br>Tinned Finish | #4480 | NA    | NA    |
| Mustad Style 34081<br>Tinned Finish | NA    | #1860 | #1862 |

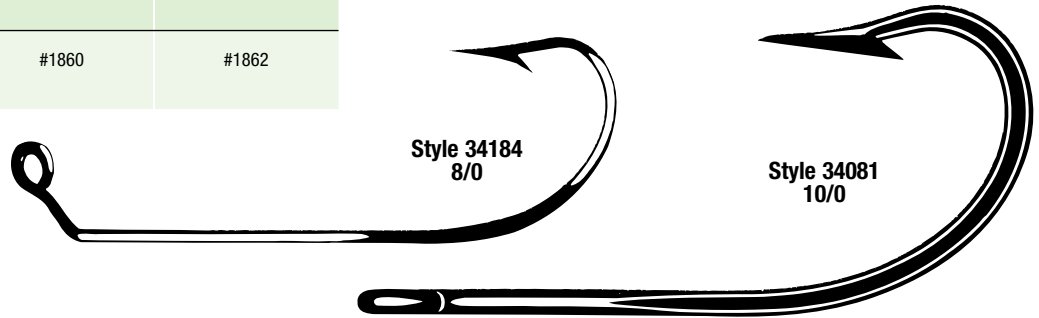

# MUSTAD STYLE 91715 HOOKS

Strong jig hooks with a 90-degree eye bend. Successful in freshwater, as well as saltwater.

| Big Game Hook Sizes                 | 7/0   | 8/0   | 9/0   |
|-------------------------------------|-------|-------|-------|
| Mustad Style 91715<br>Tinned Finish | #5017 | #5018 | #5019 |
| Mustad Style 91715<br>Tinned Finish | #5020 | #5021 | #5022 |



# MUSTAD CRIMPED HOOKS

Crimped with a sproat bend. Bends, doesn't break, under stress.



| Crimped Hook Sizes                                   | 4     | 6     | 8     | 10    |
|--|-------|-------|-------|-------|
| Style 33903<br>Mustad (sproat hook)<br>Bronze Finish | #4524 | #4526 | #4528 | #4530 |
| Style 33903<br>Mustad (sproat hook)<br>Bronze Finish | #4520 | #4521 | #4522 | #4523 |

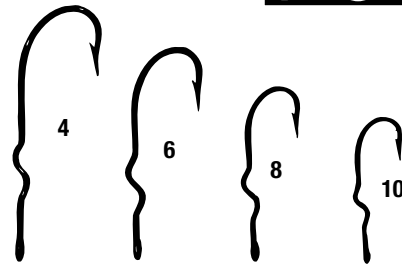

# MUSTAD STYLE 32608N NEEDLE POINT SPINNER JIG HOOKS

Premium round bend nickel-plated spinner jig hooks with "needle point" for easy penetration. A wide-bend spinner bait hook, chemically sharpened, non-tempering and long shank.

| Hook Sizes                    | 2/0   | 3/0   | 4/0   | 5/0   | 6/0   |
|-------------------------------|-------|-------|-------|-------|-------|
| Style 32608N<br>Nickel Finish | #4542 | #4543 | #4544 | #4545 | #4546 |
| Style 32608N<br>Nickel Finish | #4732 | #4733 | #4734 | #4735 | #4736 |

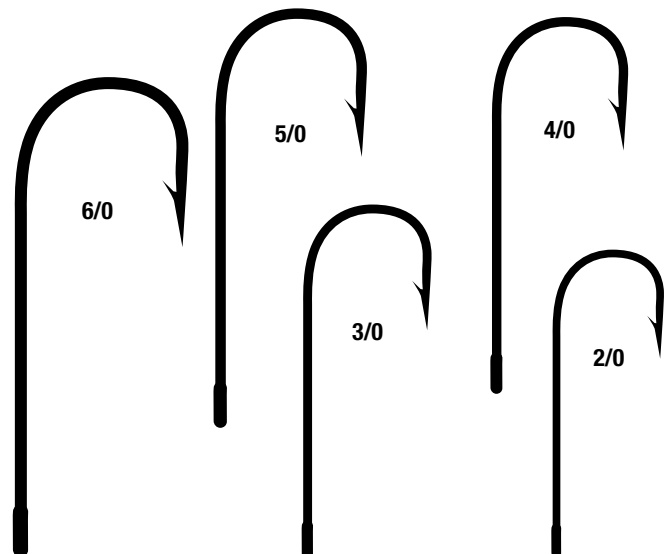

# MUSTAD 32798BLN HOOKS

A premium 60-degree jig hook with an extra-fine needle point, flat eye, chemically sharpened, plated in black nickel.

| Hook Sizes                     | 3/0   | 4/0   | 5/0   |
|--------------------------------|-------|-------|-------|
| Style 32798BLN<br>Black Nickel | #4533 | #4534 | #4535 |
| Style 32798BLN<br>Black Nickel | #4763 | #4764 | #4765 |

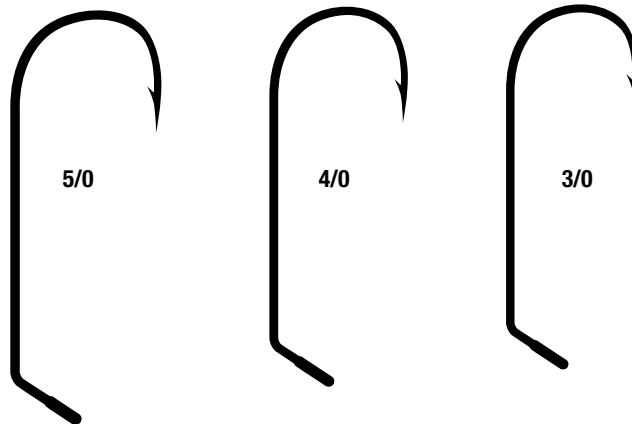

# MUSTAD 32786BLN HOOKS

Premium black nickel-plated extra-strong, chemically sharpened 60-degree wide-bend jig hook.



| Hook Sizes                     | 1/0   | 2/0   | 3/0   | 4/0   | 5/0   | 6/0   |
|--------------------------------|-------|-------|-------|-------|-------|-------|
| Style 32786BLN<br>Black Nickel | #4561 | #4562 | #4563 | #4564 | #4565 | #4566 |
| Style 32786BLN<br>Black Nickel | #4771 | #4772 | #4773 | #4774 | #4775 | #4776 |

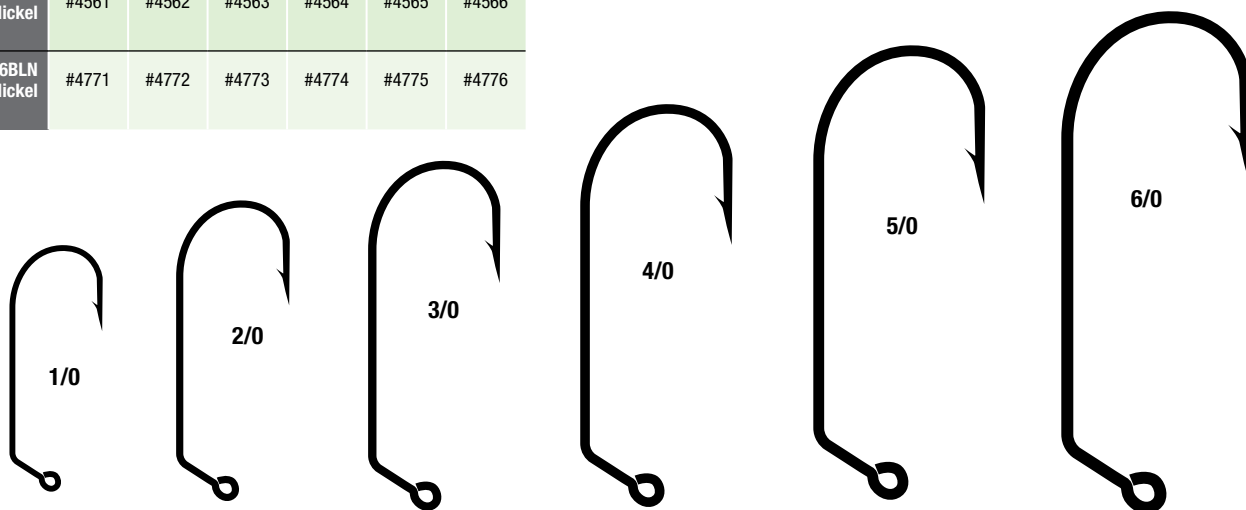

# MUSTAD 38104BLN HOOKS

Big-Mouth tube bait hook. Extra wide bend.

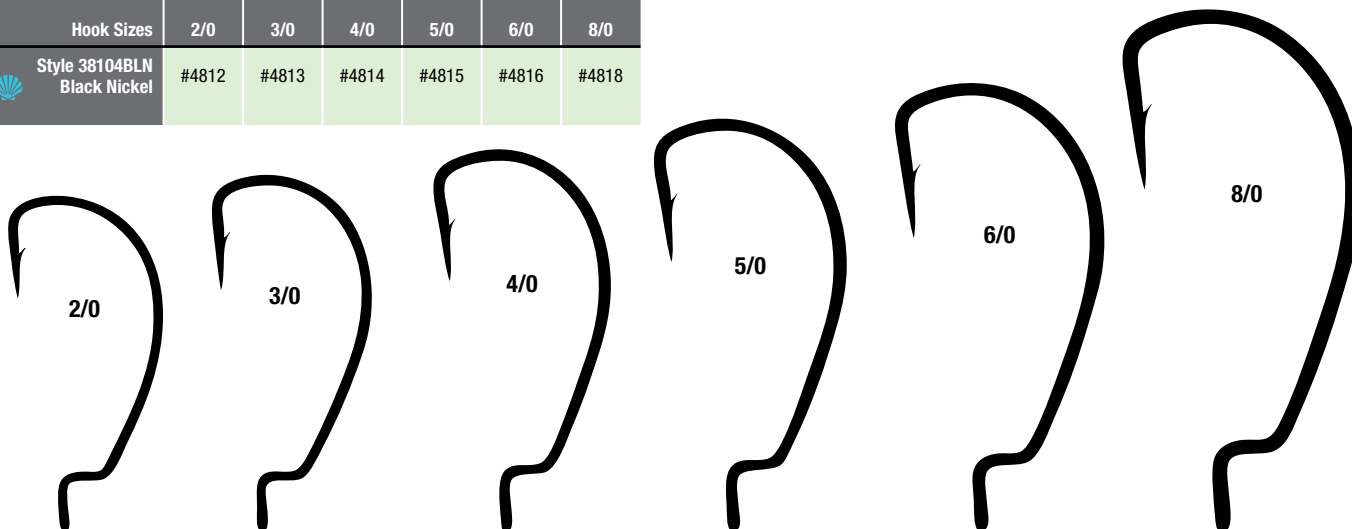

| Hook Sizes                     | 2/0   | 3/0   | 4/0   | 5/0   | 6/0   | 8/0   |
|--------------------------------|-------|-------|-------|-------|-------|-------|
| Style 38104BLN<br>Black Nickel | #4812 | #4813 | #4814 | #4815 | #4816 | #4818 |



## MUSTAD 32833BLN

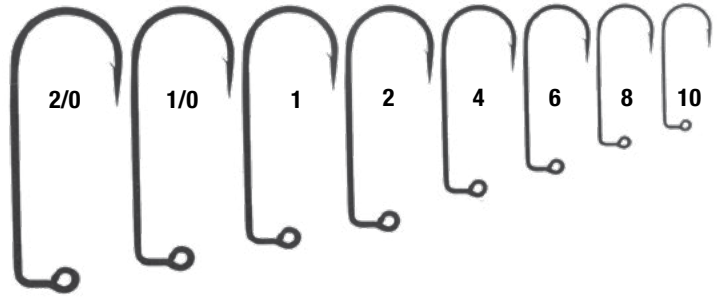

This stout, sturdy hook is an excellent choice when fishing small jigs and swim baits for larger fish, ideal for Steelhead, Salmon, Bass, Walleye and in-shore species such as spotted bass, Specks and Sea Trout.



| Hook Sizes   | 10    | 8     | 6     | 4     | 2     | 1     | 1/0   | 2/0   |
|--|-------|-------|-------|-------|-------|-------|-------|-------|
|  Style 32833BLN<br>Black Nickel | #5460 | #5458 | #5456 | #5454 | #5452 | #5451 | #5461 | #5462 |
|  Style 32833BLN<br>Black Nickel | #4793 | #4794 | #4795 | #4796 | #4797 | #4798 | #4799 | #4800 |

## MUSTAD 32746BN



Black nickel, light wire, 90° Aberdeen hook with a premium needle point.

| Hook Sizes  | 1     | 2     | 1/0   | 2/0   | 3/0   | 4/0   | 5/0   | 6/0   |
|---|-------|-------|-------|-------|-------|-------|-------|-------|
|  Style 32746BN<br>Black Nickel | #5137 | #5138 | #5139 | #5140 | #5141 | #5142 | #5143 | #5144 |
|  Style 32746BN<br>Black Nickel | #5145 | #5146 | #5147 | #5148 | #5149 | #5150 | #5151 | #5152 |



## MUSTAD 32796BN

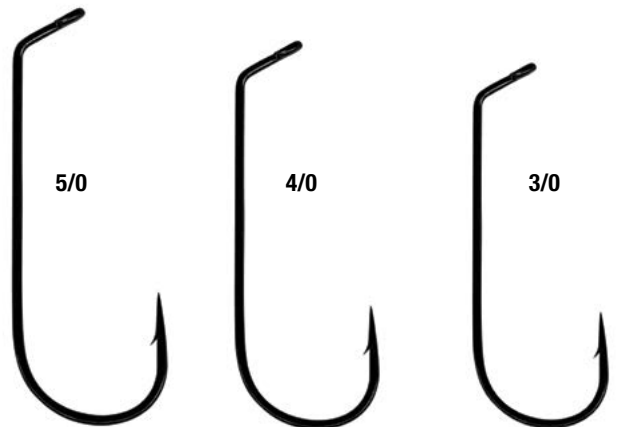

Black nickel, heavy wire, 60° bend, turned eye hook with premium needle point.

| Hook Sizes  | 3/0   | 4/0   | 5/0   |
|---|-------|-------|-------|
|  Style 32796BN<br>Black Nickel | #5153 | #5154 | #5155 |
|  Style 32796BN<br>Black Nickel | #5156 | #5157 | #5158 |



## MUSTAD 32886BLN

Premium 30 degree Grass / Flipping Hook. Ultra-Point.

| Hook Sizes   | 3/0   | 4/0   | 5/0   |
|--|-------|-------|-------|
|  Style 32886BLN<br>Black Nickel | #5263 | #5264 | #5265 |
|  Style 32886BLN<br>Black Nickel | #4790 | #4791 | #4792 |

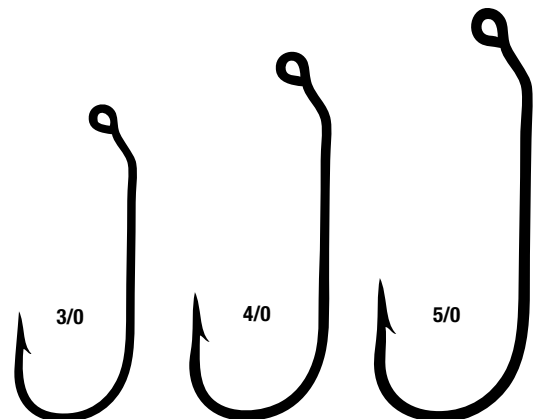



# MUSTAD 32889-BR

A 2X super fine wire crappie/panfish jig hook. Fits in most molds calling for Eagle Claw 570-575 molds but has much finer wire and will likely cause flash. Ideal for fishing sticks.

| Hook Sizes               | 2     | 4     |
|--------------------------|-------|-------|
| Style 32889-BR<br>Bronze | #5463 | #5465 |
| Style 32889-BR<br>Bronze | #5464 | #5466 |

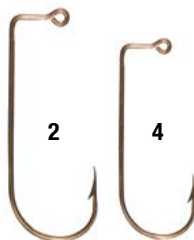

# MUSTAD 91768BLN HOOKS

Premium 28 degree black nickel hook with a modified wide gap bend. Extra strong, chemically sharpened needle point.

| Hook Sizes                     | 1/0   | 2/0   | 3/0   | 4/0   | 5/0   | 6/0   | 7/0   | 8/0   | 9/0   |
|--------------------------------|-------|-------|-------|-------|-------|-------|-------|-------|-------|
| Style 91768BLN<br>Black Nickel | #4691 | #4692 | #4693 | #4694 | #4695 | #4696 | #4697 | #4698 | #4699 |
| Style 91768BLN<br>Black Nickel | #4781 | #4782 | #4783 | #4784 | #4785 | #4786 | #4787 | #4788 | #4789 |

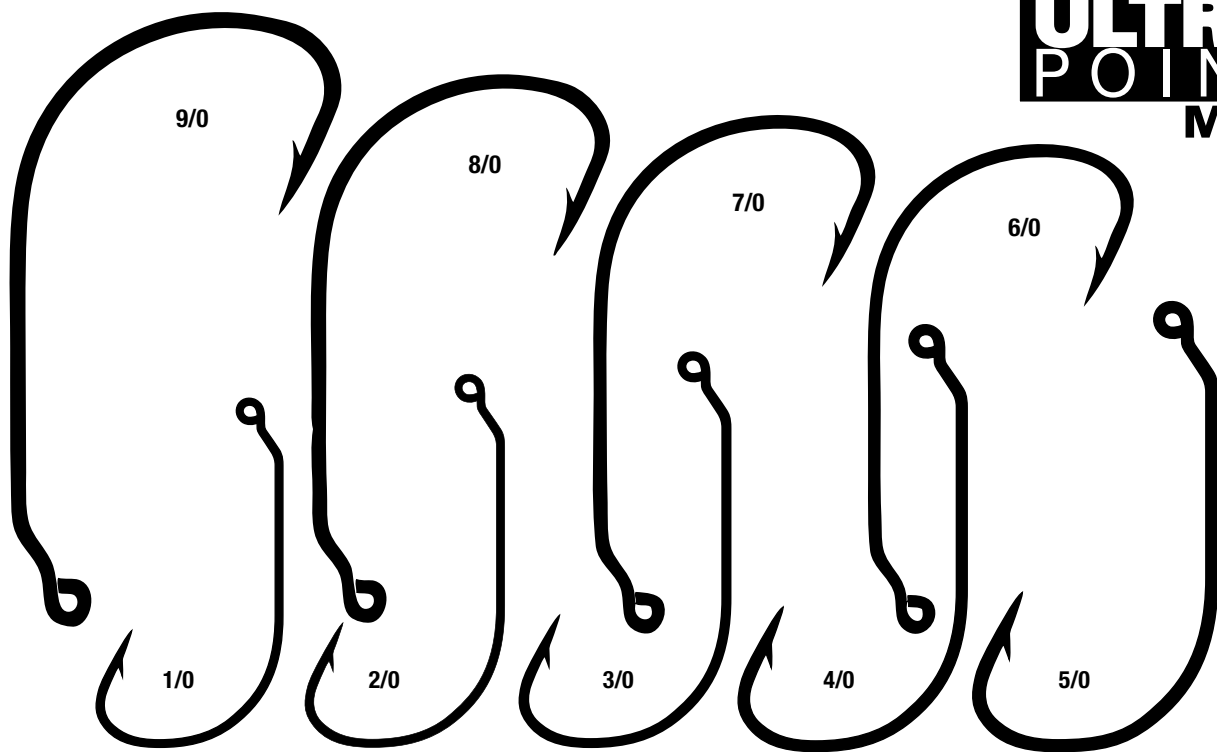

# MUSTAD 3260B SUPERIOR ABERDEEN

Aberdeen, Ringed, 24 Karat gold plated.

| Hook Sizes  | 12    | 10    | 8     | 6     | 4     | 2     | 1     |
|-------------|-------|-------|-------|-------|-------|-------|-------|
| Style 3260B | #5412 | #5410 | #5408 | #5406 | #5404 | #5402 | #5401 |
| Style 3260B | #4801 | #4802 | #4803 | #4804 | #4805 | #4806 | #4807 |

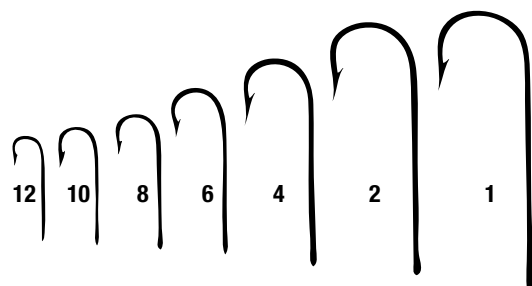

# MUSTAD 102 ULTRA NP FEATHER TREBLE

Opti-angle needle point, chemically sharpened, nor-tempered, short shank, round bend, ringed, hand-tied feathers. 2 pack.

| Hook Sizes                               | 2             | 4             | 6             |
|--|---------------|---------------|---------------|
| Style 102 RCH<br>Red, Chartreuse         | #5202<br>5.41 | #5204<br>5.41 | #5206<br>5.41 |
| Style 102 RR<br>Red                      | #5222<br>5.41 | #5224<br>5.41 | #5226<br>5.41 |
| Style 102 RW<br>Red, White               | #5232<br>5.41 | #5234<br>5.41 | #5236<br>5.41 |
| Style 102 RWCH<br>Red, White, Chartreuse | #5242<br>5.41 | #5244<br>5.41 | #5246<br>5.41 |



# MUSTAD 39951BLN DEMON CIRCLE

**Mustad®**

Black Nickel, Ultra-Point.

| Hook Sizes                                 | 6                        | 4                        | 2                        | 1                        | 1/0                      | 2/0                      | 3/0                      | 4/0                      | 5/0                      | 6/0                      | 7/0                     | 8/0                     |
|--|--------------------------|--------------------------|--------------------------|--------------------------|--------------------------|--------------------------|--------------------------|--------------------------|--------------------------|--------------------------|-------------------------|-------------------------|
| Style 39951BLN<br>Black Nickel<br>Quantity | #5306<br>4.12<br>10 pack | #5304<br>4.12<br>10 pack | #5302<br>4.12<br>10 pack | #5301<br>4.12<br>10 pack | #5331<br>4.12<br>10 pack | #5332<br>4.12<br>10 pack | #5333<br>4.12<br>10 pack | #5334<br>4.12<br>10 pack | #5335<br>4.12<br>10 pack | #5336<br>4.12<br>10 pack | #5337<br>4.33<br>6 pack | #5338<br>4.33<br>6 pack |

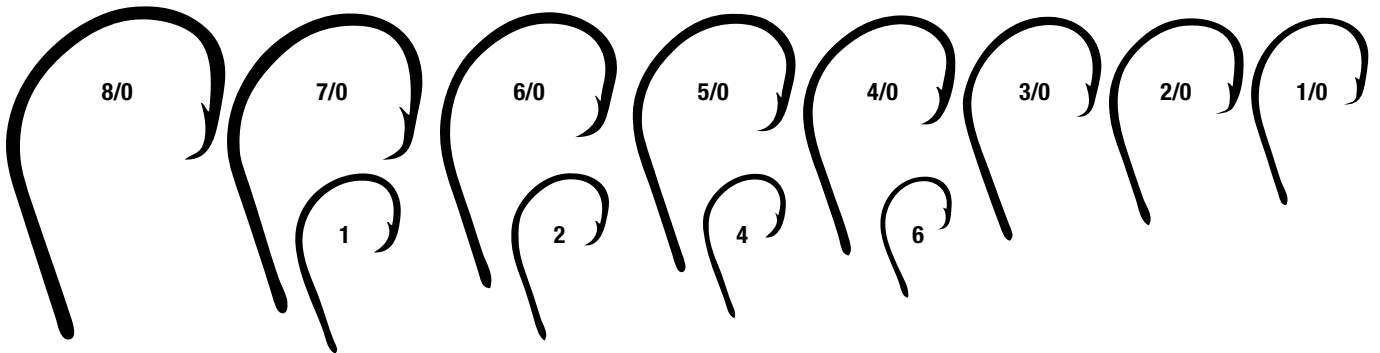

# MUSTAD 92604BLN OCTOPUS BEAK

Opti-angle needle point, chemically sharpened, nor-tempered, forged, fine wire, reversed, turned up tapered eye.

| Hook Sizes                     | 6     | 4     | 2     | 1     |
|--------------------------------|-------|-------|-------|-------|
| Style 92604BLN<br>Black Nickel | #5446 | #5444 | #5442 | #5441 |

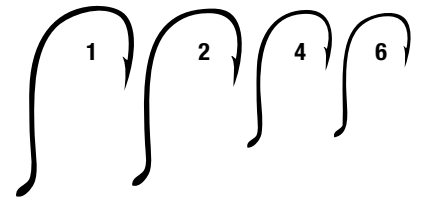

# MUSTAD CLIP-IN TREBLE HOOKS STYLE 7790X

Our Clip-In Treble Hooks feature an open, unsoldered leg so they can be snapped on or off most lures without tools or a split ring. Perfect for tailspinners, jigging spoons or vibrating lures. Now keep in mind, hooks with one unsoldered leg are more expensive to manufacture than the standard treble hooks, but you'll find the ease of installation well worth the extra pocket change.

| Clip-in Sizes                | 4     | 6     | 8     |
|------------------------------|-------|-------|-------|
| Style 7790X<br>Bronze Finish | #1784 | #1786 | #1788 |

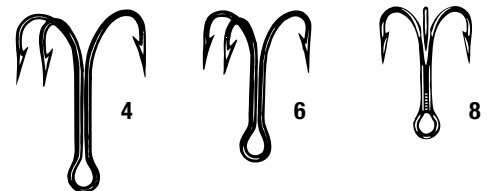

# MUSTAD STYLE 3551 TREBLE HOOKS

# Mustad®

Closed-eye treble hook with bronze finish.

| Clip-in Sizes               | 2     | 4     | 6     | 8     | 10    | 2/0   | 4/0   | 5/0   | 6/0   | 8/0   | 10/0  |
|-----------------------------|-------|-------|-------|-------|-------|-------|-------|-------|-------|-------|-------|
| Style 3551<br>Bronze Finish | #1722 | #1724 | #1726 | #1728 | #1729 | #1762 | #1764 | #1765 | #1766 | #1768 | #1769 |

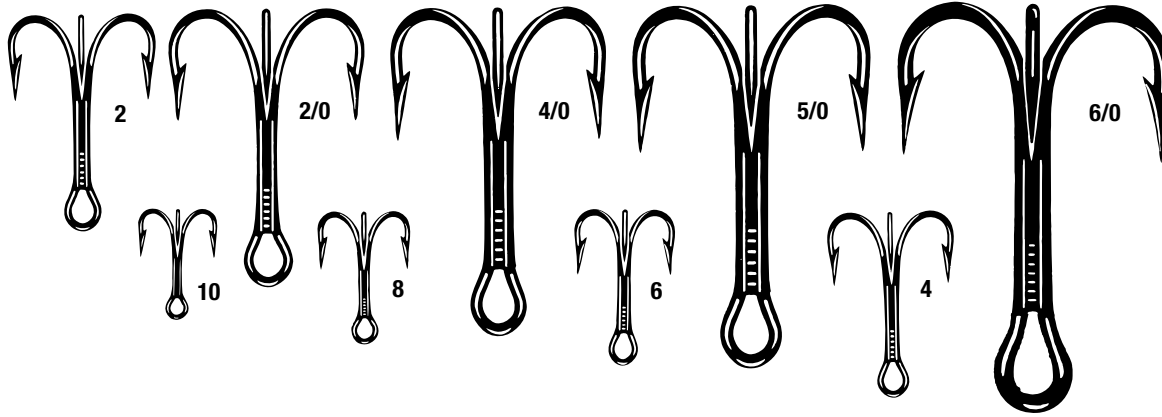

## MUSTAD TG58NP-BN

KVD Elite Triple Grip® treble, Opti-Angle Needle Point hook. Designed by Kevin VanDam with special wide bend for greater hook-ups. Premium Black Nickel finish.

| Hook Sizes                      | 6     | 4     | 2     | 1     | 1/0   |
|---------------------------------|-------|-------|-------|-------|-------|
| Style TG58NP-BN<br>Black Nickel | #5159 | #5160 | #5161 | #5162 | #5163 |
| Style TG58NP-BN<br>Black Nickel | #5164 | #5165 | #5166 | #5167 | #5168 |



## MUSTAD TG76NP-BN

Two extra short, extra strong KVD Elite Triple Grip®, Opti-angle Needle Point Hook. Designed by Kevin VanDam with special wide bend for great hook ups. Premium Black Nickel finish.

| Hook Sizes                      | 8     | 6     | 4     | 2     | 1     | 1/0   |
|---------------------------------|-------|-------|-------|-------|-------|-------|
| Style TG67NP-BN<br>Black Nickel | #5169 | #5170 | #5171 | #5172 | #5173 | #5174 |
| Style TG76NP-BN<br>Black Nickel | #5175 | #5176 | #5177 | #5178 | #5179 | #5180 |



## MUSTAD TR78NP

Premium needle point, extra strong, round bend treble with Ultra Point in Black Nickel finish.

| Hook Sizes                   | 8     | 6     | 4     | 2     |
|------------------------------|-------|-------|-------|-------|
| Style TR78NP<br>Black Nickel | #5181 | #5182 | #5183 | #5184 |
| Style TR78NP<br>Black Nickel | #5185 | #5186 | #5187 | #5188 |





# MUSTAD STYLE 32500



1X STRONG SKIP JACK BEND 90 DEGREE JIG HOOK, FITS MOLDS FOR 570-575 JIG HOOKS, BLACK NICKLE AND BRONZE FINISH.

| Aberdeen Sizes                  | 1     | 2     | 4     | 6     | 8     | 10 | 1/0   | 2/0   | 3/0 | 4/0 |
|---------------------------------|-------|-------|-------|-------|-------|----|-------|-------|-----|-----|
| Style 32500 Black Nickel Finish | #6000 | #6001 | #6002 | #6003 | #6004 | NA | #6005 | #6006 | NA  | NA  |
| Style 32500 Black Nickel Finish | #6007 | #6008 | #6009 | #6010 | #6011 | NA | #6012 | #6013 | NA  | NA  |
| Style 32500 Bronze Finish       | #6014 | #6015 | #6016 | #6017 | #6018 | NA | #6019 | #6020 | NA  | NA  |
| Style 32500 Bronze Finish       | #6021 | #6022 | #6023 | #6024 | #6025 | NA | #6026 | #6027 | NA  | NA  |

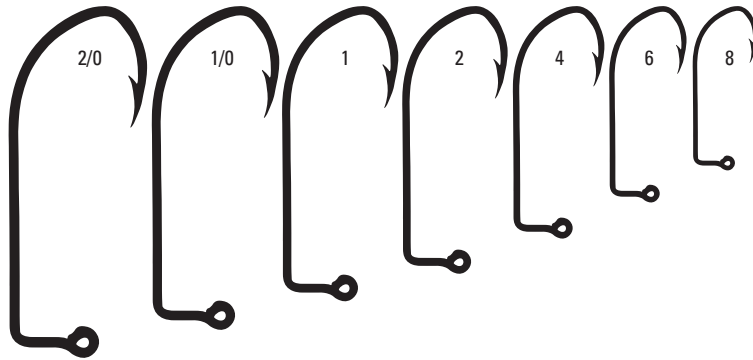

# MUSTAD STYLE 32570



1X STRONG ROUND BEND 90 DEGREE JIG HOOK, FITS MOLDS FOR 570-575 JIG HOOKS, BLONDE/GOLD, BRONZE AND RED FINISH.

| Aberdeen Sizes            | 1     | 2     | 4     | 6     | 8     | 10    | 1/0   | 2/0   | 3/0   | 4/0   |
|---------------------------|-------|-------|-------|-------|-------|-------|-------|-------|-------|-------|
| Style 32570 Blonde Finish | #6028 | #6029 | #6030 | #6031 | #6032 | #6033 | #6034 | #6035 | #6036 | #6037 |
| Style 32570 Blonde Finish | #6038 | #6039 | #6040 | #6041 | #6042 | #6043 | #6044 | #6045 | #6046 | #6047 |
| Style 32570 Bronze Finish | #6048 | #6049 | #6050 | #6051 | #6052 | #6053 | #6054 | #6055 | #6056 | #6057 |
| Style 32570 Bronze Finish | #6058 | #6059 | #6060 | #6061 | #6062 | #6063 | #6064 | #6065 | #6066 | #6067 |
| Style 32570 Red Finish    | #6068 | #6069 | #6070 | #6071 | #6072 | #6073 | #6074 | #6075 | #6076 | #6077 |
| Style 32570 Red Finish    | #6078 | #6079 | #6080 | #6081 | #6082 | #6083 | #6084 | #6085 | #6086 | #6087 |

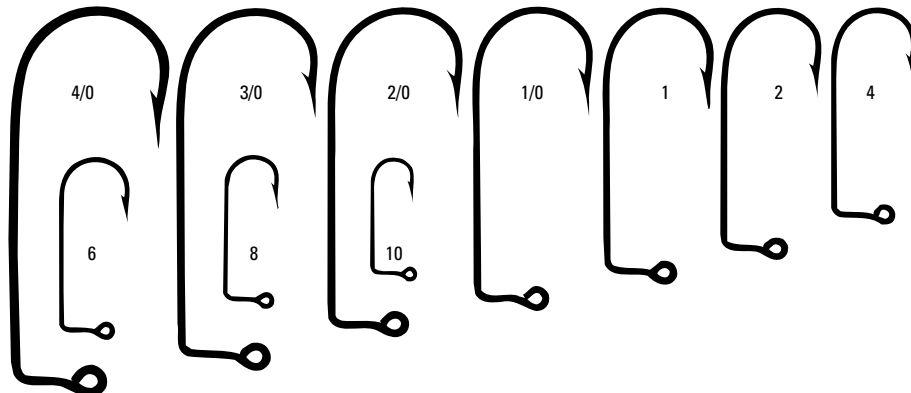

# EAGLE CLAW STYLES 575 AND 570 ABERDEEN JIG HOOKS

**EAGLE CLAW®**

The most popular freshwater jig hook. Made with flexible tempered wire, so if the hook becomes snagged, it will bend rather than break. Pictured near actual size.

| Aberdeen Sizes                   | 1     | 2     | 4     | 6     | 8     | 10    | 1/0   | 2/0   | 3/0   | 4/0   |
|----------------------------------|-------|-------|-------|-------|-------|-------|-------|-------|-------|-------|
| Style 575 Gold Finish            | #1301 | #1302 | #1304 | #1306 | #1308 | #1309 | #1310 | #1320 | #1330 | #1340 |
| Style 575M Gold Finish           | #4601 | #4602 | #4604 | #4606 | #4608 | #4609 | #4611 | #4612 | #4613 | NA    |
| Style 570 Bronze Finish          | #1351 | #1352 | #1354 | #1356 | #1358 | #1359 | #1361 | #1362 | #1363 | #1364 |
| Style 570M Bronze Finish         | #4621 | #4622 | #4624 | #4626 | #4628 | #4629 | #4631 | #4632 | #4633 | #4634 |
| Style 570R Freshwater Red Finish | #1401 | #1402 | #1404 | #1406 | #1408 | #1409 | #1410 | #1420 | #1430 | #1440 |

## ABERDEEN JIG HOOK SIZING

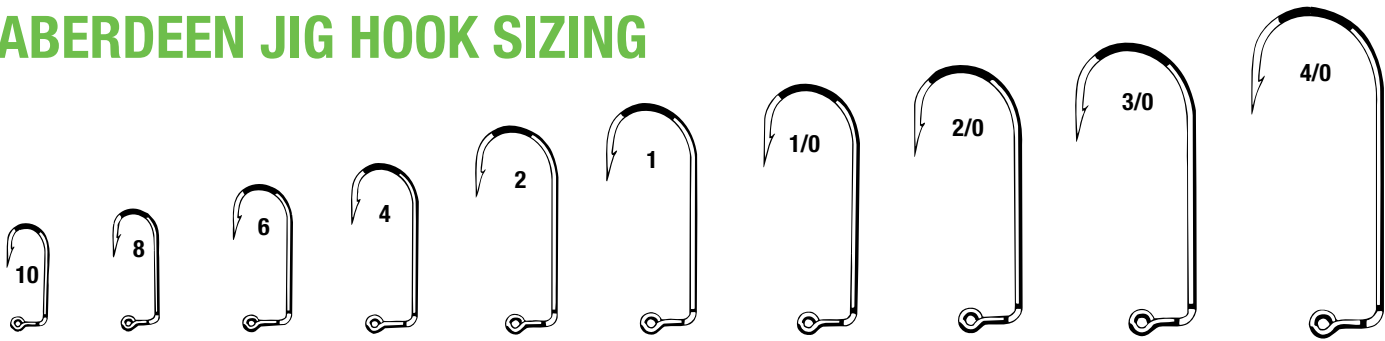

## TROKAR JIG HOOKS

Cold-Forged high carbon steel and a surgically sharpened, 3 sided hook point make this an extremely strong hook that penetrates with half the effort.

**LAZER TROKAR**

| Qty.    | Finish |
|---------|--------|
| 15 pack | Nickel |

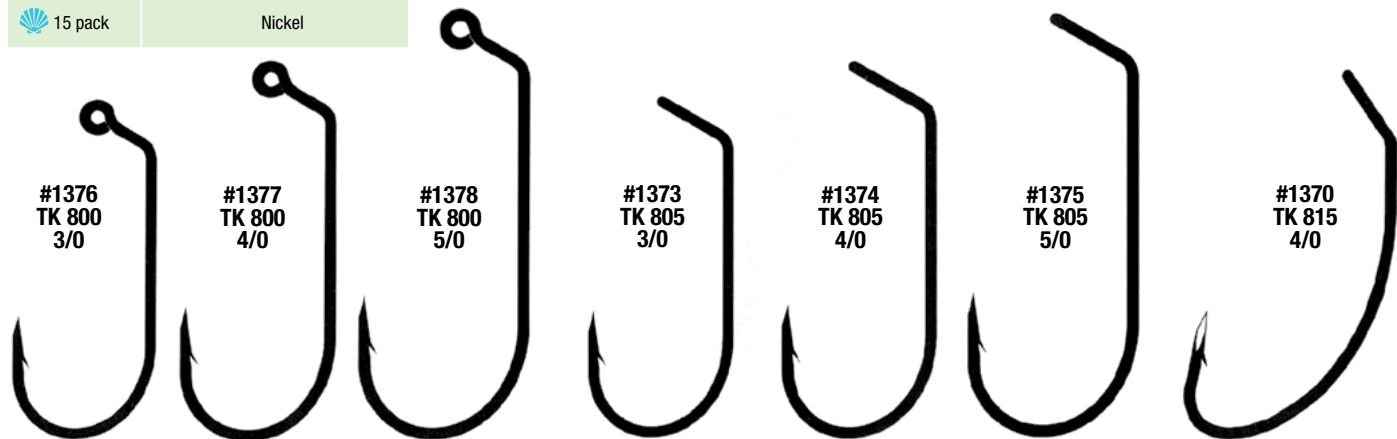

\*Federal Excise Tax of 10% will be added to all bulk (1,000pk) hooks ordered unless you provide a Form 637 exemption certificate.

# EAGLE CLAW STYLES 630 AND 635 90° O'SHAUGHNESSY JIG HOOKS



Extra long and strong tempered hooks for large fish. Style 635 hooks feature a SEAGUARD finish to resist saltwater corrosion. Pictured near actual size.

| O'Shaughnessy Sizes      | 1     | 2     | 4     | 6     | 1/0   | 2/0   | 3/0   | 4/0   | 5/0   | 6/0   | 7/0   |
|--------------------------|-------|-------|-------|-------|-------|-------|-------|-------|-------|-------|-------|
| Style 635 Tinned Finish  | #1601 | #1602 | NA    | NA    | #1610 | #1620 | #1630 | #1640 | #1650 | #1660 | #1670 |
| Style 635M Tinned Finish | #1681 | #1682 | NA    | NA    | #1691 | #1692 | #1693 | #1694 | #1695 | NA    | NA    |
| Style 630 Bronze Finish  | #1551 | #1552 | #1554 | #1556 | #1561 | #1562 | #1563 | #1564 | NA    | NA    | NA    |
| Style 630M Bronze Finish | NA    | NA    | NA    | NA    | #4291 | #4292 | #4293 | #4294 | NA    | NA    | NA    |

## O'SHAUGHNESSY JIG HOOK SIZING

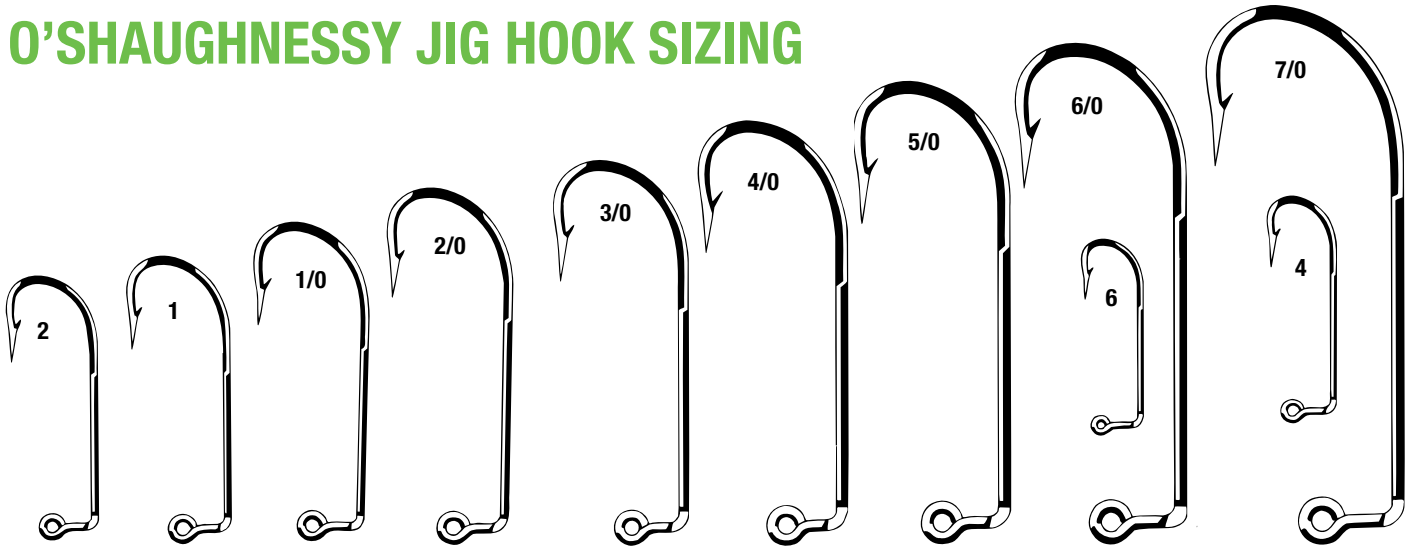

## SPECIALTY HOOKS

(Not Pictured Actual Size)

### 2190B HOOKS – SWM STYLE

| Sizes                | 4     | 1/0   | 2/0   |
|----------------------|-------|-------|-------|
| 2190B Bronze Finish  | #1574 | #1571 | #1572 |
| 2190BM Bronze Finish | #1584 | #1581 | #1582 |



### 571 HOOKS – SHORT SHANK

| Sizes                    | 1     | 1/0   |
|--------------------------|-------|-------|
| Style 571 Bronze Finish  | #4570 | #4571 |
| Style 571M Bronze Finish | #4575 | #4576 |

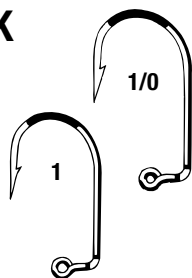

### L2221 HOOKS – 28° LAZER SHARP®

| Size                            | 5/0   |
|---------------------------------|-------|
| L2221 Hooks Bronze-Lazer Sharp  | #1592 |
| L2221M Hooks Bronze-Lazer Sharp | #1597 |

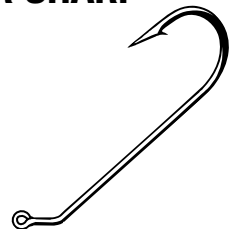



# EAGLE CLAW STYLE 730 WIDE THROAT 60° FLIPPING HOOKS

The 730 is a specialty hook designed for Bass fishing. It is a very strong, tempered hook with a wide throat to maximize hooking power, especially when fishing with pork rind. Pictured near actual size.

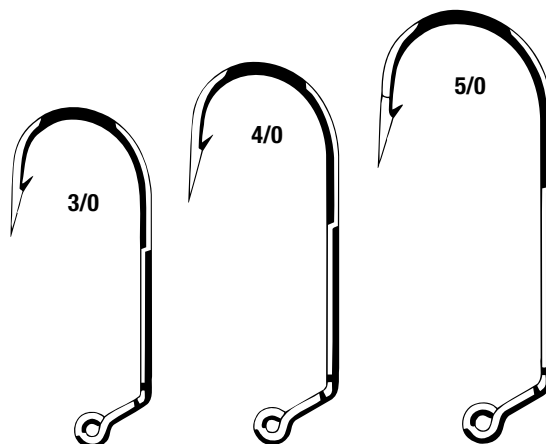

| Sizes                       | 3/0   | 4/0   | 5/0   |
|-----------------------------|-------|-------|-------|
| Style 730<br>Bronze Finish  | #4230 | #4240 | #4250 |
| Style 730M<br>Bronze Finish | #4273 | #4274 | #4275 |

# EAGLE CLAW STYLES 410 AND 413 60° O'SHAUGHNESSY JIG HOOKS

**EAGLE CLAW®**

Super strong forged jig hook. 410 and 413 hooks feature extra heavy wire and a 60-degree eye bend. SEAGUARD 413 style for saltwater fishing.

| XX STRONG-60°<br>Sizes      | 1     | 2     | 4     | 1/0   | 2/0   | 3/0   | 4/0   | 5/0   | 6/0   | 7/0   |
|-----------------------------|-------|-------|-------|-------|-------|-------|-------|-------|-------|-------|
| Style 410<br>Bronze Finish  | #4101 | #4102 | #4104 | #4110 | #4120 | #4130 | #4140 | #4150 | NA    | NA    |
| Style 410M<br>Bronze Finish | NA    | NA    | NA    | #4191 | #4192 | #4193 | #4194 | #4195 | NA    | NA    |
| Style 413<br>Tinned Finish  | #4301 | #4302 | #4304 | #4310 | #4320 | #4330 | #4340 | #4350 | #4360 | #4370 |
| Style 413M<br>Tinned Finish | NA    | NA    | #4390 | #4391 | #4392 | #4393 | #4394 | #4395 | NA    | NA    |

## 60° O'SHAUGHNESSY JIG HOOK SIZING

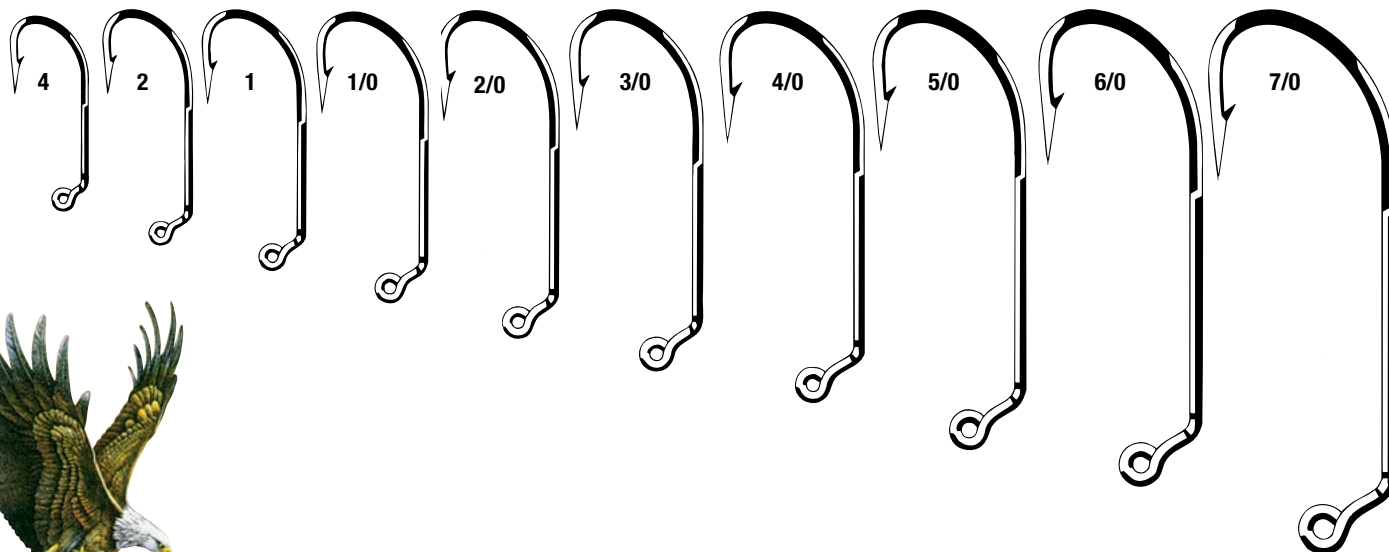

**EAGLE CLAW®**

Pictured near actual size.

# EAGLE CLAW SPINNER JIG HOOKS

O'Shaughnessy style hooks with small eyes for molding spinners.



| Spinner Jig Hook Sizes                | 1/0   | 2/0   | 3/0   | 4/0   | 5/0   |
|---------------------------------------|-------|-------|-------|-------|-------|
| Style 253 (Pictured) Nickel Finish    | #1810 | #1820 | #1830 | #1840 | #1850 |
| Style 253M Nickel Finish              | #4661 | #4662 | #4663 | #4664 | #4665 |
| Style L255 Nickel Finish Lazer Sharp  | NA    | #1802 | #1803 | #1804 | #1805 |
| Style L255M Nickel Finish Lazer Sharp | NA    | #4672 | #4673 | #4674 | #4675 |

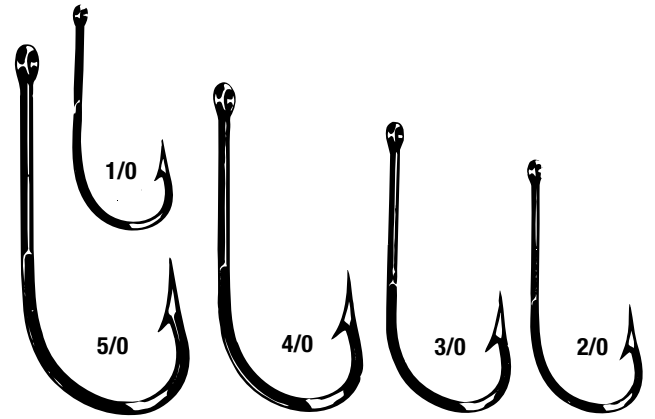

# EAGLE CLAW L786

Premium extra strong forged jig hook with 60° bend, lazer sharp, wide round bend and a Platinum Black finish. Fits molds that use a Mustad 32786 style hook.

| Hook Sizes            | 1/0   | 2/0   | 3/0   | 4/0   | 5/0   | 6/0   |
|-----------------------|-------|-------|-------|-------|-------|-------|
| Platinum Black Finish | #4948 | #4949 | #4950 | #4951 | #4952 | #4953 |
| Platinum Black Finish | #4954 | #4955 | #4956 | #4957 | #4958 | #4959 |

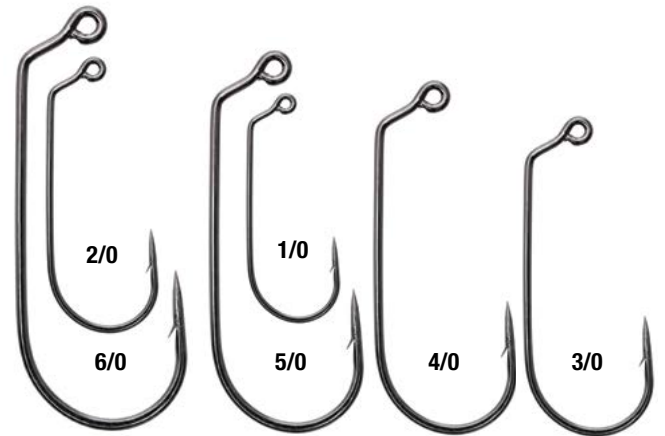

# EAGLE CLAW L279

Premium turned eyed, lazer sharp point with a Platinum Black finish. Fits molds that use a Mustad 32798 style hook.

| Hook Sizes            | 2/0   | 3/0   | 4/0   | 5/0   |
|-----------------------|-------|-------|-------|-------|
| Platinum Black Finish | #4960 | #4961 | #4962 | #4963 |
| Platinum Black Finish | #4964 | #4965 | #4966 | #4967 |

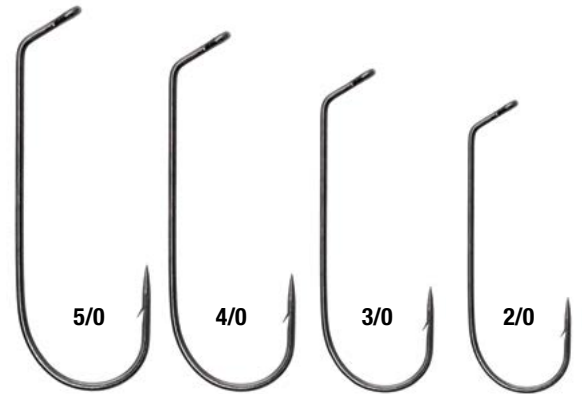

# STYLE 455 CRAPPIE SPINNER JIG HOOKS

Small, sharp and strong. Style 455 nickel-plated hooks are used in small spinner jig molds.

| Spinner Jig Hook Sizes  | 1     | 2     | 4     | 6     |
|-------------------------|-------|-------|-------|-------|
| Style 455 Nickel Finish | #4551 | #4552 | #4554 | #4556 |
| Style 455 Nickel Finish | #4741 | #4742 | #4744 | #4746 |

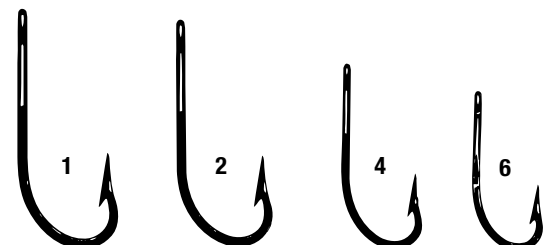

# GAMAKATSU 744 WORM HOOKS, SUPERLINE, OFFSET SHANK, EXTRA WIDE GAP (EWG)



Versatile hook for use with finesse baits, tubes, jerk baits and swim baits. NS Black.

| Hook Sizes | 2/0   | 3/0   | 4/0   | 5/0   | 6/0   |
|------------|-------|-------|-------|-------|-------|
| Item #     | #6322 | #6323 | #6324 | #6325 | #6326 |

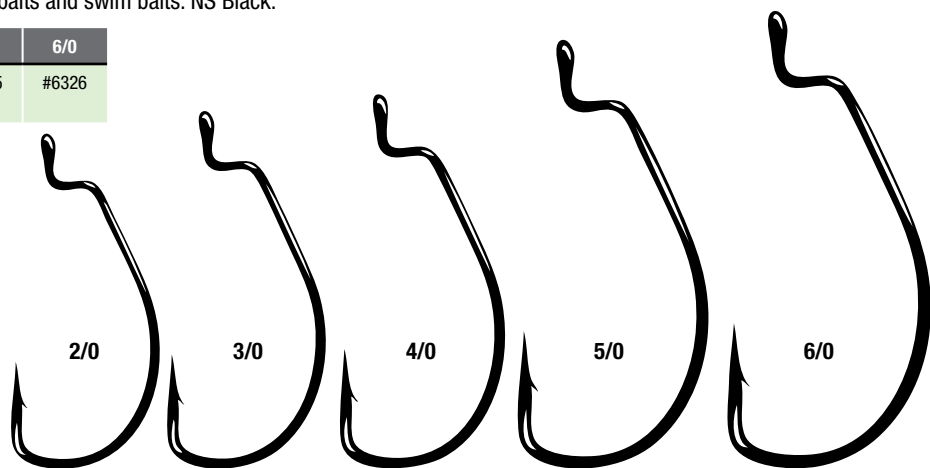

# GAMAKATSU 614 JIG HOOKS 60° FLAT EYE

Light wire hook great for finesse applications. Similar to Mustad 32798. May require slight mold modification. NS Black.

| Hook Sizes | 3/0   | 4/0   | 5/0   |
|------------|-------|-------|-------|
| Item #     | #6223 | #6224 | #6225 |
| Item #     | #6226 | #6227 | #6228 |

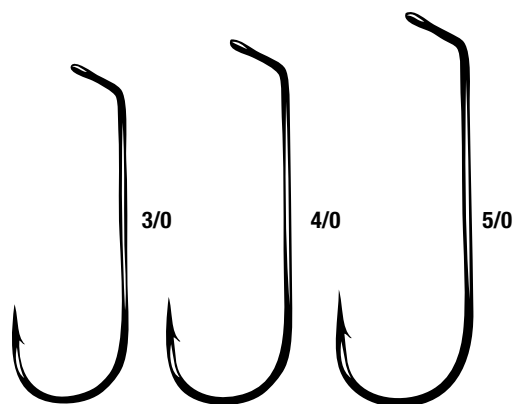

# GAMAKATSU 111 JIG HOOKS 90° O'SHAUGHNESSY

Bronze hook with a traditional O'Shaughnessy bend. Similar to Eagle Claw 630-635 hooks. May require slight mold modification.

| Hook Sizes | 3/0   | 4/0   | 5/0   |
|------------|-------|-------|-------|
| Item #     | #6233 | #6234 | #6235 |
| Item #     | #6238 | #6239 | #6240 |

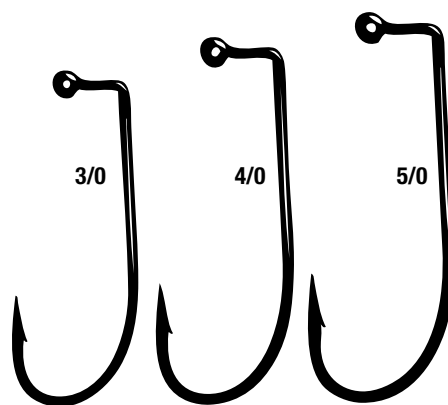

# GAMAKATSU 291 JIG HOOKS 60°

Bronze flipping and pitching hook with a round bend. Similar to Eagle Claw 730 hook. May require slight mold modification.

| Hook Sizes | 3/0   | 4/0   | 5/0   |
|------------|-------|-------|-------|
| Item #     | #6243 | #6244 | #6245 |
| Item #     | #6246 | #6247 | #6248 |

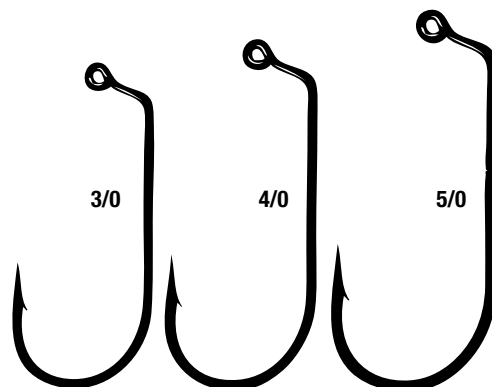



# GAMAKATSU SPINNER BAIT HOOKS

Premium Nickel Silver hooks to upgrade your baits.

| Hook Sizes | 3/0   | 4/0   | 5/0   |
|------------|-------|-------|-------|
| Item #     | #6403 | #6404 | #6405 |

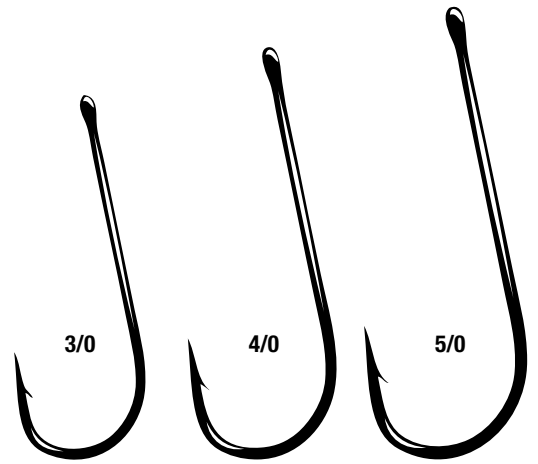

# GAMAKATSU TRAILER HOOKS

Extend the bite surface of your lure. Rubber molded eye keeps the hook secure.

| Hook Sizes           | 1/0   | 2/0   | 3/0   |
|----------------------|-------|-------|-------|
| Style SP<br>NS Black | #5620 | #5622 | #5623 |
| Style SP<br>Red      | #6411 | #6412 | #6413 |

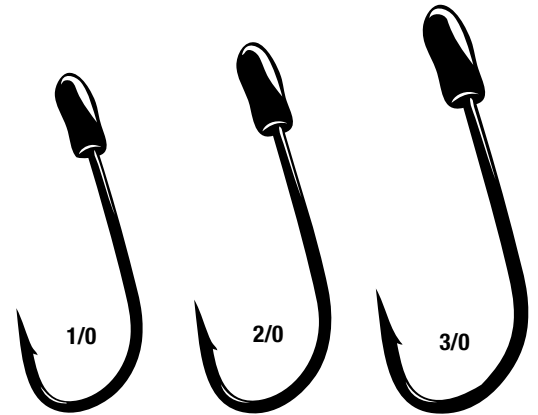

# GAMAKATSU G - STINGER NS BLACK

The ultimate utility hook. Easily attaches to any hook or lure. Great for the Do-it Flutter Jig, spinner baits, buzz baits, jerk baits and jigging spoons. Size 8 and 4 use 30 lb. braid and the larger sizes use 50 pound braid.

| Hook Sizes | 1     | 1/0   | 2/0   |
|------------|-------|-------|-------|
| Item #     | #6421 | #6410 | #6420 |
| Per 4 pack | 7.73  | 7.73  | 7.73  |

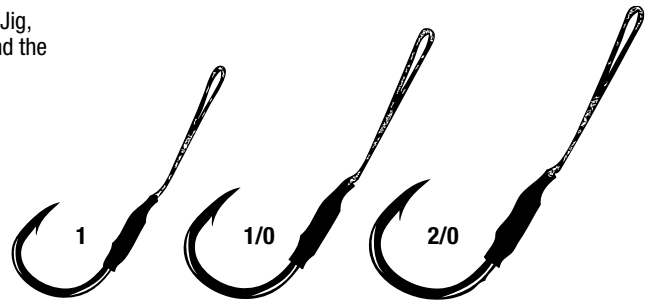

# GAMAKATSU ASSIST HOOK 510

No vertical jig should be fished without one. Super strong braided loop will easily attach to any jig. Tin finish.

| Hook Sizes | 1      | 1/0    | 2/0    | 3/0    | 4/0    |
|------------|--------|--------|--------|--------|--------|
| Item #     | #6430  | #6431  | #6432  | #6433  | #6434  |
| Quantity   | 4 pack | 4 pack | 3 pack | 3 pack | 2 pack |

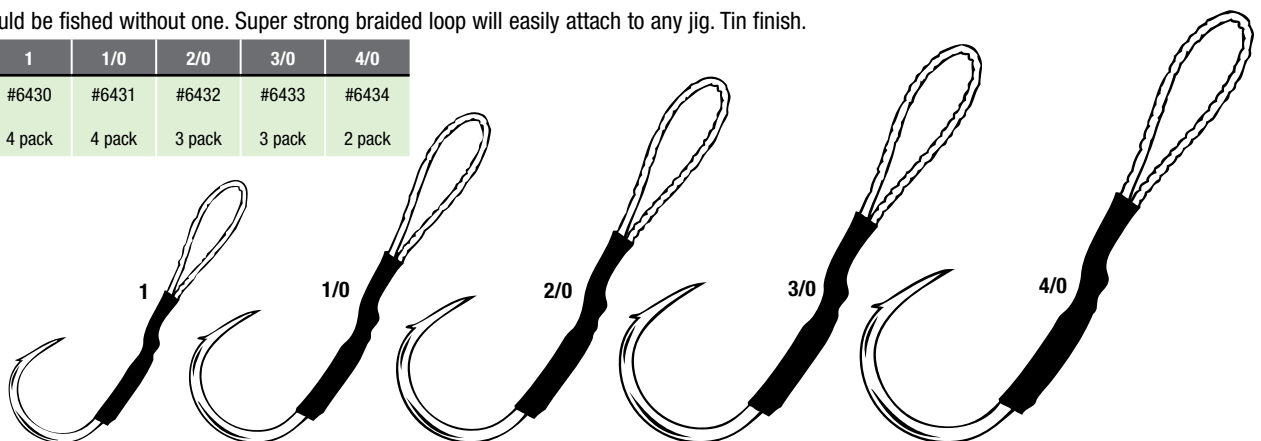

# GAMAKATSU OCTOPUS HOOKS

Gamakatsu's most versatile bait hook, known for its durability and strength. Available in Black Nickel silver or red. 25 pack

| Hook Sizes | 8     | 6     | 4     | 2     | 1     | 1/0   | 2/0   | 3/0   | 4/0   | 5/0   | 6/0   | 7/0   |
|------------|-------|-------|-------|-------|-------|-------|-------|-------|-------|-------|-------|-------|
| Black NS   | #6508 | #6506 | #6504 | #6502 | #6501 | #6510 | #6512 | #6513 | #6514 | #6515 | #6516 | #6517 |
| Red        | #6528 | #6526 | #6524 | #6522 | #6521 | #6531 | #6532 | #6533 | #6534 | #6535 | #6536 | #6537 |

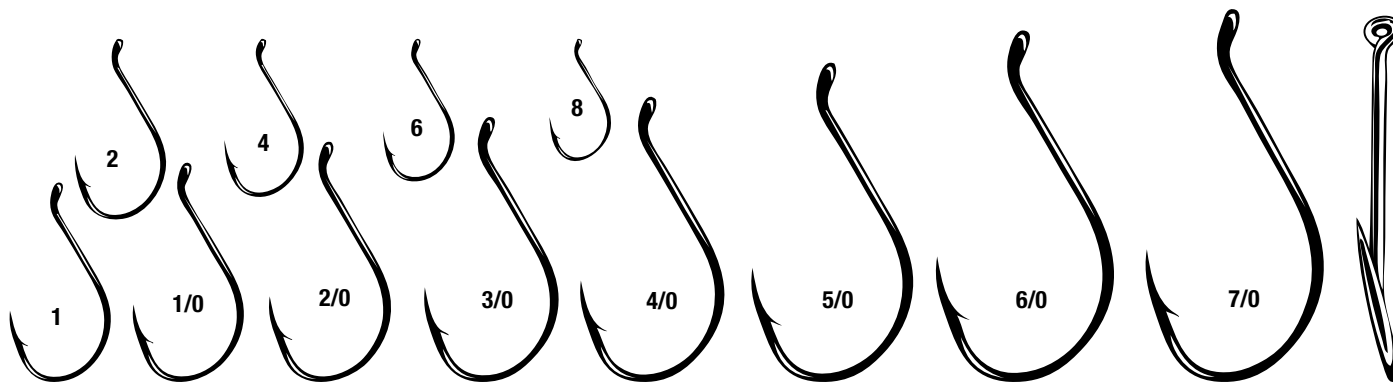

# GAMAKATSU OCTOPUS CIRCLE OFFSET POINT HOOKS

Specifically designed to set in the corner of a fish's mouth. Great for both fresh and saltwater bait fishermen. Available in Black Nickel silver.

| Hook Sizes | 1/0   | 2/0   | 3/0   | 4/0   | 5/0   | 6/0   | 7/0   | 8/0   |
|------------|-------|-------|-------|-------|-------|-------|-------|-------|
| Black NS   | #6541 | #6542 | #6543 | #6544 | #6545 | #6546 | #6547 | #6548 |

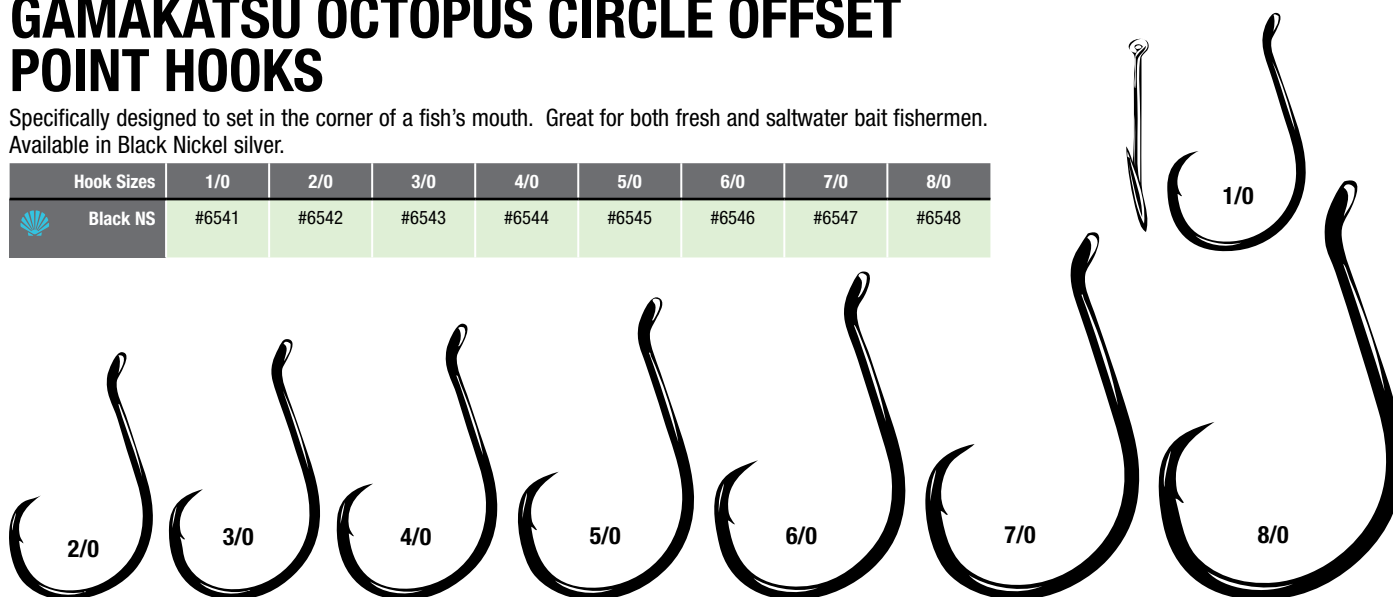

# GAMAKATSU V-EYE

Premium custom nickel silver hook produced in conjunction with Gary Yamamoto.

| Hook Sizes | 2/0   | 3/0   | 4/0   |
|------------|-------|-------|-------|
| Item #     | #4502 | #4503 | #4504 |

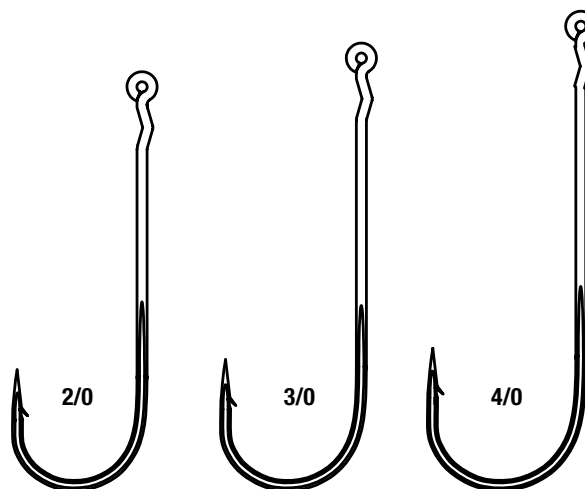

# GAMAKATSU 604 90° HEAVY WIRE HOOKS



Premium nickel silver black round bend heavy gauge wire jig hooks.

| Hook Sizes    | 2     | 1     | 1/0   | 2/0   | 3/0   | 4/0   | 5/0   | 6/0   | 7/0   | 8/0   |
|---------------|-------|-------|-------|-------|-------|-------|-------|-------|-------|-------|
| Nickel Silver | #4639 | #4640 | #4641 | #4642 | #4643 | #4644 | #4645 | #4646 | #4647 | #4648 |
| Nickel Silver | #4649 | #4650 | #4651 | #4652 | #4653 | #4654 | #4655 | #4656 | #4657 | #4658 |

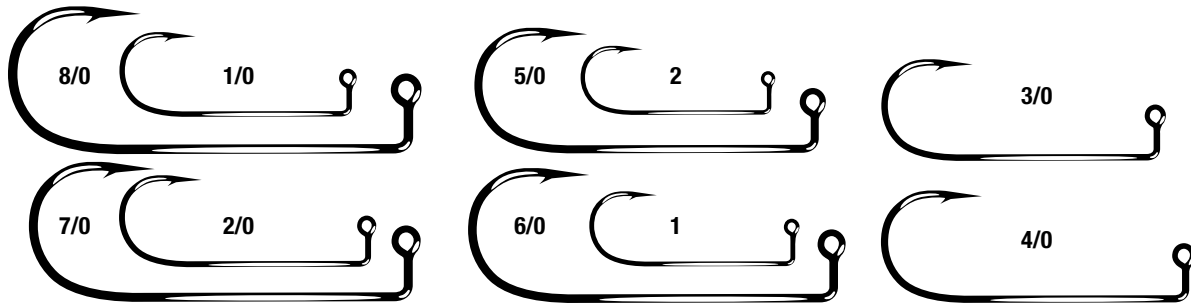

# GAMAKATSU TREBLE HOOKS BRONZE ROUND BEND

Premium nickel silver round bend heavy gauge wire jig hooks.

| Hook Sizes    | 8     | 6     | 4     | 2     | 1     | 1/0   | 2/0   |
|---------------|-------|-------|-------|-------|-------|-------|-------|
| Nickel Silver | #6628 | #6626 | #6624 | #6622 | #6621 | #6631 | #6632 |



# GAMAKATSU TREBLE HOOKS, SUPERLINE, 2X STRONG, ROUND BEND

Available in Black Nickel Silver or red.

| Hook Sizes  | 6       | 4       | 2      |
|-------------|---------|---------|--------|
| Red 2X      | #6606   | #6604   | #6602  |
| Quantity    | 10 pack | 9 pack  | 8 pack |
| Black NS 2X | #6616   | #6614   | #6612  |
| Quantity    | 12 pack | 11 pack | 9 pack |

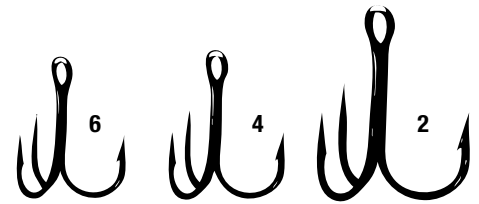

# GAMAKATSU TREBLE HOOKS, EXTRA WIDE GAP (EWG)

Available in Black Nickel silver or red.

| Hook Sizes | 6       | 4       | 2      |
|------------|---------|---------|--------|
| Red        | #6646   | #6644   | #6642  |
| Quantity   | 10 pack | 9 pack  | 8 pack |
| Black NS   | #6656   | #6654   | #6652  |
| Quantity   | 12 pack | 11 pack | 9 pack |





## OWNER 5313

90 Degree. 1x strong forged shank. Short shank and curved in point. Corrosion resistant black chrome finish. Versatile for molding fresh and saltwater jigs. Some mold modification may be needed.



| Hook Sizes | 1     | 1/0   | 2/0   | 3/0   |
|------------|-------|-------|-------|-------|
| Item #     | #4900 | #4901 | #4902 | #4903 |
| Item #     | #4875 | #4876 | #4877 | #4878 |

## OWNER 5317

60 Degree. 3x strong forged shank. Round bend round bend with Cutting Point®. Black Finish. Fits most Eagle Claw 730 molds.



| Hook Sizes | 3/0   | 4/0   | 5/0   |
|------------|-------|-------|-------|
| Item #     | #4917 | #4918 | #4919 |
| Item #     | #4869 | #4870 | #4871 |

## OWNER 5319

90 Degree. 3x strong forged shank. Round Bend. Super Needle Point. Corrosive Resistant Black Chrome Finish. Some mold modification likely.



| Hook Sizes | 3/0   | 5/0   | 7/0   |
|------------|-------|-------|-------|
| Item #     | #4920 | #4921 | #4922 |
| Item #     | #4887 | #4888 | #4889 |

## OWNER 5318

90 Degree. Lightwire shank. Round Bend with Super Needle Point. Black Finish. Minimal mold modification needed.

| Hook Sizes | 4     | 2     | 1     | 1/0   | 2/0   | 3/0   | 4/0   | 5/0   |
|------------|-------|-------|-------|-------|-------|-------|-------|-------|
| Item #     | #4904 | #4906 | #4907 | #4908 | #4909 | #4910 | #4911 | #4912 |
| Item #     | #4879 | #4880 | #4881 | #4882 | #4883 | #4884 | #4885 | #4886 |



## OWNER 5304

60 Degree. 2x strong shank. Wide Gap with Cutting Point®. Black Finish. Excellent Flip-n-Pitch hook. Some mold modification may be needed.



| Hook Sizes | 2/0   | 3/0   | 4/0   | 5/0   |
|------------|-------|-------|-------|-------|
| Item #     | #4913 | #4914 | #4915 | #4916 |
| Item #     | #4865 | #4866 | #4867 | #4868 |

## 5283 DANCING STINGER™

Used with any jig for increased hooking power. Super Strong Technora™ loops attach to a durable, flashy, titanium anti-chip saltwater Super Needle Point hook. 240 LB Leader Strength on all models. 2-3/4" length on 5/0 and 7/0. 3" length on 9/0 models. Gold finish.

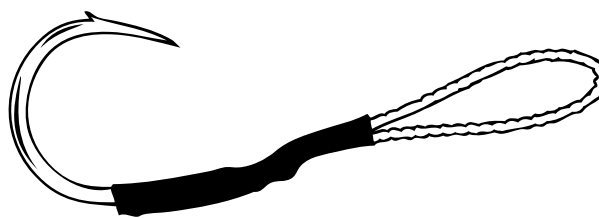

| Item No. | Size | Qty    |
|----------|------|--------|
| 4923     | 5/0  | 2 pack |
| 4924     | 7/0  | 2 pack |
| 4925     | 9/0  | 2 pack |



## DO-IT WACKY JIG HOOK

Fits 785 series molds. Premium black chrome, wide gap, forged hook with a 35° bend.

| Hook Sizes   | 2     | 6     |
|--------------|-------|-------|
| Black Chrome | #6215 | #6216 |



## 7147 ABERDEEN JIG 90°

Fits mold using Mustad 32746NP and Eagle Claw 570/575



| Hook Sizes   | 8     | 6     | 4     | 2     | 1     | 1/0   | 2/0   | 3/0   | 4/0   |
|--------------|-------|-------|-------|-------|-------|-------|-------|-------|-------|
| Black Nickel | #8103 | #8104 | #8105 | #8106 | #8107 | #8108 | #8109 | #8110 | #8111 |
| Black Nickel | #8114 | #8115 | #8116 | #8117 | #8118 | #8119 | #8120 | #8121 | #8122 |

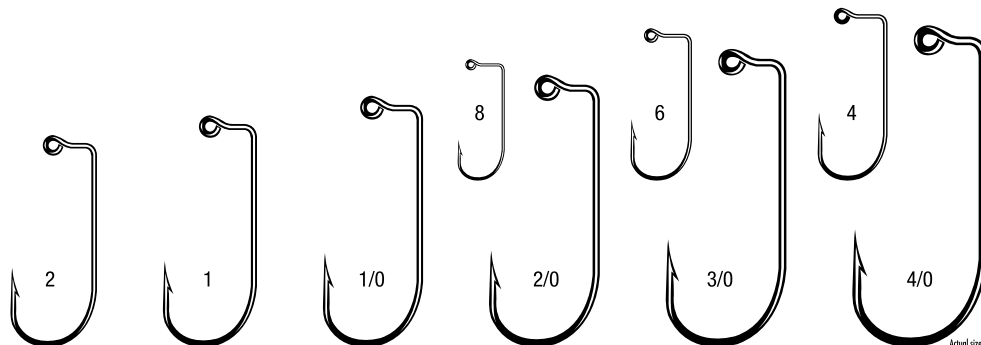

# 7161 ROUND JIG 60°

Fits mold using Mustad 32786

| Hook Sizes   | 6     | 4     | 2     | 1     | 1/0   | 2/0   | 3/0   | 4/0   | 5/0   | 6/0   | 7/0   | 8/0   |
|--------------|-------|-------|-------|-------|-------|-------|-------|-------|-------|-------|-------|-------|
| Black Nickel | #8000 | #8001 | #8002 | #8003 | #8004 | #8005 | #8006 | #8007 | #8008 | #8009 | #8010 | #8011 |
| Black Nickel | #8012 | #8013 | #8014 | #8015 | #8016 | #8017 | #8018 | #8019 | #8020 | #8021 | #8022 | #8023 |
| Tin Red      | #8048 | #8049 | #8050 | #8051 | #8052 | #8053 | #8054 | #8055 | #8056 | #8057 | #8058 | N/A   |
| Tin Red      | #8060 | #8061 | #8062 | #8063 | #8064 | #8065 | #8066 | #8067 | #8068 | #8069 | #8070 | N/A   |

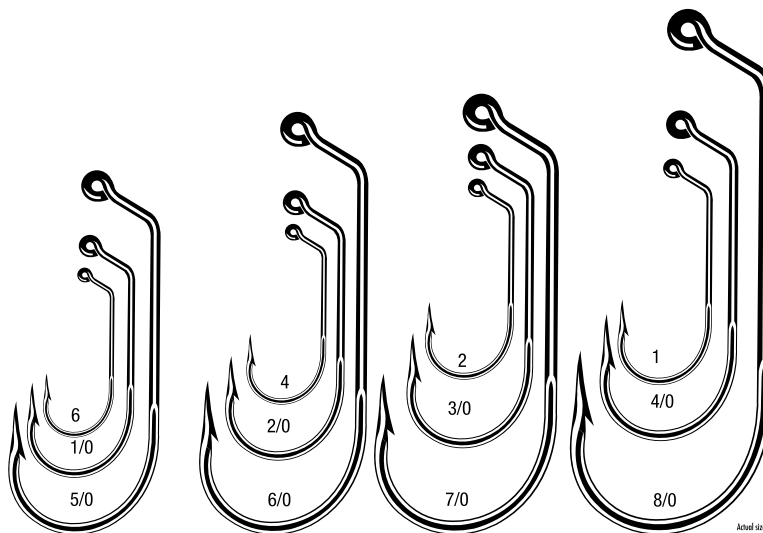

# 7247 ROUND BEND LONG SHANK JIG 90°

Fits mold using Gamakatsu model 604 and Eagle Claw 570/575

| Hook Sizes   | 1/0   | 2/0   | 3/0   | 4/0   |
|--------------|-------|-------|-------|-------|
| Black Nickel | #8123 | #8124 | #8125 | #8126 |
| Black Nickel | #8127 | #8128 | #8129 | #8130 |

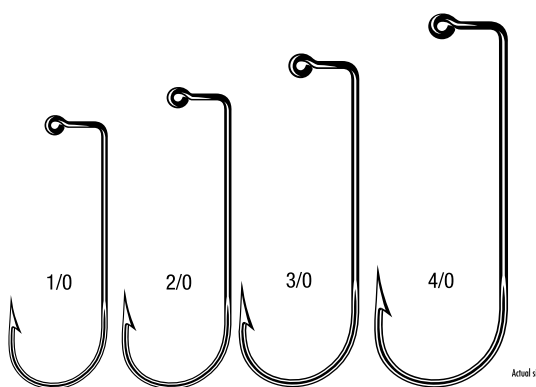

# 6215 ROTATED EYE 60° JIG

Fits mold using Mustad 32796 BLN and Eagle Claw Trokar 805

| Hook Sizes   | 4/0   | 5/0   |
|--------------|-------|-------|
| Black Nickel | #8132 | #8133 |
| Black Nickel | #8135 | #8136 |
| Tin Red      | #8138 | #8139 |
| Tin Red      | #8141 | #8142 |

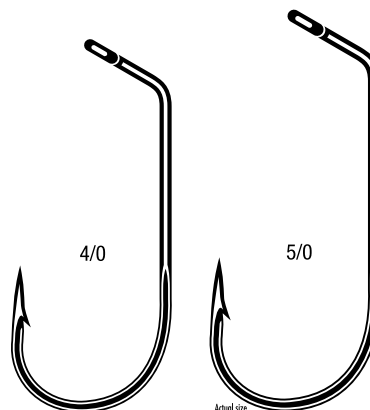



# 9147 ABERDEEN JIG 90°

Fits mold using Mustad 32746, 32755, and Eagle Claw 570/575



| Hook Sizes   | 10    | 8     | 6     | 4     | 2     | 1     | 1/0   | 2/0   | 3/0   | 4/0   |
|--------------|-------|-------|-------|-------|-------|-------|-------|-------|-------|-------|
| Black Nickel | #7903 | #7904 | #7905 | #7906 | #7907 | #7908 | #7909 | #7910 | #7911 | #7912 |
| Black Nickel | #7914 | #7915 | #7916 | #7917 | #7918 | #7919 | #7920 | #7921 | #7922 | #7923 |
| Bronze       | #7925 | #7926 | #7927 | #7928 | #7929 | #7930 | #7931 | #7932 | #7933 | #7944 |
| Bronze       | #7946 | #7947 | #7948 | #7949 | #7950 | #7951 | #7952 | #7953 | #7954 | #7955 |
| Gold         | #7957 | #7958 | #7959 | #7960 | #7961 | #7962 | #7963 | #7964 | #7965 | #7966 |
| Gold         | #7968 | #7969 | #7970 | #7971 | #7972 | #7973 | #7974 | #7975 | #7976 | #7977 |

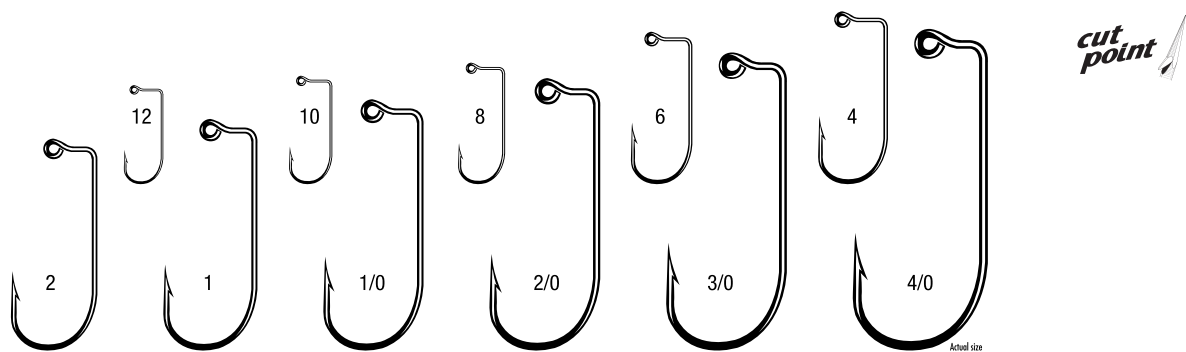

# 7218 ROUND LONG SHANK JIG 60° - ROTATED EYE

Fits mold using Mustad 32798 BLN  
5/0 perfectly fits molds using Gamakatsu 614

| Hook Sizes   | 2/0   | 3/0   | 4/0   | 5/0   |
|--------------|-------|-------|-------|-------|
| Black Nickel | #8072 | #8073 | #8074 | #8075 |
| Black Nickel | #8076 | #8077 | #8078 | #8079 |

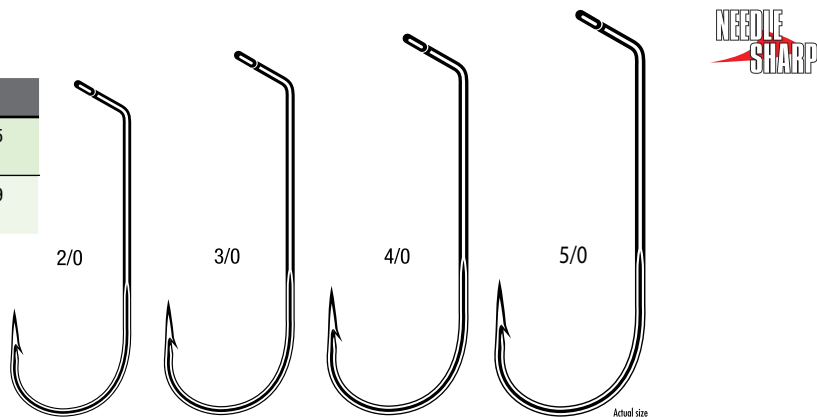

# 7216 ROUND BEND GRASS-FLIPPIN 30° JIG

Fits molds using Mustad 32886

| Hook Sizes   | 3/0   | 4/0   | 5/0   |
|--------------|-------|-------|-------|
| Black Nickel | #8080 | #8081 | #8082 |
| Black Nickel | #8083 | #8084 | #8085 |

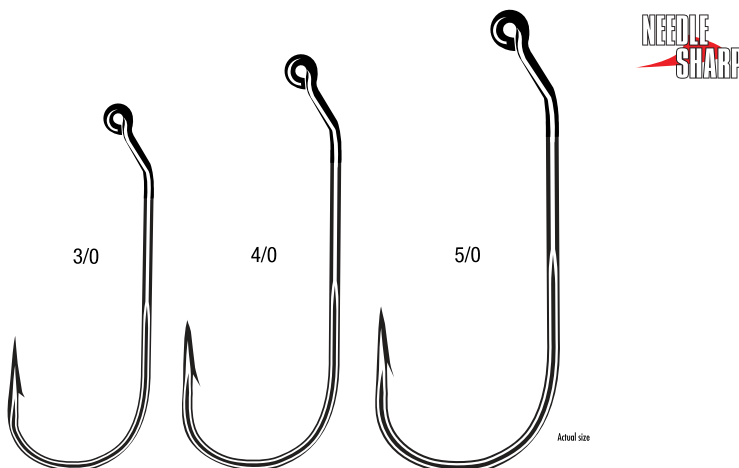

# 7329 WIDE GAP JIG 28°

Fits in molds using Mustad 91768

| Hook Sizes   | 1/0   | 2/0   | 3/0   | 4/0   | 5/0   |
|--------------|-------|-------|-------|-------|-------|
| Black Nickel | #8086 | #8088 | #8089 | #8090 | #8091 |
| Black Nickel | #8092 | #8093 | #8094 | #8095 | #8096 |

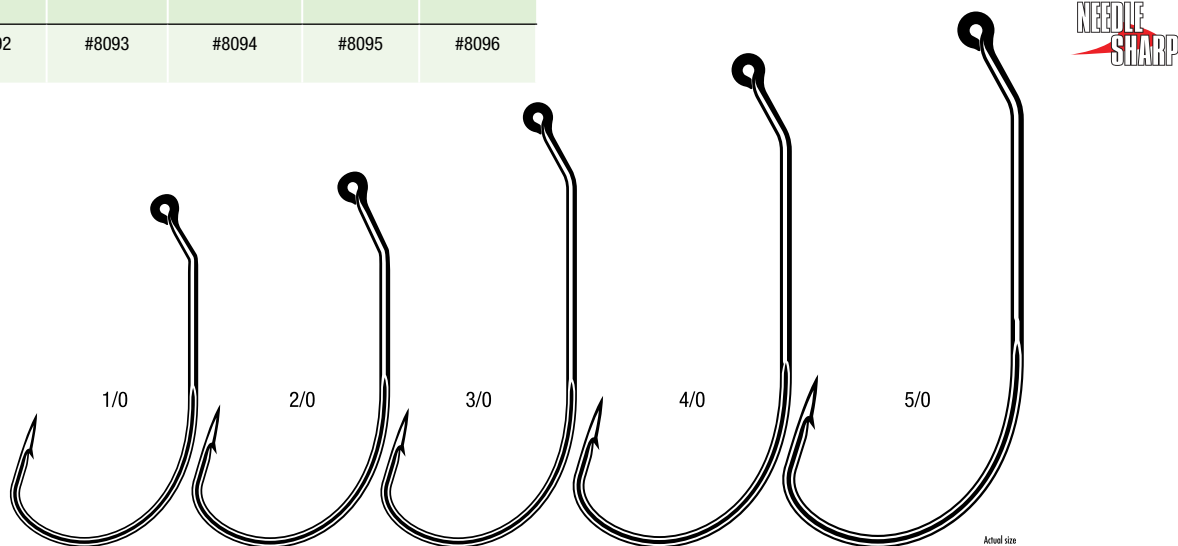

# 7250 ROUND BEND STRAIGHT SHANK SPINNER BAIT HOOK

Fits mold using Mustad 32608NP and Eagle Claw 253 and 255

| Hook Sizes   | 1/0   | 2/0   | 3/0   | 4/0   | 5/0   |
|--------------|-------|-------|-------|-------|-------|
| Black Nickel | #7978 | #7979 | #7980 | #7981 | #7982 |
| Black Nickel | #7983 | #7984 | #7985 | #7986 | #7987 |

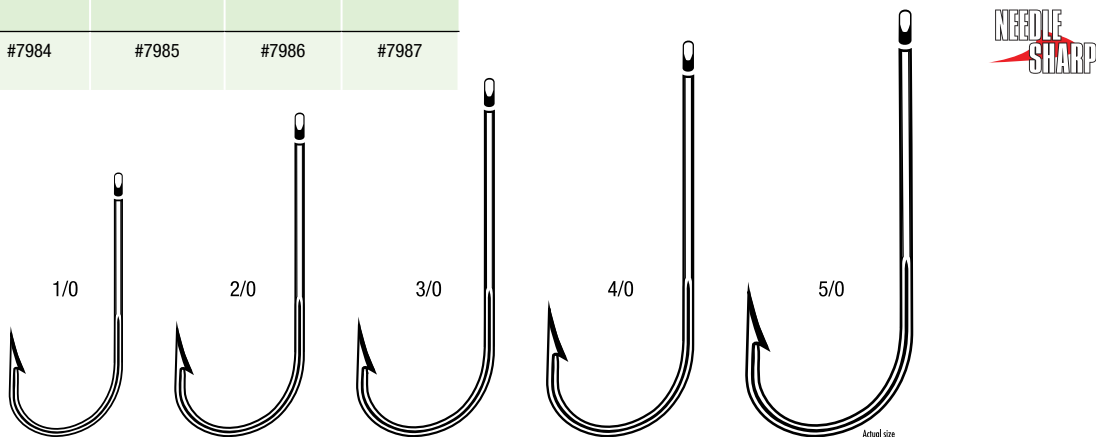

# 7320 HEAVY EXTENDED LOCKING BEND EWG

VMC original design - ideal for articulated jigheads

| Hook Sizes   | 4/0   | 5/0   |
|--------------|-------|-------|
| Black Nickel | #7988 | #7989 |
| Black Nickel | #7990 | #7991 |

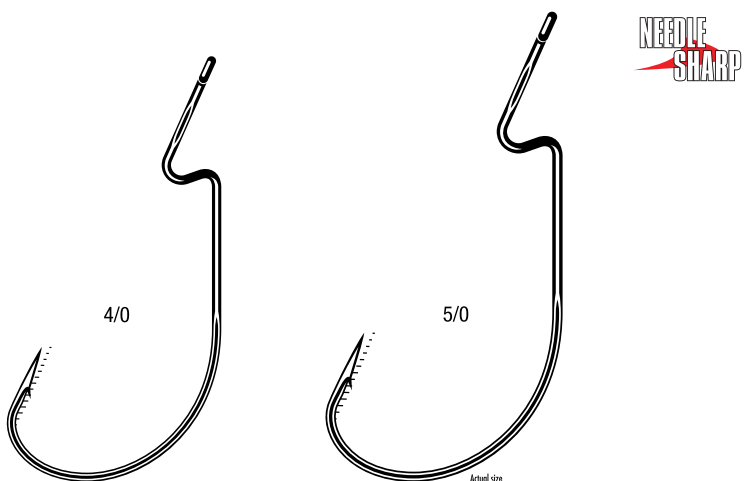

## DO-IT LINE GRIP SWIVELS

A special swivel with a V-Shaped eye to grip the line without tying. Allows easy removal or adjustment. For use in Do-it® Drop-Shot Molds. ⚠



| Item No. | Size | Finish | Qty.  |
|----------|------|--------|-------|
| 2427     | 7    | Nickel | 100   |
| 2607     | 7    | Nickel | 1,000 |

## BARREL SWIVELS

Made in KOREA. Brass finish. ⚠



| Size | Item No. | Qty. | Item No. | Qty.  |
|------|----------|------|----------|-------|
| 12   | 1912     | 144  | 2601     | 1,000 |
| 7    | 1913     | 144  | 2602     | 1,000 |
| 3    | 1921     | 144  | 2603     | 1,000 |
| 1/0  | 1927     | 144  |          |       |

## CRANE SWIVELS

These are strong American-made Crane Swivels for use with spinners or for molding into sinkers or lures.

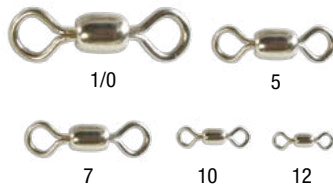

Nickel Finish. Made in USA. ⚠

| Size | Test    | 100 pack |          | Bulk 1,000 pack |          |
|------|---------|----------|----------|-----------------|----------|
|      |         | Item No. | Item No. | Item No.        | Item No. |
| 12   | 20 lb.  | 2462     | 2612     |                 |          |
| 10   | 30 lb.  | 2460     | 2613     |                 |          |
| 7    | 75 lb.  | 2457     | 2614     |                 |          |
| 5    | 90 lb.  | 2455     | 2615     |                 |          |
| 1/0  | 175 lb. | 2450     | 2616     |                 |          |

## B-CHAIN SWIVELS

Stainless steel beaded chain swivels. Four balls on each swivel. Packaged 50 in a poly bag. Made in USA.

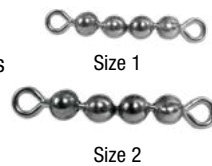

| Item No. | Size | Strength | Qty. |
|----------|------|----------|------|
| 2421     | 1    | 35 lb.   | 50   |
| 2422     | 2    | 75 lb.   | 50   |
| 2423     | 3    | 175 lb.  | 50   |

## INTERLOCK SNAPS

These quality American-made nickel snaps may be opened from either end. Suitable for permanently attaching to small swivels. Packaged 100 in a poly bag. ⚠



| Item No. | Size | Finish | Qty. |
|----------|------|--------|------|
| 2471     | 1    | Nickel | 100  |

## BALL BEARING SWIVELS

Premium nickel plated ball bearing swivels ⚠



| Item No. | Qty. |
|----------|------|
| 2428     | 10   |

## WIRE EYES ⚠

| Item No. | Size       | Qty.               |                         |
|----------|------------|--------------------|-------------------------|
| 2316     | 0          | 100                |                         |
| 2317     | 0          | 1,000              | No. 0 (Stainless Steel) |
| 2310     | 1          | 100                |                         |
| 2311     | 1          | 1 lb (~1,100 eyes) | No. 1 (Brass)           |
| 2312     | 2          | 100                |                         |
| 2313     | 2          | 1 lb (~630 eyes)   | No. 2 (Brass)           |
| 2314     | 3          | 100                |                         |
| 2315     | 3          | 1 lb (~310 eyes)   | No. 3 (Brass)           |
| 2309     | Downrigger | 50                 | Downrigger (Brass)      |

## DUO-LOCK SNAPS

Strong stainless steel snaps easily attach to swivels or crank baits. Highly favored snap for use with Blade Baits. Packaged 25 in a poly bag. ⚠

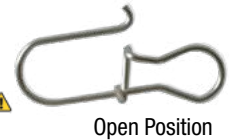

| Item No. | Size | Strength | Qty. |
|----------|------|----------|------|
| 2442     | 52   | 25 lb.   | 25   |
| 2443     | 53   | 40 lb.   | 25   |
| 2444     | 54   | 50 lb.   | 25   |

## BLADE COLLARS

These are pop rivet collars used behind aluminum blades to produce the squeaking sounds in buzz spin lures. ⚠

| Item No. | Qty.     |
|----------|----------|
| 2002     | 100 pack |

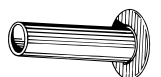

**WARNING:** Melting lead and casting lead objects will expose you and others in the area to lead, which is known to cause birth defects, other reproductive harm, and cancer. See instructions on Reducing Exposure supplied with product.

\*Items pictured near actual size.



## WIRE KEEPER FORM WB400 & WB800

Spring tempered stainless steel accessory utilized in Do-it items #3484 and #3487.

| Item No. | Item No. | Qty.       |
|----------|----------|------------|
| WB400    | 2609     | 100 pack   |
| WB400    | 2610     | 1,000 pack |
| WB800    | 2617     | 100 pack   |
| WB800    | 2618     | 1,000 pack |

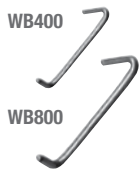

## DO-IT SCREW-LOC

Custom stainless steel screw-locs to be molded in jig heads.

| Item No. | Qty.      |
|----------|-----------|
| 2017     | 100 pack  |
| 2608     | 1000 pack |



## BOTTOM BOUNCER FORMS

Pre-made stainless steel Bottom Bouncer forms complete with a No.7 snap swivel attached. You only need to put a slight "kink" in the wire where it is molded inside the lead to keep the bottom bouncer body secure on the shaft. Use the wire diameter specified for your mold. Packaged per 25. ⚠️

| Item No. | Wire Form | Dimensions                |
|----------|-----------|---------------------------|
| 2018     | WBB-35    | .035 Wire<br>10" x 3-1/2" |
| 2019     | WBB-40    | .40 Wire<br>10" x 3-1/2"  |

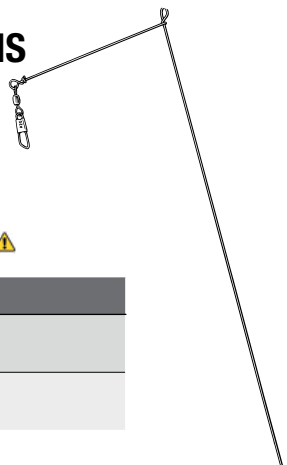

## BUZZ SPIN WIRE FORMS

are made for Do-it Buzz Spin Molds. Order the wire form designed for the specific Buzz Spin lure weight. Best lure performance will be achieved when the wire form, blade, and lure size are matched. See Delta Blades and other Buzz Blades for blade selections. Packaged per 100.

| Item No. | Wire Form Diameter    | Use with Lure Size |
|----------|-----------------------|--------------------|
| 1910     | WBS-3812<br>.051 wire | 3/8 or 1/2 oz      |
| 2007     | WBS-045<br>.045 Wire  | 1/4 oz             |
| 2006     | WBS-18<br>.035 Wire   | 1/8 oz             |



## HITCHING POST

Stainless Steel snap-on coil wire used for attaching plastics to hooks. Can also be used to attach trailers to Jigs or Spinnerbaits.

| Item No. | Size   | Qty.    |
|----------|--------|---------|
| 2230     | Small  | 25 pack |
| 2231     | Medium | 25 Pack |
| 2232     | Large  | 25 pack |

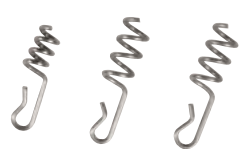

## TWISTED EYE WIRE SHAFTS

Steel Twisted Eye Wire Shafts to complete lure body and weight forward spinners. Use size .024 x 3" for 1/32 and 1/16 size lures. Use size .030 x 4" for other lure body and all weight forward spinner sizes. Packaged and sold per 100 in poly bag.

| Item No. | Type                        | Qty. |
|----------|-----------------------------|------|
| 1909     | WLB-24S<br>.024 x 3" Shafts | 100  |
| 1908     | WER-30A<br>.030 x 4" Shafts | 100  |

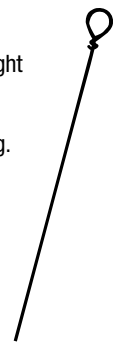

## QUAD WING PLASTIC BUZZ BLADE

The Quad Wing Buzz Blade puts your lures on top quick and keeps them there. The four wings allow for a slower retrieve than is possible with other buzz blades. An aluminum collar creates a squeaking noise from the turning blade. Select blade size to match lure weight.

Q-14 Quad Wing Blades for 1/4 oz. Lures

| Item No. | Color      | Qty. |
|----------|------------|------|
| 2240     | Clear      | 10   |
| 2241     | White      | 10   |
| 2242     | Black      | 10   |
| 2243     | Chartreuse | 10   |



Q-3812 Quad Wing Blades for 3/8 & 1/2 oz. Lures

| Item No. | Color      | Qty. |
|----------|------------|------|
| 2250     | Clear      | 10   |
| 2251     | White      | 10   |
| 2252     | Black      | 10   |
| 2253     | Chartreuse | 10   |



## DELTA BLADES

These broad aluminum blades are designed for Buzz Spin type lures. They bring the lure to the surface quickly with a maximum of commotion. Included with each blade is a pop rivet collar that holds the blade in place as well as imparting a "squeaking" noise from the turning blade. This noise is reputed to attract bass and game fish. Blade D14C is for 1/4 oz. lures and Blade D3812A can be used with heavier lures. The smaller D40E Delta Blade is for 1/8 oz. lures and should be used on a spinner wire no larger than .041. Packaged per 25 with collars.

| Item No. | Delta Blade Lure Size  | Dimensions (Length x width) |
|----------|------------------------|-----------------------------|
| 1907     | D3812A<br>3/8 & 1/2 oz | 1-5/8" x 1-15/16"           |
| 1906     | D14C - 1/4 oz          | 1-3/8" x 1-9/16"            |
| 2005     | D40E - 1/8 oz          | 1" x 1-1/4"                 |



## COUNTER TURNING TANDEM BUZZ BLADE SETS

Tandem Aluminum Buzz Blades with one turning right and one turning left create a lot of excitement in the water. Use up to .055 wire. Packaged 12 pair (24 blades) with 24 collars per set.

| Item No. | Tandem Blade Set | Use with Lure Size |
|----------|------------------|--------------------|
| 2003     | CT48D            | 1/8 & 1/4 oz       |
| 2004     | CT3812B          | 3/8 & 1/2 oz       |



## SPINNER JIG FORMS

Tempered Stainless Steel Wire. Specify Style and Item No.

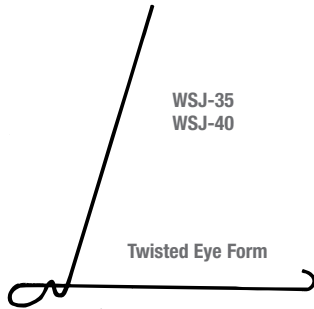
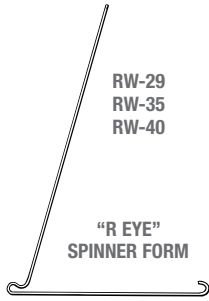

| Item No. | Style  | Diameter | Forms       | Legs            |
|----------|--------|----------|-------------|-----------------|
| 2011     | RW-29  | .029     | "R" Eye     | 1-3/8" x 1-3/4" |
| 2008     | WSJ-35 | .035     | Twisted Eye | 1-3/4" x 2-1/4" |
| 2009     | RW-35  | .035     | "R" Eye     | 1-3/4" x 2-1/2" |
| 1915     | WSJ-40 | .040     | Twisted Eye | 2-1/2" x 3-1/2" |
| 2010     | RW-40  | .040     | "R" Eye     | 2-1/4" x 3-1/2" |

## WIRE FORM

Stainless steel wire form for Flutter Jig. Packaged per 25.

| Item No. | Size  |
|----------|-------|
| 5850     | FL14  |
| 5851     | FL12  |
| 5852     | FL34  |
| 5853     | FL100 |
| 5854     | FL200 |
| 5855     | FL300 |
| 5856     | FL400 |
| 5857     | FL500 |
| 5858     | FL700 |
| 5859     | FL900 |



## CONNECTOR SLEEVES

Use to make leaders or forms. Nickel finish. 100 Pack. ⚠️



| Item No. | Diameter Inside | Use with Wire size |
|----------|-----------------|--------------------|
| 2095     | .055            | .026               |
| 2096     | .070            | .029               |
| 2097     | .080            | .035               |
| 2101     | .116            | .041-.043          |

## HAMMERED SPOON HS-FORM

This is an economical internal form, molded entirely inside the Hammered Spoon to give each lure the required strength. Made of stainless steel. Packaged per 100.

| Item No. | Size   |
|----------|--------|
| 2014     | HS-34  |
| 2015     | HS-100 |



## TAIL SPINNER WIRE FORMS

A prebent tempered stainless steel form to fit Do-it® Tail Spinner Molds. Packaged per 100.

| Item No. | Style  |
|----------|--------|
| 1916     | WTS-28 |



## JIGGING SPOON FORMS

Double looped wire forms for use in Model JS-3-A Jigging Spoon mold. Made from .030 stainless steel wire. Packaged per 100.

| Item No. | Size          |
|----------|---------------|
| 2171     | 1-JSF (5/8)   |
| 2172     | 2-JSF (1-1/8) |
| 2173     | 3-JSF (1-3/8) |



## CC-FORMS

Double looped stainless steel forms for use in casting spoon molds and diamond lure molds. Please specify Item No. and size when ordering. Packaged per 100.

| Item No. | Size           |
|----------|----------------|
| 2174     | CC-14 (1/4)    |
| 2175     | CC-12 (1/2)    |
| 2176     | CC-34 (3/4)    |
| 2177     | CC-100 (1)     |
| 2178     | CC-150 (1-1/2) |
| 2179     | CC-200 (2)     |
| 2180     | CC-300 (3)     |
| 2181     | CC-400 (4)     |
| 2182     | CC-600 (6)     |



## WIRE SHAFT WITH HOOK LOOP

These stainless steel straight wire shafts are made for those who prefer to make their own spinner jig forms. All shafts have a hook loop on one end. Packaged per 100.

| Item No. | Shafts         |
|----------|----------------|
| 2185     | .035 x 6" Wire |
| 2186     | .040 x 6" Wire |



## COILED STAINLESS STEEL WIRE

Make your own wire forms or leaders. Sold in 1/4 lb. packages



| Item No. | Wire Size | Feet | Lb. Test |
|----------|-----------|------|----------|
| 5503     | .012      | 650  | 32       |
| 5510     | .024      | 150  | 120      |
| 5511     | .026      | 137  | 140      |
| 5512     | .029      | 111  | 174      |
| 5513     | .031      | 85   | 190      |
| 5515     | .035      | 76   | 240      |
| 5518     | .041      | 56   | 330      |
| 5519     | .043      | 50   | 360      |

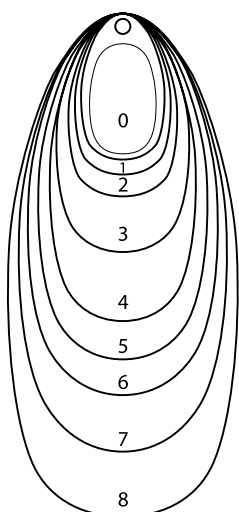

## FRENCH BLADES

French Spinner Blades are slightly domed in the center for appearance and to start spinning quickly. These quality blades are popular with weight-forward and in-line spinners. Nickel Plated & Brass. Packaged per 50. ⚠️

| French Blade Size | Nickel Plated | Polished Brass |
|-------------------|---------------|----------------|
|                   | Item No.      | Item No.       |
| 0                 | 2370          | 2458           |
| 1                 | 2371          | 2459           |
| 2                 | 2372          | 2461           |
| 3                 | 2373          | 2463           |
| 4                 | 2374          | 2464           |
| 5                 | 2475          | 2465           |
| 6                 | 2476          | 2466           |
| 7                 | 2477          | 2467           |
| 8                 | 2478          | 2468           |



## NICKEL PLATED CASTING SPOONS

Make your own Casting Spoons with the best balanced, fastest wobbling blades available. Just add a split-ring and treble hook. Packaged per 10. ⚠️

| Size   | Smooth Nickel | Hammered Nickel |
|--------|---------------|-----------------|
|        | Item No.      | Item No.        |
| 1.75"  | 1962          | 2012            |
| 2.25"  | 1963          | 2013            |
| 2.875" | 1965          | 2016            |
| 3.5"   | 1966          | 2020            |

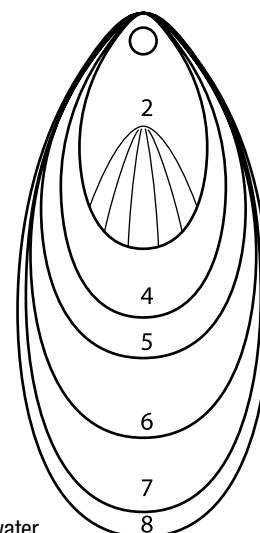

## FLUTED BLADES

These Fluted Blades really churn the water. Nickel Plated. Packaged per 25. ⚠️

| Size | Item No. |
|------|----------|
| 2    | 2482     |
| 4    | 2484     |
| 5    | 2485     |
| 6    | 2486     |
| 7    | 2487     |
| 8    | 2488     |

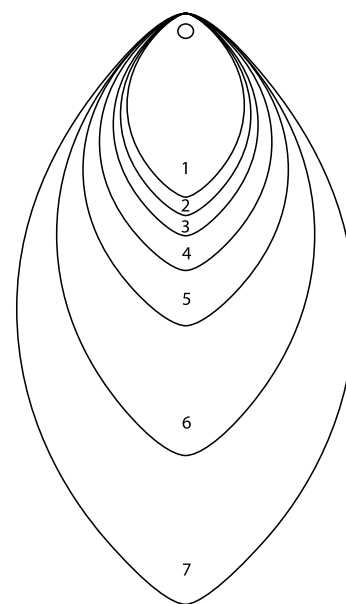

## OLYMPIC BLADES

These blades are carefully balanced and tuned for maximum action. Nickel Plated. Packaged per 25. ⚠️

| Size | Item No. |
|------|----------|
| 1    | 2411     |
| 2    | 2412     |
| 3    | 2413     |
| 4    | 2414     |
| 5    | 2415     |
| 6    | 2416     |
| 7    | 2417     |



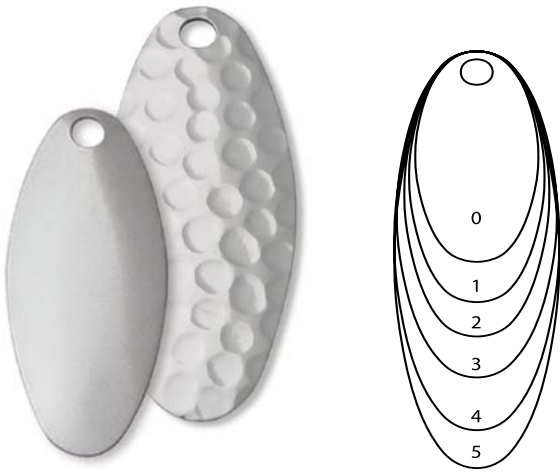

## SWING BLADES

Hammered and smooth Nickel Swing Blades are designed for use with many types of spinning lures. Packaged per 50. ⚠️

| Swing Blade Size | Smooth Nickel Plated | Hammered Nickel Plated |
|------------------|----------------------|------------------------|
|                  | Item No.             | Item No.               |
| 0                | 2400                 | 2300                   |
| 1                | 2401                 | 2301                   |
| 2                | 2402                 | NA                     |
| 3                | 2403                 | 2303                   |
| 4                | 2404                 | 2304                   |
| 5                | 2405                 | 2305                   |

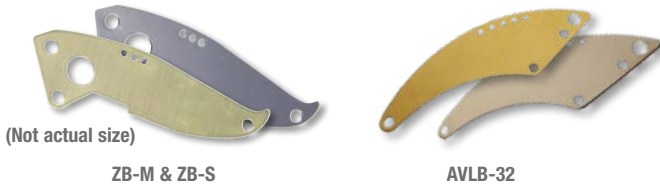

(Not actual size)

ZB-M & ZB-S

AVLB-32

## BLADE BAIT LURE BLANKS

Blade blanks designed for Shad Blade and Vibrating lures with all the necessary holes punched. Brass finish blanks can be painted. Nickel-plated blanks need only lead molded on and hooks attached. Use the ZB-M blanks for 1/2, 5/8, and 3/4 size lures. Use ZB-S for 1/4 and 3/8 size lures. Use the AVLB-32 for the Ultra Minnow Blade. ⚠️

| Finish                                 | Quantity | Item No. |
|--|----------|----------|
| <b>ZB-M Size Vibrating Lure Blanks</b> |          |          |
| Unpolished Brass Blanks                | 25       | 1958     |
|  | 100      | 1959     |
|  | 1,000    | 1951     |
| Nickel Plated Blanks                   | 25       | 1960     |
|  | 100      | 1961     |
|  | 1,000    | 1953     |
| <b>ZB-S Size Vibrating Lure Blanks</b> |          |          |
| Unpolished Brass Blanks                | 25       | 2361     |
|  | 100      | 2362     |
|  | 1,000    | 2360     |
| Nickel Plated Blanks                   | 25       | 2365     |
|  | 100      | 2366     |
|  | 1,000    | 2367     |
| <b>AVLB-32 Vibrating Lure Blanks</b>   |          |          |
| Brass Blanks                           | 25       | 2109     |
|  | 100      | 2110     |
| Nickel Blanks                          | 25       | 2130     |
|  | 100      | 2131     |



## WILLOW LEAF BLADES

Long and narrow Willow Leaf Blades are popular on spinner jigs that are used in weeds and moss. These blades swing a smaller arc than most other blades to help them run through dense cover with less tangles and snags. Hammered Nickel Finish. Packaged per 25. ⚠️

| Size | Hammered Nickel Plated | Smooth Nickel Plated |
|------|------------------------|----------------------|
|      | Item No.               | Item No.             |
| 3    | 2353                   | 2451                 |
| 3.5  | 2350                   | 2452                 |
| 4    | 2354                   | 2453                 |
| 5    | 2355                   | 2454                 |
| 6    | 2356                   | 2456                 |
| 7    | 2357                   | 2469                 |

## POISON TAIL SWING WIRE FORM STW130

| Item No. | Qty.      |
|----------|-----------|
| 2625     | 100 pack  |
| 2626     | 1000 pack |



## POISON TAIL SWING WIRE FORM STW155

| Item No. | Qty.      |
|----------|-----------|
| 2627     | 100 pack  |
| 2628     | 1000 pack |



## WIRE KEEPER WDB1000

| Item No. | Qty.      |
|----------|-----------|
| 2649     | 100 pack  |
| 2650     | 1000 pack |



\*Items pictured near actual size.

## COLORADO BLADES

The finest quality spinner blades, correct in shape, size and design. The smooth burnished edges will not damage line or leader. Packaged per 50 blades. ⚠

| Colorado Blade Size | Smooth Nickel | Hammered Nickel |
|---------------------|---------------|-----------------|
|                     | Item No.      | Item No.        |
| 00                  | 2329          | 2489            |
| 0                   | 2330          | 2490            |
| 1                   | 2331          | 2491            |
| 2                   | 2332          | 2492            |
| 3                   | 2333          | 2493            |
| 3.5                 | 2338          | 2498            |
| 4                   | 2334          | 2494            |
| 5                   | 2335          | 2495            |

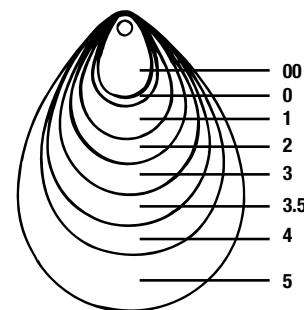

## NICKEL JIG SPINNERS & WIRE FORMS

Make a spinner bait out of any jig. Just clip on to the hook eye. Sold in pre-made spinners with Colorado Blades or just the by itself. Packaged per 25. ⚠

| Colorado Blade Size | Smooth Nickel | Wire Forms |        |
|---------------------|---------------|------------|--------|
|                     | Item No.      | Item No.   | Size   |
| 00                  | 2429          | 2183       | Small  |
| 0                   | 2430          | 2184       | Medium |
| 1                   | 2431          | 2187       | Large  |
| 2                   | 2432          |            |        |
| 3                   | 2433          |            |        |

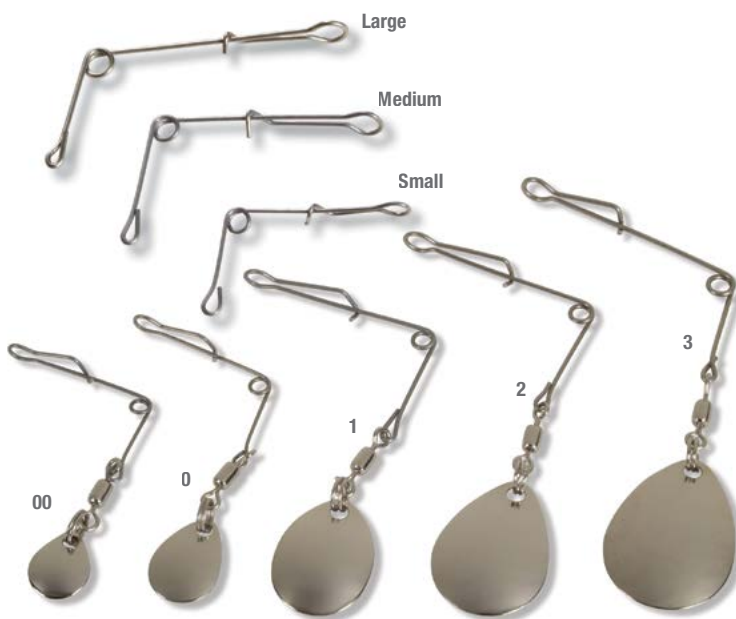

## ULTRA RIG UMBRELLA WIRE FORMS

5 ready to pour wire forms complete with five #7 Duo lock snaps, .040 wire. ⚠

| Item No. |
|----------|
| 5860     |



## SWING HOOK WIRE FORMS WJI450

| Item No. | Qty.      |
|----------|-----------|
| 2606     | 100 pack  |
| 2605     | 1000 pack |



## SWING HOOK WIRE FORMS WJI600

| Item No. | Qty.      |
|----------|-----------|
| 2619     | 100 pack  |
| 2620     | 1000 pack |



## WEY525 UNDERSPIN WIRE FORMS

| Item No. | Qty.      |
|----------|-----------|
| 2621     | 100 Pack  |
| 2622     | 1000 Pack |



## WEY375 UNDERSPIN WIRE FORMS

| Item No. | Qty.      |
|----------|-----------|
| 2623     | 100 Pack  |
| 2624     | 1000 Pack |



\*Items pictured near actual size.

## FOLDED CLELVISES

These quality nickel-plated brass clelvises are used to attach a spinner blade on a wire shaft. Use on tail spinners, Erie rigs, keel spinners and on spinner jigs with tandem blades. Packaged per 100. ⚠

| Size | Item No. |
|------|----------|
| 2    | 2342     |
| 4    | 2344     |
| 6    | 2346     |



## SOLID BRASS CLELVISES

These clelvises are formed from spring hard brass for maximum strength. The best quality for the finest lures. Packaged per 100. ⚠

| Size | Brass    | Nickel Plate |
|------|----------|--------------|
|      | Item No. | Item No.     |
| 1    | 2221     | 2261         |
| 2    | 2222     | 2262         |
| 3    | 2223     | 2263         |
| 4    | 2224     | 2264         |
| 6    | 2226     | 2266         |
| 8    | 2228     | 2268         |



## SPLIT RINGS

Quality steel split rings. Sizes 0 and 1 are made of nickel-plated fine wire perfect for fastening small spinner blades to swivels, etc. Size 2 and larger sizes are standard wire strong enough for attaching treble hooks to lures. ⚠



| Size | Item No. |
|------|----------|
| 0    | 2390     |
| 1    | 2391     |
| 2    | 2392     |
| 3    | 2393     |
| 4    | 2394     |
| 5    | 2395     |
| 6    | 2396     |
| 7    | 2397     |
| 8    | 2398     |

## OWNER HYPERWIRE SPLIT RINGS

Super heavy-duty split ring that is made from the highest quality stainless steel. Corrosion resistant and quick to spring back after opening. A must have for large salt water jigs and spoons.

| Size | Item No. | Qty |
|------|----------|-----|
| 4    | 4940     | 10  |
| 5    | 4941     | 9   |
| 6    | 4942     | 8   |
| 7    | 4943     | 7   |
| 8    | 4944     | 7   |
| 9    | 4945     | 6   |
| 10   | 4946     | 6   |
| 11   | 4947     | 5   |



## LURE BODIES

Create your own lures and in-line spinner baits with these precision-tuned, balanced lure bodies. Brass and Nickel Plated. Use with the twisted wire shafts. Packaged per 25. Approximate hole diameter .047 or greater. ⚠

| Weight (oz) | Brass    | Nickel Plated |  |
|-------------|----------|---------------|--|
|             | Item No. | Item No.      |  |
| .065        | 2800     | 2900          |  |
| .078        | 2801     | 2901          |  |
| .126        | 2802     | 2902          |  |
| .227        | 2803     | 2903          |  |
| .056        | 2804     | 2904          |  |
| .092        | 2805     | 2905          |  |
| .057        | 2806     | 2906          |  |
| .128        | 2807     | 2907          |  |
| .236        | 2808     | 2908          |  |
| .080        | 2809     | 2909          |  |
| .103        | 2810     | 2910          |  |
| .067        | 2811     | 2911          |  |
| .099        | 2812     | 2912          |  |
| .107        | 2813     | 2913          |  |
| N/A         | 2814     | 2914          |  |
| N/A         | 2815     | 2915          |  |
| N/A         | 2816     | 2916          |  |

## X<sup>2</sup> OVAL SPLIT RINGS

X<sup>2</sup> Oval Power Rings are 50% stronger than similar fine sized round split rings, making them the strongest ring available anywhere. Their unique oval design is also self-centering to keep the "split" at the side. X<sup>2</sup> Oval Power Rings are made from a unique magnesium alloy, which is stronger than stainless steel, and are finished with a military-grade zinc plating. ⚠

| Size | Item No. | Qty      |
|------|----------|----------|
| 5    | 2255     | 100 pack |
| 6    | 2256     | 100 pack |
| 7    | 2257     | 100 pack |
| 8    | 2258     | 100 pack |





## OWNER SOLID "UNBREAKABLE" RINGS

Heavy-Duty stainless steel solid rings that are virtually "unbreakable". They are abrasion resistant from wire leader lines and unlike split rings they will not cut through softer lines. A must have for attaching stinger hooks to large jigs and spoons.

| Size | Item No. | Qty    |
|------|----------|--------|
| 4    | 4930     | 9 pack |
| 5    | 4931     | 8 pack |
| 6.5  | 4932     | 8 pack |
| 7.5  | 4933     | 8 pack |
| 9    | 4934     | 8 pack |



## BRASS BEADS

Beads are not just for decoration! Also useful as bearing surfaces for spinner blades or clevises. Use small metal sizes on weighted spinners. Larger metal sizes for spinner jigs and buzz-spin lures. Brass and Nickel Plated.

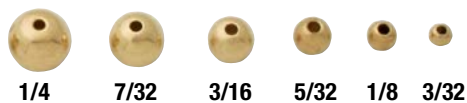

| Size                              | Hole Diameter | Item No. |
|-----------------------------------|---------------|----------|
| <b>Solid Brass</b>                |               |          |
| 3/32                              | .037          | 2343     |
| 1/8                               | .047          | 2347     |
| 5/32                              | .047          | 2348     |
| 3/16                              | .047          | 2349     |
| 7/32                              | .047          | 2351     |
| 1/4                               | .047          | 2352     |
| <b>Solid Brass Nickel Plated</b>  |               |          |
| 3/32                              | .037          | 2440     |
| 1/8                               | .047          | 2441     |
| 5/32                              | .047          | 2446     |
| 3/16                              | .047          | 2447     |
| 7/32                              | .047          | 2448     |
| 1/4                               | .047          | 2449     |
| <b>Hollow Metal Nickel Plated</b> |               |          |
| 3/32                              | .043          | 2318     |
| 1/8                               | .046          | 2319     |
| 5/32                              | .062          | 2320     |
| 3/16                              | .056          | 2321     |



## PLASTIC BEADS

Great for bearing or decorative purposes when bright color desired.

| Fluorescent Red |      |      |      |      |      |      |
|-----------------|------|------|------|------|------|------|
| Size            | 3    | 4    | 5    | 6    | 8    | 10   |
| Item No.        | 2322 | 2324 | 2325 | 2323 | 2328 | 2336 |
|                 |      |      |      |      |      |      |
| Chartreuse      |      |      |      |      |      |      |
| Size            | 3    | 4    | 5    | 6    | 8    | 10   |
| Item No.        | 2337 | 2326 | 2327 | 2339 | 2340 | 2341 |

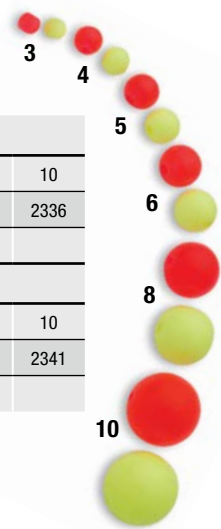

## STICK-ON LURE EYES

These self-adhesive flat decal lure eyes may be applied to smooth, FLAT surfaces. All eyes have a black center. Quantities of eyes in package vary with size of eyes. ⚠

| Size         | 1.5      | 2        | 2.5      | 4        | 5        | 6        |
|--------------|----------|----------|----------|----------|----------|----------|
| Diameter     | 3/32"    | 1/8"     | 5/32"    | 1/4"     | 9/32"    | 3/8"     |
| Per Pack     | 240      | 240      | 255      | 190      | 160      | 104      |
| Color        | Item No. | Item No. | Item No. | Item No. | Item No. | Item No. |
| White Glow   | 2560     | 2571     | 2580     | 2585     | 2590     | 2595     |
| Yellow Prism | 2561     | 2572     | 2581     | 2586     | 2591     | 2596     |
| Pink Prism   | 2562     | 2573     | 2582     | 2587     | 2592     | 2597     |
| Green Prism  | 2563     | 2574     | 2583     | 2588     | 2593     | 2598     |
| Silver Prism | 2564     | 2575     | 2584     | 2589     | 2594     | 2599     |



## 3D STICK-ON LURE EYES

Three-dimensional molded plastic self-adhesive lure eyes may be applied to smooth and FLAT surfaces. Add lifelike 3-D eyes to your lures for an incredible realistic effect. All eyes have a black center. 100 eyes per pack. ⚠

| Size             | 2        | 2.5      | 4        | 5        | 6        |
|------------------|----------|----------|----------|----------|----------|
| Diameter         | 1/8"     | 5/32"    | 1/4"     | 9/32"    | 3/8"     |
| Color            | Item No. | Item No. | Item No. | Item No. | Item No. |
| White Glow       | 2566     | 2660     | 2665     | 2670     | 2675     |
| Chartreuse Prism | 2567     | 2661     | 2666     | 2671     | 2676     |
| Red Prism        | 2568     | 2662     | 2667     | 2672     | 2677     |
| Silver Prism     | 2569     | 2663     | 2668     | 2673     | 2678     |
| White Pearl      | 2685     | 2686     | 2687     | 2688     | 2689     |
| Gold Prism       | 2680     | 2681     | 2682     | 2683     | 2684     |

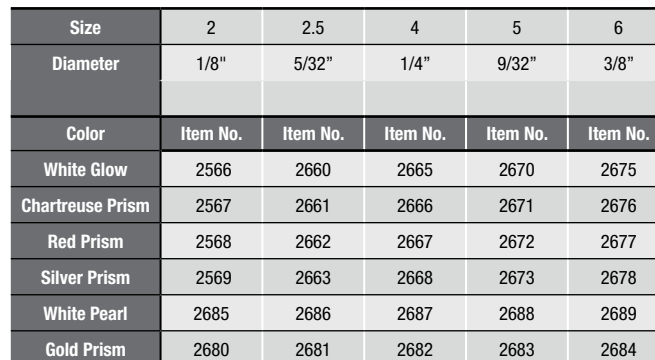

All blade and spoon tapes come in the below colors.

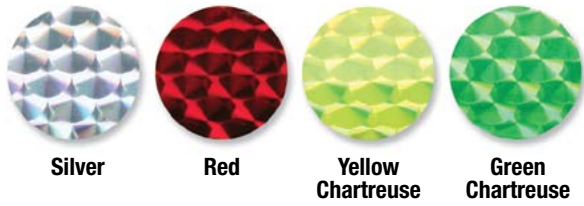

**SHAD BLADE DECAL** ⚠️

48 per pack.  
Specify Item Number

| Color             | Item No. |
|-------------------|----------|
| Silver            | 7800     |
| Red               | 7801     |
| Yellow Chartreuse | 7802     |
| Green Chartreuse  | 7803     |

**Z BLADE DECAL** ⚠️

48 per pack.  
Specify Item Number

| Color             | Item No. |
|-------------------|----------|
| Silver            | 7804     |
| Red               | 7805     |
| Yellow Chartreuse | 7806     |
| Green Chartreuse  | 7807     |

**JIGGING SPOON DECAL** ⚠️

5/8 oz., 48 per pack.  
Specify Item Number

| Color             | Item No. |
|-------------------|----------|
| Silver            | 7808     |
| Red               | 7809     |
| Yellow Chartreuse | 7810     |
| Green Chartreuse  | 7811     |

1-1/8 oz., 48 per pack.  
Specify Item Number

| Color             | Item No. |
|-------------------|----------|
| Silver            | 7812     |
| Red               | 7813     |
| Yellow Chartreuse | 7814     |
| Green Chartreuse  | 7815     |

1-3/8 oz., 48 per pack.  
Specify Item Number

| Color             | Item No. |
|-------------------|----------|
| Silver            | 7816     |
| Red               | 7817     |
| Yellow Chartreuse | 7818     |
| Green Chartreuse  | 7819     |



**CASTING SPOON DECAL** ⚠️

1/4 oz., 48 per pack.  
Specify Item Number

| Color             | Item No. |
|-------------------|----------|
| Silver            | 7820     |
| Red               | 7821     |
| Yellow Chartreuse | 7822     |
| Green Chartreuse  | 7823     |

1/2 oz., 48 per pack.  
Specify Item Number

| Color             | Item No. |
|-------------------|----------|
| Silver            | 7828     |
| Red               | 7829     |
| Yellow Chartreuse | 7830     |
| Green Chartreuse  | 7831     |

3/4 oz., 50 per pack.  
Specify Item Number

| Color             | Item No. |
|-------------------|----------|
| Silver            | 7832     |
| Red               | 7833     |
| Yellow Chartreuse | 7834     |
| Green Chartreuse  | 7835     |

1-1/2 oz., 48 per pack.  
Specify Item Number

| Color             | Item No. |
|-------------------|----------|
| Silver            | 7840     |
| Red               | 7841     |
| Yellow Chartreuse | 7842     |
| Green Chartreuse  | 7843     |

3 oz., 48 per pack.  
Specify Item Number

| Color             | Item No. |
|-------------------|----------|
| Silver            | 7848     |
| Red               | 7849     |
| Yellow Chartreuse | 7850     |
| Green Chartreuse  | 7851     |

1 oz., 50 per pack.  
Specify Item Number

| Color             | Item No. |
|-------------------|----------|
| Silver            | 7836     |
| Red               | 7837     |
| Yellow Chartreuse | 7838     |
| Green Chartreuse  | 7839     |

2 oz., 48 per pack.  
Specify Item Number

| Color             | Item No. |
|-------------------|----------|
| Silver            | 7844     |
| Red               | 7845     |
| Yellow Chartreuse | 7846     |
| Green Chartreuse  | 7847     |

4 oz., 48 per pack.  
Specify Item Number

| Color             | Item No. |
|-------------------|----------|
| Silver            | 7852     |
| Red               | 7853     |
| Yellow Chartreuse | 7854     |
| Green Chartreuse  | 7855     |



**ROLL TAPE** ⚠️

3/4" x 5 ft. rolls. Specify Item Number.



| Color             | Item No. |
|-------------------|----------|
| Silver            | 7860     |
| Gold              | 7861     |
| Red               | 7862     |
| Green Chartreuse  | 7863     |
| Yellow Chartreuse | 7864     |
| Holographic       | 7865     |
| Glow              | 7866     |



# PRO-TEC POWDER PAINT

Powder paint is a durable finish with a unique application process intended for lures that can be dip painted and then withstand heat of 350 degrees. No primer; no base coat; one coat completely covers! The lure is painted and dry in just a moment. Colors shown right.



- Non-Flammable!
- Powder Paint Can Ship by Air!
- High Gloss
- One Coat Coverage
- No Drying Time

|    | Color                  | Item No. |
|----|------------------------|----------|
| 01 | White                  | 2721     |
| 02 | Yellow Chartreuse      | 2731     |
| 03 | Green Chartreuse       | 2732     |
| 04 | Blaze Orange           | 2733     |
| 05 | Black                  | 2722     |
| 06 | Hot Pink               | 2734     |
| 07 | Flame Red              | 2737     |
| 08 | White Pearl            | 2720     |
| 11 | Bright Green           | 2735     |
| 13 | Yellow                 | 2723     |
| 14 | Red                    | 2724     |
| 15 | Purple                 | 2728     |
| 18 | Brown                  | 2725     |
| 19 | Blue                   | 2726     |
| 20 | Pink Pearl             | 2798     |
| 24 | Silver                 | 2729     |
| 28 | Gold                   | 2730     |
| 31 | Glow White             | 2751     |
| 32 | Glow Yellow Chartreuse | 2752     |
| 33 | Glow Green Chartreuse  | 2753     |
| 34 | Glow Blaze Orange      | 2754     |
| 35 | Glow Bright Green      | 2755     |
| 36 | Glow Hot Pink          | 2756     |
| 37 | Glow Flame Red         | 2757     |
| 38 | Watermelon Pepper      | 2777     |
| 40 | Watermelon             | 2738     |
| 41 | Candy Green            | 2740     |
| 42 | Candy Yellow           | 2741     |
| 43 | Candy Orange           | 2742     |
| 44 | Candy Red              | 2743     |
| 45 | Candy Purple           | 2744     |
| 46 | Candy Pink             | 2745     |
| 47 | Candy Raspberry        | 2746     |
| 48 | Transparent Gold       | 2747     |
| 49 | Candy Blue             | 2748     |
| 51 | Pumpkin Brown          | 2739     |
| 58 | Candy Lime             | 2749     |
| 61 | Transparent Copper     | 2750     |
| 63 | Smoke                  | 2778     |
| 64 | Green Pumpkin          | 2779     |

|     | Color                  | Item No. |
|-----|------------------------|----------|
| 66  | Dark Watermelon        | 2780     |
| 67  | June Bug Flake         | 2781     |
| 68  | Rootbeer Flake         | 2782     |
| 69  | Watermelon Red Flake   | 2783     |
| 71  | Copperhead             | 2784     |
| 74  | Red Bug                | 2785     |
| 76  | Ruby Slipper           | 2786     |
| 77  | Baby Bass Green        | 2787     |
| 78  | Dragon Fly             | 2788     |
| 79  | Pearl Pepper           | 2789     |
| 81  | Sapphire Blue          | 2790     |
| 82  | Black Blue Flake       | 2791     |
| 83  | Tree Bark              | 2793     |
| 84  | Salmon                 | 2794     |
| 86  | Powder Blue            | 2792     |
| 87  | Robin's Egg Blue       | 2795     |
| 88  | Transparent Watermelon | 2796     |
| 89  | Alewife                | 2797     |
| 93  | New Penny              | 2799     |
| 94  | Chrome                 | 2817     |
| 95  | Disco Green            | 2818     |
| 96  | Disco Blue             | 2819     |
| 97  | Disco Gold             | 2820     |
| 98  | Disco Red              | 2821     |
| 99  | Disco Lime             | 2822     |
| 100 | Disco Orange           | 2823     |
| 101 | Coppermine             | 2824     |
| 102 | Goldmine               | 2825     |
| 103 | Silvermine             | 2826     |
| 05M | Matte Black            | 2827     |
| 18M | Matte Brown            | 2828     |
| 40M | Matte Watermelon       | 2829     |
| 64M | Matte Green Pumpkin    | 2830     |
| NS  | "Glow" Overcoat*       | 2736     |
| NS  | Clear (not shown)      | 2727     |

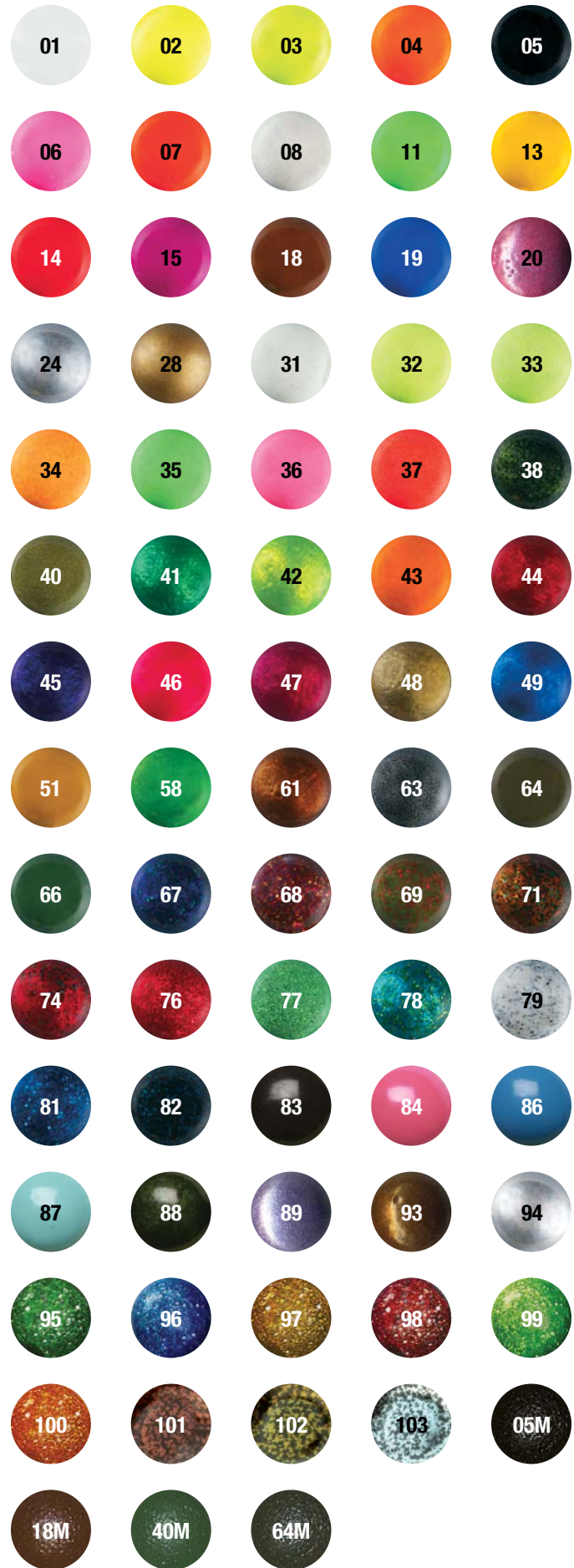

\*"Glow" Overcoat is a highly charged semi-clear powder that can be applied over any of the standard or fluorescent powder paint colors while the lure is still hot. The jig will appear as the base color in the light, but the overcoat will "glow" a greenish white in darkness.



## SUPER GLOW POWDER PAINT

Pro-Tec Super Glow Powder Paint is one of the most popular lure finishes to emerge in recent years, offering the durability of powder paint with a phosphorescent finish that glows longer and brighter than standard glow. And they glow their true color, attracting fish even in dark conditions.

|    | Color  | Item No. | Qty. |
|----|--------|----------|------|
| 56 | White  | 2758     | 2 oz |
| 52 | Yellow | 2759     | 2 oz |
| 53 | Green  | 2760     | 2 oz |
| 54 | Orange | 2761     | 2 oz |
| 57 | Red    | 2762     | 2 oz |
| 59 | Blue   | 2763     | 2 oz |



## PRO-FLAKE GLITTER

The perfect finish over any powder painted lures or projects. Simply swish hot lures or jigs right from the Pro-Tec powder color immediately into the glitter. That's it!

|    | Color                      | Item No. | Qty.   |
|----|----------------------------|----------|--------|
| 55 | Chartreuse Glitter         | 2764     | 1.5 oz |
| 60 | Gold Glitter               | 2765     | 1.5 oz |
| 62 | Gold Holographic Glitter   | 2766     | 1.5 oz |
| 65 | Green Glitter              | 2767     | 1.5 oz |
| 70 | Silver Glitter             | 2768     | 1.5 oz |
| 72 | Silver Holographic Glitter | 2769     | 1.5 oz |
| 73 | Firecracker Glitter        | 2770     | 1.5 oz |
| 75 | Orange Glitter             | 2771     | 1.5 oz |
| 80 | Red Glitter                | 2772     | 1.5 oz |
| 85 | Black Glitter              | 2773     | 1.5 oz |
| 90 | Blue Glitter               | 2774     | 1.5 oz |
| 92 | Purple Glitter             | 2775     | 1.5 oz |

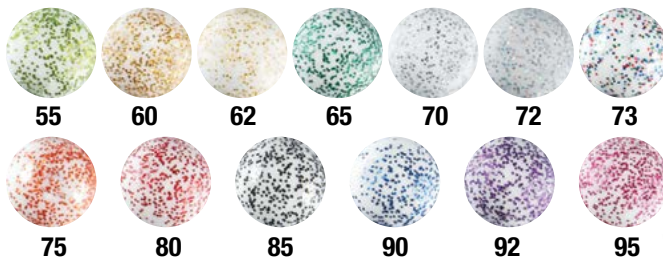

## VINYL PAINT SAMPLER PACK

Twelve 1 oz. Bottles. One each of White, Black, Clear Gloss, White Pearl, Glow, Blaze Orange, Hot Pink, Hot Yellow, Yellow Chartreuse, Green Chartreuse, Brown and Thinner. ⚠️

| Item No. |
|----------|
| 2029     |



## FLUID BED (FB3)

The FB3 suspends the powder on a column of slow moving air. The result is a beautifully thin, uniform coat of powder with every dip. A thinner coat means less wasted paint and, in most cases, will leave hook eyes unplugged.

|            | Item No. |
|------------|----------|
| Fluid Bed  | 2709     |
| Extra Cups | 2710     |



## SEAL-COAT LURE & JIG FINISH

The TOUGHEST finish ever put on a lure. This one-step system is as strong as epoxy without the measuring, mixing and smell. This finish has an extreme durability, a deep gloss, is non-yellowing, fast-drying and worm proof.

| Item No. | Qty. |
|----------|------|
| 2718     | 1 oz |
| 2719     | 4 oz |



## MARKERS

Quick-Coat Paint Markers are the answer to complete customization of lures, rods or arrows. With chisel, round and fine point tips, these markers are ideal for drawing eyes, gill plates, dorsal lines and scales. 1/3 fl. oz. ⚠️

| Color                 | Item No. |
|-----------------------|----------|
| Black                 | 2940     |
| White                 | 2941     |
| Silver                | 2942     |
| Red                   | 2943     |
| Chartreuse            | 2944     |
| Gold                  | 2945     |
| Super Glow Chartreuse | 2947     |
| Super Glow Green      | 2948     |



**CAUTION: FLAMMABLE**  
Contains petroleum distillates, keep from heat and open flame. Use under well-ventilated conditions. Keep out of reach of children.

# VINYL LURE AND JIG FINISH

Far more durable than lacquer and enamel paints and easier to use than epoxy paints, VINYL FINISH remains flexible and will not chip or flake when applied over clean lead. Go ahead, use your lures in rocks – the lead will dent but VINYL FINISH will not chip off. Dip or spray two coats of white as a base for other colors to get a professional finish. Most colors will dry flat — not glossy. For a gloss finish add a coat of CLEAR GLOSS. Colors shown right. ⚠



|    | Color<br>(FL indicates Fluorescent)<br>FL Dries Flat - Not Glossy |
|----|---|
| 01 | White   |
| 02 | Yellow Chartreuse (FL)  |
| 03 | Green Chartreuse (FL)   |
| 04 | Blaze Orange  |
| 05 | Black   |
| 06 | Hot Pink  |
| 07 | Flame Red   |
| 08 | White Pearl   |
| 11 | Bright Green  |
| 12 | Hot Yellow (FL)   |
| 13 | Yellow  |
| 14 | Red   |
| 15 | Purple  |
| 17 | Glow  |
| 18 | Brown   |
| 19 | Blue  |
| 24 | Silver Pearl  |
| 27 | Pumpkin   |
| 28 | Gold  |
| 29 | Grape   |
| 32 | Glow Yellow Chartreuse  |
| 33 | Glow Green Chartreuse   |
| 34 | Glow Blaze Orange   |
| 36 | Glow Hot Pink   |
| 37 | Glow Flame Red  |
| 40 | Watermelon  |
| 51 | Pumpkin Brown   |
| 64 | Green Pumpkin   |
| 77 | Baby Bass Green   |
| NS | Clear Gloss (not shown)   |
| NS | Thinner (not shown)   |

## GLITTER

Mix Glitter with CLEAR GLOSS to produce new variations in colors. Combine glitter at ratio of 1 to 20 parts clear gloss over colors. Use a ratio of 1 to 5 over white to produce brilliant silver or gold jigs. 13 grams. 1 oz. Bottle.



| Color                 | Item No. |
|-----------------------|----------|
| Silver Glitter        | 2081     |
| Gold Glitter          | 2082     |
| Fire Opal Glitter     | 2083     |
| Chartreuse Glitter    | 2084     |
| Emerald Green Glitter | 2085     |
| Orange Glitter        | 2086     |
| Red Glitter           | 2087     |
| Black Glitter         | 2088     |
| Blue Glitter          | 2089     |

## AIR BRUSH PAINT

CS Coatings' Air Brush Paint is one of the toughest liquid finishes on the market. Utilizing the latest generation of resins, these water based paints have been optimized for ease of use when spraying and offer excellent adhesion to most metals, wood, hard plastic and styrene. Available in twelve 1 oz. bottle starter kit and in individual 4 oz. bottles.



| Color             | Item No. | Size |
|-------------------|----------|------|
| White             | 2951     | 4 oz |
| Yellow Chartreuse | 2952     | 4 oz |
| Blaze Orange      | 2953     | 4 oz |
| Black             | 2954     | 4 oz |
| Hot Pink          | 2955     | 4 oz |
| Bright Green      | 2956     | 4 oz |
| Hot Yellow        | 2957     | 4 oz |
| Red               | 2958     | 4 oz |
| Brown             | 2959     | 4 oz |
| Grape             | 2960     | 4 oz |
| Watermelon        | 2961     | 4 oz |
| Clear             | 2962     | 4 oz |

## AIR BRUSH PAINT SAMPLE KIT

Twelve (12) 1 oz. bottle starter kit. Available in the colors above.



| Item No. |
|----------|
| 2950     |

## AIR BRUSH CLEANING KIT

7 Piece kit to protect your investment and keep it in perfect working condition.



| Item No. |
|----------|
| 5498     |

## COMPRESSOR D500

Economical and suitable for all airbrushes. This, 1/8H.P. motor is capable of delivering up to 20-40 PSI depending on airbrush being used. The D500 is an oilless piston compressor.

| Item No. |
|----------|
| 5491     |



## AIR BRUSH KIT VL SET

Perfect for both large paint coverage and creating fine details. Airbrush Set. Includes One VL#3 Double-Action Airbrush, size 1 & 5 spray heads, Head Protecting Cap, one Metal Color Cup, two Bottle Assemblies, one Bottle and Cover Assembly, Hanger, Wrench, one 6-foot Air Hose, Lessons Booklet and Parts.



| Item No. |
|----------|
| 5490     |

## SCALE NETTING

Used to create scale patterns on lures. Apply netting over lure on final paint coat to create the effect. 6 square feet per package

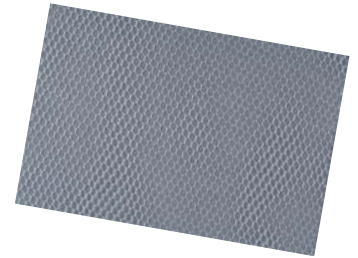

| Item No. | Type   |
|----------|--------|
| 5487     | Fine   |
| 5488     | Course |

## SCALE NETTING FRAME

Frame to hold scale netting tight for easy one hand airbrush operation. 8 inch diameter hoop.

| Item No. |
|----------|
| 5489     |



## JAR & CAP ASSEMBLY

| Type                    | Item No. |
|-------------------------|----------|
| 1 oz Jar & Cap Assembly | 5492     |
| 1 oz Cap Assembly       | 5493     |
| 1 oz Jar                | 5494     |
| 3 oz Jar & Cap Assembly | 5495     |
| 3 oz Cap Assembly       | 5496     |
| 3 oz Jar                | 5497     |





# UV BLAST PRODUCTS

UV Blast! is a clear overcoat that can be applied to any lure to reflect critical UV light. Your lure will flash even in dark, murky water where UV light, but not visible light, penetrates. Research continues to show that fish see and are attracted to UV light. With UV Blast!, you get the strongest UV enhancer available today in a variety of odor-free clear coats. See next page for further information.



## UV CLEAR LURE SPRAY

Just spray on and fire your lures up! This easy to carry 4 oz. bottle can be applied to any lure. Spray on and let dry for 30 seconds. ⚠️

| Item No. | Size |
|----------|------|
| 2963     | 4 oz |

**Flammable. Must ship ground.**



## UV BLAST MARKERS

These clear coat markers with UV Blast added give you total control over where you apply the UV Blast. With chisel, round and fine point tips included you now have the power to add UV Blast and its ability to reflect critical UV light exactly where you want it. Talk about customization. ⚠️

| Item No. | Size       |
|----------|------------|
| 2939     | 1/3 fl. oz |

**Flammable. Must ship ground.**



## WORM DIP

Instantly changes the color of soft plastics bait to give you near limitless possibilities. Quick-Coat Worm Dip has a penetrating finish that dries in seconds. Colors can even be mixed to make your own custom colors with UV enhancer. 4 oz. bottle. ⚠️

| Color         | Item No. |
|---------------|----------|
| Yellow        | 2920     |
| Green         | 2921     |
| Orange        | 2922     |
| Black         | 2923     |
| Pink          | 2924     |
| Red           | 2925     |
| Blue          | 2926     |
| Watermelon    | 2927     |
| Pumpkin Brown | 2928     |
| Clear         | 2967     |

**Flammable. Must ship ground.**



## SEAL-COAT LURE & JIG FINISH

The TOUGHEST Topcoat ever put on a lure now with the added benefit of UV Blast!. This one-step system is as strong as epoxy without the measuring, mixing and smell. This finish has an extreme durability, a deep gloss, is non-yellowing, fast-drying and worm proof.

| Item No. | Size |
|----------|------|
| 2964     | 1 oz |
| 2965     | 4 oz |



## LURE DIP

Don't miss "The Big One" because you don't have the right colored lure or hook in your tackle box. Quickly changes the color of hooks, blades, spoons, lures and more. Mix to create your own colors. Dries in seconds. 4 oz. bottle. ⚠️

| Color        | Item No. |
|--------------|----------|
| Yellow       | 2930     |
| Green        | 2931     |
| Black        | 2932     |
| Red          | 2933     |
| Blue         | 2934     |
| Blaze Orange | 2936     |
| Hot Pink     | 2937     |
| Purple       | 2938     |

**Flammable. Must ship ground.**



## CLEAR PRO-TEC POWDER PAINT

UV Blast! is a special formulation that has the effect of "lighting up" lures and jigs. Fish find baits faster that reflect UV light. This clear, super-durable, high-gloss formula can brighten fluorescent lures.

| Item No. | Size |
|----------|------|
| 2966     | 2 oz |



## LURE DIP NEUTRALIZER

Removes Quick-Coat paints from lure surfaces. ⚠️

| Item No. | Size |
|----------|------|
| 2935     | 4 oz |

**Flammable. Must ship ground.**

## WHAT IS UV BLAST?

UV Blast! is a coating that reflects ultraviolet light. This coating's special formulation has the effect of "lighting up" lures. CS Coatings manufactures a variety of odor free clear coats with UV Blast. We also have pigmented dyes for lures and soft plastics which contain the UV Blast formulation.

### WHAT IS UV LIGHT?

UV light is short wavelength, high frequency energy from sun and stars, invisible to us, but visible to a variety of the fish species scientists have tested so far.

### WHY TARGET UV LIGHT?

About 60% of sunlight that cuts through the water's surface is UV light. UV light penetrates clear water far deeper than human-visible light. Oceanographers have found UV light 700' deep. The scales of many prey fish reflect UV light. Zooplankton, shrimp, squid, and many aquatic insects also reflect UV light. This silhouettes them against their blue-green background, making these creatures more visible to their predators. UV light also polarizes, especially early and late in the day. Diverse gamefish detect polarized light.

### HOW DOES UV BLAST WORK?

In clear water UV light reflects further off UV-Blast coated baits than regular light does. UV light even brightens fluorescent lures. Fish find baits that reflect UV light faster than those without.

### WHAT FISH WILL RESPOND BEST TO UV BLAST?

Many fish that eat zooplankton see UV light. In saltwater, biologists have found that pink, chum, coho, sockeye, and masu salmon detect UV light. Weakfish and flounder also detect UV light. In freshwater, biologists found that brown and rainbow trout, kokanee, yellow perch, white suckers, carp, bluegill, and pumpkinseed sunfish detect UV light. Largemouth and smallmouth bass – members of the sunfish family – may also see UV light. Many fish species have yet to be tested to determine if they detect UV light.

### WHEN WILL UV BLAST ATTRACT FISH?

UV paints are effective in any daylight. But early and late in the day, UV light penetrates the water's surface much better than human-visible light. UV also penetrates fog and clouds. At these times, UV light is by far the greatest amount of light in water. Moonlight and starlight also contain energy from the UV spectrum.

### WHERE DOES UV BLAST WORK BEST?

UV light makes up nearly all the light in deep, clear water. Mud, algal blooms, and glacial till absorb and scatter UV light decreasing the depth which it penetrates. Long wavelength, low frequency, non-UV light – red and infrared – will cut through murkier water better.

### HOW DOES UV BLAST DIFFER FROM GLOW PAINT?

UV Blast differs from glow paint like the moon differs from the sun. UV Blast reflects light. As long as there's sunlight, UV Blast brightens baits. Glow baits give off their own light. They store light energy above water, then release it underwater. Eventually the glow is used up. The bait fades and you need a bright light to recharge it. Direct sun burns glow paints, but not UV Blast. It needs no recharging. It does not fade.

## FLEX COAT BRUSHES

Package of 10 non-shedding brushes for painting lures or applying epoxies.

| Item No. |
|----------|
| 2092     |



## CLEAR EPOXY SEALER

This two-part clear epoxy coating is mixed 50/50 and is applied as a final coat over paint to totally seal against damage by all soft plastics. Epoxy provides a tough, gloss final finish coat.

Instructions are included. ⚠️



| Item No. | Size     |
|----------|----------|
| 2271     | 2 oz set |
| 2274     | 8 oz set |

## HEAD CEMENT

Fast drying penetrating sealer for holding wrappings on jigs and flies. Dries clear and is waterproof. ⚠️

| Item No. | Size |
|----------|------|
| 2056     | 1 oz |



**SPECIAL SHIPPING NOTICE!** These materials contain flammables and may be shipped only via ground service within continental United States.





## FISHAIR SYNTHETIC HAIR

Synthetic hair of high quality. Slightly textured 50 Denier hair is similar to kip tails, ideal for dressing freshwater jigs. Large 200 Series packages contain plenty of material in 2-1/2" - 3-1/2" lengths. FisHair Colors are locked in and weather resistant. 1 oz. pack. Specify Item Number.



| Color                  | Item No. |
|------------------------|----------|
| White                  | 2021     |
| Fluorescent Yellow     | 2022     |
| Black                  | 2023     |
| Red                    | 2024     |
| Fluorescent Chartreuse | 2025     |
| Fluorescent Lime Green | 2026     |
| Fluorescent Tangerine  | 2027     |
| Brown                  | 2028     |

## BUCKTAIL

The ability of a bucktail jig to take fish is proven time and time again. Specify Item Number. ⚠



| Color              | Item No. |
|--------------------|----------|
| White              | 1944     |
| Yellow             | 1945     |
| Black              | 1946     |
| Red                | 1947     |
| Fluorescent Yellow | 1948     |
| Brown              | 1964     |
| Gray               | 1969     |
| Orange             | 1976     |
| Lt. Blue           | 1977     |
| Royal Blue         | 1978     |
| Fluorescent Green  | 1979     |

## CRAFT FUR

5 inch x 5 inch square of 2.5 to 3 inch fur. The ultimate walleye jig hair. ⚠



| Color      | Item No. | Color       | Item No. |
|------------|----------|-------------|----------|
| Royal Blue | 5700     | Sand        | 5709     |
| Rootbeer   | 5701     | Purple      | 5710     |
| Light Pink | 5702     | Olive       | 5711     |
| Light Blue | 5703     | Gold        | 5712     |
| Brown      | 5704     | Hot Pink    | 5713     |
| Hot Lime   | 5706     | Black Frost | 5714     |
| Black      | 5707     | Fuchsia     | 5715     |
| Red        | 5708     |             |          |

## STREAMER HAIR

6 to 8 inch segments of natural wool. Great for saltwater and freshwater jigs. ⚠

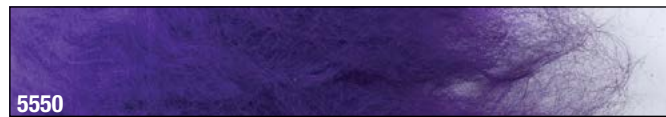

| Color         | Item No. | Color          | Item No. |
|---------------|----------|----------------|----------|
| Purple        | 5550     | Shad Gray      | 5557     |
| White         | 5551     | Red            | 5558     |
| Rust          | 5552     | Burnt Orange   | 5559     |
| FL Yellow     | 5553     | Saltwater Blue | 5560     |
| FL Pink       | 5554     | Dark Brown     | 5561     |
| FL Orange     | 5555     | Yellow         | 5562     |
| FL Chartreuse | 5556     | Black          | 5563     |



## WOOLY BUGGER MARABOU

The softest, fuzziest, densest marabou available. 1/8 oz. per package.

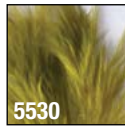
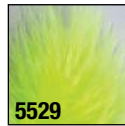
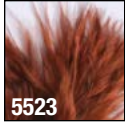

| Color  | Item No. |
|--------|----------|
| White  | 5520     |
| Black  | 5521     |
| Red    | 5522     |
| Brown  | 5523     |
| Yellow | 5524     |
| Purple | 5525     |

| Color         | Item No. |
|---------------|----------|
| Orange        | 5526     |
| FL Pink       | 5527     |
| FL Yellow     | 5528     |
| FL Chartreuse | 5529     |
| Olive         | 5530     |

## BLOOD QUILL MARABOU

The most popular Marabou. This strung marabou is 3.5 to 4.5 inches long and comes in a 1/4 oz. package.

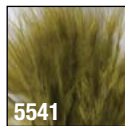
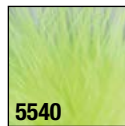
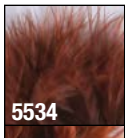
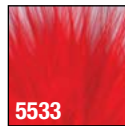
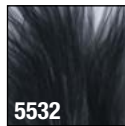

| Color  | Item No. |
|--------|----------|
| White  | 5531     |
| Black  | 5532     |
| Red    | 5533     |
| Brown  | 5534     |
| Yellow | 5535     |
| Purple | 5536     |

| Color         | Item No. |
|---------------|----------|
| Orange        | 5537     |
| FL Pink       | 5538     |
| FL Yellow     | 5539     |
| FL Chartreuse | 5540     |
| Olive         | 5541     |

## KIPTAILS

Create the look the Trout and Steelhead love, or for making small jigs that bring the pan fish flying. Approximately 11 inches long. ⚠

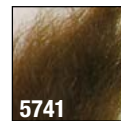
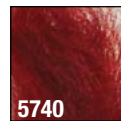
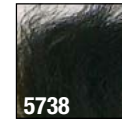
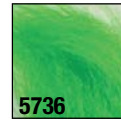
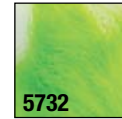

| Color                  | Item No. |
|------------------------|----------|
| White                  | 5730     |
| Fluorescent Blue       | 5731     |
| Fluorescent Chartreuse | 5732     |
| Fluorescent Orange     | 5733     |
| Fluorescent Pink       | 5734     |
| Purple                 | 5735     |
| Fluorescent Green      | 5736     |
| Fluorescent Yellow     | 5737     |
| Black                  | 5738     |
| Fluorescent Red        | 5739     |
| Rootbeer               | 5740     |
| Olive                  | 5741     |



## GLOW FLASH

16 inch strands.



| Color  | Item No. | Color  | Item No. |
|--------|----------|--------|----------|
| White  | 5660     | Blue   | 5663     |
| Yellow | 5661     | Green  | 5664     |
| Pink   | 5662     | Orange | 5665     |

## ROUND FILAMENT RUBBER

Filament rubber. Vivid colors! Round material. 14 foot.

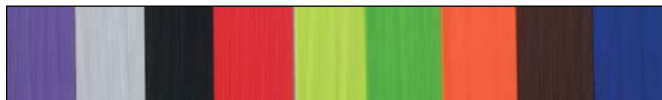

| Color         | Item No. | Color     | Item No. |
|---------------|----------|-----------|----------|
| Purple        | 2630     | FL Lime   | 2636     |
| White         | 2631     | FL Orange | 2637     |
| Black         | 2633     | Brown     | 2638     |
| Red           | 2634     | Blue      | 2639     |
| FL Chartreuse | 2635     |           |          |

## REPTILE RUBBER

Same natural rubber as round filament rubber with a printed texture. Makes beautiful fat skirts. Filament rubber. Vivid colors! Round material. 14 foot.

| Color            | Item No. |
|------------------|----------|
| Brown/Gold       | 7455     |
| Chartreuse/Black | 7456     |
| Red/Black        | 7457     |
| Blue/Black       | 7458     |
| White/Black      | 7459     |
| Lime/Gold        | 7460     |
| Purple/Green     | 7461     |
| Olive/Green      | 7462     |
| Orange/Black     | 7463     |
| Black/Silver     | 7464     |

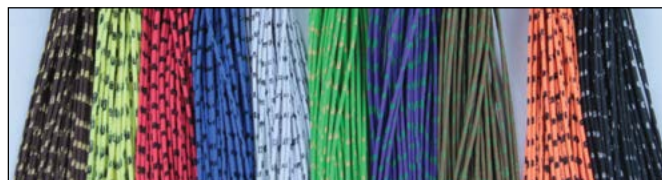

## KRYSTAL FLASH

16 inch strands.



| Color   | Item No. | Color     | Item No. |
|---------|----------|-----------|----------|
| Silver  | 5574     | FL Green  | 5578     |
| White   | 5570     | Blue      | 5579     |
| Junebug | 5571     | Red       | 5580     |
| Green   | 5572     | Tomato    | 5581     |
| Pearl   | 5573     | Purple    | 5582     |
| Fuchsia | 5575     | Copper    | 5583     |
| Teal    | 5576     | FL Yellow | 5584     |
| Gold    | 5577     | FL Orange | 5585     |

## MYLAR FLASH

16 inch strands.

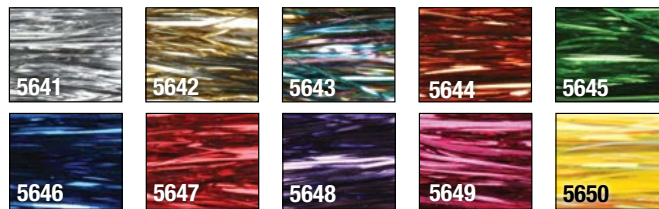

| Color      | Item No. | Color           | Item No. |
|------------|----------|-----------------|----------|
| Pearl      | 5640     | Blue            | 5646     |
| Silver     | 5641     | Red             | 5647     |
| Gold       | 5642     | Purple          | 5648     |
| Rainbow    | 5643     | Fuchsia         | 5649     |
| Copper     | 5644     | FL Yellow Pearl | 5650     |
| Lime Green | 5645     | Black           | 5651     |



## NATURAL IMAGE BANDED SKIRTS

5 Pack.

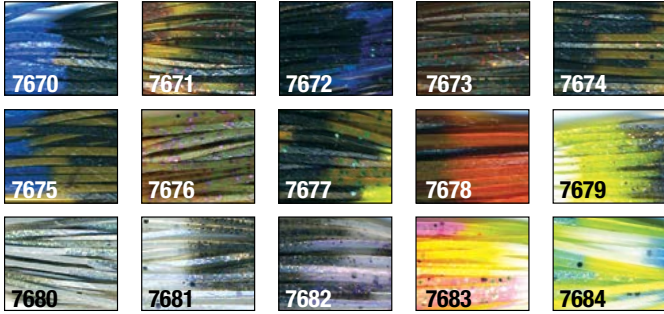

| Color                   | Item No. | Color           | Item No. |
|-------------------------|----------|-----------------|----------|
| Black & Blue            | 7670     | Grasshopper     | 7677     |
| Burnt Pumpkin           | 7671     | Halloween       | 7678     |
| Bruiser                 | 7672     | Chartreuse Chub | 7679     |
| Glitterbug              | 7673     | Green Shiner    | 7680     |
| Camo                    | 7674     | Pearl Shiner    | 7681     |
| Black & Blue Watermelon | 7675     | Purple Shiner   | 7682     |
| Crustacean              | 7676     | Angelfood       | 7683     |
|                         |          | Dorado          | 7684     |

## NATURAL IMAGE SILICONE TABS

10 Pack.

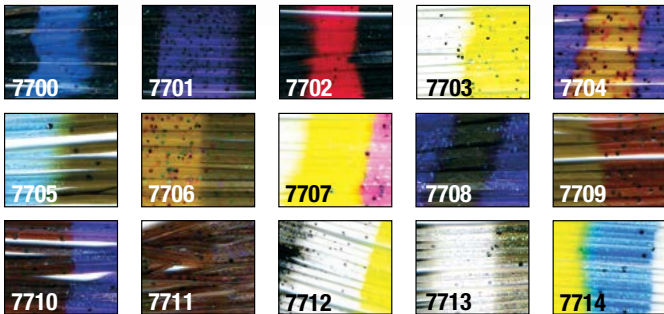

| Color                         | Item No. | Color                  | Item No. |
|-------------------------------|----------|------------------------|----------|
| Black & Blue                  | 7700     | Purple Smoke           | 7708     |
| Black & Purple                | 7701     | Chestnut Green Pumpkin | 7709     |
| Black and Red                 | 7702     | Chestnut Purple        | 7710     |
| Char and White                | 7703     | Evergreen Chestnut     | 7711     |
| PB&J                          | 7704     | Smoke Char White       | 7712     |
| Carolina Blue & Green Pumpkin | 7705     | Green Shad             | 7713     |
| Motor Oil and Green Pumpkin   | 7706     | Dorado                 | 7714     |
| Angel Food                    | 7707     |                        |          |

## BANDED SKIRTS

44 strand skirts in the hottest colors. 5 inches long. Pre-banded for you to slip-on and go. 5 Pack.

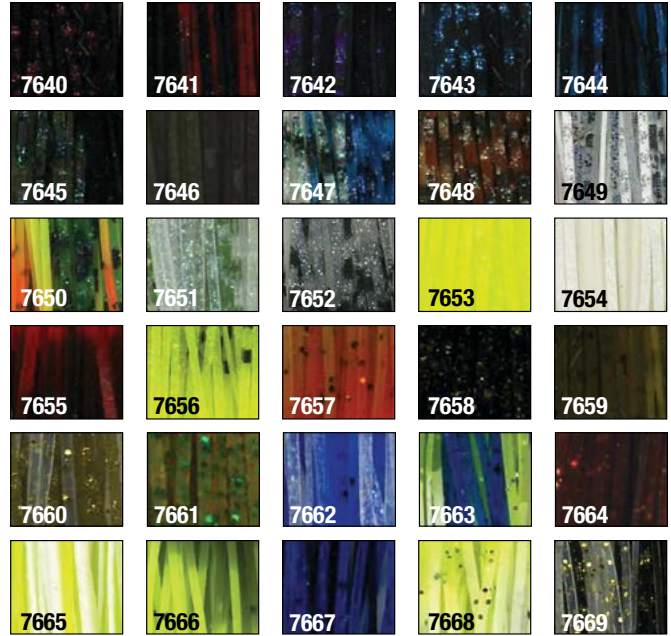

| Color                                      | Item No. | Color                                 | Item No. |
|--|----------|---------------------------------------|----------|
| Black w/ Red Scale                         | 7640     | Pumpkin w/ Orange Tip & Pepper Flake  | 7657     |
| Red w/ Black Scale                         | 7641     | Black w/ Gold Flake                   | 7658     |
| Purple w/ Black Scale                      | 7642     | Watermelon Pumpkin Pepper             | 7659     |
| Black w/ Blue Scale                        | 7643     | Watermelon Pearlescent w/ Gold Flake  | 7660     |
| Blue w/ Black Scale                        | 7644     | Pumpkin w/ Green Flake                | 7661     |
| Smoke w/ Black Scale                       | 7645     | Blue Pearl w/ Holographic Flake       | 7662     |
| Watermelon w/ Chestnut Pepper              | 7646     | Blue White w/ Chartreuse Flake        | 7663     |
| Blue Pearl w/ Black Scale                  | 7647     | Rootbeer w/ Orange Flake              | 7664     |
| Crawfish w/ Black Scale                    | 7648     | White & Chartreuse                    | 7665     |
| White                                      | 7649     | Watermelon Pepper w/ Chartreuse Flake | 7666     |
| Fire Tiger                                 | 7650     | Black & Blue w/ Blue Flake            | 7667     |
| Pearlescent w/ Green Scale                 | 7651     | White w/ Chartreuse Tip & Black Flake | 7668     |
| Pearlescent w/ Black Scale                 | 7652     | Black Pearlescent w/ Gold Scale       | 7669     |
| Chartreuse w/ Gold Flake                   | 7653     |                                       |          |
| Pearlescent White                          | 7654     |                                       |          |
| Black w/ Red Tip & Red Flake               | 7655     |                                       |          |
| Chartreuse w/ Chartreuse Tip & Black Flake | 7656     |                                       |          |



## SLIP-IT SKIRT

Molded Hubs. Easy on – easy off. 70 strands. Natural realistic colors. 3 pack.



| Color              | Item No. | Color        | Item No. |
|--------------------|----------|--------------|----------|
| White Silver Scale | 7470     | Sweet Shad   | 7474     |
| White Chartreuse   | 7471     | Smokey Shad  | 7475     |
| Citrus Punch       | 7472     | Gold Shiner  | 7476     |
| Chartreuse Shad    | 7473     | Black & Blue | 7477     |

## SLIP-IT CRAW SKIRTS

When your jig stops, the claws move up in a life like defensive position. These fat ribbed silicone skirts are welded on an easy on, easy off hub and come in 5 natural colors. 2 Pack.

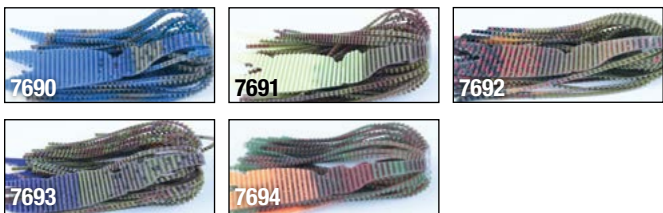

| Color              | Item No. | Color          | Item No. |
|--------------------|----------|----------------|----------|
| Natural Blue       | 7690     | Natural Purple | 7693     |
| Natural Chartreuse | 7691     | Natural Orange | 7694     |
| Natural Red        | 7692     |                |          |

## SKIRT COLLARS

Rubber skirt collars used to make skirts with the Rubber Skirt Factory. Also can be used to hold a trailer hook on a spinner jig.



| Color      | 100 pack | Bulk 1,000 |
|------------|----------|------------|
|            | Item No. | Item No.   |
| Black      | 2291     | 2295       |
| Amber      | 2292     | 2296       |
| White      | 2293     | 2297       |
| Chartreuse | 2294     | 2298       |

## SLIP-IT CURLY TAIL SKIRTS

Slow roll it or burn it, the long curly tail adds to the enticing action of the bait. These 12 realistic silicone color patterns are welded to an easy on or off hub. 2 Pack.



| Color        | Item No. | Color           | Item No. |
|--------------|----------|-----------------|----------|
| Silver Shad  | 7740     | Chartreuse Chub | 7747     |
| Pearl Melon  | 7741     | Crappie         | 7750     |
| Green Shiner | 7743     | Purple Shiner   | 7751     |
| Sweet Shad   | 7744     |                 |          |
| Party Dress  | 7745     |                 |          |

## SLIP-IT PADDLE TAIL SKIRTS

100% silicone skirting material welded to an easy on / easy off hub with paddle tails providing perfect action for swimming or jigging. 12 incredibly life like colors to choose from. 2 Pack.



| Color       | Item No. | Color           | Item No. |
|-------------|----------|-----------------|----------|
| Char Shad   | 7722     | Pearlescent     | 7729     |
| Sunfish     | 7723     | Chartreuse Chub | 7730     |
| Dorado      | 7725     | Purple Shiner   | 7731     |
| Blue Shiner | 7726     |                 |          |
| Circus      | 7728     |                 |          |

## SKIRT TOOL

Do-It's new metal skirt tool allows you to easily assemble your very own silicone skirt combinations to enhance your jigs and spinnerbaits. Create custom colors, save money & catch more fish!

| Item No. |
|----------|
| 7469     |



# SILICONE TABS

Make endless combinations of your own silicone skirts for your custom jigs and baits. 5 inches long, 3/4 of an inch wide, 22 strands. 2 tabs will make an ideal skirt.

## SILICONE TABS-DALMATIAN

10 pack.

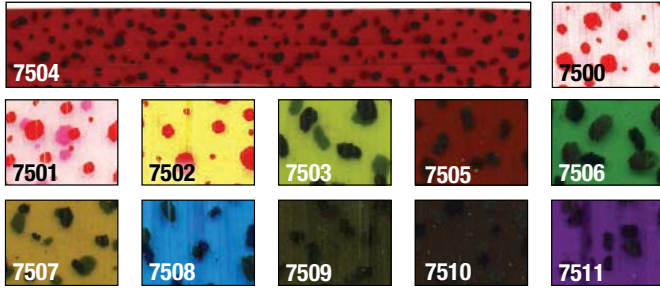

| Color                          | Item No. | Color                    | Item No. |
|--------------------------------|----------|--------------------------|----------|
| White w/ Red Dots              | 7500     | Green w/ Black Dots      | 7506     |
| Pearl w/ Red Dots              | 7501     | Motor Oil w/ Black Dots  | 7507     |
| Yellow Chartreuse w/ Red Dots  | 7502     | Blue w/ Black Dots       | 7508     |
| Green Chartreuse w/ Black Dots | 7503     | Watermelon w/ Black Dots | 7509     |
| Red w/ Black Dots              | 7504     | Chocolate w/ Black Dots  | 7510     |
| Rootbeer w/ Black Dots         | 7505     | Purple w/ Black Dots     | 7511     |

## SILICONE TABS-GLITTER SCALE

10 pack.

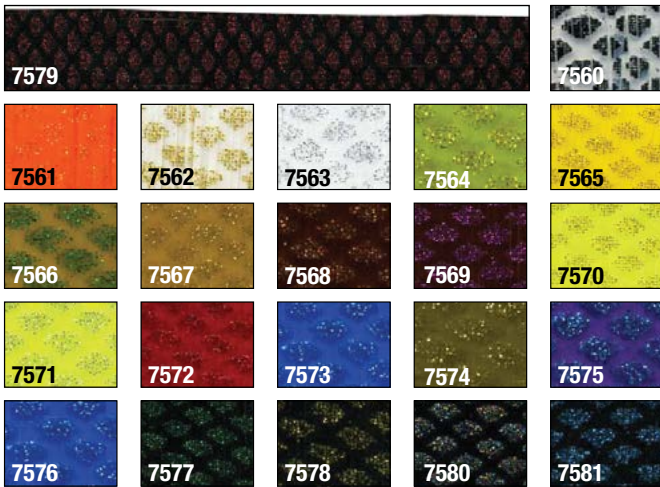

| Color                          | Item No. | Color                      | Item No. |
|--------------------------------|----------|----------------------------|----------|
| Pearlescent w/ Silver Scale    | 7560     | Chartreuse w/ Silver Scale | 7571     |
| Orange w/ Gold Scale           | 7561     | Red w/ Red Scale           | 7572     |
| White w/ Gold Scale            | 7562     | Blue w/ Blue Scale         | 7573     |
| White w/ Silver Scale          | 7563     | Watermelon w/ Gold Scale   | 7574     |
| Green Chartreuse w/ Gold Scale | 7564     | Purple w/ Blue Scale       | 7575     |
| Yellow w/ Gold Scale           | 7565     | Purple w/ Green Scale      | 7576     |
| Pumpkin w/ Green Scale         | 7566     | Black w/ Green Scale       | 7577     |
| Pumpkin w/ Gold Scale          | 7567     | Black w/ Gold Scale        | 7578     |
| Rootbeer w/ Copper Scale       | 7568     | Black w/ Red Scale         | 7579     |
| Rootbeer w/ Purple Scale       | 7569     | Black w/ Holographic Scale | 7580     |
| Chartreuse w/ Gold Scale       | 7570     | Black w/ Blue Scale        | 7581     |

# SILICONE TABS-GLITTER FLAKE

10 pack.



| Color                            | Item No. | Color                                   | Item No. |
|----------------------------------|----------|---|----------|
| Black w/ Red Flake               | 7600     | Pumpkin Pepper w/ Pepper Flake          | 7616     |
| Black w/ Gold Flake              | 7601     | Pearlescent w/ Gold Flake               | 7617     |
| Black w/ Silver Flake            | 7602     | Orange w/ Pepper Flake,                 | 7618     |
| Black w/ Green Flake             | 7603     | Cinnamon w/ Pepper Flake                | 7619     |
| Black w/ Blue Flake              | 7604     | Red w/ Red Flake                        | 7620     |
| Pink                             | 7605     | Chartreuse w/ Green & Pepper Flake      | 7621     |
| White w/ Pepper Flake            | 7606     | Chartreuse w/ Gold Flake                | 7622     |
| White                            | 7607     | Chartreuse                              | 7623     |
| Blue w/ Blue Flake & Pepper      | 7608     | Green Chartreuse w/ Gold & Pepper Flake | 7624     |
| Blue w/ Blue Flake               | 7609     | Lime Green w/ Gold & Pepper Flake       | 7625     |
| Pearlescent w/ Holographic Flake | 7610     | Purple w/ Green Flake                   | 7626     |
| Pearlescent w/ Confetti Flake    | 7611     | Purple w/ Red Flake                     | 7627     |
| Watermelon w/ Pepper Flake       | 7612     | Rootbeer w/ Orange Flake                | 7628     |
| Frog Green w/ Pepper Flake       | 7613     | Chestnut w/ Pepper Flake                | 7629     |
| Evergreen w/ Red Flake           | 7614     |   |          |
| Pumpkin Pepper w/ Green Flake    | 7615     |   |          |



## SILICONE TABS-FIRE TIP

10 pack.

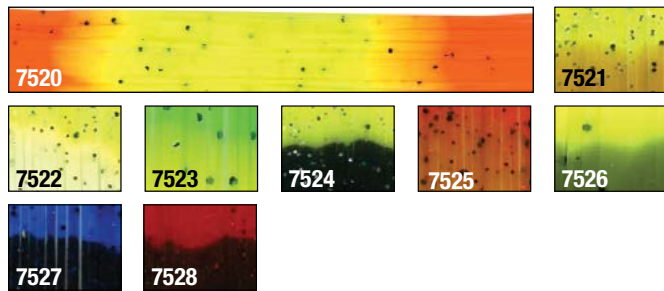

| Color                           | Item No. | Color                        | Item No. |
|---------------------------------|----------|------------------------------|----------|
| Yellow Chartreuse w/ Orange Tip | 7520     | Black w/ Chartreuse Tip,     | 7524     |
| Motor Oil w/ Chartreuse Tip     | 7521     | Motor Oil w/ Orange Tip      | 7525     |
| White w/ Chartreuse Tip         | 7522     | Watermelon w/ Chartreuse Tip | 7526     |
| Yellow Chartreuse w/ Lime Tip   | 7523     | Black w/ Blue Tip            | 7527     |
|                                 |          | Black w/ Red Tip             | 7528     |

## SILICONE TABS-BARBED WIRE

10 pack.

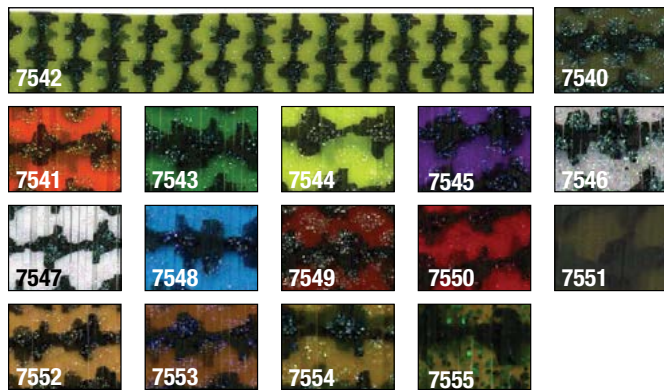

| Color             | Item No. | Color      | Item No. |
|-------------------|----------|------------|----------|
| Smoke             | 7540     | Blue       | 7548     |
| Orange            | 7541     | Rootbeer   | 7549     |
| Green Chartreuse  | 7542     | Red        | 7550     |
| Green             | 7543     | Watermelon | 7551     |
| Yellow Chartreuse | 7544     | Crawfish   | 7552     |
| Purple            | 7545     | Cinnamon   | 7553     |
| Pearlescent       | 7546     | Pumpkin    | 7554     |
| White             | 7547     | Motor Oil  | 7555     |

## NYLON THREAD

Nylon thread for tying and wrapping lures. Each spool contains 40 yards of nylon thread. Spools are made to fit on most fly and lure tying bobbins. Size "A" is a fine diameter thread for wrapping marabou, bucktail and other dressings. Size "E" is a strong, coarse diameter thread used for large jigs or where strength is important. Use size "E" thread to secure Filament Rubber, for saltwater lures, or to custom wrap fishing rods. Packaged in 3 or 12 spools.

| SIZE "A" THREAD | 3 Spool Pkg | 12 Spool Pkg |
|-----------------|-------------|--------------|
| Color           | Item No.    | Item No.     |
| Black           | 2651        | 1931         |
| White           | 2652        | 1932         |
| Red             | 2653        | 1933         |
| Yellow          | 2654        | 1934         |
| SIZE "E" THREAD | 3 Spool Pkg | 12 Spool Pkg |
| Color           | Item No.    | Item No.     |
| Black           | 2281        | 1936         |
| White           | 2282        | 1937         |
| Red             | 2283        | 1938         |



## CHENILLE

The ideal material for tying and finishing jigs. 6 foot segments per pack.



| Color      | Item No. | Color      | Item No. |
|------------|----------|------------|----------|
| Hot Pink   | 5720     | White      | 5725     |
| Hot Yellow | 5721     | Black      | 5726     |
| Hot Orange | 5722     | Red        | 5727     |
| Hot Green  | 5723     | Olive      | 5728     |
| Hot Red    | 5724     | Dark Brown | 5729     |





# FIBERGUARDS

Made of individual strands of nylon bristles, fused together at the base. Be sure to order the exact base diameter specified by each mold. Some base sizes offer a choice of stiffness, that's strictly up to your preference. You'll also notice that Fiberguards are furnished extra long to fit a variety of jig styles and hook sizes. Simply trim Fiberguards with scissors after molding for a final fit.



## FIBERGUARD STIFFNESS RATING GUIDE

- 1 - Very Light      4 - Medium Heavy
- 2 - Light            5 - Heavy
- 3 - Medium          6 - Extra Heavy

### 1/8" BASE DIAMETER 1-3/4" LENGTH (USED WITH MOST DO-IT WEEDLESS JIG MOLDS)

| Size    | Color         | Stiffness Rating | Strand Dia. (approx.) | No. Strands (approx.) | 100 Pack | Bulk 1,000 Pack |
|---------|---------------|------------------|-----------------------|-----------------------|----------|-----------------|
|         |               |                  |                       |                       | Item No. | Item No.        |
| FG-30   | Clear         | 4                | .021                  | 24                    | 1980     | 1981            |
| FG-30B  | Black         | 4                | .021                  | 24                    | 1982     | 1983            |
| FG-30G  | Green Pumpkin | 3                | .018                  | 31                    | 2137     | 2138            |
| FG-30R  | Brown         | 3                | .018                  | 31                    | 2146     | 2147            |
| FG-30X  | Black         | 3                | .018                  | 31                    | 2145     | 2149            |
| FG-30HB | Black         | 5                | .024                  | 20                    | 2124     | 2125            |

### 5/32" BASE DIAMETER 1-3/4" LENGTH (USED ONLY IN MOLDS SPECIFYING FG-40 FIBERGUARDS)

| Size    | Color | Stiffness Rating | Strand Dia. (approx.) | No. Strands (approx.) | 100 Pack | Bulk 1,000 Pack |
|---------|-------|------------------|-----------------------|-----------------------|----------|-----------------|
|         |       |                  |                       |                       | Item No. | Item No.        |
| FG-40B  | Black | 5                | .021                  | 35                    | 1987     | 1988            |
| FG-40HB | Black | 6                | .024                  | 27                    | 2128     | 2129            |

### 5/64" BASE DIAMETER 1-3/8" LENGTH (USED ONLY IN MOLDS SPECIFYING FG-12 FIBERGUARDS)

| Size    | Color | Stiffness Rating | Strand Dia. (approx.) | No. Strands (approx.) | 100 Pack | Bulk 1,000 Pack |
|---------|-------|------------------|-----------------------|-----------------------|----------|-----------------|
|         |       |                  |                       |                       | Item No. | Item No.        |
| FG-12   | Clear | 2                | .018                  | 12                    | 2167     | 2168            |
| FG-12HB | Black | 3                | .024                  | 7                     | 2165     | 2166            |

### 1/16" BASE DIAMETER 7/8" LENGTH (USED ONLY IN MOLDS SPECIFYING FG-9 FIBERGUARDS)

| Size | Color | Stiffness Rating | Strand Dia. (approx.) | No. Strands (approx.) | 100 Pack | Bulk 1,000 Pack |
|------|-------|------------------|-----------------------|-----------------------|----------|-----------------|
|      |       |                  |                       |                       | Item No. | Item No.        |
| FG-9 | Clear | 1                | .015                  | 9                     | 2162     | 2163            |

## WIRE WEEDGUARD

WWG-12

| Item No. | Qty.        |
|----------|-------------|
| 2164     | Pack of 100 |



## HEAT RESISTANT TUBING

This heat and flame resistant tubing placed over a weedguard allows you to effectively powder paint weedless jigs by protecting the fiberguard and minimizing melting or damage to the weedguard.

| Item No. | Qty.      |
|----------|-----------|
| 2711     | Pack of 5 |



## HEAT RESISTANT, NON-STICK BASE HOLE PIN

Pour, paint & bake. Paint and lead will not stick to thin pin.

| Item No. | Qty. |
|----------|------|
| 2712     | 25   |



## RUBBER SKIRT FACTORY

Make your own premium removable rubber skirts for jigs and spinner baits. This kit consists of the spreader clamp tool, clamp holder and 100 assorted skirt collars. Simple and easy-to-understand instructions will have you making premium skirts in a few minutes. Filament rubber and additional skirt collars sold separately. ⚠

| Item No. |
|----------|
| 2116     |



## PRO "AA" VISE

- Easy to operate
- Quick Cam and Collet Clamping
- Adjustable Shank
- Imported from India ⚠

| Item No. |
|----------|
| 1943     |



## DELUXE MASTER VISE

Heavy-duty jaws for large and small hooks

- Rotating jaws
- Adjustable jaw angle
- Heavy-duty cam lever
- Imported from India ⚠

| Item No. |
|----------|
| 2114     |



## "LITTLE BLUE BENDER" SPINNER JIG FORM MAKER

This unusual device bends "R" Eye Spinner Jig and Buzz Spin forms from straight wire shanks up to .041 diameter. Also bends hooks, swivel loops and makes custom bends. ⚠

| Item No. |
|----------|
| 2115     |

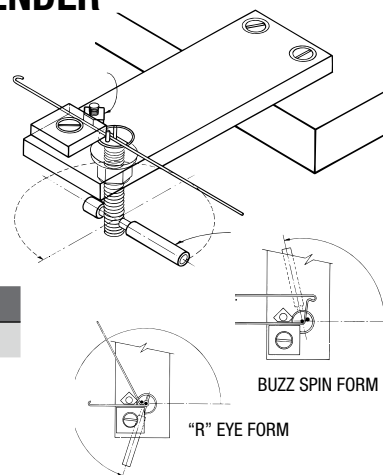

## PROFESSIONAL WIRE FORMER

- Designed for commercial use
- .018 to .041 wire diameter
- 1/8" and 3/16" diameter loop options.  
Components included for both.
- Right or left hand operation
- Anodized machined aluminum construction
- Heavy wear points constructed of heat treated tool steel
- Bench mounting capability ⚠

| Item No. |
|----------|
| 5501     |



## WIRE FORMER MUSKY LURE ADAPTER KIT

This unusual device bends "R" Eye Spinner Jig and Buzz Spin forms. ⚠

| Item No. |
|----------|
| 5502     |

## SCISSORS

These 3-1/2" stainless steel scissors feature fine pointed tips and are ideal for cutting and trimming hair and materials on any jig or lure. Imported.

| Item No. |
|----------|
| 1952     |



## CRIMPING AND CUTTING TOOL

Heavy-duty tool for crimping leader connectors and cutting wire. Chrome plated forged steel with plastic coated handles.

| Item No. |
|----------|
| 2099     |



## O-WACKY TOOL

O-ring tool to Wacky Rig, soft plastic.

| Item No. |
|----------|
| 5484     |



## WACKY "O" RINGS

Replacement "O" rings to Wacky Rig, soft plastics. Pack of 50.

| Size | Item No. |
|------|----------|
| 1/4" | 5485     |
| 3/8" | 5486     |



## XURON SPLIT RING TOOL

Spring loaded, quality tool with a sharp tooth in the upper jaw. If you are attaching many split rings or using small sizes, you'll appreciate the cushioned grip.

| Item No. |
|----------|
| 2105     |



## SPLIT RING PLIERS

An economical tool for spreading the wire of split rings or to open split shot.

| Item No. |
|----------|
| 2100     |



## GROBET ROUND-NOSE PLIERS

A top choice for the professional tackle crafter: 5-1/4" round-nose pliers with plastic coated handles. These pliers use a box joint to retain precise alignment without "wobble." The nose is finely ground for bending loops and coils. Made from hardened steel for added durability.

| Item No. |
|----------|
| 2104     |

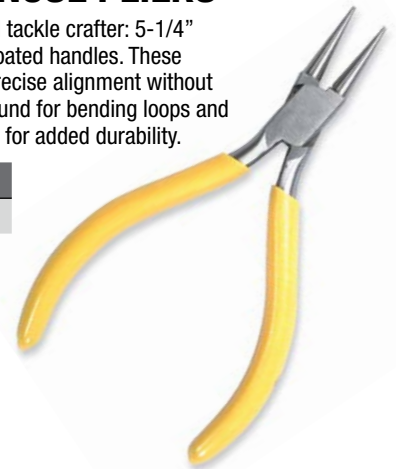

## SPRING WIRE BOBBIN

Super handy. Instant perfect adjustment. Imported. ⚠️

| Item No. |
|----------|
| 1949     |



## EYEBUSTER

This little tool belongs on every tackle maker's work bench and in every fisherman's tackle box. The Eyebuster quickly and efficiently punches paint clogs out of the eyes of hooks on painted lures.

| Item No. |
|----------|
| 2117     |





## LEE PRODUCTION POT IV

An efficient bottom pouring furnace that holds approximately 10 lbs. of lead. Features four inches of clearance under the spout. It is a very good unit for making jigs weighing less than 1/2 oz. and can be used to mold sinkers up to one ounce in size. 500 watts, adjustable heat control, and guaranteed by the manufacturer, LEE PRECISION, for two (2) years. 220V comes without plug.

|             | Item No. |
|-------------|----------|
| 110 Volt AC | 1901     |
| 220 Volt AC | 1896     |



## LEE PRO 4-20, 20 LB. ELECTRIC BOTTOM POUR LEAD MELTER

An affordable large capacity melter that holds 20 pounds of lead in a 4" x 4" I.D. carbon steel pot. Features four inches of clearance beneath the spout, a new micro adjustable flow control valve, and an adjustable mold guide. It uses the patented Lee high-efficiency design with a dependable remote sensing thermostat. The flow valve can be adjusted to pour sinkers of up to 2 and 3 oz. quickly and without wrinkles.

Note: The position of the pour spout underneath this furnace does not make it well suited for bottom pouring spinner jig molds or other molds that require wires to protrude above. 700 watts, adjustable heat control, and guaranteed by the manufacturer, LEE PRECISION Inc., for two (2) years. 220V comes without plug.

|             | Item No. |
|-------------|----------|
| 110 Volt AC | 1894     |
| 220 Volt AC | 1895     |



## LEE PRECISION MELTER

A good little furnace holding 4 lbs. of lead. Melting time is about 15 minutes. Suitable for use with jig, smaller sizes of sinkers and all bullet molds. 500 watts, adjustable heat control, guaranteed by LEE PRECISION for two (2) years. 220V comes without plug.



|             | Item No. |
|-------------|----------|
| 110 Volt AC | 1903     |
| 220 Volt AC | 1899     |

## LEE MAGNUM MELTER, 20 LB. ELECTRIC DIP-OUT MAGNUM MELTER

Ladle pouring can be faster and better than bottom pouring for sinker molds, as well as some jig and lure molds. At last there is an economical high capacity dip out melter available – the 20 pound capacity LEE MAGNUM MELTER. It utilizes the proven Lee high-efficiency design to raise lead to temperature in about 20 minutes from a cold start, holds twenty pounds of lead, and has a calibrated thermostat to maintain proper temperature. The 4" x 4" I.D. carbon steel pot is large enough to work well with the large No. 1905 Cast Iron Ladle. The MAGNUM MELTER is guaranteed by the manufacturer, LEE PRECISION Inc. for two full years. 700 Watts.

|             | Item No. |
|-------------|----------|
| 110 Volt AC | 1890     |



## HOT POT-2

This is an improved version of the traditional "electric ladle." The heating element is now mounted externally to greatly extend element life. The HOT POT-2 both melts and pours lead. An ideal beginners unit since there is nothing else to buy. Features: 3" x 1-3/4", 4 lb. lead capacity cast iron pot, heat resistant plastic handle, metal stand, and three foot cord. 500 Watts, by Palmer Mfg., Inc.

|             | Item No. |
|-------------|----------|
| 120 Volt AC | 1892     |



## LEE INGOT MOLD

This four cavity aluminum ingot mold makes two each 1/2-pound and one-pound ingots. Includes a wooden handle.



| Item No. |
|----------|
| 1893     |

## CAST IRON POT

Large 20-lb. capacity. This 5" diameter cast iron pot holds twice as much metal as the average bullet pot. Recommended for all around use.



| Item No. |
|----------|
| 1904     |

## LARGE CAST IRON POT

Designed to work in conjunction with our Large Ladle (Item No. 1886), this large pot will hold 50 lbs of lead. 8" diameter, 4" depth. Wire handle, pouring lip and tipping handle. Cast iron construction.



| Item No. |
|----------|
| 1887     |

## SMALL STEEL POT & SMALL LADLE

The pot will hold up to 5 lb. of lead and can be used on a variety of heat sources. It has pre-drilled holes to attach a handle if desired. Small sized ladle, perfect for filling smaller cavities. Holds approximately 5 oz. of lead with right and left pouring lips.



|       | Item No. |
|-------|----------|
| Ladle | 1884     |
| Pot   | 1888     |

## CAST IRON LADLE

The 1905 ladle has a 3" diameter cup to hold up to 1-1/2 lbs. of lead and is designed to pour larger cavity molds. The 1911 has a 2-1/2" diameter cup to hold up to 1-1/4 lbs. of lead. The 1911 has a shorter handle design for better agility and ease of pouring. Both models feature left and right pouring lips and are intended for use with the 1904 cast iron pot.



| Diameter | Item No. |
|----------|----------|
| 3"       | 1905     |
| 2-1/2"   | 1911     |

## LARGE LADLE

With the capability of holding 8.5 lbs of lead, this ladle is designed to be utilized for our Downrigger molds. 5" diameter. Steel construction. Right and left pouring lips. 18" handle.



| Item No. |
|----------|
| 1886     |

## CLEAN CAST FLUXING COMPOUND

Fluxing compound will remove sand, dirt, sludge, oxidation and other impurities in your lead which will result in better castings. 1 lb.



| Item No. |
|----------|
| 2269     |

## CASTING RELEASE SPRAY

Release spray will apply a micron-sized graphite coating to the surface of your mold. Even though Do-it Molds do not require a release agent, this product will help the release of the castings in older or modified molds. 6 oz.



| Item No. |
|----------|
| 2270     |

**Flammable. Must ship ground.**



# HAND POURED TACKLE

Lots of tackle in today's world is mass produced by multi-million dollar machines in secret warehouses run by robots in cold far off lands. Not our idea of tackle. When we set out to build the world's finest poured tackle, we didn't have to look very far. These individualized works of art are hand poured

with our molds and are given all the love and attention that you yourself would provide. Maybe you don't have the time to pour, maybe you just like to spend your time painting, whatever the reason, we understand. It's about making something the right way...your way.

## BULLET SPINNERBAIT

Eagle Claw Lazer Sharp Tinned Finish Hooks ⚠

| Item No. | Weight  | Hook Size | Qty    |
|----------|---------|-----------|--------|
| 7327     | 1/4 oz. | 3/0       | 5 pack |
| 7328     | 3/8 oz. | 4/0       | 5 pack |
| 7329     | 1/2 oz. | 4/0       | 5 pack |



## ULTRA MINNOW SPINNER

Eagle Claw Lazer Sharp Tinned Finish Hooks ⚠

| Item No. | Weight  | Hook Size | Qty    |
|----------|---------|-----------|--------|
| 7324     | 1/4 oz. | 3/0       | 5 pack |
| 7325     | 3/8 oz. | 4/0       | 5 pack |
| 7326     | 1/2 oz. | 4/0       | 5 pack |



## BUZZ BAIT

Eagle Claw Lazer Sharp Tinned Finish Hooks ⚠

| Item No. | Weight  | Hook Size | Qty    |
|----------|---------|-----------|--------|
| 7330     | 1/8 oz. | 2/0       | 5 pack |
| 7331     | 1/4 oz. | 3/0       | 5 pack |
| 7332     | 3/8 oz. | 4/0       | 5 pack |



## WEEDLESS FOOTBALL HEAD JIG

Mustad 32798 Black Nickel Flat Eye Ultra Point Hook ⚠

| Item No. | Weight  | Hook Size | Qty    |
|----------|---------|-----------|--------|
| 7315     | 1/4 oz. | 3/0       | 5 pack |
| 7316     | 3/8 oz. | 3/0       | 5 pack |
| 7317     | 1/2 oz. | 4/0       | 5 pack |
| 7318     | 3/4 oz. | 4/0       | 5 pack |
| 7319     | 1 oz.   | 5/0       | 5 pack |



## FOOTBALL HEAD WITH SCREW-LOC

Mustad 32798 Black Nickel Flat Eye Ultra Point Hook ⚠

| Item No. | Weight   | Hook Size | Qty    |
|----------|----------|-----------|--------|
| 7310     | 1/16 oz. | 3/0       | 5 pack |
| 7311     | 1/8 oz.  | 3/0       | 5 pack |
| 7312     | 3/16 oz. | 4/0       | 5 pack |
| 7313     | 1/4 oz.  | 4/0       | 5 pack |
| 7314     | 5/16 oz. | 4/0       | 5 pack |



## SHAKE-IT JIG

Mustad 32798 Black Nickel Flat Eye Ultra Point Hook ⚠

| Item No. | Weight   | Hook Size | Qty    |
|----------|----------|-----------|--------|
| 7300     | 1/16 oz. | 3/0       | 5 pack |
| 7301     | 1/8 oz.  | 3/0       | 5 pack |
| 7302     | 3/16 oz. | 4/0       | 5 pack |
| 7303     | 1/4 oz.  | 4/0       | 5 pack |
| 7304     | 5/16 oz. | 4/0       | 5 pack |



## SHAKE-IT WITH SCREW-LOC

Mustad 32798 Black Nickel Flat Eye Ultra Point Hook ⚠

| Item No. | Weight   | Hook Size | Qty    |
|----------|----------|-----------|--------|
| 7305     | 1/16 oz. | 3/0       | 5 pack |
| 7306     | 1/8 oz.  | 3/0       | 5 pack |
| 7307     | 3/16 oz. | 4/0       | 5 pack |
| 7308     | 1/4 oz.  | 4/0       | 5 pack |
| 7309     | 5/16 oz. | 4/0       | 5 pack |



## WEEDLESS POISON TAIL JIG

Mustad 91768 Black Nickel 60 Degree Wide Gap Ultra Point Hook ⚠

| Item No. | Weight  | Hook Size | Qty    |
|----------|---------|-----------|--------|
| 7320     | 1/8 oz. | 1/0       | 5 pack |
| 7321     | 1/4 oz. | 2/0       | 5 pack |
| 7322     | 3/8 oz. | 3/0       | 5 pack |
| 7323     | 1/2 oz. | 3/0       | 5 pack |



## WEEDLESS CASTING JIG

Mustad 32886 Black Nickel 28 Degree Wide Gap Ultra Point Hook ⚠

| Item No. | Weight   | Hook Size | Qty    |
|----------|----------|-----------|--------|
| 7333     | 1/8 oz.  | 3/0       | 5 pack |
| 7334     | 3/16 oz. | 3/0       | 5 pack |
| 7335     | 1/4 oz.  | 4/0       | 5 pack |
| 7336     | 5/16 oz. | 4/0       | 5 pack |
| 7337     | 3/8 oz.  | 4/0       | 5 pack |
| 7338     | 1/2 oz.  | 5/0       | 5 pack |





# ROUNDHEAD JIG MOLD STARTER KIT

If you are looking to get started in pouring your own Jigs, then this is the kit for you. Included is the extremely popular RHB-7-A, Round Head jig mold with tapered barb collar. This mold allows you to pour 1/32, 1/16, 1/8, 1/4, 5/16, 3/8 and 1/2 jigs. Seventy Aberdeen bend hooks are packaged in quantities of 10 for the different sized cavities in the mold. This kit has a 5 lb. melting pot and 5 oz. pouring ladle, 6 assorted colors of paint (enough for 120 jigs) and 2 paint brushes.

| Item No. |
|----------|
| 2700     |



# EGG SINKER KIT

All the necessary equipment is here to get you started in the tackle craft experience. Included in this kit is the extremely popular Do-it EG-9-A Egg Sinkers. This mold allows you to pour 1/8, 1/4, 3/8, 1/2, 3/4, 7/8, 1, 1-1/2, 2, and 3 ounce egg sinkers. This kit also has a 5 lb. melting pot and a 5 oz. pouring ladle.

| Item No. |
|----------|
| 2702     |



# DO-IT DECAL

Look great wherever you stick them. Weatherproof.

| Size      | Item No. |
|-----------|----------|
| 4" x 6"   | 1950     |
| 16" x 10" | 1968     |



## CS COATINGS DECAL

4 in. x 6 in.

| Size    | Item No. |
|---------|----------|
| 4" x 6" | 1955     |



## DO-IT FISH TOWEL

Microfiber Fishing Towel. 7X the absorbency and 3X the wicking power of cotton. Stain, Odor, and UV-Resistant.

| Size             | Item No. |
|------------------|----------|
| 6" x 18" Trifold | 1824     |



## DO-IT KOOZIE

Nothing is more frustrating than a warm beverage while you are making tackle or fishing. Show your friends that you know how to "Do-It" with this can cooler.

| Item No. | Color  |
|----------|--------|
| 1822     | Black  |
| 1823     | Yellow |





## CUSTOM MADE PREMIUM SHORT SLEEVE CREW

- Fabric laundered
- 4.3 oz., 100% ringspun cotton

| Size | Item No. | Color  |
|------|----------|--------|
| L    | 5756     | Orange |
| XL   | 5757     | Orange |
| XXL  | 5758     | Orange |
| L    | 5759     | Black  |
| XL   | 5760     | Black  |
| XXL  | 5761     | Black  |



## BUILD IT RIGHT PREMIUM SHORT SLEEVE CREW

- Fabric laundered
- 4.3 oz., 100% ringspun cotton

| Size | Item No. | Color        |
|------|----------|--------------|
| L    | 5753     | Heather Grey |
| XL   | 5754     | Heather Grey |
| XXL  | 5755     | Heather Grey |



## CUSTOM MADE ULTIMATE COTTON HOODIE

- 9.7 oz. 90% cotton/10% polyester
- Patented, low pill PrintPro® XP Fleece

| Size | Item No. | Color    |
|------|----------|----------|
| L    | 5762     | Ash      |
| XL   | 5763     | Ash      |
| XXL  | 5764     | Ash      |
| L    | 5765     | Charcoal |
| XL   | 5766     | Charcoal |
| XXL  | 5767     | Charcoal |

## DO-IT STOCKING HAT

Keep your melon warm and still look cool.

| Color | Item No. |
|-------|----------|
| Black | 1967     |







## 1959 PREMIUM SHORT SLEEVE CREW

- Fabric laundered
- 4.3 oz., 100% ringspun cotton

| Size | Item No. | Color      |
|------|----------|------------|
| L    | 5750     | Royal Blue |
| XL   | 5751     | Royal Blue |
| XXL  | 5752     | Royal Blue |



## CUSTOM BAIT'S PREMIUM LONG SLEEVE CREW

- Fabric laundered
- 4.3 oz., 100% ringspun cotton

| Size | Item No. | Color       |
|------|----------|-------------|
| L    | 5768     | Heavy Metal |
| XL   | 5769     | Heavy Metal |
| XXL  | 5770     | Heavy Metal |

## DO-IT HATS

Let everyone know how you do-it. Colors shown left to right.

| Color (shown from left to right) | Item No. |
|----------------------------------|----------|
| Gray & Chartreuse                | 1812     |
| Black                            | 1813     |
| Camo                             | 1814     |
| Black & Gold                     | 1815     |
| Khaki                            | 1816     |
| Blue                             | 1817     |



## THE DO-IT VISOR

Adjustable Hook and Loop Fastener strap with elastic stretch. Khaki with black and silver embroidery. One size fits all

| Color | Item No. |
|-------|----------|
| Khaki | 1929     |



# REPLACEMENT PARTS ⚠

| Item No. | Style No. | Description   |
|----------|-----------|---|
| 1917     | PEG-332   | Pull Pin used in ALL EGG SINKER Molds under 10 oz.    |
| 1918     | PWR-16    | Pull Pin used in all WORM RIG SINKER MOLDS            |
| 1919     | WH-2      | Wooden Handles, 1 pair                                |
| 1920     | B-40      | Blade used in Pinch-On and round Split Shot Molds     |
| 1924     | S-040     | Core Shafts used in Lure Body Mold, Pkg. of 100       |
| 1925     | CP332     | Core Pins used in NO ROLL SINKER Molds, Pkg. of 12    |
| 1928     | PEG-316   | Pull pin used in SINKER Molds, 10 oz. and up          |
| 1990     | BHP-18    | 1/8" BASE HOLE PINS for FG-30 Weedguards, Pkg. of 50  |
| 1995     | BHP-532   | 5/32" BASE HOLE PINS for FG-40 Weedguards, Pkg. of 50 |



**B-40**



**Base Hole Pin  
BHP-18  
BHP-532**

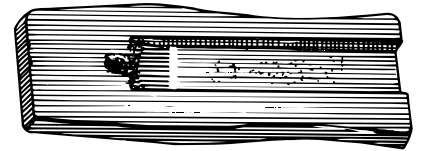

**WH-2**

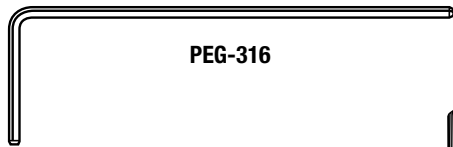

**PEG-316**

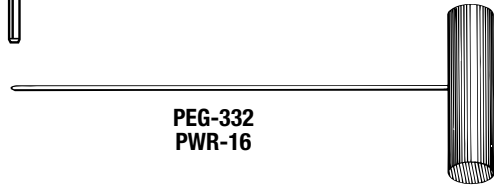

**PEG-332  
PWR-16**



**S-040**



**CP332**



## A WHOLE NEW WORLD OF CUSTOM BAIT OPTIONS

Providing equipment for anglers to make their own soft plastic baits is one of the most exciting developments at Do-it. Whether you are hand pouring into an open mold or injecting into our more sophisticated multi-piece molds, you will be pleased with the quality of your finished bait. We hold ourselves to a higher standard and it will show when you take this bait to the water. Our baits are uniquely designed, carefully scrutinized and tested by Elite Series Tournament Anglers.

With our commitment to provide the best products available, we have designed our own plastic formulas, colorants and additives. These products are custom designed to our standards, and serious fishermen across the globe are turning to Do-it for their soft bait needs.

We encourage you to venture into this area of tackle building. There are many similarities but some critical differences between casting a metal lure and a plastic bait. We encourage you to utilize our resources on this at our website and forum to build your knowledge and comfort level with injecting soft plastics. If you like our classic products you will love our new soft bait products.



### SAMPLE SOFT BAIT

Fish our baits before you buy the mold. You choose any 5 baits you would like included in the sample bag. Most samples are shot in regular formula plastisol with the first available color.

Item No.

91394



### SOFT BAIT MOLDS

Do-it's Soft Bait molds are CNC machined molds cut from bar stock aluminum. We have been making molds for fishing tackle for 55 years. We built our reputation on making the finest quality molding equipment in the industry. Research and development play a critical role in providing our customers with unique and effective baits. Each design goes through a rigorous process involving multiple iterations and testing. Long before you can order one of our molds, they have been fished and approved by our Pro-Staff of elite tournament anglers. Rest assured, if you purchase a Do-it Soft Baits Mold, you have the best the industry can offer.





## BIRCH BUG

This bait is the perfect size for pitching and flipping or if you want to super charge a jig! The Birch Bug has a beaver or bug shaped body, claws and long tentacles. The ribbed body provides a slow fall.

| Item No. | Model No. | Mold Type | Size (in inches) | Cavities |
|----------|-----------|-----------|------------------|----------|
| 95065    | BIR4R01   | Craw      | 3.75             | 1        |
| 95066    | BIR4R02   | Craw      | 3.75             | 2        |
| 95067    | BIR45R01  | Craw      | 4.25             | 1        |
| 95068    | BIR45R02  | Craw      | 4.25             | 2        |



## BIRCH BUG PRO-SERIES

| Item No. | Model No. | Mold Type | Size (in inches) | Cavities |
|----------|-----------|-----------|------------------|----------|
| 95246    | BIR45R06  | Craw      | 4.25             | 6        |

## BUCKY BUG

Similar to the Birch bug, but with a solid body.

| Item No. | Model No. | Mold Type | Size (in inches) | Cavities |
|----------|-----------|-----------|------------------|----------|
| 95069    | BUK4001   | Craw      | 3.75             | 1        |
| 95070    | BUK4002   | Craw      | 3.75             | 2        |
| 95071    | BUK4501   | Craw      | 4.25             | 1        |
| 95072    | BUK4502   | Craw      | 4.25             | 2        |



## CANEY CREEK CRAW

The Caney Creek Craw is an excellent injection mold that has a perfect craw profile from all directions. The subtle action of the claws make it especially productive during cold weather or when fish are a little spooky. The action of this bait is very realistic and is quite different than the "action" style of the Mad Dad craw.

| Item No. | Model No. | Mold Type | Size (in inches) | Cavities |
|----------|-----------|-----------|------------------|----------|
| 95073    | CCC0001   | Craw      | 3.75             | 1        |
| 95074    | CCC4001   | Craw      | 4                | 1        |

Create multi-color craws using the claw mold.



## CRAW CLAWS

The claws are spread apart slightly more and a little more "cup" has been added to the under side. Spice up your craws by adding a little color! (2 complete sets of claws)

| Item No. | Model No. | Mold Type | Size (in inches) | Cavities |
|----------|-----------|-----------|------------------|----------|
| 95023    | CCCC003   | Claw      | 3.75             | 3        |
| 95024    | CCC4C02   | Claw      | 4                | 2        |

## CHERRY PICKER

The Cherry Picker is a realistic creature craw with a ton of action on the fall or setting still. Combining a very realistic appearance in the water, the bug body really slows down the fall while kicking up some dust while hopping it on the bottom. This bait is very productive on the fall, hopping it and swimming it. Best of all is that it works hard for you even when dead stuck.

| Item No. | Model No. | Mold Type | Size (in inches) | Cavities |
|----------|-----------|-----------|------------------|----------|
| 95082    | CP40001   | Craw      | 4                | 1        |

## CHERRY PICKER CLAW

This is a 2 cavity (2 complete sets of claws and tentacles) for the Cherry Picker. This mold can also be used to make a jig trailer. The body is pretty simple, but it would put the claws and tentacles on a jig and provide a smaller profile with the same action as the Cherry Picker.

| Item No. | Model No. | Mold Type | Size (in inches) | Cavities |
|----------|-----------|-----------|------------------|----------|
| 95013    | CPC4002   | Claw      | 4                | 2        |



## MUD BUG

The Mud Bug is a combination “Action” and “Profile” Craw. Combining a very realistic appearance in the water with thickened textured pinchers, and bevels, that cause the claws to shoot out with the slightest pop or slowest retrieve. The movement emulates a natural active, but not overbearing or unrealistic action. Measuring 3.75” the Mud Bug is the perfect size for a numbers bait, or you can bulk it up for a kicker by adding it to a jig. This mold is very easy to inject.

| Item No. | Model No. | Mold Type | Size (in inches) | Cavities |
|----------|-----------|-----------|------------------|----------|
| 95064    | MB37501   | Craw      | 3.75             | 1        |
| 95243    | MB37506   | Craw      | 3.75             | 6        |

## MUD BUG TRAILER

| Item No. | Model No. | Mold Type | Size (in inches) | Cavities |
|----------|-----------|-----------|------------------|----------|
| 95063    | MBC2502   | Craw      | 2.5              | 2        |

## MUD BUG CLAWS

| Item No. | Model No. | Mold Type | Size (in inches) | Cavities |
|----------|-----------|-----------|------------------|----------|
| 95036    | MB375C4   | Claw      | 3.75             | 4        |

## MUD BUG CLAW TIPS

This is a 8 cavity (4 complete sets of claw tips) for the 3.75” Mud Bug. This mold makes perfect tips for your Mud Bugs. They are very easy to make, remove, and place in the Mud Bug mold.

| Item No. | Model No. | Mold Type | Size (in inches) | Cavities |
|----------|-----------|-----------|------------------|----------|
| 95012    | MB375T8   | Tips      | 3.75             | 8        |



Mud Bug



Mud Bug Trailer

## BERRY BUG

The Berry Bug will be one of the most versatile baits you own. With a bug body, hog flappers, and twin c-tails, you can use it as a jig trailer, chatter bait trailer, scrounger trailer, pitch it, flip it, swim it, c-rig it, t-rig it, just about anything you can think of with it. The tails are super active on the fall or retrieve and agitate independent of one another. The flappers displace a lot of water. Even the body has a unique “V” texture that works against the water while retrieving it. If you rig it on its side it has the perfect profile of a small bait fish. Your imagination is the only limitation you will have with this bait.

| Item No. | Model No. | Mold Type | Size (in inches) | Cavities |
|----------|-----------|-----------|------------------|----------|
| 95085    | BBU3501   | Creature  | 3.5              | 1        |
| 95086    | BBU4501   | Creature  | 4.5              | 1        |
| 95087    | BBU4502   | Creature  | 4.5              | 2        |



## BOSS HOG

This bait is great for flipping or you can cut it down and use it as a super trailer. It has large flappers to get their attention and twin C-tails to lure them in. What really sets this bait apart is the ringed body, adding one more water displacing attractor to an already deadly bait.

| Item No. | Model No. | Mold Type | Size (in inches) | Cavities |
|----------|-----------|-----------|------------------|----------|
| 95088    | HOG4501   | Creature  | 4.5              | 1        |
| 95089    | HOG5251   | Creature  | 5.25             | 1        |



## BOSS HOG OPEN POUR

Note: This open pour mold requires advanced skills to effectively pour as it has thin appendages. If you are new to open pours the Mad Dad 4” OP Craw is much easier to learn with.

| Item No. | Model No. | Mold Type          | Size (in inches) | Cavities |
|----------|-----------|--------------------|------------------|----------|
| 95127    | HOG450P   | Hand Pour Creature | 4.5              | 1        |

## MAD DAD CRAW

The Mad Dad Craw is an “action” craw. It provides a realistic profile when pitching, however, the claws flap like crazy on retrieve. If you’re a fan of active craws, you will love the action this bait provides. The 3” version is the perfect size for a jig trailer or smaller fish. Pincher molds for multi-color craws are also available.

| Item No. | Model No. | Mold Type | Size (in inches) | Cavities |
|----------|-----------|-----------|------------------|----------|
| 95075    | MD30001   | Craw      | 3                | 1        |
| 95077    | MD3XL01   | Craw      | 3.5              | 1        |
| 95078    | MD40001   | Craw      | 4                | 1        |
| 95079    | MD50001   | Craw      | 5                | 1        |

## MAD DAD 3XL PRO-SERIES

| Item No. | Model No. | Mold Type | Size (in inches) | Cavities |
|----------|-----------|-----------|------------------|----------|
| 95250    | MD3XL06   | Craw      | 3.5              | 6        |

## MAD DAD CLAWS

Make multi-colored craws with this 4 cavity pincher mold for the Mad Dad.  
4 Cavities (2 Pairs of claws)

| Item No. | Model No. | Mold Type | Size (in inches) | Cavities |
|----------|-----------|-----------|------------------|----------|
| 95031    | MD3C002   | Claw      | 3/3.5            | 4        |
| 95032    | MD4C002   | Claw      | 4                | 4        |
| 95033    | MD5C002   | Claw      | 5                | 4        |

## MAD DAD LAMI PLATE

| Item No. | Model No. | Mold Type  | Size (in inches) | Cavities |
|----------|-----------|------------|------------------|----------|
| 95173    | L3XL01    | Lami Plate | 3.5              | 1        |
| 95264    | LMD4001   | Lami Plate | 4                | 1        |



Create multi-color craws using the claw mold.

## MAD DAD 5 XC

The MD5 XC (Extra Claw) was specifically designed to create extra disruption without increasing the profile of the bait. We created a body similar in size to a 4” craw, but over sized the claws making the profile 4”, while the actual bait is 5”.

| Item No. | Model No. | Mold Type | Size (in inches) | Cavities |
|----------|-----------|-----------|------------------|----------|
| 95080    | MD5XC01   | Craw      | 5                | 1        |

## MAD DAD 5 XC CLAWS

Make multi-colored craws with this 2 cavity pincher mold for the Mad Dad 5XC. The Mad Dad Craw is an “action” craw. It provides a realistic profile when pitching, however, the claws flap like crazy on retrieve. If you’re a fan of active craws, you will love the action this bait provides.

| Item No. | Model No. | Mold Type | Size (in inches) | Cavities |
|----------|-----------|-----------|------------------|----------|
| 95034    | MD5XC02   | Claw      | 4                | 2        |



## MAD DAD CRAW CHUNK

The Mad Dad Craw Chunk is an “action” trailer. It provides a realistic profile when pitching, however, the claws flap like crazy in a tight realistic pattern on retrieve. When sitting on the bottom it stands up in a defensive motion and the claws slowly move like a real craw.

| Item No. | Model No. | Mold Type | Size (in inches) | Cavities |
|----------|-----------|-----------|------------------|----------|
| 95081    | MDCC001   | Craw      | 3                | 1        |



Mad Dad Craw Chunk is an “action” trailer.



## MAD DAD 3 SUPER CHUNK

The Mad Dad 3 Super Chunk is a spin on the original Mad Dad 3. The claws are wider providing more surface area, creating a greater flap and water displacement. We also made them thinner and removed the rib closest to the body to increase the movement of the entire claw. Both the MD3 and the MD3 Super Chunk work great as trailers or by themselves.

| Item No. | Model No. | Mold Type | Size (in inches) | Cavities |
|----------|-----------|-----------|------------------|----------|
| 95076    | MD3SC01   | Craw      | 3                | 1        |



## MD3 SUPER CHUNK CLAWS

| Item No. | Model No. | Mold Type | Size (in inches) | Cavities |
|----------|-----------|-----------|------------------|----------|
| 95035    | MB3SCC4   | Claw      | 3                | 4        |

## MAD DAD OPEN POUR

Very easy to pour. Using an open pour is a great way to do custom work, finish off that last little bit of plastic left in your cup, test new colors, or introduce someone new to pouring their own baits.

| Item No. | Model No. | Mold Type      | Size (in inches) | Cavities |
|----------|-----------|----------------|------------------|----------|
| 95129    | MD3XLOP   | Hand Pour Craw | 3.5              | 1        |
| 95131    | MD4000P   | Hand Pour Craw | 4                | 1        |
| 95132    | MD5000P   | Hand Pour Craw | 5                | 1        |

## MAD DAD 3 SUPER CHUNK OPEN POUR

Very easy to pour, the Mad Dad Craw is an “action” craw. It provides a realistic profile when pitching, however, the claws flap like crazy on retrieve. If you’re a fan of active claws, you will love the action this bait provides. The MD3 SC (Super Chunk) was specifically designed as a jig trailer and has even more claw action than the regular Mad Dad.

| Item No. | Model No. | Mold Type      | Size (in inches) | Cavities |
|----------|-----------|----------------|------------------|----------|
| 95128    | MD3SCOP   | Hand Pour Craw | 3                | 1        |



## MAD DAD 5 XC OPEN POUR

Very easy to pour, the Mad Dad Craw is an “action” craw.

| Item No. | Model No. | Mold Type      | Size (in inches) | Cavities |
|----------|-----------|----------------|------------------|----------|
| 95130    | MD5XCOP   | Hand Pour Craw | 5                | 1        |



## ICRAW

The 3.5” iCraw mold from Do-It Molds gives you the ability to make the most realistic soft plastic craws available on the market. The iCraw’s segmented body is excellent for Texas & Carolina Rigging but also has the bulk that makes the perfect trailer for jigging applications like flipping pitching and punching. Pour it up with Do-It’s Crystal Clear or Essential Series Plastisol and watch it come to life as the craw arms and pincers dance around emulating those of a real craw enticing strikes.

| Item No. | Model No. | Mold Type | Size (in inches) | Cavities |
|----------|-----------|-----------|------------------|----------|
| 95317    | ICRW350   | Injection | 3.5              | 1        |



## DD GILL

The DD Gill (Dying Dinner Gill) is 1" wide at it's widest, .4" thick and has a textured splittable paper thin tail. They eyes are recessed to allow them to be glued or dipped. The small fins flutter on the fall and retrieve. This is a perfect bait to throw into cover (reaction bite), let it fall, hop it back to you - pausing - to pick up the lunker that has been following it. This is a very versatile and lifelike imitation of a dying bait fish. Fish it on a swim bait hook, jig or Texas rigged. We recommend using size 5 or 6 eyes on this bait (see page 77).

| Item No. | Model No. | Mold Type | Size (in inches) | Cavities |
|----------|-----------|-----------|------------------|----------|
| 95095    | 375DDG01  | Creature  | 3.75             | 1        |



## FLIPPIN' HOG

The Flippin' Hog measures approximately 4.25" long and a little over 3/4" wide. The bug style body causes it to fall slowly and the big segmented paddle tail puts off a lot of water. The tail segments are split down the middle allowing you to easily split the tail for an even more erratic presentation.

| Item No. | Model No. | Mold Type | Size (in inches) | Cavities |
|----------|-----------|-----------|------------------|----------|
| 95083    | FLPH4251  | Creature  | 4.25             | 1        |
| 95244    | FLPH42506 | Creature  | 4.25             | 6        |



## FLIPPIN' HOG LAMI PLATE

Plate #95159 will also work with the Flipster.

| Item No. | Model No.  | Mold Type  | Size (in inches) | Cavities |
|----------|------------|------------|------------------|----------|
| 95159    | LFLPH4251  | Lami Plate | 4.25             | 1        |
| 95160    | LFLPH42506 | Lami Plate | 4.25             | 6        |

## FLIPPIN' STICK OPEN POUR

The 6" Flippin' Stick is a 2 cavity mold that produces an incredible flipping bait. The jointed paddle tail flutters on the fall and is even more enticing as it is worked around docks, vegetation, timber or rocks.

| Item No. | Model No. | Mold Type          | Size (in inches) | Cavities |
|----------|-----------|--------------------|------------------|----------|
| 95126    | FS60P02   | Hand Pour Creature | 6                | 2        |



## FLIPPIN' ZIP

The 4" Flippin' Zip body has a unique concave shape that catches water and greatly adds to the erratic action and vibration the bait puts off. Best of all is that it works hard for you even when dead stuck. The bait measures 4" at rest, is 5/8" wide at it's widest, and the ribbing is 1/16".

| Item No. | Model No. | Mold Type | Size (in inches) | Cavities |
|----------|-----------|-----------|------------------|----------|
| 95093    | 4FZIP002  | Creature  | 4                | 2        |



## FLIPSTER

Looking for subtle flipping bait or maybe a jig trailer? Here you are. It has all the goodness of the Flippin' Hog without the extras, just a solid bait with a paddle tail that puts off a lot of water to get some attention. It's a fish catcher plain and simple. The Flippin' Hog Lami plate will work with Flipster also (#95159).

| Item No. | Model No. | Mold Type | Size (in inches) | Cavities |
|----------|-----------|-----------|------------------|----------|
| 95084    | FLP42501  | Creature  | 4.25             | 1        |



## MAYDAY MAYFLY

The diet of an adult pan fish, especially Bluegill and the rest of the Sunfish family, including Crappie, mainly consists of aquatic insect larvae (mayflies, caddisflies, dragonflies). That is the motivation behind the development of this mold. A mayfly larvae imitation it is, and we've made it in a size that fishes nicely and entices bites.

| Item No. | Model No. | Mold Type | Size (in inches) | Cavities |
|----------|-----------|-----------|------------------|----------|
| 95280    | MAY620    | Pan Fish  | 2                | 6        |



## MCGRADY "NEWT"

Grady or "Newt" is specifically designed to target pressured waters and river systems for Black Bass and Small Mouth. The McGrady is great for flipping or you can use it as a trailer. It has large flappers to get their attention and an active C-tail to lure them in. What really sets this bait apart is a very low intimidation factor.

Fish notice it, then eat it, end of story. The McGrady is 3" in the mold, 3.5" on the fall or retrieve.

| Item No. | Model No. | Mold Type | Size (in inches) | Cavities |
|----------|-----------|-----------|------------------|----------|
| 95094    | BOS351U   | Creature  | 3.5              | 1        |



## ZIPPER DROP SHOT WORM

The Zipper Drop Shot Worm "Probie" has a paddle tail and stinger. Overall the worm has a triangular shape so it will always have a flat bottom and angled sides providing great action with little to no rod movement. This is the ultimate in true finesse fishing! Including the length of the stinger this worm measures just under 4". The diameter of the worm is 1/4" at it's widest.

| Item No. | Model No. | Mold Type | Size (in inches) | Cavities |
|----------|-----------|-----------|------------------|----------|
| 95100    | DS37504   | Drop Shot | 3.75             | 4        |

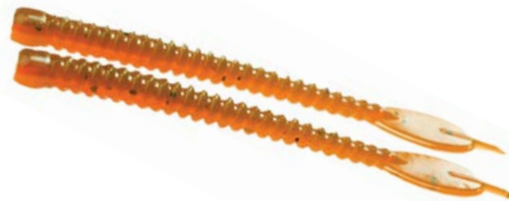

## SLIM DADDY

This is a design that was brought to us by a number of different Elite Series Bass anglers. The Slim Daddy's natural crawdad shape and small size mimics those smaller critters that call the grass mats home. It's slender shape allows it to penetrate heavy cover much easier than larger crawfish imitations allowing you to put the bait where the big ones are. Although he is pretty small in stature, rest assured he's just big enough to handle a 4/0 or 5/0 hook without issue.

| Item No. | Model No. | Mold Type | Size (in inches) | Cavities |
|----------|-----------|-----------|------------------|----------|
| 95272    | SDC235    | Craw      | 3.5              | 2        |



## SLIM DADDY LAMI PLATE

| Item No. | Model No. | Mold Type  | Size (in inches) | Cavities |
|----------|-----------|------------|------------------|----------|
| 95273    | SDC235L   | Lami Plate | 3.5              | 2        |

## FAT FORK

A fat body teamed up with a forked tail gives the all new Fat Fork the profile of a bulky minnow/shiner or small shad. Vertical jigging, drop-shotting, and casting are just a few of the applications where this bait excels. This mold pumps out fish ready fat forks that will match up perfectly with your favorite jigs. Fat Forks are great baits for fishing crappies in a brush pile on a bat jig or on a roundhead jig for spider rigging, not to mention a variety of other species that showed a propensity for the Fat Fork during our extensive testing process. The streamlined forked tail of the bait make it an excellent glider giving a slow fall triggering strikes. Give the fish something they haven't seen before and try out the Fat Fork today!

| Item No. | Model No. | Mold Type  | Size (in inches) | Cavities |
|----------|-----------|------------|------------------|----------|
| 95298    | FF4275    | Grub       | 2.75             | 4        |
| 95299    | FF4275L   | Lami Plate | 2.75             | 4        |
| 95319    | FF240     | Grub       | 4                | 4        |
| 95320    | FF240L    | Lami Plate | 4                | 4        |
| 95321    | FF250     | Grub       | 5                | 4        |
| 95322    | FF250L    | Lami Plate | 5                | 4        |





# CARROT/SKINNY CARROT

## CARROT

The king of versatility, this list of ways this bait can be rigged is endless. Talk about multi species, if it forages on bait fish it will eat THE CARROT. Tail and Laminate Plates are available to help achieve that perfect bait fish imitation. Consider the Carrot as a go to bait if you just want to catch fish.

| Item No. | Model No. | Mold Type | Size (in inches) | Cavities |
|----------|-----------|-----------|------------------|----------|
| 95002    | CAR35010  | Carrot    | 3.5              | 10       |
| 95003    | CAR4004   | Carrot    | 4                | 4        |
| 95004    | CAR4008   | Carrot    | 4                | 8        |
| 95005    | CAR5004   | Carrot    | 5                | 4        |
| 95006    | CAR6004   | Carrot    | 6                | 4        |
| 95007    | CAR7004   | Carrot    | 7                | 4        |



## CARROT PRO-SERIES

| Item No. | Model No. | Mold Type | Size (in inches) | Cavities |
|----------|-----------|-----------|------------------|----------|
| 95247    | CAR4020   | Carrot    | 4                | 20       |



Carrot

## CRAPPIE CARROT

The Crappie Carrot was a collaborative effort with Professional Crappie Fisherman Ted Ellsworth. Specifically designed to target tournament quality Crappie, the Crappie Carrot's size and movement entices fish. Carrot Lami Plates also work for the Crappie Carrot.

| Item No. | Model No. | Mold Type | Size (in inches) | Cavities |
|----------|-----------|-----------|------------------|----------|
| 95049    | CAR25T8   | Carrot    | 1.75             | 12       |
| 95050    | CAR30T8   | Carrot    | 2.25             | 10       |
| 95051    | CAR2508   | Carrot    | 2.5              | 12       |
| 95052    | CAR3008   | Carrot    | 3                | 10       |



Crappie Carrot

## CRAPPIE CARROT PRO-SERIES

| Item No. | Model No. | Mold Type | Size (in inches) | Cavities |
|----------|-----------|-----------|------------------|----------|
| 95249    | CAR3020   | Carrot    | 3                | 20       |

## SKINNY CARROT

Just as versatile as the Carrot but it's been put on a diet. It has that same great Carrot shape but more slender. Rig it anyway you see fit its seductive wiggles and shakes will flat out drive the fish crazy.

| Item No. | Model No. | Mold Type | Size (in inches) | Cavities |
|----------|-----------|-----------|------------------|----------|
| 95061    | CAR3S12   | Carrot    | 3                | 12       |
| 95000    | CAR5S04   | Carrot    | 5                | 4        |
| 95008    | CAR6S04   | Carrot    | 6                | 4        |
| 95001    | CAR7S04   | Carrot    | 7                | 4        |

Skinny Carrot  
Produced utilizing a lami plate

## SKINNY CARROT PRO-SERIES

| Item No. | Model No. | Mold Type | Size (in inches) | Cavities |
|----------|-----------|-----------|------------------|----------|
| 95251    | CAR5S020  | Carrot    | 5                | 20       |
| 95252    | CAR6S020  | Carrot    | 6                | 20       |

## CARROT/SKINNY CARROT LAMI PLATE

Please verify the size and number of cavities in your mold before purchasing a lami plate.

| Item No. | Model No. | Mold Type  | Size (in inches) | Cavities |
|----------|-----------|------------|------------------|----------|
| 95139    | L175CAR   | Lami Plate | 1.75             | 12       |
| 95143    | L225CAR   | Lami Plate | 2.25             | 10       |
| 95145    | L25CAR    | Lami Plate | 2.5              | 12       |
| 95149    | L3CAR     | Lami Plate | 3                | 10       |
| 95151    | LS3CAR    | Lami Plate | 3                | 12       |
| 95152    | LCAR351   | Lami Plate | 3.5              | 1        |
| 95155    | L4CAR4N   | Lami Plate | 4                | 4        |
| 95156    | L4CAR8N   | Lami Plate | 4                | 8        |
| 95165    | LCAR504   | Lami Plate | 5                | 4        |
| 95164    | LCAR5020  | Lami Plate | 5                | 20       |
| 95169    | LCAR6S1X  | Lami Plate | 6                | 4        |
| 95171    | LCAR7     | Lami Plate | 7                | 4        |



## CROSS TAIL CARROT

An amazing drop-shop bait. The cross runs the entire length of the tail giving it one flat side that creates a unique action that triggers a strike. This mold can either be injected or hand poured, and will produce a perfect drop-shot bait in either regular or soft plastic. The 3.5" Cross Tail Carrot is .375" wide at it's widest, the body is 1.8" long and the tail is 1.7" long.

| Item No. | Model No. | Mold Type | Size (in inches) | Cavities |
|----------|-----------|-----------|------------------|----------|
| 95096    | CTC35010  | Carrot    | 3.5              | 10       |

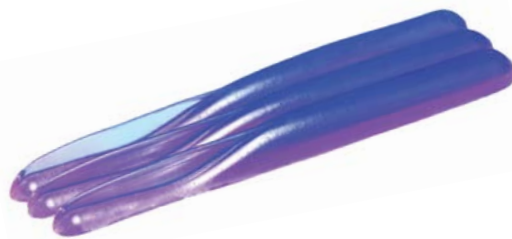

## FINESSE WORM

The name says it all. It's a subtle and delicate worm that coaxes more bites. With a 5/16" diameter it tapers a little more quickly than the Carrots giving it that added wiggle. A perfect bait for drop shot or shaky head presentations it will persuade even the most picky eaters.

| Item No. | Model No. | Mold Type | Size (in inches) | Cavities |
|----------|-----------|-----------|------------------|----------|
| 95213    | FNW35010  | Carrot    | 3.5              | 10       |
| 95214    | FNW4004   | Carrot    | 4                | 4        |
| 95215    | FNW4505   | Carrot    | 4.5              | 5        |
| 95217    | FNW6005   | Carrot    | 6                | 5        |



## FINESSE LAMI PLATE

| Item No. | Model No. | Mold Type  | Size (in inches) | Cavities |
|----------|-----------|------------|------------------|----------|
| 95283    | FWL450    | Lami Plate | 4.5              | 5        |
| 95284    | FWL4001   | Lami Plate | 4                | 4        |

## MIDWEST FINESSE RIG

The Midwest Finesse mold compliments one of our hottest molds, the Midwest Finesse Jig mold. Those of you who have fished the Ned Rig already understand the fish catching command these baits have. They stand up straight when on bottom and several different actions can be achieved by adding softener to these little fish magnets.

| Item No. | Model No. | Mold Type | Size (in inches) | Cavities |
|----------|-----------|-----------|------------------|----------|
| 95326    | MFR827    | Ned Rig   | 2.7              | 8        |



## TOAD STICKER

The Toad Sticker has wicked action with almost no weight or the slightest movement. It was specifically designed for pitching and flipping heavy vegetation and timber. It will collapse down and squeeze through the smallest space and then mushroom into frenzy of action.

| Item No. | Model No. | Mold Type | Size (in inches) | Cavities |
|----------|-----------|-----------|------------------|----------|
| 95092    | TST6001   | Creature  | 6                | 1        |

## TOAD STICKER CLAWS

| Item No. | Model No. | Mold Type | Size (in inches) | Cavities |
|----------|-----------|-----------|------------------|----------|
| 95282    | TSC6002   | Claw      | 6                | 2        |

## LIL' TOAD STICKER

| Item No. | Model No. | Mold Type | Size (in inches) | Cavities |
|----------|-----------|-----------|------------------|----------|
| 95090    | TST4001   | Creature  | 4                | 1        |

## TINY TOAD STICKER

| Item No. | Model No. | Mold Type | Size (in inches) | Cavities |
|----------|-----------|-----------|------------------|----------|
| 95091    | TST3001   | Creature  | 3                | 1        |



## MO MAGIC

There is no doubt that most anyone who has seen or worked with a Carrot mold has thought or commented on its simplistic design and ease of use. Ingenuity however can come from the most interesting places, as a number of us came to realize at this forum's "get together" this past January when one certain member brought with him a Carrot mold that he had modified into one of the most fishable baits any in attendance and seen in a good long while. We would consider it a very versatile bait that will draw any one of a number of species and is made in some sizes that will catch fish. We could not be more pleased and happy for his sharing it with everyone, and at long last, it is now time to release it to the rest of the world... Thank you Mr. Terry



| Item No. | Model No. | Mold Type | Size (in inches) | Body Diameter | Cavities |
|----------|-----------|-----------|------------------|---------------|----------|
| 95277    | MM1225    | Drop Shot | 2.5              | 1/4"          | 12       |
| 95278    | MM1230    | Drop Shot | 3                | 5/16"         | 12       |
| 95279    | MM840     | Drop Shot | 4                | 7/16"         | 8        |
| 95288    | MM460     | Drop Shot | 6                | 1/2"          | 4        |
| 95289    | MM480     | Drop Shot | 8                | 1/2"          | 4        |

## SUPER STINGER

The 3.75" Super Stinger has a diamond shaped stinger tail that tapers to a fine point. The Super Stinger is .3" tall and just under .5" wide at it's belly. The stinger tail provides an extremely enticing action with no rod movement.



| Item No. | Model No. | Mold Type  | Size (in inches) | Cavities |
|----------|-----------|------------|------------------|----------|
| 95097    | SS37505   | Drop Shot  | 3.75             | 5        |
| 95293    | SSL375    | Lami Plate | 3.75             | 5        |

## ZIPPER GOBY

The Zipper Goby body has a unique concave shape that catches water and greatly adds to the erratic action and vibration the bait puts off. The 4" Zipper Goby is just under 4" long and 5/8" wide at it's widest. The ribbing is 1/16".

| Item No. | Model No. | Mold Type | Size (in inches) | Cavities |
|----------|-----------|-----------|------------------|----------|
| 95098    | ZGOBI003  | Drop Shot | 4                | 3        |





# CANEY CREEK CROAKER

This frog is a FREAK. Designed from the ground up, the Caney Creek Croaker is modeled after a boat hull. The front rides very high providing an almost instantaneous pop to the top. The overly round belly prevents roll. If it does somehow get upside down all you have to do is stop your retrieve and it will roll back over. The "rear" of the Croaker models a twin pad design, with a concave section to trap air and increase water agitation while retrieved. The rear also has an even lower section that acts like a rudder, making it run straight, but also creates what would best be described as a subtle chine walk. Overall it produces a true running bait with unique water agitation and sound.

| Item No. | Model No. | Mold Type | Size (in inches) | Cavities |
|----------|-----------|-----------|------------------|----------|
| 95104    | CCF17503  | Frog      | 1.75             | 3        |
| 95101    | CCF3001   | Frog      | 3                | 1        |
| 95102    | CCF3501   | Frog      | 3.5              | 1        |
| 95103    | CCF4001   | Frog      | 4                | 1        |

## CROAKER PRO-SERIES

| Item No. | Model No. | Mold Type | Size (in inches) | Cavities |
|----------|-----------|-----------|------------------|----------|
| 95248    | CCF175020 | Frog      | 1.75             | 20       |

## 4" CROAKER BELLY

To achieve optimum results pour the belly in the Croaker Mold and then inject the Croaker.

| Item No. | Model No. | Mold Type | Size (in inches) | Cavities |
|----------|-----------|-----------|------------------|----------|
| 95014    | CCFB406   | Belly     | 4                | 6        |



Use the Croaker Belly to create a multi-color bait

## BEETLE BUG

The subtle action of this split tail bait is all it takes to bring them out of the cover and make them eat. 1/4" in diameter and 2.25" long it's the perfect size for a variety of species. The tail mold is available for added ease in producing two colored baits.

| Item No. | Model No. | Mold Type | Size (in inches) | Cavities |
|----------|-----------|-----------|------------------|----------|
| 95046    | BBC22510  | Grub      | 2.25             | 10       |

## BEETLE BUG TAIL

| Item No. | Model No. | Mold Type | Size (in inches) | Cavities |
|----------|-----------|-----------|------------------|----------|
| 95022    | BBC22510T | Tail      | 2.25             | 10       |



## CC GLIDER MOLDS

Nothing heats up the pan fish bite like the Glider. Graced with a flappin' paddle tail this little bait will thump them into submission. A variety of fish catching sizes make it a perfect addition to a small jig head. Tail and Laminate plates are available for making eye popping two color baits.

| Item No. | Model No. | Mold Type | Size (in inches) | Cavities |
|----------|-----------|-----------|------------------|----------|
| 95047    | CCG1508   | Grub      | 1.5              | 8        |
| 95048    | CCG2008   | Grub      | 2                | 8        |
| 95121    | CCG3004   | Grub      | 3                | 4        |

## GLIDER TAIL

| Item No. | Model No. | Mold Type | Size (in inches) | Cavities |
|----------|-----------|-----------|------------------|----------|
| 95025    | CCG2T08   | Tail      | 2                | 8        |
| 95011    | CCGT308   | Tail      | 3                | 8        |

## GLIDER LAMI PLATE

| Item No. | Model No. | Mold Type  | Size (in inches) | Cavities |
|----------|-----------|------------|------------------|----------|
| 95150    | LCG0301   | Lami Plate | 3                | 4        |



# CHUB GRUBS

## ST CHUB GRUB

This is a 4 cavity Swimmin' Chub Grub. The thing that sets the ST Grubs apart from other grubs is its versatility. You can swim it at a fast retrieve and really turn some water, or you can use light weight and the tail goes into finesse mode. It works great on the fall with any amount of weight, swimming, or bouncing it off the bottom. This is a serious, big fish, thumpin' grub.

| Item No. | Model No. | Mold Type | Size (in inches) | Cavities |
|----------|-----------|-----------|------------------|----------|
| 95111    | STCG304   | Grub      | 3                | 4        |
| 95116    | STCG404   | Grub      | 4                | 4        |



Split Tail

## TWIN TAIL CHUB GRUB

Your classic twin tail bait used for decades by hard core anglers. The 3" Twin Tail Chub Grub is approximately 3.5" on the fall or retrieve. The body measures just under 1/2" in diameter. The 3.5" Twin Tail Chub Grub is approximately 4" on the fall or retrieve. The body measures a hair over 1/2" in diameter. The 4" Twin Tail Chub Grub is 4.5" - 4.75" on the fall or retrieve.

| Item No. | Model No. | Mold Type | Size (in inches) | Cavities |
|----------|-----------|-----------|------------------|----------|
| 95108    | TTCG302   | Grub      | 3                | 2        |
| 95113    | TTCG351   | Grub      | 3.5              | 1        |
| 95117    | TTCG401   | Grub      | 4                | 1        |



Twin Tail

## CHUB GRUB COMBO

This is a special combo mold that has both the 3" Twin Tail Chub Grub, and the 3" Swimmin' Chub Grub. Both are approximately 3.5" on the fall or retrieve. The body measures just under 1/2" in diameter. If you fish a smaller jig this mold will seriously hook you up.

| Item No. | Model No. | Mold Type | Size (in inches) | Cavities |
|----------|-----------|-----------|------------------|----------|
| 95109    | TTCG301   | Grub      | 3                | 1        |



## K-CHUB

Based on the semi-oval Chub Grub body. While the tail itself is thin and moves easily, it is large with a wide base causing it to really displace water and cause a serious thump.

| Item No. | Model No. | Mold Type | Size (in inches) | Cavities |
|----------|-----------|-----------|------------------|----------|
| 95260    | KGR2506   | Grub      | 2.5              | 6        |
| 95261    | KGR3004   | Grub      | 3                | 4        |
| 95112    | KGR3502   | Grub      | 3.5              | 2        |
| 95262    | KGR4002   | Grub      | 4                | 2        |



## SKIRTED CHUB GRUB

Skirted Chub Grub is the marriage of a Twin Tail Grub with a Skirt. This union provides a great bait for flipping and pitching. The bait can be injected one color, or you can inject the tail color, cut the grub off, and then inject the bait.

If you have one of our molds that already has a skirt (uses a spline) you do not need to buy another one if you don't mind swapping out the tips. The spline can be used in any of the regular skirted molds. If you don't already have a spline (one of our skirted molds), you will need the spline to make the tail (page 132).

| Item No. | Model No. | Mold Type | Size (in inches) | Cavities |
|----------|-----------|-----------|------------------|----------|
| 95110    | SCG301    | Grub      | 3                | 1        |
| 95114    | SCG401    | Grub      | 4                | 1        |



## FLAP JACK

This bait serves it up with all the goodness a hungry pan fish could want. Cunningly subtle it is a no nonsense bait that brings them running. Use the tail mold to create two color offerings that keep them coming back for more.

| Item No. | Model No. | Mold Type | Size (in inches) | Cavities |
|----------|-----------|-----------|------------------|----------|
| 95054    | FJC20010  | Grub      | 2                | 10       |
| 95053    | FJC25010  | Grub      | 2.5              | 10       |



## FLAP JACK TAIL

| Item No. | Model No. | Mold Type | Size (in inches) | Cavities |
|----------|-----------|-----------|------------------|----------|
| 95028    | FJC20010T | Tail      | 2                | 8        |

## GLADE GRUB

The Glade Grub is a twin tail bait specifically designed for working heavy cover like grass, stumps, rocks and around boat docks. The tails are beveled giving it an incredible action on the fall and retrieve, regardless of how fast or slow it is moving. No fish will be able to resist this bait on the fall with super light weight. Recommended as light a weight as the wind, water depth, and your patience will allow. Don't limit this bait to a jig. Fish it on a split shot, Texas rigged, Carolina rigged, or on a drop shot. The bottom line is this is one of those baits that just flat out produces.

| Item No. | Model No. | Mold Type | Size (in inches) | Cavities |
|----------|-----------|-----------|------------------|----------|
| 95118    | GG30002   | Grub      | 3                | 2        |
| 95119    | GG40001   | Grub      | 4                | 1        |
| 95120    | GG40002   | Grub      | 4                | 2        |



## GO-GO GRUB

The shuddering vibration of this grubs tail is the ultimate imitation of a fleeing bait fish. Go-go tail action equals fish feeding reaction plain and simple. The tail mold is available for that added attraction of a two-colored presentation.

| Item No. | Model No. | Mold Type | Size (in inches) | Cavities |
|----------|-----------|-----------|------------------|----------|
| 95055    | GGC2508   | Grub      | 2.5              | 8        |

## GO-GO GRUB TAIL

| Item No. | Model No. | Mold Type | Size (in inches) | Cavities |
|----------|-----------|-----------|------------------|----------|
| 95029    | GGC2508T  | Tail      | 2                | 8        |



## ICE PICK

The Ice Pick is triangle in shape presenting a prismatic effect for your glitter. You can not get the tail to stop quivering. The unique shape of the tail gives it a realistic profile, while also allowing maximum resistance and action from the taper. This bait can be cut down even further for the toughest conditions.

| Item No. | Model No. | Mold Type | Size (in inches) | Cavities |
|----------|-----------|-----------|------------------|----------|
| 95041    | IP10020   | Grub      | 1                | 20       |
| 95039    | IP158012  | Grub      | 1-5/8            | 12       |





## FRY

The Fry is an “action” profile bait with a very unique stinger tail. The tail is triangle shaped tapering from the body to almost nothing. The unique shape of the tail gives it a realistic profile, while also allowing maximum resistance and action from the taper. The Fry is 2.5” long and 1/4” at it’s widest. The body is 1” long and the tail is 1.5” long.

| Item No. | Model No. | Mold Type | Size (in inches) | Cavities |
|----------|-----------|-----------|------------------|----------|
| 95044    | SMF25012  | Grub      | 2.5              | 12       |
| 95239    | SMF25024  | Grub      | 2.5              | 24       |



## FRY LAMI PLATE

| Item No. | Model No. | Mold Type  | Size (in inches) | Cavities |
|----------|-----------|------------|------------------|----------|
| 95146    | L25F      | Lami Plate | 2.5              | 12       |

## NANO FRY

Continuing the success of the Small Fry, Fry and Swim Fry, the Nano Fry measures in at a whopping 1”, but is sure to be a heavyweight when it comes to hitting your favorite fishing hole. The Nano Fry has an “action” shad / fry profile with a very unique stinger tail. The tail is triangle shaped, tapering from the body to almost nothing. The unique shape of the tail gives it a realistic profile, while also allowing maximum resistance and action from the taper. The Nano Fry is 1” long and 3/16” wide.

| Item No. | Model No. | Mold Type | Size (in inches) | Cavities |
|----------|-----------|-----------|------------------|----------|
| 95042    | NFRY1016  | Grub      | 1                | 16       |



## NANO FRY LAMI PLATE

| Item No. | Model No. | Mold Type  | Size (in inches) | Cavities |
|----------|-----------|------------|------------------|----------|
| 95142    | LNF1016   | Lami Plate | 1                | 16       |

## SMALL FRY

The Small Fry is an “action” profile bait with a very unique stinger tail. The tail is triangle shaped tapering from the body to almost nothing. The unique shape of the tail gives it a realistic profile, while also allowing maximum resistance and action from the taper.

| Item No. | Model No. | Mold Type | Size (in inches) | Cavities |
|----------|-----------|-----------|------------------|----------|
| 95040    | SMF17512  | Grub      | 1.75             | 12       |
| 95043    | SMF22512  | Grub      | 2.25             | 12       |



## SMALL FRY LAMI PLATE

| Item No. | Model No. | Mold Type  | Size (in inches) | Cavities |
|----------|-----------|------------|------------------|----------|
| 95140    | LSF1751   | Lami Plate | 1.75             | 12       |
| 95144    | L225SF    | Lami Plate | 2.25             | 12       |



## SMALL FRY PRO-SERIES

| Item No. | Model No. | Mold Type | Size (in inches) | Cavities |
|----------|-----------|-----------|------------------|----------|
| 95238    | SMF17524  | Grub      | 1.75             | 24       |

## SMALL FRY LAMI PLATE PRO-SERIES

| Item No. | Model No. | Mold Type  | Size (in inches) | Cavities |
|----------|-----------|------------|------------------|----------|
| 95141    | LSF17524  | Lami Plate | 1.75             | 24       |

## THE SWIM FRY

The Swim Fry has more wiggle than you can shake a stick at. Combining the proven action of the Go-Go Grub and the profile of the Small Fry, this bait is going to be tough to beat when the fish are active. While the size of this bait makes it a prime candidate for Crappie, the action has already proven itself on everything that swims. A tail mold is also available (Go-Go Grub Tail, see page 115).

| Item No. | Model No. | Mold Type | Size (in inches) | Cavities |
|----------|-----------|-----------|------------------|----------|
| 95058    | SMF2508   | Grub      | 2.5              | 8        |



## SWIM FRY LAMI PLATE

| Item No. | Model No. | Mold Type  | Size (in inches) | Cavities |
|----------|-----------|------------|------------------|----------|
| 95147    | LSF2508   | Lami Plate | 2.5              | 8        |

## SUPER FRY

The Super Fry is definitely a multi-species bait (fish slayer). From bedding Bass to Crappie it has caught fish when traditional baits haven't. Based on shared characteristics of other baits we've designed, this bait is going to be a show stopper for Small Mouth and Walleye as well. It has a triangular shaped stinger tail that tapers to a fine point. The body is 1.5" long, 5/16" wide and 1/2" at the belly. The triangular shaped tail is 5/16" wide, 1/4" thick and tapers to a point. The stinger tail provides an extremely enticing action with no rod movement. Overall the bait has a surprisingly nice glide to it - almost like a small jerk bait.

| Item No. | Model No. | Mold Type | Size (in inches) | Cavities |
|----------|-----------|-----------|------------------|----------|
| 95099    | SF35010   | Grub      | 3.5              | 10       |

## SUPER FRY LAMI PLATE

| Item No. | Model No. | Mold Type  | Size (in inches) | Cavities |
|----------|-----------|------------|------------------|----------|
| 95153    | LSF3510   | Lami Plate | 3.5              | 10       |



## RAD TAD

This aquatic bug imitation gets bit on many occasions simply because it's different. The long slender Y-shaped tail comes alive with the slightest of movements bringing pan fish out of hiding for an easy meal. A tail mold is available for putting the finishing touch on this ultra buggy bait.

| Item No. | Model No. | Mold Type | Size (in inches) | Cavities |
|----------|-----------|-----------|------------------|----------|
| 95056    | RTC2010   | Grub      | 2                | 10       |

## RAD TAD TAIL MOLD

| Item No. | Model No. | Mold Type | Size (in inches) | Cavities |
|----------|-----------|-----------|------------------|----------|
| 95037    | RTC2010T  | Tail      | 2                | 10       |



## SPLIT TAIL

Fat and Sassy, this bait represents an enticing meal for even the most finicky fish. The simple twin tail design gives them that subtle wave they simply cannot endure. Fish it at the full 4" or size it down to match the local forage this is a killer bait for multiple species both fresh and salt water.

| Item No. | Model No. | Mold Type | Size (in inches) | Cavities |
|----------|-----------|-----------|------------------|----------|
| 95115    | STG4003   | Grub      | 4                | 3        |

## SPLIT TAIL LAMI PLATE

| Item No. | Model No. | Mold Type  | Size (in inches) | Cavities |
|----------|-----------|------------|------------------|----------|
| 95157    | LTT403    | Lami Plate | 4                | 3        |



## THUMP GRUB

Our staff has had some good success with this Thump Grub in both fresh and salt water. It's a bait that appeals to multiple species but is without a doubt aimed straight in the face of the Walleye, Smallmouth, and Redfish. The Thump Grub has a relatively subtle thumping action backing it up.

| Item No. | Model No. | Mold Type | Size (in inches) | Cavities |
|----------|-----------|-----------|------------------|----------|
| 95286    | TG515     | Grub      | 1.5              | 5        |
| 95287    | TG425     | Grub      | 2.5              | 4        |
| 95263    | TG335     | Grub      | 3.5              | 3        |



## WUTZ-IT

The Wutz-It is a beast of a bait. It is a Jerk Bait mold with the baits aligned vertically to easily facilitate pouring laminates by hand, then injecting, or with a two color injector. It also has a hook slot and place for eyes. The tail has an incredible subtle action that is sure to trigger strikes. This mold is available with a hook slot, or without. When using it without a hook slot it is normally fished on a jig head with an exposed hook. Please note: With the hook slot this mold takes a medium injector. Without the hook slot it requires the large injector.

| Item No. | Model No. | Mold Type | Size (in inches) | Hook Slot | Cavities |
|----------|-----------|-----------|------------------|-----------|----------|
| 95265    | WUT2512   | Jerk Bait | 2.5              | No        | 12       |
| 95133    | WUT4004H  | Jerk Bait | 4                | Yes       | 4        |
| 95135    | WUT5004H  | Jerk Bait | 5                | Yes       | 4        |
| 95136    | WUT5004   | Jerk Bait | 5                | No        | 4        |
| 95137    | WUT7003H  | Jerk Bait | 7                | Yes       | 3        |
| 95138    | WUT7003   | Jerk Bait | 7                | No        | 3        |

## WUTZ-IT LAMI PLATE

| Item No. | Model No. | Mold Type  | Size (in inches) | Cavities |
|----------|-----------|------------|------------------|----------|
| 95148    | L25001    | Lami Plate | 2.5              | 1        |
| 95158    | LWW401    | Lami Plate | 4                | 1        |
| 95166    | LWT5001   | Lami Plate | 5                | 1        |
| 95172    | LWU701    | Lami Plate | 7                | 1        |



## WUTZ-IT LAMI PRO-SERIES

| Item No. | Model No. | Mold Type | Size (in inches) | Hook Slot | Cavities |
|----------|-----------|-----------|------------------|-----------|----------|
| 95255    | WUT5016H  | Jerk Bait | 5                | Yes       | 16       |
| 95254    | WUT5016   | Jerk Bait | 5                | No        | 16       |
| 95257    | WUT7008H  | Jerk Bait | 7                | Yes       | 8        |
| 95256    | WUT7008   | Jerk Bait | 7                | No        | 8        |



## WUTZ-IT LAMI PLATE PRO

| Item No. | Model No. | Mold Type  | Size (in inches) | Cavities |
|----------|-----------|------------|------------------|----------|
| 95167    | LWT5016   | Lami Plate | 5                | 16       |

## STINGER WUTZ-IT

The Stinger Wutz-It is 2.5" long and .25" wide, and is spot on as a small bait fish. The thin tail never stops moving. The mold is 12 cavities, aligned vertically to make pouring or injecting laminates a snap.

| Item No. | Model No. | Mold Type | Size (in inches) | Cavities |
|----------|-----------|-----------|------------------|----------|
| 95057    | WUTS2512  | Jerk Bait | 2.5              | 12       |





## WUTZ-IT FORKTAIL

A twist on one of our most popular selling soft plastic molds, we've taken the Wutz-It Jerk Bait mold and have opened up the door on versatility with the new Wutz-It Forktail. Available in two sizes the new split tail design gives this bait a great gliding action that perfectly matches a bait fish. These baits roll when snapped or twitched and are great baits for getting reaction strikes out of lethargic fish. Glide it, swim it, snap it, rip it, jerk it, fish it fast, fish it slow, these two new baits are sure to put some serious thump running up your line.



| Item No. | Model No. | Mold Type | Size (in inches) | Cavities |
|----------|-----------|-----------|------------------|----------|
| 95304    | WTZ440    | Jerk Bait | 4                | 4        |
| 95303    | WTZ450    | Jerk Bait | 5                | 4        |

## WUTZ-IT FORKTAIL LAMI PLATE

| Item No. | Model No. | Mold Type  | Size (in inches) | Cavities |
|----------|-----------|------------|------------------|----------|
| 95309    | WTZ440L   | Lami Plate | 4                | 4        |
| 95308    | WTZ450L   | Lami Plate | 5                | 4        |

## LAKE FORK LIZARD

The Lake Fork Lizard is specifically designed to entice Spring and Fall feeding patterns, as well as trigger defensive instincts. It has a curved "W" shaped belly which encourages a gliding motion, while the "C" tail displaces a unique vibration that is bound to draw a fishes attention. The tail is triangle shaped just like a real lizard, and is available ringed or solid. Both have great action.

| Item No. | Model No. | Mold Type | Tail  | Size (in inches) | Cavities |
|----------|-----------|-----------|-------|------------------|----------|
| 95174    | LFL8001   | Lizard    | Solid | 7                | 1        |
| 95175    | LFLR801R  | Lizard    | Ring  | 7                | 1        |
| 95290    | LFL4502   | Lizard    | Solid | 4.5              | 2        |



## THE GARY YAMAMOTO SENKO™

This IS "The Senko" not a knock off as you may find elsewhere. From bow to transom and every little rib in between it is to exact specifications. As we have done in the past, we have teamed up with Gary Yamamoto and he has given us license to manufacture a do it yourself mold to create a bait with the very same specifications as his legendary Senko, one of the most popular soft plastic baits in history.



| Item No. | Model No. | Mold Type | Size (in inches) | Cavities |
|----------|-----------|-----------|------------------|----------|
| 95294    | GYS4004   | Senko     | 4                | 4        |
| 95258    | GYS5004   | Senko     | 5                | 4        |
| 95296    | GYS6004   | Senko     | 6                | 4        |

## GARY YAMAMOTO SENKO™ LAMI PLATE

| Item No. | Model No. | Mold Type  | Size (in inches) | Cavities |
|----------|-----------|------------|------------------|----------|
| 95295    | GYS4004L  | Lami Plate | 4                | 4        |
| 95259    | LGYS5004  | Lami Plate | 5                | 4        |
| 95297    | GYS6004L  | Lami Plate | 6                | 4        |

## SWIM STICK

If you are flipping docks or fishing heavy vegetation the Swim Stick will get into the smallest of places and puts off a great vibration on the fall and retrieve. It should also excel on a drop shot rig.

| Item No. | Model No. | Mold Type | Size (in inches) | Cavities |
|----------|-----------|-----------|------------------|----------|
| 95190    | SMW4003   | Swim Bait | 4                | 3        |
| 95191    | SMW6002   | Swim Bait | 6                | 2        |

## SWIM STICK TAIL MOLD

6" Swim Worm Tail Mold.

| Item No. | Model No. | Mold Type | Size (in inches) | Cavities |
|----------|-----------|-----------|------------------|----------|
| 95019    | SMW6004T  | Tail      | 6                | 4        |

## SWIM STICK LAMI PLATE

| Item No. | Model No. | Mold Type  | Size (in inches) | Cavities |
|----------|-----------|------------|------------------|----------|
| 95170    | LSW6002   | Lami Plate | 6                | 2        |

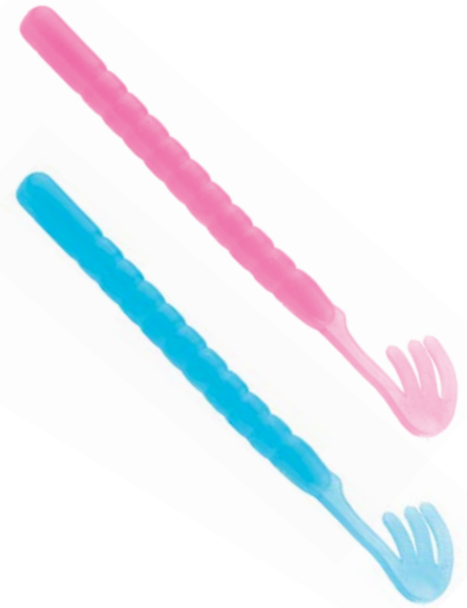

## SMOKIN' SHAD

It has a hook slot and tapers to a traditional swim bait boot tail. They eyes are recessed allowing them to be glued in, or put in place and dipped in clear plastic. The mold is extremely easy to shoot and produces a great bait. The action is awesome. We recommend using size 5 (9/32") eyes on this bait. The 3.75" Smokin' Swim is 5/8" at it's tallest and just under 1/2" at it's widest. The 4.75" Smokin' Shad is 3/4" at it's tallest and just over 1/2" at it's widest.

| Item No. | Model No. | Mold Type | Tail  | Size (in inches) | Cavities |
|----------|-----------|-----------|-------|------------------|----------|
| 95183    | 375SS001  | Swim Bait | Solid | 3.75             | 1        |
| 95188    | 475SS001  | Swim Bait | Ring  | 4.75             | 1        |



Size 5 eyes work great with the Smokin' Shad  
See page 77

## SWIM SHAD

The ultimate in imitating most any bait fish that swims the Swim Shad's thumping tail provides the action and pulse that brings them running for a tasty bite. The original tail puts off a heavier thump and is ideal for a constant retrieve. The thin tail offers that same action even on a slow retrieve and is perfect for a stop and go presentation.

| Item No. | Model No. | Mold Type | Tail     | Size (in inches) | Cavities |
|----------|-----------|-----------|----------|------------------|----------|
| 95181    | SMS3503   | Swim Bait | Original | 3.5              | 3        |
| 95182    | SMS3503   | Swim Bait | Thin     | 3.5              | 3        |
| 95184    | SMS4502   | Swim Bait | Original | 4.5              | 2        |
| 95185    | SMS4502   | Swim Bait | Thin     | 4.5              | 2        |
| 95186    | SMS4504   | Swim Bait | Original | 4.5              | 4        |
| 95187    | SMS4504   | Swim Bait | Thin     | 4.5              | 4        |



Original Tail

## SWIM SHAD PRO-SERIES

| Item No. | Model No. | Mold Type | Tail Type | Size (in inches) | Cavities |
|----------|-----------|-----------|-----------|------------------|----------|
| 95241    | SMS35012  | Swim Bait | Original  | 3.5              | 12       |
| 95242    | SMS35012  | Swim Bait | Thin      | 3.5              | 12       |

## SWIM SHAD LAMI PLATE

| Item No. | Model No. | Mold Type  | Size (in inches) | Cavities |
|----------|-----------|------------|------------------|----------|
| 95154    | LSS37501  | Lami Plate | 3.5              | 3        |
| 95161    | LSS4502   | Lami Plate | 4.5              | 2        |
| 95162    | LSS4504   | Lami Plate | 4.5              | 4        |

## ICE TICKLER

This twenty cavity mold is a smooth shooter and produces 20 1" baits capable of tickling those tight lipped Pannies into biting when other baits won't. The Ice Tickler works excellent on small ice jigs and spoons. Thread the body onto your favorite jig and let the tantalizing tail tickle up big crappies, perch, and gills onto your dinner plate!

| Item No. | Model No. | Mold Type | Size (in inches) | Cavities |
|----------|-----------|-----------|------------------|----------|
| 95301    | LIT201    | Grub      | 1                | 20       |



## WAX WIGGLER

Winter is fast approaching and with several days forecasted in the single digits it's time to start charging batteries, firing up the augers, and pouring up ice plastics. Treat yourself for the holidays with one of our new favorites, the Wax Wiggler. Two sizes in one mold and a total of 40 cavities make injecting a pile of baits fast and easy. The spherical body segments make shortening up your baits a breeze & the tail movement is Off the Hook! no pun intended! The Wax Wiggler is the perfect offering for bluegills and is particularly deadly on crappies!

| Item No. | Model No. | Mold Type | Size (in inches) | Cavities                   |
|----------|-----------|-----------|------------------|----------------------------|
| 95307    | WWLR240   | Grub      | 1.1" & 1.35"     | 40 Total<br>(20 Each Size) |



## SWIM TOAD "BIG FOOT"

The Swim Toad "Big Foot" has great top water action, but really excels flipping and as a Swim Toad. Toss it around the veggies and buzz it in, or let it fall and swim it in. You could catch the fish of a lifetime at any point. And when you do hook-up, there is absolutely no doubt. Bass hit this thing like a sledgehammer and won't let go. For laminates you can hand pour the belly or use a blending block.

| Item No. | Model No. | Mold Type | Size (in inches) | Cavities |
|----------|-----------|-----------|------------------|----------|
| 95105    | TBF3501   | Toad      | 3.5              | 1        |
| 95106    | TBF4001   | Toad      | 4                | 1        |
| 95107    | TBF4501   | Toad      | 4.5              | 1        |



## SWIM TOAD BELLY MOLD

| Item No. | Model No. | Mold Type | Size (in inches) | Cavities |
|----------|-----------|-----------|------------------|----------|
| 95015    | STB4006   | Belly     | 4                | 6        |
| 95016    | STB4506   | Belly     | 4.5              | 6        |

## CRAW TUBE

If you're fishing tubes to mimic Crayfish this might be just the ticket. Fish it like a tube or T-rig it, either way it will make them stand up and take notice. Nobody screams Crayfish like the Craw Tube, and Crayfish are good.

| Item No. | Model No. | Mold Type | Size (in inches) | Insert Size | T-Rig Insert Size | Cavities |
|----------|-----------|-----------|------------------|-------------|-------------------|----------|
| 95210    | TUBC401   | Tube      | 4                | 1-3/4"      | 1-1/2"            | 1        |

Requires a spline and insert, see page 132



## FLIPPIN' GORILLA

The mold is just like our other tube molds, it makes an awesome bait. The spline fits like a glove and there is no flashing. This is a great bed bait, flipping bait, jig trailer, Carolina rig, T-Rig, etc.

| Item No. | Model No. | Mold Type | Size (in inches) | Insert Size | T-Rig Insert Size | Cavities |
|----------|-----------|-----------|------------------|-------------|-------------------|----------|
| 95211    | FLGT4501  | Tube      | 4.5              | 2-1/4"      | 2"                | 1        |

Requires a spline and insert, see page 132





## GORILLA TUBE

This is a great bed bait, flipping bait, jig trailer, Carolina rig, T-Rig, etc. If you haven't fished a tube before this is a great one to start with as it has lots of movement and is very productive using it the same way you would a creature bait. Here's a fishing tip that works great on most tube baits (T-Rig or C-Rig): plug the opening of the tube with a small piece of worm and hold it in place with a toothpick. This will trap the air in the tube and cause it to float off the bottom.

| Item No. | Model No. | Mold Type | Size (in inches) | Insert Size | T-Rig Insert Size | Cavities |
|----------|-----------|-----------|------------------|-------------|-------------------|----------|
| 95192    | GRT4001   | Tube      | 3-4              | 1-3/4"      | 1-1/2"            | 1        |
| 95212    | GRT4501   | Tube      | 4.5              | 2-1/4"      | 2                 | 1        |

Requires a spline and insert, see page 132



## G-TUBE

He's a fatty... or is he? Larger ribs and a full head size make this a solid contender for double (or triple) dipping into some awesome fish catching goodness. It also catches fish as is. It's a firm contender and a very versatile tube in a good fish catching size.

| Item No. | Model No. | Mold Type | Size (in inches) | Insert Size | T-Rig Insert Size | Cavities |
|----------|-----------|-----------|------------------|-------------|-------------------|----------|
| 95195    | TUBG401   | Tube      | 4                | 1-3/4"      | 1-1/2"            | 1        |

Requires a spline and insert, see page 132



## SKIRT MOLD

This mold makes a 5" skirt that can be attached to any bait (5" diameter / 2.25" hanging). This mold uses the same spline as all of our skirted molds use. You just inject the skirt, remove the spline, trim the sprue off and place it in the Tube or Chub Grub mold as an example. This is a really easy and fast way to make skirted baits that are different colors and minimize time and reheats.

| Item No. | Model No. | Mold Type | Size (in inches) | Cavities |
|----------|-----------|-----------|------------------|----------|
| 95209    | SKT5001   | Tube      | 5                | 1        |

Requires a spline, see page 132



## SUPER SMOOTHY TUBE

The Smoothy Tube is everything "tube" in a moderately slimmer and sleek profile. It's not quite as bulky as many tubes and is popular with Smallmouth, Large Mouth, Crappie and Walleye too, it will allow you to finesse a number of species in for a closer look.

| Item No. | Model No. | Mold Type | Size (in inches) | Insert Size | T-Rig Insert Size | Cavities |
|----------|-----------|-----------|------------------|-------------|-------------------|----------|
| 95193    | TUBS301   | Tube      | 3                | 1-1/4"      | 1"                | 1        |
| 95281    | TUBS351   | Tube      | 3.5              | 1-1/2"      | 1-1/4"            | 1        |
| 95196    | TUBS401   | Tube      | 4                | 1-3/4"      | 1-1/2"            | 1        |

Requires a spline and insert, see page 132



## TUBE

These tubes are just slightly longer and bigger than their Smooth Tube cousins giving them just a little more bulk for those fish that are looking for a full dinner plate. Feel like making them bigger.....dip them again....adding more to the table.

| Item No. | Model No. | Mold Type | Size (in inches) | Insert Size | T-Rig Insert Size | Cavities |
|----------|-----------|-----------|------------------|-------------|-------------------|----------|
| 95194    | TUB3501   | Tube      | 3.5              | 1-1/4"      | 1"                | 1        |
| 95197    | TUB4501   | Tube      | 4.5              | 2-1/4"      | 2"                | 1        |

Requires a spline and insert, see page 132



## ZIPPER TUBE

This tube bait is designed specifically for bed fishing. Heavily ribbed with tantalizing tentacles, this bait will be hard for any Bass to ignore. The spline fits like a glove and there is no flashing. Add a touch of softener or worm oil to the insert and it slides right off. The head is smooth for easy dipping and the body has a very small scallop.

| Item No. | Model No. | Mold Type | Size (in inches) | Insert Size | T-Rig Insert Size | Cavities |
|----------|-----------|-----------|------------------|-------------|-------------------|----------|
| 95198    | TZL4501   | Tube      | 4.5              | 2-1/4"      | 2"                | 1        |

Requires a spline and insert, see page 132



## C-TAIL WORM

Our C-Tail worm might just have the most elegant action of any worm ever. The tail on this worm moves effortlessly, and looks like a ribbon in the wind - with practically no weight. The head of the worm was designed to protect your knot from the weight, there is plenty of worm for your hook to Texas rig. There's also a nice sized egg sack, followed by a tight body that really moves with the lightest movement or current.

| Item No. | Model No. | Mold Type | Size (in inches) | Cavities |
|----------|-----------|-----------|------------------|----------|
| 95225    | WCTL804   | Worm      | 8                | 4        |



## C-TAIL TAIL

This is a universal c-tail, fitting other sizes (when it makes sense) as well.

| Item No. | Model No. | Mold Type | Size (in inches) | Cavities |
|----------|-----------|-----------|------------------|----------|
| 95026    | WCTLT04   | Tail      | 8                | 4        |

## CRAW WORM

Measuring 5" with a flat bottom and small pincher like tail, the crawl worm is the perfect size for pressured waters. The flat bottom gives it a slow erratic fall on a shaky head or wacky rigged.

| Item No. | Model No. | Mold Type | Size (in inches) | Cavities |
|----------|-----------|-----------|------------------|----------|
| 95226    | CRW004    | Worm      | 5                | 4        |

## CRAW WORM LAMI PLATE

| Item No. | Model No. | Mold Type  | Size (in inches) | Cavities |
|----------|-----------|------------|------------------|----------|
| 95168    | LCW004    | Lami Plate | 5                | 4        |



## RIBBED RIBBON TAIL WORM

It's the same proven design of the ribbon tail worm with the added enticement and bulk of a ringed body that not only helps to conceal the hook but captures tiny air bubbles for a natural breathing action. Aside from giving the bait a bulkier appearance without the additional weight, the ribs displace a significant amount of water, creating a bigger disturbance below the surface and attracting fish from greater distances.

| Item No. | Model No. | Mold Type | Size (in inches) | Cavities |
|----------|-----------|-----------|------------------|----------|
| 95237    | RTW6506   | Worm      | 6.5              | 6        |
| 95232    | RRTW702   | Worm      | 7                | 2        |
| 95227    | RRTW101   | Worm      | 10               | 1        |



## EL GUSANO

El Gusano is a pretty straight forward worm designed to coax a difficult bite into happening. The front half of the worm is round then transitions to a flat tail section. Perfect for drop shot or shakey head presentations. These worms will boost your percentages with out a doubt.

| Item No. | Model No. | Mold Type | Size (in inches) | Cavities |
|----------|-----------|-----------|------------------|----------|
| 95266    | ELG345    | Drop Shot | 4.5              | 3        |
| 95268    | ELG360    | Drop Shot | 6                | 3        |



## EL GUSANO LAMI PLATE

| Item No. | Model No. | Mold Type  | Size (in inches) | Cavities |
|----------|-----------|------------|------------------|----------|
| 95267    | ELG345L   | Lami Plate | 4.5              | 3        |
| 95269    | ELG360L   | Lami Plate | 6                | 3        |

## DRAGON TAIL FINESSE WORM

The Finesse Dragon Tail Worm is 5/16" in diameter and has a very fast taper. The totally unique tail provides resistance in all directions making the worm really move. It works great on a drop shot, Wacky rigged, Texas rigged weightless or with a small split shot.

| Item No. | Model No. | Mold Type | Size (in inches) | Cavities |
|----------|-----------|-----------|------------------|----------|
| 95218    | 45DTW004  | Worm      | 4.5              | 4        |
| 95219    | FNDT6004  | Worm      | 6                | 4        |



## DRAGON TAIL TAILS

Tail Mold for the 4.5" and 6" Dragon Tail. 8 cavity injection mold.

| Item No. | Model No. | Mold Type | Size (in inches) | Cavities |
|----------|-----------|-----------|------------------|----------|
| 95027    | DTT08     | Tail      | 4.5 or 6         | 8        |



## FREEDOM FRY

The Freedom Fry is a mold that produces a bait that looks as good as it fishes. This bait is very versatile: Texas Rig, Carolina Rig, Shaky Head, or Wacky. The flat bottom produces a slow enticing fall. This is a great mold that is very easy to make lots of baits in a short period of time.

| Item No. | Model No. | Mold Type | Size (in inches) | Cavities |
|----------|-----------|-----------|------------------|----------|
| 95220    | FF4004    | Worm      | 3.85             | 4        |
| 95216    | FF5004    | Worm      | 4.85             | 4        |

## FREEDOM FRY LAMI PLATE

| Item No. | Model No. | Mold Type  | Size (in inches) | Cavities |
|----------|-----------|------------|------------------|----------|
| 95285    | FFL3851   | Lami Plate | 3.85             | 4        |
| 95163    | LFF401    | Lami Plate | 4.85             | 4        |



## FREEDOM FRY OPEN POUR

This is a great open pour mold that is very easy to hand pour, or you can use a small injector to fill the cavities.

| Item No. | Model No. | Mold Type | Size (in inches) | Cavities |
|----------|-----------|-----------|------------------|----------|
| 95124    | FF4050P   | Hand Pour | 3.85             | 5        |
| 95125    | FF5050P   | Hand Pour | 4.85             | 5        |



## RIBBON TAIL WORM

The classic ribbon tail design has long been the staple for tournament pros wanting to put a kicker fish in the live well. These worms deliver an enticing swimming action when retrieved or on the fall and the tail moves effortlessly with practically no weight and at the slowest retrieval speeds. It's a tantalizing motion that they just can't resist.

| Item No. | Model No. | Mold Type | Size (in inches) | Cavities |
|----------|-----------|-----------|------------------|----------|
| 95221    | RTW4752   | Worm      | 4.75             | 2        |
| 95233    | RTW702    | Worm      | 7                | 2        |
| 95234    | RTW0902   | Worm      | 9                | 2        |
| 95228    | RTW1001   | Worm      | 10               | 1        |
| 95229    | RTW1052   | Worm      | 10.5             | 2        |
| 95230    | RTW1202   | Worm      | 12               | 2        |
| 95231    | RTW1402   | Worm      | 14               | 2        |



## RIBBON TAIL WORM PRO-SERIES

| Item No. | Model No. | Mold Type | Size (in inches) | Cavities |
|----------|-----------|-----------|------------------|----------|
| 95245    | RTW4756   | Worm      | 4.75             | 6        |

## RIBBON TAIL WORM TAIL MOLD

| Item No. | Model No. | Mold Type | Size (in inches) | Cavities |
|----------|-----------|-----------|------------------|----------|
| 95017    | RTWT4752  | Tail      | 4.75             | 2        |
| 95021    | RRTW702   | Tail      | 7                | 2        |
| 95009    | RRTW102   | Tail      | 10               | 2        |

## RING-IT WORM

This 4.5" Ring-it Worm measures 4.5 swimming and 3.85 in the mold. The smaller diameter core is ringed with 3/8" diameter rings giving this worm plenty of movement for a shorter worm. The 6" measures 6" swimming and 5.35 in the mold. It's core is ringed with 7/16" diameter rings. "Slinky" is a good way to describe the action of the 6" worm. Both of these worms are backed up by the subtle ring type tail adding some enticing action to the presentation. Both sizes are wonderful baits for Finesse Jigging or Dropshot fishing Walleye, Smallmouth or Largemouth.

| Item No. | Model No. | Mold Type | Size (in inches) | Cavities |
|----------|-----------|-----------|------------------|----------|
| 95270    | RIW245    | Worm      | 4.5              | 2        |
| 95271    | RIW260    | Worm      | 6                | 2        |

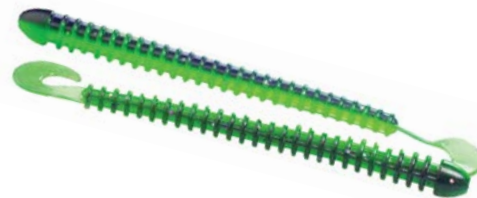

## STUMP THUMPER

The 12" "Stump Thumper" measures 10" in the mold, 12" on the fall. It is a big worm with a thick tail that is really a hybrid between a "C" tail and a "U" tail. It really puts off some serious vibrations under water. You can experiment with your plastic hardness and get more of a finesse presentation, or a serious thump out of this worm. This mold is available as an injection or open pour mold.

| Item No. | Model No. | Mold Type | Size (in inches) | Cavities |
|----------|-----------|-----------|------------------|----------|
| 95224    | WMC12001  | Worm      | 12               | 1        |

## 12" STUMP THUMPER TAIL

| Item No. | Model No. | Mold Type | Size (in inches) | Cavities |
|----------|-----------|-----------|------------------|----------|
| 95010    | WMCT1201  | Tail      | 12               | 2        |

## STUMP THUMPER OPEN POUR

| Item No. | Model No. | Mold Type      | Size (in inches) | Cavities |
|----------|-----------|----------------|------------------|----------|
| 95122    | WMCOP01   | Hand Pour Worm | 12               | 1        |



## SPEAR TAIL WORM

This is a great bait that has an incredible subtle action. The head of the worm was designed to protect your knot from the weight, there is plenty of worm for your hook to Texas rig. There's also a nice sized egg sack, followed by a tight body that really moves with the lightest movement or current. The spear tail provides nice resistance and plenty of water displacement.

| Item No. | Model No. | Mold Type | Size (in inches) | Cavities |
|----------|-----------|-----------|------------------|----------|
| 95222    | WSP6005   | Worm      | 6                | 5        |
| 95236    | WSP7004   | Worm      | 7                | 4        |



## SPEAR TAIL TAIL

This is a universal spear tail, fitting other sizes (when it makes sense) as well.

| Item No. | Model No. | Mold Type | Size (in inches) | Cavities |
|----------|-----------|-----------|------------------|----------|
| 95038    | WSP7T08   | Tail      | 7                | 8        |

## TAPERED TROUT / FINESSE WORM

The Trout / Finesse Worm is 3" long and .19" in diameter, tapering to .12". This mold shoots super easy and makes perfect worms every time. Besides making a great Trout worm, it also makes a great smaller Bass bait: Wacky or Drop Shot. Pan Fish love it also. It is a super solid all around bait.

| Item No. | Model No. | Mold Type | Size (in inches) | Cavities |
|----------|-----------|-----------|------------------|----------|
| 95062    | TRT03010  | Worm      | 3                | 10       |
| 95240    | TRT03040  | Worm      | 3                | 40       |



## TUBE WORM

The 6.75" tube worm makes an awesome bait, every time. The spline fits like a glove and there is no flashing. Add a touch of softener or worm oil to the insert and it slides right off. The head is smooth for easy dipping and the body has a very small scallop.

If you have one of our molds that already has a skirt (uses a spline) you do not need to buy another one if you don't mind swapping out the tips. The spline can be used in any of the regular skirted molds. If you don't already have a spline (one of our skirted molds), you will need the spline to make the tail (page 132).

| Item No. | Model No. | Mold Type | Size (in inches) | Cavities |
|----------|-----------|-----------|------------------|----------|
| 95223    | TUB6751   | Worm      | 6.75             | 1        |



## THUMPER SWIM FRY

The Thumper Fry is a 2" paddle tail swim bait. The body is 1" long, .25" wide and .35" tall. The tail is 1" long including the paddle. The bait is set vertically in the mold to allow easy laminates. \*Please note, to get this mold to shoot / vent properly a small tag needed to be added to the tail. It is very small (.01) and easily removed.

| Item No. | Model No. | Mold Type | Size (in inches) | Cavities |
|----------|-----------|-----------|------------------|----------|
| 95059    | TFRY210   | Worm      | 2                | 10       |
| 95253    | TFRY220   | Worm      | 2                | 20       |



## TROUT WORM

The epitome of simplicity the Trout Worm is 2.95" in length and .18" in diameter. A super all around bait not only for Trout but Pan Fish love it too. Simple and effective for a variety of species.

| Item No. | Model No. | Mold Type | Size (in inches) | Cavities |
|----------|-----------|-----------|------------------|----------|
| 95045    | TRT29520  | Worm      | 2.95             | 20       |



## WACKM' WORM

At it's biggest and baddest, this worm measures a whopping 13". While that may seem like too much worm for most applications, fish it and you'll see it's not only not too much worm, but championships are being won on it. The Wackm' Multi Worm is a 2 cavity mold that produces 4 different size worms.

| Item No. | Model No. | Mold Type | Size (in inches) | Cavities |
|----------|-----------|-----------|------------------|----------|
| 95235    | WWM1301   | Worm      | 13               | 2        |



## WACKM' WORM OPEN POUR

| Item No. | Model No. | Mold Type      | Size (in inches) | Cavities |
|----------|-----------|----------------|------------------|----------|
| 95123    | WWOP132   | Hand Pour Worm | 13               | 2        |

## HELLGY

Hellgrammites (the larvae of the Dobsonfly) are largely aquatic creatures that spend their time along the rocky bottoms of streams and creeks. Hellgrammites have long been a choice bait for smallmouth fishermen and trout fishermen alike. It was with that in mind along with input/demand from our customers that we produced this pair of molds to compliment those needs.

| Item No. | Model No. | Mold Type | Size (in inches) | Cavities |
|----------|-----------|-----------|------------------|----------|
| 95291    | HLG2225   | Creature  | 2.25             | 2        |
| 95292    | HLG230    | Creature  | 3                | 2        |



## RIPPER

With an excellent swimming style action that has great side-to-side "wiggling" movement when retrieved both fast or slow, the Ripper's ribbed body and boot style tail make it a super bait for fishing in all bodies of water.

| Item No. | Model No. | Mold Type | Size (in inches) | Cavities |
|----------|-----------|-----------|------------------|----------|
| 95323    | RPR135    | Swimbait  | 3.5              | 1        |
| 95324    | RPR130    | Swimbait  | 3                | 1        |
| 95325    | RPR140    | Swimbait  | 4                | 1        |
| 95302    | RPR2250   | Swimbait  | 2.5              | 2        |
| 95329    | RPR220    | Swimbait  | 2                | 3        |
| 95328    | RPR160    | Swimbait  | 6                | 1        |



## TANGO TUBE

Introducing the new 4" Tango Tube. This single cavity tube mold pours ribbed tube baits that are perfect for rigging with a tapered tube skirt jig internally, or rigging texposed on a worm hook. The ribbed body of the tube is perfect for adding and holding scent and gives the bait a slow fall, unique action, and added vibration that set it apart from other tubes.

| Item No. | Model No. | Mold Type | Size (in inches) | Cavities |
|----------|-----------|-----------|------------------|----------|
| 95318    | TRT4001   | Tube      | 4                | 1        |



## CRAPPIE FLUKE

A segmented grub body that tapers to a split tail a combo that no crappie black or white can resist. An 8 cavity mold that keeps your tackle supply stacked at all times and a separate tail mold for easily making 2-tone body tail combos make this a must have mold, not to mention the dual injecting possibilities. And it's not just crappie that have an affinity for it, the Crappie fluke makes an excellent dropshot bait for a variety of other species including perch largemouth and smallmouth.

| Item No. | Model No. | Mold Type | Size (in inches) | Cavities |
|----------|-----------|-----------|------------------|----------|
| 95327    | CPF825    | Grub      | 2.5              | 8        |

## CRAPPIE FLUKE TAIL

| Item No. | Model No. | Mold Type | Size (in inches) | Cavities |
|----------|-----------|-----------|------------------|----------|
| 95331    | CPFT825   | Tail      | 2.5              | 8        |





# CRYSTAL CLEAR PLASTISOL

Crystal Clear Plastisol is a brand new formula developed to our exact specifications - for the way we use plastisol. We went outside the fishing industry for a fresh perspective on plastisol. We worked very closely with chemist and engineers to develop a "phthalate free" plastic engineered specifically for the harsh environment of a microwave. As a result, it not only works great in a microwave, it works great in a pot or on a burner.

Frankly, Crystal Clear is the clearest, least smoke and smell, easiest to use plastic available. It is phthalate free, does not make oily baits, it doesn't hard pack, micro bubbles are not an issue, it's honestly the best plastic available.

## CRYSTAL CLEAR PLASTISOL

| Qty.        | Plastisol Type |         |        |
|-------------|----------------|---------|--------|
|             | Hard           | Regular | Soft   |
| 1 pint      | #91396         | #91382  | #91395 |
| 1 gallon    | #91379         | #91376  | #91373 |
| 2.5 gallons | #91380         | #91377  | #91374 |
| 5 gallons   | #91381         | #91378  | #91375 |



## CRYSTAL CLEAR PLASTISOL HARDENER

| Item No. | Qty.   |
|----------|--------|
| 91383    | 1 pint |



## CRYSTAL CLEAR SOFTENER

| Item No. | Qty.   |
|----------|--------|
| 91390    | 5.5 oz |
| 91391    | 1 pint |



## HD SINKING ADDITIVE

The HDS Additive is a naturally occurring silicate formulated specifically for use in making soft plastic baits sink. To achieve a similar sink rate to popular sinking baits add 1-2 tablespoons of HDS Additive per 4 oz of plastic.

| Item No. | Qty.  |
|----------|-------|
| 91384    | 1 lb  |
| 91385    | 5 lb  |
| 91386    | 10 lb |



## UPPER HAND SCENTS

5.5 ounces of Upper Hand Scent. Please note: Coffee Shad is a dark scent and should only be added to dark baits or to the bag of lighter colored baits. ⚠️

| Color                               | Item No. |
|-------------------------------------|----------|
| Toad Xplode                         | 91316    |
| Hawg Sauce (Crawfish)               | 91317    |
| Hawg & Garlic (Crawfish and Garlic) | 91318    |
| Hawg & Anise (Crawfish and Anise)   | 91319    |
| Coffee Shad (Coffee and Shad)       | 91320    |
| Toad Magnet (Garlic and Anise)      | 91321    |
| Grape Shad (Bass Sauce with Grape)  | 91322    |
| Java' N Garlic (Coffee and Garlic)  | 91323    |



## CRYSTAL CLEAR STABILIZER

A custom blend of multiple heat stabilizers to help prevent yellowing of plastic on reheats. Phthalate free.

| Item No. | Qty.   |
|----------|--------|
| 91387    | 5.5 oz |
| 91388    | 1 pint |



## WORM OIL

| Item No. | Qty.   |
|----------|--------|
| 91392    | 5.5 oz |
| 91393    | 1 pint |



## X2 COLORANT

X2 Colorants were engineered to our exact specifications. Specifically, you will find it suspends much better than most colorants, is much thicker (typically the consistency of ketchup), and is much stronger (requiring 1/3 - 1/2 as many drops as you may normally use). These are the actual colors, but you can dramatically change them by adding more or less colorant, by mixing colorants and adding glitter. 5.5 oz, 9.99 each. ⚠️



|    | Color                        | Item No. |
|----|------------------------------|----------|
| 1  | Amber                        | 91262    |
| 2  | Baby Bass                    | 91263    |
| 3  | Black                        | 91264    |
| 4  | Blue                         | 91267    |
| 5  | Blue Fleck #1                | 91265    |
| 6  | Blue Fleck #2                | 91266    |
| 7  | Brown                        | 91268    |
| 8  | Bubble Gum                   | 91269    |
| 9  | Caney Creek Green            | 91270    |
| 10 | Chartreuse                   | 91271    |
| 11 | Cinnamon                     | 91272    |
| 12 | Emerald Green                | 91273    |
| 13 | Florida Grape                | 91274    |
| 14 | Fluorescent Blue             | 91275    |
| 15 | Fluorescent Green Chartreuse | 91276    |
| 16 | Fluorescent Lime Green       | 91277    |
| 17 | Fluorescent Orange           | 91278    |
| 18 | Fluorescent Pink             | 91279    |
| 19 | Green Grass                  | 91280    |
| 20 | Green Pumpkin Brown          | 91281    |
| 21 | Green Pumpkin Green          | 91282    |
| 22 | Jelly Red                    | 91283    |
| 23 | June Bug                     | 91284    |
| 24 | Midnight Blue                | 91285    |
| 25 | Motor Oil                    | 91286    |
| 26 | Plum                         | 91287    |
| 27 | Pumpkin Seed                 | 91288    |
| 28 | Purple                       | 91289    |
| 29 | Red                          | 91290    |
| 30 | Sweet Potato                 | 91291    |
| 31 | Tomato                       | 91292    |
| 32 | Watermelon Brown             | 91293    |
| 33 | Watermelon Green             | 91294    |
| 34 | White                        | 91295    |
| 35 | Yellow                       | 91296    |



01



02



03



04



05



06



07

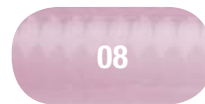

08

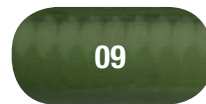

09



10



11



12



13



14



15



16



17



18



19



20



21



22



23



24



25



26



27



28



29



30



31



32

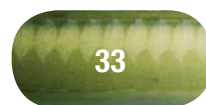

33

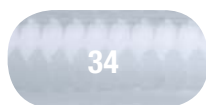

34



35

## SUPER GLOW POWDER

Once charged Super Glow Powders glow their true colors up to five times brighter and twice as long as standard glow additives. This means greater attraction in deep or murky water conditions and after dark or during low light. Photo samples were made using a like colored X2 florescent colorant and 1/8 tsp. Super Glow Powder per 4-6 oz. plastic. Colors shown right.

Sold by weight (1.5 ounces) in 1 oz. container.

| Color               | Item No. |
|---------------------|----------|
| Chartreuse          | 91255    |
| Blue                | 91256    |
| Orange              | 91257    |
| Green               | 91258    |
| Red                 | 91259    |
| Natural Glow        | 91260    |
| 6 pack (all colors) | 91261    |

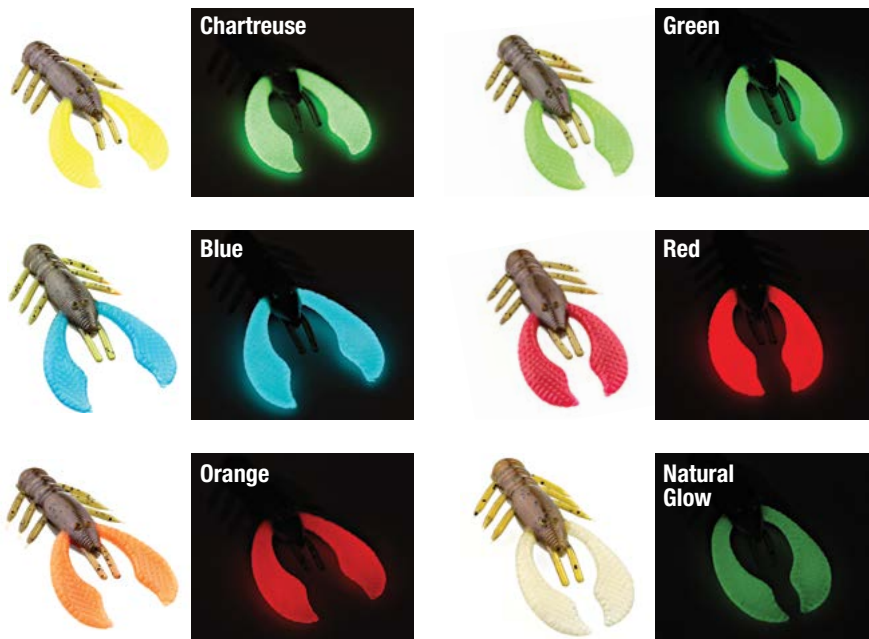

## HYPER HI-LITES

Hyper Hi-lite powders added to your plastisol will create exciting effects. Particles reflect light creating a sense of depth and provide a sheen of color to the skin of your baits. The color intensity reflecting off the surface of the bait varies based on movement and viewing angle creating a dynamic effect in the water. Color combinations are endless. Start with a small amount the size of a match tip and add as needed. Colors are shown mixed with left in clear plastisol and right in black X2 colorant.

|    | Color        | 2 oz     | 5.00     | 4 oz     | 9.50     | 8 oz  | 18.99 |
|----|--------------|----------|----------|----------|----------|-------|-------|
|    |              | Item No. | Item No. | Item No. | Item No. |       |       |
| 48 | Blue Pearl   | 91297    |          | 91298    |          | 91299 |       |
| 49 | Bronze Pearl | 91300    |          | 91301    |          | 91302 |       |
| 50 | Gold Pearl   | 91303    |          | 91304    |          | 91305 |       |
| 51 | Green Pearl  | 91306    |          | 91307    |          | 91308 |       |
| 52 | Rose Pearl   | 91309    |          | 91310    |          | 91311 |       |
| 53 | Violet Pearl | 91312    |          | 91313    |          | 91314 |       |

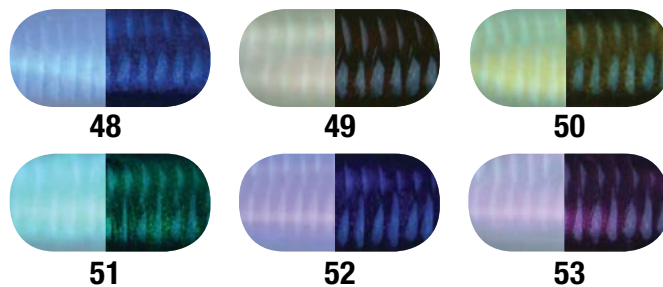

## HYPER HI-LITES 6 PACK

The Hyper Hi-lite six pack contains one of each of the six colors we offer in the 2 oz. size. It is a great way to try out this product! Hyper Hi-lite powders added to your plastisol will create exciting effects. See colors listed above.



| Item No. |
|----------|
| 91315    |

## UV BLAST POWDER

UV BLAST is now available in a powder form for your softbaits! It will cause your bait to flash even in dark, murky water where UV light, but not visible light, penetrates. Research continues to show that fish see and are attracted to UV light. Order some UV BLAST and make 'em glow! 2 oz.

| Item No. |
|----------|
| 91253    |

## PEARL POWDER

Ultra Bright White Pearl Powder. A small amount of this goes a long way. Start with a very small amount, maybe equal to the tip of a match stick, and add as needed. 2 oz. jar.



| Item No. |
|----------|
| 91252    |





# HIGH HEAT HEX GLITTER

This is the top of line polyester glitter made specifically for baits. All colors are a deep rich color and will withstand reheating. For best results, and maximum reheating, initially add the glitter once your plastic is hot. All glitter ships in a reusable plastic jar. Available in 3 sizes: .008", .015", and .040". Colors shown below.

| Color # | Color Name        | .008 High Heat Hex Glitter |          |          |          |          | .015 High Heat Hex Glitter |       |          |          |          | .040 High Heat Hex Glitter |          |          |   |          |          |          |          |          |          |
|---------|-------------------|----------------------------|----------|----------|----------|----------|----------------------------|-------|----------|----------|----------|----------------------------|----------|----------|---|----------|----------|----------|----------|----------|----------|
|         |                   | 2 oz                       | 3.75     | 4 oz     | 5.75     | 8 oz     | 10.50                      | #     | 2 oz     | 3.75     | 4 oz     | 5.75                       | 8 oz     | 10.50    | # | 2 oz     | 3.75     | 4 oz     | 5.75     | 8 oz     | 10.50    |
|         |                   | Item No.                   | Item No. | Item No. | Item No. | Item No. | Item No.                   |       | Item No. | Item No. | Item No. | Item No.                   | Item No. | Item No. |   | Item No. | Item No. | Item No. | Item No. | Item No. | Item No. |
| 54      | Silver            | 91027                      |          | 91028    |          | 91029    | 54                         | 91102 |          | 91103    |          | 91104                      | 54       | 91177    |   | 91178    |          | 91179    |          |          |          |
| 55      | Gold              | 91030                      |          | 91031    |          | 91032    | 55                         | 91105 |          | 91106    |          | 91107                      | 55       | 91180    |   | 91181    |          | 91182    |          |          |          |
| 56      | Copper            | 91033                      |          | 91034    |          | 91035    | 56                         | 91108 |          | 91109    |          | 91110                      | 56       | 91183    |   | 91184    |          | 91185    |          |          |          |
| 57      | Garnet            | 91036                      |          | 91037    |          | 91038    | 57                         | 91111 |          | 91112    |          | 91113                      | 57       | 91186    |   | 91187    |          | 91188    |          |          |          |
| 58      | Fire Red          | 91039                      |          | 91040    |          | 91041    | 58                         | 91114 |          | 91115    |          | 91116                      | 58       | 91189    |   | 91190    |          | 91191    |          |          |          |
| 59      | Chartreuse        | 91042                      |          | 91043    |          | 91044    | 59                         | 91117 |          | 91118    |          | 91119                      | 59       | 91192    |   | 91193    |          | 91194    |          |          |          |
| 60      | Sea Green         | 91045                      |          | 91046    |          | 91047    | 60                         | 91120 |          | 91121    |          | 91122                      | 60       | 91195    |   | 91196    |          | 91197    |          |          |          |
| 61      | Lime              | 91048                      |          | 91049    |          | 91050    | 61                         | 91123 |          | 91124    |          | 91125                      | 61       | 91198    |   | 91199    |          | 91200    |          |          |          |
| 62      | Moss Green        | 91051                      |          | 91052    |          | 91053    | 62                         | 91126 |          | 91127    |          | 91128                      | 62       | 91201    |   | 91202    |          | 91203    |          |          |          |
| 63      | Ocean Blue        | 91054                      |          | 91055    |          | 91056    | 63                         | 91129 |          | 91130    |          | 91131                      | 63       | 91204    |   | 91205    |          | 91206    |          |          |          |
| 64      | Ocean Spray Green | 91057                      |          | 91058    |          | 91059    | 64                         | 91132 |          | 91133    |          | 91134                      | 64       | 91207    |   | 91208    |          | 91209    |          |          |          |
| 65      | Navy              | 91060                      |          | 91061    |          | 91062    | 65                         | 91135 |          | 91136    |          | 91137                      | 65       | 91210    |   | 91211    |          | 91212    |          |          |          |
| 66      | Canadian Blue     | 91063                      |          | 91064    |          | 91065    | 66                         | 91138 |          | 91139    |          | 91140                      | 66       | 91213    |   | 91214    |          | 91215    |          |          |          |
| 67      | Light Purple      | 91066                      |          | 91067    |          | 91068    | 67                         | 91141 |          | 91142    |          | 91143                      | 67       | 91216    |   | 91217    |          | 91218    |          |          |          |
| 68      | Purple            | 91069                      |          | 91070    |          | 91071    | 68                         | 91144 |          | 91145    |          | 91146                      | 68       | 91219    |   | 91220    |          | 91221    |          |          |          |
| 69      | Orange            | 91072                      |          | 91073    |          | 91074    | 69                         | 91147 |          | 91148    |          | 91149                      | 69       | 91222    |   | 91223    |          | 91224    |          |          |          |
| 70      | Perry             | 91075                      |          | 91076    |          | 91077    | 70                         | 91150 |          | 91151    |          | 91152                      | 70       | 91225    |   | 91226    |          | 91227    |          |          |          |
| 71      | Gunmetal          | 91078                      |          | 91079    |          | 91080    | 71                         | 91153 |          | 91154    |          | 91155                      | 71       | 91228    |   | 91229    |          | 91230    |          |          |          |
| 72      | Black             | 91081                      |          | 91082    |          | 91083    | 72                         | 91156 |          | 91157    |          | 91158                      | 72       | 91231    |   | 91232    |          | 91233    |          |          |          |
| 73      | White             | 91084                      |          | 91085    |          | 91086    | 73                         | 91159 |          | 91160    |          | 91161                      | 73       | 91234    |   | 91235    |          | 91236    |          |          |          |
| 74      | Holo Silver       | 91087                      |          | 91088    |          | 91089    | 74                         | 91162 |          | 91163    |          | 91164                      | 74       | 91237    |   | 91238    |          | 91239    |          |          |          |
| 75      | Holo Gold         | 91090                      |          | 91091    |          | 91092    | 75                         | 91165 |          | 91166    |          | 91167                      | 75       | 91240    |   | 91241    |          | 91242    |          |          |          |
| 76      | Holo Purple       | 91093                      |          | 91094    |          | 91095    | 76                         | 91168 |          | 91169    |          | 91170                      | 76       | 91243    |   | 91244    |          | 91245    |          |          |          |
| 77      | Holo Blue         | 91096                      |          | 91097    |          | 91098    | 77                         | 91171 |          | 91172    |          | 91173                      | 77       | 91246    |   | 91247    |          | 91248    |          |          |          |
| 78      | Holo Green        | 91099                      |          | 91100    |          | 91101    | 78                         | 91174 |          | 91175    |          | 91176                      | 78       | 91249    |   | 91250    |          | 91251    |          |          |          |

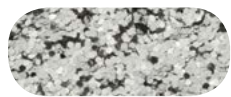

54

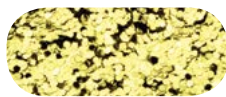

55



56

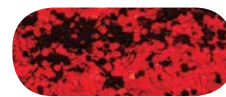

57

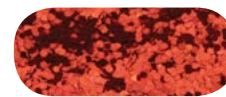

58



59

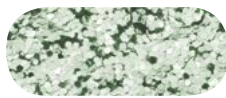

60

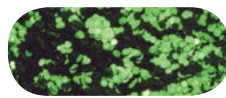

61

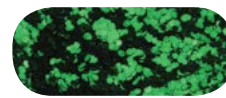

62

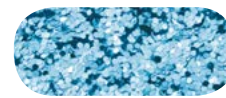

63

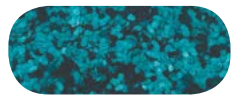

64

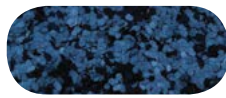

65

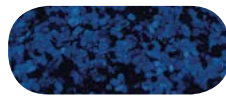

66

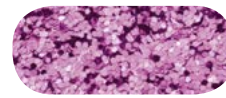

67



68

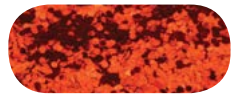

69

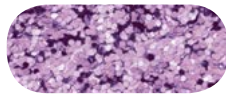

70

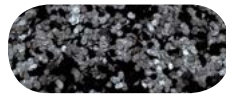

71



72

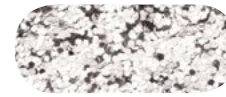

73



74



75

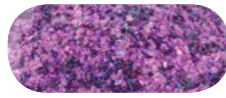

76



77

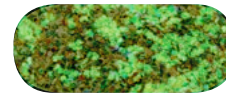

78

## INJECTORS

The Medium Injector and Nozzle holds 1/2 cup (4oz) of plastic. Super smooth action. Please note: This injector does not use a locking pin to hold the nozzle on. Additional care and awareness should be used when using it.

Engineered to get hot quick and hold heat longer, the Large Injector holds approximately 9.5 oz of plastic (approximately 1.5 cups). It is wider and shorter than traditional injectors allowing more plastic in a shorter tube which keeps it hot longer. It also makes it less cumbersome to use.

| Item No. | Model No. | Size    |
|----------|-----------|---------|
| 91345    | INJ0002   | 4 oz.   |
| 91361    | INJ0006   | 6 oz.   |
| 91351    | INJ0009   | 9.5 oz. |

**NEW SIZE!**

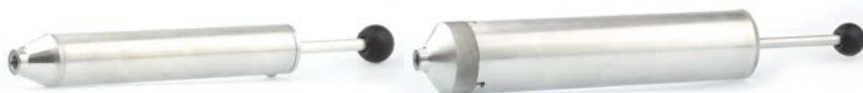

## INJECTOR O-RINGS

2 O-rings. Rebuild your entire injector (2 O-rings: 1 for the injector, 1 for the nozzle).

| Item No. | Model No. | Size      | Qty. |
|----------|-----------|-----------|------|
| 91347    | NOZRNG2   | 4 & 6 oz. | 2    |
| 91344    | NOZRNL2   | 9.5 oz.   | 2    |



6 oz. injector uses medium o-rings

## TUBE SPLINE

The spline is what makes the tail. The insert screws into the spline and determines how hollow the bait is. This is a spline (tail insert) for your mold.

| Item No. | Model No. |
|----------|-----------|
| 95208    | TUBSPLN   |



## SPLINES

Do-It now offers a variety of spline options for customizing soft plastic tubes. The new Spike 15 & Squiggle 6 Strand Splines work great with Do-It's existing line of tube molds and inserts enabling you to give your favorite tubes new life. Whether it's the Standard 18 Strand, the Spike 15 Straight or the Squiggle 6 Strand Spline you'll have the tools needed to give the fish a new look they won't be able to resist.

| Item No. | Model No. | Type                     |
|----------|-----------|--------------------------|
| 91325    | TUBSKPL   | Spike 15 Strand Spline   |
| 91326    | TUBSQPL   | Squiggle 6 Strand Spline |



Spike 15 Strand Spline  
item #91325



Squiggle 6 Strand Spline  
item #91326

## TUBE INSERT

This is an insert for your tube / hollow body mold so you can change the thickness of the head for a tube jig or thick for a t-rig. The insert screws into the spline and determines how hollow the tube is. The spline is what makes the tail. When checking out please document in the notes what tube this is for and what type of head you want.

| Item No. | Size (in inches) |
|----------|------------------|
| 95200    | 3/4              |
| 95201    | 1                |
| 95202    | 1.25             |
| 95203    | 1.5              |
| 95204    | 1.75             |
| 95205    | 2                |
| 95206    | 2.25             |
| 95207    | 4                |
| 95199    | Blank            |



## GLOVES

Keep yourself safe. Always wear gloves! I use both the cotton and Nitrile almost every time I pour. The cotton are easy to slip on, the Nitrile increase your dexterity and plastic just peels off.



| Item No. | Model No. | Type        |
|----------|-----------|-------------|
| 91343    | GLVC001   | Cotton Mill |
| 91348    | GLVN001   | Nitrile     |



## LAMINATED BAG

Heavy duty resealable laminated Barrier bags for artificial baits. Polyester blend to keep plasticizers and oils where they belong.

| Size     | Qty | Item No. |
|----------|-----|----------|
| 4" x 4"  | 25  | 91000    |
| 4" x 4"  | 50  | 91001    |
| 4" x 4"  | 100 | 91002    |
| 6" x 4"  | 25  | 91009    |
| 6" x 4"  | 50  | 91010    |
| 6" x 4"  | 100 | 91011    |
| 7" x 4"  | 25  | 91012    |
| 7" x 4"  | 50  | 91013    |
| 7" x 4"  | 100 | 91014    |
| 8" x 4"  | 25  | 91015    |
| 8" x 4"  | 50  | 91016    |
| 8" x 4"  | 100 | 91017    |
| 10" x 4" | 25  | 91003    |
| 10" x 4" | 50  | 91004    |
| 10" x 4" | 100 | 91005    |

## POLY BAG

Heavy duty resealable Crystal Clear Polypropylene bags. Excellent viewing properties. Resists oils and grease. Perfect for jigs, weights and other small terminal tackle.

| Size    | Qty | Item No. |
|---------|-----|----------|
| 2" x 3" | 25  | 91023    |
| 2" x 3" | 50  | 91021    |
| 2" x 3" | 100 | 91022    |
| 4" x 4" | 25  | 91018    |
| 4" x 4" | 50  | 91019    |
| 4" x 4" | 100 | 91020    |

## FLOATING FOAM 5'

This foam is intended to add buoyancy to your baits without exposing you to glass air bubbles which can become airborne and get in your lungs. The foam is chemical resistant, soft, flexible and heat resistant. It is approximately 0.15" wide.

| Item No. |
|----------|
| 91342    |



## SPRUE EXTENDER

Do-It's new 5" Sprue Extender gives large cavity molds additional hot plastic to draw from as the mold(s) cool keeping the runner full of hot plastic instead of drawing air.

| Item No. |
|----------|
| 91352    |



## 4 OZ. & 6 OZ. INJECTOR NOZZLE

Medium Injector Nozzle. It's a good idea to have a couple extras as they can get hot and need time to cool between uses.

| Item No. | Size      |
|----------|-----------|
| 91346    | 4 & 6 oz. |



## PROACCURATE DIGITAL THERMOMETER

Know your plastic temperature. Stainless Steel quick read thermometer that is certified plus or minus 2 degrees up to 450 degrees. Shatterproof and waterproof. Sheath and battery included.

| Item No. | Model No. |
|----------|-----------|
| 91349    | CDN001    |



## YORKER CAPS

Yorker Cap and Red Lid (fits 5.5 oz and pint bottles)

| Item No. | Qty |
|----------|-----|
| 91324    | 5   |



## DUAL INJECTOR

Sleek, agile, and compact. Item 91340 is a complete dual injection system, that features two 4 oz capacity injectors. Item 91341 is a conversion kit for the folks that already have two of our 4 oz injectors. This kit contains everything you need, plus the tool, to assemble your own dual injector system. Also compatible with the 6 oz. injectors.

| Item No. |
|----------|
| 91340    |
| 91341    |

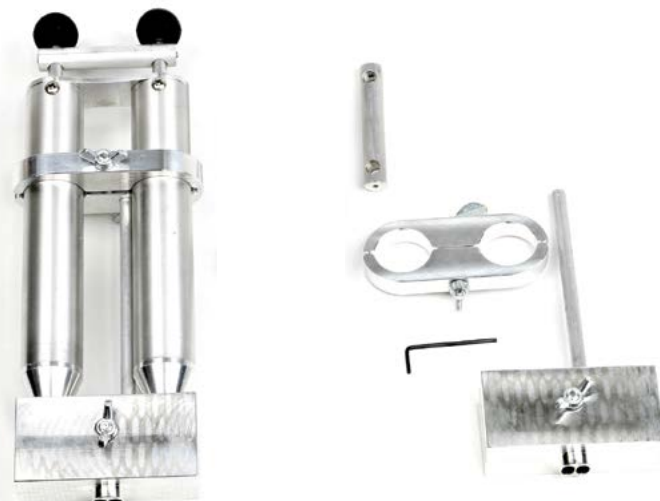



# STARTER KIT

This kit includes the most frequently requested supplies for someone just getting started. You can basically select this kit, and then purchase whatever molds you want. The only essential items not in the kit are your molds, heat source / Pyrex cup or pan, 2 Irwin bar clamps and an infrared thermometer.

The kit includes:

- (1) Gallon Regular Crystal Clear Plastisol
- 5.5 fl. oz. Worm Oil
- 5.5 fl. oz. Softener

- 5.5 fl. oz. Heat Stabilizer
- (4) Bottles X2 Colorant (Watermelon Brown, Green Pumpkin, Florida Grape, Pumpkin Seed) ⚠️
- (4) 2 oz. jars of glitter (.040 Black, .008 Red, .015 Moss Green, .015 Canadian Blue)

- (1) Pair of Nitrile Gloves
- (1) Medium Injector with extra nozzle
- (25) 7x4 Bait Bags

| Item No. |
|----------|
| 91359    |

# MOLD KITS

Each kit includes: Medium Plastic Injector, Pint of Crystal Clear Plastic, two 5 oz. containers of plastic colorant, two 2 oz. containers of glitter, nitrile gloves, and an Aluminum Injection Mold or an Aluminum Open Pour Mold of the bait listed and shown below. ⚠️

Colors may differ than those shown right.



## INJECTION CRAPPIE KIT

This kit includes materials to create a 2.5" Crappie Carrot

| Item No. |
|----------|
| 91353    |



Crappie Carrot

## INJECTION CRAW KIT

This kit includes materials to create a 3.75" Mud Bug

| Item No. |
|----------|
| 91354    |



Mud Bug

## INJECTION CREATURE KIT

This kit includes materials to create a 4" Lil' Toad Sticker

| Item No. |
|----------|
| 91355    |



Lil' Toad Sticker

## INJECTION CROAKER KIT

This kit includes materials to create a 3.5" Croaker

| Item No. |
|----------|
| 91356    |



Croaker

## INJECTION WACKY KIT

This kit includes materials to create a 6" Skinny Carrot

| Item No. |
|----------|
| 91357    |



Skinny Carrot

## OPEN POUR KIT

This kit includes materials to create a 4.85" Freedom Fry

| Item No. |
|----------|
| 91358    |



Freedom Fry

# INTRODUCING DO-IT SOFT BAITS ESSENTIAL SERIES

Custom making your own soft bait lures is one of the most exciting things in angling. Do-it's new Essential Series focuses on providing the tackle enthusiast all the "essential" products used to enter into the world making their own soft bait lures. The products are designed to be a great value and something that any fisherman can utilize to begin creating their own custom baits.



The Essential Series Molds are value engineered, giving the enthusiast a lower price point product, but still retain all the bait's effective fish catching power. Our plastisol is easy to use, does not contain harmful phalates and out performs other products on the market. Our colorant and glitter for the Essential Series is engineered to be user friendly, cost effective and gives the customer amazing creative ability.

## ESSENTIALS STARTER KIT

All the "essential" accessories needed to get started shooting your own plastics in one easy starter kit.

The kit includes:

- (1) Quart Essential Series Plastisol
- (4) Bottles Essential Series Colorant (Watermelon Green, Chartreuse, June Bug, Motor Oil) ⚠️
- (2) Bottles Essential Series Glitter (.015 Holographic Silver and .015 Fire Red)
- (1) Medium Injector with extra nozzle
- (25) 7x4 Bait Bags



Item No.

91360

## BEAVER STYLE BUG

The king of flipping and punching baits, this classic beaver style bait will break through the cover and seduce the most finicky of fish. A classic presentation employed by many a tournament angler to fill the live well.

| Item No. | Model No. | Mold Type | Size (in inches) | Cavities |
|----------|-----------|-----------|------------------|----------|
| 96009    | BBG-1-45  | Creature  | 4.5              | 1        |



## BRUSH HOG

This is a great flipping or pitching bait. Large flappers, twin c-tails and a partially ringed body all add to this baits fish attracting simplicity.

| Item No. | Model No. | Mold Type | Size (in inches) | Cavities |
|----------|-----------|-----------|------------------|----------|
| 96004    | BH-1-525  | Creature  | 5.25             | 1        |



## CRAW

This is an "action" craw. It provides a realistic profile when pitching, however, the claws have a super flapping action on retrieve. It will get their attention one way or the other.

| Item No. | Model No. | Mold Type | Size (in inches) | Cavities |
|----------|-----------|-----------|------------------|----------|
| 96006    | MDC-1-35  | Craw      | 3.5              | 1        |



## CREATURE CRAW CHUNK

Every boat needs a good trailer and jigs are no different. The Creature Craw Chunk is an excellent trailer to quickly beef up a jig to slow its fall and give it added attraction. The meaty body easily slides up the hook shank of your favorite jigs and can be shortened as needed while the ribbed craw pincers give it an erratic unique action. Pour it up in a craw color or match your favorite skirt. The Creature Craw Chunk allows you to build it right and get the bite.

| Item No. | Model No. | Mold Type | Size (in inches) | Cavities |
|----------|-----------|-----------|------------------|----------|
| 96013    | CCC-4-325 | Craw      | 3.25             | 4        |



## FINESSE CRAWLER

This worm defines finesse. Subtle and delicate, it's an outstanding performer on a split shot rig or shakey head. Its bulbous tipped tail has one flat side and simply can't be still with even the slightest movement of the rod tip.

| Item No. | Model No. | Mold Type | Size (in inches) | Cavities |
|----------|-----------|-----------|------------------|----------|
| 96001    | FSC-5-60  | Worm      | 6                | 5        |



## FROG

An extremely realistic frog imitation, toss this Swim Frog in or around the grass or Lillie pads and hang on. It has a stellar top water action but excels as a subsurface swimmer as well. Just put this bait in their "froggie zone" they're going to pound it.

| Item No. | Model No. | Mold Type | Size (in inches) | Cavities |
|----------|-----------|-----------|------------------|----------|
| 96002    | BFS-2-35  | Frog      | 3.5              | 2        |



## GRUB

It is theoretically possible that the 3" twisty tail grub has caught more fish than any other plastic bait. Imitating a small forage fish it's the perfect size with an action that is irresistible. Now you can make your own 3" grubs in the colors that entice the fish on your local waters.

| Item No. | Model No. | Mold Type | Size (in inches) | Cavities |
|----------|-----------|-----------|------------------|----------|
| 96010    | KCG-4-3   | Grub      | 3                | 4        |



## JERK BAIT

The tail on this jerk bait has an incredibly subtle action that is sure to trigger strikes, and not unlike most soft jerk baits with this profile, it casts like a dart and has a very erratic action when twitched on the retrieve. Carolina Rig, Texas Rig, Drop Shot, Donkey Rig, just about anything goes with this bait.

| Item No. | Model No. | Mold Type | Size (in inches) | Cavities |
|----------|-----------|-----------|------------------|----------|
| 96000    | WJB-4-50  | Jerk Bait | 5                | 4        |



## LIZARD

The Lizard is specifically designed to entice Spring and Fall feeding patterns, as well as trigger defensive instincts. The King of the Carolina Rig and Spring bed fishing everyone's arsenal needs a Lizard to help bring in the early and late season fish.

| Item No. | Model No. | Mold Type | Size (in inches) | Cavities |
|----------|-----------|-----------|------------------|----------|
| 96003    | LZ-1-7    | Creature  | 7                | 1        |





## SENKO

As we have done in the past we have teamed up with Gary Yamamoto and he has given us license to manufacture a do it yourself mold to create a bait with the very same specifications as his legendary Senko, one of the most popular soft plastic baits in history. From bow to transom and every little rib in between it is to exact specifications.

| Item No. | Model No. | Mold Type | Size (in inches) | Cavities |
|----------|-----------|-----------|------------------|----------|
| 96019    | GYS-4-40  | Worm      | 4                | 4        |
| 96005    | GYS-4-50  | Worm      | 5                | 4        |
| 96020    | GYS-4-60  | Worm      | 6                | 4        |



## SWIMBAIT

Sporting a natural swimming action, that will be sure to attract bites from hesitant bass, this bait rocks gently back and forth as its tail dances from side to side. Fish it alone Texas Rigged, on an underspin jig, or group them together on an umbrella style rig, it is a realistic and versatile swimmer.

| Item No. | Model No. | Mold Type | Size (in inches) | Cavities |
|----------|-----------|-----------|------------------|----------|
| 96007    | SSB-3-375 | Swimbait  | 3.75             | 3        |



## RIBBON WORM

A staple of Bass Fishing for many years the Ribbon Worm delivers an excellent swimming action thanks to its specially designed tail. Wider at its base, this prevents it from wrapping around grass and stick ups, keeping you and the bait free to make a few more casts.

| Item No. | Model No. | Mold Type | Size (in inches) | Cavities |
|----------|-----------|-----------|------------------|----------|
| 96008    | RTW-2-7   | Worm      | 7                | 2        |



## PADDLE TAIL

You can hardly round out your tackle box or lure collection without including the Paddle Tail. It has been a staple of many people's presentations for years and it is here to stay. Now you can make your very own custom Paddle Tails in all of your favorite color combinations. They excel on a jig and do a great job of imitating a prey fish. Poured up in the right color they can mimic almost any bait fish in the system. These baits are the perfect size for a multitude of species making these a versatile all around bait meant for every fisherman's tackle box!

| Item No. | Model No. | Mold Type | Size (in inches) | Cavities |
|----------|-----------|-----------|------------------|----------|
| 96014    | PT-12-175 | Swimbait  | 1.75             | 12       |
| 96015    | PT-8-200  | Swimbait  | 2                | 8        |
| 96011    | PT-6-225  | Swimbait  | 2.25             | 6        |
| 96016    | PT-3-350  | Swimbait  | 3.5              | 3        |
| 96017    | PT-2-400  | Swimbait  | 4                | 2        |
| 96018    | PT-2-500  | Swimbait  | 5                | 2        |
| 96021    | PT-1-600  | Swimbait  | 6                | 1        |



## TWO-PENNY TWINTAIL GRUB

The Twintail grub may be responsible for more walleye dinners than any other plastic out there. We improved upon this age old bait by segmenting and bulking up the body while ribbing and thinning down the tail to maximize action. These tails move! Not to mention, it serves as a great jig trailer for bass fishermen. The Two Penny Twintail comes in 4" length but can easily be shortened to custom fit a jig. Let the fish give you their two cents worth while you give them a mouthful of the Two Penny Twintail.

| Item No. | Model No. | Mold Type | Size (in inches) | Cavities |
|----------|-----------|-----------|------------------|----------|
| 96012    | TPT-2-40  | Grub      | 4                | 2        |

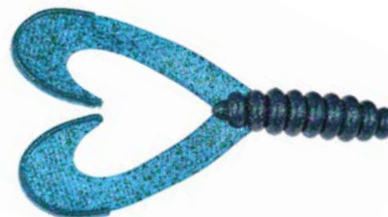

## ES RIPPER

The ES Ripper's fat ribbed body and boot style tail create a side-to-side lateral swimming action that make it deadly on all trophy game fish. This 3-cavity mold is the best value swimbait mold available on the market. Rip them up with the new ES Ripper from Do-it Molds.

| Item No. | Model No. | Mold Type | Size (in inches) | Cavities |
|----------|-----------|-----------|------------------|----------|
| 96022    | RPR-2-35  | Swimbait  | 3.5              | 3        |
| 96023    | RPR-5-30  | Swimbait  | 3.0              | 5        |



## ESSENTIAL SERIES CRAPPIE FLUKE

A segmented grub body that tapers to a split tail is a combo that no crappie black or white can resist. This 8 cavity mold assures your tackle supply will be stacked at all times. Dual injecting perfect two tone variations is a breeze and it's not just crappie that have an affinity for it as it makes a great dropshot bait for a variety of other species including perch largemouth and smallmouth.

| Item No. | Model No. | Mold Type | Size (in inches) | Cavities |
|----------|-----------|-----------|------------------|----------|
| 96025    | CRF825    | Swimbait  | 2.5              | 8        |



## ESSENTIAL SERIES MIDWEST FINESSE

A true fan favorite, the Midwest Finesse Rig (aka Ned Rig), is now available in a cast Essential Series model for those of you looking for an economical way to make quality soft plastics. Those of you who have fished the Ned Rig already understand the fish catching command these baits have. They stand up straight when on bottom and fish simply cannot resist them. Now with the Essential Series Midwest Finesse Rig, you can make your own in that favorite color you've been buying or in a custom color that fish have never seen before. The Midwest Finesse Rig plastics are a perfect match for our Midwest Finesse Jig heads as seen on page 21. The Midwest Finesse Rig is essentially one of the most fish catching baits of our modern time.

| Item No. | Model No. | Mold Type | Size (in inches) | Cavities |
|----------|-----------|-----------|------------------|----------|
| 96024    | MFR-8-27  | Swimbait  | 2.7              | 8        |



## ESSENTIAL SERIES COLORANT

Make your own soft plastic baits in the colors you want. A few drops of Essential Series Colorant added to your plastisol before pouring is all you'll need to create that perfect fish catching color you're looking for. Add more for a darker more opaque appearance or less for that translucent look. Either way, you're in control. ⚠️

|    | Color            | Item No. |
|----|------------------|----------|
| 1  | White            | 91400    |
| 2  | Chartreuse       | 91401    |
| 3  | Black            | 91402    |
| 4  | Motor Oil        | 91403    |
| 5  | Red              | 91404    |
| 6  | Watermelon Green | 91405    |
| 7  | Blue             | 91406    |
| 8  | Pumpkin Brown    | 91407    |
| 9  | Junebug          | 91408    |
| 10 | Midnight Blue    | 91409    |
| 11 | Blue Smoke       | 91410    |
| 12 | Pearl            | 91411    |
| 13 | Purple Smoke     | 91412    |
| 14 | Flo. Orange      | 91413    |
| 15 | Green Smoke      | 91414    |
| 16 | Flo. Pink        | 91415    |





# ESSENTIAL SERIES PLASTISOL

Making your own custom soft plastic baits has never been easier with Do-Its' line of Essential Series Plastisol. Simply heat up 4-8 oz. of plastisol in a microwave to 350 degrees adding color and glitter as desired and inject into your mold(s). You'll be making your own custom colored plastic baits with ease and peace of mind knowing you are using the best quality plastic on the market. The Essential Series Plastisol comes in a liquid form and upon heating turns clear and hardens into plastic upon returning to room temperature once injected. The Essential Series Plastisol line is user friendly and perfect for those just getting into making their own baits. Set up time takes only 30-60 seconds upon injecting into a mold. For best results let baits cure after pulling them out of the mold for 24 hours before bagging packaging or fishing them.

| Qty.            | Item No. |
|-----------------|----------|
| 1 Pint          | 91460    |
| 1 Quart         | 91461    |
| 1 Gallon        | 91462    |
| 2.5 Gallon      | 91370    |
| 5 Gallon Bucket | 91371    |
| 55 Gallon Drum  | 91372    |

\*Freight needs to be calculated

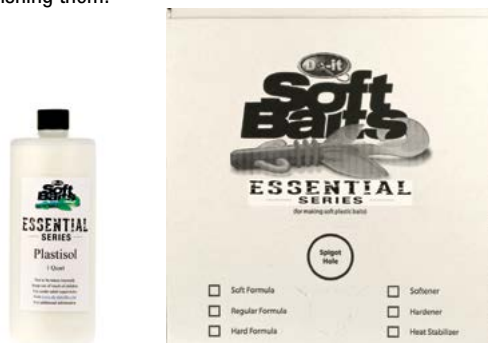

# ESSENTIAL SERIES GLITTER

Bring the "bling" to your own custom made soft plastic baits. A high quality polyester glitter, the Essential Series Glitter suspends in plastic better than heavier glitters and was made specifically for plastic baits. Give your soft baits that professional, eye popping appeal that catches fish, for best results, add glitter to hot plastic just before pouring or injecting. Glitter Flake comes in .015 size.

|    | Color         | Item No. |
|----|---------------|----------|
| 1  | Silver        | 91430    |
| 2  | Canadian Blue | 91431    |
| 3  | Gold          | 91432    |
| 4  | Fire Red      | 91433    |
| 5  | Black         | 91434    |
| 6  | Chartreuse    | 91435    |
| 7  | White         | 91436    |
| 8  | Purple        | 91437    |
| 9  | Moss Green    | 91438    |
| 10 | Copper        | 91439    |
| 11 | Orange        | 91440    |
| 12 | Gun Metal     | 91441    |



01



02

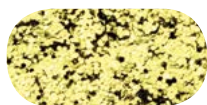

03

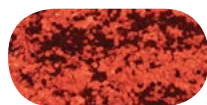

04



05



06



07



08

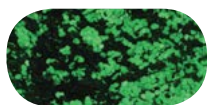

09



10

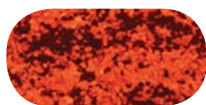

11



12