

DS18

WE LIKE IT LOUD

2018 CATALOG

DS18

DS18 is a leading electronics manufacturer specializing in Mobile, Marine & Home Electronic equipment with its headquarters in Miami, FL, USA. DS18 was created and developed by a team of young and determined professionals who understand the needs in today's audio industry. Offering several series of amplifiers, speakers, subwoofers, tweeters, midranges, cables, accessories, component sets and much more DS18 guarantees to satisfy customers seeking a wide assortment of products.

The DS18 brand stands out from other lines in its progressive design and "never-stop-innovating" Attitude. Our team takes your feedback as a command to constantly improve and keep-up with all new trends in order to deliver the most technologically up-to-date products in the market. We are here to revolutionize the market capitalizing on what the other guys failed to do right: Delivering a Sophisticated, trendy product line that people demand and love (and continue doing so on a regular basis). We promise to never stop refreshing our product lines with the coolest designs and technology available so you can always have the most outstanding products technology can offer. Think of DS18 as that new cool kid in the block that makes all the old-school brands uneasy. We do that with your feedback and our creativity, quality, pricing, and kick-ass "never-stop-innovating" attitude.

Without further ado, please take some time to be inspired by our 2018 line-up. From all of us at team DS18, we thank you for your support, business, and consideration.

TROUBLEMAKER HOOLIGAN

EXL ELITE BLACK DIAMOND GEN-X

SELECT PRO CANDY 

TECHNOLOGY HYDRO VISION LIFESTYLE



TABLE OF CONTENTS

Multimedia	4	Diaphragms	64
Headunits & Packages	5	Installation Accessories	65-67
Rearview Mirrors & Dashcams	6	Rearview Mirrors	68
Dashcams & BT Transmitters	7	Parking Sensors & Cameras	69
Flipdowns	8	Cameras	70
Headrests	9-10	Horns	71
Sound Quality	12-13	Car Accessories	72-73
Deluxe Sound Quality	14	Batteries	74
Speakers	15-19	Power	75
Loud Speakers	20-34	Hydro - For All Elements	77-83
Grills	35	Headlights	84
Subwoofers	36-45	LED Bars	85
Bass Packages	46	LED Lights	86
Boxes	47	LED Bulbs	87
Amplifiers	48-55	Headphones	88
Audio Processors	56-58	On The Road	89
Tweeters	59-60	Audio Interface	90
Drivers	61-63	P.O.P	91

Thinking about music lovers and technology enthusiasts, DS18 designed a various range of DVD multimedia players. Bluetooth wireless technology compatible with all devices for easy drive and steering control assistance intergraded in all models.

DDX6A 6.2" DOUBLE DIN DVD PLAYER WITH ANDROID 6.0 OS

- Android 6.0 Operating System
- Smart Phones Mirror Link Function
- Bluetooth, Call Hands-Free with External Mic, Phone Book Download, A2DP Bluetooth Music
- WiFi for Wireless Internet Access
- Multiple Screen Displays - Video Input / Two Video Output
- GPS / Compass / GLONASS & Other Multi-Mode Navigation
- Radio, FM Band, RDS, Radio Area Selection
- DVD / CD / MP3 Player
- 2-Way SD Card, Front USB Slot
- Multi-Format Audio & Video Decoding, 1080P Full Format Support, Highest 4K Video Quality Playback
- High Speed DVR (Dash Cam Recording) 720P, 1080P Function
- Voice Recognition, Language Wake-Up, Voice Control, System Sleep, Fast Start, Fast Reversing
- Optional Functions: Tire Pressure / OBD / TV / iPod & Others
- 3 Pre-Out 2.5 Volt RMS (Front, Rear, Sub W)
- 15 watts RMS @ 4 ohm - 45 Watts Max Power x 4 Amplifier
- 3 Band EQ With 5 Presets
- Programable Analog Steering Wheel Control
- CPU: T3 Chip, Quad-Core ARM Cortex-A7
- GPU: Mail400MP2, Supports OpenGL ES 2.0 / OpenVG 1.1 Standard
- RAM: 1G DDR3; ROM: 16G EMMC



DD620 6.2" DOUBLE DIN DVD PLAYER WITH USB & BLUETOOTH

- Universal Car Multimedia System DVD/VCD/CD/MP3/MP4/USB/SD
- Radio/RDS/iPod/Bluetooth/- Aux In
- HD Digital Panel (800 x 480) Resolution
- TFT LCD Fixed Panel
- Front Micro SD Slot on The Front Panel
- USB Input on Front Panel
- Internal Microphone
- Front & Rearview Camera Input
- Steering Wheel Connection
- Remote Control
- 2.4 Volt preout 5 ch
- Built-in 8 Band EQ
- Bluetooth Wireless Hands Free
- 45 Watts (max) 4 Channel High Output Power



DD600 6.2" DOUBLE DIN DVD PLAYER WITH USB & BLUETOOTH

- Universal Car Multimedia System DVD/VCD/CD/MP3/MP4/USB/SD
- Radio/iPod/CD/Bluetooth/Aux In
- HD Digital Panel (800 x 480) Resolution
- TFT LCD Fixed Panel
- 30 Station Preset: 12AM/18FM, Station Seek, Preset Scan
- Front SD Card & USB Input
- Bluetooth Wireless Hands Free
- Full Function Wireless Infrared Remote Control
- 2.4 Volt Preout 5 ch
- 45 Watts (max) 4 Channel High Output Power
- Steering Wheel Control
- Built in 8 Band EQ
- Internal Microphone
- Rearview Camera Output



CDSX18U SINGLE DIN DETACHABLE CAR CD/USB/FM PLAYER

- Negative LCD Display with Blue Color Backlight
- 30 Preset Stations (x18 for FM; x12 for AM). USA Freq
- 4x35 Watts Maximum Power Output
- Front Panel 3.5mm AUX (Audio) Input
- Front USB Input
- SD Card Input
- RCA Line Output (1 Pair)
- Remote Control
- CD/MP3 Player



CDV200 SINGLE DIN DETACHABLE CAR DVD/CD/USB/BT/FM/AM PLAYER

- Negative LCD Display with Blue Color Backlight
- Support ID3 Tag Function (Displays Singer, Song & Album's Name)
- Supports USB/SD/MMC Card. Front USB Input / SD Card Input
- Compatible with DVD/CD/MP3/WMA/BT
- 30 Preset Stations (x18 for FM; x12 for AM). USA Freq
- 4 x 35 Watts Maximum Power Output
- Front Panel 3.5mm AUX (Audio) Input
- 2 RCA Line Output - Bluetooth - Remote Control
- Video Output
- Electronic Preset Equalizer (POP/ROCK/CLASSIC/FLAT)
- Electronic Volume Control (TRE/BASS/BAL/FADE)



Putting together a complete car audio package can be difficult and time consuming, but DS18 package deals make it easy for anyone to have a modern setup. Our car audio/stereo package deals include a single DIN radio with all the features necessary to stream and play your favorite multimedia. Stream music on Bluetooth, through an AUX cable, or via USB/SD Card easily, or connect the radio to a monitor and play your favorite DVDs.

PKG36D CDV200 SINGLE DIN RADIO WITH A PAIR OF SLC-N65X & SLC-N69X SPEAKERS



SLC-N69X Specs: Page 19

SLC-N65X Specs: Page 19

CDV200 Specs Above

PKG18D CDV200 SINGLE DIN RADIO WITH A PAIR OF SLC-N65X 6.5" 4-WAY SPEAKERS



CDV200 Specs Above

SLC-N65X Specs: Page 19

Record your surroundings at all times with the Eagle Series Rearview Mirrors. All mirrors include rearview camera with built in dash-cam. Take the necessary precautions and keep your environment recorded in case of any situation.

EAGLE HD REARVIEW MIRROR • DASH CAM REC • REARVIEW CAM REC

- Full 1080P, 30fps (For Front Camera)
- Dual Record For Front & Rear Image
- Universal Mount
- Shooting Angle: 140°
- 4.3" HD LCD Display: 16:9
- Multi-Language Function
- Storage: TF card (up to 32G)
- Built-In Mic and Speaker
- Rear-view Function Activates When Reversing

DIY
CONNECTS TO
CIGARETTE LIGHTER



Universal Mount

EAGLE2IN1 HD REARVIEW MIRROR • DASH CAM REC • REARVIEW CAM REC • PARKING SENSOR

- Full 1080P/30fps (For Front Camera)
- Dual Record For Front & Rear Image
- Universal Mount
- Rearview Function Starts When Reversing
- Camera/Video Angle: 140°
- 4.3" HD LCD Display: 16:9
- Multi-Language Function
- Storage: TF card (up to 32G)
- Built-In Mic for Sound Recording
- Built-In Speaker

DIY
CONNECTS TO
CIGARETTE LIGHTER



Universal Mount

RCS2IN1 Included

- RCS2IN1**
- CMOS Color Camera, Color Screen Image
 - Beeping Sound Sensor 80-100 dB
 - Operation Temperature: -20 °C ~ +75 °C
 - TV System: PAL/NTSC
 - Distance scale line: 0.4-2M
 - Horizontal Resolution: 420 TV lines
 - Dimension: 67x30x28 mm
 - Ultrasonic Sensor Angle: 70°(level)
 - Lens Angle: 130 °(Level) 130° (Crosswise) 170°

SMART EAGLE/S SMART HD REARVIEW MIRROR • DASH CAM REC • SPECIAL MOUNT

SMART EAGLE SMART HD REARVIEW MIRROR • DASH CAM REC • UNIVERSAL MOUNT

- Smart Eagle - Universal Mount
- Smart Eagle/S - Special Mount
- Android 4.4 Quad-Core High-Speed Drive
- 5" 1080P Full HD Capacitive Touch Screen
- Main and Assist External Camera
- GPS Navigation and Rearview Reverse Function
- WiFi Connection • FM Radio • Bluetooth
- Video Codec: H.264 Video Format
- Mirror Size: 11mm Ultra-Thin Mirror, Support PIP
- Lens Angle: 140° Ultra-Wide Angle Lens
- Video Recording Resolution: 1080P@ 30FPS
- Cycle Recording: Over-Write First File if Memory is Full
- Loop Recording / G-Sensor / Motion Detection / Seamless Link
- Power Supply: 12-24V Car Adapter (Cigarette Lighter)
- Battery Capacity: Built-In High-Capacity Li-Battery
- Support Real Time & Date Display on the Video
- USB: USB2.0/AV OUT
- Storage: TF card (up to 32G)
- ON/OFF: With The Ignition Key



DIY
CONNECTS TO
CIGARETTE LIGHTER



Special Mount

Universal Mount

BLACK BOX DASH CAM RECORDER

- Full HD 1080P, 30 fps
- 25mm Diameter Lens
- 170° Ultra Wide View Angle
- 0330 Sensor with Super Night Visual Function
- 3.0" HD LCD Display 16:9
- Top Grade Metal Shell with More Color Choice
- Built-in G-sensory, WDR Function
- Multi-language - English, Portuguese, Spanish & More!!



BLUETOOTH

Wireless connection has been the fastest and most progressive development of this generation, the amount of technology production has been growing more rapidly over the years. DS18 has two models of Bluetooth transmitters; Slick & Connect, the easiest way to stream and talk hands free

SLICK IN CAR BLUETOOTH FM-TRANSMITTER

- Bluetooth
- Dual USB Output to Charge Other Devices (DC 5V/2.1A)
- Supports USB/SD/TF/AUX-IN
- Switch to Hands Free Mode Automatically when Receives Calls
- Draws Power from the Cigarette Socket in the car (DC 12V/24V)
- LCD Display
- 206 Channels
- Frequency: 87.5 - 108.0MHz
- Music Format: MP3, WMA

BT
BLUETOOTH



USB



Line-in



MP3/WMA



12V - 24V



Charger
5V / 2.1A



SD/TF Card



CONNECT IN CAR BLUETOOTH FM-TRANSMITTER

- Rated Voltage: 12-24V
- Rated Current: 90mA
- Power Consumption: 1W
- Work Temperature: 0-50°C
- SNR > 60dB
- Degree of Distortion < 0.1%
- Left and Right Channel > 60dB
- Bluetooth Version: BlueCore3
- Transmit Distance: 10M
- Bluetooth Microphone Effective Range: 0.5-2M
- Transmit Frequency: 87.5 - 106MHz
- Frequency Response: 20Hz - 15KHz



BT **FM** **SD CARD**

MP3

Enjoy all your entertainment needs in Hi-Def with the various lines of DS18 Headrest and Flip Down Monitors. Bring the fun back to road trips with our large selection of multimedia displays, play video games, watch movies, or listen to videos at any time.

FDS10 10.1" SUPER SLIM FLIP DOWN MONITOR

1024x768 LED Screen
Display Ratio: 16:9
Contrast Ratio: 500:1
Power Supply: DC 12V
System: PAL/NTSC
Built-in IR Transmitter for Wireless

Headphones
2 Video Inputs, 2 Audio Inputs
With LED Dome Light
IR Full Function Remote Controller
Touch Button

FDS12 12" SUPER SLIM FLIP DOWN MONITOR

1024x600 LED Screen
Display Ratio: 16:9
Contrast Ratio: 500:1
Power Supply: DC 12V
System: PAL/NTSC
Built-in IR Transmitter for Wireless

Headphones
2 Video Inputs, 2 Audio Inputs
With LED Dome Light
IR Full Function Remote Controller
Touch Button

FDS15 15.6" SUPER SLIM FLIP DOWN MONITOR

1366x786 LED Screen
Display Ratio: 16:9
Contrast Ratio: 600:1
Power Supply: DC 12V
System: PAL/NTSC
Built-in IR Transmitter for Wireless

Headphones
2 Video Inputs, 2 Audio Inputs
With LED Dome Light
IR Full Function Remote Controller
Touch Button

FDHQ13 13.3" ULTRA SLIM ROOF MOUNT MONITOR

1920x1080 Pixels LED Screen
2 Way AV Input
System: PAL/NTSC
Display Mode: 16:9 wide view screen
Pixel: 1920 (W) x 3 (RGB) x 1080 (H)
Power: DC 12V
Built-in Dome LED Lights

FDHQ13U 13.3" ULTRA SLIM ROOF MOUNT MONITOR WITH MULTIMEDIA

1920x1080 Pixels LED Screen with USB/SD(MP5)
IR/FM/Speakers/HDMI Input
System: PAL/NTSC
Display Mode: 16:9 Wide View Screen
Pixels: 1920 (W) x 3 (RGB) x 1080 (H)
2 Way AV Input, 1 Way HDMI Input
Built-in Dome LED Lights
Built-in IR/FM Transmitter
Power DC: 12V
Built in MP5/USB Card and SD/MS/MMC Slot
Built-in Multi-Media Compatible MP3/MP4/WMA/WAV/MPEG2/MPEG4/MKV/H.264/AVS/VC1/RM/RMVB/AVI/VP6/VP8 & More

FDHQ13DV 13.3" ULTRA SLIM ROOF MOUNT MONITOR WITH DVD & MULTIMEDIA

1920x1080 Pixels LED Screen with DVD/USB/SD(MP5)
IR/FM/Speakers/HDMI Input
Display Mode: 16:9 Wide View Screen
Pixels: 1920 (W) x 3 (RGB) x 1080 (H)
Built-in Multimedia Compatible
DVD/MP3/MP4/WMA/WAV/MPEG2/MPEG4/MKV/H.264/AVS/VC1/RM/RMVB/AVI/VP6/VP8 & More
System: PAL/NTSC • 2 Way AV Input, 1 Way HDMI Input
Built-in Dome LED Lights • Built in MP5/USB Card and SD/MS/MMC Slot
Built-in IR/FM Transmitter • Power DC: 12V



BLACK



TAN

GREY

BEIGE

AVAILABLE IN
BLACK, TAN, GREY



BLACK



TAN

GREY

BEIGE

AVAILABLE IN
BLACK, TAN, GREY

HPKG-7TBG 7" HEADREST

HPKG-9TBG 9" HEADREST

HEADREST COMBO - AV PILLOW MONITORS

Pair AV Pillow Monitor
Power DC 12V
New Panel of 800x400
Display Mode 16:9
PAL/NTSC/AUTO all Available
2 Way Video Inputs
Multi-Language Menu
Full Function Remote Control with IR

3 INTERCHANGEABLE COVERS
GREY, BLACK & TAN INCLUDED



HPKG-7DVD 7" HEADREST

HPKG-9DVD 9" HEADREST

COMBO HEADREST 1 AV PILLOW MONITOR & 1 DVD PLAYER USB/SD/IR READY

Power DC 12V
Compatible with DVD/VCD/CDCDG/MP4/MP3/WMA/JPEG/DIVX
New Panel of 800x400 Display Mode 16:9
PAL/NTSC/AUTO all Available
FM Transmitter for Car Radio Stereo System
Support 32 Bit & 8 Bit Games
Included: Wireless Joystick, More than 2300 Games
IR Transmitter For Infrared Headphone
SD Card Reader and USB Port
Audio/Video Input and Output
Multi-Language Menu
Full Function Remote Control
Built-in Dual Speaker

3 INTERCHANGEABLE COVERS
GREY, BLACK & TAN INCLUDED



HPKG-72DVD 7" HEADREST

HPKG-92DVD 9" HEADREST

HEADREST COMBO WITH 2 DVD PLAYER USB/SD/IR READY

Power DC 12V
Compatible with DVD/VCD/CDCDG/MP4/MP3/WMA/JPEG/DIVX
New Panel of 800x400 Display Mode 16:9
PAL/NTSC/AUTO all Available
FM Transmitter for Car Radio Stereo System
Support 32 Bit & 8 Bit Games
Included: Wireless Joystick, More than 2300 Games
IR Transmitter For Infrared Headphone
SD Card Reader and USB Port
Audio/Video Input and Output
Multi-Language Menu
Full Function Remote Control
Built-in Dual Speaker

3 INTERCHANGEABLE COVERS
GREY, BLACK & TAN INCLUDED



Going beyond the auto market industries and setting aside the way to enjoy videos, games or even music in the back seat just got easier. Choose from pillow headrest to our universal mount headrest available in 3 different colors.

HPKG7 1 PAIR 7" HEADREST PACKAGE WITH PILLOW

Screen Size: 7"
 Display Format: 16:9
 Pixels: 800x480
 Power Consumption: 7W
 Power Supply: DC 12V
 Video: Dual Video Input
 System: NTSC/PAL

AVAILABLE IN
 GREY, BLACK & TAN



HCOD-9P 1 PAIR 9" UNIVERSAL MOUNT HEADREST PACKAGE 1 DVD PLAYER AND 1 LCD

Slot-In DVD Player
 Full Function Remote Control
 Built-In IR/FM Transmitter
 Built-In SD/MMC Card Reader
 Built-In 32B Wireless Game
 Built-In USB Jack
 Built-In Speaker, Earphone
 Two Video & Audio Inputs
 One Video & Audio Output
 Multi-Language OSD Menu
 Power Input: DC12V
 800x480 16:9 Widescreen Resolution
 400 NIT Screen Resolution
 With HDMI Jack and Cable
 Unit Size: 10.24 x 8.1 x 2"

AVAILABLE IN
 GREY & TAN

DIY
 CONNECTS TO
 CIGARETTE LIGHTER



SPOTLIGHT DEIVHOOK



DS18 had the privilege to partner with Deivhook at the main HQ located in MIAMI Florida and listen to his drum beats blasting our demo vehicles, the Ford F350 "TROUBLEMAKER" powered with more than 90,000 Watts and 60 speakers in total made this drumming session one of his loudest.

SQ2

SOUND QUALITY BASS AND COMPONENT SET

Complete Copper Installation Kit Included



Subwoofer: SQBASS
8" Subwoofer 2Ω
RMS Power@ 14.4 V DC
2 Ohm: 1 x 150 Watts
THD: <0.5%
Bass Boost: 0 to +12dB
Subsonic Filter: 20Hz
Fuse Rating: 25A

Signal-to-Noise Ratio: >80dB
Low Pass Filter: 50-150Hz
Frequency Response: 20Hz - 150Hz
Input Sensitivity, High Level: 300mV - 10V
Input Sensitivity, Low Level: 100mV - 3.5V
Size L x W x H: 290 x 245 x 77mm

Tweeter: SQTW (pair)
Nominal Impedance: 4Ω
RMS Power: 40 Watts
MAX Power: 120 Watts
Sensitivity: 88dB
Frequency: 2K-20KHz

Voice coil Diameter: 1.1"
Voice Coil Former Material: ASV
Diaphragm Material: Silk Dome
Basket Material: Plastic
Magnet Material: Neodymium

Component Speaker: SQCOMP (pair)
Size: 165mm (6.5")
RMS Power: 60 Watts
MAX Power: 180 Watts
Sensitivity: 91dB
Impedance: 4 OHM
Mounting Depth: 65mm
Mounting Diameter: 135mm

Frequency Response: 45Hz - 20KHz
Mode of Frequency Division: 2-Way
Magnet: NdFeB (Woofer: N38 / Tweeter: N35)
Voice Coil: Woofer:Φ30mm / Tweeter: Φ28MM
Cone Stand Structure: Integrated Structure
Cone: Woofer: Polymerization Resin + High Foam Edge / Tweeter: Silk Film Dome

Wires Specifications:

Tweeter (2 pcs) - 16GA OFC - 3M Long
Remote (1 pc) - 18GA OFC - 5M Long
Negative/Ground (1 pc) - 4GA OFC - .6M Long
Negative/Battery Back (1 pc) - 4GA OFC - .3M Long
High Input (1 pc) - OFC - 1.5M Long
Positive/Power (1 pc) - 4GA OFC - 3.78M Long
RCA (1 pc) - 6" 2-Way

Crossover (pair)

Tweeter Crossover
Frequency Crossover: 3.5KHz
dB/OCT Crossover: 12dB
Woofer Crossover
Frequency Crossover: 3.5KHz
dB/OCT Crossover: 6dB

SQ4

SOUND QUALITY COMPLETE SET

Complete Copper Installation Kit Included



Amplifier: CANDY-X4W
RMS Power@14.4VDC
Power @ 4 Ohms: 4 x 80 Watts
Power @ 2 Ohms: 4 x 120 Watts
Bridged Power @ 4 Ohms: 2 x 240 Watts
Min. Speaker Impedance: 2Ω
THD Distortion: 0.01%
Frequency Response: 20Hz ~ 20KHz
Input Sensitivity: 0.2V ~ +6V
Input Impedance: 10K
Signal-to-Noise Ratio: 100dB
Channel Separation: 50dB
Crossover Network
High Pass Filter: 40Hz ~ 250Hz
Low Pass Filter: 40Hz ~ 250Hz
Bass Boost: 0 dB ~ +12dB
Fuse Rating: 2 x 25A
Size L x W x H: 234.4 x 127 x 44mm

Tweeter:SQTW (pair)
Nominal Impedance: 4Ω
RMS Power: 40 Watts
MAX Power: 120 Watts
Sensitivity: 88dB
Frequency: 2K-20KHz
Voice coil Diameter: 1.1"
Voice Coil Former Material: ASV
Diaphragm Material: Silk Dome
Basket Material: Plastic
Magnet Material: Neodymium

Component Speaker: SQCOMP (pair)

Size: 165mm (6.5")
RMS Power: 60 Watts
MAX Power: 180 Watts
Sensitivity: 91dB
Impedance: 4 OHM
Mounting Depth: 65mm
Mounting Diameter: 135mm
Frequency Response: 45Hz - 20KHz
Mode of Frequency Division: 2-Way
Magnet: NdFeB
Woofer: N38 • Tweeter: N35
Voice Coil:
Woofer:Φ30mm • Tweeter: Φ28MM
Cone Stand Structure: Integrated Structure
Cone: Woofer: Polymerization Resin + High Foam Edge / Tweeter: Silk Film Dome

Wires Specifications:

Tweeter (2 pcs) - 16GA OFC - 3M Long
Amplifier (2 pcs) - 16GA OFC - 4M Long
Remote (1 pc) - 18GA OFC - 5M Long
Negative/Ground (1 pc) - 4GA OFC - .6M Long
Negative/Battery Back (1 pc) - 4GA OFC - .3M Long
High Input (2 pcs) - OFC - 1.5M Long
Positive/Power (1 pc) - 4GA OFC - .5M Long
Positive/Power (1 pc) - 4GA OFC - 2.5M Long
Positive/Power (1 pc) - 4GA OFC - 3.78M Long
Midrange Woofer (2 pcs) - 16GA OFC - .5M Long
Fuse Box (1 pc)
RCA (1 pc) - 6" 2-Way
RCA (1 pc) - 12" 4 Channel

Coaxial Speaker: SQCOAX (pair)
6.5" Coaxial Speaker 4Ω
Mode of Frequency Division: 2-Way
RMS Power: 60 Watts
MAX Power: 180 Watts
Sensitivity: 91dB
Frequency Response: 45Hz - 20KHz
Magnet: NdFeB (Woofer: N38 / Tweeter: N35)
Cone:
Woofer: Bulletproof Fabric + Rubber Edge
Tweeter: Silk Film Dome
Voice Coil:
Woofer: Φ30mm • Tweeter: Φ20mm
Cone Stand Structure: Integrated Structure
Mounting Depth: 69mm
Mounting Diameter: 135mm

Crossover (pair)
Tweeter Crossover
Frequency Crossover: 3.5KHz
dB/OCT Crossover: 12dB
Woofer Crossover
Frequency Crossover: 3.5KHz
dB/OCT Crossover: 6dB

Subwoofer: SQBASS
8" Subwoofer 2Ω
RMS Power@ 14.4 V DC
2 Ohm: 1 x 150 Watts
THD: <0.5%
Bass Boost: 0 to +12dB
Subsonic Filter: 20Hz

Fuse Rating: 25A
Signal-to-Noise Ratio: >80dB
Low Pass Filter: 50-150Hz
Frequency Response: 20Hz - 150Hz
Input Sensitivity, High Level: 300mV - 10V
Input Sensitivity, Low Level: 100mV - 3.5V
Size L x W x H: 290 x 245 x 77mm

SQCOMP

6.5" COMPONENT SPEAKER 4 OHM

Component Speaker: SQCOMP (pair)
Size: 165mm (6.5")
RMS Power: 60 Watts
MAX Power: 180 Watts
Sensitivity: 91dB
Impedance: 4 OHM
Mounting Depth: 65mm
Mounting Diameter: 135mm
Frequency Response: 45Hz - 20KHz

Mode of Frequency Division: 2-Way
Magnet: NdFeB
Woofer: N38
Voice Coil:
Woofer:Φ30mm
Cone Stand Structure: Integrated Structure
Cone: Woofer: Polymerization Resin + High Foam Edge / Tweeter: Silk Film Dome



Crossover Specifications:

Tweeter Crossover
Frequency Crossover: 3.5KHz
dB/OCT Crossover: 12dB
Woofer Crossover
Frequency Crossover: 3.5KHz
dB/OCT Crossover: 6dB

Tweeter: SQTW (pair)
Nominal Impedance: 4Ω
RMS Power: 40 Watts
MAX Power: 120 Watts
Sensitivity: 88dB
Frequency: 2K-20KHz
Voice coil Diameter: 1.1" Voice Coil
Former Material: ASV
Diaphragm Material: Silk Dome
Basket Material: Plastic
Magnet Material: Neodymium

SQCOAX

6.5" COAXIAL SPEAKER 4OHM

Mode of Frequency Division: 2-Way
RMS Power: 60 Watts
MAX Power: 180 Watts
Sensitivity: 91dB
Frequency Response: 45Hz - 20KHz
Mounting Depth: 69mm
Mounting Diameter: 135mm

Magnet: NdFeB (Woofer: N38 / Tweeter: N35)
Cone:
Woofer: Bulletproof Fabric + Rubber Edge
Tweeter: Silk Film Dome
Voice Coil:
Woofer: Φ30mm • Tweeter: Φ20mm
Cone Stand Structure: Integrated Structure



SQTW

1.1" SILK DOME TWEETER

Nominal Impedance: 4Ω
RMS Power: 40 Watts
MAX Power: 120 Watts
Sensitivity: 88dB
Frequency: 2K-20KHz
Built In Attenuation Switch (+3 / 0 -3)dB

Voice coil Diameter: 1.1"
Voice Coil Former Material: ASV
Diaphragm Material: Silk Dome
Basket Material: Plastic
Magnet Material: Neodymium N35



SQBASS

AMPLIFIED SUBWOOFER

8" Subwoofer 2Ω
RMS Power@ 14.4 V DC
2 Ohm: 1 x 150 Watts
THD: <0.5%
Bass Boost: 0 to +12dB
Subsonic Filter: 20Hz
Fuse Rating: 25A

Signal-to-Noise Ratio: >80dB
Low Pass Filter: 50-150Hz
Frequency Response: 20Hz - 150Hz
Input Sensitivity, High Level: 300mV - 10V
Input Sensitivity, Low Level: 100mV - 3.5V
Size L x W x H: 290 x 245 x 77mm



A sense of perfection is necessary when designing a truly good loudspeaker, particularly when you want to produce the best sound quality. DS18 components were developed through a combination of art and science to construct the perfect speaker/crossover combination that will work seamlessly and look good while doing so.

DELUXE2C 2 WAY COMPONENT SET

Passive Crossover (pair)
 12/18 dB Selectable Passive Crossover
 Mid Frequency Adjustable
 Selectable Tweeter Attenuation
 2-Way for Car Audio Speaker systems
 150 Watts RMS Power
 300 Watts MAX Power
 Gold Plated Screw Terminals
 Ferrite and Air Cooled Spools
 Woofer Frequency: 20Hz-3.2KHz
 Tweeter Frequency: 720Hz-20KHz
 High Grade Polymer Capacitors



6.5" Midbass (pair)
 Black Color Aluminum Basket
 28 oz High Strength Ferrite Magnet
 1.5" High Temperature KVC
 Rubber Edge & Aluminum Cone

200 Watts RMS Power
 400 Watts MAX Power
 Impedance: 4 OHMS
 Sensitivity: 89dB
 Frequency Response: 65-20KHz

1" Dome Tweeter (pair)
 High Strength Neodymium Magnet
 1" High Temperature KVC
 30 Watts RMS Power

60 Watts MAX Power
 Impedance: 4 OHMS
 Sensitivity: 95.2dB
 Frequency Response: 920-20 KHz

DELUXE3C 3 WAY COMPONENT SET

Passive Crossover (pair)
 48dB Passive crossover
 3-Way for Car Audio Speaker Systems
 250 Watts RMS Power
 500 Watts MAX Power
 Gold Plated Screw Terminals
 Ferrite and Air Cooled Spools
 Copper Foil Inductance
 Woofer Frequency: 20Hz-800Hz
 Tweeter Frequency: 720Hz-20KHz
 Midrange Frequency: 256Hz-7.8KHz
 High Grade Polymer Capacitors



4" Midrange (pair)
 Red Color Aluminum Basket
 High Strength Neodymium Magnet
 2.0" High Temperature Kapton Voice Coil
 50 Watts RMS Power
 100 Watts MAX Power
 Impedance: 4 OHMS
 Sensitivity: 94.2dB
 Frequency Response: 370-5.5 KHz

6.5" Woofer (pair)
 Black Color Aluminum Basket
 28 oz High Strength Ferrite Magnet
 1.5" High Temperature Kapton Voice Coil
 Rubber Edge & Red Kevlar Cone
 200 Watts RMS Power
 400 Watts MAX Power
 Impedance: 4 OHMS
 Sensitivity: 89dB
 Frequency Response: 65-20KHz

1" Dome Tweeter (pair)
 High strength Neodymium Magnet
 1" High Temperature KVC
 30 Watts RMS Power
 60 Watts MAX Power
 Impedance: 4 OHMS
 Sensitivity: 95.2dB
 Frequency Response: 920-20KHz

When you seek sound quality, it is best to have an idea of what to look for. Sensitivity, frequencies, woofer, tweeter, surround materials, & power handling are all important. EXL SQ Coaxial Speaker brings it all with black glass fiber cone, advanced PEI dome tweeter, neo magnets, die-cast baskets, 1" BASV voice coils, 3 OHMS impedance strontium magnets & machined finish basket surrounds.

EXL



WITH ADVANCED TECHNOLOGY PEI DOME TWEETER

EXL-SQ4 4" 2-WAY COAXIAL SPEAKER

1" (25.5mm) BASV Voice Coil
 Φ0.83" PEI Dome Tweeter
 Neodymium Magnet
 Frequency Response: 115-22KHz
 Sensitivity: 85dB/w/m
 Impedance: 3 OHMS
 60 Watts RMS Power
 260 Watts MAX Power
 Strontium Magnet:
 Φ3.16 x Φ1.27 x 0.47" Y25 (8.94 oz)
 Black Glass Fiber Cone with Rubber Edge



EXL-SQ5.25 5.25" 2-WAY COAXIAL SPEAKER

1" (25.5mm) BASV Voice Coil
 Φ0.83" PEI Dome Tweeter
 Neodymium Magnet
 Frequency Response: 100-22KHz
 Sensitivity: 86dB/w/m
 Impedance: 3 OHMS
 80 Watts RMS Power
 340 Watts Max Power
 Strontium Magnet:
 Φ3.16 x Φ1.27 x 0.47" Y25 (8.94 oz)
 Black Glass Fiber Cone with Rubber Edge



EXL-SQ6.5 6.5" 2-WAY COAXIAL SPEAKER

1.3"(32.88mm) BASV Voice Coil
 Φ1.14" PEI Dome Tweeter
 Neodymium Magnet
 Frequency Response: 80-22KHz
 Sensitivity: 90dB/w/m
 Impedance: 3 OHMS
 120 Watts RMS Power
 400 Watts MAX Power
 Strontium Magnet:
 Φ3.55 x Φ1.58 x 0.6" (13.5oz)
 Black Glass Fiber Cone with Rubber Edge



EXL-SQ6.9 6X9" 2-WAY COAXIAL SPEAKER

1.3" (32.88mm) BASV Voice Coil
 Φ1.14" PEI Dome Tweeter
 Neodymium Magnet
 Frequency Response: 55-22KHz
 Sensitivity: 90dB/w/m
 Impedance: 3 OHMS
 160 Watts RMS Power
 560 Watts MAX Power
 Strontium Magnet:
 Φ3.94 x Φ1.77 x 0.7" Y30 (19.88oz)
 Black Glass Fiber Cone with Rubber Edge



EXL-SQ6.5C 6.5" 2-WAY PACKAGED COMPONENT SET

6.5" Black Paper Cone Speaker
 PU Surround Edge
 120 Watts RMS Power
 400 Watts MAX Power
 1"(25mm) ASV Voice Coil
 Magnet Size: 80x40x15mm (10oz)

Φ38mm/1.5" Slik Dome Tweeter
 Neodymium Magnet
 Frequency Response: 45-22KHz
 Sensitivity: 86dB/w/m
 Impedance: 4 OHMS
 Crossover Network Unit: 3.5KHz, 12dB/oct



ELITE

Keeping top quality sound with a sleek carbon fiber finish, the Elite Series Coaxial Speakers deliver an exceptional feeling that can be enjoyed in all sizes. Ranging from the smallest speaker at 3.5" to the largest at 6x9" these 7 models can be matched to create the most elaborate system you can imagine.



Z-354 3.5" FULL RANGE SPEAKER

40 Watts RMS Power
100 Watts MAX Power
20.5mm/0.8" Voice Coil
Impedance: 4 OHMS
Magnet Size: 4 oz
Sensitivity: 91dB
Frequency Response: 150Hz - 20KHz
Material (Cone): Fiberglass from France



Z-44 4" 2-WAY COAXIAL SPEAKER

50 Watts RMS Power
120 Watts MAX Power
20mm/0.79" PEI DOME Tweeter
25.5mm/1" Voice Coil
Impedance: 4 OHMS
Magnet: 10 oz
Frequency Response: 50Hz-25KHz
Sensitivity: 91dB
Material (cone): Fiberglass from France



Z-464 4X6" 2-WAY COAXIAL SPEAKER

60 Watts RMS Power
120 Watts MAX Power
20mm/.79" PEI DOME Tweeter
25.5mm/1" Voice Coil
Impedance: 4 OHMS
Magnet: 10 oz
Sensitivity: 92dB
Frequency Response: 50Hz - 25KHz
Material (cone) Fiberglass from France



Z-5254 5.25" 2-WAY COAXIAL SPEAKER

60 Watts RMS Power
150 Watts MAX Power
20mm/.79" PEI DOME Tweeter
25.5mm/1" Voice Coil
Impedance: 4 OHMS
Magnet: 10 oz
Frequency Response: 50Hz-25KHz
Sensitivity: 91dB
Material (cone): Fiberglass from France



Z-654 6.5" 2-WAY COAXIAL SPEAKER

80 Watts RMS Power
180 Watts MAX Power
20mm/.79" PEI DOME Tweeter
25.5mm/1" Voice Coil
Impedance: 4 OHMS
Magnet: 14.5 oz
Frequency Response: 45Hz-25KHz
Sensitivity: 93dB
Material (cone): Fiberglass from France



Z-574 5X7" 2-WAY COAXIAL SPEAKER

90 Watts RMS Power
150 Watts MAX Power
20mm/.79" PEI DOME Tweeter
25.5mm/1" Voice Coil
Impedance: 4 OHMS
Magnet: 12oz
Frequency Response: 45Hz-25KHz
Sensitivity: 93dB
Material (cone): Fiberglass from France



Z-694 6X9" 2-WAY COAXIAL SPEAKER

150 Watts RMS Power
240 Watts MAX Power
20mm/0.79" PEI DOME Tweeter

25.5mm/ 1" Voice Coil
Impedance: 4 OHMS
Magnet: 20oz

Sensitivity: 94dB
Frequency Response: 40Hz-25KHz
Material (cone): Fiberglass from France



BLACK DIAMOND

The BL4CK DI4MOND Limited Edition Coaxial Speakers deliver class, sophistication, and power. This series sets itself apart by using the highest quality control and raw materials available for its high-end technology. Woofers resound vigorously through the paper cones to get all the vibrant low frequencies while the midranges and high-frequencies showcase Mylar tweeters. These speakers come in 4-ohm impedance.



BD-X43 4" 3-WAY COAXIAL SPEAKER

Black Paper Cone with Rubber Edge
45 Watts RMS Power
135 Watts MAX Power
1" (25mm) ASV Voice Coil
29mm Mylar Dome Tweeter
φ9mm Mylar Dome Tweeter
Frequency Response: 105~20KHz
Sensitivity: 83dB/w/m
Impedance: 4 OHMS
Magnet Size: φ70×32×10mm



BD-X463 4X6" 3-WAY COAXIAL SPEAKER

Black Paper Cone with Rubber Edge
50 Watts RMS Power
150 Watts MAX Power
1"(25mm) ASV Voice Coil
φ29mm Mylar Dome Tweeter
φ9mm Mylar Dome Tweeter
Frequency Response: 105-20KHz
Sensitivity: 83dB/w/m
Impedance: 4 OHMS
Magnet Size: φ70×φ32×12mm



BD-X5253 5.25" 3-WAY COAXIAL SPEAKER

Black Paper Cone with Rubber Edge
1"(25mm) ASV Voice Coil
50 Watts RMS Power
150 Watts MAX Power
φ29mm Mylar Dome Tweeter
φ9mm Mylar Dome Tweeter
Frequency Response: 95-20KHz
Sensitivity: 84dB/w/m
Impedance: 4 OHMS
Magnet Size: φ70×φ32×12mm



BD-X573 5X7" 3-WAY COAXIAL SPEAKER

Black Paper Cone with Rubber Edge
1"(25mm) ASV Voice Coil
55 Watts RMS Power
165 Watts MAX Power
φ38mm Mylar Dome Tweeter
φ20mm Mylar Dome Tweeter
Sensitivity: 85dB/w/m
Impedance: 4 OHMS
Frequency Response: 78-20KHz
Magnet size: φ80×φ40×15mm



BD-X653 6.5" 3-WAY COAXIAL SPEAKER

Black Paper Cone with Rubber Edge
1"(25mm) ASV Voice Coil
55 Watts RMS Power
165 Watts MAX Power
φ38mm Mylar Dome Tweeter
φ20mm Mylar Dome Tweeter
Frequency Response: 75-20KHz
Sensitivity: 85dB/w/m
Impedance: 4 OHMS
Magnet Size: φ80×φ40×15mm



BD-X693 6X9" 3-WAY COAXIAL SPEAKER

Black Paper Cone with Rubber Edge
1.25"(30mm) ASV Voice Coil
65 Watts RMS Power
195 Watts MAX Power
φ35mm Mylar Dome Tweeter
φ29mm Mylar Dome Tweeter
Sensitivity: 87dB/w/m
Impedance: 4 OHMS
Frequency Response: 65-20KHz
Magnet Size: φ110×φ60×17mm



GEN-X

The GEN-X Coaxial Series features mylar balanced dome tweeters, black paper cones with rubber edges, and sleek mesh grills with red accents. These unique speakers will hit all frequencies with great style. They boast a fine clarity that is unparalleled by any other speaker in their class.

4 OHM



GEN-X4 4" 2-WAY COAXIAL SPEAKER

40 Watts RMS Power
120 Watts MAX Power
1" (25mm) ASV Voice Coil
Impedance: 4 OHMS
Frequency Response: 105-20KHz
Sensitivity: 83dB/w/m
Magnet Size: $\phi 70 \times \phi 32 \times 10$ mm
Black Paper Cone with Rubber Edge
 $\phi 28$ mm Mylar Balanced Dome Tweeter



GEN-X4.6 4X6" 2-WAY COAXIAL SPEAKER

45 Watts RMS Power
135 Watts MAX Power
1" (25mm) ASV Voice Coil
Impedance: 4 OHMS
Black Paper Cone with Rubber Edge
 $\phi 29$ mm Mylar Dome Tweeter
Frequency Response: 105-20KHz
Sensitivity: 83dB/w/m
Magnet Size: $\phi 70 \times \phi 32 \times 12$ mm



GEN-X5.25 5.25" 2-WAY COAXIAL SPEAKER

45 Watts RMS Power
135 Watts MAX Power
1" (25mm) ASV Voice Coil
Impedance: 4 OHMS
Frequency Response: 95-20KHz
Sensitivity: 84dB/w/m
Magnet Size: $\phi 70 \times \phi 32 \times 12$ mm
Black Paper Cone with Rubber Edge
 $\phi 28$ mm Mylar Balanced Dome Tweeter



GEN-X5.7 5X7" 3-WAY COAXIAL SPEAKER

1" (25mm) ASV Voice Coil
50 Watts RMS Power
165 Watts MAX Power
 $\phi 28$ mm Mylar Dome Tweeter
 $\phi 9$ mm Mylar Dome Tweeter
Sensitivity: 85dB/w/m
Impedance: 4 OHMS
Black Paper Cone with Rubber Edge
Frequency Response: 78-20KHz
Magnet size: $\phi 80 \times \phi 40 \times 12$ mm



GEN-X6.5 6.5" 3-WAY COAXIAL SPEAKER

Black Paper Cone with Rubber Edge
1" (25mm) ASV Voice Coil
50 Watts RMS Power
150 Watts MAX Power
 $\phi 28$ mm Mylar Dome Tweeter
 $\phi 9$ mm Mylar Dome Tweeter
Frequency Response: 75-20KHz
Sensitivity: 85dB/w/m
Impedance: 4 OHMS
Magnet Size: $\phi 80 \times \phi 40 \times 12$ mm



GEN-X6.9 6X9" 4-WAY COAXIAL SPEAKER

Black Paper Cone with Rubber Edge
1.25" (30mm) ASV Voice Coil
60 Watts RMS Power
180 Watts MAX Power
 $\phi 28$ mm Mylar Dome Tweeter
 $\phi 20$ mm Mylar Dome Tweeter
Sensitivity: 87dB/w/m
Impedance: 4 OHMS
Frequency Response: 65-20KHz
Magnet Size: $\phi 100 \times \phi 60 \times 18$ mm



GEN-X6.5C 6.5" 2-WAY PACKAGED COMPONENT SET

50 Watts RMS Power
150 Watts MAX Power
1" (25mm) ASV Voice Coil
Impedance: 4 OHMS
Black Paper Cone with Rubber Edge

$\phi 38$ mm/1.5mm Silk Dome Tweeter
Frequency Response: 76-20KHz
Crossover Network Unit: 3.5KHz, 12dB/oct
Sensitivity: 86dB/w/m
Magnet Size: $\phi 80 \times \phi 40 \times 15$ mm



SELECT

The SELECT Speakers were introduced in order to provide undiscovered value. DS18 understands the demands of many inexperienced car audiophiles and fiscally-responsible deal-finders. The Select series offers a variety of speakers; classic, dual cone, & non-pressed paper cone with rubber or foaming suspensions, injection cones, ferrite magnets, and mylar & piezo tweeters

SLC-N4X 4" 4-WAY COAXIAL SPEAKER

Frequency: 100-20KHz
Sensitivity: 82.4dB/w/m
35 Watts RMS Power
140 Watts MAX Power
Magnet: 7.6 oz
Voice Coil: 25mm
Woofer: Injection Cone
Midrange & Tweeter:
30mm Mylar Dome Tweeter
& 2X12mm Piezo Tweeter



SLC-N525X 5.25" 4-WAY COAXIAL SPEAKER

Frequency: 80-20KHz
Sensitivity: 84.5dB/w/m
40 Watts RMS Power
160 Watts MAX Power
Magnet: 10 oz
Voice Coil: 25mm
Woofer: Injection Cone
Midrange & Tweeter:
30mm Mylar Dome Tweeter
& 2X12mm Piezo Tweeter



SLC-N65X 6.5" 4-WAY COAXIAL SPEAKER

Frequency: 65-20KHz
Sensitivity: 84.9dB/w/m
50 Watts RMS Power
200 Watts MAX Power
Magnet: 12 oz
Voice Coil: 25mm
Woofer: Injection Cone
Midrange & Tweeter:
30mm Mylar Dome Tweeter
& 2X15mm Piezo Tweeter



SLC-N69X 6X9" 5-WAY COAXIAL SPEAKER

Frequency: 45-20KHz
Sensitivity: 85.4dB/w/m
65 Watts RMS Power
260 Watts MAX Power
Magnet: 20 oz
Voice Coil: 25mm
Woofer: Injection Cone
Midrange & Tweeter:
35mm Mylar Dome Tweeter
& 27+20+12mm Piezo Tweeter





EXL NEO

NEODYMIUM MAGNET

DS18 amassed a wealth of experience in manufacturing the most elegant neodymium midranges for those seeking simple perfection. Neodymium magnets provide a higher magnetic flux density in the air gap which generates a much greater action force in the voice coil, for this reason neo magnets have the strongest permanent magnets of all the commercially available speakers. Ranging in sizes, mounting depths, and frequency responses, we have more than 10 different models of neo mids to accommodate any build.



EXL-MM64NB

6" NEO FULL RANGE LOUDSPEAKER

Black Aluminum Basket
200 Watts RMS Power
400 Watts MAX Power
Impedance: 4 OHMS
Sensitivity: 95 dB

Frequency Response: 100Hz - 16KHz
Cloth Edge And Non-Pressed Paper Cone
High Strength Neodymium Magnet
1.5" Kapton Voice Coil

EXL-MM84NB

8" NEO FULL RANGE LOUDSPEAKER

Black Aluminum Basket
250 Watts RMS Power
500 Watts MAX Power
Impedance: 4 OHMS
Sensitivity: 96 dB

Frequency Response: 80Hz - 16KHz
Cloth Edge And Non-Pressed Paper Cone
High Strength Neodymium Magnet
1.5" Kapton Voice Coil



6.5"

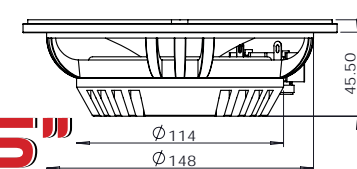

8"

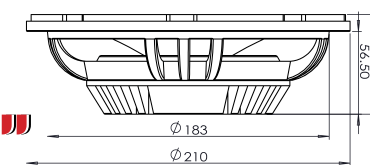

PRO-NEO6SLIM

6.5" SHALLOW NEO MIDRANGE LOUDSPEAKER WITH BULLET

Black Aluminum Basket
200 Watts RMS Power
400 Watts MAX Power
Impedance: 4 OHMS
Sensitivity: 96 dB

Frequency Response: 136 - 11 KHz
Cloth Edge And Non-Pressed Paper Cone
High Strength Neodymium Magnet
1.5" KCCA W 2 Layer Voice Coil

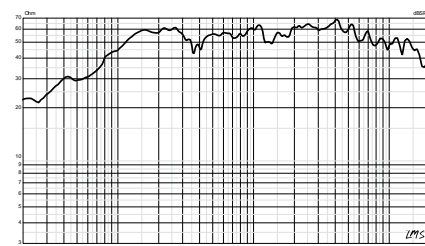

PRO-NEO8SLIM

8" SHALLOW NEO MIDRANGE LOUDSPEAKER WITH BULLET

Black Aluminum Basket
250 Watts RMS Power
300 Watts MAX Power
Impedance: 4 OHMS
Sensitivity: 95 dB

Frequency Response: 123 - 13.7KHz
Cloth Edge And Non-Pressed Paper Cone
High Strength Neodymium Magnet
2" KCCA W Voice Coil

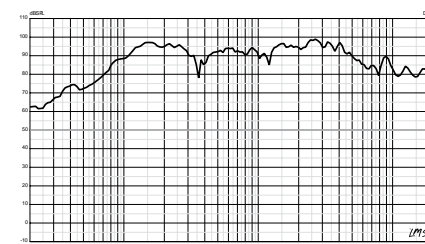

6.5"

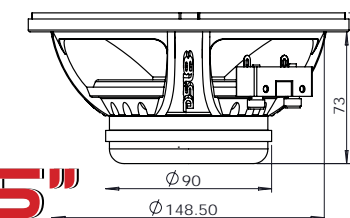

8"

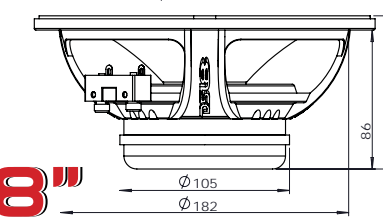

PRO-NEO6

6.5" NEO MIDRANGE LOUDSPEAKER

Heavy Duty Aluminum Basket
250 Watts RMS Power
500 Watts MAX Power
Impedance: 4 OHMS
Sensitivity: 96 dB

Frequency Response: 124 - 9.7 KHz
Cloth Edge And Non-Pressed Paper Cone
High Strength Neodymium Magnet
1.5" KCCA W 2 Layer Voice Coil

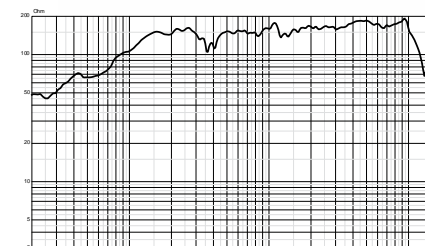

PRO-NEO8

8" NEO MIDRANGE LOUDSPEAKER

Heavy Duty Aluminum Basket
300 Watts RMS Power
600 Watts MAX Power
Impedance: 4 OHMS
Sensitivity: 98.9 dB

Frequency Response: 95 - 9.5 KHz
Cloth Edge And Non-Pressed Paper Cone
High Strength Neodymium Magnet
1.5" KCCA W 2 Layer Voice Coil

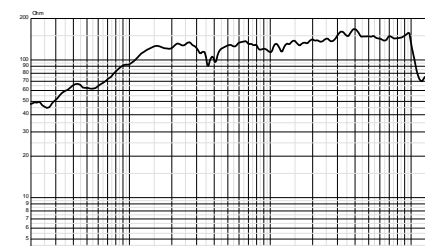



PRO



4 OHM

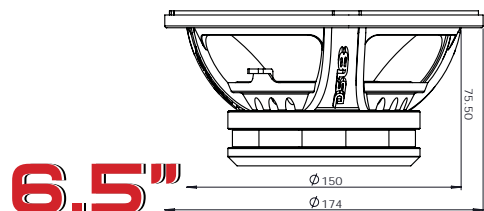

6.5"

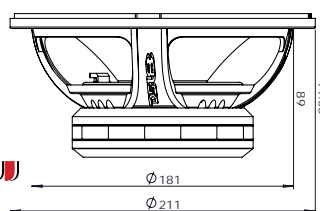

8"

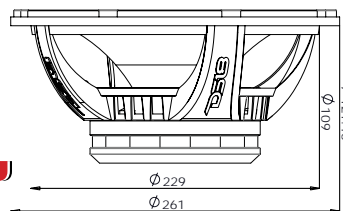

10"

PRO-NEO6R

**6.5" MIDRANGE LOUDSPEAKER
HIGH GRADE NEODYMIUM RINGS MAGNET**

Red Aluminum Basket
300 Watts RMS Power
600 Watts MAX Power
Impedance: 4 OHMS
Sensitivity: 95 dB

High Grade 12 Oz Neodymium Rings Magnet
Cloth Edge And Non-Pressed Paper Cone
2" KCCA W Voice Coil
Frequency Response: 65 - 14.2KHz

PRO-NEO8R

**8" MIDRANGE LOUDSPEAKER
HIGH GRADE NEODYMIUM RINGS MAGNET**

Red Aluminum Basket
400 Watts RMS Power
800 Watts MAX Power
Impedance: 4 OHMS
Sensitivity: 95.2 dB

High Grade 15 Oz Neodymium Rings Magnet
Cloth Edge And Non-Pressed Paper Cone
2.2" TICCA W Voice Coil
Frequency Response: 62 - 11KHz

PRO-NEO10R

**10" MIDRANGE LOUDSPEAKER
HIGH GRADE NEODYMIUM RINGS MAGNET**

Red Aluminum Basket
500 Watts RMS Power
1000 Watts MAX Power
Impedance: 4 OHMS
Sensitivity: 98 dB

High Grade 18 Oz Neodymium Rings Magnet
Cloth Edge And Non-Pressed Paper Cone
2.5" TICCA W Voice Coil
Frequency Response: 60 - 11KHz

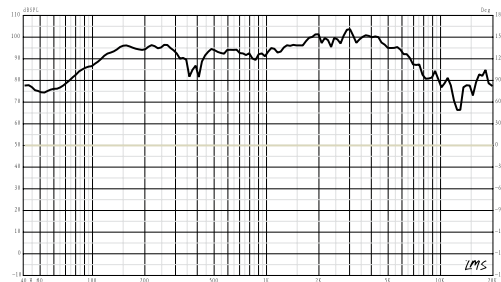
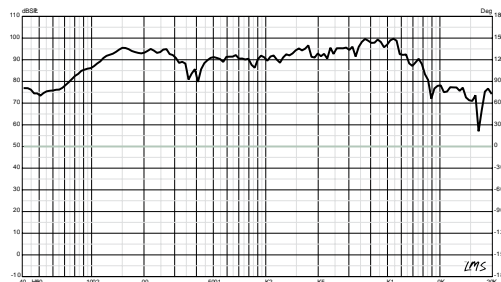
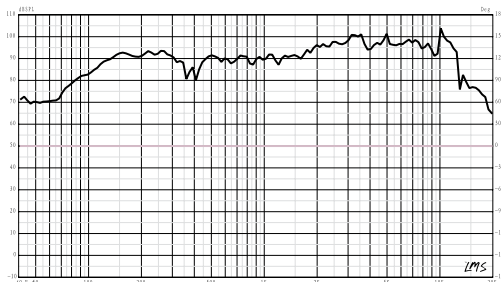

PRO



4 OHM

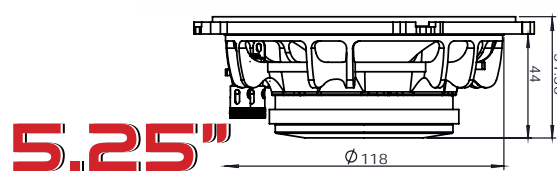

5.25"

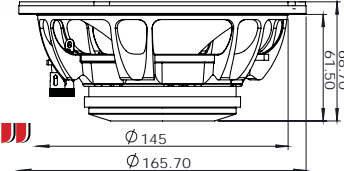

6.5"

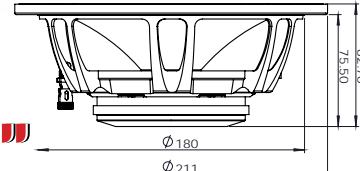

8"

PRO-FR5NEO

5.25" NEO FULL RANGE LOUDSPEAKER WITH BULLET

Heavy Duty Aluminum Basket
High Strength Neodymium Magnet
1.2" KCCA W 2 Layer Voice Coil
200 Watts RMS Power
400 Watts MAX Power

Impedance: 4 OHMS
Sensitivity 94.6dB
Cloth Edge and Non-Pressed Paper Cone
Frequency Response: 242-13.6 KHz

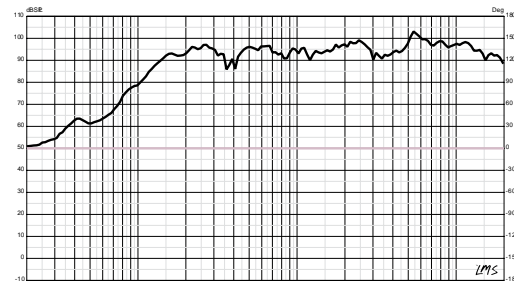

PRO-FR6NEO

6.5" NEO FULL RANGE LOUDSPEAKER WITH BULLET

Heavy Duty Aluminum Basket
High Strength Neodymium Magnet
1.5" KCCA W 2 Layer Voice Coil
250 Watts RMS Power
500 Watts MAX Power

Impedance: 4 OHMS
Sensitivity: 97.8 dB
Cloth Edge and Non-Pressed Paper Cone
Frequency Response: 151-12.5 KHz

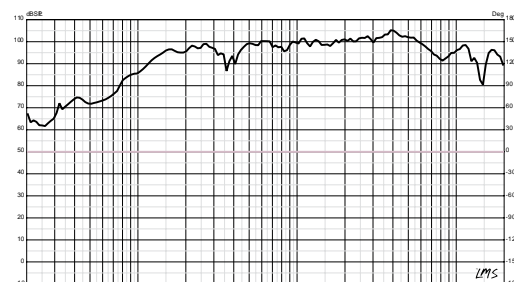

PRO-FR8NEO

8" NEO FULL RANGE LOUDSPEAKER WITH BULLET

Heavy Duty Aluminum Basket
High Strength Neodymium Magnet
1.5" KCCA W 2 Layer Voice Coil
250 Watts RMS Power
500 Watts MAX Power

Impedance: 4 OHMS
Sensitivity: 100.5 dB
Cloth Edge and Non-Pressed Paper Cone
Frequency Response: 128-14.8KHz

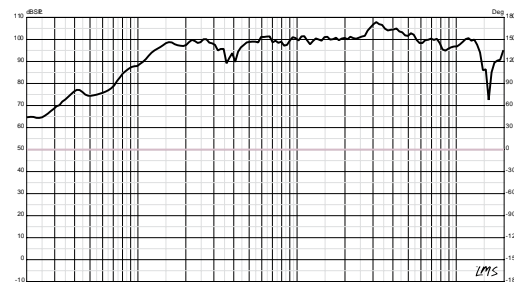

TROUBLEMAKER

The TroubleMaker Midbass Series is the strongest and most powerful in the industry, it has the majority of the most critical audio information in its frequencies. The dominant energy of the human voice, whether speaking or singing, is found in the midrange, as well as that of many musical instruments. The TroubleMaker Midbass foundation adds unparalleled realism to overtones from drum strikes, kettle drums, pianos, guitars, low strings, and all 45-16.8 KHz frequencies.

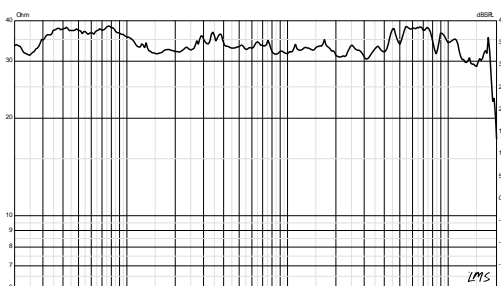
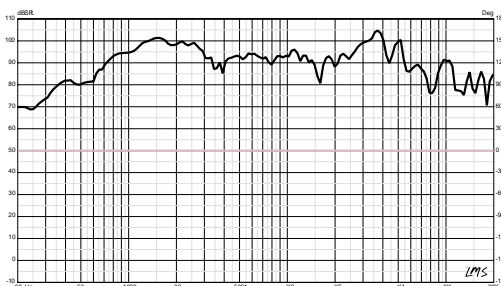
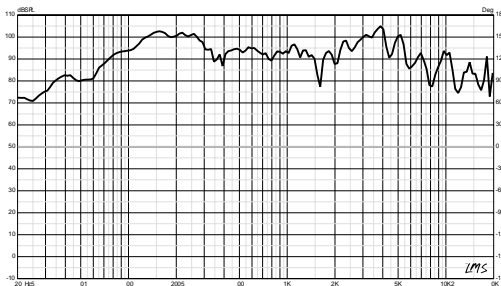
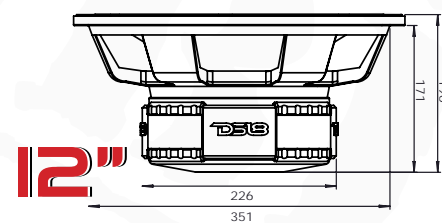
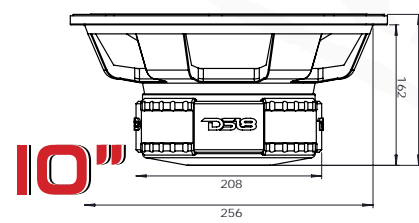
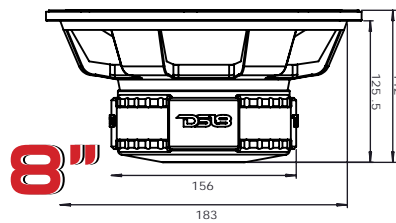

TM-MB8.2

8" MIDBASS 2 OHMS



Black Color Aluminum Basket
Cloth Edge and Non-Pressed Paper Cone
3" Black Aluminum 4 Layer Voice Coil
1200 Watts RMS Power
2000 Watts MAX Power

Impedance: 2 OHMS
Sensitivity: 95.2dB
Frequency Response: 81-6.8KHz
2X49 oz High Strength Double Ferrite Magnet

TM-MB8.D2

8" MIDBASS 2+2 OHMS



Black Color Aluminum Basket
Cloth Edge and Non-Pressed Paper Cone
3" Black Aluminum 4 Layer Voice Coil
1200 Watts RMS Power
2000 Watts MAX Power

Impedance: 2+2 OHMS
Sensitivity: 94 dB
Frequency Response: 84-6.5KHz
2X49 oz High Strength Double Ferrite Magnet

TM-MB10

10" MIDBASS 4 OHMS



Black Color Aluminum Basket
Cloth Edge and Non-Pressed Paper Cone
3" Black Aluminum 4 Layer Voice Coil
2000 Watts RMS Power
3000 Watts MAX Power

Impedance: 4 OHMS
Sensitivity: 97.5dB
Frequency Response: 52-16.8KHz
2X110 oz High Strength Double Ferrite Magnet

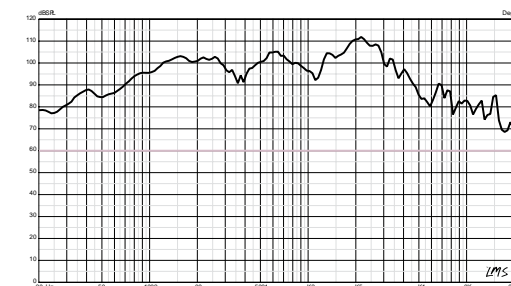
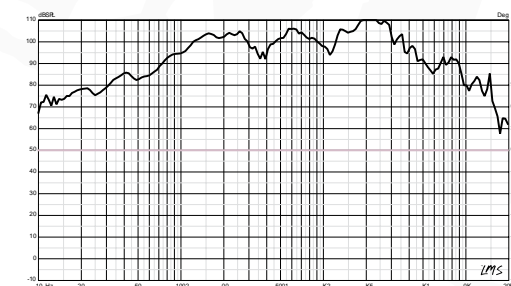
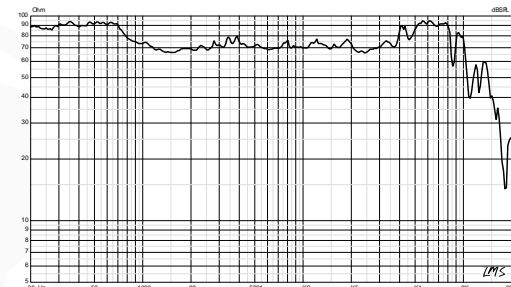
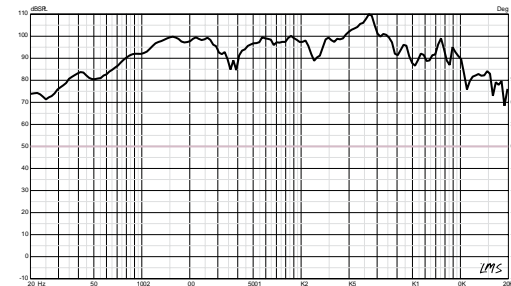
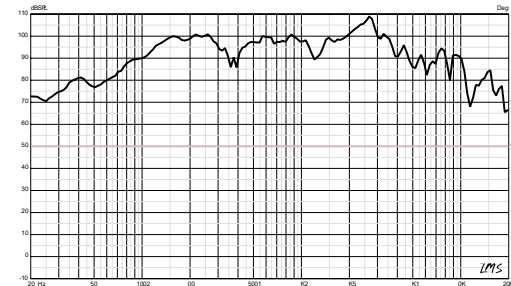

TM-MB10.2

10" MIDBASS 2 OHMS



Black Color Aluminum Basket
Cloth Edge and Non-Pressed Paper Cone
3" Black Aluminum 4 Layer Voice Coil
2000 Watts RMS Power
3000 Watts MAX Power

Impedance: 2 OHMS
Sensitivity: 100dB
Frequency Response: 64-9.5KHz
2X115 oz High Strength Double Ferrite Magnet

TM-MB10.D2

10" MIDBASS 2+2 OHMS



Black Color Aluminum Basket
Cloth Edge and Non-Pressed Paper Cone
3" Black Aluminum 4 Layer Voice Coil
2000 Watts RMS Power
3000 Watts MAX Power

Impedance: 2 + 2 OHMS
Sensitivity: 99dB
Frequency Response: 63-9.2KHz
2X115 oz High Strength Double Ferrite Magnet

TM-MB12

12" MIDBASS 4 OHMS



Black Color Aluminum Basket
Cloth Edge and Non-Pressed Paper Cone
4" Black Aluminum 4 Layer Voice Coil
2500 Watts RMS Power
3750 Watts MAX Power

Impedance: 4 OHMS
Sensitivity: 100.5dB
Frequency Response: 45-11.0KHz
2X130 oz High Strength Double Ferrite Magnet

TM-MB12.2

12" MIDBASS 2 OHMS



Black Color Aluminum Basket
Cloth Edge and Non-Pressed Paper Cone
4" Black Aluminum 4 Layer Voice Coil
2500 Watts RMS Power
3750 Watts MAX Power

Impedance: 2 OHMS
Sensitivity: 103dB
Frequency Response: 53-3.7KHz
2X130oz High Strength Double Ferrite Magnet

TM-MB12.D2

12" MIDBASS 2+2 OHMS



Black Color Aluminum Basket
Cloth Edge and Non-Pressed Paper Cone
4" Black Aluminum 4 Layer Voice Coil
2500 Watts RMS Power
3750 Watts MAX Power

Impedance: 2+2 OHMS
Sensitivity: 102dB
Frequency Response: 53-3.3KHz
2X130oz High Strength Double Ferrite Magnet



4 OHM



EXL

The people who live and breathe car audio demanded a higher-performing, extremely effect and dynamic product series. After several months and money allocated to R&D, DS18 is proud to launch the PRO-EXL Extremely Loud midrange series. There are the epitome of competition-quality midranges. Red aluminum baskets, cloth-edges, non-pressed paper cone, and the option for 8-ohm or 4-ohm impedance; these are only the basic components, the rest is pure DS18 technology.

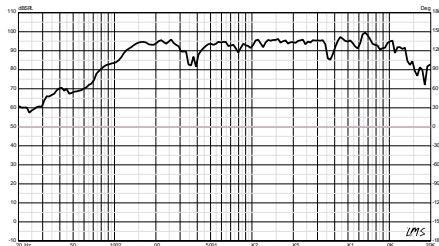

PRO-EXL64

6.5" MIDRANGE LOUDSPEAKER 4 OHMS

Red Aluminum Basket
300 Watts RMS Power
600 Watts MAX Power
Impedance: 4 OHMS
Sensitivity: 93 dB

2.0" KCCAW Voice Coil
Cloth Edge And Non-Pressed Paper Cone
34 oz High Strength Ferrite Magnet
Frequency Response: 136 - 14.7KHz

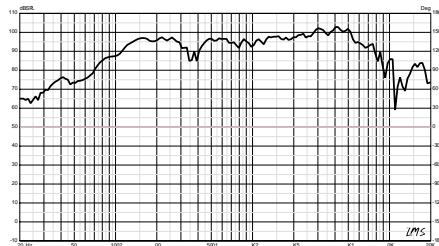
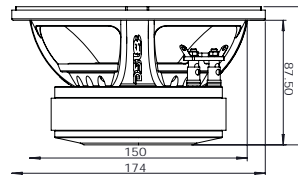

PRO-EXL84

8" MIDRANGE LOUDSPEAKER 4 OHMS

Red Aluminum Basket
400 Watts RMS Power
800 Watts MAX Power
Impedance: 4 OHMS
Sensitivity: 97dB

2.0" KCCAW Voice Coil
Cloth Edge And Non-Pressed Paper Cone
49 oz High Strength Ferrite Magnet
Frequency Response: 100 - 11.3KHz

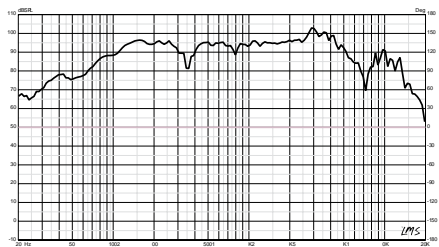
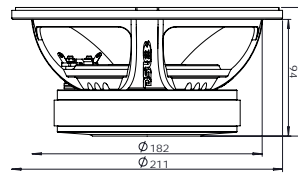

PRO-EXL104

10" MIDRANGE LOUDSPEAKER 4 OHMS

Red Aluminum Basket
600 Watts RMS Power
1000 Watts MAX Power
Impedance: 4 OHMS
Sensitivity: 96dB

3.0" KCCAW Voice Coil
Cloth Edge And Non-Pressed Paper Cone
80 oz High Strength Ferrite Magnet
Frequency Response: 85 - 12KHz

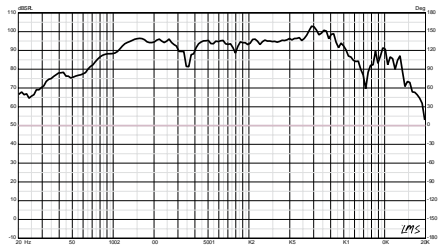
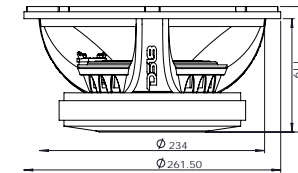

PRO-EXL104MBASS

10" MIDBASS LOUDSPEAKER 4 OHMS

Red Aluminum Basket
600 Watts RMS Power
1000 Watts MAX Power
Impedance 4 OHMS
Sensitivity 96dB

3.0" KCCAW Voice Coil
Cloth Edge And Non-Pressed Paper Cone
80 oz High Strength Ferrite Magnet
Frequency Response 72 - 10.5KHz

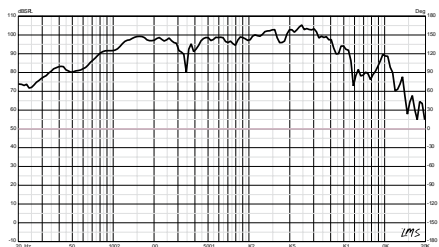
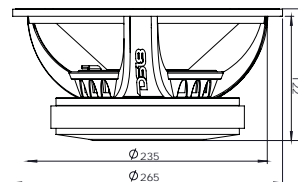

PRO-EXL124

12" MIDRANGE LOUDSPEAKER 4 OHMS

Red Aluminum Basket
800 Watts RMS Power
1200 Watts MAX Power
Impedance: 4 OHMS
Sensitivity: 97dB

3.0" KCCAW Voice Coil
Cloth Edge And Non-Pressed Paper Cone
80 oz High Strength Ferrite Magnet
Frequency Response: 57 - 9.7KHz

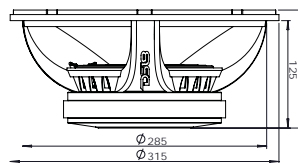

8 OHM



EXL

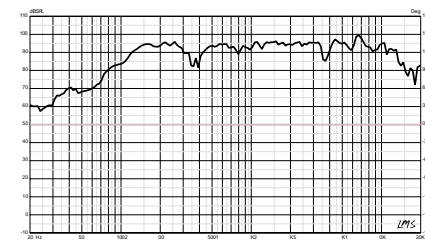

PRO-EXL68

6.5" MIDRANGE LOUDSPEAKER 8 OHMS

Red Aluminum Basket
300 Watts RMS Power
600 Watts MAX Power
Impedance 8 OHMS
Sensitivity 93 dB

2.0" KCCAW Voice Coil
Cloth Edge And Non-Pressed Paper Cone
34 oz High Strength Ferrite Magnet
Frequency Response 100 - 14.7KHz

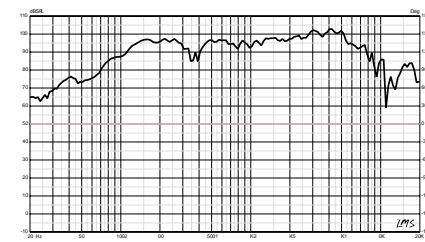
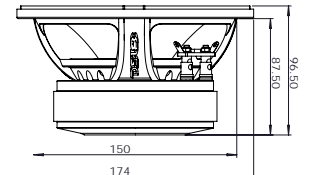

PRO-EXL88

8" MIDRANGE LOUDSPEAKER 8 OHMS

Red Aluminum Basket
400 Watts RMS Power
800 Watts MAX Power
Impedance 8 OHMS
Sensitivity 96dB

2.0" KCCAW Voice Coil
Cloth Edge And Non-Pressed Paper Cone
49 oz High Strength Ferrite Magnet
Frequency Response 94 - 10KHz

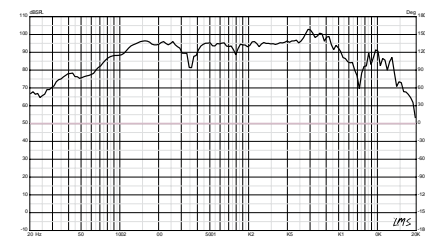
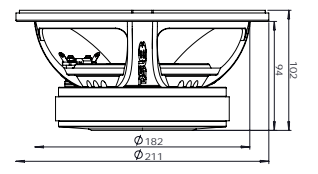

PRO-EXL108

10" MIDRANGE LOUDSPEAKER 8 OHMS

Red Aluminum Basket
600 Watts RMS Power
1000 Watts MAX Power
Impedance 8 OHMS
Sensitivity 97dB

3.0" KCCAW Voice Coil
Cloth Edge And Non-Pressed Paper Cone
80 oz High Strength Ferrite Magnet
Frequency Response 74 - 11.5KHz

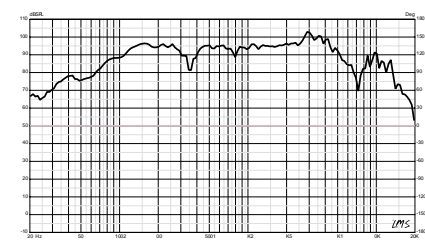
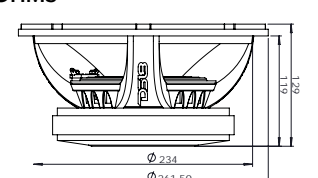

PRO-EXL108MBASS

10" MIDBASS LOUDSPEAKER 8 OHMS

Red Aluminum Basket
600 Watts RMS Power
1000 Watts MAX Power
Impedance 8 OHMS
Sensitivity 96dB

3.0" KCCAW Voice Coil
Cloth Edge And Non-Pressed Paper Cone
80 oz High Strength Ferrite Magnet
Frequency Response 72 - 8KHz

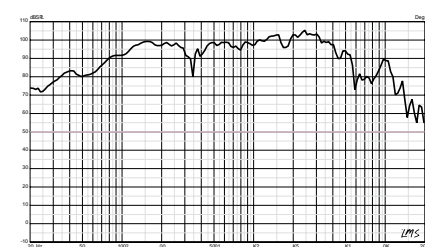
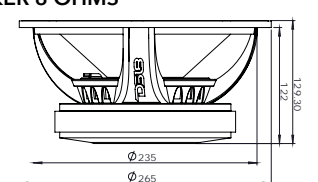

PRO-EXL128

12" MIDRANGE LOUDSPEAKER 8 OHMS

Red Aluminum Basket
800 Watts RMS Power
1200 Watts MAX Power
Impedance 8 OHMS
Sensitivity 98dB

3.0" KCCAW Voice Coil
Cloth Edge And Non-Pressed Paper Cone
80 Oz High Strength Ferrite Magnet
Frequency Response 92 - 9.5KHz

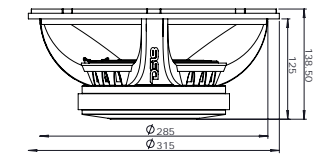

The Hybrid Series Midrange Speakers are a new technology that was developed to allow for the installation of a horn driver in the middle of the speaker. The driver/mid combination allows for more frequencies to blend in while making the outcome much louder. PRO-DR550 is the recommended driver for the Hybrid Series.

PRO

DRIVER RECOMMENDED

PRO-DR550: PAGE 63
SOLD SEPARATELY



8 OHM

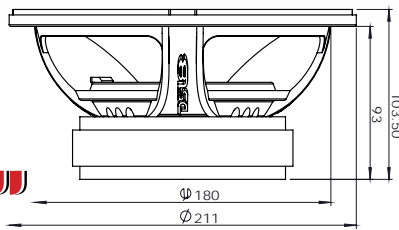

8"

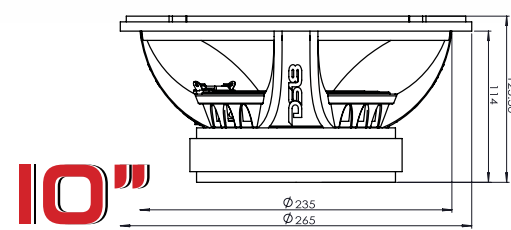

10"

PRO-HYBRID8

8" MIDRANGE COAXIAL DRIVER

Black Plastic Horn
200 Watts RMS Power
400 Watts MAX Power
Impedance 8 OHMS
Sensitivity: 95.6dB
Black Aluminum Basket
Frequency Response: 94-7.5KHz

Cloth Edge And Non-Pressed Paper Cone
44.5 oz High Strength Ferrite Magnet
2" High Temperature CCAR Voice Coil Driver
Material: Pc/Abs
Profile: Circular • Coverage: 45° X 45°
Throat Diameter: 1.4"
Installation Mode: Twist

PRO-HYBRID10

10" MIDRANGE COAXIAL DRIVER

Black Plastic Horn
300 Watts RMS Power
600 Watts MAX Power
Impedance: 8 OHMS
Sensitivity: 95.7dB
Black Aluminum Basket
Frequency Response: 81-5.7KHz

Cloth Edge and Non-Pressed Paper Cone
77.5 oz High Strength Ferrite Magnet
2" High Temperature KASV Voice Coil
1" Screw-On Driver Type Horn (Not Included)
Profile: Circular • Coverage: 45° x 45°
Throat Diameter: 1.4"
Installation Mode: Twist

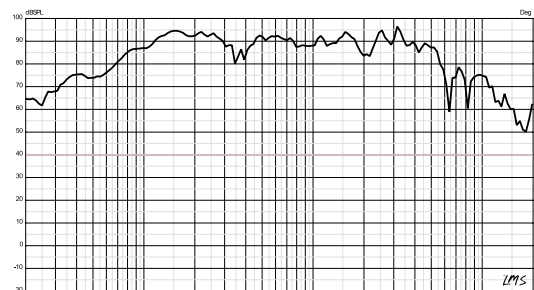
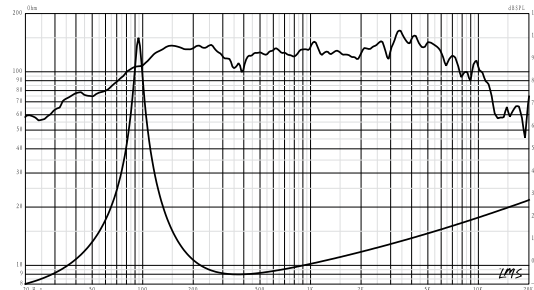

8 OHM

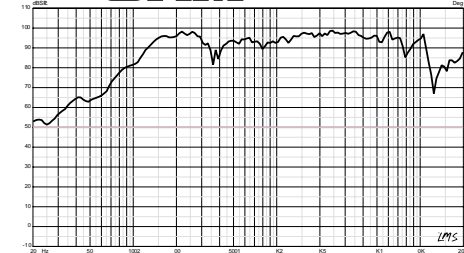

PRO-H6EDGE

6.5" MIDHIGH LOUDSPEAKER

Red Steel Basket
250 Watts RMS Power
500 Watts MAX Power

Impedance 8 OHMS
Sensitivity 97dB
Frequency Response 196 - 12.5KHz

30 oz High Strength Ferrite Magnet
Cloth Edge And Non-Pressed Paper Cone
1.5" High Temperature KCCAW Voice Coil

6.5"

8"

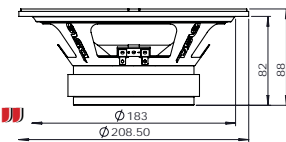
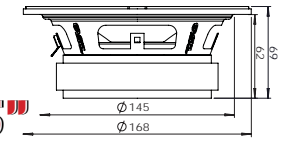

PRO

New Edge Cone Design Increases Cone Surface Area
Increasing Efficiency and Sound Quality



8 OHM

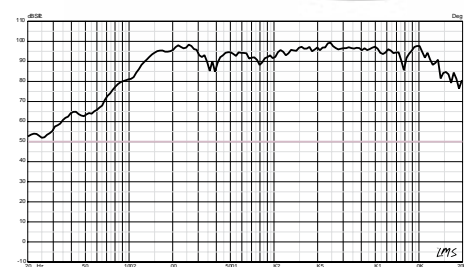

PRO-HB6EDGE

6.5" MIDHIGH LOUDSPEAKER WITH BULLET

Red Steel Basket
Red Aluminum Bullet
250 Watts RMS Power
500 Watts MAX power
Impedance: 8 Ohms

Sensitivity: 98 dB
30 Oz High Strength Ferrite Magnet
Frequency Response: 203-14.7KHz
Cloth Edge and Non-Pressed Paper Cone
1.5" High Temperature KCCAW Voice Coil

6.5"

8"

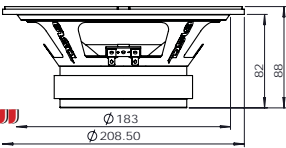
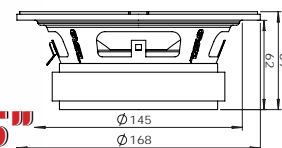

PRO

PRO-HB8EDGE

8" MIDHIGH LOUDSPEAKER WITH BULLET

Red Steel Basket
Red Aluminum Bullet
275 Watts RMS Power
550 Watts MAX power
Impedance: 8 OHMS

Sensitivity: 99dB
30 Oz High Strength Ferrite Magnet
Frequency Response: 135-14.2KHz
Cloth Edge and Non-Pressed Paper Cone
1.5" High Temperature KCCAW Voice Coil

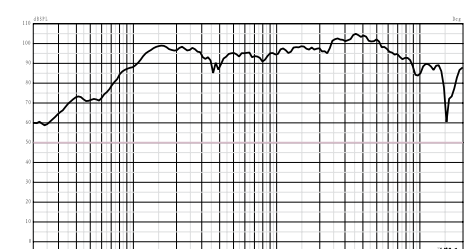



4 OHM

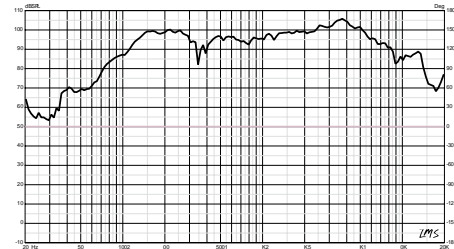
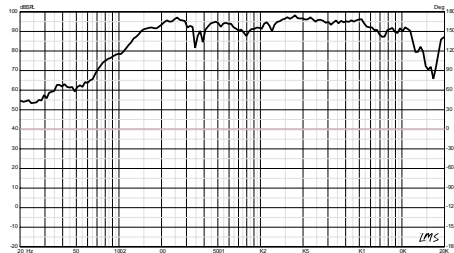

PRO

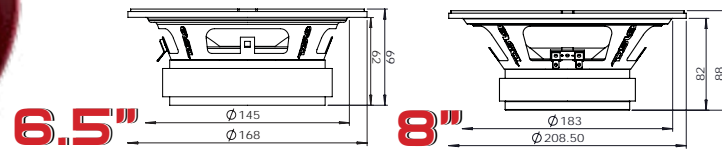

PRO-HB6.4EDGE

6.5" MIDHIGH LOUDSPEAKER 4 OHMS WITH BULLET

Red Steel Basket
Red Aluminum Bullet
250 Watts RMS Power
500 Watts MAX power

Impedance: 4 OHMS
Sensitivity: 96dB
30 oz High Strength Ferrite Magnet
Frequency Response: 240-15.2KHz

Cloth Edge and Non-Pressed Paper Cone
1.5" High Temperature KCCAW Voice Coil

PRO-HB8.4EDGE

8" MIDHIGH LOUDSPEAKER 4 OHMS WITH BULLET

Red Steel Basket
Red Aluminum Bullet
275 Watts RMS Power
550 Watts MAX power

Impedance: 4 OHMS
Sensitivity: 99dB
30 oz High Strength Ferrite Magnet
Frequency Response: 160-14.7KHz

Cloth Edge and Non-Pressed Paper Cone
1.5" High Temperature KCCAW Voice Coil



8 OHM

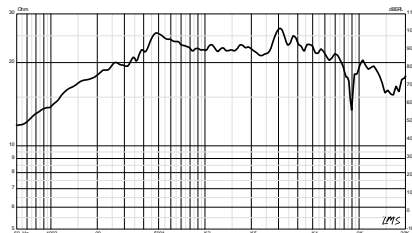
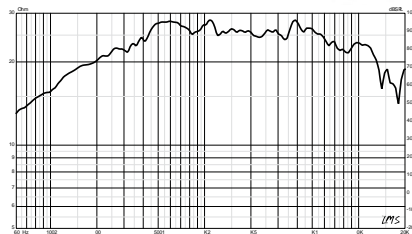

PRO

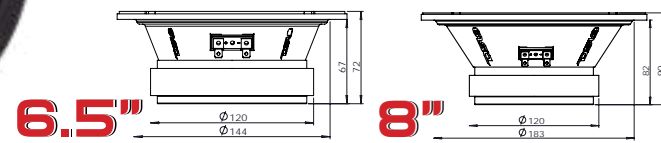

PRO-X6MSE

6.5" MIDRANGE LOUDSPEAKER SEALED BACK

Red Steel Basket
225 Watts RMS Power
450 Watts MAX Power
Impedance: 8 OHMS

Sensitivity: 92dB
Two Wave Edge
Frequency Response: 511-13.5KHz
33oz High Strength Ferrite Magnet

Cloth Edge and Non-Pressed Paper Cone
1.5" KCCAW 2 Layer Voice Coil
Cross Wire on Spider Suspension

PRO-X8MSE

8" MIDRANGE LOUDSPEAKER SEALED BACK

Red Steel Basket
275 Watts RMS Power
550 Watts MAX Power
Impedance: 8 OHMS

Sensitivity: 98.2dB
Two Wave Edge
Frequency Response: 482-11.5KHz
33oz High Strength Ferrite Magnet

Cloth Edge and Non-pressed Paper Cone
1.5" KCCAW 2 Layer Voice Coil
Cross Wire on Spider Suspension

PRO



8 OHM

VOTED #1
Midrange in the Market

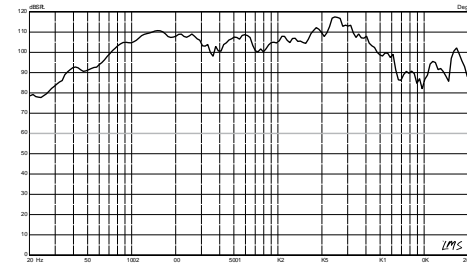
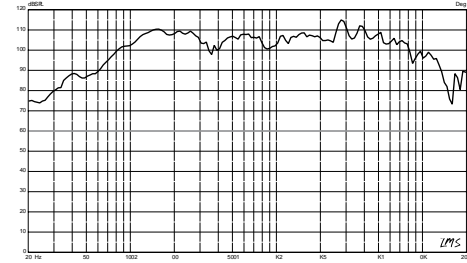
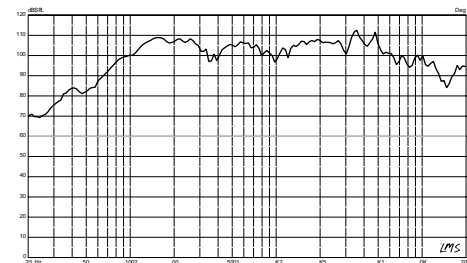
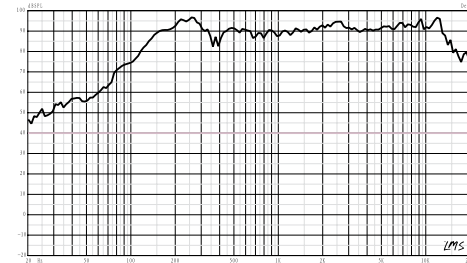
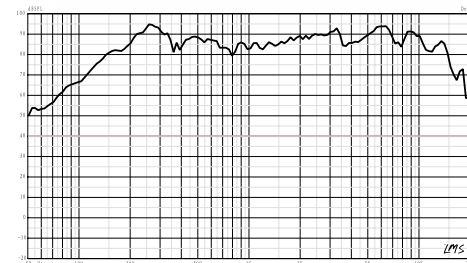

PRO-X4M

4" MIDRANGE LOUDSPEAKER 8 OHMS

Red Steel Basket
100 Watts RMS Power
200 Watts MAX Power
Impedance: 8 OHMS
Sensitivity: 85.7dB

Frequency Response: 298-14.2KHz
9 oz High Strength Ferrite Magnet
1" High Temperature KCCAW Voice Coil
Cloth Edge and Non-Pressed Paper Cone

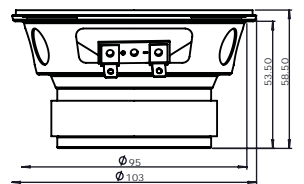

PRO-X5M

5.25" MIDRANGE LOUDSPEAKER 8 OHMS

Red Steel Basket
150 Watts RMS Power
300 Watts MAX Power
Impedance: 8 OHMS
Sensitivity: 90.4dB

Frequency Response: 245-13.5KHz
18.5 oz High Strength Ferrite Magnet
1.2" High Temperature KCCAW Voice Coil
Cloth Edge And Non-Pressed Paper Cone

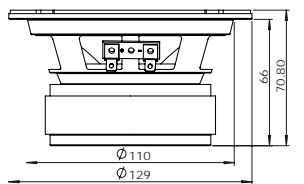

PRO-X6M

6.5" MIDRANGE LOUDSPEAKER 8 OHMS

Red Steel Basket
225 Watts RMS Power
450 Watts MAX Power
Impedance: 8 OHMS
Sensitivity: 92dB

Frequency Response: 115-150KHz
30 oz High Strength Ferrite Magnet
Cloth Edge and Non-Pressed Paper Cone
1.5 High Temperature CCAR Voice Coil

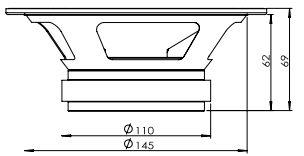

PRO-X8M

8" MIDRANGE LOUDSPEAKER 8 OHMS

Red Steel Basket
275 Watts RMS Power
550 Watts MAX Power
Impedance: 8 OHMS
Sensitivity: 98.2dB

Frequency Response: 100-13KHz
30 oz High Strength Ferrite Magnet
Cloth Edge and Non-Pressed Paper Cone
1.5" High Temperature CCAR Voice Coil

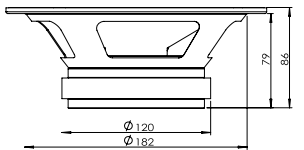

PRO-X10M

10" MIDRANGE LOUDSPEAKER 8 OHMS

Red Steel Basket
300 Watts RMS Power
600 Watts MAX Power
Impedance: 8 OHMS
Sensitivity: 100.2dB

Frequency Response: 76-6.8KHz
40 oz High Strength Ferrite Magnet
Cloth Edge and Non-Pressed Paper Cone
2" High Temperature CCAR Voice Coil

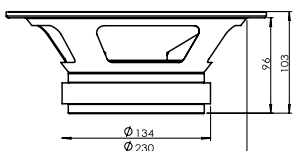



8 OHM

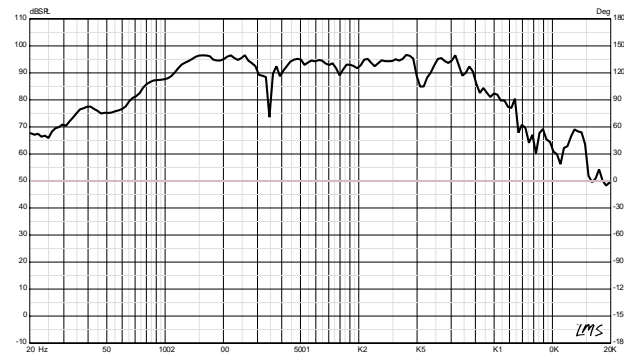

PRO-X10MBASS

10" MIDBASS LOUDSPEAKER

- Black Steel Basket
- 400 Watts RMS Power
- 800 Watts MAX Power
- Impedance: 8 OHMS
- Sensitivity: 96.3dB
- Frequency Response: 80Hz-6.3KHz
- 60oz High Strength Ferrite Magnet
- Cloth Edge and Non-Pressed Paper Cone
- 2.5" High Temperature KASV Voice Coil

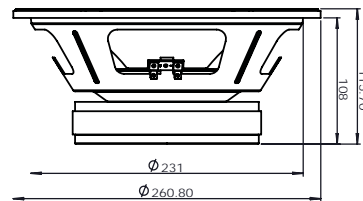

During the focused R&D period of perfecting the PRO-EXL line, DS18 identified the opportunity to spawn off another line since there was a division amongst competition audiophiles and concert/"voceteo" audiophiles. Therefore, DS18 created the PRO audio line, which features a wide variety of midranges the produce concert-like sounds that will knock the wind out of you.



8 OHM

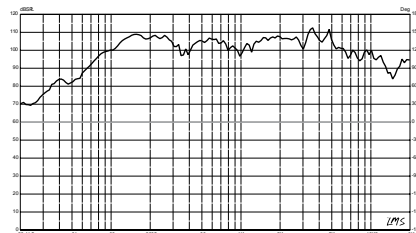

PRO-X6BM

6.5" MIDRANGE LOUDSPEAKER WITH BULLET

- Red Steel Basket
- Red Aluminum Bullet
- 250 Watts RMS Power
- 500 Watts MAX Power
- Impedance: 8 OHMS
- Two Wave Edge
- Sensitivity: 90dB
- Frequency response: 118-17KHz
- 30 oz High Strength Ferrite Magnet
- Cloth Edge And Non-Pressed Paper Cone
- 1.5" High Temperature CCAR Voice Coil
- Cross Wire on Spider Suspension

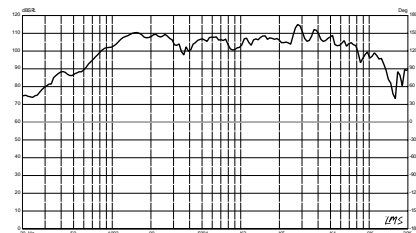
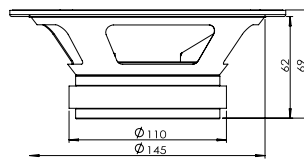

PRO-X8BM

8" MIDRANGE LOUDSPEAKER WITH BULLET

- Red Steel Basket
- Red Aluminum Bullet
- 275 Watts RMS Power
- 550 Watts MAX Power
- Impedance: 8 OHMS
- Two Wave Edge
- Sensitivity: 97dB
- Frequency Response: 100-16KHz
- 30oz High Strength Ferrite Magnet
- Cloth Edge and Non-Pressed Paper Cone
- 1.5" High Temperature CCAR Voice Coil
- Cross Wire on Spider Suspension

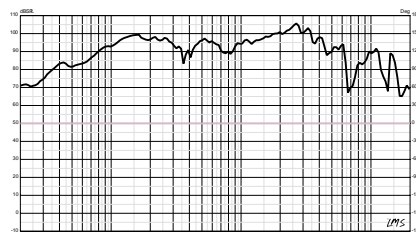
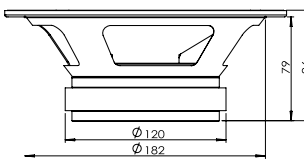

PRO-X10BM

10" MIDRANGE LOUDSPEAKER WITH BULLET

- Red Steel Basket
- Red Aluminum Bullet
- 300 Watts RMS Power
- 600 Watts MAX Power
- Impedance: 8 OHMS
- Two Wave Edge
- Sensitivity: 98dB
- Frequency Response: 77-11.2KHz
- 41 Oz High Strength Ferrite Magnet
- Cloth Edge and Non-Pressed Paper Cone
- 2" High Temperature KCCAW Voice Coil
- Cross Wire on Spider Suspension

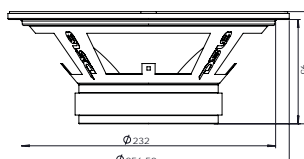

4 OHM

PRO-X4.4BM

4" MIDRANGE LOUDSPEAKER 4 OHMS

- Red Steel Basket
- Red Aluminum Bullet
- 100 Watts RMS Power
- 200 Watts MAX Power
- Impedance 4 OHMS
- Sensitivity 89.6dB
- Frequency Response 260-11.5KHz
- 10 oz High Strength Ferrite Magnet
- 1" High Temperature KCCAW Voice Coil
- Cloth Edge and Non-Pressed Paper Cone

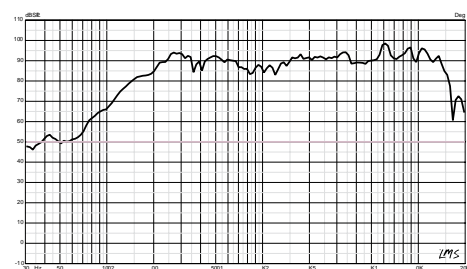
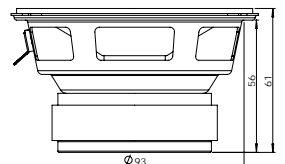

PRO-X5.4BM

5.25" MIDRANGE LOUDSPEAKER 4 OHMS

- Red Steel Basket
- Red Aluminium Bullet
- 150 Watts RMS Power
- 300 Watts MAX Power
- Impedance: 4 OHMS
- Sensitivity: 92.7dB
- Frequency Response: 215-13.4KHz
- 18.5 oz High Strength Ferrite Magnet
- 1.2" High Temperature KCCAW Voice Coil
- Cloth Edge and Non-Pressed Paper Cone

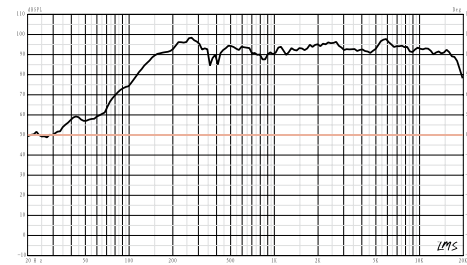
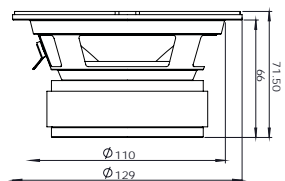

PRO-X6.4BM

6.5" MIDRANGE LOUDSPEAKER 4 OHMS

- Red Steel Basket
- Red Aluminum Bullet
- 300 Watts RMS Power
- 600 Watts MAX Power
- Impedance: 4 OHMS
- Sensitivity: 93dB
- Frequency Response: 106-17KHz
- 30 oz High Strength Ferrite Magnet
- Cloth Edge and Non-Pressed Paper Cone
- 1.5" High Temperature CCAR Voice Coil

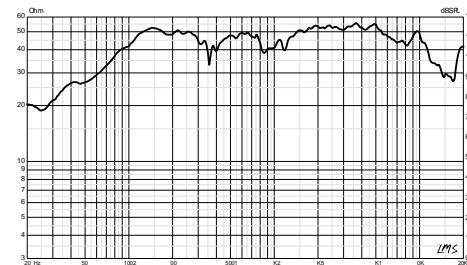
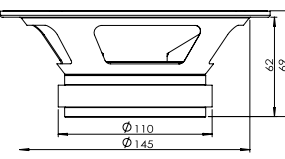

PRO-X8.4BM

8" MIDRANGE LOUDSPEAKER 4 OHMS

- Red Steel Basket
- Red Aluminum Bullet
- 275 Watts RMS Power
- 550 Watts MAX Power
- Impedance: 4 OHMS
- Sensitivity: 99dB
- Frequency Response: 93-16KHz
- 30 oz High Strength Ferrite Magnet
- Cloth Edge and Non-Pressed Paper Cone
- 1.5" High Temperature CCAR Voice Coil

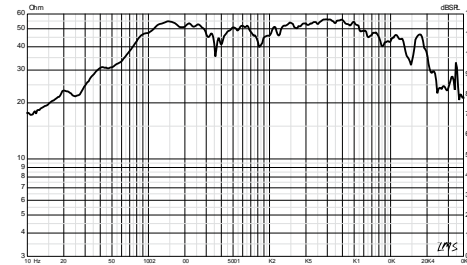
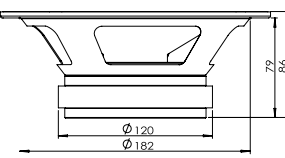

PRO-X6.4BMSL

6.4" MIDRANGE LOUDSPEAKER 4 OHMS SLIM

- Red Steel Basket
- Red Aluminum Bullet
- 250 Watts RMS Power
- 500 Watts MAX power
- Impedance: 4 OHMS
- Sensitivity: 95dB
- Frequency Response: 159Hz-9.4KHz
- 21 oz High Strength Ferrite Magnet
- Cloth Edge & Non-Pressed Paper Cone
- 1.5" High Temperature KCCAW Voice Coil

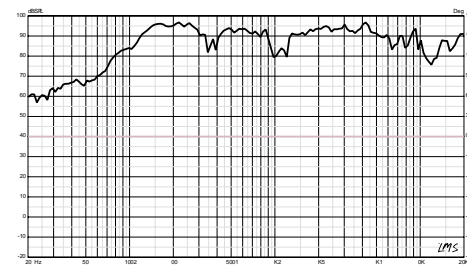
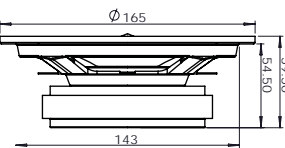



8 OHM

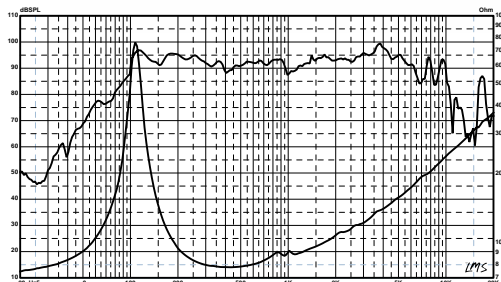

PRO-GM6

6.5" MIDRANGE LOUDSPEAKER

Black Paper Woofer Cone
Cloth Surround, Black Stamp Basket
6.5" Nominal Basket Diameter
140 Watts RMS Power
480 Watts MAX Power
Sensitivity: 92dB

Nominal Impedance: 8 OHMS
Mounting Depth: 2.5"
1.5" High Temperature Kapton Voice Coil
Frequency Response: 98-10KHz
Magnet Structure: 23 Oz with Rubber Boot Cover

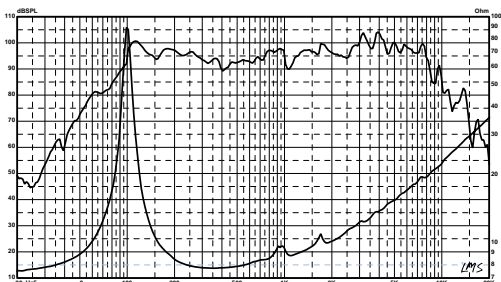

PRO-GM8

8" MIDRANGE LOUDSPEAKER

Black Paper Woofer Cone
Cloth Surround, Black Stamp Basket
8" Nominal Basket Diameter
190 Watts RMS Power
580 Watts MAX Power
Sensitivity: 93dB

Nominal Impedance: 8 OHMS
Mounting Depth: 3.2"
1.5" High Temperature Kapton Voice Coil
Frequency Response: 90-10KHz
High Energy Magnet: 30 oz

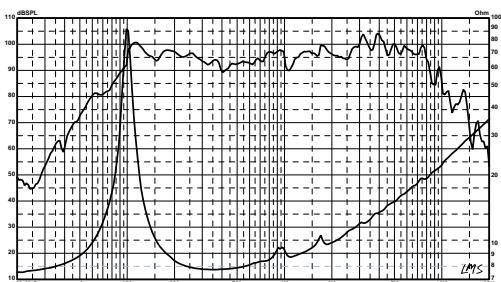

PRO-GM10

10" MIDRANGE LOUDSPEAKER

Black Paper Woofer Cone
Cloth Surround, Black Stamp Basket
10" Nominal Basket Diameter
220 Watts RMS Power
660 Watts MAX Power
Sensitivity: 94dB

Nominal Impedance: 8 OHMS
Mounting Depth: 3.7"
2" High Temperature Kapton Voice Coil
Frequency Response: 78Hz-7.6KHz
High Energy Magnet: 30 oz

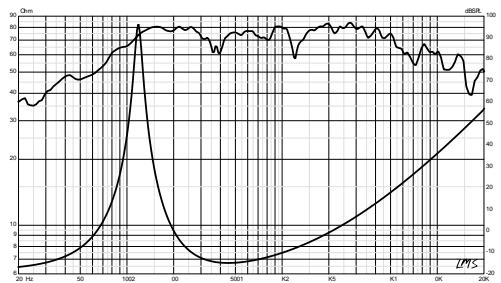

PRO-GM6B

6.5" MIDRANGE LOUDSPEAKER WITH BULLET

Black Paper Woofer Cone
Cloth Surround, Black Stamp Basket
140 Watts RMS Power
480 Watts MAX Power
Sensitivity: 94dB
Impedance: 8 OHMS

Mounting Depth: 2.5"
Frequency Response: 160-10KHz
1.5" High Temperature Kapton Voice Coil
6.5" Nominal Basket Diameter With Bullet
Magnet Structure: 23 Oz with Rubber Boot Cover

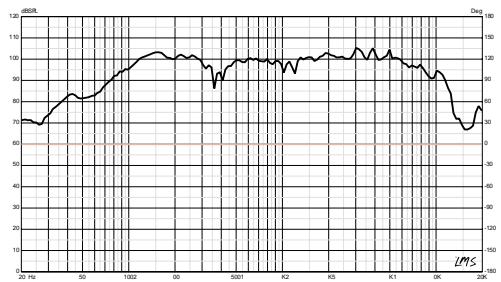

PRO-GM8B

8" MIDRANGE LOUDSPEAKER WITH BULLET

Black Paper Woofer Cone
Cloth Surround, Black Stamp Basket
190 Watts RMS Power
580 Watts MAX Power
Sensitivity: 95dB
Impedance: 8 OHMS

Mounting Depth: 3.2"
Frequency Response: 125-12KHz
1.5" High Temperature Kapton Voice Coil
8" Nominal Basket Diameter with Bullet
High Energy Magnet: 30 oz



PRO

PRO-GRILL6

6.5" SPEAKER GRILL COVER

PRO-GRILL8

8" SPEAKER GRILL COVER

PRO-GRILL10

10" SPEAKER GRILL COVER

Material: PC/ABS
Installation Method: Screw
Available in: Black, Blue, Red, Yellow, Green, White & Silver





TM-N32 32" SUBWOOFER QUAD 1 OHM

TM-SPL18NEO 18" SUBWOOFER DUAL 1 OHMS

TM-SPL15NEO 15" SUBWOOFER DUAL 1 OHMS

TM-SPL15 15" SUBWOOFER DUAL 1 OHMS

TM-SPL12 12" SUBWOOFER DUAL 1 OHMS

TROUBLEMAKER

The name says it all. After causing trouble in the competition lanes and exceeding global expectations we gained the knowledge necessary to tweak these subs and achieve the best results. After years of research and development we designed a new technology in SPL competition subwoofer motors and restructured the whole line. With authentic red Kevlar cones, voice coils made in the USA, and a secret compound formula for the glues and resins, we combined the highest quality materials into our classified design. The result; a monster subwoofer that can handle up to 30K Watts in burps and exceeds all specifications desired by competitors around the world.

TROUBLEMAKER Subwoofers	Size	RMS Power	MAX Power	Burst Power	Impedance	Voice Coil Diameter	Sensitivity	Frequency Response	Mounting Depth	Magnet
TM-N32	32"	15,000W	20,000W	N/A	1 + 1 + 1 + 1	8"	98dB	15-200Hz	15.75"	650 oz
TM-SPL18NEO	18"	3,000W	5,000W	30,000W	1 + 1	3"	TBA	TBA	TBA	TBA
TM-SPL15NEO	15"	3,000W	5,000W	30,000W	1 + 1	3"	93.4dB	TBA	10.5"	TBA
TM-SPL15	15"	2,500W	5,000W	15,000W	1 + 1	3"	90.85dB	TBA	9.26"	TBA
TM-SPL12	12"	2,500W	5,000W	15,000W	1 + 1	3"	84.7dB	TBA	8.6"	TBA

TROUBLEMAKER Subwoofers	Cone Material	Magnet Type	Thiele & Small Parameter							Net Weight
			Fs	Re	Qes	Qms	Qts	Vas	Xmax	
TM-N32	Paper Cone	NEO	22.2 Hz	0.78 x 4	1.050	1.938	0.681	714L	54.8mm	256 lb
TM-SPL18NEO	Pure Kevlar	NEO - 52	TBA	TBA	TBA	TBA	TBA	TBA	TBA	TBA
TM-SPL15NEO	Pure Kevlar	NEO - 52	51.14 Hz	0.49	0.263	4.253	0.247	27.7L	TBA	37.5 kg
TM-SPL15	Pure Kevlar	FERRITE	55.85 Hz	0.48	0.629	6.410	0.573	28.4L	TBA	34.5 kg
TM-SPL12	Pure Kevlar	FERRITE	55.85 Hz	0.59	0.855	6.762	0.759	9.3L	TBA	32 kg



HOOL-X12.2D 12" SUBWOOFER DUAL 2 OHMS 6000 WATTS

HOOL-X12.4D 12" SUBWOOFER DUAL 4 OHMS 6000 WATTS

HOOL-X15.2D 15" SUBWOOFER DUAL 2 OHMS 6000 WATTS

HOOL-X15.4D 15" SUBWOOFER DUAL 4 OHMS 6000 WATTS



After breaking several records with our original Hooligan, we decided to take this subwoofer to the next level. Upgraded in every aspect, HOOLIGAN-X features a DS18 X-clusive basket design, Kevlar enforced paper cone, and upgraded spider, bringing a true BassHead Sub to life!

HOOLIGAN Subwoofers	Size	RMS Power	MAX Power	Impedance	Voice Coil Diameter	Sensitivity	Frequency Response	Mounting Depth	Magnet	Net Weight
HOOL-X12.2D	12"	4000W	6000W	2 + 2	4"	85.2dB	44-3.5KHz	9.38"	3 x 114 oz	27 kg
HOOL-X12.4D	12"	4000W	6000W	4 + 4	4"	85.3dB	44-3.5KHz	9.38"	3 x 114 oz	27 kg
HOOL-X15.2D	15"	4000W	6000W	2 + 2	4"	86.2dB	35-2.3KHz	10.81"	4 x 150 oz	37 kg
HOOL-X15.4D	15"	4000W	6000W	4 + 4	4"	86.4dB	35-2.3KHz	10.81"	4 x 150 oz	37 kg

HOOLIGAN Subwoofers	Optimum Sealed FT ³ / Liters	Optimum Ported FT ³ / Liters	Displacement	Thiele & Small Parameter						
				Fs	Re	Qes	Qms	Qts	Vas	Xmax
HOOL-X12.2D	1.72 / 48.72	2.32 / 65.6	0.11FT ³	41.72 Hz	1.9 + 1.9	1.0	6.478	0.871	17.4L	56.5 mm
HOOL-X12.4D	1.72 / 48.72	2.32 / 65.6	0.11FT ³	45 Hz	3.2 + 3.2	1.110	6.925	0.963	10.5L	56.5 mm
HOOL-X15.2D	2.75 / 77.8	3.47 / 98.2	0.21FT ³	31.63 Hz	2.3 + 2.3	0.531	4.387	0.474	45.13L	59 mm
HOOL-X15.4D	2.75 / 77.8	3.47 / 98.2	0.21FT ³	30.28 Hz	3.6 + 3.6	0.516	3.646	0.452	52.83L	59 mm



EXL



EXL

For standard subwoofers there is no better SPL Competition Grade woofers than the EXL-XX, which can be bought in either 2-Ohms or 4-Ohms Dual Voice Coils Configurations. At 2,000 and 2,500 RMS power the Hellion comes in 12" and 15" sizes respectively in order to provide more standard options of modifications and installations to serious competitors.

EXL-XXB12.2D 12" SUBWOOFER DUAL 2 OHMS

EXL-XXB12.4D 12" SUBWOOFER DUAL 4 OHMS

EXL-XXB15.2D 15" SUBWOOFER DUAL 2 OHMS

EXL-XXB15.4D 15" SUBWOOFER DUAL 4 OHMS

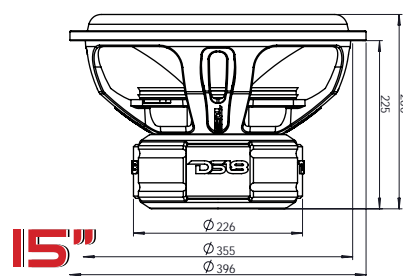
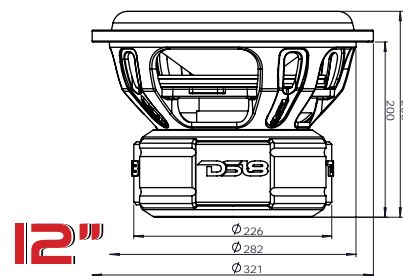

EXL-X12.2D 12" SUBWOOFER DUAL 2 OHMS

EXL-X12.4D 12" SUBWOOFER DUAL 4 OHMS

EXL-X15.2D 15" SUBWOOFER DUAL 2 OHMS

EXL-X15.4D 15" SUBWOOFER DUAL 4 OHMS

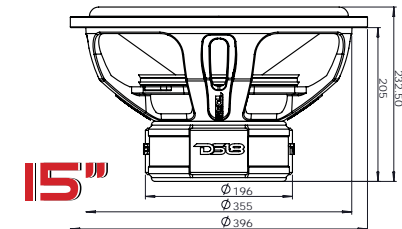
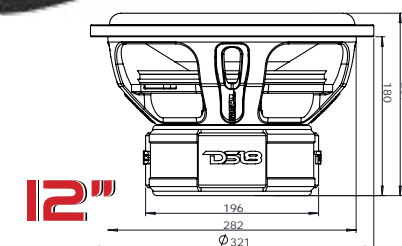

EXL Subwoofers	Size	RMS Power	MAX Power	Impedance	Voice Coil Diameter	Sensitivity	Frequency Response	Mounting Depth	Magnet	Net Weight
EXL-XXB12.2D	12"	2000W	4000W	2 + 2	3"	87.2dB	20-1.6KHz	7.87"	3 x 102 oz	27 kg
EXL-XXB12.4D	12"	2000W	4000W	2 + 2	3"	88dB	20-1.6KHz	7.87"	3 x 102 oz	27 kg
EXL-XXB15.2D	15"	2000W	4000W	2 + 2	3"	89.23dB	20-1.3KHz	8.85"	3 x 102 oz	28 kg
EXL-XXB15.4D	15"	2000W	4000W	2 + 2	3"	90.42dB	20-1.3KHz	8.85"	3 x 102 oz	28 kg

EXL Subwoofers	Optimum Sealed FT ³ / Liters	Optimum Ported FT ³ / Liters	Displacement	Thiele & Small Parameter						
				Fs	Re	Qes	Qms	Qts	Vas	Xmax
EXL-XXB12.2D	1.1 / 31.1	1.6 / 45.3	TBA	53.4 Hz	2.3 + 2.3	0.571	5.872	0.52	6.6L	TBA
EXL-XXB12.4D	1 / 28.3	1.5 / 42.4	TBA	54 Hz	3.7 + 3.7	0.609	7.064	0.561	7L	TBA
EXL-XXB15.2D	1.69 / 47.8	2.12 / 60	TBA	45 Hz	2.1 + 2.1	0.681	6.001	0.611	40.23L	TBA
EXL-XXB15.4D	1.69 / 47.8	2.12 / 60	TBA	43.7 Hz	3.8 + 3.8	0.677	4.346	0.586	57.72L	TBA

EXL Subwoofers	Size	RMS Power	MAX Power	Impedance	Voice Coil Diameter	Sensitivity	Frequency Response	Mounting Depth	Magnet	Net Weight
EXL-X12.2D	12"	1250W	2500W	2 + 2	2.57"	88dB	30-1.7KHz	7.08"	2 x 105 oz	15 kg
EXL-X12.4D	12"	1250W	2500W	4 + 4	2.57"	88dB	30-1.7KHz	7.08"	2 x 105 oz	15 kg
EXL-X15.2D	15"	1250W	2500W	2 + 2	2.57"	92dB	25-1.5KHz	8.07"	2 x 105 oz	16 kg
EXL-X15.4D	15"	1250W	2500W	4 + 4	2.57"	92dB	25-1.5KHz	8.07"	2 x 105 oz	16 kg

EXL Subwoofers	Optimum Sealed FT ³ / Liters	Optimum Ported FT ³ / Liters	Displacement	Thiele & Small Parameter						
				Fs	Re	Qes	Qms	Qts	Vas	Xmax
EXL-X12.2D	1.16 / 32.8	1.51 / 42.7	TBA	49.6 Hz	2 + 2	0.448	2.901	0.388	9.31L	30mm
EXL-X12.4D	1.21 / 34.2	1.68 / 47.5	TBA	55.7 Hz	3.7 + 3.7	0.482	3.305	0.431	9.08L	30mm
EXL-X15.2D	1.63 / 46.1	2.1 / 59.4	TBA	50.1 Hz	2 + 2	0.562	5.842	0.513	24.76L	30mm
EXL-X15.4D	1.8 / 50.9	2.4 / 67.9	TBA	52.3 Hz	3.6 + 3.6	0.572	6.214	0.495	25.53L	30mm



ELITE-Z6 6.5" SUBWOOFER DUAL 4 OHMS 600 WATTS

ELITE-Z8 8" SUBWOOFER DUAL 4 OHMS 900 WATTS

ELITE-Z10 10" SUBWOOFER DUAL 4 OHMS 1500 WATTS

ELITE-Z12 12" SUBWOOFER DUAL 4 OHMS 1600 WATTS

ELITE-Z15 15" SUBWOOFER DUAL 4 OHMS 1800 WATTS

Elite Series subwoofers are designed for every day bass lovers and competitors alike, Providing low frequencies and ready for high power applications. Its reinforced Carbon fiber dust cap gives it a unique and exclusive look.

ELITE Z FEATURES

- Kevlar Dust Cap
- Black Steel Basket
- Paper and Foam Edge
- BASV 4 Layer Voice Coil

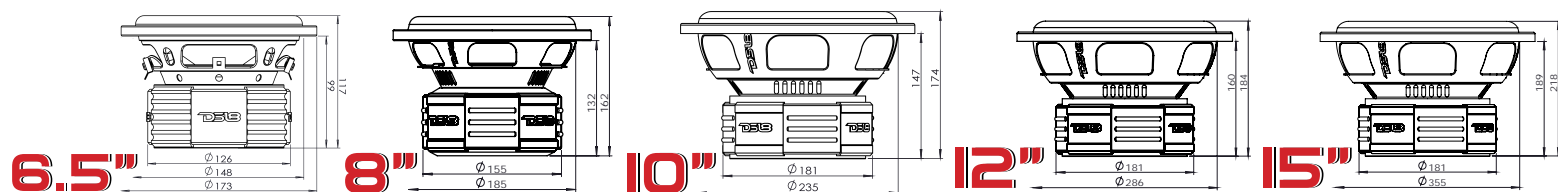

ELITE Subwoofers	Size	RMS Power	MAX Power	Impedance	Voice Coil Diameter	Sensitivity	Frequency Response	Mounting Depth	Magnet	Net Weight
ELITE-Z6	6.5"	300W	600W	4 + 4	1.5"	86.5dB	32 - 10KHz	3.89"	2 x 33.5 oz	3.8 kg
ELITE-Z8	8"	500W	900W	4 + 4	2.5"	85.2dB	46 - 2.8KHz	5"	2 x 60 oz	7 kg
ELITE-Z10	10"	750W	1500W	4 + 4	2.5"	87dB	34 - 3.5KHz	5.56"	2 x 80 oz	9.5 kg
ELITE-Z12	12"	800W	1600W	4 + 4	2.5"	90.1dB	32 - 3.3KHz	6.13"	2 x 80 oz	10 kg
ELITE-Z15	15"	900W	1800W	4 + 4	2.5"	92dB	30 - 3.1KHz	7.31"	2 x 80 oz	10.5 kg

ELITE Subwoofers	Optimum Sealed FT ³ / Liters	Optimum Ported FT ³ / Liters	Displacement	Thiele & Small Parameter						
				Fs	Re	Qes	Qms	Qts	Vas	Xmax
ELITE-Z6	0.28 / 7.9	0.37 / 10.4	0.02 FT ³	61.5 Hz	3.2 + 3.2	0.587	5.124	0.527	2.25L	15mm
ELITE-Z8	0.51 / 14.4	0.91 / 25.7	0.03 FT ³	53.2 Hz	3.2 + 3.2	1.238	4.23	0.59	5.49L	25.5mm
ELITE-Z10	0.79 / 22.3	1.2 / 33.9	0.05 FT ³	39.8 Hz	3.2 + 3.2	1.09	5.97	0.521	9.18L	27.5mm
ELITE-Z12	1.1 / 31.1	1.45 / 41	0.07 FT ³	37.7 Hz	3.2 + 3.2	1.28	9.31	0.55	16L	29mm
ELITE-Z15	1.71 / 48.4	2.28 / 64.5	0.14FT ³	35.4 Hz	3.2 + 3.2	1.605	13.63	0.52	33.5L	30.5mm

ELITE



The Z-BD subwoofer series deliver class, sophistication, and power. This series sets itself apart by using the highest quality control and raw materials available for its high-end technology. With RMS power of 600 and 700 watts, the 12" and 15" Z-BD series are the classiest, most-powerful luxury subwoofers in the market that fit any ambitious audio-ophile.

Z-BD124D 12" SUBWOOFER DUAL 4 OHMS

Z-BD154D 15" SUBWOOFER DUAL 4 OHMS

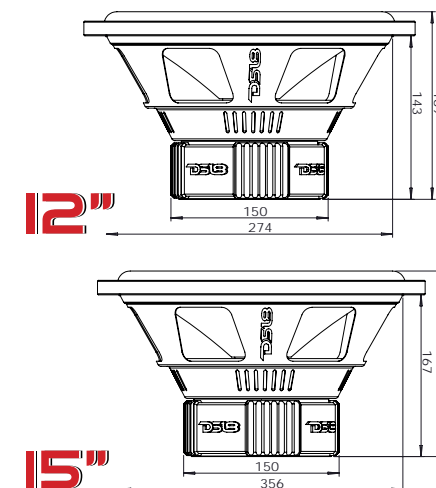

ELITE-Z Subwoofers	Size	RMS Power	MAX Power	Impedance	Voice Coil Diameter	Sensitivity	Frequency Response	Mounting Depth	Magnet	Net Weight
Z-BD124D	12"	600W	1200W	4 + 4	2"	87dB	30 - 3.5KHz	5.63"	2 x 45 oz	5.8 kg
Z-BD154D	15"	700W	1400W	4 + 4	2"	87dB	27 - 3.2KHz	6.61"	2 x 45 oz	6.3 kg

ELITE-Z Subwoofers	Optimum Sealed FT ³ / Liters	Optimum Ported FT ³ / Liters	Displacement	Thiele & Small Parameter						
				Fs	Re	Qes	Qms	Qts	Vas	Xmax
Z-BD124D	1.28 / 36.2	1.68 / 47.5	0.07 FT ³	42 Hz	3.2 + 3.2	0.815	0.815	0.72	24L	19.8mm
Z-BD154D	1.53 / 43.3	2.1 / 59.4	0.12 FT ³	40 Hz	3.2 + 3.2	1.519	7.353	1.259	55.8L	19.8mm



GEN-X

Introducing the GEN-X subwoofers at 4-Ohms configurations in 10", 12", and 15". With powers ranging from 400-500 watts RMS, these subwoofers will provide high-quality, provoking resonations for anyone seeking a powerful bass.

GEN-X104D 10" SUBWOOFER DUAL 4 OHMS

GEN-X124D 12" SUBWOOFER DUAL 4 OHMS

GEN-X154D 15" SUBWOOFER DUAL 4 OHMS

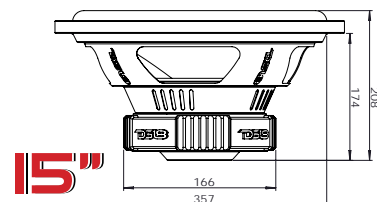
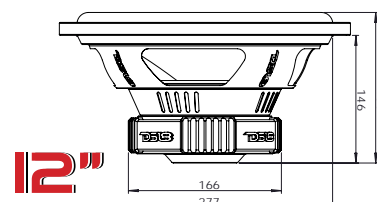
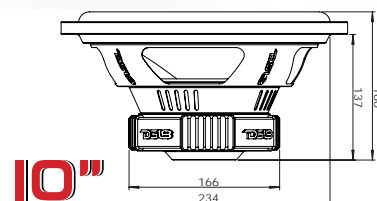

GEN-X Subwoofers	Size	RMS Power	MAX Power	Impedance	Voice Coil Diameter	Sensitivity	Frequency Response	Mounting Depth	Magnet	Net Weight
GEN-X104D	10"	400W	800W	4 + 4	2"	87dB	25 - 6KHz	5.39"	66 oz	6 kg
GEN-X124D	12"	450W	900W	4 + 4	2"	87.5dB	44 - 4.8KHz	5.75"	66 oz	6.3 kg
GEN-X154D	15"	500W	1000W	4 + 4	2"	88.5dB	38 - 3.5KHz	7.63"	70 oz	6.9 kg

GEN-X Subwoofers	Optimum Sealed FT ³ / Liters	Optimum Ported FT ³ / Liters	Displacement	Thiele & Small Parameter						
				Fs	Re	Qes	Qms	Qts	Vas	Xmax
GEN-X104D	1 / 28.3	1.32 / 37.3	0.04FT ³	54.6 Hz	3.2 + 3.2	0.616	5.191	0.551	10.65L	17.5mm
GEN-X124D	1.22 / 34.5	1.7 / 48.1	0.08FT ³	43 Hz	3.5 + 3.5	0.748	6.305	0.69	23.4L	17.8mm
GEN-X154D	1.6 / 45.3	2 / 56.6	0.13FT ³	43 Hz	3.5 + 3.5	1.151	7.728	1.002	56.7L	17.8mm

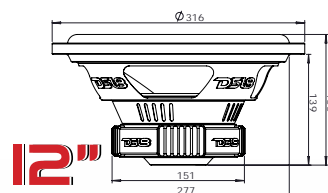
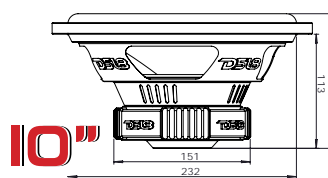
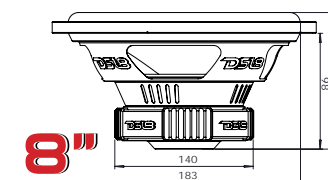

SLC-8S 8" SUBWOOFER SINGLE 4 OHMS

SLC-10S 10" SUBWOOFER SINGLE 4 OHMS

SLC-12S 12" SUBWOOFER SINGLE 4 OHMS

SELECT

The Select Series Subwoofers come in 8", 10", and 12" in black steel baskets. DS18 understands the demands of many inexperienced car audiophiles and fiscally responsible deal-finders. These subwoofers' success relies in their ability to deliver better quality and RMS power than all other entry level offerings of their competition.



SLC-MD12 12" SUBWOOFER SINGLE 4 OHMS

SLC-MD12.4D 12" SUBWOOFER SINGLE 4 OHMS

SELECT Subwoofers	Size	RMS Power	MAX Power	Impedance	Voice Coil Diameter	Sensitivity	Frequency Response	Mounting Depth	Magnet	Net Weight
SLC-8S	8"	200W	400W	4	2"	84dB	50 - 4.5KHz	3.85"	38 oz	3 kg
SLC-10S	10"	220W	440W	4	2"	88dB	40 - 4.5KHz	4.45"	45 oz	3.5 kg
SLC-12S	12"	250W	500W	4	2"	90dB	41 - 4.2KHz	5.47"	45 oz	4 kg
SLC-MD12	12"	250W	500W	4	2"	90dB	27 - 1.5KHz	5.5"	42 oz	3.5 kg
SLC-MD12.4D	12"	250W	500W	4 + 4	2"	90dB	28 - 1.6KHz	5.5"	42 oz	3.5 kg

SELECT Subwoofers	Optimum Sealed FT ³ / Liters	Optimum Ported FT ³ / Liters	Displacement	Thiele & Small Parameter						
				Fs	Re	Qes	Qms	Qts	Vas	Xmax
SLC-8S	0.51 / 14.4	0.85 / 24	0.02FT ³	50Hz	3.6	0.889	6.875	0.787	7.92L	16.5 mm
SLC-10S	0.7 / 19.8	1.09 / 30.8	0.04FT ³	40Hz	3.6	0.891	5.878	0.774	37L	17 mm
SLC-12S	0.82 / 23.2	1.19 / 33.6	0.06FT ³	41Hz	3.4	1.116	4.611	0.898	32.8L	17 mm
SLC-MD12	1.3 / 36.8	1.55 / 43.9	0.07FT ³	29.6Hz	3.2	0.783	5.367	0.684	48.52L	13.8mm
SLC-MD12.4D	1.2 / 33.9	1.45 / 41	0.07FT ³	30.5Hz	3.2 + 3.2	0.802	4.538	0.681	49.17L	13.8mm



How about putting bass where there is no space, that's right - our shallow subwoofer series is designed for small and tight application and are easy to fit in any vehicle. Single or dual voice coils and power handling rated at 500 or 600 RMS.

SW10D4 10" SHALLOW SUBWOOFER DUAL 4 OHMS

SW10S4 10" SHALLOW SUBWOOFER SINGLE 4 OHMS

SW12D4 12" SHALLOW SUBWOOFER DUAL 4 OHMS

SW12S4 12" SHALLOW SUBWOOFER SINGLE 4 OHMS

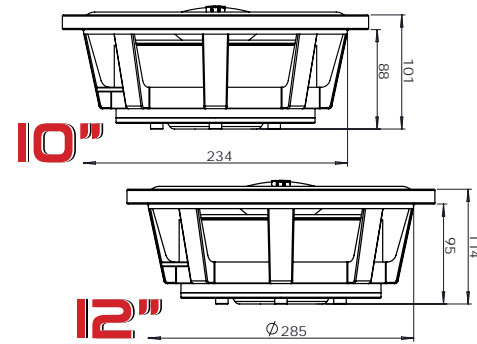

SW Subwoofers	Size	RMS Power	MAX Power	Impedance	Voice Coil Diameter	Sensitivity	Frequency Response	Mounting Depth	Magnet	Net Weight
SW10D4	10"	500W	1000W	4 + 4	2"	90dB	30 - 3.2KHz	3.5"	50 oz	5 kg
SW10S4	10"	500W	1000W	4	2"	90dB	40 - 3.2KHz	3.5"	50 oz	5 kg
SW12D4	12"	600W	1200W	4 + 4	2"	90.6dB	35 - 2.6KHz	3.7"	60 oz	6 kg
SW12S4	12"	600W	1200W	4	2"	90.6dB	35 - 2.6KHz	3.7"	60 oz	6 kg

SW Subwoofers	Optimum Sealed FT ³ / Liters	Optimum Ported FT ³ / Liters	Displacement	Thiele & Small Parameter						
				Fs	Re	Qes	Qms	Qts	Vas	Xmax
SW10D4	0.75 / 21.2	1.14 / 32.2	0.03FT ³	51.8	3.6 + 3.6	1.163	6.767	0.992	16.62L	12.5mm
SW12D4	1.26 / 35.6	1.68 / 47.5	0.04FT ³	48.45	3.3 + 3.3	1.159	6.246	0.978	28.48L	15mm
SW10S4	0.77 / 21.8	1.18 / 33.4	0.03FT ³	54.51	3.4	1.011	7.528	0.891	13.57L	12.5mm
SW12S4	1.3 / 36.8	1.75 / 49.5	0.04FT ³	51.15	3.36	0.964	6.866	0.845	26.45L	15mm

SW10S4X

10" SHALLOW SUBWOOFER 4 OHMS

Black Aluminum Basket
 Ferrite High Strength Magnet
 Rubber Edge and Paper Cone
 2" BASV 4 Layer Voice Coil
 500 Watts RMS Power
 1000 Watts Max Power
 Sensitivity: 90dB
 Frequency Response: 30 - 3.2KHz
Dimensions: D1 x D2 x W x H
 100 x 157 x 600 x 320mm

SW12S4X

12" SHALLOW SUBWOOFER 4 OHMS

Black Aluminum Basket
 Ferrite High Strength Magnet
 Rubber Edge and Paper Cone
 2" BASV 4 Layer Voice Coil
 600 Watts RMS Power
 1200 Watts MAX Power
 Sensitivity: 90.6dB
 Frequency Response: 35 - 2.6KHz
Dimensions: D1 x D2 x W x H
 115 x 182 x 700 x 350mm



SLC112X 1 X 12" VENTED MDF ENCLOSURE

Black Color Steel Basket
 45 oz High Strength Ferrite Magnet
 Foam Edge and Paper With Glass Fiber Cone
 2" Black Aluminum 4 Layer Voice Coil
 4 OHM Load Configuration
 250 Watts RMS Power
 500 Watts MAX Power
 Impedance 4 OHMS
Dimensions: D1 x D2 x W x H
 281 x 340 x 470 x 362mm

SLC212X 2 X 12" VENTED MDF ENCLOSURE

Black Color Steel Basket
 45 oz High Strength Ferrite Magnet
 Foam Edge and Paper With Glass Fiber Cone
 2" Black Aluminum 4 Layer Voice Coil
 2 OHM Load Configuration
 500 Watts RMS Power
 1000 Watts MAX Power
 Impedance 2 OHMS
Dimensions: D1 x D2 x W x H
 281 x 340 x 860 x 362mm





AMPLIFIER INCLUDED

BP110 1 X 10" SUBWOOFER ENCLOSURE
MDF CONSTRUCTION

600 Watts MAX Power Handling
Dimensions: D1 x D2 x W x H
185 x 267 x 370 x 265mm

BP112 1 X 12" SUBWOOFER ENCLOSURE
MDF CONSTRUCTION

650 Watts MAX Power Handling
Dimensions: D1 x D2 x W x H
220 x 320 x 442 x 365mm

BP210 2 X 10" SUBWOOFER ENCLOSURE
MDF CONSTRUCTION

1200 Watts MAX Power Handling
Dimensions: D1 x D2 x W x H
185 x 267 x 733 x 302mm

BP212 2 X 12" SUBWOOFER ENCLOSURE
MDF CONSTRUCTION

1300 Watts MAX Power Handling
Dimensions: D1 x D2 x W x H
220 x 320 x 808 x 365mm



BUILT IN CLASS A/B AMPLIFIER

BPX110A 1 X 10" AMPLIFIED BASS ENCLOSURE
WITH CARBON FIBER VINYL WRAP

600 Watts MAX Power Handling
Dimensions: D1 x D2 x W x H
185 x 265 x 418 x 301mm

BPX112A 1 X 12" AMPLIFIED BASS ENCLOSURE
WITH CARBON FIBER VINYL WRAP

650 Watts MAX Power Handling
Dimensions: D1 x D2 x W x H
226 x 315 x 481 x 365mm

BPX210A 2 X 10" AMPLIFIED BASS ENCLOSURE
WITH CARBON FIBER VINYL WRAP

1200 Watts MAX Power Handling
Dimensions: D1 x D2 x W x H
185 x 265 x 736 x 301mm

BPX212A 2 X 12" AMPLIFIED BASS ENCLOSURE
WITH CARBON FIBER VINYL WRAP

1300 Watts MAX Power Handling
Dimensions: D1 x D2 x W x H
226 x 315 x 884 x 365mm

COMPLETE 8 GAUGE INSTALLATION KIT INCLUDES

- 2 Color-Coded Nickel-Plated Ring Terminals
- 1 x Nickel-Plated Mini-ANL Fuse Holder with 40A Fuse
- 1 x 17 ft Red 8 Gauge Power Cable
- 1 x 3 ft Black 8 Gauge Ground Cable
- 1 x 17 ft 2-Channel Twisted Pair RCA Cable
- 1 x 17 ft Gray 18 Gauge Remote Wire
- 5 x Nickel-Plated Spade Terminals
- 1 x 18 Gauge Butt Connector
- 10 Black Zip Cable Ties
- 1 x 10 ft Speaker Cable
- 1 x 8 Gauge Grommet

PRO-BOX

HIGH EFFICIENCY DOUBLE MID-RANGE AND DRIVER BOX

1/2" MDF Enclosure
Carpet finish with Logo Stitching
Horn Material: UV Compliant High Gloss High Polymer Resin and fiberglass Composite
Separate Dual Connectors (Mid, Driver)
Double Port Design Toneality
For More Bass And Midbass Response

Speakers:
Two PRO - EXL108
Two PRO - PRO-DR450
Sensitivity: 105dB
Frequency Response:
Mode 1 - 125Hz-20KHz Without Port Covered
Mode 2 - 80Hz-20KHz With one Port Covered
1200 Watts RMS (Mids) 600 Watts RMS (Driver)
2000 Watts MAX (Mids) 1200 Watts MAX (Driver)
SIZE D x W x H: 9" x 29.75 x 14.25



PRO-CUBE6

HIGH EFFICIENCY MID-RANGE
HORN/DEFUSER BOX WITH SPEAKER

1/2" MDF Enclosure
Carpet Finish
Size: 9" x 9" x 9"
Horn Material: ABS Molded
Speaker: PRO-EXL68
Impedance: 8 OHMS
300 Watts RMS Power
600 Watts MAX Power
Sensitivity: 99dB
Frequency Response: 90Hz - 16KHz



PRO-CUBE8

HIGH EFFICIENCY MID-RANGE
HORN/DEFUSER BOX WITH SPEAKER

1/2" MDF Enclosure
Carpet Finish
Size: 10" x 10" x 10"
Horn Material: ABS Molded
Speaker: PRO-EXL88
Impedance: 8 OHMS
400 Watts RMS Power
800 Watts MAX Power
Sensitivity: 100dB
Frequency Response: 90Hz - 16KHz

PRO-CUBE10

HIGH EFFICIENCY MID-RANGE
HORN/DEFUSER BOX WITH SPEAKER

1/2" MDF Enclosure
Carpet Finish
Size: 12" x 12" x 12"
Horn Material: ABS Molded
Speaker: PRO-EXL108
Impedance: 8 OHMS
600 Watts RMS Power
1000 Watts MAX Power
Sensitivity: 100.2dB
Frequency Response: 63Hz - 10KHz



PRO-SDF6

6.5" SPEAKER DIFFUSER

PRO-SDF8

8" SPEAKER DIFFUSER

PRO-SDF10

10" SPEAKER DIFFUSER

After the great success of our HOOLIGAN Subwoofers, our customers were looking for an amplifier to supply the raw, violent power needed to unleash the mob. With its red aluminum finish and digital volt/temperature reader, this sophisticated amplifier is one of a kind.



HOOLIGAN Amplifiers	MAX Power (Watts)	Channels	RMS Power @ 14V			Speaker Impedance	THD	Input Sensitivity
			4 OHMS	2 OHMS	1 OHM			
HOOLIGAN-8K	8,000	1	1 x 3,000W	1 x 5,000W	1 x 8,000W	1 - 4 OHMS	<0.01%	0.2V-6V

HOOLIGAN Amplifiers	High Pass	Low Pass	Bass Boost	Signal to Noise Ratio	Frequency Response	Fuse Size (Recommended)	Dimensions	Power Input
HOOLIGAN-8K	N/A	25Hz-250Hz	0-18dB	>95dB	15Hz-250Hz	800A	750 x 231 x 56mm	2 x 0GA

HOOLIGAN

Made in South Korea, HOOL-SPL series amps provide the most advanced SPL options for audiophiles seeking maximum power with unparalleled performance and sophistication. Find the most powerful subwoofers and plug them to the SPL series. Create an elaborate build. Compete. Win. These amplifiers are the highest rated amplifiers today's technology can manufacture. Only recommended for serious installers, competitors, and people who want to be heard by anyone within a mile radius.



HOOLIGAN Amplifiers	MAX Power (Watts)	Channels	RMS Power @ 14V			@16V	Speaker Impedance	THD	Input Sensitivity
			4 OHMS	2 OHMS	1 OHM	1 OHM			
HOOL-SPL3.5	3,500	1	1 x 1,100W	1 x 2,100W	1 x 3,500W		1 - 4 OHMS	<0.15%	10V - 0.2V
HOOL-SPL5	5,000	1	1 x 1,500W	1 x 2,800W	1 x 5,000W		1 - 4 OHMS	<0.15%	10V - 0.2V
HOOL-SPL8.5	8,500	1	1 x 2,300W	1 x 4,300W	1 x 8,500W		1 - 4 OHMS	<0.15%	10V - 0.2V
HOOL-SPLX	10,000	1	1 x 3,000W	1 x 6,300W	1 x 10,000W		1 - 4 OHMS	<0.15%	10V - 0.2V

HOOLIGAN Amplifiers	High Pass	Low Pass	Bass Boost	Signal to Noise Ratio	Frequency Response	Fuse Size (Recommended)	Dimensions	Power Inputs
HOOL-SPL3.5K	N/A	30Hz - 250Hz	0 - 12dB	≥100dB	10Hz - 350Hz	350A	560 x 250 x 58mm	1 x 0GA
HOOL-SPL5K	N/A	30Hz - 250Hz	0 - 12dB	≥100dB	10Hz - 350Hz	500A	590 x 250 x 58mm	2 x 0GA
HOOL-SPL8.5K	N/A	30Hz - 250Hz	0 - 12dB	≥100dB	10Hz - 350Hz	750A	700 x 290 x 76mm	2 x 0GA
HOOL-SPLX	N/A	30Hz - 250Hz	0 - 12dB	≥100dB	10Hz - 350Hz	1150A	950 x 290 x 76mm	3 x 0GA

PRO

Made in South Korea, the PRO-FR series amps provide Full Range options for audiophiles seeking maximum power with unparalleled performance and sophistication. Find the most powerful midranges, tweeters, drivers, coaxials, or any other speaker and plug them to the Full Range series. Create an elaborate build. Compete. Win. These amplifiers are the highest rated amplifiers today's technology can manufacture. Only recommended for serious installers, competitors, and people who want to be heard by anyone within a mile radius.



PRO Amplifiers	MAX Power (Watts)	Channels	Power Output @ 14.4V			Speaker Impedance	THD	Input Sensitivity
			4 OHMS	2 OHMS	1 OHM			
PRO-FR3500.1	3,500W	1	1 x 1,650W	1 x 2,800W	1 x 3,800W	1 - 4 OHMS	<.07%	8V-0.2V
PRO-FR6000.1	6,000W	1	1 x 3,000W	1 x 4,900W	1 x 6,400W	1 - 4 OHMS	<.07%	8V-0.2V
PRO-FR9000.1	9,000W	1	1 x 7,000W	1 x 8,250W	1 x 9500W	1 - 4 OHMS	<.07%	8V-0.2V

PRO Amplifiers	High Pass	Low Pass	Bass Boost	Signal to Noise Ratio	Frequency Response	Fuse Size (Recommended)	Dimensions	Power Inputs
PRO-FR3500.1	10Hz-500Hz	50Hz-15KHz	0-12dB	>90dB	10Hz-15KHz	300A	310 x 230 x 70mm	1 x 0GA
PRO-FR6000.1	10Hz-500Hz	50Hz-15KHz	0-12dB	>90dB	10Hz-15KHz	600A	410 x 230 x 70mm	1 x 0GA
PRO-FR9000.1	10Hz-500Hz	50Hz-15KHz	0-12dB	>90dB	10Hz-15KHz	900A	540 x 230 x 70mm	1 x 0GA



PRO Amplifiers	MAX Power (Watts)	Channels	Power Output @ 14.4V				@16V	Speaker Impedance	THD	Input Sensitivity
			4 OHMS	4 OHMS Bridged	2 OHMS	1 OHM	1 OHM			
PRO-FR600.4	600W	4	4 x 150W	2 x 480W	4 x 240W	N/A	N/A	1 - 8 OHMS	4OHM 1KHz:<0.1%	8V ~ 500mV (+/- 5%)
PRO-FR800.1	800W	1	1 x 265W	N/A	1 x 450W	1 x 700W	1 x 800W	1 - 8 OHMS	4OHM 1KHz:<0.1%	8V ~ 500mV (+/- 5%)
PRO-FR1500.1	1,500W	1	1 x 500W	N/A	1 x 850W	1 x 1,300W	1 x 1,500W	1 - 8 OHMS	4OHM 1KHz:<0.1%	8V ~ 500mV (+/- 5%)

PRO Amplifiers	High Pass	Low Pass	Bass Boost	Signal to Noise Ratio	Frequency Response	Fuse Size	Dimensions
PRO-FR600.4	50Hz ~ 500Hz	50Hz ~ 500Hz	N/A	>90dB	10Hz ~ 30KHz (+/-1dB)	3 x 30A	120 x 50 x 280mm
PRO-FR800.1	10Hz ~ 500Hz	10Hz ~ 500Hz	@ 45Hz: 0 ~ 12dB	>90dB	10Hz ~ 20KHz (+/-1dB)	2 x 30A	120 x 50 x 250mm
PRO-FR1500.1	10Hz ~ 500Hz	10Hz ~ 500Hz	@ 45Hz: 0 ~ 12dB	>90dB	10Hz ~ 20KHz (+/-1dB)	4 x 30A	120 x 50 x 300mm



EXL

The people who live and breathe car audio demanded a higher-performing, extremely intelligent (Technologically speaking), Dynamic product line. With their Compact size and new SMC (surface mount component) technology, the EXL sound quality amplifiers are the epitome of competition and sq amplifiers all in one sleek design. Boasting audio precision quality control verification and Tiffany RCA jacks, these amplifiers offer high quality audio reproduction for the audiophile and everyday listener alike. This line has built in LEDs that light up for power/protection/clipping and have the latest Class-D circuit design.

EXL Amplifiers	MAX Power (Watts)	Channels	RMS Power @ 14V				Speaker Impedance	THD	Input Sensitivity
			4 OHMS	2 OHMS	1 OHM	4 OHMS BRIDGED			
EXL-SQ160.2	250W	2	2 x 80W	2 x 125W	N/A	1 x 250W	2 - 8 OHMS	0.07%	0.2~5V
EXL-SQ300.2	500W	2	2 x 150W	2 x 250W	N/A	1 x 500W	2 - 8 OHMS	0.07%	0.2~5V
EXL-SQ600.2	840W	2	2 x 300W	2 x 420W	N/A	1 x 840W	2 - 8 OHMS	0.07%	0.2~5V
EXL-SQ1200.2	1700W	2	2 x 600W	2 x 850W	N/A	1 x 1700W	2 - 8 OHMS	0.07%	0.2~5V
EXL-SQ320.4	500W	4	4 x 80W	4 x 125W	N/A	2 x 250W	2 - 8 OHMS	0.07%	0.2~5V
EXL-SQ600.4	1000W	4	4 x 150W	4 x 250W	N/A	2 x 500W	2 - 8 OHMS	0.07%	0.2~5V
EXL-SQ1000.4	1440W	4	4 x 250W	4 x 500W	N/A	2 x 720W	2 - 8 OHMS	0.07%	0.2~5V
EXL-SQ600.1	600W	1	250W	400W	600W	N/A	1 - 4 OHMS	0.07%	0.2~5V
EXL-SQ1000.1	1000W	1	440W	730W	1,000W	N/A	1 - 4 OHMS	0.07%	0.2~5V
EXL-SQ1600.1	1600W	1	700W	1,120W	1,600W	N/A	1 - 4 OHMS	0.07%	0.2~5V
EXL-SQ3000.1	3000W	1	1,300W	2,000W	3,000W	N/A	1 - 4 OHMS	0.07%	0.2~5V

EXL Amplifiers	Crossover & Switching			Signal to Noise Ratio	Frequency Response	Fuse Size	Dimensions
	High Pass	Low Pass	Bass Boost				
EXL-SQ160.2	40Hz-3KHz	40Hz-3KHz	N/A	>90dB	20Hz - 20KHz	1 x 25A	184 x 170 x 51mm
EXL-SQ300.2	40Hz-3KHz	40Hz-3KHz	N/A	>90dB	20Hz - 20KHz	1 x 40A	214 x 170 x 51mm
EXL-SQ600.2	40Hz-3KHz	40Hz-3KHz	N/A	>90dB	20Hz - 20KHz	2 x 40A	264 x 170 x 51mm
EXL-SQ1200.2	40Hz-3KHz	40Hz-3KHz	N/A	>90dB	20Hz - 20KHz	4 x 40A	334 x 170 x 51mm
EXL-SQ320.4	40Hz-3KHz	40Hz-3KHz	N/A	>90dB	20Hz - 20KHz	2 x 25A	264 x 170 x 51mm
EXL-SQ600.4	40Hz-3KHz	40Hz-3KHz	N/A	>90dB	20Hz - 20KHz	2 x 40A	314 x 170 x 51mm
EXL-SQ1000.4	40Hz-3KHz	40Hz-3KHz	N/A	>90dB	20Hz - 20KHz	4 x 40A	334 x 170 x 51mm
EXL-SQ600.1	N/A	50Hz - 250Hz	0dB - 18dB	>90dB	20Hz - 500Hz	2 x 30A	264 x 170 x 51mm
EXL-SQ1000.1	N/A	50Hz - 250Hz	0dB - 18dB	>90dB	20Hz - 500Hz	3 x 40A	294 x 170 x 51mm
EXL-SQ1600.1	N/A	50Hz - 250Hz	0dB - 18dB	>90dB	20Hz - 500Hz	4 x 40A	384 x 170 x 51mm
EXL-SQ3000.1	N/A	50Hz - 250Hz	0dB - 18dB	>95dB	20Hz - 500Hz	350A (recommended)	534 x 170 x 51mm



ELITE

DS18 ELITE-Z amplifiers are designed for every day car audio lovers and competitors alike. All amps in this line feature Black extra heavy heatsink with MOSFET psu transistors and have 1-Ohm stable circuits. Remote bass knob included with all models. With their unique look, sleek design and impressive power quality the elite-z Series will be sure to turn some heads.

ELITE Amplifiers	Channels	MAX Power (Watts)	RMS Power @ 14V				Speaker Impedance	THD	Input Sensitivity
			4 OHMS	2 OHMS	1 OHM	4 OHMS BRIDGED			
Z-1K2	2	1,500W	2 x 60W	2 x 90W	N/A	1 x 180W	2-8 OHMS	<0.05%	0.2V~+6v
Z-3K2	2	3,000W	2 X 150W	2 X 230W	N/A	1 X 460W	2-8 OHMS	<0.05%	0.2V~+6v
Z-1.5K4	4	1,500W	4 x 80W	4 x 120W	N/A	2 x 240W	2-8 OHMS	<0.05%	0.2V~+6v
Z-3K4	4	3,000W	4 x 150W	4 x 225W	N/A	2 x 450W	2-8 OHMS	<0.01%	0.2V~+6v
Z-1.5K1	1	1,500W	1 x 220W	1 x 380W	1 x 500W	N/A	1-8 OHMS	<0.2%	0.2V~+6v
Z-3K1D	1	3,000W	1 x 420W	1 x 720W	1 x 1,020W	N/A	1-8 OHMS	<0.2%	0.2V~+6v
Z-4.5K1D	1	4,500W	1 x 600W	1 x 1,010W	1 x 1,520W	N/A	1-8 OHMS	<0.2%	0.2V~+6v
Z-6K1D	1	6,000W	1 x 800W	1 x 1,400W	1 x 2,000W	N/A	1-8 OHMS	<0.2%	0.2V~+6v
Z-9K1D	1	9,000W	1 x 1,200W	1 x 2,000W	1 x 3,000W	N/A	1-8OHMS	<0.2%	0.2V~+6v

ELITE Amplifiers	Crossover & Switching			Signal To Noise Ratio	Frequency Response	Fuse Size	Dimensions
	High Pass	Low Pass	Bass Boost				
Z-1K2	30Hz~300Hz	30Hz~300Hz	0dB~+12dB	>85dB	20Hz~20KHz	2 x 30A	280 x 239 x 54mm
Z-3K2	50Hz~1.2KHz	50Hz~200Hz	0dB~+12dB	>85dB	20Hz~20KHz	3 x 25A	386 X 239 x 54mm
Z-1.5K4	30Hz~300Hz	30Hz~300Hz	0DB/+6dB/+12dB	>85dB	20Hz~20KHz	3 x 20A	375 x 239 x 54mm
Z-3K4	30Hz~300Hz	30Hz~300Hz	0DB/+6dB/+12dB	>85dB	20Hz~20KHz	3 x 40A	481 x 239 x 54mm
Z-1.5K1	N/A	40Hz~250Hz	0dB~+18dB	>85dB	10Hz~250Hz	2 x 15A	246 x 239 x 54mm
Z-3K1D	N/A	40Hz~250Hz	0dB~+18dB	>85dB	10Hz~250Hz	3 x 40A	365 x 239 x 54mm
Z-4.5K1D	N/A	40Hz~250Hz	0dB~+18dB	>85dB	10Hz~250Hz	4 x 40A	385 x 239 x 54mm
Z-6K1D	N/A	40Hz~250Hz	0dB~+18dB	>85dB	10Hz~250Hz	2 x 100A	468 x 239 x 54mm
Z-9K1D	N/A	40Hz~250Hz	0dB~+18dB	>85dB	10Hz~250Hz	300A (recommended)	538 x 239 x 54mm



GEN-X

The DS18 GEN-X line was developed with the customer in mind. We wanted to produce the sturdiest amplifier possible within a reasonable price range, and after months of R&D we finally put together the most attractive design with top of the line internal technologies. All internal parts are manufactured by DS18. With their lower power consumption and high efficiency, the gen-x amplifiers can be installed Without the need of a secondary or high-output alternator.

GEN-X Amplifiers	Channels	MAX Power (Watts)	RMS Power @ 14V				Speaker Impedance	THD %	Input Sensitivity
			4 OHMS	2 OHMS	1 OHM	4 OHMS BRIDGED			
GEN-X800.2	2	800W	2 X 80W	2 X 120W	N/A	1 X 200W	2 - 8 OHMS	0.01%	0.2V~+6v
GEN-X1200.2	2	1,200W	2 x 120W	2 x 180W	N/A	1 x 300W	2 - 8 OHMS	0.01%	0.2V~+6v
GEN-X2000.2	2	2,000W	2 x 160W	2 x 270W	N/A	1 x 500W	2 - 8 OHMS	0.01%	0.2V~+6v
GEN-X900.4	4	900W	4 x 60W	4 x 90W	N/A	2 x 150W	2 - 8 OHMS	0.08%	0.2V~+6v
GEN-X1600.4	4	1,600W	4 x 80W	4 x 120W	N/A	2 x 200W	2 - 8 OHMS	0.01%	0.2V~+6v
GEN-X2000.4	4	2,000W	4 x 120W	4 x 180W	N/A	2 x 300W	2 - 8 OHMS	0.01%	0.2V~+6v
GEN-X3700.4	4	3,700W	4 x 160W	4 x 270W	N/A	2 x 470W	2 - 8 OHMS	0.01%	0.2V~+6v
GEN-X1800.1D	1	1,800W	1 x 250W	1 x 450W	1 x 600W	N/A	1 - 4 OHMS	0.01%	0.2V~+6v
GEN-X3000.1D	1	3,000W	1 x 430W	1 x 700W	1 x 1,000W	N/A	1 - 4 OHMS	0.01%	0.2V~+6v
GEN-X4500.1D	1	4,500W	1 x 500W	1 x 900W	1 x 1,500W	N/A	1 - 4 OHMS	0.01%	0.2V~+6v
GEN-X6000.1D	1	6,000W	1 x 700W	1 x 1200W	1 x 2,000W	N/A	1 - 4 OHMS	0.01%	0.2V~+6v

GEN-X Amplifiers	Crossover & Switching			Signal To Noise Ratio	Bass Response	Frequency Response	Fuse Rating	Dimensions
	High Pass	Low Pass	Bass Boost					
GEN-X800.2	50Hz~500Hz	50Hz~500Hz	0dB/+6dB/+12dB	98dB	N/A	20Hz~20KHz	2 x 15A	330 X 190 x 55mm
GEN-X1200.2	50Hz~500Hz	50Hz~500Hz	0dB/+6dB/+12dB	98dB	N/A	20Hz~20KHz	2 x 25A	400 x 190 x 55mm
GEN-X2000.2	50Hz~500Hz	50Hz~500Hz	0dB/+6dB/+12dB	98dB	N/A	20Hz~20KHz	2 x 35A	430 x 190 x 55mm
GEN-X900.4	50Hz~500Hz	50Hz~500Hz	0dB/+6dB/+12dB	98dB	N/A	20Hz~20KHz	2 x 15A	380 x 190 x 55mm
GEN-X1600.4	50Hz~500Hz	50Hz~500Hz	0dB/+6dB/+12dB	98dB	N/A	20Hz~20KHz	2 x 25A	430 x 190 x 55mm
GEN-X2000.4	50Hz~500Hz	50Hz~500Hz	0dB/+6dB/+12dB	98dB	N/A	20Hz~20KHz	3 x 35A	500 x 190 x 55mm
GEN-X3700.4	50Hz~500Hz	50Hz~500Hz	0dB/+6dB/+12dB	98dB	N/A	20Hz~20KHz	3 x 40A	540 x 190 x 55mm
GEN-X1800.1D	N/A	40Hz~180Hz	0dB~+12dB	98dB	30Hz~80Hz	N/A	2 x 35A	330 x 190 x 55mm
GEN-X3000.1D	N/A	40Hz~180Hz	0dB~+12dB	98dB	30Hz~80Hz	N/A	4 x 30A	430 x 190 x 55mm
GEN-X4500.1D	N/A	40Hz~180Hz	0dB~+12dB	98dB	30Hz~80Hz	N/A	4 x 40A	430 x 190 x 55mm
GEN-X6000.1D	N/A	40Hz~180Hz	0dB~+12dB	98dB	30Hz~80Hz	N/A	N/A	478 x 190 x 55mm



SELECT

The SLC-X Series amplifiers have brought something new to the industry Basically forcing others to drastically change their equipment to try to match ours. We use high-quality, streamlined equipment at an entry level price, which is unheard of from any other amplifier line in the industry. These are the amplifiers that any serious customers "goes to" when in need of ultimate power and features Without breaking the bank

SLC Amplifiers	Channels	MAX Power (Watts)	RMS Power @ 14V				Speaker Impedance	Input Sensitivity	THD %
			4 OHMS	2 OHMS	1 OHM	4 OHMS BRIDGED			
SLC-X1150.2	2	1,150W	2 x 70W	2 x 100W	N/A	1 x 200W	2 - 8 OHMS	0.2 - 6V	<0.1%
SLC-X1650.2	2	1,650W	2 x 100W	2 x 160W	N/A	1 x 260W	2 - 8 OHMS	0.2 - 6V	<0.05%
SLC-X1050.4	4	1,050W	4 x 70W	4 x 100W	N/A	2 x 200W	2 - 8 OHMS	0.2 - 6V	<0.1%
SLC-X1850.4	4	1,850W	4 x 110W	4 x 180W	N/A	2 x 300W	2 - 8 OHMS	0.2 - 6V	<0.1%
SLC-X1550.1D	1	1,550W	1 x 200W	1 x 300W	1 x 400W	N/A	1 - 4 OHMS	0.2 - 6V	<0.2%
SLC-X2250.1D	1	2,250W	1 x 300W	1 x 530W	1 x 750W	N/A	1 - 4 OHMS	0.2 - 6V	<0.2%
SLC-X3050.1D	1	3,050W	1 x 450W	1 x 750W	1 x 1,050W	N/A	1 - 4 OHMS	0.2 - 6V	<0.2%

SLC Amplifiers	Crossover & Switching			Signal To Noise Ratio	Frequency Response	Fuse Size	Dimensions
	High Pass	Low Pass	Bass Boost				
SLC-X1150.2	50Hz - 1.2KHz	50Hz - 200Hz	0dB/+6dB/+12dB	>85dB	20Hz ~ 20KHz	1 x 30A	230 x 232 x 53.1mm
SLC-X1650.2	50Hz - 1.2KHz	50Hz - 200Hz	0dB/+6dB/+12dB	>85dB	20Hz ~ 20KHz	1 x 35A	280 x 232 x 53.1mm
SLC-X1050.4	50Hz - 1.2KHz	50Hz - 200Hz	0dB/+6dB/+12dB	>85dB	20Hz ~ 20KHz	2 x 35A	237 x 232 x 53.1mm
SLC-X1850.4	50Hz - 1.2KHz	50Hz - 200Hz	0dB/+6dB/+12dB	>85dB	20Hz ~ 20KHz	2 x 45A	392 x 232 x 53.1mm
SLC-X1550.1D	N/A	32Hz - 300Hz	0-18dB	>85dB	10Hz ~ 300Hz	2 x 25A	272 x 232 x 53.1mm
SLC-X2250.1D	N/A	32Hz - 300Hz	0-18dB	>85dB	10Hz ~ 300Hz	3 x 35A	328 x 232 x 53.1mm
SLC-X3050.1D	N/A	32Hz - 300Hz	0-18dB	>85dB	10Hz ~ 300Hz	3 x 40A	358 x 232 x 53.1mm



CANDY

The DS18 CANDY Series offers mini, compact amplifiers that not only have the juice to power your system but will also save you a ton of space in your car or bike. Don't sacrifice comfort for better sound when you can simultaneously have both. The CANDY Series comes in monoblock, stereo, and multichannel configurations available in White & Black.

CANDY Amplifiers	Channels	MAX Power (Watts)	RMS Power @ 14V				Fuse Rating	THD %	Input Sensitivity
			4 OHMS	2 OHMS	1 OHM	4 OHMS BRIDGED			
CANDY-X1B	1	1,800W	1 x 240W	1 x 400W	1 x 600W	N/A	2 x 35A	0.01%	0.2V~+6V
CANDY-X2B	2	800W	2 x 80W	2 x 120W	N/A	1 x 240W	1 x 25A	0.01%	0.2V~+6V
CANDY-X4B	4	1,600W	4 x 80W	4 x 120W	N/A	2 x 240W	2 x 25A	0.01%	0.2V~+6V
CANDY-X4W	4	1,600W	4 x 80W	4 x 120W	N/A	2 x 240W	2 x 25A	0.01%	0.2V~+6V
CANDY-XXL1B	1	3,000W	1 x 400W	1 x 650W	1 x 1,000W	N/A	3 x 35A	0.01%	0.2V~+6V
CANDY-X5B	5	2,000W	4 x 80W + 1 x 200W	4 x 120W + 1 x 320W	1 x 420W	2 x 240 W + 1 x 200 W	2 x 40A	0.01%	0.2V~+6V

CANDY Amplifiers	Crossover & Switching			Signal To Noise Ratio	Boost Frequency	Frequency Response	Speaker Impedance	Dimensions
	High Pass	Low Pass	Bass Boost					
CANDY-X1B	N/A	50Hz~150Hz	0dB~+18dB	100dB	40Hz~100Hz	20Hz~150Hz	1 OHMS	220 x 127 x 47.5mm
CANDY-X2B	40Hz~250Hz	40Hz~250Hz	0dB~+12dB	100dB	N/A	20Hz~20KHz	2 OHMS	180 x 127 x 47.5mm
CANDY-X4B	40Hz~250Hz	40Hz~250Hz	0dB~+12dB	100dB	N/A	20Hz~20KHz	2 OHMS	234.4 x 127 x 47.5mm
CANDY-X4W	40Hz~250Hz	40Hz~250Hz	0dB~+12dB	100dB	N/A	20Hz~20KHz	2 OHMS	234.4 x 127 x 47.5mm
CANDY-XXL1B	N/A	50Hz~150Hz	0dB~+18dB	100dB	40Hz~100Hz	20Hz~150KHz	1 OHMS	280 x 127 x 47.5mm
CANDY-X5B	40Hz~250Hz	50Hz~150Hz	0dB~+12dB	100dB	N/A	20Hz~20KHz	1-4 OHMS	280 x 127 x 47.5mm



CANDY Amplifiers	Channels	Max Power (Watts)	RMS Power @ 14V				Speaker Impedance	THD %	Input Sensitivity
			4 OHMS	2 OHMS	1 OHM	4 OHMS BRIDGED			
CANDY-Z4B	4	1800	4 x 100W	4 x 150W	N/A	2 x 300	2 OHMS	0.05%	0.2V~+6V

CANDY Amplifiers	Crossover & Switching			Signal To Noise Ratio	Frequency Response	Fuse Rating	Dimensions
	High Pass	Low Pass	Bass Boost				
CANDY-Z4B	50Hz~750Hz	50Hz~750Hz	0dB~+12dB	90dB	10Hz - 50KHz	2 x 30A	179 x 120 x 44mm

CANDY-6 6 CHANNEL AMPLIFIER

Class D Technology
 Output Power Rating @4 OHMS: 6 x 80 Watts
 Output Power Rating @2 OHMS: 6 x 125 Watts
 Bridged @ 4 OHMS: 3 x 250 Watts
 Frequency Response: 10Hz - 60KHz
 Input Sensitivity: 0.2 - 5V
 Signal to Noise Ratio: ≥80dB
 THD and Noise: <0.01%
 Low Pass Cross Frequency: 50Hz - 750Hz
 High Pass Cross Frequency: 50Hz - 750Hz
 Speaker Impedance: 2-32 OHMS
 Fuse Size: 2 x 40A
 Dimensions (LxWxH) mm: 351 x 137 x 43



CANDY-MICRO2 MINI 2 CHANNEL AMPLIFIER

Extruded Iron Chassis
 Black and Hair Line Heatsink
 Silkprint Logo
 280Mv-6.1V Low Level Inputs
 2-Ohm Stable In Stereo Mode,
 4-Ohm Bridged Stable
 Power @ 4-Ohms: 2 X 65 Watts
 Power @ 2-Ohms: 2 X 80 Watts
 Power @ 4-Ohms: 1 X 160 Watts
 THD %:< 0.1%

Signal To Noise Ratio: ≥ 80 Db
 Frequency Response: 19Hz - 39KHz
 Variable Input Level Control
 Four Way Protection Circuit:
 Thermal Protection
 Over-Load Current Protection
 Output Direct Current Protection
 Speaker Short Circuit Protection
 Dimensions (LxWxH) mm: 80.2 X 124 X 37
 With Aux Input



CANDY-MICRO4 MINI 4 CHANNEL AMPLIFIER

Extruded Iron Chassis
 Black And Hairline Heatsink
 Silkprint Logo
 0.28V-6.1V Low Level Inputs
 2 OHM Stable in Stereo Mode,
 4 OHM Bridged Stable
 Power @ 4-OHMS: 4 x 60 Watts
 Power @ 2-OHMS: 4 x 80 Watts
 Power @ 4-OHMS: 2 x 120 Watts
 THD %:< 0.1%

Signal to Noise Ratio: ≥ 80 dB
 Frequency Response: 15Hz - 35KHz
 Variable Input Level Control
 Four Way Protection Circuit:
 Thermal Protection
 Over-Load Current Protection
 Output Direct Current Protection
 Speaker Short Circuit Protection
 Dimensions (LxWxH) mm: 150 x 38 x 123
 With Aux Input



NF2 HIGH PERFORMANCE AUDIO NOISE FILTER

Pure High Quality Inductor Filter
 Metal Housing
 Pure copper Wire for Output RCA Output
 Valid Value of avoid Noise:1 0-80dB

Frequency Response: 20Hz-30KHz
 Sensitivity: 0.1V-8V
 Input: RCA Jack
 Dimensions: 53.3L x 57W x 24.1H (mm)



3AVS 3 AMP VOLT STABILIZER

Input Voltage Range 6-16V
 Output Voltage 14.4V (Constant)
 Output Current: 3 AMP

Voltage Stableized Accuracy <0.5%
 Ripple Factor <0.1%
 Transfer Efficiency >85%



DSP DIGITAL SIGNAL PROCESSOR

- 32-bit Δ - Σ A/D & D/A Conversion Technology
- 8 Channel High Volt RCA Output
- Bluetooth Compatibility for Audio Streaming and full control of DSP Parameters Using Android App
- Signal Phase x 8CH
- 31 Band Parametric Equalizer x 8 CH
- Audio Mixing to Match Inputs and Outputs
- Time Delay x 8CH
- Crossover (High-Pass & Low-Pass Filter)
- Slope of 12dB to 48dB
- 6 Channel RCA Hi-Volt Input
- Optical Digital Audio Input
- 6 channel High Level Speaker Input (30 Volts)
- Frequency Response: 10Hz - 33KHz
- Signal To Noise Ratio: >110dB
- THD: <0.002%
- Dynamic Range >114dB
- Auto On / Remote Trigger Switch Selector
- Remote Amp Output
- High Speed 3.0 USB Port to PC or Remote Control Connection



DSPBT DSP BLUETOOTH INTERFACE

- Range: >10 Meters
- Audio Streaming
- Android Friendly



DSPRC DSP REMOTE CONTROL

- Remote Control to Dash
- Main Volume Control
- Input Selector
- Memory Recall Functions
- High Speed USB Connections



DBP-1 DIGITAL BASS PROCESSOR

- Maximum Input Level: 15V
- Maximum Output Level 13.5 V Peak
- Frequency Response : 10 Hz - 100KHz ; +/-1dB
- Total Harmonic Distortion: 0.003%
- Signal to Noise Ratio: -130dB
- Balanced Input Noise Rejection: >60dB
- RCA Input Impedance: 10K OHMS
- RCA Output Impedance: 150 OHMS
- Power Supply: High Headroom PWM
- Power Draw: 150mA
- Recommended Fuse Rating: 1 AMP



If you're looking to maximize sound quality and control over your system, look no further. Our EQ series features 7, 5, or 4 band line drivers to assure we can meet the needs of even the most complex builds. These units have the ability to fine tune your audio system while giving you the ability to add a unique touch to your sound

KEQ20 6 CHANNEL LINE DRIVER/FACTORY STEREO EQUALIZER

- Front/Rear/Subwoofer Equalization (6 Band Subwoofer) (7 Band Front & Rear)
- High Level-Speaker Inputs and Sound Quality Restoration 100W
- High Voltage-RCA Input with Variable Output Voltage 15V
- Switchable Subwoofer Signal Sources
- Variable Pre Amp Voltage for Maximum Sound Level Matching
- Frequency Response: 10Hz-20KHz +/-1dB
- 10 Volts RMS Preout RCA
- Dimensions: 285mm x 220mm x 30mm
- High Quality RCA Input & Output Connectors
- Signal to Noise Ratio <110dB
- THD: 0.003%
- Equalization Cut/Boost +/-12 dB
- Stereo Plus Input
- 2V, 6V Clip LED Indicator RCA Output
- Remote Amp Output Delayed



Bass Knob with Clip Indicator

KEQ7 7 BAND STEREO EQUALIZER

- 7 Band Stereo Equalizer / Crossover with Auxiliary Stereo RCA Input for Use with Portable Devices, such as an MP3 or DVD Player
- 7 Equalization Bands (50Hz, 125Hz, 315Hz, 2.2KHz, 6KHz, 16KHz)
- Each Adjustable from -12dB to +12dB (-15dB to +15dB for Subwoofer Frequencies)
- Subwoofer Output Uses a Built-In 18dB per Octave Electronic Crossover Fixes at 60Hz or 90Hz
- 3 Stereo RCA Outputs to Drive Front, Rear, and Subwoofer Audio Amplifiers
- Separate Controls for Master Volume, Subwoofer Volume (Sub Level), Front / Rear Fader, and Selection of Main or Auxiliary Inputs
- Frequency Response 10Hz-50KHz +/-1dB
- Extended Frequency Response from 20Hz to 30KHz with Exceptional 100dB Signal-to-Noise Performance
- Input Sensitivity 50mV-3V / Head Room 20dB
- Input Impedance 20K OHMS - Output 2K OHMS
- Stereo Separation 82dB / 1KHz



- Operating Voltage 11V-15V Negative Ground
- Gold-Plated RCA Connectors for Best Audio Signal Outputs
- ISO Mounting Holes and Removable Trim Ring for Custom Installation
- Size: 7" x 4 1/8" x 1" High

KEQ5 5 BAND STEREO EQUALIZER

- 5-Band Stereo Equalizer / Crossover Specifically Created for the Mobile Environment. It Provides Powerful Features in a Compact Size
- 5 Equalization Bands (45Hz, 180Hz, 750Hz, 3.5KHz) Each Adjustable from -18dB to +18dB
- Active Gain Equalizer with Adjustable Input Sensitivity
- Master Volume Control with up to 7 Volts RMS of Output
- Individual Left and Right Sensitivity Controls
- Specific Bandwidth for Each Band Plus High Frequency Shelving
- On-Board 30V Bipolar Switching Power Supply
- Subwoofer Level Control
- Subwoofer Frequency Adjustable 60Hz - 90Hz
- Gold Plated RCA Input/Output Connectors
- Input RADIO / CD Select Switch
- Night illumination Design with 2 Color Selectable
- 4 Channel Separate Control for Fitting Front & Rear Field by Dual VR Type
- S/N Ratio 80dB REF IV Input / T.H.D 0.05%
- Frequency Response 10Hz-50KHz, +/- 1dB



- Stereo Separation 80dB / 1KHz
- Input Impedance 20K OHMS
- Operation Voltage 11~15V DC Negative Ground

KEQ4LD 4-BAND GRAPHIC EQUALIZER LINE DRIVER & 2-WAY CROSSOVER

- 4-Band Graphic Equalizer (45Hz - 120Hz - 2200Hz - 12,000Hz)
- Selectable Main & Aux. Inputs Gain Input Level
- Subwoofer Input (Mono & Stereo Selectable)
- 2-Way Crossover
- Low Pass Crossover 12dB/Oct.: 50/80/120Hz
- High Pass Crossover 12dB/Oct.: 80/120/200Hz
- Equalization Cut/Boost :18dB
- THD: 0.01%
- Channel Separation >80dB
- Signal to Noise Ratio: >100dB



Having the perfect tools to make your sound system the ultimate music machine is what DS18 has for you. Our Crossovers are designed to provide the perfect frequency distribution throughout your system to ensure the clarity and peak efficiency for your acoustic

XM6LD 6 WAY ACTIVE CROSSOVER

6CH RCA Input With 2,4,6 CH Selector
 12CH/6 Way RCA Output 11.5V
 High Pass Crossover 12dB/Oct.
 Low Pass Crossover 12dB/Oct.
 Band Pass Crossover 12dB/Oct.
 Output Level Control: 0.2V-11.5V
 Input/output Maximized LED Indicator
 Remote Control For SUB-Level
 1 Subwoofer Band Lowpass with Subsonic Filter, Phase and Level Control (40Hz-90Hz)
 1 Midbass Band (40Hz - 1KHz)
 3 Bandpass Band (40Hz - 12KHz)
 1 Highpass Band (1KHz - 12KHz)
 THD 0.04%
 Signal to Noise Ratio >105 dB
 Stereo Separation



Bass Knob with Clip Indicator

REMOTE BASS CONTROL
 6-WAY ACTIVE CROSSOVER
 6 CHANNEL 11.5-VOLT RCA

XM3 3 WAY ACTIVE CROSSOVER

3 Way Active Crossover with x20 Frequency Multiplier Switch
 Remote Sub Level Control, 0-180 Degree Subwoofer Phase Switch, Detected Frequency Selection Control, Gold RCA Input and Output Connectors, Bass Boost Power, Ground and Remote Connector, PWM Power Supply, LED Power Indicator, Signal To Noise Ratio >102dB
 Total Harmonic Distortion (1KHz, 1VRMS) 0.01%
 Crossover Slopes: 12dB/Octave Butterworth
 Crossover Frequencies: Front HighPass, Rear HighPass, and Subwoofer: 32Hz to 400Hz
 Remote Sub Level: +18dB Boost
 Low Level Input Voltage: 4VRMS
 Maximum Output (10 KΩ Load): 9vrms
 Supply Voltage: 9-15 VDC
 Dimensions: 125mm W x 170mm L x 47mm H



PRO-CFX 2-WAY PASSIVE CROSSOVER

High Freq And Low Freq
 Upper Cover: Steel
 Lower Cover: Plastic
 Freq Crossover: 3.5KHz
 Size: 160X88x38mm
 6.3X3.5x1.5"



V4HL 4CH HI/LOW CONVERTER

Signal to Noise Ratio: >95dB
 Frequency Respose: 20Hz - 20KHz
 High Level Input Rating: 50 Watts
 RCA Low Level Output: 2.5V
 Remote Trigger Output: 12V



BT-ONE AUDIO BT CONNECTION

Stereo Jack Auxiliary Audio Input
 RCA Audio Output • BT Version: 4.0
 Receiver Distance: 20 Meters
 Suitable Cell Phone System:
 iPhone/iPad, Android, Win 10
 Coating Protection Board
 for Marine Applications
 Remote Output



TW2.5 1" SILK DOME TWEETER (PAIR)

Frequency Response: 1.8-20KHz
 Sensitivity: 93.5dB/W/M
 50 Watts RMS Power
 100 Watts MAX Power
 Voice Coil: 1"
 Impedance Input: 4 ohm
 Mounting Depth: 0.75"
 Mounting Diameter: 2.07"
 Surface/Flush/Angle Included



TWC 1" SILK DOME TWEETER (PAIR)

1" Tweeter Speaker
 20 Watts RMS Power
 60 Watts MAX Power
 ø35mm Silk Dome Tweeter
 1"(25mm) ASV Voice Coil
 Frequency Response 1-25KHz
 Sensitivity: 90dB/w/m
 Impedance: 4Ω



TX1R 1.38" PEI DOME TWEETER - RED (PAIR)

TX1S 1.38" PEI DOME TWEETER - SILVER (PAIR)

50 Watts RMS Power
 200 Watts MAX Power
 Sensitivity: 88dB/W/M
 Frequency Response: 2K-20KHz
 Voice Coil: 0.5"
 Impedance: 4 ohm



TWPZ PIEZO DOME TWEETER (PAIR)

40 Watts RMS Power
 80 Watts MAX Power
 Sensitivity: 101dB
 Frequency Response 3.5-20KHz
 Piezo Magnet



PRO-TW4L 1.75" RGB BULLET TWEETER (SINGLE)

Transparent Polycarbonate Frame
 Built in RGB LED
 300 Watts RMS Power
 600 Watts MAX Power
 Frequency response 1.5-20KHz
 Sensitivity 108dB
 Magnet Size 16oz



TWSQ 1.1" SILK DOME TWEETER (PAIR)

Nominal Impedance: 4Ω
 40 Watts RMS Power
 120 Watts MAX Power
 Sensitivity: 88dB
 Frequency: 2K-20KHz
 Built In Attenuation Switch (+3 / 0 -3)dB
 Voice coil Diameter: 1.1"
 Voice Coil Former Material: ASV
 Diaphragm Material: Silk Dome
 Basket Material: Plastic
 Magnet Material: Neodymium N35



PRO-TW820 1" ALUMINUM SUPER BULLET TWEETER

100 Watts RMS Power
200 Watts MAX Power
Impedance 4 OHMS
Sensitivity 102.5dB

High Strength Neodymium Magnet
Black Color Aluminum Body
1" Kapton Voice Coil
Frequency Response: 900 - 18.5KHz



PRO-TW510 1.5" BULLET SUPER TWEETER (SINGLE)

Diecast Aluminum
200 Watts RMS Power
400 Watts MAX Power
Sensitivity: 109.5dB

Frequency Response: 2.5 - 16.8KHz
Magnet Size: 14.5 oz
Impedance: 4 OHMS



PRO-TW310 1.75" BULLET SUPER TWEETER (SINGLE)

Diecast Aluminum
250 Watt RMS Power
400 Watt MAX Power
Sensitivity: 100dB

Frequency Response: 2 - 20KHz
Magnet Size: 12 oz
Impedance: 4 OHMS



PRO-TW110 1" BULLET SUPER TWEETER (PAIR)

Diecast Aluminum
200 Watt RMS Power
300 Watt MAX Power
Sensitivity: 100dB

Frequency Response: 2 - 20KHz
Magnet Size: 5.4 oz
Impedance: 4 OHMS



PRO-TW710 1" TITANIUM SUPER BULLET TWEETER

Diecast Aluminum
250 Watt RMS Power
450 Watt MAX Power
Sensitivity: 100dB

Frequency Response: 1.5 - 20KHz
Neodymium Magnet
Impedance: 4 OHMS



PRO-TW410 1.5" BULLET SUPER TWEETER (SINGLE)

Diecast Aluminum
200 Watt RMS Power
400 Watt MAX Power
Sensitivity: 107.2dB

Frequency Response: 2 - 20KHz
Magnet Size: 14.5 oz
Impedance: 4 OHMS



PRO-TW220 1" BULLET SUPER TWEETER (PAIR)

Diecast Aluminum
225 Watt RMS Power
350 Watt MAX Power
Sensitivity: 102dB

Frequency Response: 2 - 20KHz
Magnet Size: 8 oz
Impedance: 4 OHMS



PRO-TW100B 1" BULLET SUPER TWEETER (PAIR)

Diecast Aluminum
200 Watt RMS Power
300 Watt MAX Power
Sensitivity: 100dB

Frequency Response: 2 - 20KHz
Magnet Size: 5.4 oz
Impedance: 4 OHMS

PRO

PRO-DKH4 4" TITANIUM COMPRESSION DRIVER

400 Watts RMS Power
800 Watts MAX Power
Impedance: 8 OHMS
Sensitivity: 104.2dB
Frequency Response: 620-18.9KHz
Magnet Size: 98oz
Horn Material: Aluminum
Dimensions: 243 x 243 x 176mm
Depth: 328.5mm
12.75"



PRO-DKH2 3" TITANIUM COMPRESSION DRIVER

800 Watts RMS Power
1200 Watts MAX Power
Impedance: 8 OHMS
Sensitivity: 110dB
Frequency Response: 900-17.2KHz
Magnet Size: 65oz
Mylar Capacitor Crossover Included
Horn Material: Aluminum
Horn Dimensions: 188 x 188 x 168mm
Throat Diameter: 3"
Depth: 247mm
9.7"



PRO-DRNEO 3" NEODYMIUM DRIVER

600 Watts RMS Power
800 Watts MAX Power
Impedance: 8 OHMS
Sensitivity: 115dB
Frequency Response: 900-18KHz
Black Aluminum Cover
3" KAPTON 2 Layer Voice Coil



PRO-DRN3 3" NEODYMIUM DRIVER

300 Watts RMS Power
600 Watts MAX Power
Impedance: 8 OHMS
Sensitivity: 110dB
Frequency Response: 500-18KHz
Throat Diameter: 2"
Titanium Diaphragm



PRO-DKHCL 1.75" RGB COMPRESSION DRIVER

Built in RGB LED Transparent Polycarbonate Horn
Includes 18dB Crossover With Polyswitch
350 RMS Power
700 MAX Power
Sensitivity: 101dB
Impedance: 4 OHMS
Frequency Response: 1-20KHz
Magnet Size: 21 oz
Titanium Diaphragm
Horn Dimensions: 176 x 176 x 150mm
Throat Diameter: 1"
Depth: 203mm
8"

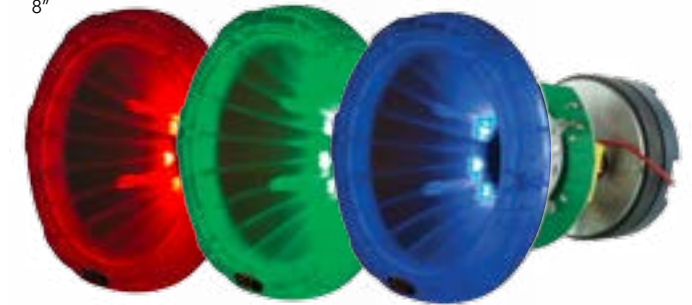

PRO-DKH1 2.03" TITANIUM COMPRESSION DRIVER

600 Watts RMS Power
1000 Watts MAX Power
Impedance: 8 OHMS
Sensitivity: 108dB
Frequency Response: 800-18.5KHz
Magnet Size: 35oz
Mylar Capacitor Crossover Included
Horn Material: Aluminum
Horn Dimensions: 157 x 157 x 132mm
Coverage: 100°
Throat Diameter: 2"
Depth: 4.84"



PRO-DKN25 1" NEODYMIUM DRIVER

60 Watts RMS Power
120 Watts MAX Power
Impedance: 8 OHMS
Sensitivity: 108dB
Frequency Response: 1.5-18KHz
Titanium Diaphragm



PRO-DRN1 1.75" NEODYMIUM DRIVER

150 Watts RMS Power
300 Watts MAX Power
Impedance: 8 OHMS
Sensitivity: 110dB
Frequency Response: 500-18KHz
Throat Diameter: 1"
Titanium Diaphragm



PRO

PRO-D3 4" PHELONIC COMPRESSION DRIVER

4" Phelonic Resin Film Diaphragm
 300 Watts RMS Power
 600 Watts MAX Power
 Impedance: 8 OHMS
 Sensitivity: 104.5 dB
 Magnet Size: 98 oz
 Frequency Response: 700Hz - 16.5KHz



PRO-D1 2.03" TITANIUM COMPRESSION DRIVER

600 Watts RMS Power
 1000 Watts MAX Power
 Impedance: 8 OHMS
 Sensitivity: 108dB
 Frequency Response: 800 - 18.5KHz
 Magnet Size: 35 oz
 Mylar Capacitor Crossover Included



PRO-D1F 2.03" PHELONIC COMPRESSION DRIVER

600 Watts RMS Power
 1000 Watts MAX Power
 Impedance: 8 OHMS
 Sensitivity: 108dB
 Frequency Response: 800 - 18.5KHz
 Magnet Size: 35 oz
 Mylar Capacitor Crossover Included



PRO-DR550 2" TITANIUM COMPRESSION DRIVER

400 Watts RMS Power
 800 Watts MAX Power
 Impedance 8 OHMS
 Sensitivity 110dB
 Magnet Size 38oz
 2.0" KAPTON 2 Layer Voice Coil
 Frequency Response 980 - 20KHz



PRO-DR450 1.75" TITANIUM COMPRESSION DRIVER

300 Watts RMS Power
 600 Watts MAX Power
 Impedance: 8 OHMS
 Sensitivity: 107dB
 Magnet Size: 24oz
 1.75" KAPTON 2 Layer Voice Coil
 Frequency Response: 1 - 20KHz



PRO-DR350 1.35" TITANIUM COMPRESSION DRIVER

200 Watts RMS Power
 400 Watts MAX Power
 Impedance: 8 OHMS
 Sensitivity: 103dB
 Magnet Size 16 oz
 1.35" KAPTON 2 Layer Voice Coil
 Frequency Response: 1.2 - 20KHz



PRO-DR250 2" PHELONIC COMPRESSION DRIVER

Die-Cast Aluminum Basket
 200 Watts RMS Power
 300 Watts MAX Power
 Impedance: 8 OHMS
 Sensitivity: 98 dB
 Magnet Size: 13 oz
 2.03" KAPTON 2 Layer Voice Coil
 Frequency Response: 1-16.3KHz



PRO-DR150 1.5" TITANIUM COMPRESSION DRIVER

50 Watts RMS Power
 150 Watts MAX Power
 Impedance: 8 OHMS
 Sensitivity: 105dB
 Magnet Size: 20 oz
 Frequency Response: 1 - 20KHz



PRO-DR100 1" TITANIUM COMPRESSION DRIVER

30 Watts RMS Power
 60 Watts MAX Power
 Impedance: 8 OHMS
 Sensitivity: 98dB
 Magnet Size: 10 oz
 Frequency Response: 1 - 18KHz



PRO

PRO-HA50

Material: Aluminum
 Profile: Circular
 Coverage: 100°
 Throat Diameter: 2"
 Depth: 2.7"
 Installation Method: Screw Down



PRO-HA300A

Material: Aluminum
 Profile: Circular
 Coverage: 100°
 Throat Diameter: 2"
 Depth: 4.84"
 Installation Method: Screw Down



PRO-HELLIP

Material: PC/ABS
 Profile: Elliptical
 Coverage: 45°x30°
 Throat Diameter: 1.4"
 Depth: 2.17"
 Installation Method: Twist



PRO-H44

Material: PC/ABS
 Profile: Circular
 Coverage: 45°x45°
 Throat Diameter: 1.4"
 Depth: 2.68"
 Installation Method: Twist



PRO-H110

Material: PC/ABS
 Profile: Circular
 Coverage: 110°
 Throat Diameter: 1.4"
 Depth: 6.14"
 Installation Method: Twist



PERFECT FIT FOR PRO-DKH1 & PRO-DRNEO



PRO-HA100

Material: Aluminum
 Profile: Circular
 Coverage: 100°
 Throat Diameter: 2"
 Depth: 4.84"
 Installation Method: Screw Down



TWEETER DIAPHRAGM



PRO-TW820VC
Universal 1" VCL

PRO-TW710VC
Universal 1" VCL

PRO-TW510VC
Universal 1.5" VCL

PRO-TW410VC
Universal 1.5" VCL

PRO-TW310VC
Universal 1.75" VCL

PRO-TW210VC
Universal 1" VCL

PRO-TW110VC
Universal 1" VCL

PRO-TW4LVC
Universal 1.75" VCL

DRIVER DIAPHRAGM



PRO-DRNEOVC
Universal 3" VCL

PRO-DKHLVLC
Universal 1.75" VCL

PRO-DRN3VC
Universal 3" VCL

PRO-DIN1VC
Universal 1.75" VCL

PRO-D4VC
Universal 4" VCL

PRO-D3VC
Universal 4" VCL
Phelonic

PRO-D2VC
Universal 3" VCL

PRO-D1VC
Universal 2" VCL

PRO-D1FVC
Universal 2" VCL
Phelonic

PRO-DR550VC
Universal 2" VCL

PRO-DR450VC
Universal 1.75" VCL

PRO-DR350VC
Universal 1.35" VCL

PRO-DR250VC
Universal 2" VCL
Phelonic

PRO-DR150
Universal 1.5" VCL

PRO-DR100VC
Universal 1" VCL

ANL FUSE HOLDERS



FHAFS-150A
4/8GA IN, 4/8GA OUT,
150 Amp Mini ANL Fuse Included

FHAFSDIG-120A
2/4GA IN, 2/4GA OUT,
120 AMP Mini ANL Fuse Included
Volt Meter LED Display

FDG1224AFS-80A
1X2GA IN, 2X4GA OUT,
80 AMP Mini ANL Fuse Included
Volt Meter LED Display

DB-3ANL-150A
ANL DISTRIBUTION
1x0GA IN 3x4GA Out
With 150A Fuse Included

FD1024/28AFS-60A
1X0GA+2X4GA IN, 2X8GA OUT,
60 AMP Mini ANL Fuse Included

FD1024/38AFS-60A
1X0GA+2X4GA IN, 3X8GA OUT
60 AMP Mini ANL Fuse Included

FD1024/48AFS-60A
1X0GA+2X4GA IN, 4X8GA OUT
60 AMP Mini ANL Fuse Included

FHSANL1014DIG
0/4 GA IN, 0/4 GA OUT
Volt Meter LED Display

FDG1024ANLDIG
0GA IN, 2X4GA OUT
Volt Meter LED Display

FHSANL200A
0/4GA Square
With 200A ANL Fuse Included

FHSANL
0/4GA Square

FHRANL
0/4GA Round

FHRANL250A
0/4GA Round
With 250A ANL Fuse Included

FH4W
4 way Fuse Holder
Does not Include Terminal & fuse

FH2W
2 way Fuse Holder
Does not Include Terminal & fuse

DISTRIBUTION BLOCKS



DB1024
1x0GA IN - 2x4GA OUT



DB1034
1x0GA IN - 3x4GA OUT



DB1448
1x4GA IN - 4x8GA OUT



DB1020
1x0GA IN - 2x0GA OUT



DB1030
1x0GA IN - 3x0GA OUT



DP1V1/0
Power Reductor 1 x1/0GA Pin Output -
2 x 2/0GA Input Wire
Pure Copper and Chrome Coating

AGU FUSE HOLDERS



FHSAGU
AGU Fuse Holder

FHSAGU80A
AGU Fuse Holder
With 80A Fuse

MINI ANL FUSES

MANL-30A
MINI ANL FUSE 30A

MANL-60A
MINI ANL FUSE 60A

MANL-80A
MINI ANL FUSE 80A

MANL-100A
MINI ANL FUSE 100A

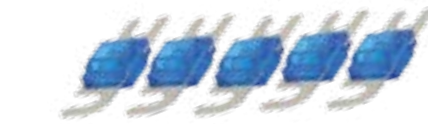

MANL-120A
MINI ANL FUSE 120A

MANL-150A
MINI ANL FUSE 150A

MANL-200A
MINI ANL FUSE 200A

MANL-250A
MINI ANL FUSE 250A

AMPKIT0

0 GAUGE AMP KIT

- 17 FT 0 Gauge Red Super-Flex-Twist Premium Cable
- 3 FT 0 Gauge Black Super-Flex-Twist Ground Cable
- 17 FT 12 Gauge Red/Black Super-Flex-Twist Premium Speaker Cable
- 17 FT 2 Channel Shielded Twisted Pair Premium Audio Interconnects
- 17 FT Remote Turn-On Wire
- 6 FT Split Loom Tubing
- 1 Piece ANL Fuse Holder and 250A ANL Fuse
- 0 Gauge Accessories

AMPKIT4

4 GAUGE AMP KIT

- 17 FT 4 Gauge Red Super-Flex-Twist Premium Cable
- 3 FT 4 Gauge Black Super-Flex-Twist Ground Cable
- 17 FT 14 Gauge Red/Black Super-Flex-Twist Premium Speaker Cable
- 17 FT 2 Channel Shielded Twisted Pair Premium Audio Interconnects
- 17 FT Remote Turn-On Wire
- 6 FT Split Loom Tubing
- 1 Piece AGU Fuse Holder and FHSAGU-100A Fuse
- 4 Gauge Accessories

AMPKIT8

8 GAUGE AMP KIT

- 17 FT 8 Gauge Red Super-Flex-Twist Premium Cable
- 3 FT 8 Gauge Black Super-Flex-Twist Ground Cable
- 17 FT 16 Gauge Red/Black Super-Flex-Twist Premium Speaker Cable
- 17 FT 2 Channel Shielded Twisted Pair Premium Audio Interconnects
- 17 FT Remote Turn-On Wire
- 6 FT Split Loom Tubing
- 1 Piece AGU Fuse Holder and FHSAGU-80A Fuse
- 8 Gauge Accessories



CABLES

POWER WIRES CCA High Performance Ultra-Flex Twist
Copper Clad Aluminum (60% Aluminum - 40% Copper)

- | | | | |
|--|--|--|--|
| 2/0GA - 25ft
PW-2/0GA-25RD
PW-2/0GA-25BK | | 1/0GA - 50ft
PW-1/0GA-50BK
PW-1/0GA-50BL
PW-1/0GA-50RD | |
| 4GA - 100ft
PW-4GA-100BK
PW-4GA-100BL
PW-4GA-100RD | | 8GA - 250ft
PW-8GA-250BK
PW-8GA-250BL
PW-8GA-250RD | |



POWER WIRES OFC High Current Capacity
100% Copper

- | | | | |
|---|--|---|--|
| 2/0GA - 15ft
PW-OFC2/0GA-15BK
PW-OFC2/0GA-15RD | | 2/0GA - 25ft
PW-OFC2/0GA-25BK
PW-OFC2/0GA-25RD | |
| 1/0GA - 15ft
PW-OFC1/0GA-15BK
PW-OFC1/0GA-15RD | | 1/0GA - 25ft
PW-OFC1/0GA-25BK
PW-OFC1/0GA-25RD | |



PRIMARY WIRES Ultra Flex

- 500ft**
PW-16GA-500BL
PW-16GA-500OR
PW-16GA-500BK
PW-16GA-500RD



SPEAKER WIRES Ultra Flex-Twist Premium Speaker Wires

- 500ft**
SW-12GA-500RB
- 1000ft**
SW-16GA-1000RB
SW-18GA-1000RB



RCA CABLES Shielded Twisted Molded Connectors

- RCA1F2M
RCA1M2F
RCA3FT
RCA6FT
RCA12FT
RCA16FT
RCA20FT



RCA CABLES Shielded Twisted Molded Connectors

- PRORCA1F2M
PRORCA1M2F
PRORCA3FT
PRORCA6FT
PRORCA12FT
PRORCA16FT
PRORCA20FT

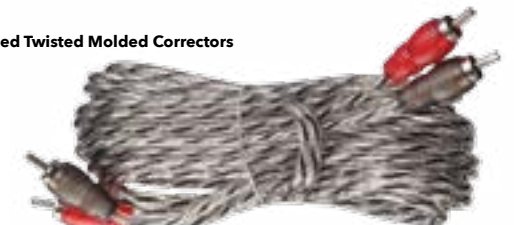

AUXILIARY CABLES Ultra Flex Noise Rejection

- MP3AUX3FT**
AUX 3.5" to AUX 3.5" MP3. 3 Feet
- MP3AUX6FT**
AUX 3.5" to AUX 3.5" MP3. 6 Feet



AUXILIARY TO RCA CABLES Ultra Flex Noise Rejection

- MP3DUALRCA3FT**
AUX 3.5" MP3 to Dual RCA. 3 Feet
- MP3DUALRCA6FT**
AUX 3.5" MP3 to Dual RCA. 6 Feet



WIRES	Section Area	OD
2/0GA	67.4mm ²	17.5mm
1/0GA	53mm ²	15.8mm
4GA	21.04mm ²	10mm
8GA	8.3mm ²	6.7mm
12GA	3.31mm ²	4.5mm
16GA	1.31mm ²	3.2mm
18GA	0.81mm ²	2.4mm

RVM

REARVIEW MIRROR LCD UNIVERSAL MOUNT

Type: Digital TFT LCD
 Display Size: 4.3"
 Display Format: 4:3 / 16:9
 Power Supply: DC 12V
 Video: AV1/AV2 Input
 Pixel: 480(W) x 272(H)
 Operating Voltage: DC9V-16V
 Environment Humidity: 10%-90%
 Operating Temperature: -20° +60°
 Storage Temperature: -40° +85°



RVM/S

REARVIEW MIRROR LCD SPECIAL MOUNT

Type: Digital TFT LCD
 Display Size: 4.3"
 Display Format: 4:3 / 16:9
 Power Supply: DC 12V
 Video: AV1/AV2 Input
 Pixel: 480(W) x 272(H)
 Operating Voltage: DC9V-24V
 Environment Humidity: 10%-90%
 Operating Temperature: -20° +60°
 Storage Temperature: -40° +85°



PRKMC4

PARKING SENSOR, REARVIEW MIRROR & CAMERA PACKAGE

Colorful Distance Display with Label
 Audible Warning Buzzer
 Detachable Sensor with Waterproof Socket Connector
 Digital TFT LCD Monitor
 Waterproof Color Camera with 2 Installations
 Resolution: 420TV Lines
 Voltage: 12V DC
 Detection Distance: 0.3-2.5m for Rear
 Ultrasonic Frequency: 40KHz



PRKMC5

Colorful Distance Display with Label
 Detachable Sensor with Waterproof Socket Connector
 Waterproof Color Camera with 2 Installations
 Digital TFT LCD Monitor
 Input Signal Automatically Boots
 Resolution: 420TV Lines
 Voltage: 12V DC
 Rear Detection Distance: 0.3-2.5m
 Ultrasonic Frequency: 40KHz

CAMERA SPECIFICATIONS

Image Device: 1/4" CMOS
 Picture Pixels: 640 x 480
 Signal System: NTSC
 Synchronization System: Internal
 Horizontal Definition: 420 TV lines
 Minimum illumination: 0.2 lux
 S/N Ratio: Better than 45 dB
 Back Light Compensation: Automatic

Sensor Viewing Angle: 100 -140°
 Waterproof Grade: IP67
 Voltage Range: 9-16v DC
 Video Output: 1vpp 75Ω
 Working Temperature: -20 - +70° Celsius
 Storage Temperature: -30 - +75° Celsius

PRKDI4

PARKING SENSOR

3-Color LED Display with Buzzer Built-In
 Audible Warning Buzzer
 Detachable Sensor with Waterproof Socket Connector
 Digital Meter Distance Mode
 Directional Indication of Left and Right
 Voltage: 12V DC - 16V DC
 Rated current: 10mA - 250mA
 Detection Distance: 0.3-2.5m for Rear
 Working temperature: -30°C - +80°C
 Ultrasonic Frequency: 40KHz



PRKDI8

PARKING SENSOR

3-Color LED Display with Buzzer Built-In
 Audible Warning Buzzer
 Detachable Sensor with Waterproof Socket Connector
 Digital Meter Distance Mode
 Directional Indication of Left and Right
 Voltage: 12V -16 V DC
 Rated current: 10mA - 250mA
 Detection Distance: 0.3-2.5m for Rear
 Working temperature: -30°C - +80°C
 Ultrasonic Frequency: 40KHz
 Front and Rear Parking Sensor



PRKB4

PARKING SENSOR

Audible Warning Buzzer
 Detachable Sensor with Waterproof Socket Connector
 Voltage: 12V DC
 Rated Current: 10mA - 150mA
 Detection Distance: 0.3-2.5m for Rear
 Working Temperature: -30°C - +80°C
 Ultrasonic Frequency: 40KHz



RCS2IN1

WATERPROOF 2 IN 1 VIDEO PARKING SENSOR

CMOS Color Camera, Color Screen Image
 Beeping Sound Sensor 80-100 dB
 Operation Temperature: -20 °C~ +75 °C
 TV System: PAL/NTSC
 Distance scale line: 0.4-2M
 Horizontal Resolution: 420 TV lines
 Dimension: 67x30x28 mm
 Ultrasonic Sensor Angle: 70°(level)
 Lens Angle: 130 °(Level) 130° (Crosswise) 170°

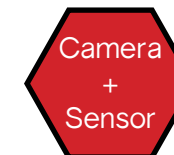

RCB22

REAR VIEW CAMERA

Operation Temperature: -20°C~+75°C (RHS95%MAX)
 TV System: NTSC
 Effective Pixels: NTSC: 656x462
 Sensing Area: 5.961mm x 4.276mm
 Horizontal Resolution: 420 line
 Dimension: 31 x 28x35.5mm

Usable Illumination: 2.26V/Lux-sec@5600k
 Electronic Shutter Time: 1/50 (1/60)-1/100,000sec.
 Video Output: CCIR/EIA(PAL/NTSC) Standard
 Video Signal 1.0Vp-p, 75ohm
 Syns System: Internal Synchronization
 Power Supply: 12V 120mW
 Aluminum Case
 Distant Scale Line: 6-9M



With customer safety in mind, DS18 Cameras and Reverse Sensors are manufactured with the most up-to-date parts in the industry. Engineered and Designed in the United States our cameras have crystal clear night vision and are tested to work in the harshest environments.

RCB24 REARVIEW CAMERA

Operation Temperature: -20°C~+75°C (RHS95%MAX)
TV System: NTSC
Effective Pixels: NTSC: 510x496
Sensing Area: 5.961mm x 4.276mm
Horizontal Resolution: 380 line
Dimension: 31 x 28x35.5mm

Usable Illumination: 2.26V/Lux-sec@5600k
Electronic Shutter Time: 1/60-1/15000sec.
Video Output: CCIR/EIA(PAL/NTSC) Standard
Video Signal 1.0Vp-p, 75ohm
Syns System: Internal Synchronization
Power Supply: 12V 120mW
Aluminum Case



RCD20S/B WATERPROOF REAR VIEW CAR CAMERA

Operation Temperature: -20°C~+75°C (RHS95%MAX)
TV System: NTSC
Distance Scale Line: 6-9M
Effective Pixels: NTSC: 720(H)*567(V)
Sensing Area: 5.78mm x 4.19mm
Horizontal Resolution: 480 Line
Dimension: 24 x 25 x21.6mm

Usable Illumination: 2.26V/Lux-sec@5600k
Electronic Shutter Time: 1/50 - 1/100,000sec.
Video Output: CCIR/EIA(PAL/NTSC) Standard
Video Sygnal 1.0Vp-p, 75ohm
Sync System: Internal Synchronization
Power Supply: 12V 120mW
Stainless Steel Case



RCD20S
Silver

RCD20B
Black

RCTRL REARVIEW CAMERA

Effective Pixel Array: 736x592
Pixel Size: 6.43
Effective Image Area 4.7324mm x 3.56976mm
Optical Format: 1/3 Inch RGB Bayer Filter
Max. Clock Frequency: 54 MHz
Max Frame Rate:
Dynamic Range: 66dB
SNR:48dB
60 FPS, 720x480 YCbCr422/RGB565/RGB444@54MHZ
60 FPS, 720x480 BAYER@27MHz
60Field 720x480 (288)YCbCr@27MHz
CVBS 30fps @27MHz
Dark Current: 40mV/s@60°C
Power Supply: AVDD/DOVDD/CVDD: 3.3V DVDD:1.5V
Power Consumption: 280mW
Operating Temp: -30°C~70°C



ACTIVE PARKING LINES



RCCPS/B REARVIEW CAMERA

Stainless Steel
Waterproof
High Resolution Night Vision
Distance Scale
Color Camera
Wide Angle (120°-170°)

RCCPS
Silver



RCCPB
Black

RCLPS/B REARVIEW CAMERA

Stainless Steel
Waterproof
High Resolution Night Vision
Distance Scale
Color Camera
Wide Angle (120°-170°)

RCLPS
Silver



RCLPB
Black



Train horns like to make some loud noise, how about the loudest horn, that would blow anyone out of your way, our train horns qualify as Extremely Loud! They can be as loud as 125 db. The horns' shiny chrome finish gives a nice touch to your vehicle and the 100% stainless steel adds a bright polished finish for no rusting. In addition, they are strongly engineered for exterior use in almost any weather condition. Trumpets are mounted next to each other for easy installation.

TH3COMBO TRAIN AIR HORNS

Volt: 12V - Volume: 6L - Current: <6.5A
Max Pressure: 150 Psi
Tank Capacity: 1.5 Gallon
Working Pressure: 90-120 Psi
Size: 16.34"x14.17"x11.81"
Compressor Size: 6.7"x3.54"x6.3"
Decibel: 125 Db (Test Distance: 1M)
Material: Zinc (Horn Pipe) Aluminum (Base) Plastic (Cover)



TH4COMBO TRAIN AIR HORNS

Volt: 12V - Volume: 6L - Current: <6.5A
Max Pressure: 150 PSI
Tank capacity: 1.5 Gallon
Working Pressure: 90-120 PSI
Horns Size: 13.78"x11.61"x9.06"x7.48"
Compressor Size: 6.7"x3.54"x6.3"
Decibel: 125 dB (Test Distance: 1M)
Material: Zinc (Horn Pipe) Aluminum (Base) Plastic (Cover)



THX2 TRAIN AIR HORNS

Volt: 12V
Current: 40-43A
Color: Chrome
Size: 13.67"x15.55"
Decibel: 110-115dB (Test Distance: 1M)



THEL2 ELECTRIC TRAIN HORNS

Volt: 12V
Current: 8-9A
Size: 15.5"x18.5"
Decibel: 110-120dB (Test Distance: 1M)



RC-RELAY12 RELAY 12V 30A



RC-PWC2 UNIVERSAL POWER WINDOW CLOSER, 2 DOOR

RC-PWC4 UNIVERSAL POWER WINDOW CLOSER, 4 DOOR



RC-PWS2 UNIVERSAL POWER WINDOW SWITCH, 2 DOOR



RC-CLS2 CENTRAL LOCK 2 DOOR SYSTEM

1 Master Control,
1 Slaves Wire Harness, Module Control,
Mounting Hardware Included for Easy Installation

RC-CLS4 CENTRAL LOCK 4 DOOR SYSTEM

1 Master Control,
1 Slaves Wire Harness, Module Control,
Mounting Hardware Included for Easy Installation

RC-CLA2 CENTRAL LOCK ACTUATOR 2 WIRE

RC-CLA5 CENTRAL LOCK ACTUATOR 5 WIRE



RC-PWK2D UNIVERSAL POWER WINDOW KIT

2 Door Switch, Wire Harness,
Mounting Harness Adaptor For All Car Models Included

RC-PWK4D UNIVERSAL POWER WINDOW KIT

2 Door Switch, Wire Harness,
Mounting Harness Adaptor For All Car Models Included



DS18 Sound Deadening Mat is applied to absorb vibrations and noises caused from driving or car audio. This product gets rid of excess noise, stops unwanted vibration, dampens engine and exhaust noise within the car, and makes the car stereo sound up to three times better!

SD918 SOUND DEADNER

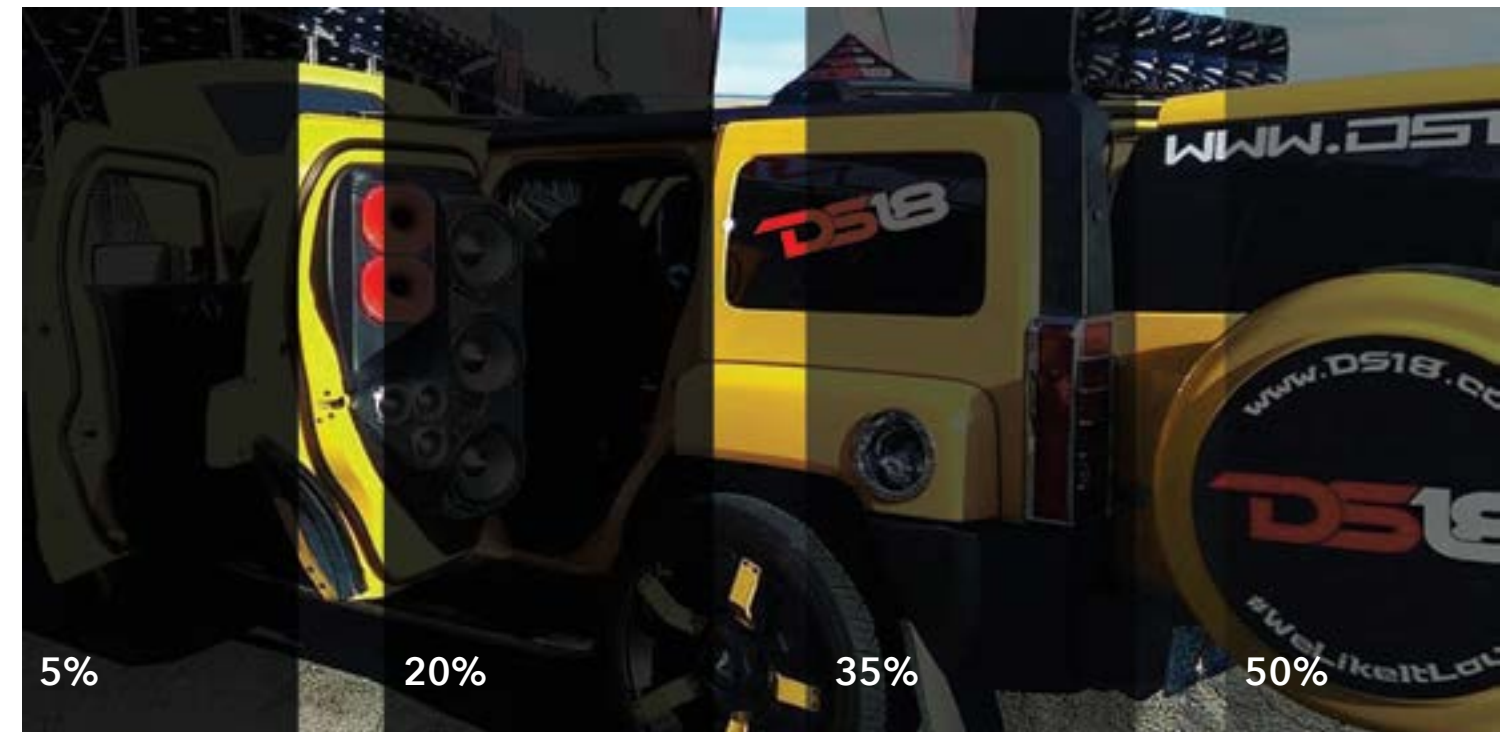

1 PLY - SCRATCH RESISTANT - COLOR STABLE

20"x 200ft	40"x 200ft	60"x 200ft
HAWK-0520 5% Black	HAWK-0540 5% Black	HAWK-0560 5% Black
HAWK-2020 20% Black	HAWK-2040 20% Black	HAWK-2060 20% Black
HAWK-3520 35% Black	HAWK-3540 35% Black	HAWK-3560 35% Black
HAWK-5020 50% Black	HAWK-5040 50% Black	HAWK-5060 50% Black



GEL

LITHIUM

AGM

GEL Batteries	Nominal Voltage	Nominal Ah	20Hr Capacity	Burst Amps	Terminal Posts	Dimensions In Inches			Weight Kgs	Charging Current	Cycle Voltage	Float Voltage	Group
						Length	Width	Height					
GB45	12.8V	45Ah	47Ah	275-320A	T3	7.80	6.54	6.85	13	< 10.5A	14.4-14.9V	13.6-13.8V	U1L
GB55	12.8V	55Ah	60Ah	400-480A	T3	9.02	5.53	8.19	17.5	< 13.8A	14.4 - 14.9V	13.6-13.8V	22NF
GB80	12.8V	80Ah	85Ah	510-600A	T3	10.24	6.65	8.31	23.5	< 20A	14.4 - 14.9V	13.6-13.8V	24
GB90	12.8V	90Ah	100Ah	530-630A	T3	12.09	6.65	8.31	27	< 22.5A	14.4 - 14.9V	13.6-13.8V	27
GB100	12.8V	100Ah	110Ah	605-720A	T4	13.03	6.85	8.43	30	< 25A	14.4 - 14.9V	13.6-13.8V	31
GB150	12.8V	150Ah	160Ah	900-1070A	T4	19.06	6.73	9.49	43.80	< 30A	14.4 - 14.9V	13.6-13.8V	N/A
GB180	12.8V	180Ah	200Ah	1260-1498A	T5	20.55	9.45	8.62	55.80	< 36A	14.4 - 14.9V	13.6-13.8V	4D
GB220	12.8V	220Ah	240Ah	1700-2090A	T5	20.55	9.45	8.62	61.40	< 44A	14.4 - 14.9V	13.6-13.8V	4D
GB250	12.8V	250Ah	280Ah	2380	T5	20.47	10.55	8.66	71	< 50A	14.4 - 14.9V	13.6-13.8V	8D

GEL Batteries: Value Regulated To Support High Temperature Environment, Deep Cycle, Maintenance Free, Non-Spilleable & High Resistance To Shock & Vibration

AGM Batteries	Nominal Voltage	Nominal Ah	20Hr Capacity	Burst Amps	Terminal Posts	Dimensions In Inches			Weight Kgs	Charging Current	Cycle Voltage	Float Voltage	Group
						Length	Width	Height					
PC25	12.8V	25Ah	27Ah	160-195A	T3	6.50	4.96	6.85	7.70	< 6A	14.4-14.9V	13.6-13.8V	N/A
PC35	12.8V	23Ah	37Ah	190-230A	T3	7.72	5.12	7.05	10	< 8.25A	14.4 - 14.9V	13.6-13.8V	U1
PC45	12.8V	45Ah	47Ah	275-320A	T3	7.80	6.54	6.85	12.90	< 10.5A	14.4 - 14.9V	13.6-13.8V	U1L
PC55	12.8V	55Ah	60Ah	400-480A	T3	9.02	5.43	8.90	17.40	< 13.8A	14.4 - 14.9V	13.6-13.8V	22NF
PC80	12.8V	80Ah	85Ah	510-600A	T3	10.24	6.65	9.09	23.30	< 20A	14.4 - 14.9V	13.6-13.8V	24
PC90	12.8V	90Ah	100Ah	530-630A	T3	12.09	6.65	8.94	26.70	< 22.5A	14.4 - 14.9V	13.6-13.8V	27
PC100	12.8V	100Ah	110Ah	605-720A	T4	12.91	6.77	8.74	30	< 25A	14.4 - 14.9V	13.6-13.8V	31
PC150	12.8V	150Ah	160Ah	900-1070A	T4	19.06	6.73	9.49	41	< 30A	14.4 - 14.9V	13.6-13.8V	N/A
PC180	12.8V	180Ah	200Ah	1260-1498A	T4	20.94	8.11	8.70	52.50	< 36A	14.4 - 14.9V	13.6-13.8V	4D
PC220	12.8V	220Ah	240Ah	1700-2090A	T5	20.55	9.45	9.61	60.50	< 44A	14.4 - 14.9V	13.6-13.8V	4D
PC250	12.8V	250Ah	280Ah	2380-2926A	T5	20.47	10.55	9.65	68	< 50A	14.4 - 14.9V	13.6-13.8V	8D

AGM Batteries: Sealed, Maintenance Free, Non-Spilleable & Deep Cycle

LITHIUM Batteries	Nominal Voltage	Nominal Ah	20Hr Capacity	Burst Amps	Dimensions In Inches			Weight Kgs	Charging Current	Cycle Voltage	Group
					Length	Width	Height				
LT50X	13V	50Ah	100Ah	150A	13.8	6.61	7.07	5.5	< 13A	14.6V	N/A
LT100X	13V	100Ah	200Ah	300A	12.9	6.73	8.72	13.8	< 25A	14.6V	U1
LT150X	13V	150Ah	300Ah	450A	19.1	6.69	9.39	20	< 30A	14.6V	U1L

LITHIUM Batteries: High-Tech Battery, Short Circuit, Overload (Charge And Discharge) Protection, Light Weight & Hi Volt Float

Reduce the voltage flocking or dimming lights, used to prevent lights from dimming when loud bass notes play. Reduce the rise voltage & clean the residual noise on the electrical system in your car.

EXTREME ION CAPACITORS

CAP5 5 FARAD EXTREME ION CAPACITOR STATION
SUGGESTED POWER: UP TO 1300 WATTS

CAP15 15 FARAD EXTREME ION CAPACITOR STATION
SUGGESTED POWER: UP TO 1600 WATTS

CAP50 50 FARAD EXTREME ION CAPACITOR STATION.
SUGGESTED POWER: UP TO 2000 WATTS

Digital Voltage / Amperage Display
Working Voltage:10V-16.5V
Extreme Ion Capacitor Station
Amplifier Style Housing
Digital Voltage/Amperage Display
0GA and 4GA Amplifier Atyle Input/output Terminals
Heavy Duty, Platinum Plated Bolt-Down Terminals
Saves The Electric Current and Accurately Detects
the Working Current with a Remote Control
IC Controlled Circuitry
Automatically Alarms when The Voltage is Above 17.5 and Under 10V



CAP2 2 FARAD EXTREME ION CAPACITOR.

Suggested Power: Up To 1000 Watts
Digital Voltage / Amperage Display
Working Voltage:10V-16.5V
Automatically Alarms when The Voltage is Above 17.5 and Under 10V

2,000,000µF



DS18 is continuously evolving while creating products that stand out against our competitors. We now offer a specially designed alternator for SPL competitions. The DS18 alternators generate higher voltages and amperages in this market and our units are designed for competitors wishing to improve their maximum SPL. DS18 modules have the ability to turn on and off the DS18 alternator with just switch of a button; you can turn on when needed and turn it off when it is not needed. These Alternators use plug and play connectors between the regulator, module and the alternator without using tools; all you have to do is connect the 0 Gauge power wires or higher and begin to use it.

ALT200AC / ALT200AF

HIGH CURRENT ALTERNATOR - 200 AMP @ 15 VOLT
FOR DAILY USE / UNIVERSAL APPLICATION

ALT250AC / ALT250AF

HIGH CURRENT ALTERNATOR - 250 AMP @ 15 VOLT
FOR DAILY USE / UNIVERSAL APPLICATION

ALT350AC / ALT350AF

HIGH CURRENT ALTERNATOR - 350 AMP @ 15 VOLT
FOR DAILY USE / UNIVERSAL APPLICATION

ALT450AC / ALT450AF

HIGH CURRENT ALTERNATOR - 450 AMP @ 15 VOLT
FOR COMPETITION ONLY / UNIVERSAL APPLICATION

ALL ALTERNATORS INCLUDE:
Module - Regulator - Pulley - Extension Cord



MOST POWERFUL ALTERNATOR IN THE MARKET!



HYDRO

"The DS18 NXL400.4D is a worthy Competitor to many of the old school brands. After hearing this amp there is no question in my mind that the new kid on the block can build a good sounding amplifier, and with the Sealed design and rugged construction its likely to provide many years of trouble free listening pleasure"
- Garry Springgay, PASMAG

HYDRO Amplifiers	Channels	Power Output				Signal to Noise Ratio	Low Pass	Subsonic	Frequency Response	Input Sensitivity	Dimensions (Millimeters)
		4 OHMS	2 OHMS	1 OHM	4 OHMS Bridged						
NXL-200.2D	2	2 x 100W	2 x 150W	N/A	1 x 300W	>95dB	40Hz-3KHz	N/A	20-20KHz	0.2-5V	192x125x42
NXL-400.4D	4	4 x 100W	4 x 150W	N/A	2 x 300W	>95dB	40Hz-3KHz	N/A	20-20KHz	0.2-5V	245x125x42
NXL-800.5D	5	4 x 80W + 200W	4 x 125W	N/A	2 x 250W + 300W	>95dB	40Hz-3KHz	N/A	20-20KHz	0.2-5V	295x125x42
NXL-600.1D	1	1 x 250W	1 x 400W	1 x 600W	N/A	>95dB	40Hz-3KHz	10-50Hz	20-20KHz	0.2-5V	215x125x42

▲▲ FOR ALL ELEMENTS



NXL6



MARINE, ATV / UTV & JEEPS
6.5" 2-WAY SPEAKER SYSTEM WITH RGB LED LIGHT

Integrated RGB LED Lighting
Continuous Power Handling 100W RMS
Peak Music Power 300W MAX
Magnet Sensitivity: 91dB at 1W/1M
Nominal Impedance: 4-OHMS
Mounting Depth: 2.52"/64mm
Cut-out Diameter: 5.39"/137mm
Over-All Diameter: 6.93"/176mm
Over-all Height: 3.7"/94mm
25mm Titanium Dome PEI Surround Tweeter

IP65 Marine Grade Compliant Specifications, 100% UV Stable
High Temp injection Molded Composite
High Gloss Basket With UV Coating
High Gloss injection Molded Composite
ASA Grills With UV Coating
Motor Structure Use Y35 Ferrite Main Magnet & Reverse Neodymium Magnet

▲▲ FOR ALL ELEMENTS



NXL8



MARINE, ATV / UTV & JEEPS
8" 2-WAY SPEAKER SYSTEM WITH RGB LED LIGHT

Integrated RGB LED Lighting
Continuous Power Handling 125W RMS
Peak Music Power 375W MAX
Magnet Sensitivity: 93dB at 1W/1M
Nominal Impedance: 4-OHMS
Mounting Depth: 3.11"/79mm
Cut-Out Diameter: 7.09"/180mm
Over-All Diameter: 8.58"/218mm
Over-All Height: 4.45"/113mm
25mm Titanium Dome PEI Surround Tweeter

IP65 Marine Grade Compliant Specifications, 100% UV Stable
High Temp injection Molded Composite
High Gloss Basket With UV Coating
High Gloss injection Molded Composite
ASA Grills With UV Coating
Motor Structure Use Y35 Ferrite Main Magnet & Reverse Neodymium Magnet

▲▲ FOR ALL ELEMENTS



CF65



MARINE & ATV/UTV
6.5" 2-WAY SPEAKER SYSTEM WITH RGB LED LIGHT (pair)

Continuous Power Handling 125 Watts RMS
Peak Music Power 375 Watts MAX
Integrated RGB LED Lighting
Sensitivity: 91dB at 1W/1M
Nominal Impedance: 4 OHMS
Mounting Depth: 2.52" / 64mm
Cut-out Diameter: 5.39" / 137mm
Over-All Diameter: 6.93" / 176mm
Over-all Height: 3.7" / 94mm

IP65 Marine Grade Compliant Specifications, 100% UV Stable
25mm Titanium Dome PEI Surround Tweeter
High Temp injection Molded Composite
High Gloss Basket With UV Coating
Black Carbon Fiber Texture with 316 Metal Mesh
Motor Structure Use Y35 Ferrite Main Magnet & Reverse Neodymium Magnet

▲▲ FOR ALL ELEMENTS



CF8



MARINE & ATV/UTV
8" 2-WAY SPEAKER SYSTEM WITH RGB LED LIGHT (pair)

Continuous Power Handling 150 Watts RMS
Peak Music Power 450 Watts MAX
Integrated RGB LED Lighting
Sensitivity: 93dB at 1W/1M
Nominal Impedance: 4 OHMS
Mounting Depth: 3.11" / 79mm
Cut-Out Diameter: 7.09"/180mm
Over-All Diameter: 8.58"/218mm
Over-All Height: 4.45"/113mm

IP65 Marine Grade Compliant Specifications, 100% UV Stable
Carbon Fiber Texture with 316 Metal Mesh
25mm Titanium Dome PEI Surround Tweeter
High Temp injection Molded Composite
High Gloss Basket With UV Coating
Motor Structure Use Y35 Ferrite Main Magnet & Reverse Neodymium Magnet

▲▲ FOR ALL ELEMENTS



CF10SUB



MARINE 10" SUBWOOFER WITH RGB LED LIGHT

Continuous Power Handling 300 Watts RMS
Peak Music Power 600 Watts MAX
Gloss Basket with UV Coating
Sensitivity: 89dB
Nominal Impedance: 4-OHMS
Mounting Depth: 5.02" / 127.5mm
Cut-Out Diameter: 8.78" / 223mm
Over-All Diameter: 10.75" / 273mm
Over-All Height: 6.71" / 170.5mm

Over-All Height: 6.71" / 170.5mm
IP65 Marine Grade Compliant Specifications, 100% UV Stable
Integrated RGB LED Lighting
High Temp injection Molded Composite High
Motor Structure Use Y35 Ferrite Main Magnet
Grills Black Carbon Fiber Texture with 316 Metal Mesh
High Temp Injection Molded Composite

▲▲ FOR ALL ELEMENTS



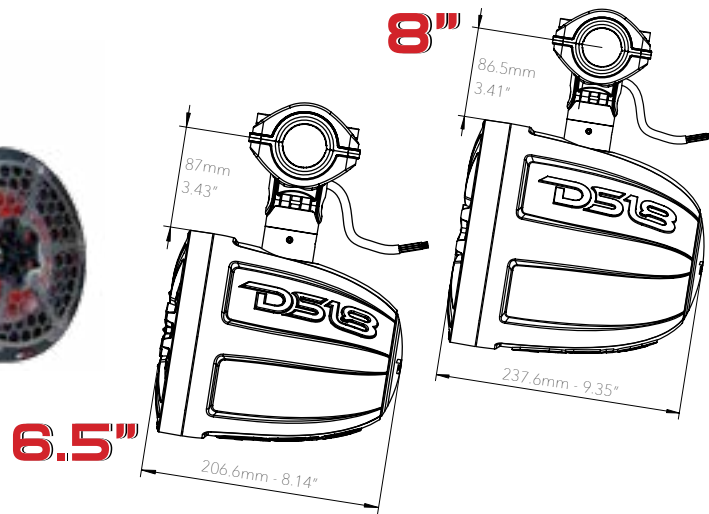

RGB MARINE, ATV / UTV & JEEPS
2-WAY SPEAKER SYSTEM WITH RGB LED LIGHT

**NXL-6UTVR
NXL-8UTVR**

PAIR 6.5" 300 WATTS (Red)
PAIR 8" 375 WATTS (Red)

IP65 Marine-Grade Compliant
6 Core Wires for Lighting and Speaker
RF/BT or wifi Remote LED Controller For Multi-Function RGB LED Lighting (Optional)
Coax Separate Floating Design 1" Titanium Dome PEI Surround Tweeter
Die-cast Solid Aluminum 360-Degree Rotation Mounting Clamps, Full Rounded,
Buried Wire Or Open Wire Mounting Optional, Included (1.5",1.75",2") NBR Pad
UV-Compliant High Gloss, High Polymer With Resin and Fiberglass Composite Body
Injection Molded, UV-Compliant, Polypropylene Cone
High Gloss, ASA Grill / Black Carbon Fiber texture Grill With 316 Metal Mesh
Motor Structure Use Y35 Ferrite Main Magnet & Reverse Neodymium Magnet
Front Logo & Back Cover is Rotatable (When Flat Mounting Can adjust)

**NXL-6UTVW
NXL-8UTVW**

PAIR 6.5" 300 WATTS (White)
PAIR 8" 375 WATTS (White)

**CF-6UTV
CF-8UTV**

PAIR 6.5" 350 WATTS (Black Carbon Fiber)
PAIR 8" 425 WATTS (Black Carbon Fiber)

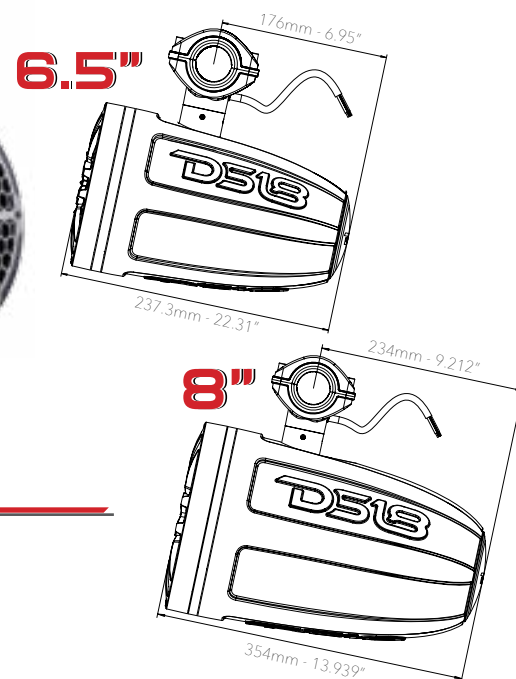

RGB MARINE, ATV / UTV & JEEPS
2-WAY SPEAKER SYSTEM WITH RGB LED LIGHT

**NXL-6TPR
NXL-8TPR
NXL-6TPR/NS
NXL-8TPR/NS**

PAIR 6.5" 300 WATTS (Red)
PAIR 8" 375 WATTS (Red)
PAIR 6.5" NO SPEAKER (Red)
PAIR 8" NO SPEAKER (Red)

Coax Separate Floating Design 1" Titanium Dome PEI Surround Tweeter
Die-cast Solid Aluminum 360-Degree Rotation Mounting Clamps,
Full Rounded, Buried Wire Or Open Wire mounting optional,Included NBR Pad
UV-Compliant High Gloss,High Polymer With Resin and Fiberglass Composite
IP65 Marine-Grade Compliant
High Gloss, ASA Grill
Injection Molded, UV-Compliant, Polypropylene Cone
Motor Structure Use Y35 Ferrite Main Magnet And Reverse Neodymium Magnet
6 Core Wires For Lighting and Speaker
Front Logo And Back Cover is Rotatable (When Flat Mounting is Adjusted)
RF Remote LED Controller Or WIFI Controller Option Available
For Multi-Function RGB LED Lighting (Optional)
Buried Wire or Open Wire Mounting Optional; Included 1.5", 1.75", 2" NBR Pad

**NXL-6TPW
NXL-8TPW
NXL-6TPW/NS
NXL-8TPW/NS**

PAIR 6.5" 300 WATTS (Red)
PAIR 8" 375 WATTS (Red)
PAIR 6.5" NO SPEAKER (Red)
PAIR 8" NO SPEAKER (Red)

**CF-6TP
CF-8TP
CF-6TP/NS
CF-8TP/NS**

PAIR 6.5" 350 WATTS (Black Carbon Fiber)
PAIR 6.5" 425 WATTS (Black Carbon Fiber)
PAIR 8" NO SPEAKER (Black Carbon Fiber)
PAIR 8" NO SPEAKER (Black Carbon Fiber)



HYDRO

RGB MARINE, ATV / UTV & JEEPS
1.75" COMPRESSION DRIVER TOWER SPEAKER SYSTEM

**NXL-DTW
NXL-DTR**

300 WATTS (White)
375 WATTS (Red)

IP65 Marine-Grade Compliant
6 Core Wires for Lighting and Speaker
RF/BT or wifi Remote LED Controller
For Multi-Function RGB LED Lighting (Optional)
Coax Separate Floating Design
1" Titanium Dome PEI Surround Tweeter
Die-cast Solid Aluminum 360-Degree
Rotation Mounting Clamps, Full Rounded,
Buried Wire Or Open Wire Mounting Optional,
Included (1.5",1.75",2") NBR Pad

UV-Compliant High Gloss, High Polymer
With Resin and Fiberglass Composite Body
Injection Molded, UV-Compliant, Polypropylene Cone
High Gloss, ASA Grill / Black Carbon Fiber
texture Grill With 316 Metal Mesh
Motor Structure Use Y35 Ferrite Main Magnet
& Reverse Neodymium Magnet
Front Logo & Back Cover is Rotatable
(When Flat Mounting Can adjust)

CF-DT

375 WATTS (Red)



RGB MARINE, ATV / UTV & JEEPS
6" 3-WAY DOUBLE TOWER SPEAKERS WITH COMPRESSION DRIVER SYSTEM

**NXL-62TDR
NXL-82TDR**

6.5" 750 WATTS (Red)
8" 900 WATTS (Red)

1.35" Titanium Diaphragm Compression Driver
18dB Crossover with Temperature Switch
Ferro Fluid Cools the Voice Coil and Increases the Sensitivity
Die-Cast Solid Aluminum Mounting Clamps, Full Rounded
Buried Wire Or Open Wire Mounting Optional. Included (1.5", 1.75", 2") NBR Pad
(3" Mobile Die-cast Solid Aluminum Clamps Optional,
Included (2.25", 2.5", 2.75", 3") NBR Pad
IP65 Marine-Grade Compliant
UV-Compliant High Gloss, High Polymer With Resin And Fiberglass Composite
Injection Molded, UV-Compliant, Polypropylene Cone
Motor Structure Use Y35 Ferrite Main Magnet and Reverse Neodymium Magnet
Integrated LED-RGB Speaker Lighting
6 Core Wires For Lighting And Speaker
Front Logo and Back Cover are Rotatable (When Flat Mounting Is Adjusted)
RF Remote LED Controller or WiFi Controller For Multi-Function RGB LED Lighting (Optional)

**NXL-62TDW
NXL-82TDW**

6.5" 750 WATTS (White)
8" 900 WATTS (White)

**CF-62TD
CF-82TD**

6.5" 750 WATTS (Black Carbon Fiber)
8" 900 WATTS (Black Carbon Fiber)

SBAR25



MARINE, ATV / UTV & JEEP 25" SOUND BAR WATERPROOF SPEAKER SYSTEM

For All Elements - Marine, ATV / UTV & Jeeps
25" Sound Bar Waterproof Speaker System
Continuous Power Handling 200 Watts RMS
Peak Music Power 600 Watts MAX
Efficiency: 94.7dB 1W/1M 2.8V

Frequency Response: 63Hz - 20KHz
IP65 Marine-Grade Compliant
Tube Mounting Kit Include
Extrusion Aluminium Cabinet with Black Sand Powder Coating
8 Core Wires For Lighting and Speaker

Integrated LED-RGB Sound Bar Lighting
4 x 4" Speaker ,2 x 1" Titanium Tweeter
RF / BT or WiFi Controller For Multi-Function RGB LED Lighting (Optional)

▲▲ FOR ALL ELEMENTS



ME22W

22" 120W 9600LM OFF ROAD/MARINE LIGHT BAR SERIES

Voltage: DC 9-32V
Power 120W
Color Temperature: 6000K
Light Beam: Spot/Flood/Combo Beam Optional

LED Source: EPISTAR Led
Waterproof Grade: IP68
Work Environment: -40°C~+105°C
White Housing



ME14W

14" 72W 5760LM OFF ROAD/MARINE LIGHT BAR SERIES

Voltage: DC 9-32V
Power 72W
Color Temperature: 6000K
Light Beam: Spot/Flood/Combo Beam Optional

LED Source: EPISTAR Led
Waterproof Grade: IP68
Work Environment: -40°C~+105°C
White Housing



ME7W

7" 36W 2880LM OFF ROAD/MARINE LIGHT BAR SERIES

Voltage: DC 9-32V
Power 36W
Color Temperature: 6000K
Light Beam: Spot/Flood/Combo Beam Optional

LED Source: EPISTAR Led
Waterproof Grade: IP68
Work Environment: -40°C~+105°C
White Housing



STORM

WATERPROOF WIRELESS BLUETOOTH SPEAKER WITH MICROPHONE

4.2 BT Version
Lithium Battery Voltage: 7.4V
Lithium Battery Capacity: 4400 MAH
Speaker Spec: 40 mm 4 OHM 10 Watts
Waterproof: IP67
Battery Life: 9-12 Hours

Output Power: 2 X 10 Watts
Charging Voltage: 5V
THD: <0.3%
SNR: >92dB
BT Distance: 65 Feet
Dimensions: 189mm x 51mm x 80mm



▲▲ FOR ALL ELEMENTS



TSB3B/W

MARINE, ATV / UTV & JEEPS TOWER MOUNTING TUBE WITH MOBILE CLAMPS

Die-Cast Solid Aluminum Full Rounded
Included 2.25",2.5",2.75",3" NBR Pad
Mounting Distance 48.3"-50.3"
UV-Compliant Gloss
Available in Black or White



CLP3RB

FOR ALL HYDRO NXL & CF TOWER MOUNTING MOBILE CLAMPS (single)

Die-cast Solid Aluminum Full Rounded
Buried Wire or Open Wire Mounting Optional
Included/ 2.25",2.5",2.75",3" NBR Pad
360° Rotational Bracket
Tilt Adjustable 30°
UV-Compliant Gloss
Available in Black or White



CLP3RW

FOR ALL HYDRO NXL & CF TOWER MOUNTING MOBILE CLAMPS (single)

Die-cast Solid Aluminum Full Rounded
Buried Wire or Open Wire Mounting Optional
Included t2.25",2.5",2.75",3" NBR Pad
360° Rotational Bracket
Tilt Adjustable 30°
UV-Compliant Gloss
Available in Black or White



TMBRB

HYDRO NXL & CF TOWER MOUNTING 360° ROTATING BRACKET (single)

Die-Cast Aluminum
Tilt Adjustable 30°
UV-Complaint Gloss



TMBRW

HYDRO NXL & CF TOWER MOUNTING 360° ROTATING BRACKET (single)

Die-Cast Aluminum
Tilt Adjustable 30°
UV-Complaint Gloss



FLMB/B

MARINE & UTV/ATV FLAT MOUNTING (Pair)

Diecast Solid Aluminum
360° Rotational Bracket
Tilt Adjustable 30°

UV-Compliant Gloss
Available in Black or White



FLMB/W

MARINE & UTV/ATV FLAT MOUNTING (Pair)

Diecast Solid Aluminum
360° Rotational Bracket
Tilt Adjustable 30°

UV-Compliant Gloss
Available in Black or White



PKG-M1

MC18BT - MARINE RADIO & PAIR HYDRO-65 MARINE SPEAKERS



MC18BT
Rust-Resistant Chassis
UV-Resistant Faceplate and Trim Ring
Positive LCD Display with Blue Color Backlight
Night illumination (Blue Color)
Support USB/SD/MMC Card.
Front USB Input / SD Card Input
Compatible with CD/MP3/WMA
Supports ID3 tag function Displays Singer, Song and Album's Name)

30 Preset . USA Freq
4x35 Watts Maximum Power Output
Front Panel 3.5mm AUX (Audio) Input
RCA Line Output (1 pair)
Bluetooth
Remote Control
Power Supply: 12 Voltage
Electronic Preset Equalizer (POP/ROCK/CLASSIC/FLAT)
Electronic Volume Control (TRE/BASS/BAL/FADE)

HYDRO-65
6.5" 2-Way Marine Speaker
Frequency: 65-20KHz
Sensitivity: 89dB/W/M
RMS Power: 100W
Max Power: 380W
Magnet: 10oz
Voice Coil: 25mm
Woofer: Injection Cone
Midrange and Tweeter:
35mm Mylar Dome Tweeter

MC18BT

1 DIN MARINE CD/ MP3, AM/FM, BLUETOOTH RECEIVER WITH USB & DETACHABLE FACEPLATE

Rust-Resistant Chassis
UV-Resistant Faceplate and Trim Ring
Positive LCD Display with Blue Color Backlight
Night illumination (Blue Color)
Support USB/SD/MMC Card.
Front USB Input / SD Card Input
Compatible with CD/MP3/WMA
Supports ID3 tag function Displays Singer, Song and Album's Name)
30 Preset . USA Freq
4x35 Watts Maximum Power Output
Front Panel 3.5mm AUX (Audio) Input
RCA Line Output (1 pair)
Bluetooth
Remote Control
Power Supply: 12 Voltage
Electronic Preset Equalizer (POP/ROCK/CLASSIC/FLAT)
Electronic Volume Control (TRE/BASS/BAL/FADE)



HYDRO-65

6.5" 2-WAY MARINE SPEAKER

6.5" 2-Way Marine Speaker
Frequency: 65-20KHz
Sensitivity: 89dB/W/M
100 Watts RMS Power
380 Watts MAX Power

Magnet: 10oz
Voice Coil: 25mm
Woofer: Injection Cone
Midrange and Tweeter:
35mm Mylar Dome Tweeter



HMRBP

WATERPROOF STEREO RECEIVER BUILT FOR THE OUTDOORS

Power: 4x40 Watts
Operation Voltage: 11V-13.6V
Outside ϕ : 113mm
Mounting Hole ϕ : 87.9mm
Mounting Depth: 63mm

Bluetooth
USB
FM Radio
AUX Input
RCA Output



HMRC

WATERPROOF MARINE REMOTE CONTROL

Rubber Buttons
Outside ϕ : 61mm
Mounting Hole ϕ : 51mm
Mounting Depth: 30mm
Multi-Remote Compatible
Ignition Protection Certified

Bright White LED Illumination
Meets ASTMB117 Salt/Fog
Exposure Standard
Meets ASTM4329 UV
Exposure Standard



MCC

MARINE 1-DIN HEADUNIT COVER

Marine 1-Din Headunit Cover
Protect your Marine 1-Din Headunit from Damage & the Marine Environment with MCC Splash Guard. This Protective Bezel & Cover Will Protect Against Water Splashes and Spray. Constructed of UVA Resistant Plastic Dampened Flip-Up



HM2MAUX

WATERPROOF USB & 3.5MM AUX INPUT EXTENSION

Outside ϕ : 38mm
Mounting Hole ϕ : 30mm
Mounting Depth: 40mm



HM1.5A

WATERPROOF ANTENNA

12 Volt Booster FM/AM Antenna
With a 10dB/12dB FM Gain & a 5dB/2dB AM Gain



JHHL

7" LED / RGB HEADLIGHT FOR JEEP, GM, HARLEY DAVIDSON & MORE!

- White Halo D.R.L Ring with Amber Turn Singal Function
- RGB High Power Lens
- RF / BT & WiFi Controller (Optional)
- Low Beam LED 3500LM
- High Beam LED 3800LM
- Back Illuminated DS18 Logo
- LED Canbus Included
- H4 / H13 / 9004 / 9007 Connections Included



VLK LED

LED CONVERSION KITS

Applicable To any Car
 Anti-Glare, Shockproof Design, Stable Light
 Perfect Heat Dissipation Design
 Suitable For General Bulb Model
 Super Long Lifetime: Above 50,000 Hours
 Waterproof Grade: IP68
 Voltage: 8~32V DC
 Power: High Beam: 60 Watts
 Low Beam: 30 Watts
 Single Beam: 30 Watts
 Brightness: High Beam: 5,000LM
 Low Beam: 3,000LM

H1	5202
H3	D2
H4	D4
H7	9004
H10	9005
H11	9006
H13	9007
880	PSX20W



L BRACKET LED BAR DOUBLE ROW LED BAR

- ED42 42" 240W 19200LM
- ED31 31" 180W 14400LM
- ED22 22" 120W 9600LM
- ED13 13" 72W 5760LM
- ED7 7" 36W 2880LM



L BRACKET LED BAR SINGLE ROW LED BAR

- ES28 28" 140W 11200LM
- ES21 21" 90W 7200LM
- ES7 7" 30W 2400LM



A BRACKET LED BAR DOUBLE ROW LED BAR

- (Spot/ Flood/ Combo Beam)
- BC21.5 20" 126W 126400LM
 - BC15 15" 108W 10800LM
 - BC10 10" 72W 17200LM
 - BC7 7" 36W 3600LM
 - LDWL-007A 6" 24W 1920LM
 - LDWL-007B 8" 36W 2880LM
 - LDWL-007C 12" 60W 4800LM



A BRACKET LED BAR SINGLE ROW LED BAR

- (Spot/ Flood/ Combo Beam)
- ORWL23.1 23" 120W 12000LM
 - ORWL15.1 15" 80W 8000LM
 - ORWL12.1 12" 60W 6000LM
 - ORWL9.1 9" 40W 4000LM
 - ORWL5.1 5" 20W 2000LM



COLOR LENS COVERS
 Add Custom Color to Your LED Bars!

- ORC1 - 150mm x 80mm
- ORC2 - 80mm x 50mm

Poly- Carbonate Protective Lens Covers For Light Bars
 2 Sizes Can Be Combined Together To Suit Straight Light Bars
 6 Colors Available: Blue, Green, Red, Orange, Black & Clear



BRELAY



Ultra-High-End luxury switch. Output circuit protection, overload protection, reverse polarity protection & multiple protection

1. Voltage: DC 9-16V
2. Wire Length: 3m
3. DT Connector

BRELAYROKER



LED STRIPS

CAR, HOME & MULTI-PURPOSE



SL-3528-300-RGB

SL-5050-300-RGB

1. Voltage: DC 12V 18W
2. 5 Meters / 16 Feet
3. 300SMD RGB
4. Waterproof Grade: IP65
5. Work Environment: -40°C+105°C
6. Wireless Control Remote



SL-5050-300-W (white light)

SL-5050-300-B (blue light)

1. Voltage: DC 12V
2. 5 Meters / 16 Feet
3. LED Source: 5050 300SMD
4. Waterproof Grade: IP65
5. Work Environment: -40°C+105°C



SL-3528-1-W (white light)

SL-3528-1-B (blue light)

SL-3528-1-R (red light)

1. Voltage: DC 12V
2. 1 Meter / 3 Feet Long x 5mm Wide
3. LED Source: 3528 90SMD
4. Waterproof Grade: IP65
5. Work Environment: -40°C+105°C
6. LED Slim Strip Light



WADAPTER

1. AC/DC Adapter
2. Input: AC100-240V 50/60Hz
3. Output: 12V-2.0A
4. For LED Strip Light



UCKITFLEX / LED

UNDER CAR LED KIT FLEXIBLE

DRL12FLEXRGB/LED

17" 6W/PCS - RGB - PAIR

4pcs (2x36"+2x48") RGB 15 Flashing Modes



- Input Voltage: 9-32V
Output Power: 6W/PCS
IP Grade: IP67
Certificate: E-MARK
RGB Types Of Remote Control Changing



DRL5 / LED

11.5" 5W/PCS - PAIR



- Input Voltage: 9-32V
Output Power: 5W/PCS
IP Grade: IP67
Certificate: E4
Color Temperature: 6000K

DRL12FLEXRGBR/LED

17" 5W/PCS - PAIR



- Input Voltage: 9-32V
Output Power: 6W/PCS
IP Grade: IP67
Color Temperature: 6000K
Life-Span: 50000/hours

DRL12FLEXRGBW/LED

17" 5W/PCS - PAIR



- Input Voltage: 9-32V
Output Power: 6W/PCS
IP Grade: IP67
Color Temperature: 6000K
Life-Span: 50000/hours

REPLACEMENT LED BULBS

T10-5630-6SMD-B (blue light)

- T10-5630-6SMD-W** (white light)
1. Voltage: DC 12V
 2. Power & Brightness: 3W 240Lumens
 3. LED Source: 6SMD 5630
 4. Waterproof Grade: IP68
 5. Work Environment: -40°C+105°C
 6. Pack of 10



T10-5630-6SMD-BC (blue light)

- T10-5630-6SMD-WC** (white light)
1. Voltage: DC 12V
 2. Power & Brightness: 3W 240Lumens
 3. LED Source: 6SMD 5630 CANBUS
 4. Waterproof Grade: IP68
 5. Work Environment: -40°C+105°C
 6. Pack of 10



T10-5630-10SMD-W (white light)

1. Voltage: DC 12V
2. Power & Brightness: 5W 400Lumens
3. Light Color: White Light
4. LED Source: 10SMD 5630
5. Waterproof Grade: IP68
6. Work Environment: -40°C+105°C
7. Pack of 10



T10-5630-10SMD-WC

1. Voltage: DC 12V
2. Power & Brightness: 3W 240Lumens
3. Light Color: White Light
4. LED Source: 6SMD 5630 CANBUS
5. Waterproof Grade: IP68
6. Work Environment: -40°C+105°C
7. Pack of 10



FT-31MM-S85-5630-6SMD

1. Voltage: DC 12V
2. Power & Brightness: 3W 240Lumens
3. Light Color: White Light
4. LED Source: S85 6SMD 5630
5. Waterproof Grade: IP68
6. Work Environment: -40°C+105°C
7. Pack of 10



FT-36MM-S85-5630-6SMD

1. Voltage: DC 12V
2. Power & Brightness: 3W 240Lumens
3. Light Color: White Light
4. LED Source: S85 6SMD 5630
5. Waterproof Grade: IP68
6. Work Environment: -40°C+105°C
7. Pack of 10



PCB-5050-24SMD

1. Voltage: DC 12V
2. Power & Brightness: 4.8W 384Lumens
3. Light Color: White Light
4. LED Source: 24SMD 5050
5. Waterproof Grade: IP68
6. Work Environment: -40°C+105°C
7. Pack of 10



3157-1210-60SMD-DY/W

1. Voltage: DC 12V
2. Power & Brightness: 12W 960Lumens
3. Light Color: White / Yellow Light
4. LED Source: 60SMD 1210
5. Waterproof Grade: IP68
6. Work Environment: -40°C+105°C
7. Pack of 10



T10-5050-4SMD-W

1. Voltage: DC 12V
2. Power & Brightness: 2W 160Lumens
3. Light Color: White Light
4. LED Source: 4SMD 5050
5. Waterproof Grade: IP68
6. Work Environment: -40°C+105°C
7. Pack of 10



T10-5050-5SMD-W

1. Voltage: DC 12V
2. Power & Brightness: 1W 180Lumens
3. Light Color: White Light
4. LED Source: 5SMD 5050
5. Waterproof Grade: IP68
6. Work Environment: -40°C+105°C
7. Pack of 10



T10-5050-9SMD-W

1. Voltage: DC 12V
2. Power & Brightness: 1.8W 144Lumens
3. Light Color: White Light
4. LED Source: 9SMD 5050
5. Waterproof Grade: IP68
6. Work Environment: -40°C+105°C
7. Pack of 10



PCB-5050-9SMD

1. Voltage: DC 12V
2. Power & Brightness: 1.8W 144Lumens
3. Light Color: White Light
4. LED Source: 9SMD 5050
5. Waterproof Grade: IP68
6. Work Environment: -40°C+105°C
7. Pack of 10



FT-39MM-S85-5630-6SMD

1. Voltage: DC 12V
2. Power & Brightness: 3W 240 Lumens
3. Light Color: White Light
4. LED Source: S85 6SMD 5630
5. Waterproof Grade: IP68
6. Work Environment: -40°C+105°C
7. Pack of 10



FT-31MM-5050-4SMD

1. Voltage: DC 12V
2. Power & Brightness: 0.8W 32 Lumens
3. Light Color: White Light
4. LED Source: 4SMD 5050
5. Waterproof Grade: IP68
6. Work Environment: -40°C+105°C
7. Pack of 10



FT-42MM-S85-5630-6SMD

1. Voltage: DC 12V
2. Power & Brightness: 2W 160 Lumens
3. Light Color: White Light
4. LED Source: S85 6SMD 5630
5. Waterproof Grade: IP68
6. Work Environment: -40°C+105°C
7. Pack of 10



FT-36MM-5050-6SMD

1. Voltage: DC 12V
2. Power & Brightness: 1.2W 96 Lumens
3. Light Color: White / Yellow Light
4. LED Source: 6SMD 5050
5. Waterproof Grade: IP68
6. Work Environment: -40°C+105°C
7. Pack of 10

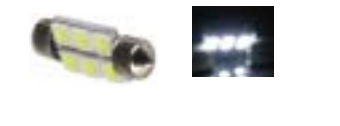

T10-5630-6SMD-WC

1. Voltage: DC 12V
2. Power & Brightness: 1.2W 96 Lumens
3. Light Color: White / Yellow Light
4. LED Source: 6SMD 5630
5. Waterproof Grade: IP68
6. Work Environment: -40°C+105°C
7. Pack of 10



FT-42MM-5050-6SMD

1. Voltage: DC 12V
2. Power & Brightness: 3W 240 Lumens
3. Light Color: White Light
4. LED Source: 6SMD 5630 Canbus
5. Waterproof Grade: IP68
6. Work Environment: -40°C+105°C
7. Pack of 10



LASERFOG / LED

LASER FOG LIGHT

1. Voltage: DC 12-24V
2. Laser Wavelength: 650nm (red)
3. Angle Range: Up Or Down ± 90°C
4. Waterproof Grade: IP65
5. Work Environment: -20°C~+70°C

INSTALLATION METHOD

- Alternative Connection To Below Line is Workable
1. Connect to Fog Lamps Line
 2. Connect to Brake Lamps Line
 3. Connect to Dangerous Warning Lamps Line



Now you can enjoy your favorite music on the move with superior quality sounds. DS18 high-end headphones deliver that bass feeling directly to your ears, light weighted, foldable and bluetooth compatibility.

BOLD HIGH DEFINITION NOISE CANCELING FOLDABLE BT HEADPHONE

Built - In Microphone
 Answer/Hang Up Phone Calls Directly From Headphone
 Speaker: Φ40mm
 Impedance: 32Ω
 Sensitivity: 105 ± 3dB S.P.L at 1KHz
 Frequency Response: 20-20KHz
 Rated Power: 50mW
 Working Distance Range: 32 Feet
 Charging Time: 2 Hours
 Talking / Music Time: 5 hours
 Standby Time: 30 Hours
 Foldable Compact Design
 Provides Portability & Durability
 Includes Travel Pouch
 Cable length: 4 Feet
 Plug Type: USB Plug



HDPBT FOLDABLE BLUETOOTH HEADPHONE WITH TF CARD, FM RADIO & AUX-IN

Speaker: Φ40mm
 Impedance: 32Ω
 Sensitivity: 105±3dB S.P.L at 1KHz
 Frequency Range: 2.402 GHz-2.480 GHz
 Rated Power: 15mW
 Cable length: 120cm ± 2cm
 Working Distance Range: 10 M
 Plug Type: USB plug
 Charging Time: 2 Hours
 Playing Time: 4 hours



HDP WIRED HEADPHONE WITH MICROPHONE

Optimized for Portable Audio: MP3, iPod, Smart Phones, CD Players & More!
 Wired Headphone with Mic
 Speaker: Φ40mm
 Impedance: 32Ω
 Sensitivity: 105 ± 3dB S.P.L at 1KHz
 Frequency Response: 20Hz-22KHz
 Rated Power: 15mW
 Cable Length: 120cm ± 2cm
 Rubber Coating Surface

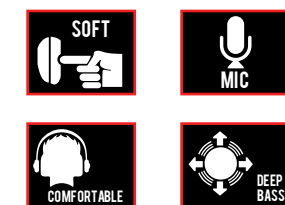

The DS18 COOLBOX24 Thermoelectric Cooler and Warmer is a great accessory to take on road trips, or just to keep at home or in the office. The iceless cooler is easy to use and will keep the inside either hot or cold, depending on how it is set, for as long as it has a power source, and then some. This cooler can be plugged into DC 12V Cars or into AC standard household plugs, and both adapters are included with this cooler so you don't need to purchase any extra accessories. If food is pre-heated or pre-cooled just drop it in the cooler and turn it on to maintain the current temperature.

COOLBOX24 THERMOELECTRIC COOLER AND WARMER

Capacity: Has A Volume Of 24 Liters And Can Fit Upwards Of 34 + 12 Oz Cans
 2 Temperature Settings: Gets as Cold as 34F & Can Warm Up To 140F;
 Includes Hot/Cold/Off Switch, Ac/Dc Switch, And Has Indicator Lights For Hot And Cold
 Heavy Duty Handle For Easy Transport
 Included a 6 Feet DC Power Cord Which Allows The Unit To Be Placed In The Vehicle's Backseat
 Operates On 12V Dc (Cord Included) For Use In Vehicles,
 Or Can Be Plugged Into Ac (Cord Included) For Home And Office Use



Travel with comfort and style with DS18 Chill-Pill and Auto-Mat. The Chill Pillow is a great accessory for long plane or car rides. With its unique design and small size, the Chill-Pill is easy to carry and gives great posture when the need to sleep arises in an uncomfortable situation. The Auto Mattress is a great addition to any car, great for road trips or a quick nap during your lunch break, just inflate your Auto-Mat and turn the backseat of your car into a comfortable bed. Both products are made with micro fleece material; they are soft to the touch and will never harm your skin.



AUTO-MAT INFLATABLE CAR BED

Automatically Turn your Car's Backseat Into a Comfortable Bed!
 Material: PVC + Flocking
 Capacity: 1-2 People (300 kg)
 Can Be Used as a Bed or as a Couch
 Great for Cars, Camping, Roadtrips, Napping etc.
 Dimensions: 55 x 35.4 x 17.7"
 2 Pillows Included

AUTO-MAT IS AVAILABLE IN BLUE AND BLACK



CHILL-PILL INFLATABLE PILLOW

Material: PVC + Flocking
 Soft Material & Washable Cover
 Inflatable & Portable Design
 Packed Size: 50cm x 40cm x 28cm
 Inflated Size: 55cm x 35cm x 30cm
 Great for Airplanes, Cars, Buses, Trains, Camping etc.
 Easily Inflate and Deflate
 You Can Easily Inflate This Napping Pillow With Just 5-8 Breaths
 and Deflate This Travel Air Pillow With Just Pressing The Gas Nozzle

CHILL-PILL IS AVAILABLE IN BLUE AND BLACK





MB-XLR20 MICROPHONE CABLE
XLR3 Female to XLR3 Male 20ft



MB-DTS10 STEREO INTERCONNECT
Dual 1/4" TS to Dual 1/4" TS 10ft



MB-DTS10 INSERT CABLE 1/4"
Mono Plug to Dual 1/4" TS 10ft



MB-TRS2MN3 INSERT CABLE 1/4"
1/4" Mono Plug to 3.5mm TRS 3ft



MB-TRS2MN10 INSERT CABLE 1/4"
1/4" Mono Plug to 3.5mm TRS 10ft



MB-TS10 SPEAKER CABLE 16GA
1/4" TS to 1/4" TS



MB-TS25 SPEAKER CABLE 14GA
1/4" TS to 1/4" TS



MB-TS50 SPEAKER CABLE 12GA
1/4" TS to 1/4" TS



MB-TRS3 BALANCED INTERCONNECT
1/4" TRS to 1/4" TRS 3ft



MB-TRS6 BALANCED INTERCONNECT
1/4" TRS to 1/4" TRS 6ft



MB-TRS10 BALANCED INTERCONNECT
1/4" TRS to 1/4" TRS 10ft



MB-TRS25 BALANCED INTERCONNECT
1/4" TRS to 1/4" TRS 25ft



MP3DUAL1/4-3 STEREO CABLE
AUX 3.5" MP3 to Dual 1/4" 3ft



MP3DUAL1/4-6 STEREO CABLE
AUX 3.5" MP3 to Dual 1/4" 6ft



MP3MIC1/4-3 STEREO CABLE
AUX 3.5" MP3 to 1/4" Stereo TRS 3ft



MB-5XLR5 XLR CABLE
5 Pin Male to Female 5ft



MB-5XLR10 XLR CABLE
5 Pin Male to Female 10ft

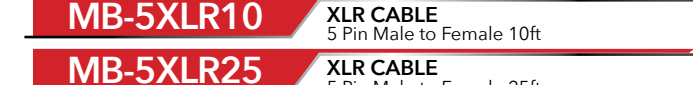

MB-5XLR25 XLR CABLE
5 Pin Male to Female 25ft



MB-GC3 GUITAR CABLE
6.35 Mono Plug 3ft

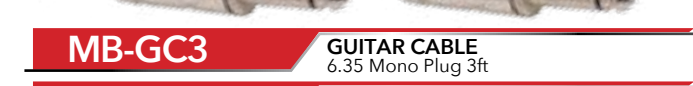

MB-GC6 GUITAR CABLE
6.35 Mono Plug 6ft

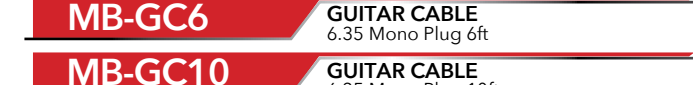

MB-GC10 GUITAR CABLE
6.35 Mono Plug 10ft



MB-GC20 GUITAR CABLE
6.35 Mono Plug 20ft



MB-SN10 SPEAKER CABLE 16GA
Speakon to Speakon 10ft



MB-SN25 SPEAKER CABLE 14GA
Speakon to Speakon 25ft



MB-SN50 SPEAKER CABLE 12GA
Speakon to Speakon 50ft



MB-TS2SN10 SPEAKER CABLE 16GA
Speakon to 1/4 RSL 6.35 Mono 10ft



MB-TS2SN25 SPEAKER CABLE 14 GA
Speakon to 1/4 RSL 6.35 Mono 25ft



MB-TS2SN50 SPEAKER CABLE 12GA
Speakon to 1/4 RSL 6.35 Mono 50ft



MB-XLRF2TRS3 PRO BALANCED INTERCONNECT
REAN XLR3F to 1/4" TRS 3ft



MB-XLRF2TRS6 PRO BALANCED INTERCONNECT
REAN XLR3F to 1/4" TRS 6ft



MB-XLRF2TRS10 PRO BALANCED INTERCONNECT
REAN XLR3F to 1/4" TRS 10ft



MB-XLRF2TRS25 PRO BALANCED INTERCONNECT
REAN XLR3F to 1/4" TRS 25ft



MB-XLRM2TRS3 PRO BALANCED INTERCONNECT
REAN XLR3M to 1/4" TRS 3ft



MB-XLRM2TRS6 PRO BALANCED INTERCONNECT
REAN XLR3M to 1/4" TRS 6ft



MB-XLRM2TRS10 PRO BALANCED INTERCONNECT
REAN XLR3M to 1/4" TRS 10ft

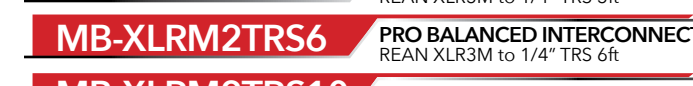

MB-XLRM2TRS20 PRO BALANCED INTERCONNECT
REAN XLR3M to 1/4" TRS 20ft



MB-XLRM2TRS30 PRO BALANCED INTERCONNECT
REAN XLR3M to 1/4" TRS 30ft

At DS18 we see our direct customers as part of our family. And we like to treat our family very well. Throughout the year we have marketing budgets allocated to print, radio, tradeshow, and point of sale merchandise that help increase our brand awareness and your sales. Feel free to contact your DS18 representative for some awesome SWAG merchandise to put up in your stores, warehouses, and to give away to your customers. We are constantly adding and upgrading our SWAG - just like our products

HATS



PENS



LANYARDS



BANNERS



FLAGS



TENTS



DS18 DISPLAY

T-SHIRTS



*Hats and T-shirts available in red, black, and white

LICENSE PLATE

