

FIAMM

THE WORLD'S LARGEST MANUFACTURER OF CAR HORNS



ACOUSTIC DEVICES

Automotive



Industrial & Heavy Duty



Emergency



Marine



Miscellaneous



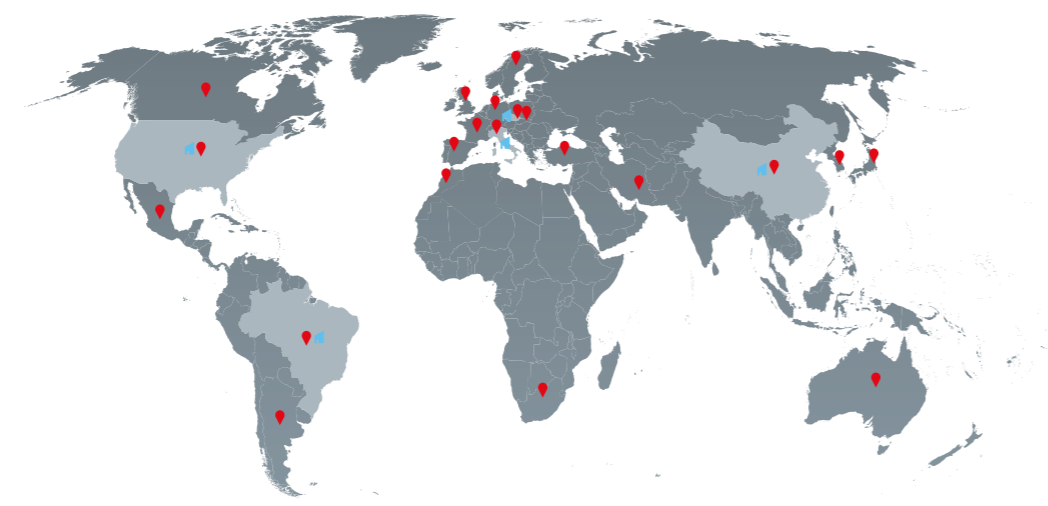

O.E. Customers

- Alfa Romeo
- Aston Martin
- Audi
- BMW
- BYD
- Chrysler
- Citroën
- Ferrari
- FIAT
- Ford
- GM
- Hyundai
- Jaguar
- Lancia
- Land Rover
- Maserati
- Mazda
- Mercedes
- MINI (BMW)
- Mitsubishi
- Nissan
- Opel (GM)
- Peugeot
- Renault
- SEAT
- Škoda
- Toyota
- Vauxall (GM)
- Volvo
- VW
- Caterpillar
- Iveco
- MAN
- Renault Truck
- Scania
- Volvo Truck

Certifications



ELECTROMAGNETIC

The sound is produced through an electro-magnetic circuit that forces a membrane to vibrate at high frequency.

Horns

Discs



ELECTRONIC

Frequency is controlled by an electronic circuit, leading to an increased product lifespan (high usage markets).

Horns

Discs



AIR HORN

The sound is produced when compressed air passes through an acoustic trumpet.

Pneumatic

Solutions operating with the on-board air system of the vehicle.

Electropneumatic

Solutions equipped with a compressor and a set of trumpets.



EMERGENCY SOLUTIONS

Acoustic warning systems for priority and emergency vehicles.

Electronic

Acoustic system for continuous service, composed by an electronic control unit and a set of loudspeakers.

Electropneumatic

Acoustic system composed by a compressor and a set of trumpets.

Pneumatic

Acoustic system composed by an electronic control unit and a set of trumpets.



FIAMM horns are produced in the same production plants where also original equipment horns are manufactured, using the same technology, manpower, equipment and control systems approved by car manufactures.

5 Automotive

Passenger Cars & Light Vehicles

Truck & Bus

Motorbike

19 Industrial & Heavy Duty

29 Emergency

System Overview

PS10 System

MC4 System

PS20 System

49 Marine

55 Miscellaneous

Adapters

Connectors

M4line / MC4 line / MC4 +

Accessories

NOVELTY line

GAS line

Contents

Automotive

6	AM80 line
10	HK line
11	TR99 line
12	JERICHO line / FA 260
13	TIR line / Fultone / TC2 line
14	M4 line / MT line / Ultimate Blast
16	Ala line
17	LLH line
18	BA line / BK line

Industrial & Heavy Duty

20	HK line / HK9E line
22	AM80 line
23	LLH line
24	JERICHO line
25	TIR line
26	M4 line / MT line / Ultimate Blast
28	BA line / BK line

Emergency

30	PS10 System Choice
32	MC4 System Choice
34	PS20 System Choice
36	PS10 System
42	MC4 System
44	PS20 System
46	Trumpets

Marine

50	VEGA line
51	MARINE HORN line
52	TA line

Miscellaneous

56	Adapters
57	Connectors
58	M4 line / MC4 line / MC4+ line
60	Accessories
62	NOVELTY line
64	GAS line
66	Packaging
68	Brackets

Automotive



Passenger Cars
& Light Vehicles
Truck & Bus
Motorbike

FIAMM

AM80 line

THE ORIGINAL EQUIPMENT BEST CHOICE
more compact more powerful





Compact emergency horn approved for road use. The most commonly installed by car manufacturers.



100.000
cycles

AM80SX The Tecnological Evolution

ELECTROMAGNETIC HORNS





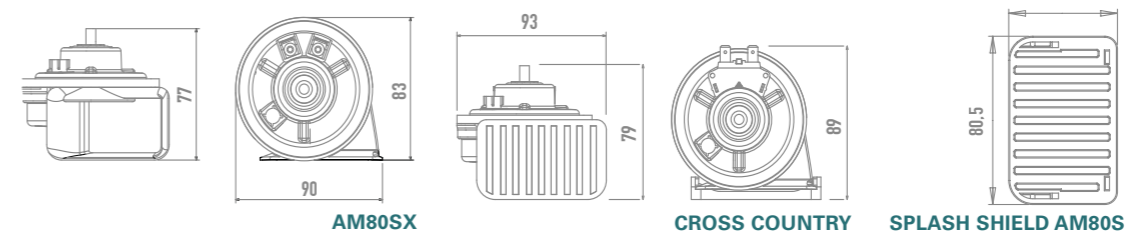

	Voltage	Amp. Draw	Decibel	Frequency	Connectors	M O O	Packaging
	V	A	dB(A) 2m	Hz	See table p. 19	u.	
Steel/ABS 	AM80SX						
Steel/ABS 	CROSS COUNTRY						

Type approval [Reg.28/Reg. 10 ECE](#)











AM80 line

ELECTROMAGNETIC HORNS

	Voltage	Amp. Draw	Decibel	Frequency	Connectors	M O Q	Packaging	
	V	A	dB(A) 2m	Hz	See table p.19	u.		
Steel/ABS 	KIT		CITROEN / DACIA / PEUGEOT / RENAULT					
AM80SX KIT 2TJS COD. 932326Z + 1 RELAY	12	9	110	L = 405 H = 500	2T JUMPER JPT JUMPER SICMA II	36	I16	
AM80SX/H KIT 2TJS COD. 932324Z	12	4,5	107	H = 500	2T JUMPER JPT JUMPER SICMA II	63	S6	
AM80SX/L KIT 2TJS COD. 932325Z	12	4,5	107	L = 405	2T JUMPER JPT JUMPER SICMA II	63	S6	
Steel/ABS	KIT		AUDI / MERCEDES AMG / MERCEDES BENZ / SEAT / SMART / SKODA VOLKSWAGEN					
AM80SX/H KIT 2TV COD. 932327Z	12	4,5	107	H = 500	2T VDA	63	S6	
AM80SX/L KIT 2TJS COD. 932328Z	12	4,5	107	L = 405	2T VDA	63	S6	
Steel/ABS	KIT		ALFA ROMEO / ASTON MARTIN / CHEVROLET / FERRARI / FIAT / FORD HOLDEN / JAGUAR / LAND ROVER / LANCIA / MASERATI / NISSAN / OPEL SAAB / VAUXHALL MOTORS / VOLVO					
AM80SX KIT 2TJU COD. 932331Z + 1 RELAY	12	9	110	L = 405 H = 500	2T JUMPER JPT JUMPER USCAR	36	I16	
Steel/ABS	KIT		ALFA ROMEO / ASTON MARTIN / FERRARI / FIAT / FORD / JAGUAR LAND ROVER / LANCIA / MASERATI / NISSAN / SAAB / VOLVO					
AM80SX/H KIT 2TJU COD. 932329Z	12	4,5	107	H = 500	2T JPT USCAR	63	S6	
AM80SX/L KIT 2TJU COD. 932330Z	12	4,5	107	L = 405	2T JPT USCAR	63	S6	
Steel/ABS	KIT		BMW / MINI					
AM80S/H KIT SP COD. 927384	12	4,5	107	H = 500	ELO STECKER ELO POWER	63	S6	
AM80S/L KIT SP COD. 927385	12	4,5	107	L = 405	ELO STECKER ELO POWER	63	S6	
Steel/ABS	KIT		CHEVROLET / HOLDEN / MERCEDES VAN / OPEL / RENAULT VAN VAUXHALL MOTORS / VOLKSWAGEN VAN					
AM80SX/H KIT UP COD. 932332Z	12	4,5	107	H = 500	USCAR PACKARD	63	S6	
AM80SX/L KIT UP COD. 932333Z	12	4,5	107	L = 405	USCAR PACKARD	63	S6	

Type approval [Reg.28/Reg. 10 ECE](#)

ELECTROMAGNETIC HORNS

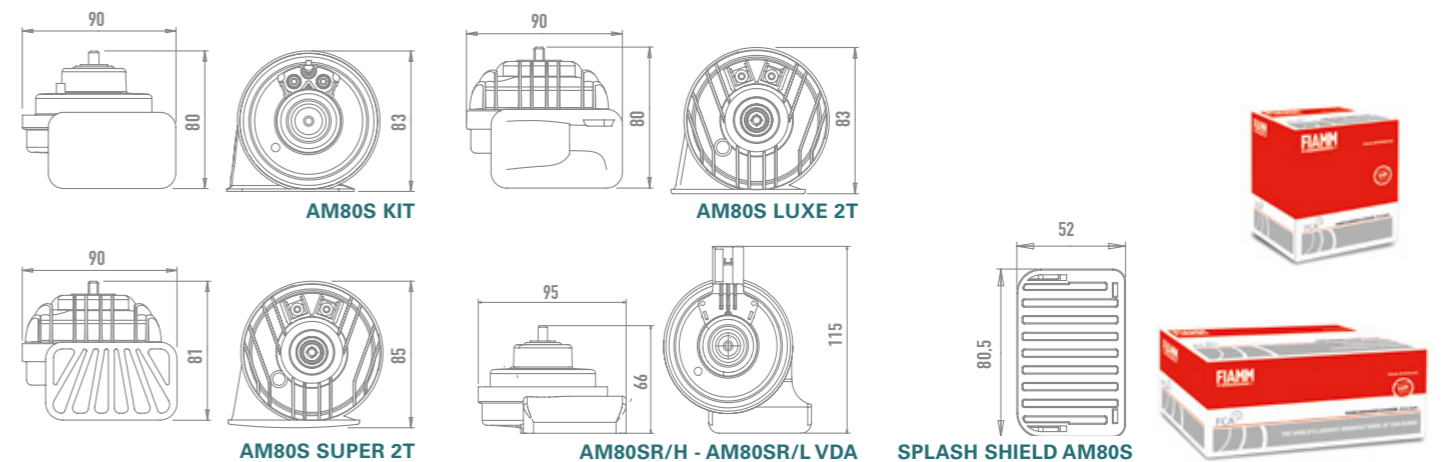

	Voltage	Amp. Draw	Decibel	Frequency	Connectors	M O Q	Packaging	
	V	A	dB(A) 2m	Hz	See table p.19	u.		
Steel/ABS 	SUPER		AM80S SUPER - 2T					
AM80S SUPER - 2T COD. 924650 + 1 RELAY	12	9	110	L = 405 H = 500	2T	36	I16	
Steel/ABS 	LUXE		AM80S LUXE - 2T					
AM80S LUXE - 2T COD. 924648 + 1 RELAY	12	9	110	L = 405 H = 500	2T	36	I16	
Steel/ABS 	AM80S		AM80S-R - 2T					
AM80S-R - 2T COD. 927588 + 1 RELAY	12	9	110	L = 405 H = 500	2T	36	I16	
Steel/ABS 	VDA		AM80SR/H VDA					
AM80SR/H VDA COD. 924869	12	4,5	107	H = 500	VDA	63	S6	
AM80SR/L VDA COD. 924870	12	4,5	107	L = 405	VDA	63	S6	
							Type approval Reg.28/Reg. 10 ECE	
ABS 	SPLASH SHIELD		AM80SX/AM80S/LLH				18	S4
		COD. 920356		KIT OF 4 PCS				



HK line

Approved disc horns, available in the 80 mm version, ideal for applications on motorcycles and small cylinder vehicles, and in the 90 mm version for trucks.

ELECTROMAGNETIC DISC HORNS

	Voltage	Amp. Draw	Decibel	Frequency	M O Q	Packaging
	V	A	dB(A) 2m	Hz	u.	
Steel/Aluminium 						
HK8 HK8 - 2T COD. 930067 + 1 RELAY	12	8	113	L = 350 H = 420	12	I14
HK8/H - 2T COD. 930068	12	4	110	H = 420	18	I12
HK8/L - 2T COD. 930069	12	4	110	L = 350	18	I12
Steel 						
HK9 HK9 - 2T COD. 920994 + 1 RELAY	12	6	113	L = 340 H = 425	12	I14
HK9/H - 2T COD. 920995	12	3	110	H = 425	18	I13
HK9/L - 2T COD. 920996	12	3	110	L = 340	18	I13
HK9 - 2T COD. 920368 + 1 RELAY	24	3	113	L = 340 H = 425	12	I14
HK9/H - 2T COD. 920369	24	1,5	110	H = 425	18	I13
HK9/L - 2T COD. 920370	24	1,5	110	L = 340	18	I13

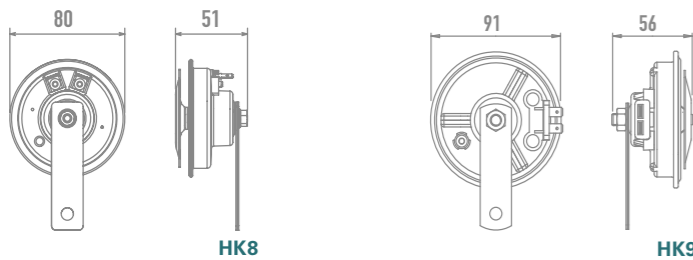

Type approval [Reg.28/Reg. 10 ECE](#)





TR99 line

A full range of approved road emergency horns for trucks that can also be used as industrial vehicle warning signals.

Una gama completa de bocinas de carretera homologadas para camiones, que se pueden utilizar también como señalizadores para vehículos industriales.

ELECTROMAGNETIC HORNS

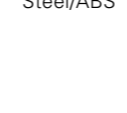
	Voltage	Amp. Draw	Decibel	Frequency	M O Q	Packaging
	V	A	dB(A) 2m	Hz	u.	
Steel/ABS 						
TR99 2T TR99 - 2T COD. 922010 + 1 RELAY	24	5	112	L = 420 H = 500	12	G1
TR99/L+L - 2T COD. 922012 + 1 RELAY	24	5	112	L = 420	12	G1
Steel/ABS 						
TR99 2T TR99/H 24V - 2T COD. 922020	24	2,5	109	H = 500	9	I6
TR99/L 24V - 2T COD. 922021	24	2,5	109	L = 420	9	I6
Steel/ABS 						
TR99 JPT TR99/L+L - JPT COD. 922018 + 1 RELAY	24	65	112	L = 420	12	G1

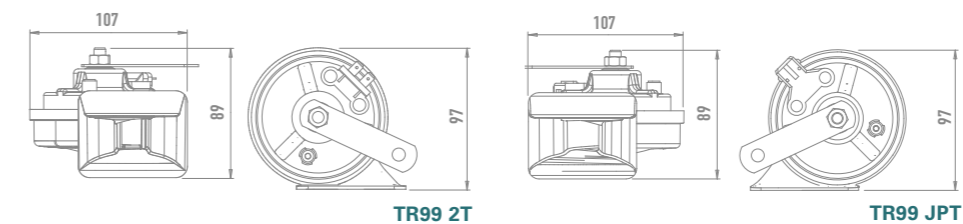

Type approval
[Reg.28/Reg. 10 ECE](#)



JERICHO line / FA 260 line

Pneumatic horns that operate with on-board air.

PNEUMATIC HORNS

		Air consumption	Pressure	Decibel	Frequency	M O Q	Packaging
		l/sec	kPa	dB(A) 2m	Hz	u.	
 ABS 24 V 0,8 A	JERICHO AIR COMPACT DIN CONNECTOR COD. 928028	0,4	300 1000	118	400	13	R
	24V HDSCS CONNECTOR COD. 928026	0,4	300 1000	118	400	13	R
<i>Volvo and Renault Truck since 2013</i>							
 FA 260 COD. 921130		7	500 1000	117	260	6	F17

Type approval [Reg.28/Reg. 10 ECE](#)

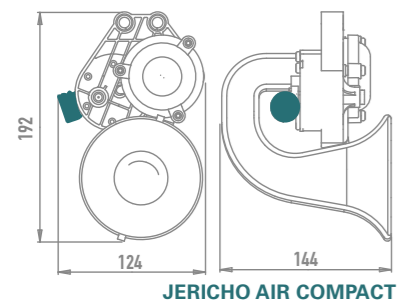

JERICHO AIR COMPACT

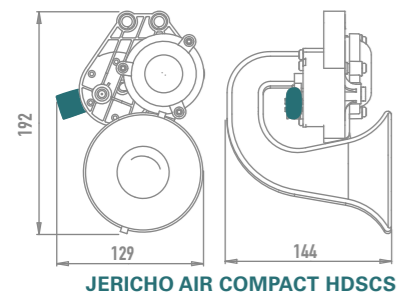

JERICHO AIR COMPACT HDSCS

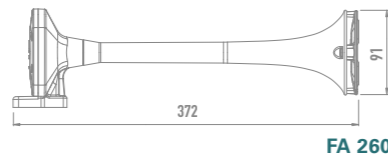



FA 260



TIR line / FULTONE line / TC2 line

PNEUMATIC HORNS

		Air consumption	Pressure	Decibel	Frequency	M O Q	Packaging
		l/sec	kPa	dB(A) 2m	Hz	u.	
Inox Steel  TIR TA150 COD. 920613		5,5	600 1200	118	150	9	M
	TA180 COD. 920614	5,5	600 1200	118	180	9	M
Inox Steel  TIR	SPOILER TIR COD. 920326 KIT OF 2 PCS	-	-	-	-	9	I5
Inox Steel  FULTONE FULTONE T COD. 920308		0,9	500 1200	117	L = 260 H = 300	6	F4
Chromated Steel  FULTONE SPOILER FULTONE T COD. 920322 KIT OF 2 PCS		-	-	-	-	9	I5
ABS  TC2 TC/2 PV COD. 920157		0,9	500 1200	117	L = 392 H = 415	6	F5
	TC/2 PV WITH BRACKET COD. 921126	0,9	500 1200	117	L = 392 H = 415	6	F5

Type approval [Reg.28/Reg. 10 ECE](#)

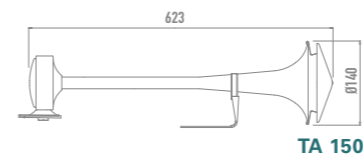

TA 150

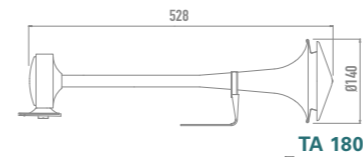

TA 180

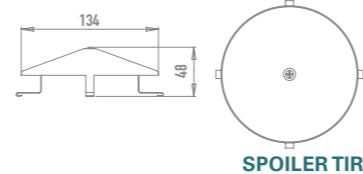

SPOILER TIR

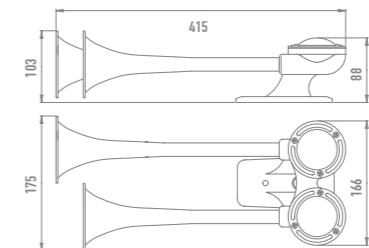

FULTONE

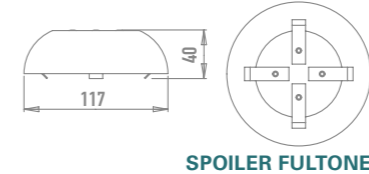

SPOILER FULTONE

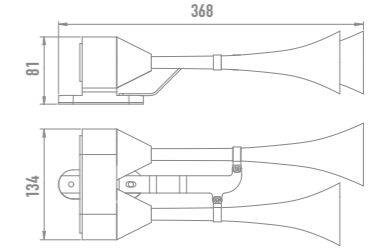





TC2



M4 line / MT line / Ultimate Blast









Electropneumatic emergency horns with a clean and powerful sound, equipped with a new and easy installation compressor.

ELECTROPNEUMATIC HORNS

		Voltage	Amp. Draw	Decibel	Frequency	H	M O Q	Packaging
		V	A	dB(A) 2m	Hz	mm	u.	
	ULTIMATE BLAST 							
	ULTIMATE BLAST COD. 921939	12	19	115	L = 530 H = 660	-	12	C4
	ULTIMATE BLAST COD. 920621	24	8	115	L = 530 H = 660	-	12	C4
	M4/TA2 COD. 921981 PLASTIC	12	17	116	L = 655 H = 828	203 147	10	B3
	M4/TA SPORT COD. 921984 PLASTIC	12	17	116	L = 655 H = 788	193 152	10	B3
	M4/TA2 COD. 921982 PLASTIC	24	8	116	L = 655 H = 828	203 147	10	B3
	M4/TA-BLU COD. 921987 PLASTIC	24	8	116	L = 622 H = 788	212 154	10	B3
								
	M4/TA-BLU COD. 921986 PLASTIC	12	17	116	L = 622 H = 788	212 152	10	B3
	M4/TA2-M COD. 921985 METAL	12	17	116	L = 622 H = 788	212 152	10	B3

Type approval [Reg.28/Reg. 10 ECE](#)

ELECTROPNEUMATIC HORNS

		Voltage	Amp. Draw	Decibel	Frequency	H	M O Q	Packaging
		V	A	dB(A) 2m	Hz	mm	u.	
	M4 							
	M4/TA3 COD. 921983 PLASTIC	12	17	116	L = 655 M = 768 H = 828	203 155 147	10	B3
	MT 							
	TRIO COD. 921967 PLASTIC	12	17	116	L = 655 M = 768 H = 828	203 155 147	10	B1
	MT/3i COD. 921969 PLASTIC	12	17	116	L = 622 M = 695 H = 788	212 193 152	10	B1
	MT/3i Metal COD. 920387 METAL	12	17	116	L = 622 M = 695 H = 788	213 193 152	10	B2
								
	TRIO COD. 921968 PLASTIC	24	8	116	L = 655 M = 768 H = 828	203 155 147	10	B1
	M4/FUL 							
	M4/FUL COD. 921990 INOX STEEL	12	17	115	L = 260 H = 300	-	6	F9



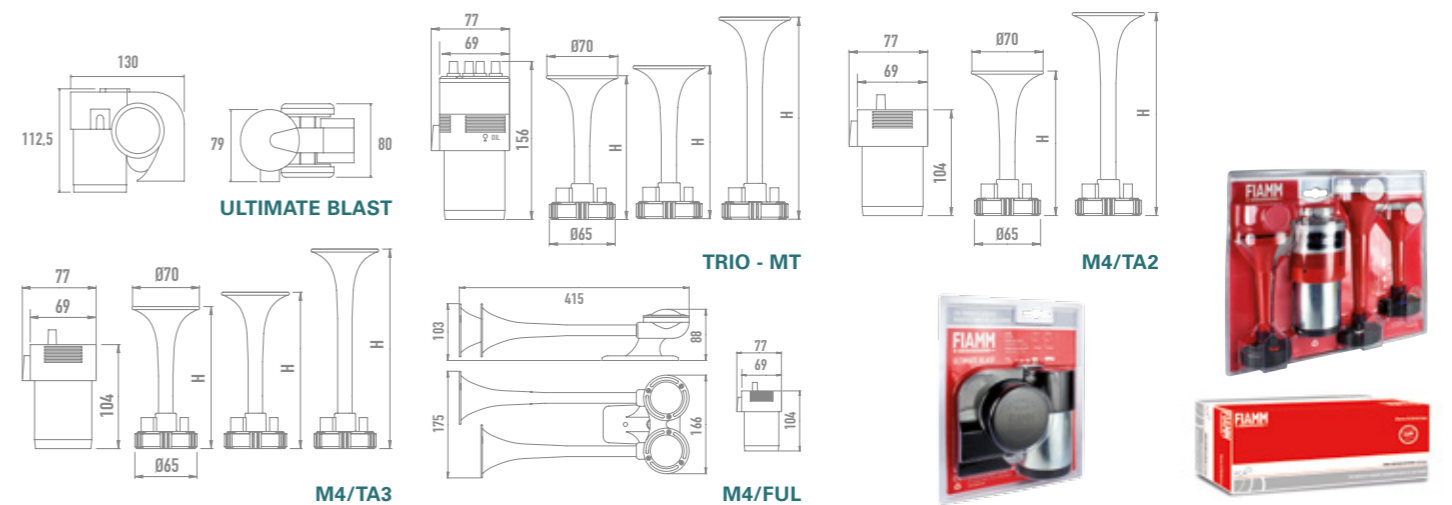

Type approval [Reg.28/Reg. 10 ECE](#)



ALA line

Electropneumatic horn ideal for installations on public transport vehicles.

ELECTROPNEUMATIC HORNS

	Voltage	Amp. Draw	Decibel	Frequency	M O Q	Packaging
Steel/Aluminium ALA 						
 ALA 12V COD. 921997 PLASTIC	12	17	116	L = 390 H = 490	8	H
 ALA 24V COD. 921998 PLASTIC	24	8	116	L = 390 H = 490	8	H
 TA2/ALA COD. 920646 ONLY TRUMPETS	-	-	116	L = 390 H = 490	8	H3

Type approval [Reg.28/Reg. 10 ECE](#)

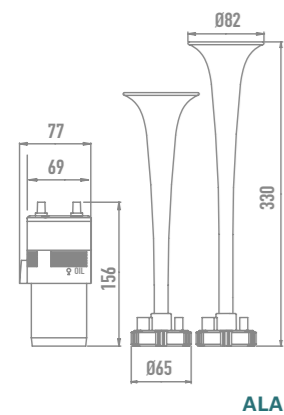

ALA

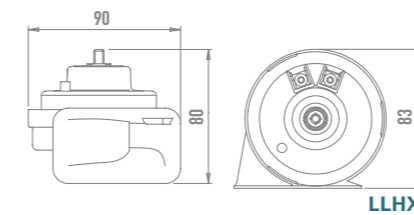



LLHX



LLH line

LLH, is an electronic snail horn engineered by FIAMM. This horn can be installed in every car model thanks to its compact size due to internal electronics assembly and it ensures a duration of more than 2 million cycles.

ELECTRONIC HORNS

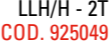
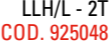
	Voltage	Amp. Draw	Decibel	Frequency	Connectors	M O Q	Packaging
Steel/ABS LLH 							
 LLH - 2T COD. 925047 + 1 RELAY	12	9	110	L = 405 H = 500	2T	12	I14
 LLH/H - 2T COD. 925049	12	4,5	107	H = 500	2T	18	I12
 LLH/L - 2T COD. 925048	12	4,5	107	L = 405	2T	18	I12



Type approval [Reg.28/Reg. 10 ECE](#)

BA line / BK line

ELECTROPNEUMATIC HORNS

		Voltage	Amp. Draw	Decibel	Frequency	M O Q	Packaging
		V	A	dB(A) 2m	Hz	u.	
 ABS	BA  BA87 COD. 923152 TYPE C ALARM	24 12	0,5 1	97	1500	18	12
	BA107 COD. 923158 TYPE B ALARM	24 12	0,5 1	107	1400	18	12
 Nylon	BA  BA87 12-80V COD. 923163 TYPE C ALARM	12 80	0,3	97	1270	18	G2
 ABS	BA  BA112 COD. 923159 TYPE A ALARM	24 12	0,5 1	112	1400	9	13
	BA87-112 ADAPTIVE COD. 923160 TYPE A-D ALARM	24 12	0,5 1	87 112 adaptive	1400	9	13
 Plastic	BA  MINI ALARM 97 COD. 923161	12	0,7	97	1700	18	17
 Steel/ABS	BK  BK9 HEAVY DUTY - 2T COD. 923009	24 12	0,7 1,4	94	780	18	11

Type approval [Reg.28/Reg. 10 ECE](#)

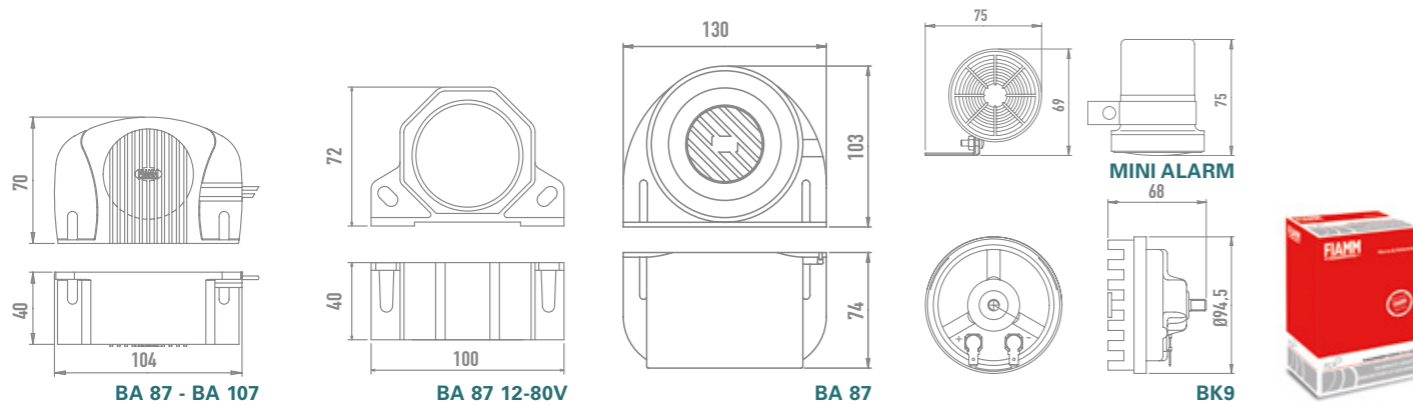

Industrial & Heavy Duty



Electromagnetic
& Electronics Horns
Air Horns
Back-up Alarms

FIAMM

500.000
cycles

HK9E line



ELECTRONIC LONG LIFE HORN
500.000 cycles

Electronic disc horn for industrial and military applications, available in multivoltage 24-48V.

HK line

Approved disc horns, available in the 80 mm version, ideal for applications on motorcycles and small cylinder vehicles, and in the 90 mm version for trucks.

ELECTROMAGNETIC DISC HORNS

		Voltage	Amp. Draw	Decibel	Frequency	M O Q	Packaging
		V	A	dB(A) 2m	Hz	u.	
Steel/Aluminium 	HK8 HK8/H - 2T COD. 930068	12	4	110	H = 420	18	I12
	HK8/L - 2T COD. 930069	12	4	110	L = 350	18	I12
Steel 	HK9 HK9/H - 2T COD. 920995	12	3	110	H = 425	18	I13
	HK9/L - 2T COD. 920996	12	3	110	L = 340	18	I13
	HK9/H - 2T COD. 920369	24	1,5	110	H = 425	18	I13
	HK9/L - 2T COD. 920370	24	1,5	110	L = 340	18	I13

Type approval Reg.28/Reg. 10 ECE

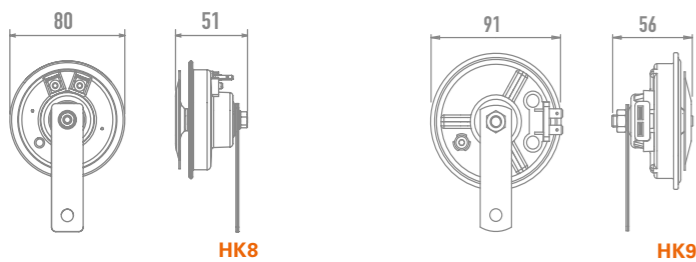

ELECTRONIC DISC HORNS

	Voltage	Amp. Draw	Decibel	Frequency	M O Q	Packaging	
	V	A	dB(A) 2m	Hz	u.		
Steel/ABS 	HK9E HK9/E - 2T COD. 985902	48 24	0,4 0,8	110	430	18	I1

Type approval Reg.28/Reg. 10 ECE

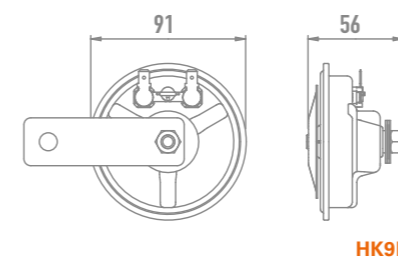

100.000 cycles
AM80 line

Compact emergency horn approved for road use. The most commonly installed by car manufacturers.

ELECTROMAGNETIC HORNS

		Voltage	Amp. Draw	Decibel	Frequency	Connectors	M O Q	Packaging
		V	A	dB(A) 2m	Hz	See table p. 19	u.	
Steel/ABS 	AM80SX AM80SX/H 12V - 2T COD. 932039Z	12	4,5	110	H = 495	2T	63	I17
	AM80SX/L 12V - 2T COD. 932040Z	12	4,5	110	L = 405	2T	63	I17

Type approval **Reg.28/Reg. 10 ECE**

2.000.000 cycles
LLH line

LLH is an electronic snail horn engineered by FIAMM. This horn can be installed in every car model thanks to its compact size due to internal electronics assembly and it ensures a duration of more than 2 million cycles.

ELECTRONIC HORNS

		Voltage	Amp. Draw	Decibel	Frequency	Connectors	M O Q	Packaging
		V	A	dB(A) 2m	Hz	See table p. xx	u.	
Steel/ABS 	LLH LLH/H - 2T COD. 925049	12	4,5	107	H = 500	2T	18	I12
	LLH/L - 2T COD. 925048	12	4,5	107	L = 405	2T	18	I12

Type approval **Reg.28/Reg. 10 ECE**

TR99 line

A full range of approved road emergency horns for trucks that can also be used as industrial vehicle warning signals.

ELECTROMAGNETIC HORNS

		Voltage	Amp. Draw	Decibel	Frequency	M O Q	Packaging
		V	A	dB(A) 2m	Hz	u.	
Steel/ABS 	TR99 2T TR99/H 24V - 2T COD. 922020	24	2,5	109	H = 500	9	16
	TR99/L 24V - 2T COD. 922021	24	2,5	109	L = 420	9	16

Type approval **Reg.28/Reg. 10 ECE**

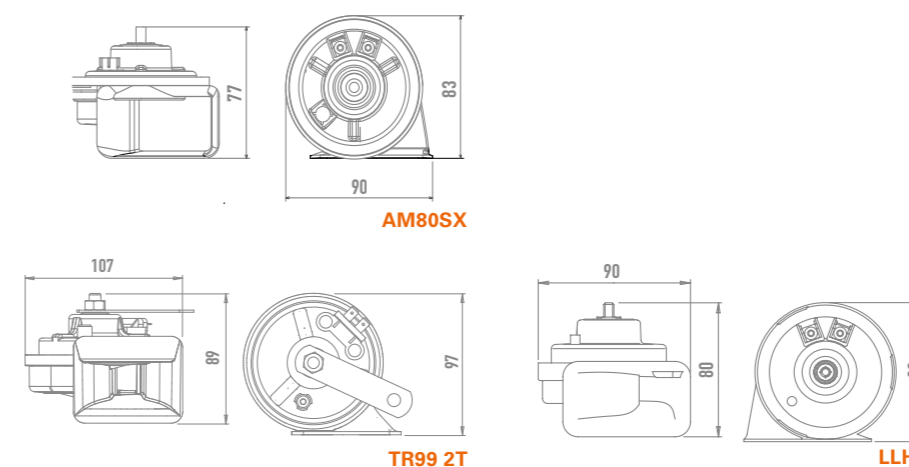

JERICHO line

Pneumatic horns that operate with on-board air.

PNEUMATIC HORNS

		Air consumption	Pressure	Decibel	Frequency	M O Q	Packaging
		l/sec	kPa	dB(A) 2m	Hz	u.	
ABS	JERICHO AIR COMPACT 						
	DIN CONNECTOR COD. 928028	0,4	300 1000	118	400	13	R

24 V | 0,8 A

Type approval [Reg.28/Reg. 10 ECE](#)

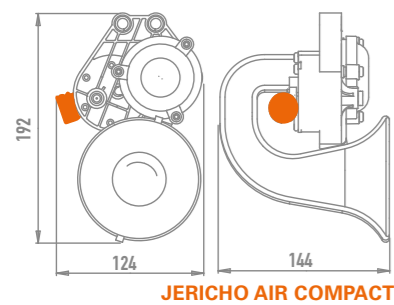

JERICHO AIR COMPACT



TIR line

PNEUMATIC HORNS

		Air consumption	Pressure	Decibel	Frequency	M O Q	Packaging
		l/sec	kPa	dB(A) 2m	Hz	u.	
Inox Steel	TIR  TA150 COD. 920613	5,5	600 1200	118	150	9	M
	TA180 COD. 920614	5,5	600 1200	118	180	9	M
Inox Steel	TIR  SPOILER TIR COD. 920326 KIT OF 2 PCS			-		9	I5
Inox Steel	TA MP  TA MP COD. 920374	5,5	400 800	128	380	5	F15
Inox Steel	FULTONE  FULTONE T COD. 920308	0,9	500 1200	117	L = 260 H = 300	6	F4

Type approval [Reg.28/Reg. 10 ECE](#)

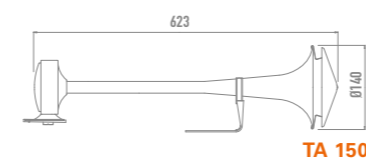

TA 150

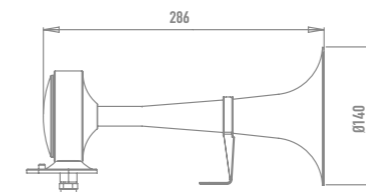

TA MP

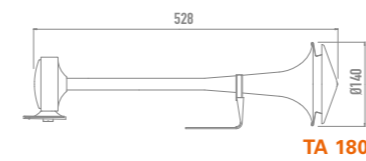

TA 180

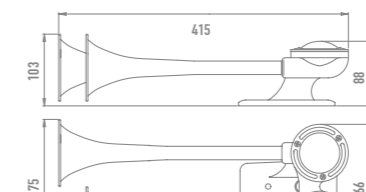

FULTONE

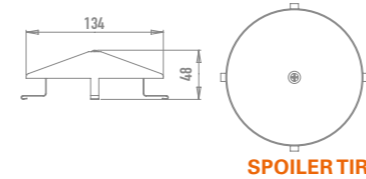



SPOILER TIR



M4 line / MT line / Ultimate Blast

Electropneumatic emergency horns with a clean and powerful sound, equipped with a new and easy installation compressor.

ELECTROPNEUMATIC HORNS

		Voltage	Amp. Draw	Decibel	Frequency	H	M O Q	Packaging
		V	A	dB(A) 2m	Hz	mm	u.	
	ULTIMATE BLAST COD. 921939	12	19	115	L = 530 H = 660	-	12	C4
	ULTIMATE BLAST COD. 920621	24	8	115	L = 530 H = 660	-	12	C4
	M4/TA2 COD. 921981 PLASTIC	12	17	116	L = 655 H = 828	203 147	10	B3
	M4/TA SPORT COD. 921984 PLASTIC	12	17	116	L = 655 H = 788	193 152	10	B3
	M4/TA2 COD. 921982 PLASTIC	24	8	116	L = 655 H = 828	203 147	10	B3
	M4/TA-BLU COD. 921987 PLASTIC	24	8	116	L = 622 H = 788	212 154	10	B3
	M4/TA-BLU COD. 921986 PLASTIC	12	17	116	L = 622 H = 788	212 152	10	B3
	M4/TA2-M COD. 921985 METAL	12	17	116	L = 622 H = 788	212 152	10	B3

Type approval [Reg.28/Reg. 10 ECE](#)

ELECTROPNEUMATIC HORNS

	Voltage	Amp. Draw	Decibel	Frequency	H	M O Q	Packaging
	V	A	dB(A) 2m	Hz	mm	u.	
	M4	12	17	116	L = 655 M = 768 H = 828	203 155 147	10 B3

Type approval [Reg.28/Reg. 10 ECE](#)

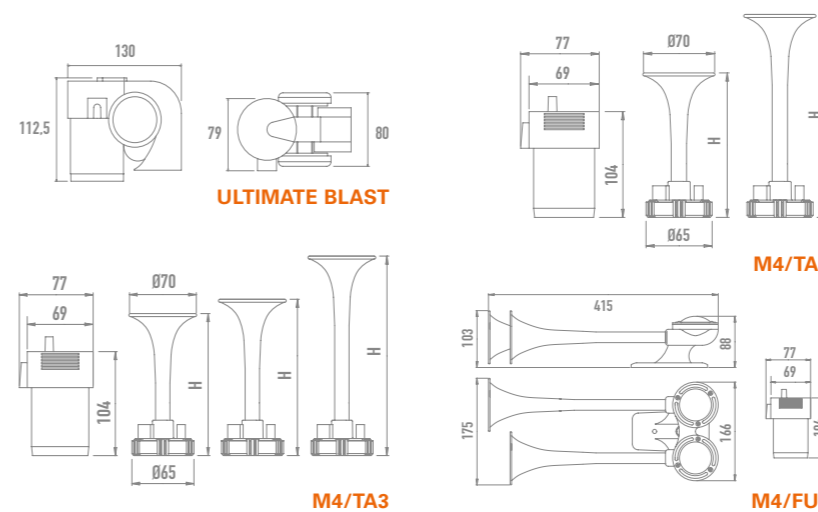

BA line / BK line

ELECTROPNEUMATIC HORNS

		Voltage	Amp. Draw	Decibel	Frequency	M O Q	Packaging
		V	A	dB(A) 2m	Hz	u.	
ABS 	BA  BA87 COD. 923152 TYPE C ALARM	24	0,5	97	1500	18	12
		12	1				
Nylon 	BA  BA87 12-80V COD. 923163 TYPE C ALARM	12	0,3	97	1270	18	G2
		80					
ABS 	BA  BA112 COD. 923159 TYPE A ALARM	24	0,5	112	1400	9	13
		12	1				
Plastic 	BA  BA87-112 ADAPTIVE COD. 923160 TYPE A-D ALARM	24	0,5	87	1400	9	13
		12	1	112 adaptive			
Steel/ABS 	BK  BK9 HEAVY DUTY - 2T COD. 923009	24	0,7	94	780	18	11
		12	1,4				

Type approval Reg.28/Reg. 10 ECE

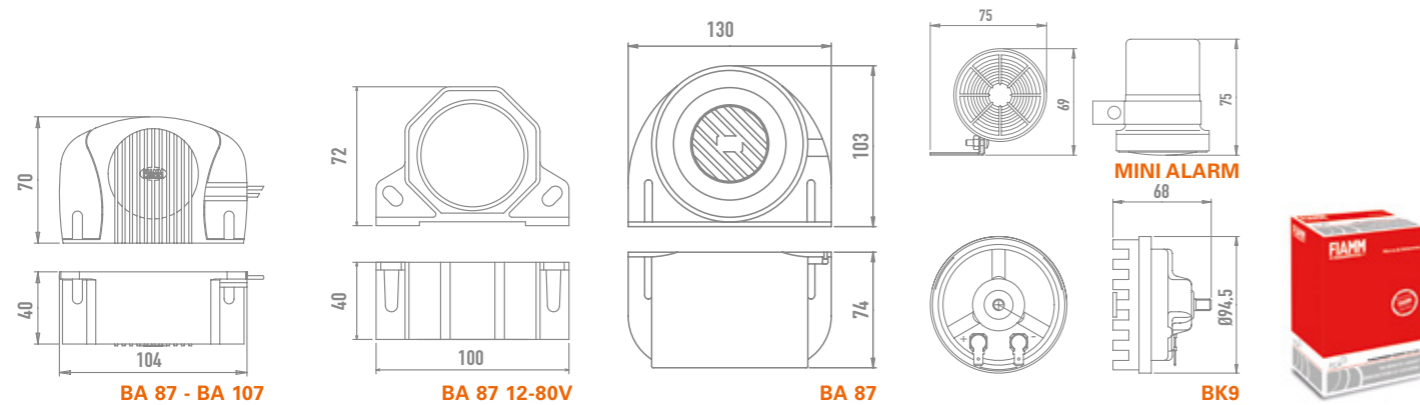

Emergency

Fire Brigades
Police Forces
Ambulances



PS10 System Choice

1 >> Choose your country

2 >> Choose your special force:



Fire Brigades



Ambulance



Police Forces

3 >> Read the code of your electronic module



4 >> Choose your vehicle type [CAR | VAN | TRUCK]

5 >> Read on the left the code of your loudspeaker



6 >> Complete your system with the mandatory connection cable



	Italy	France	Netherlands	Belgium	United Kingdom	Austria	Germany	Switzerland	Latin America	USA	International	
1												
2	 	 	 	 	 	 	 	 	 	 	 	
3	PS10 AMB-POMP-I COD. 951001 PS10 AMB-POMP-WY-I COD. 951062 PS10 POL-I COD. 951013	PS10 AMB-F COD. 951004 PS10 UMH-F COD. 951006 PS10 AMB-UMH-F COD. 951069 PS10 GEN-F COD. 951007 PS10 POL-F COD. 951008 PS10 SPO-F COD. 951005 PS10 SPO-F 24V COD. 951023	PS10 EMER-N COD. 951028 PS10 EMER-N SLOW COD. 951089	PS10 EMER-B COD. 951078 PS10 SPO-B NIGHT COD. 951091	PS10 EMER-UK COD. 951035 PS10 EMER-WY-UK COD. 951064	PS10 AMB-A COD. 951046 PS10 FEUER-A COD. 951064	PS10 EMER-D COD. 951060 PS10 USSOUND COD. 951061 PS10 USSOUND-WY COD. 951063					
4	TRUCK 1 module + • 2 loudspeakers	TRUCK 1 module + • 2 loudspeakers	TRUCK 1 module + • 1 loudsp.	TRUCK 1 module + • 2 loudspeakers	TRUCK 1 module + • 2 loudspeakers	TRUCK 1 module + • 2 loudspeakers	TRUCK 1 module + • 2 loudspeakers					
	TRUCK 1 module + • 2 loudspeakers	TRUCK 1 module + • 2 loudspeakers	TRUCK 1 module + • 1 loudsp.	TRUCK 1 module + • 2 loudspeakers	TRUCK 1 module + • 2 loudspeakers	TRUCK 1 module + • 2 loudspeakers	TRUCK 1 module + • 2 loudspeakers					
	CAR VAN TRUCK 1 module + • 1 loudspeaker (Car, Van) • 2 loudspeakers (Car, Van, Truck)	CAR VAN TRUCK 1 module + • 1 loudspeaker (Car, Van) • 2 loudspeakers (Car, Van, Truck)	TRUCK 1 module + • 1 loudsp.	CAR VAN TRUCK 1 module + • 1 loudsp. (Car, Van) • 2 loudsp. (Car, Van, Truck)	CAR VAN TRUCK 1 module + • 1 loudsp. (Car, Van) • 2 loudsp. (Car, Van, Truck)	CAR VAN TRUCK 1 module + • 1 loudsp. (Car, Van) • 2 loudsp. (Car, Van, Truck)	CAR VAN TRUCK 1 module + • 1 loudspeaker (Car, Van) • 2 loudspeakers (Car, Van, Truck)					
5	CAR VAN TRUCK 1 module + • 1 loudspeaker (Car, Van) • 2 loudspeakers (Car, Van, Truck)	CAR VAN TRUCK 1 module + • 1 loudspeaker (Car, Van) • 2 loudspeakers (Car, Van, Truck)	TRUCK 1 module + • 1 loudsp.	CAR VAN TRUCK 1 module + • 1 loudsp. (Car, Van) • 2 loudsp. (Car, Van, Truck)	CAR VAN TRUCK 1 module + • 1 loudspeaker (Car, Van) • 2 loudsp. (Car, Van, Truck)	CAR VAN TRUCK 1 module + • 1 loudsp. (Car, Van) • 2 loudsp. (Car, Van, Truck)	CAR VAN TRUCK 1 module + • 1 loudspeaker (Car, Van) • 2 loudspeakers (Car, Van, Truck)					
	CAR VAN 1 module + • 1 loudspeaker (Car, Van) • 2 loudspeakers (Car, Van)	CAR VAN 1 module + • 1 loudspeaker (Car, Van) • 2 loudspeakers (Car, Van)	-	CAR VAN 1 module + • 1 loudsp. (Car, Van) • 2 loudsp. (Car, Van)	CAR VAN 1 module + • 1 loudspeaker (Car, Van) • 2 loudspeakers (Car, Van)	CAR VAN 1 module + • 1 loudspeaker (Car, Van) • 2 loudspeakers (Car, Van)	CAR VAN 1 module + • 1 loudspeaker (Car, Van) • 2 loudspeakers (Car, Van)					
	CAR VAN 1 module + • 1 loudspeaker (Car, Van) • 2 loudspeakers (Car, Van)	CAR VAN 1 module + • 1 loudspeaker (Car, Van) • 2 loudspeakers (Car, Van)	-	CAR VAN 1 module + • 1 loudsp. (Car, Van) • 2 loudsp. (Car, Van)	CAR VAN 1 module + • 1 loudspeaker (Car, Van) • 2 loudspeakers (Car, Van)	CAR VAN 1 module + • 1 loudspeaker (Car, Van) • 2 loudspeakers (Car, Van)	CAR VAN 1 module + • 1 loudspeaker (Car, Van) • 2 loudspeakers (Car, Van)					
	MOTORBIKE CAR 1 module + • 1 loudspeaker (Motorbike, Car) • 2 loudspeakers (Motorbike, Car)	MOTORBIKE CAR 1 module + • 1 loudspeaker (Motorbike, Car) • 2 loudspeakers (Motorbike, Car)	-	MOTORBIKE CAR 1 module + • 1 loudsp. (Motorbike, Car) • 2 loudsp. (Motorbike, Car)	MOTORBIKE CAR 1 module + • 1 loudsp. (Motorbike, Car) • 2 loudsp. (Motorbike, Car)	MOTORBIKE CAR 1 module + • 1 loudsp. (Motorbike, Car) • 2 loudsp. (Motorbike, Car)	MOTORBIKE CAR 1 module + • 1 loudspeaker (Motorbike, Car) • 2 loudspeakers (Motorbike, Car)					
6	CONNECTION CABLE COD. 951057						MANDATORY FOR ALL SYSTEMS					



MC4 System Choice

1 >> Choose your country

2 >> Choose your special force: Fire Brigades Ambulance Police Forces

3 >> Read the code of your compressor

4 >> Choose your vehicle type [CAR | VAN | TRUCK]

5 >> Read on the left the code of your trumpets

6 >> Lubricator included in the compressor code

		Italy		Netherlands		Belgium	United Kingdom		Austria		Germany		Switzerland		Spain		International																		
		MC4 FDS 12V COD. 921084		MC4 FVA 12V COD. 921077		MC4 FVA 24V COD. 921078	MC4 FALG 12V COD. 921121		MC4 FALG 24V COD. 921122		MC4 FI 24V COD. 921124		MC4 FI 12V COD. 921123		MC4 FI 24V COD. 921124		MC4 FD 12V COD. 921116		MC4 FA 12V COD. 921118		MC4 FA 24V COD. 921119		MC4 FD 12V COD. 921116		MC4 FD 24V COD. 921117		MC4 FD 12V COD. 921116		MC4 FD 24V COD. 921117		MC4 FI 12V COD. 921123		MC4 FI 24V COD. 921124		SPOLLER COD. 920618
		CAR VAN		CAR VAN		TRUCK	CAR VAN		CAR VAN		TRUCK		CAR VAN		TRUCK		CAR VAN		TRUCK		CAR VAN		TRUCK		CAR VAN		TRUCK		CAR VAN TRUCK		TRUCK				
TA/2 906-V COD. 920392	1 compressor + 1 set of trumpets																																✓		
TA/2 906-C COD. 920393	1 compressor + 1 set of trumpets																																✓		
TA/2 VA-V COD. 920395		CAR VAN	1 compressor + 1 set of trumpets	TRUCK	1 compressor + 1 set of trumpets																												✓		
TA/2 GA-V COD. 920615							CAR VAN	1 compressor + 1 set of trumpets	TRUCK	1 compressor + 1 set of trumpets																							•		
TA/2 GB-V COD. 920616							CAR VAN	1 compressor + 1 set of trumpets	TRUCK	1 compressor + 1 set of trumpets																							•		
TA/2 BL-C COD. 920629								TRUCK	1 compressor + 1 set of trumpets	CAR VAN	1 compressor + 1 set of trumpets	TRUCK	1 compressor + 1 set of trumpets																				•		
TA/2 BL-V COD. 920396								TRUCK	1 compressor + 1 set of trumpets	CAR VAN	1 compressor + 1 set of trumpets	TRUCK	1 compressor + 1 set of trumpets																				•		
TA/2 DE-B COD. 920397											CAR VAN	1 compressor + 1 set of trumpets	TRUCK	1 compressor + 1 set of trumpets																			•		
TA/4 906-C COD. 920394																																	✓		
TA/2 LE-V COD. 920400																																			
LUBRICATOR COD. 920617	ALWAYS INCLUDED WITH THE COMPRESSOR, IN CASE ALSO AVAILABLE AS A SPARE PART																ALWAYS INCLUDED WITH THE COMPRESSOR, IN CASE ALSO AVAILABLE AS A SPARE PART																		

FIAMM



PS20 System Choice

1 >> Choose your country

2 >> Choose your special force:



3 >> Read the code of your electronic control unit



4 >> Choose your vehicle type [CAR | VAN | TRUCK]

5 >> Read on the left the code of your trumpets



	Italy		Netherlands	Belgium	United Kingdom		Austria			Germany		Switzerland		International		✓ = included • = optional		
	🇮🇹	🇳🇱	🇧🇪	🇬🇧	🇦🇹	🇦🇹	🇦🇹	🇦🇹	🇦🇹	🇩🇪	🇩🇪	🇨🇭	🇨🇭	🌐	🌐			
	🚒	🚒	🚒	🚒	🚒	🚒	🚒	🚒	🚒	🚒	🚒	🚒	🚒	🚒	🚒	🚒		
	PS20 - POL - I 12V COD. 951081	PS20 AMB/POMP - I 12V COD. 951082	PS20 AMB/POMP - I 24V COD. 951083	PS20 - HI-LO 12V COD. 951079	PS20 - HI-LO 24V COD. 951080	PS20 - HI-LO 12V COD. 951079	PS20 - HI-LO 24V COD. 951080	PS20 EMER - D 12V COD. 951084	PS20 - FEUER - A 12V COD. 951087	PS20 - FEUER - A 24V COD. 951088	PS20 - FEUER - A 24V COD. 951086	PS20 EMER - D 12V COD. 951084	PS20 EMER - D 24V COD. 951085	PS20 EMER - D 12V COD. 951084	PS20 EMER - D 24V COD. 951085	PS20 - HI-LO 12V COD. 951079	PS20 - HI-LO 24V COD. 951080	
	PS20 - POL - I 12V COD. 951081	PS20 AMB/POMP - I 12V COD. 951082	PS20 AMB/POMP - I 24V COD. 951083	PS20 - HI-LO 12V COD. 951079	PS20 - HI-LO 24V COD. 951080	PS20 - HI-LO 12V COD. 951079	PS20 - HI-LO 24V COD. 951080	PS20 EMER - D 12V COD. 951084	PS20 - FEUER - A 12V COD. 951087	PS20 - FEUER - A 24V COD. 951088	PS20 - FEUER - A 24V COD. 951086	PS20 EMER - D 12V COD. 951084	PS20 EMER - D 24V COD. 951085	PS20 EMER - D 12V COD. 951084	PS20 EMER - D 24V COD. 951085	PS20 - HI-LO 12V COD. 951079	PS20 - HI-LO 24V COD. 951080	
TA/2 906-V COD. 920392	CAR VAN 1 electr.unit + 1 set of trumpets							CAR VAN 1 electr.unit + 1 set of trumpets				CAR VAN 1 electr.unit + 1 set of trumpets	TRUCK 1 compressor + 1 set of trumpets	CAR VAN 1 electr.unit + 1 set of trumpets	TRUCK 1 electr.unit + 1 set of trumpets	CAR VAN TRUCK 1 electr.unit + 1 set of trumpets	TRUCK 1 electr.unit + 1 set of trumpets	✓
TA/2 906-C COD. 920393	CAR VAN 1 electr.unit + 1 set of trumpets							CAR VAN 1 electr.unit + 1 set of trumpets				CAR VAN 1 electr.unit + 1 set of trumpets	TRUCK 1 compressor + 1 set of trumpets	CAR VAN 1 electr.unit + 1 set of trumpets	TRUCK 1 electr.unit + 1 set of trumpets	CAR VAN TRUCK 1 electr.unit + 1 set of trumpets	TRUCK 1 electr.unit + 1 set of trumpets	✓
TA/2 VA-V COD. 920395		CAR VAN 1 electr.unit + 1 set of trumpets	TRUCK 1 electr.unit + 1 set of trumpets															✓
TA/2 BL-C COD. 920629						TRUCK 1 electr.unit + 1 set of trumpets	CAR VAN 1 electr.unit + 1 set of trumpets	TRUCK 1 electr.unit + 1 set of trumpets										•
TA/2 BL-V COD. 920396						TRUCK 1 electr.unit + 1 set of trumpets	CAR VAN 1 electr.unit + 1 set of trumpets	TRUCK 1 electr.unit + 1 set of trumpets										•
TA/2 DE-B COD. 920397									CAR VAN 1 electr.unit + 1 set of trumpets	TRUCK 1 electr.unit + 1 set of trumpets	TRUCK 1 electr.unit + 1 set of trumpets							•
TA/4 906-C COD. 920394												CAR VAN 1 electr.unit + 1 set of trumpets	TRUCK 1 compressor + 1 set of trumpets	CAR VAN 1 electr.unit + 1 set of trumpets	TRUCK 1 electr.unit + 1 set of trumpets	CAR VAN TRUCK 1 electr.unit + 1 set of trumpets	TRUCK 1 electr.unit + 1 set of trumpets	✓
TA/4 NL-C+SPOILER COD. 920647				CAR VAN TRUCK 1 electr.unit + 1 set of trumpets														

PS10 System

Electronic priority emergency horn for continuous service, ensuring a powerful, clean sound. Systems equipped with a control unit with degree of protection IP67 and Loudspeaker IP 66. The PS10 system, thanks to its flexibility, complies with national standard requirements and can produce several sounds and is therefore easily customisable.

INTERNATIONAL Hi-Lo
AMERICAN SOUND Wail / Yelp
ITALY
FRANCE
NETHERLANDS
BELGIUM
UK
AUSTRIA
GERMANY
SWITZERLAND
LATIN AMERICA



12V / 24V

Loudspeaker



Sealed Connection



ELECTRONIC EMERGENCY HORNS

Voltage	Amp. Draw	Frequency	Option	Country	M O Q	Packaging	PS10		
							V	A	Hz
Flame retardant PBT								PS10	
12	3,5	L = 392	-	Italy	8	S			
24	1,75	H = 660	-	Italy	8	S			
12	3,5	L = 392	Wail/Yelp	Italy	8	S			
24	1,75	H = 523	Wail/Yelp	Italy	8	S			
12	3,5	L = 466	-	Italy	8	S			
24	1,75	H = 622	-	Italy	8	S			
12	3,5	L = 420	-	France	8	S			
24	1,75	H = 516	-	France	8	S			
12	3,5	L = 435	Day/Night	France	8	S			
24	1,75	H = 651	Day/Night	France	8	S			
12	3,5	-	Ambulance	France	8	S			
24	1,75	-	UMH Day/Night	France	8	S			
12	3,5	L = 435	-	France	8	S			
24	1,75	H = 732	-	France	8	S			
12	3,5	L = 435	Day/Night	France	8	S			
24	1,75	H = 580	Day/Night	France	8	S			
12	3,5	L = 435	-	France	8	S			
24	1,75	H = 488	-	France	8	S			
12	1,75	L = 435	-	France	8	S			
24	1,75	H = 488	-	France	8	S			
12	3,5	L = 375	Fast/Slow	Netherlands	8	S			
24	1,75	H = 500	Fast/Slow	Netherlands	8	S			
12	3,5	L = 360	Fast/Slow	Netherlands	8	S			
24	1,75	H = 480	Fast/Slow	Netherlands	8	S			

Type approval Reg. 10 / National homologation if required

Loudspeakers

PS10 System

ELECTRONIC EMERGENCY HORNS

	Voltage	Amp. Draw	Frequency	Option	Country	M O Q	Packaging
Flame retardant PBT							
PS10 🇧🇪							
PS10 - EMER-B COD. 951078	12 24	3,5 1,75	L = 440 H = 495	Day/Night	Belgium	8	S
PS10-SPO-B NIGHT COD. 951091	12 24	3,5 1,75	L = 440 H = 495	-	Belgium	8	S
PS10 🇬🇧							
PS10 - EMER-UK COD. 951035	12 24	3,5 1,75	L = 440 H = 495	-	United Kingdom	8	S
PS10 - EMER-WY-UK COD. 951034	12 24	3,5 1,75	L = 440 H = 495	Wail/Yelp	United Kingdom	8	S
PS10 🇦🇹							
PS10 - AMB-A COD. 951046	12 24	3,5 1,75	L = 450 H = 600	-	Austria	8	S
PS10 - FEUER-A COD. 951064	12 24	3,5 1,75	L = 392 H = 523	-	Austria	8	S
PS10 🇩🇪 🇨🇭							
PS10 - EMER-D COD. 951060	12 24	3,5 1,75	L = 430 H = 570	Stadt/Land	Germany Switzerland	8	S
PS10 🇺🇸							
PS10 - USSOUND COD. 951061 WAIL/YELP	12 24	3,5 1,75	L = 430 H = 570	-	Latin America	8	S
PS10 🇺🇸							
PS10 - USSOUND-WY COD. 951063 HI-LO	12 24	3,5 1,75	L = 560 H = 650	Wail/Yelp	International USA	8	S

Type approval Reg. 10 / National homologation if required

The PS10 system offers 7 different types of loudspeakers to permit the best installation suitable for different needs. There are loudspeakers in ferrite and neodymium, available in various dimensions for internal or external vehicle installation.

LOUDSPEAKERS



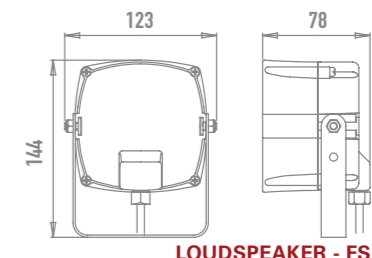
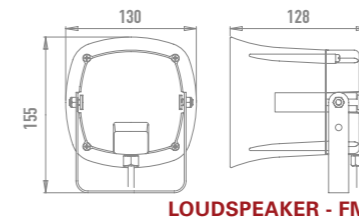
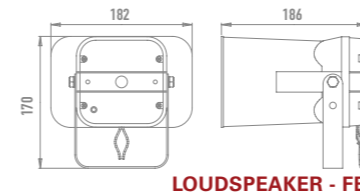
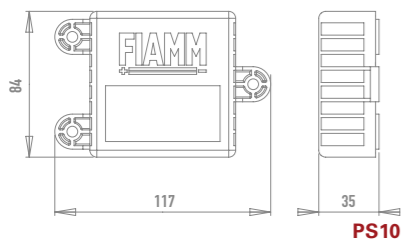

	Voltage	Decibel	Nominal power	Peak power	Impedance	M O Q	Packaging
ABS / Ferrite Magnet FB 🚚							
LOUDSPEAKER - FB COD. 951051	12 24	115	25	40	4	8	F12 Degree of protection: IP56
ABS / Ferrite Magnet FM 🚗 🚚 🚛							
LOUDSPEAKER - FM COD. 951052	12 24	114	25	40	4	8	G8 Degree of protection: IP66
ABS / Ferrite Magnet FS 🚗 🚚 🚛							
LOUDSPEAKER - FMW COD. 951077 UV PROTECTION	12 24	114	25	40	4	8	G8
LOUDSPEAKER - FS COD. 951053	12 24	113	25	40	4	8	G8 Degree of protection: IP56





Loudspeaker

LOUDSPEAKERS

	Voltage	Decibel	Nominal power	Peak power	Impedance	M O Q	Packaging						
								V	dB(A) 2m	W	W	Ohm	u.
ABS / Neodymium Magnet  LOUDSPEAKER -NB COD. 951054	12 24	117	50	70	4	8	F12 Degree of protection: IP66						
ABS / Neodymium Magnet  LOUDSPEAKER -NSC COD. 951055	12 24	113	20	30	4	8	G5 Degree of protection: IP66						
ABS / Neodymium Magnet  LOUDSPEAKER -NS COD. 951056	12 24	113	20	30	4	4	G9 Degree of protection: IP66						
ABS  CONNECTION CABLE PS10 COD. 951057					4	4	I9 Degree of protection: IP67						

NEODYMIUM MAGNET

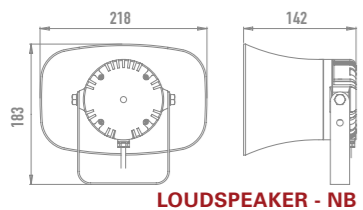

LOUDSPEAKER - NB

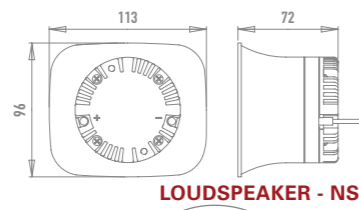

LOUDSPEAKER - NS

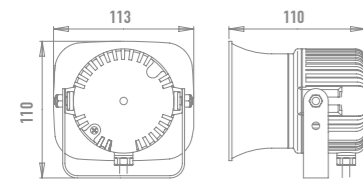

LOUDSPEAKER - NSC

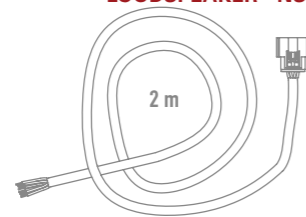

CONNECTION CABLE PS10



For the Italian market, special kits to integrate offers

ELECTRONIC EMERGENCY HORNS

	Voltage	Amp. Draw	Decibel	Country	M O Q	Packaging				
							V	A	dB(A) 2m	u.
PS10  PS10 - FB-AMB-POMP-I COD. 951009 KIT OF MODULE + 2 FB SPEAKER + CABLE	12 24	4 2	121	Italy	5	F6				
PS10 - NB-AMB-POMP-I COD. 951012 KIT OF MODULE + 2 NB SPEAKER + CABLE	12 24	4 2	123	Italy	5	F11				
PS10 - FM-AMB-POMP-I COD. 951019 KIT OF MODULE + 2 FM SPEAKER + CABLE	12 24	4 2	120	Italy	4	G6				
PS10 - FMW-AMB-I COD. 951022 KIT OF MODULE + 2 FMW SPEAKER + CABLE	12 24	4 2	120	Italy	4	G6				
PS10 - FS-AMB-POMP-I COD. 951010 KIT OF MODULE + 2 FS SPEAKER + CABLE	12 24	4 2	119	Italy	8	G7				
PS10 - NSC-AMB-POMP-I COD. 951011 KIT OF MODULE + 2 NSC SPEAKER + CABLE	12 24	4 2	119	Italy	8	F12				
PS10 - FB-POL-I COD. 951015 KIT OF MODULE + 2 FB SPEAKER + CABLE	12 24	4 2	121	Italy	5	F6				
PS10 - NB-POL-I COD. 951018 KIT OF MODULE + 2 NB SPEAKER + CABLE	12 24	4 2	123	Italy	5	F11				
PS10 - FM-POL-I COD. 951020 KIT OF MODULE + 2 FM SPEAKER + CABLE	12 24	4 2	120	Italy	4	G6				
PS10 - FS-POL-I COD. 951016 KIT OF MODULE + 2 FS SPEAKER + CABLE	12 24	4 2	119	Italy	8	G7				
PS10 - NSC-POL-I COD. 951017 KIT OF MODULE + 2 NSC SPEAKER + CABLE	12 24	4 2	119	Italy	8	F12				



KIT ITALIA

Type approval Reg. 10 / National homologation if required

MC4 System







High power, directional Electropneumatic emergency horn systems to be used as primary signals on temporary exit vehicles or as secondary signals to successfully overcome difficult traffic situations or for dangerous crossroads.

INTERNATIONAL Hi-Lo

- ITALY
- NETHERLANDS
- BELGIUM
- UK
- AUSTRIA
- GERMANY
- SWITZERLAND



COMPRESSORS

	Voltage	Amp. Draw	Country	Type approval	M O Q	Packaging
	V	A			u.	
Steel/Aluminium						
 MC4 FDS 12V + LUBRICATOR COD. 921084	12	17	Italy	National/ Reg.10	4	I11
MC4 FVA 12V + LUBRICATOR COD. 921077	12	17	Italy	National/ Reg.10	4	I11
MC4 FVA 24V + LUBRICATOR COD. 921078	24	8	Italy	National/ Reg.10	4	I11
 MC4 FALG 12V + LUBRICATOR COD. 921121	12	17	Netherlands	Reg. 10 ECE	4	I11
MC4 FALG 24V + LUBRICATOR COD. 921122	24	8	Netherlands	Reg. 10 ECE	4	I11
 MC4 FI 24V + LUBRICATOR COD. 921124	24	8	Belgium, UK International	Reg. 10 ECE	4	I11
 MC4 FI 12V + LUBRICATOR COD. 921123	12	17	UK International	Reg. 10 ECE	4	I11
 MC4 FD 12V + LUBRICATOR COD. 921116	12	17	Austria	Reg. 10 ECE	4	I11
MC4 FA 12V + LUBRICATOR COD. 921118	12	17	Austria	Reg. 10 ECE	4	I11
MC4 FA 24V + LUBRICATOR COD. 921119	24	8	Austria	Reg. 10 ECE	4	I11
 MC4 FD 12V + LUBRICATOR COD. 921116	12	17	Germany Switzerland	National/ Reg.10	4	I11
MC4 FD 24V + LUBRICATOR COD. 921117	24	8	Germany Switzerland	National/ Reg.10	4	I11

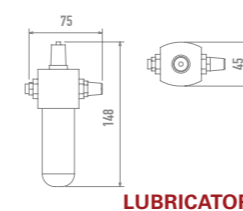
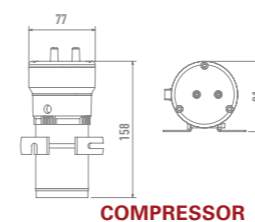

PS20 System

Through its powerful and directional sound, the priority system PS20 maximises security and sound localization of emergency vehicles. A pneumatic horn guided by an electronic module for continuous service, that guarantees a high duration.

INTERNATIONAL Hi-Lo

- ITALY
- BELGIUM
- UK
- AUSTRIA
- GERMANY
- SWITZERLAND
- SPAIN



ELECTRONIC EMERGENCY HORNS

Voltage	Amp. Draw	Compressed air source	Country	M O Q	Packaging	Icons	
						V	A
12	1,5	On-Board air system Dedicated compressor	Italy	4	14		
12	1,5	On-Board air system Dedicated compressor	Italy	4	14		
24	0,7	On-Board air system Dedicated compressor	Italy	4	14		
24	0,7	On-Board air system Dedicated compressor	Belgium, UK International Hi-Lo	4	14		
12	1,5	On-Board air system Dedicated compressor	UK International Hi-Lo	4	14		
12	1,5	On-Board air system Dedicated compressor	Germany Switzerland	4	14		
12	1,5	On-Board air system Dedicated compressor	Austria	4	14		
24	0,7	On-Board air system Dedicated compressor	Germany Switzerland	4	14		
12	1,5	Dedicated compressor	Austria	8	S		
24	0,7	Dedicated compressor	Austria	8	S		
24	0,7	On-Board air system	Austria	8	S		

Type approval **Reg. 10** / National homologation if required

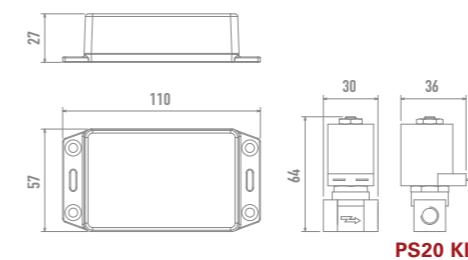











Trumpets









The trumpets on the MC4 and PS20 Systems, thanks to the chrome and coated versions, are easily installed both inside and outside vehicles. The frequency range covers various national standards. The 4-tone version offers maximum audibility and a pleasant sound.

Las bocinas de los sistemas prioritarios MC4 y PS20, disponibles en versión cromada y pintada, se instalan fácilmente tanto dentro como fuera del vehículo. La gama de frecuencias cubre las diferentes normativas nacionales. La versión de 4 tonos se caracteriza por máxima audibilidad y un sonido agradable.

TRUMPETS

	Decibel	Frequency	Country	H	M O Q	Packaging
	dB(A) 2m	Hz		mm	u.	
Metal						
						
TA SET OF 2 TRUMPETS						
 TA/2 906-V+SPOILER COD. 920392	117	L = 466 H = 622	Italy	286 210	8	H1
 TA/2 906-V+SPOILER COD. 920392	117	L = 466 H = 622	Austria	286 210	8	H1
 TA/2 906-V+SPOILER COD. 920392	117	L = 466 H = 622	Germany, Switzerland International	286 210	8	H1
 TA/2 906-C+SPOILER COD. 920393	117	L = 466 H = 622	Italy	286 210	8	H1
 TA/2 906-C+SPOILER COD. 920393	117	L = 466 H = 622	Austria	286 210	8	H1
 TA/2 906-C+SPOILER COD. 920393	117	L = 466 H = 622	Germany, Switzerland International	286 210	8	H1
 TA/2 VA-V+SPOILER COD. 920395	117	L = 392 H = 660	Italy	329 199	8	H1
 TA/2 GA-V COD. 920615	117	L = 494 H = 660	Netherlands	274 199	8	H1
 TA/2 GB-V COD. 920616	117	L = 440 H = 587	Netherlands	297 239	8	H1

TRUMPETS

	Decibel	Frequency	Country	H	M O Q	Packaging
	dB(A) 2m	Hz		mm	u.	
Metal						
TA SET OF 2 TRUMPETS						
 TA/4 NL-C+SPOILER COD. 920647 SET OF 4 TRUMPETS	117	L = 375 - 400 H = 485 - 500	Netherlands	275 - 283 374 - 389	3	F3
 TA/2 BL-C COD. 920629	117	L = 440 H = 494	Belgium	297 274	8	H1
 TA/2 BL-C COD. 920629	117	L = 440 H = 494	UK	297 274	8	H1
 TA/2 BL-V COD. 920396	117	L = 440 H = 494	Belgium	297 274	8	H1
 TA/2 BL-V COD. 920396	117	L = 440 H = 494	UK	297 274	8	H1
 TA/2 DE-B COD. 920397	117	L = 392 H = 523	Austria	329 262	8	H1
 TA/4 906-C+SPOILER COD. 920394	117	L = 435 - 450 H = 580 - 600	Germany, Switzerland International	297 - 289 223 - 214	4	H2
 TA/2 LE-V COD. 920400	117	L = 466 H = 544	Spain	286 251	8	H1
 SPOILER TA COD. 920618 ONLY SPOILER	-	-	All	-	8	S5

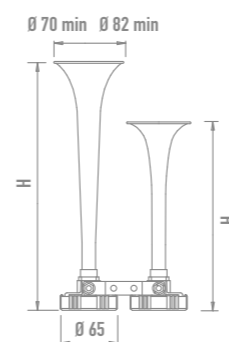

TA



Marine



FIAMM
+ -

VEGA line

Electromagnetic steel trumpets for excellent audibility at sea. Available in two-tones and pairs.

ELECTROMAGNETIC HORNS

		Voltage	Amp. Draw	Decibel	Frequency	M O Q	Packaging
		V	A	dB(A) 2m	Hz	u.	
Inox Steel	VEGA						
	VEGA 15 COD. 920333	12	6	117	370	6	F14
	VEGA 18 COD. 920334	12	6	117	310	6	F14
Inox Steel	VEGA DUAL						
	VEGA DUAL COD. 920335	12	12	120	L = 320 H = 370	6	F13
	VEGA DUAL COD. 920993	24	6	120	L = 320 H = 370	6	F13

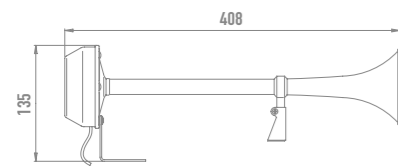

VEGA 15

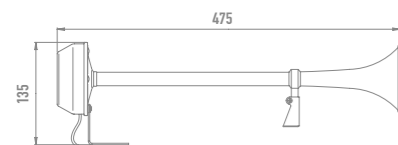

VEGA 18

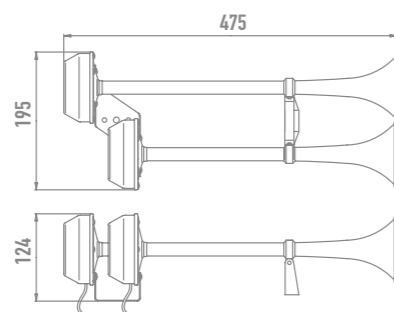

VEGA DUAL



MARINE HORN line

Small electromagnetic emergency horn for retractable installation. Available in 5 colours.

ELECTROMAGNETIC HORNS

		Voltage	Amp. Draw	Decibel	Frequency	M O Q	Packaging
		V	A	dB(A) 2m	Hz	u.	
Steel / ABS	MARINE HORN						
	MARINE HORN BLACK - 2T COD. 920314	12	4,5	112	405	9	I6
	MARINE HORN PANAMA - 2T COD. 920323	12	4,5	112	405	9	I6
	MARINE HORN WHITE - 2T COD. 932216Z	12	4,5	112	405	4	G9
	MARINE HORN STEEL - 2T COD. 932215Z	12	4,5	112	405	4	G9



MARINE HORN BLACK - 2T
COD. 920314



MARINE HORN PANAMA - 2T
COD. 920323



MARINE HORN WHITE - 2T
COD. 932216Z



MARINE HORN STEEL - 2T
COD. 932215Z

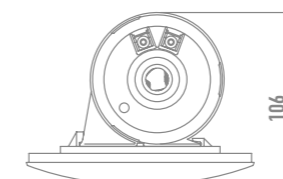
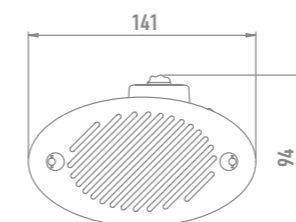

MARINE HORN





Miscellaneous



Accessories

FIAMM
+  -

Adapters

ADAPTERS WITH ORIGINAL EQUIPMENT CONNECTOR	Voltage	Suitable for	M O Q	Packaging
For 2 terminals connection	V		u.	
	-	IVECO / MERCEDES / OPEL RENAULT / VOLKSWAGEN	9	S2
	-	ALFAROMEO / FERRARI / FIATFORD HOLDEN / JAGUAR LANDROVER LANCIA / OPEL VAUXALL / VOLVO	9	S2
	-	ALFAROMEO / DACIA / FORD LANDROVER / MASERATI RENAULT / VOLVO	9	S2
	-	CITROEN / PEUGEOT	9	S2

Relays available in 12V version to complete the electrical circuit
See pag.60

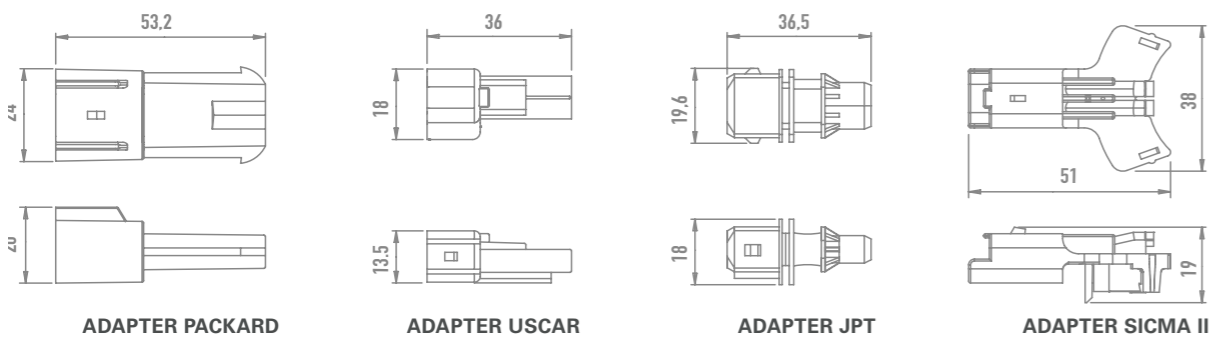

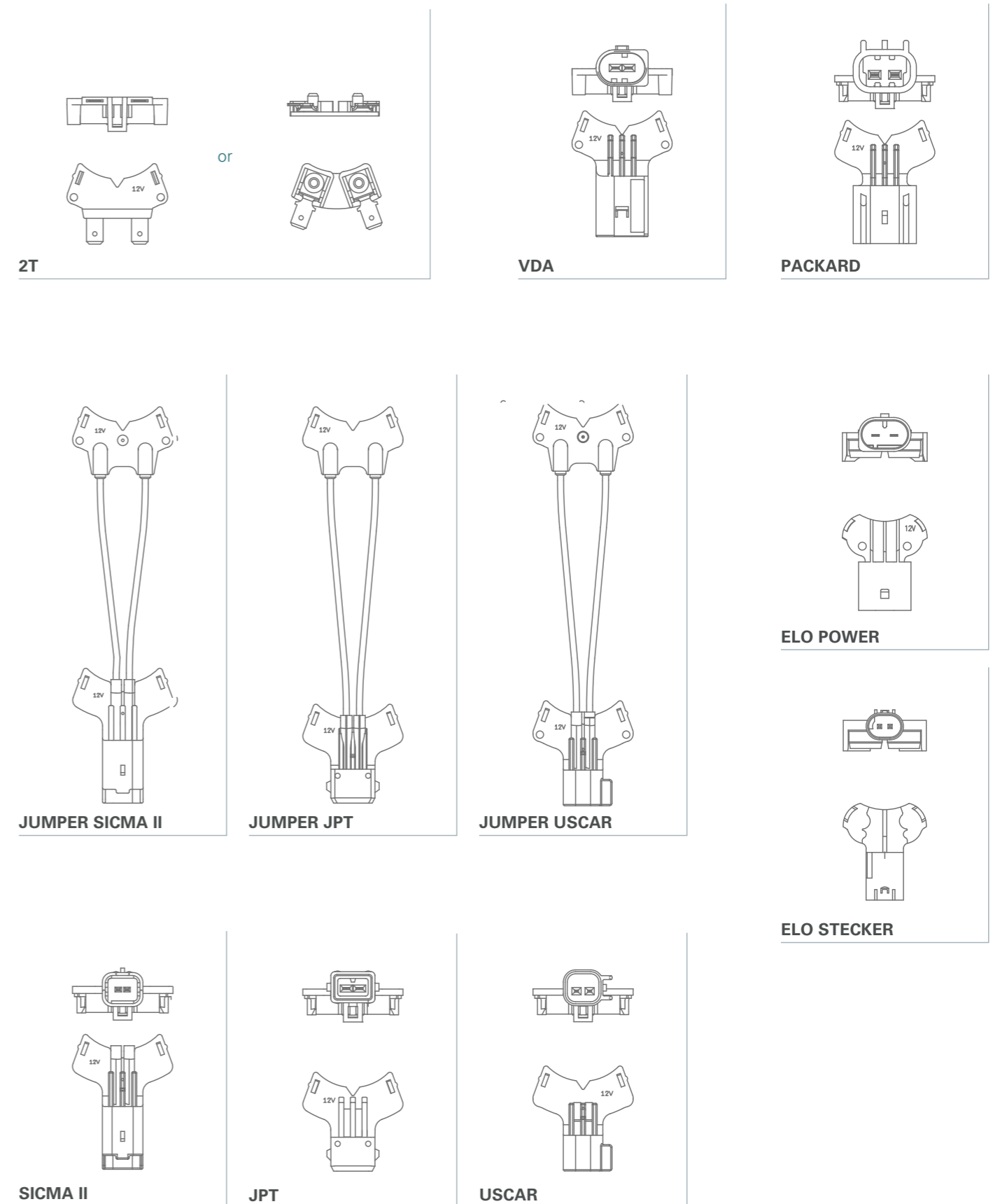

Connectors





M4 line / MC4 line / MC4+ line

New generation, more compact, more powerful and versatile compressors. Available models are possible, from the simplest version M4, to the more powerful compressor MC4+ for more challenging applications. The MC4+ can be also used with the lubricator.

COMPRESSORS		Voltage	Amp. Draw	Pressure	Air flow	M O Q	Packaging
		V	A	kPa		u.	
Steel/Aluminium 	M4 12V COD. 921988	12	17	1,2	80	4	I8
	M4 24V COD. 921989	24	8	1,2	80	4	I8
	MC4 12V COD. 921991	12	17	1,4	80	4	I9
	MC4 24V COD. 921992	24	8	1,4	80	4	I9
Steel/Aluminium 	MC4+ 12V COD. 921937	12	17	1,9	80	4	I10
	MC4+ 24V COD. 921938	24	8	1,9	80	4	I10

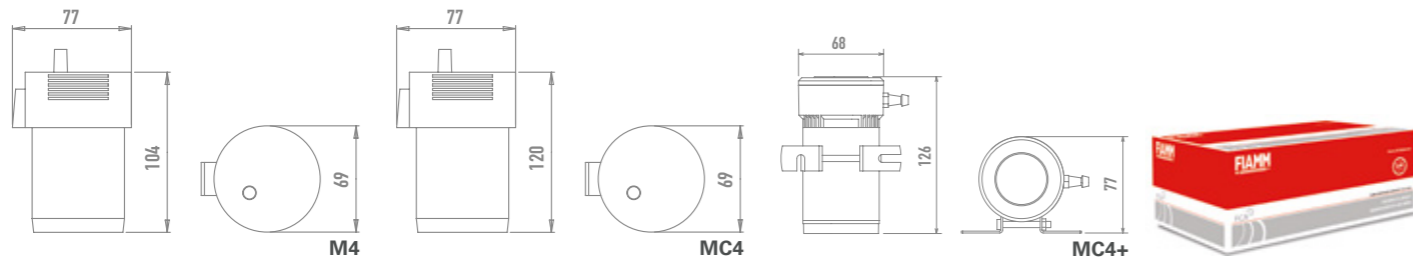

Type approval [Reg.28/Reg. 10 ECE](#)



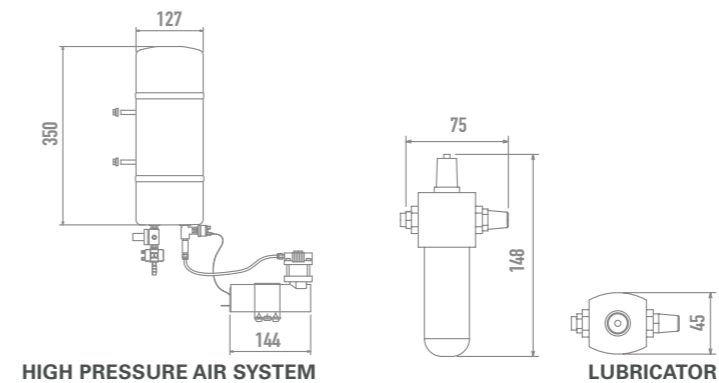

COMPRESSORS		Voltage	Amp. Draw	Pressure	Air flow	M O Q	Packaging
		V	A	kPa		u.	
	HIGH PRESSURE AIR SYSTEM COD. 921125	12	11	3	100	1	V
	Suitable for						
Plastic/Metal 	LUBRICATOR COD. 920617					8	S5
	Suitable for						









Accessories

Relay	Voltage	Suitable for	M O Q	Packaging
	RELAY 12V COD. 920960 5 PINS			
	RELAY 24V COD. 920961 5 PINS			

TRUMPETS	Decibel	Frequency	Pressure	Air consumption	M O Q	Packaging
	TA/O SHORT COD. 920358 PLASTIC - 1 PC					
	TA/2 COD. 920357 PLASTIC - KIT OF 2 PCS					

Type approval [Reg.28/Reg. 10 ECE](#)

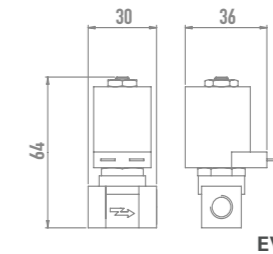
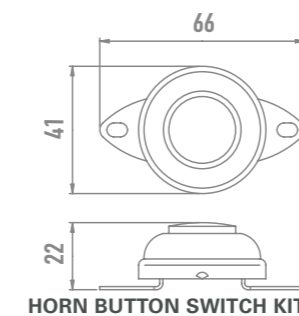
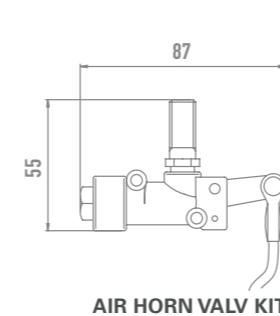
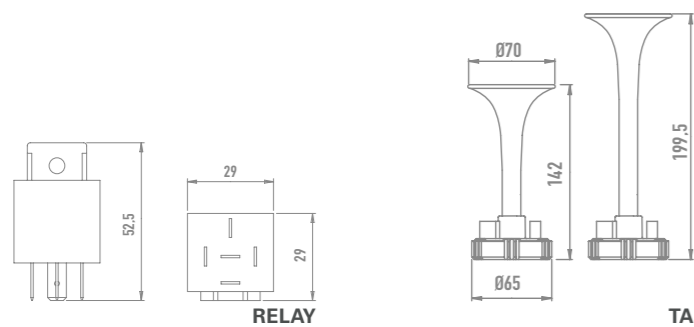

PNEUMATIC HORNS	Voltage	Amp. Draw	Pressure	Suitable for	M O Q	Packaging
						
	AIR HORN VALVE KIT COD. 920321	MANUAL	500 1200	TA180 TA150 FULTONE TC2 PV	9	S3
						
	HORN BUTTON SWITCH KIT COD. 920320	12 24		ELECTRIC HORNS	9	S3
						
	EV 12V - 2T COD. 920950	12	1,5	500 1200	8	A
	EV 24V - 2T COD. 920975	24	0,7	500 1200	8	A
EV 24V WITH FILTER - 2T COD. 921131	24	0,7	500 1200	8	A	

Type approval [Reg.28/Reg. 10 ECE](#)





NOVELTY line

Electropneumatic, retro style horns for a pleasant sound. Available versions from 3, 5 and 6 trumpets. They reproduce the most popular melodies taken from movies and music themes.

ELECTROPNEUMATIC HORNS	Voltage	Amp. Draw	Decibel	Frequency	M O Q	Packaging
	V	A	dB(A) 2m	Hz	u.	
Steel/Aluminium						
 CHARGE / LA CARICA COD. 921970 PLASTIC	12	17	116	-	5	C1
IL SORPASSO COD. 921977 PLASTIC	12	17	116	-	5	C1
Steel/Aluminium						
 IN THE SUMMERTIME COD. 921979 PLASTIC	12	17	116	-	5	C3
THE GODFATHER / IL PADRINO COD. 921976 PLASTIC	12	17	116	-	5	C3

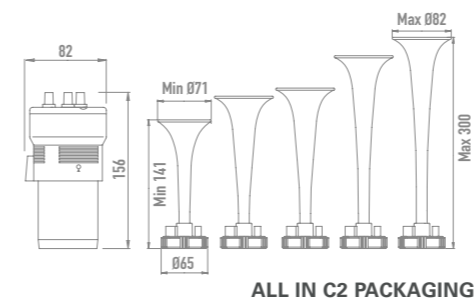
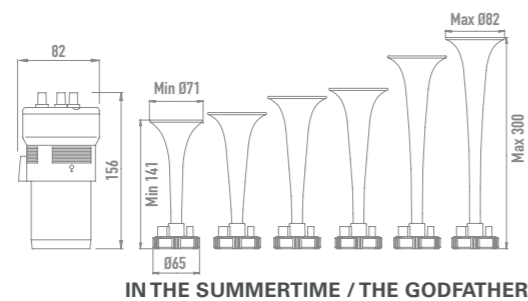
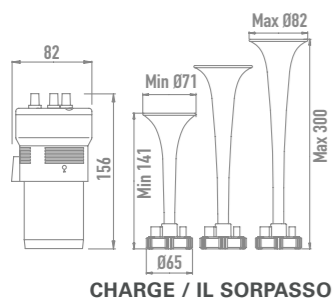
Type approval [Reg.28/Reg. 10 ECE](#)



ELECTROPNEUMATIC HORNS	Voltage	Amp. Draw	Decibel	Frequency	M O Q	Packaging
	V	A	dB(A) 2m	Hz	u.	
Steel/Aluminium						
 LA CUCARACHA COD. 921972 PLASTIC	12	17	116	-	5	C2
DIXIE LAND / DUKES OF HAZZARD COD. 921973 PLASTIC	12	17	116	-	5	C2
O' SOLE MIO COD. 921974 PLASTIC	12	17	116	-	5	C2
OH! SUSANNA COD. 921975 PLASTIC	12	17	116	-	5	C2
RIVER KWAI / LA MARCIA DEL PONTE COD. 921971 PLASTIC	12	17	116	-	5	C2
LA MARSIGLIESE / LA MARSEILLAISE COD. 921980 PLASTIC	12	17	116	-	5	C2
BRASIL COD. 921978 PLASTIC	12	17	116	-	5	C2

Type approval [Reg.28/Reg. 10 ECE](#)

GAS line

Emergency pressurised horn with non-flammable 134A propellant for safety at sea.

GAS HORNS

Gas volume	Decibel	Frequency	M O Q	Packaging
ml	dB(A) 2m	Hz	u.	

Aluminium/Plastic

TE 



TE/M
COD. 920293

300

116

590

20

T

Aluminium

REFILL 



REFILL TE/M
COD. 926043

300

-

-

48

T1

Not flammable, Not explosive, not oxidant

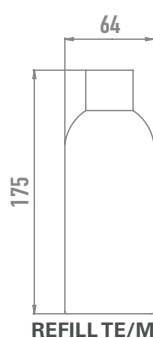
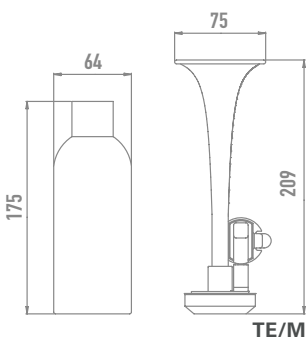

Packaging

Imballo

Reference	Packaging	Quantity for packaging	Master Carton dimensions	Quantity for Master Carton	M.C. Weight	Master Carton quantity on pallet
		no. of pieces	mm	no. of pieces	Kg	
A	BOX - 35x72x97	1	240x145x95	8	2	-
B1	BLISTER	1	450x510x310	10	14	-
B2	BLISTER	1	450x510x310	10	18	-
B3	BLISTER	1	450x510x310	10	11	-
C1	BLISTER	1	380x330x475	5	8	-
C2	BLISTER	1	460x385x455	5	9	-
C3	BLISTER	1	520x425x465	5	10	-
C4	BLISTER	1	502x427x225	12	10	-
F1	BULK	-	450x510x310	40	9	-
F2	BULK	-	450x510x310	40	4	-
F3	BOX - 135x200x480	1	520x450x265	3	6	-
F4	BOX - 135x200x480	1	520x450x265	3	6	-
F5	BOX - 135x200x480	1	520x450x265	3	3	-
F6	BOX - 220x310x150	1	500x325x400	5	18	-
F9	BOX - 135x200x480	1	450x520x265	3	7	-
F10	BOX - 110x135x480	1	450x520x265	6	10	-
F11	BOX - 220x310x150	1	500x325x400	5	12	-
F12	BOX - 185x220x150	1	500x325x400	8	12	-
F13	BOX - 135x200x480	1	450x520x265	3	6	-
F14	BOX - 110x135x480	1	450x520x265	6	6	-
F15	BOX - 220x310x150	1	500x325x400	5	5	-
F16	BOX - 110x135x480	1	450x520x265	6	5	-
F17	BOX - 110x135x480	1	450x520x265	6	3	-
F18	BOX - 185x220x150	1	500x325x400	8	17	-
G1	BOX - 113x194x80	2 H+L/L+L	400x300x300	16	10	-
G2	BOX - 82x90x105	1	300x200x200	9	3	-
G5	BOX - 142x180x146	1	400x300x300	8	6	-
G6	BOX - 144x385x146	1	400x300x300	4	13	-
G7	BOX - 142x180x146	1	400x300x300	8	22	-
G8	BOX - 142x180x146	1	400x300x300	8	10	-
G9	BOX - 83x126x192	1	300x200x200	4	2	-
H	BOX - 95x166x357	1	400x390x480	8	12	-
H1	BOX - 95x166x357	1	400x390x480	8	8	-
H2	2 BOX - 95x166x357	1	400x390x480	4	8	-
H3	BOX - 95x166x357	1	400x390x480	8	3	-

Packaging

Imballo

Reference	Packaging	Quantity for packaging	Master Carton dimensions	Quantity for Master Carton	M.C. Weight	Master Carton quantity on pallet
		no. of pieces	mm	no. of pieces	Kg	
I1	BOX - 82x90x105	1	300x200x200	9	3	-
I2	BOX - 82x90x105	1	300x200x200	9	2	-
I3	BOX - 83x126x192	1	400x300x200	9	5	-
I4	BOX - 113x194x80	1	300x200x200	4	4	-
I5	BOX - 83x126x192	2	400x300x200	9	4	-
I6	BOX - 83x126x192	1	400x300x200	9	4	-
I7	BOX - 82x90x105	1	300x200x200	9	1	-
I8	BOX - 113x194x80	1	245x210x180	4	3	-
I9	BOX - 113x194x80	1	245x210x180	4	4	-
I10	BOX - 113x194x80	1	245x210x180	4	5	-
I11	BOX - 113x194x80	1	245x210x180	4	7	-
I12	BOX - 82x90x105	1	300x200x200	9	3	60
I13	BOX - 82x90x105	2	300x200x200	9	3	60
I14	BOX - 93x190x85	2 H+L	400x300x200	12	7	40
I15	BOX - 82x90x105	1	400x300x200	22	7	40
I16	BOX - 93x190x85	2 H+L	400x300x200	12	8	40
I17	BOX - 82x90x105	1	300x200x200	9	3	60
I18	BOX - 93x190x85	2 H+L	400x300x200	12	7	40
I19	BOX - 113x194x80	1	300x200x200	4	2	-
L1	BOX - 93x190x85	2 H+L	610x470x230	30	16	20
M	BOX - 145x145x690	1	725x500x490	9	15	6
R	BOX - 130x220x152	1	600x400x300	13	10	15
S	BOX - 62x125x125	1	300x200x200	8	4	-
S2	BOX - 82x90x105	3	300x200x200	9	1	-
S3	BOX - 82x90x105	1	300x200x200	9	2	-
S4	BOX - 82x90x105	4	300x200x200	9	5	-
S5	BOX - 62x125x125	1	300x200x200	8	2	-
S6	BOX - 82x90x105	1	300x200x200	9	3	60
T	BLISTER	1	500x320x420	20	10	-
T1	BLISTER	1	500x320x420	48	19	-
U	BULK	-	300x200x200	240	6	-
V	BOX - 435x300x290	1	435x300x290	1	5	-

Reference	Thickness	Quantity for horn	Interaxis	Fastening diameter on vehicle
	mm		mm	
AM80S	2	1	70	M8
TR99	2	1	65	M8
HK9	1	2	65	M8
HK8	1	2	65	M8