

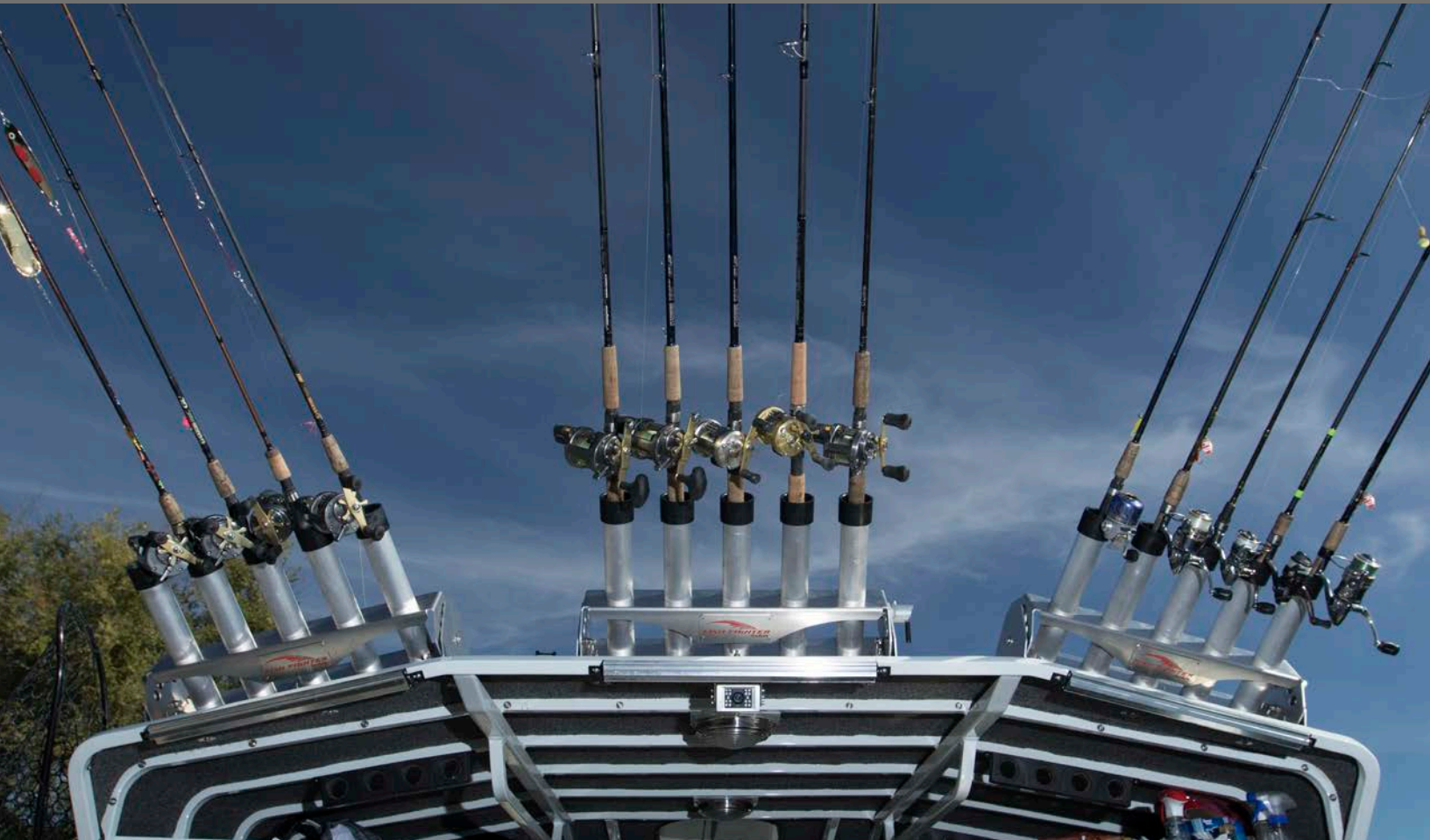

FISH FIGHTER[™]
Products

ROD
RACKS



WALL MOUNT ROD RACKS

PART #	DESCRIPTION	DIMENSIONS
ITD5107	Wall Mount Rod Rack (3)	11 3/4" X 5 1/2" X 2 1/2"
ITD1423	Wall Mount Rod Rack (6)	26" X 5 1/2" X 2 1/2"
ITD5108	Wall Mount Offshore Rod Rack (3)	15 1/4" X 8 1/2" X 2 1/2"
ITD1424	Wall Mount Offshore Rod Rack (6)	34 1/4" X 8 1/2" X 2 3/4"



ITD5107

It is up to the installer to determine the appropriate mounting hardware for chosen mounting location. Includes (4) #10 X 1" Drywall Anchors with each Wall Mount Rod Rack to allow mount to most walls or flat surfaces.



ITD1423

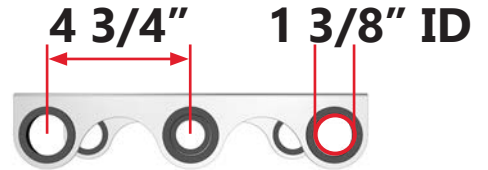

ITD5108

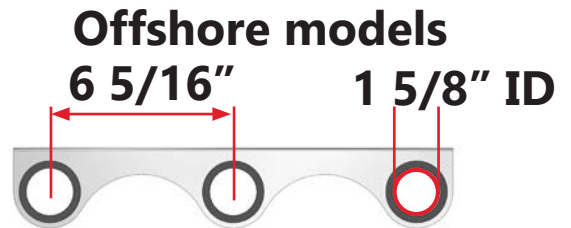

ITD1424

FIXED ANGLE "ROCKET LAUNCHER" ROD RACKS

PART #	DESCRIPTION	DIMENSIONS
ITD5287	Fixed Angle "Rocket Launcher" Rod Rack (3) Rod Model	12" X 10 7/8" X 10 9/16"
ITD5482	Fixed Angle "Rocket Launcher" Rod Rack (4) Rod Model	16" X 10 7/8" X 10 9/16"
ITD5405	Fixed Angle "Rocket Launcher" Rod Rack (5) Rod Model	20" X 10 7/8" X 10 9/16"



It is up to the installer to determine the appropriate mounting hardware for chosen mounting location.

Includes:

- (5) - 1/4" SS Stainless Washer Large 1" OD
- (10) - 1/4" SS Small Washer Small OD
- (5) - 1/4" - 20 X 1" SS Truss Head Screw
- (5) - 1/4" - 20 X 1 1/4" SS Truss Head Screw
- (5) - 1/4" - 20 SS Nylock Nut

with each Fixed Angle "Rocket Launcher" Rod Rack to allow mounting to flat surfaces.

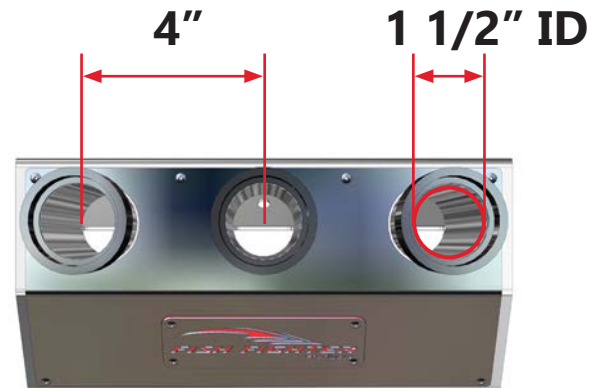

MULTI ANGLE "ROCKET LAUNCHER" ROD RACKS

PART #	DESCRIPTION	DIMENSIONS
ITD5283	Multi Angle "Rocket Launcher" Rod Rack (3) Rod Model	13 3/4" X 13 1/8" X 4"
ITD5279	Multi Angle "Rocket Launcher" Rod Rack (4) Rod Model	17 3/4" X 13 1/8" X 4"
ITD5485	Multi Angle "Rocket Launcher" Rod Rack (5) Rod Model	21 3/4" X 13 1/8" X 4"

ITD5283



It is up to the installer to determine the appropriate mounting hardware for chosen mounting location.

Includes:

- (6) - 1/4" SS Stainless Washer Large 1" OD
- (12) - 1/4" SS Small Washer Small OD
- (6) - 1/4" - 20 X 1" SS Truss Head Screw
- (6) - 1/4" - 20 X 1 1/4" SS Truss Head Screw
- (6) - 1/4" - 20 SS Nylock Nut

with each Multi Angle "Rocket Launcher" Rod Rack to allow mounting to flat surfaces.

ITD5279



115° Range of Motion



Loosen and tighten bolts to adjust the wide range of positions allowing installation about anywhere.

ITD5485

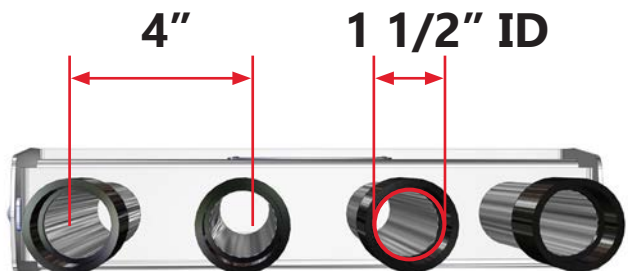

PIVOTING "ROCKET LAUNCHER" ROD RACKS

PART #	DESCRIPTION	DIMENSIONS
ITD5275	Pivoting "Rocket Launcher" Rod Rack (3) Rod Model	16 1/16" X 13 3/16" X 6"
ITD5271	Pivoting "Rocket Launcher" Rod Rack (4) Rod Model	20 1/16" X 13 3/16" X 6"
ITD5396	Pivoting "Rocket Launcher" Rod Rack (5) Rod Model	24 1/16" X 13 3/16" X 6"

ITD5275



It is up to the installer to determine the appropriate mounting hardware for chosen mounting location.

Includes:

- (6) - 1/4" SS Stainless Washer Large 1" OD
- (12) - 1/4" SS Small Washer Small OD
- (6) - 1/4" - 20 X 1" SS Truss Head Screw
- (6) - 1/4" - 20 X 1 1/4" SS Truss Head Screw
- (6) - 1/4" - 20 SS Nylock Nut

with each Pivoting "Rocket Launcher" Rod Rack to allow mounting to flat surfaces.

ITD5271



Four Positions

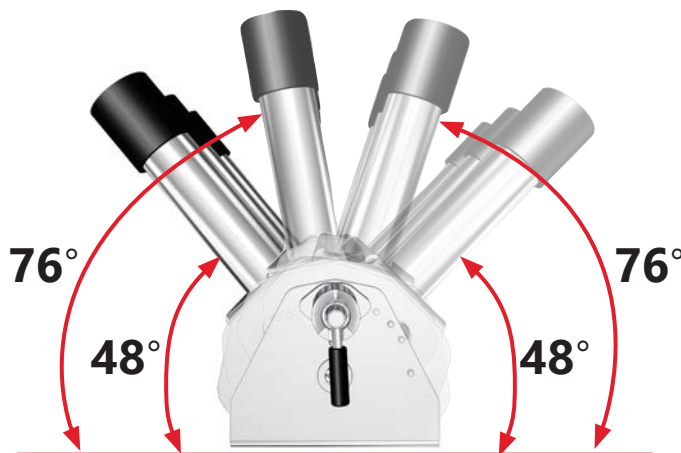

Disengage Speed Lock™ to move to any of the four angle positions. See complete Speed Lock™ instructions on PG 5.

ITD5396

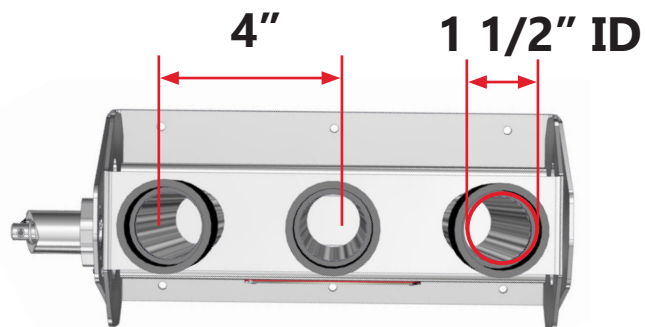

SPEED LOCK™

PART #	DESCRIPTION
ITD7291	Speed Lock™ (Only installed on Pivoting "Rocket Launcher" Rod Racks, Part #'s: ITD5275, ITD5271, ITD5396)



ITD7291

Fish Fighter™ Products recommends to grease the Speed Lock™ at least one pump a year or as needed.

**DISENGAGED
POSITION**

**ENGAGED
POSITION**

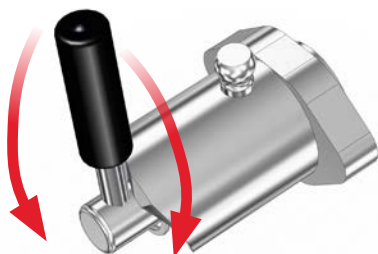

WALL MOUNT ROD RACKS

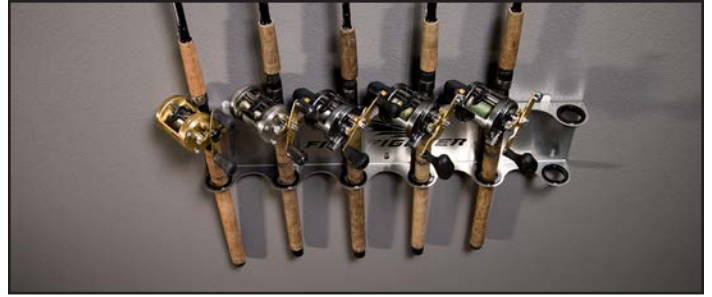

FIXED ANGLE "ROCKET LAUNCHER" ROD RACKS



MULTI ANGLE "ROCKET LAUNCHER" ROD RACKS



PIVOTING "ROCKET LAUNCHER" ROD RACKS

