



*Marelon® Composite Plumbing*



*Boat Care Products*



*Davits and Cranes*



*LeisureFurl In-Boom Furling*

# **FORESPAR®**

**SAILBOAT & POWER BOAT EQUIPMENT**  
**MARINE PRODUCTS THAT PERFORM SINCE 1966**

- **Product Info and Specs** • **How to Use** • **How to Maintain**

Have a look at the Knowledge section of our site and check the **Gold Information Tabs** below the product info on our site pages. All of the information you need is in one convenient place. We believe the more you know about your equipment and systems, the more you'll enjoy your boating experience.

Made by boaters for boaters. Designed to help make your boating easier, safer, faster and a lot more fun.

The Forespar Team

**For Direct Product Page Access**  
Look For These Icons Throughout The Catalog

## Build Your Knowledge With These Online Tools:

- **Tech Tips** – Learn from experienced boaters about your specific equipment
- **How-to Videos** – View professional videos to expand your and your crew's knowledge & skills
- **Installation Instructions** – Install your equipment properly and safely
- **Usage Tips** – Get the best use and enjoyment out of your equipment
- **Maintenance Tips** – Extend the life of your equipment for trouble-free operation

Sample Tech Tip Page

### VERTICAL POLE STORAGE

Storing poles (whisker or spinnaker) vertically up the forward face of the mast has become very popular. It clears the decks and keeps the cruising sailor from having to lift the entire weight of the pole from the deck to the mast car. It can, however, cause a few problems or failures if not used with the correct components.

Selection of the proper mast car and inboard end fitting combination is critical. Ring style cars (ours or anyone else's) will not allow a pole to hang vertically without binding and eventually breaking the end fitting. Bear in mind that you have a significant "lever arm" effect on the end. A 10-foot pole can create enough leverage to fracture or bend ends and rings if they bind up without you ever feeling it from the opposite end of the pole. Therefore, Forespar® does not recommend ANY ring style mast cars if the pole is to be stored up the mast.

If using lach style ends (LUX® & LUTK Ultra ends or older "XR", "TR" & "TL" aluminum ends) the FC-125 (#232000) Range style car (this page) is designed to allow up to a 4-1/2" diameter pole to hang vertically without binding up. The Toggle style cars will also allow mast storage with the "offshore" style "TS" & "UTS" style ends.

To aid in vertical pole storage, Forespar® has designed the "VPC" (this page) vertical pole storage cars in 2-1/2" to 4" sizes. These cars are designed to attach to the FC-125 or toggle style cars with a short "tail" (line or wire) and run in tandem up and down the track. When the pole is in use, they hang below the mast car and out of the way. Most importantly, when the pole is raised to the vertical storage position, the VPC car is rolled up the track and engages the pole near the top. This not only keeps the pole on the centerline (important with toggle cars) but also dampens the poles movement when at anchor. When used with the appropriate deck chock, (also on the mast) the pole can safely be stored up the mast and sheets will not foul on the outboard pole end that is captured by the deck chock on the mast. It is important that all components are on the mast so that the stored pole comes as close to parallel to the mast as possible.

If storage of the pole up the mast is your choice, we also strongly recommend securely mounted deck chocks be available for severe weather. It is advisable to remove poles from the mast and store them on deck in storm conditions. This removes the weight and windage aloft and keeps the poles available for an emergency should your rig be carried away.

If vertical pole storage is not desirable, Forespar® offers stanchion chocks and standard deck chocks for pole storage as well.

Part numbers:  
 335100 VPC-125-250 for 2-1/2" poles  
 335101 VPC-125-300 for 3" poles  
 335102 VPC-125-350 for 3-1/2" poles  
 335103 VPC-125-400 for 4" poles

All poles that are to be vertically stored on the mast cannot use "ring" style mast cars of any kind.



P9

# FORESPAR®

MARINE PRODUCTS THAT PERFORM

Fellow Boaters,

As boaters ourselves, we understand the passion you bring to the water every time you step onboard your boat. We strive to create practical and exciting products based on our own on-water experience and continue to create new offerings as well as the category leading boating products we are known for. From hardware to maintenance products, they are all designed and built to make sure your precious boating time is spent enjoying the water.

As we go to press, we are proud to present numerous new products specifically designed for boaters. To name a few, our new LED mast lights now offer the energy conservation of LED lighting in our time-tested light designs. For economical and efficient downwind sailing, take a look at our popular new adjustable length TriReacher downwind pole. And for those who need an easy way to store a dinghy, our new Quik Davit is a compact and smartly styled mounting system that allows your dinghy to be quickly connected and tilted out of the water onto your swim platform or transom. Our very popular LeisureFurl boom systems have also been updated with the addition of carbon fiber and electric power options.

We have also expanded our line of boat care products with several new offerings. The new MareLube REACH valve lubrication kit allows you to easily and properly lubricate your seacocks and valves. We have also developed a great new line of tea tree oil based odor control products called Tea Tree Power that has received very positive reviews.

Of course we have also added several new products to our ever expanding Marelon composite plumbing parts line. Truly the modern solution to marine plumbing, Marelon products offer corrosion free fittings that are becoming the standard for all marine plumbing systems.

There is a lot of useful information there to help you find and use the exact equipment needed for your boat.

Sincerely,

Scott Foresman  
CEO



Photo by Billy Black

## TABLE OF CONTENTS

ALUMINUM TUBING.....	13
ANCHORAGE STABILIZER -ROLL-X.....	22
AWNING POLES.....	9
BOOM VANGS.....	14
BOW SPRITS.....	22
CHOCKS, LINE.....	17
CLEATS.....	17
DAVITS - NOVA DAVIT™.....	26
EXIT BOX.....	17
HOYT JIB BOOM™ SYSTEM.....	22
JIB ROLLERS-SAIL SAVER.....	26
LIGHTNING MASTER™ (STATIC DISSIPATER).....	15
LANOCOTE® <b>NEW</b> .....	17
LABEL SETS.....	23
LEISURE FURL™.....	28-30
LIFTS - NOVA LIFT™, MOTOR MATE™.....	25-26
LIGHTS, MAST & LIGHT GUARD <b>NEW</b> .....	15
LIGHTS, PERSONAL RESCUE.....	21
MARELUBE™ LUBRICANTS <b>NEW</b> .....	32-33
MAST CARS <b>NEW</b> .....	12
MOB POLES & HOLDERS.....	20-21
PLUMBING PARTS - MARELON®.....	35-50
BALL VALVES.....	37
BULKHEAD FITTINGS <b>NEW</b> .....	41
DECK FILLS.....	48
DRAINS.....	48-49
DRAIN PLUGS.....	48
ELBOWS.....	39
FLANGE SEACOCKS.....	37
FLOWTECH™ PERFORMANCE VALVES.....	49
HOSE CONNECTORS <b>NEW</b> .....	39
INTEGRATED SYSTEMS.....	44-47
SINK WASTES.....	48
ROV VALVES.....	41
TANK VENTS.....	48
THRU-HULL CONNECTORS.....	38
VENTED LOOPS.....	40
WATER STRAINERS <b>NEW</b> .....	50
Y-VALVES.....	40
POLE ADAPTING COLLARS.....	13
POLE CHOCKS.....	13
POLE END FITTINGS.....	10-11
POLE MAST FITTINGS.....	11
QUIK DAVIT® <b>NEW</b> .....	27
RAILFAST® HARDWARE.....	24
REACHING STRUTS.....	9
REPLACEMENT PARTS.....	51
REFRESH DEODORIZERS <b>NEW</b> .....	34
REPLACEMENT MASTS & BOOMS.....	31
ROLL-X FLOPPER STOPPER.....	22
SAFETY EQUIPMENT.....	20-21
SHACKLE GUARDS.....	16
SPINNAKER POLES.....	5-8
STA-PLUG.....	21
STEERING CONTROL ARM.....	23
STROBE LIGHTS.....	21
T-TRACK.....	11
TABLE PEDESTAL SYSTEM.....	25
TEA TREE POWER® <b>NEW</b> .....	34
TEF 45™.....	33
TILLER EXTENSIONS.....	18-19
TILLER LOCK-BOX.....	19
TRACK STOPS.....	11
TURNBUCKLE COVERS.....	16
WHISKER POLES <b>NEW</b> .....	2-4
WHISKER POLE LOCK REPAIR KITS.....	3
WINCH, MARELON®.....	23

# WHISKER POLES



Whisker poles are used for non-spinnaker class racing and short-handed cruising, or whenever downwind performance is desired without the use of conventional spinnakers. A properly sized and deployed whisker pole will allow the headsail to add considerable power and speed to downwind sailing. Telescoping whisker poles allow one pole to be used with furling headsails or multiple sized jibs and genoas on a given boat.



*"It is the most important add-on I have on Quetzal, really. I can't imagine sailing downwind without my whisker pole". I make offshore passages for a living and I count on my Forespar® whisker pole. It's an aluminum and carbon, telescoping model that gives me great flexibility when poling out my headsail. The pole is robust, well engineered and easy to set. When the wind pipes-up I'm able to keep sailing on a deep reach and if it builds more I simply furl the sail, adjust the pole length and keep blasting along.*

**John Kretschmer**  
Professional Passagemaker  
Sailing Writer

By projecting the headsail out to weather and out of the mainsail's "wind shadow", the headsail can fill and stabilize. Without a whisker pole, the headsail will flop from side to side, limp and useless. The use of a whisker pole will allow "wing on wing" sailing dead downwind with surprising performance. In recent years, asymmetrical spinnakers have become "all the rage" in off-the-wind sailing. These sails are subject to the same dynamics as jibs or genoas as you turn closer to dead down wind or try to sail "deep".

The use of a whisker pole to hold out the clew of the asymmetrical sail will stabilize the sail in the same way as a conventional headsail.

WHISKER POLES

## Forespar Line Control Poles Are Easy As 1 - 2 - 3 (see pg 4)

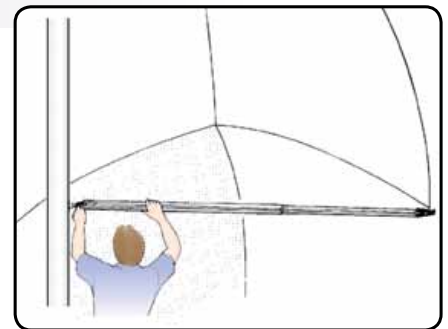
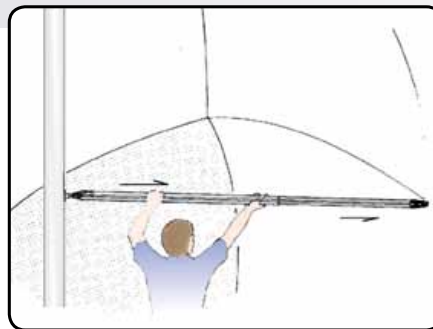
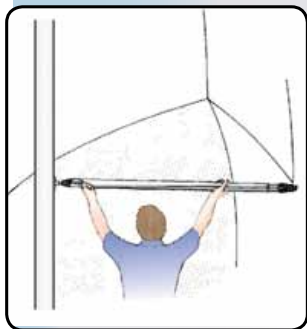

- 1** *Un-cleat the Line.*
- 2** *Pull Line out to extend the pole.*
- 3** *Re-cleat the Line.*

## WHISKER POLE SIZE RECOMMENDATIONS

### WORKING JIB

Boat Length:	Light to Mod. Air	Mod. to Heavy Air
Up to 16 ft.	ADJ 4'-8'	ADJ 6'-12'
Up to 22 ft.	ADJ 6'-12'	HD 6'-12'
Up to 25 ft.	HD 6'-12'	HD 6'-12'
Up to 28 ft.	ADJ 7'-15'	ADJ 7'-15'
Up to 33 ft.	LC 10'-18'	LC 10'-18'
Up to 35 ft.	LC 12'-22'	LC 12'-22'
Up to 46 ft.	LC 13'-24'	LC 13'-24'
Up to 50 ft.	LC 15'-27'	LC 15'-27'
50ft and Over	Please contact Forespar for advise on ordering pole of this size	

### GENOA

Light to Mod. Air	Mod. to Heavy Air
ADJ 6'-12'	HD 6'-12'
HD 6'-12'	LC 8'-14'
ADJ 7'-15'	ADJ 7'-15'
ADJ 7'-15'	LC 10'-18'
LC 10'-18'	LC 12'-22'
LC 12'-22'	LC 13'-24'
LC 13'-24'	LC 15'-27'
LC 15'-27'	Carbon Fiber Custom Poles
	Carbon Fiber Custom Poles

**For Replacement Whisker Pole Parts See Page 51**

# TWIST LOCK WHISKER POLES

## FOR BOATS 16 TO 30 FEET

### SMALL TELESCOPING POLES (TWIST LOCK)

Telescoping models can be adjusted to any desired length and securely locked in position with an effortless twist of the inner tube. All small poles include strong corrosion-free Lexan end fittings and a Mast Pad Eye with stainless steel screws.

**ADJ DL Style**



ADJ #-# DL models in chart have latch fittings on both ends

404100 Shown

Outboard End

**ADJ Style**



(ADJ #-# models in chart have spike on one end)

#404000 Shown

Part No.	Model No.	Size/Weight
404000	ADJ 4-8	Telescopes from 53" to 93"/3 lbs. 1" outer diameter
404100	ADJ 4-8 DL	Double Latch - latch fittings on both ends
406000	ADJ 6-12	Telescopes from 72" to 134"/3 lbs. 1- 1/4" outer diameter
406100	ADJ 6-12 DL	Double Latch - latch fittings on both ends
404011	PE-1	Pad Eye Only
300026	ADJ 4-8	End kit
300027	ADJ 6-12	End kit

### HEAVY DUTY TELESCOPING POLES (TWIST LOCK)

These telescoping whisker poles are heavy duty two section and three section aluminum spars which can be extended to lengths up to 15' and securely locked in position by an internal twist lock device. Poles feature self-latching Ultra Series™ fittings on the inboard and outboard ends. Mast Pad Eyes (PE-3SF or PE-3SC - Page 11) are recommended.

Inboard Ends



Outboard Ends

Part No.	Model No.	Size/Weight
406300	HD 6-12-DL	Two sections extending from 79" to 138", 1-7/8" outer tube diameter. With self-latching fittings on both ends/8 lbs.
407101	ADJ 7-15-DL	Three sections extending from 83" to 169", 2 in. outer tube diameter. With self-latching fittings on both ends/8 lbs.
304015 UEF-3	HD 6-12 DL	Special - inboard (big) end only
304018 UEF-5	HD 6-12 DL	Outboard end only (small)
304057 UEF-3	ADJ 7-15 DL	Inboard (big) end only
304018 UEF-5	ADJ 7-15-DL	Outboard end only (small).

### TWIST-LOCK REPAIR KITS\*

To recondition any of our twist-lock telescoping poles, we offer lock repair kits. Complete instructions and all necessary parts are provided.



Part No.	Lock for:
400006	TAP's & ADJ 4-8's
400007	BHT's & TAP HD's
400008	ADJ 6-12
400009	HD 6-12
400010	ADJ 7-15 (Two-lock set)



TWIST LOCK WHISKER POLES

# LINE CONTROL WHISKER POLES

FOR BOATS 20 TO 55 FEET

## LINE CONTROL™ WHISKER POLES

Line Control™ is a proven concept in telescoping whisker pole design. So unique, that full patent protection has been secured. Line Control™ is only available on Forespar® whisker poles. See the chart below for pole lengths and tube sizes. The system is simple, and makes the extension and retraction of poles quick and easy. And most amazing of all...the entire operation can be executed while being positioned at the mast. It is no longer necessary to go forward to adjust buttons of any kind - simply unclasp the line and extend or retract (never attempt to adjust while under load). It's quick and easy even with the largest poles. Topping lift attachment points are on all poles. Attachment to outer end is with end fittings jaw facing down.



## “COMBO” LINE CONTROL™ WHISKER POLES 50/50 CARBON/ALUMINUM

These Line Control™ Whisker poles offer just the right blend of aluminum and carbon structures to provide the racing or cruising sailor an affordable lightweight pole option. They have the strength and weight savings of carbon on the inner tube and the abrasion resistance, durability and cost savings of aluminum on the outer tube. They also feature Forespar's exclusive “Ultra” end fittings (UTS socket inboard and UTR trigger outboard) for further weight reduction and ease of maintenance.



WHISKER POLES

### LINE CONTROL WHISKER POLE MODELS, SPECS & FITTINGS

Part No.	Model No.	End Fittings		Recommended Mast Fittings	Collapsed Length / Weight	Max. Working Length	Tubing Diameters
		Inboard	Outboard				
401106	LC 10-18 EL-UXP	EL	UXP	PE-3SC, RC-125, FC-125	121.75"/17 lbs.	218.13"	2" & 2-1/2"
401107	LC 10-18 EL-UTR	EL	UTR	PE-3SC, RC-125, FC-125	121.75"/17 lbs.	218.13"	2" & 2-1/2"
402200	LC 12-22 UXP-UTR	UXP	UTR	RC-125, FC-125	148.50"/27 lbs.	265.25"	2-1/2" & 3"
402201	LC 12-22 UTS-UTR	UTS	UTR	T-125-S	148.50"/28 lbs.	265.25"	2-1/2" & 3"
800802	LC 12-22 UTS-UTR-CF	UTS	UTR	T-125-S	148.50"/19 lbs.	265.25"	2-1/2" & 3"
402203	LC 12-22 COMBO	UTS	UTR	T-125-S	148.50"/24 lbs.	265.25"	2-1/2" & 3"
403200	LC 13-24 UXP-UXP	UXP	UXP	RC-125, FC-125	162.00"/38 lbs.	272.00"	3" & 3-1/2"
403202	LC 13-24 UTS-UTR	UTS	UTR	T-125-S	162.00"/39 lbs.	272.00"	3" & 3-1/2"
800800	LC 13-24 UTS-UTR-CF	UTS	UTR	T-125-S	162.00"/24 lbs.	272.00"	3" & 3-1/2"
403203	LC 13-24 COMBO	UTS	UTR	T-125-S	162.00"/34 lbs.	272.00"	3" & 3-1/2"
405200	LC 15-27 UTS-UXP	UTS	UXP	T-125-S	182.00"/58 lbs.	324.00"	3-1/2" & 4"
405201	LC 15-27 UTS-UTR	UTS	UTR	T-125-S	182.00"/58 lbs.	324.00"	3-1/2" & 4"
800801	LC 15-27 UTS-UTR-CF	UTS	UTR	T-125-S	182.00"/32 lbs.	324.00"	3-1/2" & 4"
405203	LC 15-27 COMBO	UTS	UTR	T-125-S	182.00"/42 lbs.	324.00"	3-1/2" & 4"

\*When selecting accessories for your pole, be sure to match the accessory size to the corresponding pole size.

## TRI-REACHER™ WHISKER POLE NEW

For boats 35'-42' loa. The new Tri-Reacher™ whisker pole is an adjustable length pole developed specifically for use with Aysmmetrical/Gennaker sails. Use of this 3-part telescoping whisker pole with these sails will allow deeper sailing angles and eliminate the need for constant jibing downwind. Collapses to 8' and extends to 21'. Ships UPS wt. 22 lbs

### Part No. Description

408200	Tri-Reacher w/ UTS - UXP ends
332025	Fixed Mast TS Toggle for #408200
408201	Tri-Reacher w/ UXP - UXP ends
333025	Fixed Mast FC Flange for #408201

(see pg 12 for mast toggle and flange info)



3" Dia.

2 7/8" Dia.

2 1/2" Dia.

# SPINNAKER POLES

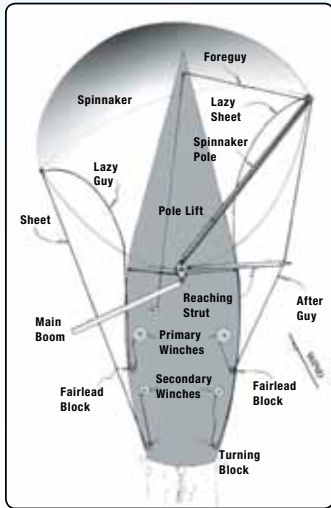

We offer a complete and diversified line of spinnaker poles. We manufacture eight complete end styles from which we create a multitude of combinations to fit the needs of all sailors - racers - cruiser.

## CUSTOM POLES

Our “customized” poles are built to specific dimensions. End fittings and tubing are available separately for those who wish to assemble poles to their own specifications.

Conventional Spinnaker Set-Up  
Varies by Boat Model,  
Size and Sail Type



## DETERMINING POLE LENGTH

The length of your spinnaker pole is determined by the yacht’s “J” measurement. This is the straight line distance from the front of the mast at deck level to the headstay. The “J” measurement is available from your sailplan, or contact **Forespar®** and we will be able to assist you in determining the proper length.

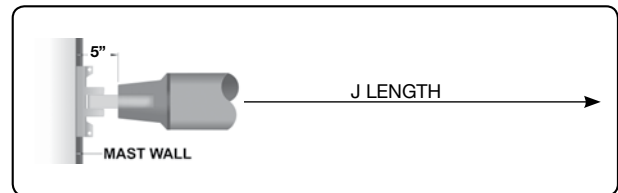

**NOTE:** For poles with our TS & UTS end fittings and using a Forespar T-125-S CAR, 5” is subtracted when given a “J” dimensions to establish pole length.

## RETRACTABLE BRIDLE OPTION

For custom spinnaker poles 3” in diameter or larger only. Featuring internal outboard-end trip lines, and a retractable topping lift, this rigging allows the sailor to smoothly complete a spinnaker jibe without detaching the pole from the mast.

Part No.	Description
300032	Retractable Bridle Option

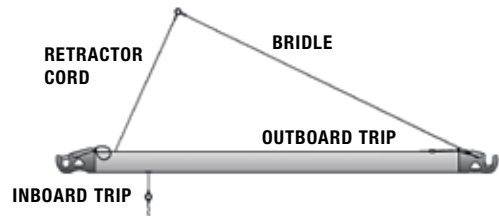

## HOW TO ORDER YOUR SPINNAKER POLE

Because there are a variety of options to choose from in ordering a spinnaker pole we need the person ordering the pole to fill out an order form detailing exactly how to build the pole and what features should be built in. There are 2 distinct forms, one for an aluminum pole and one for a carbon pole. Each is easy to fill in but lets us know what kind of boat the pole will be used on, what color paint (if any), what type of end fittings and many more choices.

# SPINNAKER POLES

## SMALL BOAT SPINNAKER POLE KITS

Each kit includes anodized aluminum tubing. One end is loose so you can cut tubing to desired over-all length and then fasten end fitting with epoxy supplied. Less than 10 minutes to complete. Mini 6'/7' kits include nylon latching end fittings, nylon lanyard, pad eye and epoxy kit.



Part No.	Model No.	Size/Weight
303600	Mini-6	1" dia.-6' Kit/4 lbs.
303700	Mini-7	1-1/4" dia.-7' Kit/4.5 lbs.

## STANDARD SPINNAKER POLES

Our Standard Spinnaker Poles have a double bridle topping lift/foreguy system. Unless otherwise specified, all standard poles are supplied with the throat (jaw) facing upward. See price page for information regarding charges for special tubing.

(Requires a Forespar® T-125-S or AT-150-S Toggle Car - See Page 12)

Part No.	Model Number	Shipping Weight	Max Length (w/ends)	Description
304100	UXP-150-UXP	6 lbs.	7'-8"	ULTRA UXP fitting both ends.
304101	UXP-200-UXP	10 lbs.	9'-6"	ULTRA UXP fitting both ends.
304102	UXP-200-UTR	11 lbs.		ULTRA Trigger one end/ULTRA Piston other.
304103	UTR-200-UTR	11 lbs.	2" Dia.	ULTRA Trigger fitting both ends.
304104	UXP-250-UXP	14 lbs.	11'-6"	ULTRA UXP fitting both ends.
304105	UTR-250-UXP	15 lbs.		ULTRA Trigger one end/ULTRA Piston other.
304106	UTR-250-UTR	15 lbs.	2 1/2" Dia.	ULTRA Trigger fitting both ends.
304107	UXP-300-UXP	18 lbs.	13'-6"	ULTRA UXP fitting both ends.
304108	UTR-300-UXP	19 lbs.		ULTRA Trigger one end/ULTRA Piston other.
304109	UTR-300-UTR	19 lbs.	3" Dia.	ULTRA Trigger fitting both ends.
304110	UXP-350-UXP	33 lbs.	15'-5"	ULTRA UXP fitting both ends.
304111	UTR-350-UXP	33 lbs.		ULTRA Trigger one end/ULTRA Piston other.
304112	UTR-350-UTR	34 lbs.	3 1/2" Dia.	ULTRA Trigger fitting both ends.

## OFFSHORE POLES (Requires a Forespar® T-125-S or AT-150-S Toggle Car - See Page 12)

Part No. Custom	Model Number	Shipping Weight	Kit Length (w/ends)	Description
302028	TS-300-GP	22 lbs.	14'	Socket Inboard/GP Outboard.
304115	UTS-300-UTR	18 lbs.	13.5'	ULTRA Socket Inboard/ULTRA Trigger Outboard.
304116	UTS-300-UGPS	19 lbs.	13.5'	ULTRA Socket inboard/ULTRA GPS Outboard.
302032	TS-350-GP	35 lbs.	15.5'	Socket Inboard/GP Outboard.
304117	UTS-350-UTR	33 lbs.	15'	ULTRA Socket Inboard/ULTRA Trigger Outboard.
304118	UTS-350-UGPS	34 lbs.	15'	ULTRA Socket inboard/ULTRA GPS Outboard.
302036	TS-400-GP	47 lbs.	19'	Socket Inboard/GP Outboard.
304119	UTS-400-UGPS	44 lbs.	18.5'	ULTRA Socket Inboard/ULTRA GPS Outboard.
302040	TS-450-GP	52 lbs.	21'	Socket Inboard/GP Outboard.
304120	UTS-450-UGPS	49 lbs.	20.5'	ULTRA Socket Inboard/ULTRA GPS Outboard.

## CUSTOM OFFSHORE SPINNAKER POLES

Our Offshore Series spinnaker poles provide the serious racer with rugged, reliable and efficient equipment. These poles are designed to withstand the rigors of extended offshore racing.

**Note:** Due to the variety of personal preferences concerning bridle and topping lift rigging on offshore end type poles, no "standard" rigging is included on the poles above. If so specified, an end-to-end or a single topping lift can be supplied.



# CARBON FIBER POLES

## FORESPAR® SETS THE STANDARD IN CARBON FIBER DOWNWIND POLES

We have perfected the art of manufacturing carbon fiber equipment not only for the blue water yachts and racers but now for the recreational sailor as well. We have manufactured standard composite poles for over 10 years. We made our first carbon fiber mast in 1979, ten years before anyone else in the U.S. All Forespar® poles are manufactured in the U.S.A. and assembled in our California plant by professional riggers.

We are the world leader in standard composite whisker poles, spinnaker poles and reaching struts. Standard sizing is 2" – 6" diameter. Custom 6 -12" diameter poles are also available. Spinnaker poles are offered in double tapered as well as parallel configurations. In addition, we custom design and make poles or bow sprits specifically sized for the head sail of your choice; code zeros, asymmetrical chutes, spinnakers or roller furling genoas. Typically a composite spinnaker pole will be 40% lighter than a similar aluminum pole yet almost 50% stiffer. Fixed length whisker poles and bow sprits are 50% lighter.

**To ensure proper construction, a completed Spinnaker Pole Order Form must be submitted for each spinnaker pole.**

## TYPES OF CARBON FIBER POLES

### Double-Tapered and Parallel Configurations Available



#### CARBON FIBER FIXED LENGTH WHISKER POLES

Forespar® carbon fiber poles available in deep epoxy clear coat or any Awlgrip color.

#### CUSTOM POLES

California "carbonwood" poles are faux spruce painted poles which give poles the rich wood grain look.



#### CARBON FIBER LINE CONTROL WHISKER POLES

Line Control pole inner tube is epoxy clear coat carbon fiber and the outer tube is Awlgrip white coated carbon fiber.

#### CENTER POINT POLES

Smaller diameter poles can be made with "center point" pick up "D" ring attachments



#### CARBON FIBER SPINNAKER POLES

Shown with optional Kevlar™ chafe protection.



#### CLASS LEGAL ONE DESIGN CARBON POLES

##### Part No.

800124  
800104  
800204  
800306  
800405

##### Model No.

J24  
Tartan 10, UXP-250-UXP CF  
Beneteau 36.7, UTR-300-UTR CF  
Mumm 30  
Beneteau 40.7

# CARBON FIBER SPINNAKER POLES

Forespar's Composites Division has years of experience in the production of high performance carbon poles for racing and cruising boats. Weight reductions over similar aluminum poles are typically 50% or better.

Poles from 2.5" to 4.5" diameters are straight tubes unless custom 4.5" to 3.5" taper is requested. All 5" diameter and larger tubes have double tapered ends. All are produced from pressure cured intermediate modulus carbon fiber, and high performance epoxy resin systems.



## Amsteel™ Trip Lines Standard On All Poles

Part No.	O.D.	Approx. Total Weight	End Fittings	Bridles	Maximum Length	Standard Finish
<b>STRAIGHT NON-TAPERED TUBES</b>						
800901	2.0"	4 lbs.	UXP-UXP	Double	10.0'	EZ Grip
800101	2.5"	4.5 lbs.	UXP-UXP	Double	12.0'	EZ Grip
800102	2.5"	4.5 lbs.	UTR-UTR	Double	12.0'	EZ Grip
800201	3.0"	8 lbs.	UXP-UXP	Double	14.0'	EZ Grip
800202	3.0"	8 lbs.	UTR-UTR	Double	14.0'	EZ Grip
800203	3.0"	9.5 lbs.	UTS-UTR	Double	14.0'	EZ Grip
800301	3.5"	11.5 lbs.	UTR-UTR	Double	16.5'	EZ Grip
800302	3.5"	11.5 lbs.	UXP-UXP	Custom	16.5'	EZ Grip
800303	3.5"	12 lbs.	UTS-UTR	Custom	16.5'	EZ Grip
800304	3.5"	14 lbs.	UTS-UGPS	Custom	16.5'	EZ Grip
800404	4.0"	20 lbs.	UTS-GP	Custom	18.5'	EZ Grip
800405	4.0"	21 lbs.	UTS-UGPS	Custom	18.5'	EZ Grip
800501	4.5"	25 lbs.	UTS-GP	Custom	22.5'	EZ Grip
800503	4.5"	26 lbs.	UTS-UGPS	Custom	22.5'	EZ Grip
<b>DOUBLE TAPERED TUBES</b>						
800502	4.5" to 3.5"		UTS-UTR	Custom	22.5'	EZ Grip
800504	4.5" to 3.5"		UTS-GP	Custom	22.5'	EZ Grip
800505	4.5" to 3.5"		UTS-UGPS	Custom	22.5'	EZ Grip
800601	5.0" to 3.5"		TS-GP	Custom	24.5'	EZ Grip
800701	6.0" to 4.0"		TS-GP	Custom	28.5'	EZ Grip

### OPTIONS

- 800090 Retracting Bridle Option on 3" or Larger UTS Inboard
- 800091 Kevlar Patches (per 2 foot section)

### FINISH OPTIONS

- 800096 U.V. High Gloss Finish - 2" thru 3-1/2"
- 800094 U.V. High Gloss Finish - 4" and Larger Poles
- 800093 AWLGRIPTM Color Coat on 2" - 3-1/2" Poles
- 800089 AWLGRIPTM Color Coat on 4" and Larger Poles

## CARBON FIBER POLE FINISHES

We offers 3 distinctive pole finishes to chose from:

- 1 Our standard "EZ Grip" has a rough textured finish and is a functional and economic way to get carbon fiber performance.
- 2 The "High Gloss" UV resistant clear coated glossy poles offers some protection from the elements and also affords a very shiny and good looking pole.
- 3 The best protection and in some ways the best looking pole is an Awlgrip™ painted pole. A painted pole offers the best protection from the sun while matching any Awlgrip™ color in order to match the mast, deck or any other paint scheme on the boat.

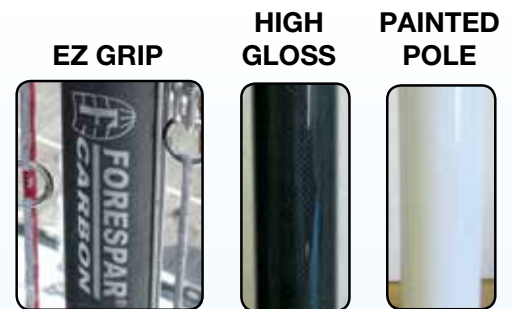

## PADDED SPINNAKER POLE COVERS

Part No.	Model No.
882000	Small - Up to 3" O.D., 14' 6"
882001	Large - Up to 4" O.D., 18' 5"



# REACHING STRUTS

## SELF-LATCHING STRUTS

These struts feature the easy-latching inboard fitting which quickly and securely snaps onto the mast ring. Use of our stainless steel PE-3SF or PE-3SC mast pad eyes is recommended for proper fit.

RSO

UXP



Part No.	Model No.	Kit Length & Weight	Dia.	Mast Fitting
341000	RS-200-UXP	5'7 lbs.	2"	PE-3SF or PE-3SC
341001	RS-250-UXP	6'9 lbs.	2 1/2"	PE-3SF or PE-3SC
341002	RS-300-UXP	7'10 lbs.	3"	PE-3SF or PE-3SC

## STRUT END FITTINGS

The RSO-200 accepts up to 3/8" line while the RSO-300 and RSO-400 accept up to 5/8" line.

Part No.	Model No.	Strut End	Fits Tube I.D.
349000	RSO-200-EF	Outboard	1.870"
349001	RSO-250-EF	Outboard	2.334"
349002	RSO-300-EF	Outboard	2.835"
349003	RSO-400-EF	Outboard	3.750"
304050	UXP-200-EF	Inboard	1.870"
304051	UXP-250-EF	Inboard	2.334"
304052	UXP-300-EF	Inboard	2.835"
309028	TS-300-EF	Inboard	2.835"
405006	TS-400-EF	Inboard	3.750"

Reaching struts are traditionally the same diameter as your spinnaker pole. To figure the length use:

1/2 the beam of the boat + 3 feet or approximately 39% of the J measurement

*Reaching Struts Also Available In Carbon Fiber*

## AUTOMATIC LOCKING STRUTS

This series of struts features our special socket-type end that automatically locks onto the toggle-pin mast fitting with an easy push on the strut. A simple release lever allows the strut to be quickly removed. This strut is especially valuable in competitive racing situations. The TMP mast fittings are required.

RSO

Automatic TS End  
(For TMP Fitting)

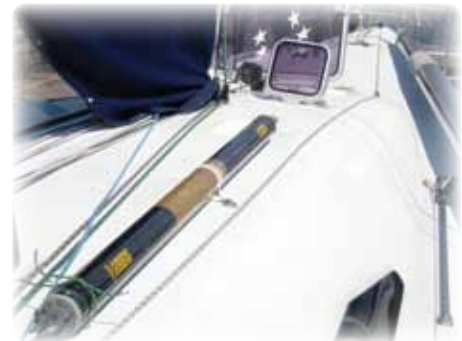

Part No.	Model No.	Kit Length & Weight	Dia.
343000	RS-300-TS	7'11 lbs.	3"
343001	RS-400-TS	9'17 lbs.	4"



## TMP MAST FITTINGS FOR TS ENDS

Part No.	Description
343002	Aluminum
343010	Stainless Steel

# TELESCOPING AWNING POLES



Ideal for boat awnings, our Telescoping Awning Poles are available in four length ranges to accommodate all boat sizes. Featuring our renowned internal twist lock mechanism, the poles feature "eye" type end fittings. For larger boats we offer a special Heavy Duty option. Standard size poles have 7/8" and 1" diameter tubing. Heavy Duty poles are 1" and 1-1/8" in diameter.

Part No.	Model No.	Telescopes
503000	TAP 3-6	45" to 71"
504000	TAP 4-8	57" to 96"
505000	TAP 5-10	69" to 120"
506000	TAP 6-12	81" to 144"
505100	TAP 5-10 HD	69" to 120"
506100	TAP 6-12 HD	81" to 144"



# POLE END FITTINGS

## FORESPAR'S ULTRA SERIES™ END FITTINGS

Represents the cutting edge in spinnaker pole end fitting technology. Designed to be durable, high strength, very light weight and resistance to corrosion, the Ultra Series™ composite end fittings are perfect for aluminum or carbon fiber spinnaker poles and whisker poles. The Ultra Series™ is the sailor's choice for inshore and offshore racing and cruising. Available with or without triggers. Maximum LOA Boat Outboard End - 43'. Maximum LOA Boat Inboard End - 36'. All larger boats use GP Series.

- All Ultra ends require minimum 1.5 inch i.d. rings. Undersized rings damage ends and voids warranty.
- Trip line is Spectra™ with terminal eyestay included. Length is sufficient for standard pole lengths based on diameter.

• Anti-rotational pin with **TRIGGER BALL** allows you to retract trigger end without using pole bridle. All UTR 3 & 3.5 trigger style ends also have adjustable spring tension screw.



### UTR Trigger Style Ends

Part No.	For Pole Model No.	Fits Diameter	Tube I.D.	End Fitting Length	End Fitting Weight
304060	UTR-200-EF	2.0"	1.870"	2.750"	6.97 oz.
304061	UTR-250-EF	2.5"	2.334"	3.125"	9.25 oz.
304062	UTR-300-EF	3.0"	2.835"	3.000"	11.92 oz.
304063	UTR-350-EF	3.5"	3.260"	3.625"	15.72 oz.

### UXP External Trip Ends



Part No.	For Pole Model No.	Fits Diameter	Tube I.D.	End Fitting Length	End Fitting Weight
304054	UXP-150-EF	1.5"	1.370"	2.750"	6.97 oz.
304050	UXP-200-EF	2.0"	1.870"	2.750"	6.97 oz.
304051	UXP-250-EF	2.5"	2.334"	3.125"	9.25 oz.
304052	UXP-300-EF	3.0"	2.835"	3.000"	11.92 oz.
304053	UXP-350-EF	3.5"	3.260"	3.625"	15.72 oz.



### UXTR External Trip Line Ends

Part No.	For Pole Model No.	Fits Diameter	Tube I.D.	End Fitting Length	End Fitting Weight
304090	UXTR-200	2"	1.870"	2.750"	6.0 oz.
304091	UXTR-250	2.5"	2.334"	3.125"	9.25 oz.

LATCH/TRIGGER

## OFFSHORE SERIES GP & ULTRA SERIES™ UGPS END FITTINGS

The **UGPS** end fitting comes with a stainless steel lined throat. This deluxe ocean racing end fitting features a wide flared throat. Both the GP and **UGPS** ends also feature our proven spring loaded piston & trigger system with roller for positive lock and release.

All **UGPS** and **GP** ends for outboard pole end use only. Will not work with mast cars. ALL OUTBOARD ENDS ARE INTERNAL TRIP ONLY.

### UGPS Style



MAXIMUM BOAT LENGTH 60'

Part No.	For Pole Model No.	Tube Dia.	Tube I.D.	Weight w/o trip	Fitting Length
304021	UGPS-300-EF-ULTRA	3.0"	2.835"	2 lb 6 oz	5.00"
304022	UGPS-350-EF-ULTRA	3.5"	3.260"	2 lb 9 oz	5.625"
304023	UGPS-400-EF-ULTRA	4.0"	3.750"	2 lb 3 oz	5.625"
304024	UGPS-450-EF-ULTRA	4.5"	4.260"	3 lb 3 oz	5.1875"

### GP Style



MAXIMUM BOAT LENGTH 75'

Part No.	For Pole Model No.	Tube Dia.	Tube I.D.	Weight w/o trip	Fitting Length
309030	GP-300-EF (Aluminum)	3.0"	2.835"	2 lb 12 oz	5.00"
309033	GP-350-EF (Aluminum)	3.5"	3.260"	3 lb 6 oz	5.625"
309035	GP-400-EF (Aluminum)	4.0"	3.750"	3 lb 14 oz	5.625"
309038	GP-450-EF (Aluminum)	4.5"	4.260"	4 lb 13 oz	5.1875"

## ULTRA SERIES™ GRAND PRIX OUTBOARD END FITTINGS

Our **ULTRA SERIES™** composite pole end fittings are a proven success. Their light weight and resistance to corrosion answer racing and cruising sailor's needs for strength and reliability. The Grand Prix **ULTRA SERIES** include sizes suitable for yachts sixty feet LOA. The **ULTRA** Grand Prix, **UGPS**, model with a stainless steel throat liner insert weighs only 38 ounces.

FOR REPLACEMENT PARTS SEE PAGE 51

## AUTO SOCKET END FITTINGS TS & UTS

This unique “socket” type fitting automatically locks onto the mast toggle pin with a quick and easy push. The release is just as quick with a press of the lever (fits Forespar® mast toggle pins only).



TS Style

Shown with required T-125-S End Fitting Car (pg 12)

For Pole Fits		Weight		
Part No.	Model No.	Diameter	Tube I.D.	w/o trip
309028	TS-300-EF (Aluminum)	3.0"	2.835"	1 lb 10 oz
304080	UTS-300-ULTRA	3.0"	2.835"	1 lb 4 oz
309031	TS-350-EF (Aluminum)	3.5"	3.260"	1 lb 13 oz
304081	UTS-350-ULTRA	3.5"	3.260"	1 lb 7 oz
405006	TS-400-EF (Aluminum)	4.0"	3.750"	2 lb 2 oz
309036	TS-450-EF (Aluminum)	4.5"	4.260"	2 lb 13 oz
304082	UTS-400-ULTRA	4.0"	3.750"	1 lb 7 oz
304083	UTS-450-ULTRA	4.5"	4.260"	1 lb 7 oz

## POLE MAST FITTINGS

### PE-3SF & PE-3SC PAD-EYES

To compliment our medium size Whisker Poles (LC 10-18), Forespar® designed the stainless steel PE-3SF & PE-3SC Mast Pad Eyes. Measuring 2-3/4" x 2", both pad-eyes have inside ring diameters of 1-5/8". PE-3SF is for flat mast surfaces. PE-3SC is slightly bent to better accommodate a curved mast.

Part No.	Model No.
400001	PE-3SF (Flat Base)
400002	PE-3SC (Curved Base)
400012	PE-3-SSF w/ struts (Flat Base)



### Fixed Mast FC & Toggles

Want to add a spinnaker or whisker pole, but don't need a full track system on your mast? Our new Fixed Mast FC or TS Toggle Mounts are a perfect solution for boats 30 to 50 feet. The “FC” works with piston and trigger style end fittings (page 10) and the “TS” only works with the UTS & TS socket style inboard end fittings (page 11). The scissor base adjusts to fit mast thicknesses ranging from 2 1/2" to 5 1/2" wide. Polished stainless, it measures 7" long and has 10 - 1/4" staggered mounting holes.



Part No.	Description
332025	Large Fixed Mast FC Mount (for boats over 35' Feet)
332026	Small Fixed Mast FC Flange Mount (for boats over 25' to 35' Feet)
333025	Large Fixed Mast TS Flange Mount (for boats over 35' Feet)

### T-Track 1-1/4"

Our T-track offers clear anodized aluminum T-track in one standard size. Track comes pre-drilled with alternating pin-stop and mounting holes. The base of the track is gently curved to better accommodate mast surfaces. Available lengths — 5' or 10'. The recommended fasteners are 5/16" x 3/4" Flat-head machine screws. 4" Hole spacing with “pin stop” holes

Part No.	Model No.
339007	T-Track 5' Length
339008	T-Track 10' Length

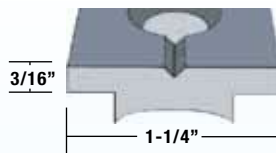

### MARELON Track Stop MS-125

MARELON construction prevents the cracking and shattering common with plastic stops.

Sold Individually.

Part No.	Model No.
339009	MS-125



**TECH TIPS**

### VERTICAL POLE STORAGE

Storing poles (whisker or spinnaker) vertically up the forward face of the mast has become very popular. It clears the decks and keeps the cruising sailor from having to lift the entire weight of the pole from the deck to the mast car.

Selection of the proper mast car and inboard end fitting combination is critical. Ring style cars will not allow a pole to hang vertically without binding and eventually breaking the end fitting. Bear in mind that you have a significant “lever arm” effect on the end. A 10-foot pole can create enough leverage to fracture or bend ends and rings if it binds up and you may never even feel it from the opposite end of the pole. **Forespar® does not recommend ANY ring style mast cars for vertical pole storage**

FOR VERTICAL STORAGE USE ONLY MAST CARS; FC-125, T-125-S, T-150-S



# MAST CARS

## RING STYLE MAST CAR – RC 125

The ring and body of this unusually strong car is investment cast of 17-4 heat treated stainless steel to provide a superior product. Compatible with our “UXP” and “UTR” pole end fittings. Ring I.D. is 1-5/8”. The RC-125 is for 1-1/4” T-track and has a screw lock-pin, our special UHMW polyethylene slides inserts and provisions for up and downhaul shackles.

*RC-125 car is NOT recommended for use with poles that are stored vertically up the mast.*



Part No.	Model No.
331000	RC-125

## HEAVY DUTY CAR — FC-125

These spinnaker cars are designed for the yachtsman who wants a safe, effective means of pole attachment for less than the price of the pin type car. The heavy duty FC-125 spinnaker car allows both vertical and horizontal movement while eliminating undesirable twisting motion of the spinnaker pole. The car slide and pole acceptance jaw are stainless steel.

Fits all standard 1-1/4” X 3/16” flat stainless or aluminum T-track. Recommended for “UTR” and “UXP” type spinnaker pole ends.

#332004 Fits Selden® #511 or 533 mast cars.

**Forespar Does Not Sell or Stock Selden® Mast Cars**



FC-125



#332004 Selden® Flange

Part No.	Model No.
332002	FC-125
332004	Selden FC Flange

## TOGGLE CARS 1-1/4” & 1-1/2” (For use with Auto Socket TS & UTS Ends - pg 11)

This car slide is offered both in stainless steel and hard coat anodized extruded aluminum and offers low friction movement due to UHMW inserts. The toggle-pin is stainless steel in each case. Toggle assemblies available separately see replacement parts page. Our strong 1-1/2” toggle spinnaker car is for boats approx. 50’ to 70’ LOA. Fits the standard Schaefer 41-12 1-1/2” track.



T-125-S



T-150-S

Part No.	Model No.	Track Size
333004	T-125-S (S/S Body)	1-1/4”
333020	Long Toggle Option	
333010	Toggle & Knuckle Assembly	
334100	T-150-S (Aluminium Body)	1-1/2”
331013	Replacement Runners (Sold in Pairs)	

To allow vertical storage on the mast of larger poles up to 6” diameter, specify our long toggle option. Our standard toggle works with poles to 4-1/2” diameter.

### Measuring Poles With TS Or UTS End Fittings & T-125 Toggle Cars

For poles with our TS & UTS end fittings and using a **Forespar®** T-125-S CAR, 5” is subtracted when given a “J” dimensions to establish pole length.

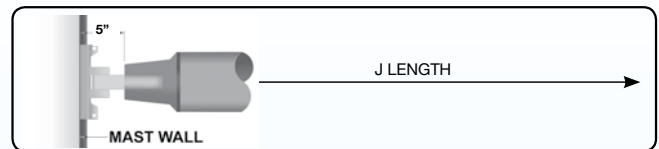

**For Mast Car Replacement Parts See Page 51**

**TECH TIPS**

### IMPORTANT: MAST CAR & EYE SIZES ON OLDER BOATS

Many masts on boats built through the 70’s and early 80’s came with mast pad eyes or ring cars for attachment of the spinnaker pole. These were fixed eyes or sliding cars with relatively small ring diameters. Some were as small as 1” I.D.

Forespar® “Ultra” series end fittings (both the UXP and UTR style) require a minimum of 1-1/2” I.D. rings for proper function. If the ends are used on rings less than 1-1/2” I.D. the jaws (“beak”) can bind-up in the rings and with the leverage of an 8’ pole, (or longer!) the ends will fail. Lesser diameter rings should be changed-out to avoid potential failure to ends due to insufficient clearance. Forespar® will not warrant ends that fail due to improperly sized rings on the mast performance life.

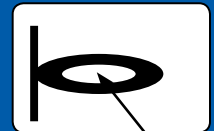

MINIMUM RING INNER DIAMETER MUST BE 1-1/2” OR MORE (UP TO 2” MAXIMUM) FOR PROPER FUNCTION OF FORESPAR END FITTINGS

# SPINNAKER POLE ACCESSORIES

## ALUMINUM TUBING

Clear anodized to military specification (triple commercial). Prime marine alloy 6063-T6. All tubing sold in stock lengths.

Part No.	O.D.	Stock Lengths	Wall	I.D.	Wt./ Ft.	Part No.	O.D.	Stock Lengths	Wall	I.D.	Wt./ Ft.
500018	1-1/2"	22'6"	.065"	1.370"	.35 lbs	301065	3"	11'2"	.083"	2.835"	1.00 lb
500014	1-1/4"	12'	.050"	1.150"	.22 lbs	301072	3"	12'2"	.083"	2.835"	1.00 lb
408002	1-1/2"	7'2"	.065"	1.370"	.35 lbs	301019	3"	13'	.083"	2.835"	1.00 lb
301005	1-1/2"	7'6"	.065"	1.370"	.35 lbs	301063	3"	16'	.083"	2.835"	1.00 lb
500020	2"	21'6"	.065"	1.870"	.47 lbs	301030	3"	23'4"	.083"	2.835"	1.28 lb
408003	2"	7'2"	.065"	1.870"	.47 lbs	301061	3-1/2"	24'4"	.120"	3.260"	1.50 lb
401004	2"	9'1"	.065"	1.870"	.47 lbs	403004	3-1/2"	12'2"	.120"	3.260"	1.50 lb
301058	2-1/2"	20'2"	.083"	2.334"	.74 lbs	301059	3-1/2"	14'	.120"	3.260"	1.50 lb
301056	2-1/2"	9'	.083"	2.334"	.74 lbs	301024	3-1/2"	15'	.120"	3.260"	1.50 lb
301057	2-1/2"	11'2"	.083"	2.334"	.74 lbs	301003	4"	20'	.120"	3.750"	1.72 lb

## VERTICAL POLE STORAGE CAR

This mast fitting is a simple solution to vertical pole storage problems. The VPC-125 retains the upper end of the stowed pole on the mast centerline. The chock slides on the track and eliminates rattle, vibration and binding of the pole end. All four cars fit 1-1/4" T-Track. Available in four sizes; this mast fitting can be rigged with our FC-125 and T-125 mast cars.



Part No.	Model No.
335100	VPC-125-250
335101	VPC-125-300
335102	VPC-125-350
335103	VPC-125-400

## ADAPTING COLLARS

For sleeving Forespar® spinnaker pole end-fittings for use on larger diameter tubing, and other applications.



Part No.	Model No.	Adapts:
304049	AC-2 "ULTRA"	2.00" to 2.50"
304048	AC-3 "ULTRA"	3.00" to 3.50"
304085	"ULTRA"	3.00" to 4.00"
304086	"ULTRA"	3.00" to 4.50"

## DECK CHOCKS

Our deck chocks stow our spinnaker poles or whisker poles on the deck. We strongly recommend poles be stored on deck for heavy weather. The "Ultra" deck chocks will accept all Forespar® pole fittings. Designed and made from Marelon for rugged use and use a "snag-proof" low profile design.



Part No.	Model No.	Description
300002	DC-2 "Ultra"	(For UXP, UTR, GP & UGPS end fittings)
300013	DC-TS "Ultra"	(For TS & UTS end fittings)
300028	DC-TS-S	(Stainless steel, for UTS & TS ends)
300029	DC-2-S	(S. steel, for UXP, UTR, UGPS & GP ends)

## STANCHION MOUNTED POLE CHOCKS

Clear the decks! Now you can stop stumbling over deck mounted poles. These chocks are molded from durable, weather-resistant urethane and mount easily onto 1" stanchions — no drilling necessary. For poles 2" to 3-1/2" in diameter. (Chocks are sold individually — two chocks are needed for each pole.) For spinnaker or whisker poles. Ideal for reaching struts!



Part No.	Model No.	For Pole Dia
300050	SC 200	2"
300042	SC 250	2-1/2"
300043	SC 300	3"
300044	SC 350	3-1/2"

## MAST MOUNTED CHOCKS

(For Vertical Pole Mounting on the Mast)

Molded from durable high tech urethane, these chocks allow for stowing the pole vertically against the face of the mast. Off the deck and out of the way! Two MPC chocks mounted 2-3 feet apart will help stop the pole from rattling.



Part No.	Model No.	Description
300070	MPC 200	2" Mast Pole Chock
300071	MPC 250	2-1/2" Mast Pole Chock
300072	MPC 300	3" Mast Pole Chock
300073	MPC 350	3-1/2" Mast Pole Chock
300074	MPC 400	4" Mast Pole Chock

# YACHT ROD™

## The High Performance Spring-Loaded Mechanical Boom Vang

Precision design in three sizes. Excellent vang/boom support for performance cruising and racing. White powder coated aluminum & polished stainless steel. Supplied with spectra cable ready to add your tackle system. Your 4:1 equals 8:1 when installed on Yacht Rod™. Can be led to small winch for additional power. Spring return holds boom.

Brackets for mast and boom sold separately. Mast and boom fittings are listed below. Caution: Oversheeting or leaning heavily on aft end of boom can bend the boom or the Yacht Rod™. The main halyard shackle should be snapped to the outboard boom end, in port, to prevent damage to the Yacht Rod™.

### “FOR RACING OR CRUISING”



*Note of Caution: Furling booms weigh as much as 3 times the weight of standard booms. Standard vang spring will not support their weight.*

#### FEATURES:

- Eliminates need for boom topping lift
- Supports boom in light air, when reefing and lowering mainsail
- No gas spring to lose its charge
- Faster than hydraulics – No messy hydraulics to leak
- More efficient than conventional tackles
- Tubing is white coated anodized 6061-T6 aluminum and electropolished 316 stainless steel
- Precision machined 6061-T6 aluminum clevis ends, sheaves and Nylatron® bearings
- Precipitation hardened stainless steel spring with fast-pin adjustment — rated for over 1 million compressions.

YR Model Specs	YR-M	YR-L	YR-XL
Stroke	7"	11-1/2"	11-1/2"
Adjustable Length			
Pin to Pin (min.)	58 1/2"	66 1/2"	79 1/2"
Pin to Pin (max.)	70 1/2"	80"	93"
Adjustable Distance	12"	13-1/2"	13-1/2"
Pin Size	1/2"	5/8"	5/8"
Jaw Width	3/8"	11/16"	11/16"
Weight	9.8 lbs	17 lbs	19 lbs
Max. Return Force	600 lbs	1450 lbs	1450 lbs

### YACHT ROD™ MAST & BOOM FITTINGS

YR-M Boom Fitting



YR-L & XLG Boom Fitting



### COMPLETE YACHT ROD™ PACKAGES

#### YR-MEDIUM - COMPLETE SYSTEM

Part No.	Package	Max. LOA	Includes
352050	1	40	YR-M Vang YR-M Boom Fitting YR-M Mast Fitting Harken Blocks & Tackle

#### YR-LARGE - COMPLETE SYSTEM

Part No.	Package	Max. LOA	Includes
352160	2	45	YR-LG Vang YR-LG Boom Fitting YR-LG Mast Fitting Harken Blocks & Tackle

#### YR-EXTRA LARGE - COMPLETE SYSTEM

Part No.	Package	Max. LOA	Includes
352165	3	55	YR-XLG Vang YR-XLG Boom Fitting YR-XLG Mast Fitting Harken Blocks & Tackle

#### Part No. Model No./Description:

352003	Boom fitting for YR-M
352103	Boom fitting for YR-L & YR-XL
352005	Mast fitting for YR-M
352104	Mast fitting for YR-L & YR-XL
352007	Harken 8:1 Tackle YR-M
352130	Harken 8:1 Tackle YR-L
352131	Harken 8:1 Tackle YR-XL

### YACHT ROD™ - w/o HARDWARE

Model No./Description:	Part No.
YR Medium Yacht Rod for boats 34-40'	352000
YR Large Yacht Rod for boats 41-45'	352100
YR X-Large Yacht Rod for boats 46-55'	352101



# MAST LIGHTS

Forespar® offers two mast light systems. Model ML-1 deck light is designed primarily for installation on the mast just below the spreaders. Model ML-2 is a combination deck-bow light with separate switching, to be mounted on the forward part of the mast.

ML-1 & ML-2 feature durable molded polymer housing assemblies with adaptable wraparound mounting apron to accommodate virtually any mast curvature. For 12 V systems. Replacement bulbs available from Forespar® or most marine dealers.

## SPREADER/DECK LIGHT - ML-1



- Lightweight - Rugged Composite Material
- Adaptable to Mast Radius for Ease in Mounting
- 20W Replaceable Halogen Type Bulb 1.4 amps
- Weighs 4 oz. - Measures 3-5/8" Vertically
- Provided with 6" of Twin-Lead Wire
- New Molded Body
- Available in black finish only

**NEW** Available with LED Bulbs

Part No.	Model No.
131000	ML-1
131300	ML-1 LED
132035	Standard Bulb
132009	Replacement bottom ring (Twist lock)

## COMBINATION DECK/BOW LIGHT - ML-2



ML-2 #132000

This top selling light has been completely retooled for easy bulb replacement and brighter deck illumination using a new prismatic reflector.

- New molded black finish body
- Meets Coast Guard Requirements for Yachts Up to 65' LOA\*
- Separate Switching
- 10 Watt Bow Light Bulb Is Easily Replaceable (WN-211) .8 amps
- Deck Light Features Identical to ML-1
- Provided with 6" of Triple-Lead Wire
- Weighs 7 oz. - Measures 5-3/4" Vertically

Part No.	Model No.
132000	ML-2
132300	ML-2 LED
132025	WN-211 Top Bulb
132200	Stainless Steel Chafe Guard
132041	Complete top clear lens

\*Copy of certification report available upon request from Forespar®.

### LED Replacement Bulbs

Part No.	Model No.
132325	ML-2 Top bulb-LED
132335	ML-1 & 2 Bottom bulb-LED

For All Replacement Parts See Page 51

## STAINLESS STEEL LIGHT GUARD



Stainless Steel Light Guard protects mast lights and other mast fittings from line snagging

Part No.	Model No.
132200	Stainless Steel Chafe Guard



Works with Aqua Signal #254047-7 Combo Light

## LIGHTNING MASTER™

Lightning Master™ Static Dissipaters lower the exposure to a direct lightning strike by controlling the conditions which trigger direct strikes. It reduces the build-up of static ground charge and retards the formation of the ion "streamers" that complete the path for a lightning strike.

This is the same technology successfully employed to protect commercial broadcast and television towers. This lightweight (5.2 oz.) 21" long dissipater mounts to the masthead and extends vertically above all other masthead equipment.

We do not claim that this product is 100% effective in preventing a lightning strike. At the present collective level of understanding of the lightning phenomenon, no one can make that claim. This product does control the causes of lightning strikes and thereby reduces the incidence of direct strikes.



Lightning Master™ is the trade mark of the Lightning Master Corporation whose products are protected by U.S. patent.

Part No.	Description
151100	Lightning Master™ Static Dissipater

Works Well on Power Boats Too!

# SHACKLE GUARDS

Place a protective buffer between the spinnaker pole ends and your after-guy shackle. Made of high-strength polyethylene, these tough polymer guards are UV inhibited for long life. Shackle Guards can also be used on lifelines to skirt genoas.

**Sold Individually**



Part No.	Model No.	Size	Part No.	Model No.	Size	Part No.	Model No.	Size
300006	SG-1 White	2-1/4" Dia. X 3/8" ID	300085	SG-1 Red	2-1/4" Dia. X 3/8" ID	300090	SG-1 Green	2-1/4" Dia. X 3/8" ID
300007	SG-2 White	2-1/4" Dia. X 1/2" ID	300086	SG-2 Red	2-1/4" Dia. X 1/2" ID	300091	SG-2 Green	2-1/4" Dia. X 1/2" ID
300008	SG-3 White	3" Dia. X 1/2" ID	300087	SG-3 Red	3" Dia. X 1/2" ID	300092	SG-3 Green	3" Dia. X 1/2" ID
300009	SG-4 White	3" Dia. X 5/8" ID	300088	SG-4 Red	3" Dia. X 5/8" ID	300093	SG-4 Green	3" Dia. X 5/8" ID
300010	SG-5 White	3" Dia. X 3/4" ID	300089	SG-5 Red	3" Dia. X 3/4" ID	300094	SG-5 Green	3" Dia. X 3/4" ID

# SAIL SAVER™

## JIB ROLLER - SR-2

Jib rollers for wire sizes 3/16" to 3/8". Extend the life of your genoa by reducing chafe on the spreader tips.

Jib rollers can also be used on lifelines for helping pass foot of jib over stanchions.

**Sold in Pairs**

Part No.	Model No.	Wire Size
210003	SR-2 (pr.)	Accepts wire 3/16" to 3/8"



# TURNBUCKLE COVERS



Deluxe aluminum turnbuckle covers give a fine yacht the "finished" look. Functional (keeps sheets from snagging on turnbuckle clevis pins) and durable, the turnbuckle covers come in three sizes to handle rigging from 7/32" to 1/2" wire diameter.

They are available in a white finish or clear anodized (silver) aluminum finish. The bases (bottom) come square and can be notched (to fit over chain plates) or cut to match your deck/shroud angle.

**Sold Individually**

### Three Available Sizes

**Small**-(1-1/2" tubes) for 7/32", 1/4" and 9/32" wire sizes.

- #210013 Anodized
- #210010 White
- Length - 22"

**Medium**-(2" tubes) for 5/16" and 3/8" wire sizes.

- #210014 Anodized
- #210011 White
- Length - 26"

**Large**-(2-1/2" tubes) for 7/16" and 1/2" wire sizes.

- #210015 Anodized
- #210012 White
- Length - 36"

# LANOCOTE PROP & BOTTOM

## ALL NATURAL FOUL RELEASE PROP & BOTTOM COATING

**NEW**

LanoCote Prop & Bottom is a revolutionary new way to keep your underwater surfaces clean. Simply wipe a thin coating of LanoCote Prop & Bottom onto fowl prone surface for long lasting growth resistance and increased flow efficiency.

Part No.	Model
770035	LanoCote Prop & Bottom 16 oz. Jar
770031	LanoCote Prop & Bottom 1 Gallon
770030	LanoCote Prop & Bottom 5 Gallon



# LANOCOTE®

The Natural Choice of Marine Professionals

## HOW DOES LANOCOTE WORK?

LanoCote works on these five basic principals: displaces water, absorbs corrosion, forms moisture barrier, penetrates and has high lubricity. LanoCote prevents dissimilar metal galvanization. LanoCote is extremely effective in preventing and stopping corrosion on all types of metals under all environmental conditions. Formulated to withstand salt water marine conditions, LanoCote® is particularly useful in preventing thread seizure due to all types of corrosion on boats and machinery.

Applied during assembly, LanoCote will greatly assist in easy dismantling years later. An example would be anchor shackles which are regularly immersed in salt water. LanoCote® also combats galvanization where dissimilar metals are fastened together, such as stainless steel fittings on alloy masts etc.

- Prevents Thread Freeze-up
- Combats Galvanic Reaction of Dissimilar Metals
- Seals Porous Surfaces
- Neutralizes Acids, Alkalies & Salts



Part No.	Model
770001	LanoCote® 4 oz. Jar
770002	LanoCote® 7 oz. Aerosol Spray Can
770003	LanoCote® 16 oz. Jar
770007	LanoCote® 8 oz. Pump Spray Bottle

## ASSORTED MARELON® CLEATS

Molded from high-strength Marelon®, Forespar's cleats have been used by manufacturers of yachts and power boats all over the world. Their strength, light weight and low cost have contributed to their increased use in the marine industry. The use of Marelon® allows our cleats to take up the curve of a deck without breaking, while maintaining strength and resisting abrasion — will not soften on hot days or freeze in winter.

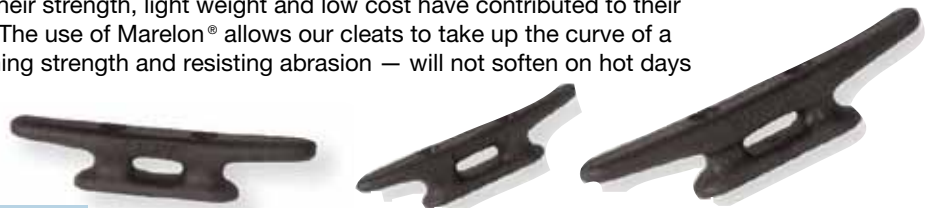

### 3" - 8" CLEATS

Part No.	Model No.	Hole Dia.	Size
941018	MF 761/3	5/32"	3"
941016	MF 762/4	3/16"	4"
941013	MF 763/5	3/16"	5"
941014	MF 764/6.5	1/4"	6.5"
941015	MF 765/8	1/4"	8"

### LOW PROFILE 6" CLEAT

Part No.	Model No.	Hole Dia.
941006	MF 766/6	1/4"



## EXIT BOX

This line exit box is made for use with the new high-tech rope fibers. Suitable for carbon fiber and ideal for aluminum because there is no metal to metal contact to promote corrosion. Stainless steel molded into a strong Marelon® cheek with no moving parts.

Part No.	Model
030016	Marelon® Exit Box

Flange size: 3-1/4" L X 7/8" W  
 Cut-out size: 2" X 11/16"  
 Maximum line size: 1/4"  
 Uses two 3/16" flat head fasteners.



## TRANSOM HANDLE

Tough Marelon Transom Handle.  
 6-5/8" (168.27mm) long x 2-9/16" (65.08mm) deep

Part No.	Model
890017	Marelon® Transom Handle

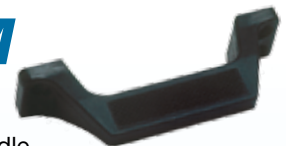

## LINE CHOCKS

Tough Marelon Line Chocks create a convenient, chafe-free line lead to help direct your dock lines as needed.

Part No.	Model No.	Hole Ctrs.	Hole Dia.
950001	MF 755	3-1/2"	3/16"
950000	MF 770	6"	1/4"



# TILLER EXTENSIONS

## TWIST-LOCK TILLER EXTENSIONS

The industry standards are set by Forespar's complete line of hiking sticks with designs and lengths to satisfy every sailor. Our telescoping models offer a choice of three excellent fastening devices: TFP (Quick-Release); SF (Sta-Fast™); and SL (Speed-Lock) our new composite universal.

A long time favorite of serious sailors around the world, the TFP (Quick-Release) model can be instantly fastened to the tiller by simply depressing the plunger and inserting the detent pin into the special tubular fitting supplied. Again, an easy push on the plunger and the hiking stick is released from the tiller. Stow it or take it home with you. It's fast, simple and secure.

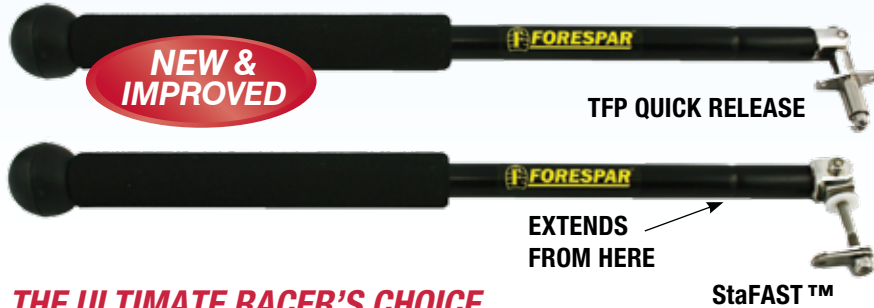

## TILLER CLIPS

Exceptional strength tiller clips molded out of Marelon®



## THE ULTIMATE RACER'S CHOICE.

*New composite cam locks give our time tested twist lock tiller extensions a crisp, positive bite while freely unlocking with a quick turn of the wrist.*

Part No.	Model No.	Telescopes	Tube Dia.
104016	TFP-S	19" to 32"	3/4" - 5/8"
104017	TFP-M	27" to 48"	3/4" - 5/8"
105110	STX 30"	Fixed	3/4"
105120	STX 36"	Fixed	3/4"
108100	SF-S	19" to 32"	3/4" - 5/8"
108101	SF-M	27" to 48"	3/4" - 5/8"

Part No.	Model No.	Size
941020	MF-671	3/4" Tubing Clip
941021	MF-672	7/8" Tubing Clip
941022	MF-673	1" Tubing Clip
941023	MF-674	1-1/8" Tubing Clip

## "BIG STICK" CARBON FIBER TILLER EXTENSIONS

Our rugged, light weight tiller extensions are built to stand the test of time on any go fast dinghy or keel boat. They are simple yet elegant. Nothing to go wrong. 7/8" diameter shaft for a solid grip for either men or women. NO Frills, just an extension! Black only.

Part No.	Model No.	Length
102214	Big Stick Carbon	30"
102215	Big Stick Carbon	36"
102217	Big Stick Carbon	48"
102216	Big Stick Carbon	72"

All straight tubes so that they can be modified by each sailor to tailor fit his/her boat. Simply cut the tube to length on the outboard end. All come with our proven "speed lock" design (see page 21) for quick mount/dismount and easy replacement if necessary. The extensions are shipped loose for custom lengths to suit your class requirements.



## "GIANT STICK" CARBON FIBER TILLER EXTENSIONS

The Big Stick's big brother, the Giant Stick offers all the features of the Big Stick with a larger diameter tube for a more comfortable and positive feel. 1-1/4" diameter shaft for a solid grip for either men or women. Black only.

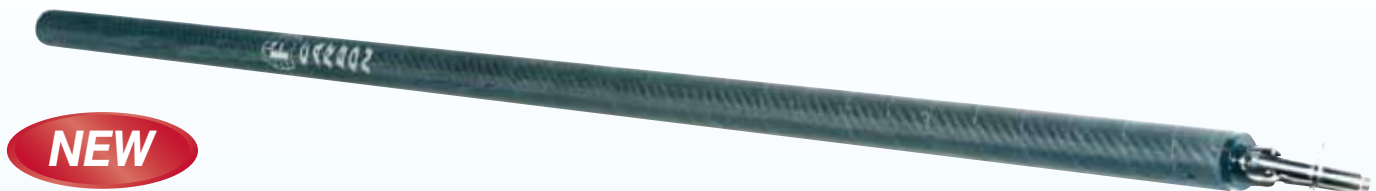

Part No.	Model No.	Length
102225	Giant Stick, StaFast	30"
102226	Giant Stick, StaFast	48"

Part No.	Model No.	Length
102221	Giant Stick, Speed-Lock	30"
102229	Giant Stick, Speed-Lock	36"
102222	Giant Stick, Speed-Lock	48"
102227	Giant Stick, Speed-Lock	72"

**Giant Stick**  
**Big Stick**  
**Conventional**

**Diameter Comparisons**

## THE BALL END & GOLF GRIP SWIVEL STICK

Forespar's economical fixed length tiller extension is now a better value. Featuring our removable Speed Lock (SL) rubber universal end fitting mounted on rugged 5/8" dia. black anodized aluminum tubing with rubber Ball End or Golf Grip style handle. For the small boat (up to 22' maximum) sailor. Available in four of the most popular lengths: 18", 24", 30" & 36".

### BALL END

Part No.	Model No.	Length
102000	SW-18	18 in.
102001	SW-24	24 in.
102002	SW-30	30 in.
102003	SW-36	36 in.
102117	Replacement Speedlock Universal	
102119	Curved Base	
102120	Speedlock Base	

Tube Diameters 5/8"  
(Uses Tiller Clip Part # 941020)

### GOLF GRIP

Part No.	Model No.	Length
102008	SWG-18	18 in.
102004	SWG-24	24 in.
102005	SWG-30	30 in.
102006	SWG-36	36 in.
102117	Replacement Speedlock Universal	
102119	Curved Base	
102120	Speedlock Base	

Tube Diameters 5/8"

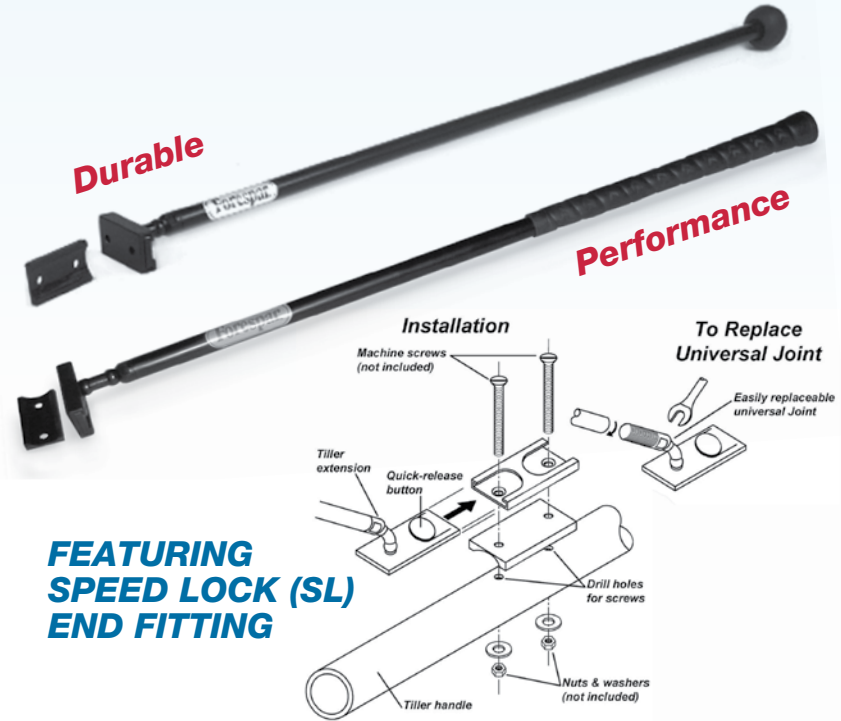

**FEATURING SPEED LOCK (SL) END FITTING**

## END FITTINGS

### StaFAST™ END FITTING (SF)

Patented design holds the tiller extension exactly where you leave it. No more sliding down out of reach (not sold separately). 5/16" X 2-1/2" bolt



StaFAST™STX & SF

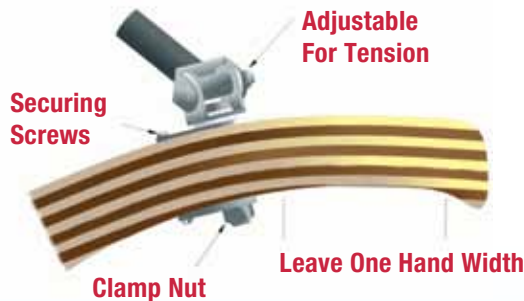

### TFP QUICK RELEASE



**Part No.**

104004 TFP Assembly Complete With Socket  
104006 TFP Socket (receptacle only)

**Not Sold Separately**

### TILLER LOCK BOX — TLB

This inexpensive product turns any boat with a ball-grip Forespar® tiller extension into a boat with a simple, effective and adjustable tiller lock. Install one into your cockpit coaming and you have it in minutes!

**Cut-out Dimensions :**  
3-3/8" w X 4-3/4" h X 1-1/2" d.

Part No.	Model No.
100000	TLB

**Locks Your Boat On Course!**

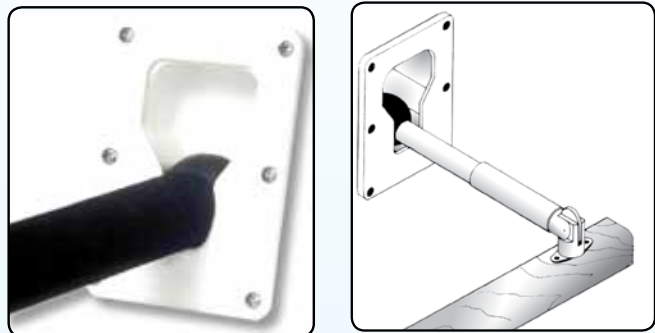

# MOB SAFETY PRODUCTS

## OVERBOARD GEAR NEEDS TO BE DEPLOYED QUICKLY...



... Because, at only 3 knots ...

... the person will be 50 feet away in 10 seconds, and ...

... in waves, the person will lose sight of the horseshoe buoy without an overboard pole!!

Our Man Overboard Poles are approved by both I.S.A.F. and Transpac Y.C. for offshore racing. These poles are constructed of the finest materials and reflect modern design and quality workmanship. The strong fiberglass shafts feature a highly visible yellow coating. The red and yellow flags are made of long lasting Dacron with a batten sewn in place to hold the flag in an open position. Now includes reflective tape to aid in night location.

We also use a special bright orange float which is made of a high impact, polyethylene jacket filled with closed-cell polyurethane foam. The float is slotted on the OP 120/150 model so it easily fits close to the backstay or life lines.

All poles are two-piece and feature a unique top shaft that can be custom sized by the user resulting in an overall pole length ranging from 11.5 to 15 ft. An epoxy kit is provided with each unit and no cutting is necessary. Simply telescope the top shaft to length desired and epoxy in place. A non-corrosive joining sleeve is standard to allow disassembly of the top shaft from the float for easy storage. The flag is included with Overboard Poles. Outside diameter of float is 4.25 inches.

### OVERBOARD POLES — OP-120



#### DIMENSIONS

Part No.	Model No.	Overall Length		Butt to Top of Float	Weight	Top Half	
		Minimum	Maximum			Minimum	Maximum
202018	OP-120	142 in.	176 -1/2 in.	64 in.	8 lbs.	78 in.	112-1/2 in.
202020	Top Pole Complete with Flag						
202026	Replacement Flag						

### STERN TUBE OVERBOARD POLES

Functionally the same as model OP-120 overboard pole, the OPST is designed for boats with stern tubes.

Outside diameter of float is 3.25 inches.

Constructed from the same fine materials as our 'standard' poles.



#### DIMENSIONS

Part No.	Model No.	Overall Length		Butt to Top of Float	Weight	Top Half	
		Minimum	Maximum			Minimum	Maximum
202019	OPST-120	143 in	178 in	65-1/4 in	8 lbs.	78-1/2 in.	112-1/2 in.

## FLOATING STROBE WATER LIGHT- WL-1



Recent intense technological developments in the camera industry enable us to bring you this advanced strobe light at a significantly lower price.

Built to meet Code of Federal Regulations sub part 161.010; this rugged water light produces brilliant omni-directional (360 degrees) strobe flashes automatically when thrown overboard and is visible for miles at sea. When used with a 6 volt alkaline lantern battery (not included) it will flash at the U.S.C.G. required rate for over 52 hours and will still flash at least every 2 seconds after 7 days of continuous operation (meets U.S.C.G. requirements—46 CFR-161.010). A stainless steel mounting bracket is included. Dimensions are 11-1/2" long, and 4" maximum diameter, 1.85 lbs.

Battery Not Included

Part No.	Model No.
205102	WL-1
205130	Replacement Strobe
205113	Bracket Only
202151	Battery

**U.S.C.G. Approval #161.010/20/0**

## PERSONAL RESCUE LIGHT - RL 2 & RL SOLAS

Our new approved personal strobe flasher should be an essential part of every yachtsman's safety gear. Meets U.S.C.G. 161.012 when powered by an alkaline "C" battery replaced annually. Batteries are not included. Waterproof to 120 feet. Has a Velcro strap for attachment to upper arm or safety harness. Measures approx. 5" high, weighs only 5 oz. & flashes for over 24 hours.

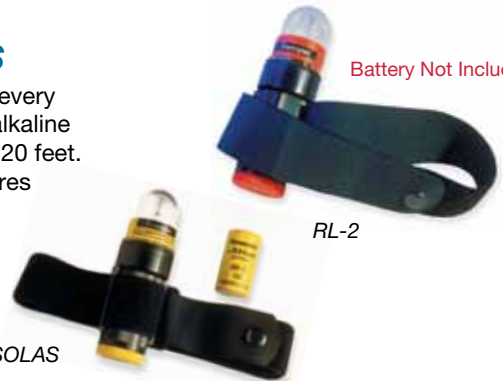

Battery Not Included

Part No.	Model No.
202150	RL SOLAS
202102	RL-2



## OVERBOARD POLE HOLDER - 300-M

The Railfast® overboard pole holder holds the base of the pole. Easily mounted to the stern rail, close to the horseshoe bracket, it helps provide a complete safety system—with all man-overboard items located in close proximity for speedy deployment when time is of the essence. This unit is made of stainless steel and corrosion proof nylon, and comes with all mounting hardware.

Part No.	Model No.
156003	300-M-1" Rail
156023	300-M-1-1/4" Rail

## FLAG TUBE OP-FT

To secure the flag on the overboard pole to the backstay or along the lifeline, our polyvinyl flag tube is superior to fabric flag-boots. Offering longer life and a faster release of overboard pole. Comes complete with fasteners and simple instructions. Maximum wire size = 3/8 in.



Part No.	Model No.
202013	OP-FT

## Sta-Plug®

Sta-Plug® instantly controls incoming water by automatically conforming to fill the shape of a hole. Whether it's from hull damage, hose failure, corroded thru-hulls or any other source, Sta-Plug's® soft cone-shape fills the gap. Its unique edge gripping riblets also help hold it in place, giving you precious time in an emergency.

**NEW**



- More Versatile Than Wooden Plugs
- Easy to Use - Hand Compresses
- Works Up To 10' Below Waterline

Part No.	Model No.
150110	Sta-Plug

# HOYT JIB BOOM™

## Perfect Wing & Wing Trim of Your 100% Self-Tacking Jib

As your boat bears off downwind, and the sheets are eased, the Hoyt Jib Boom™ maintains precise control of the jib's leach. This results in remarkable performance improvement and ease of handling.

*"The Hoyt Jib Boom™ is one of the best cruising innovations I have seen or used".*  
Ken Read • Vice Pres. North Sails



## Sail More Easily & Efficiently

Proven on Over 1,000 Boats and Trans-Oceanic Passages

- Self Tacking Upwind
- Self Vanging Downwind
- White Powder Coated Base
- Up and Downwind Jib Control Based on a Simple & Effective Principle
- Leach Twist Perfectly Trimmed Downwind

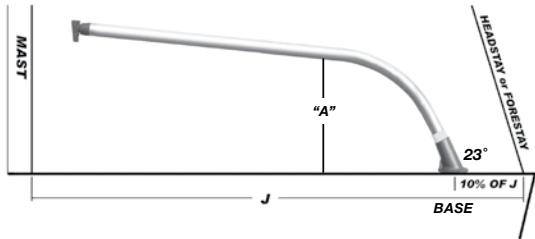
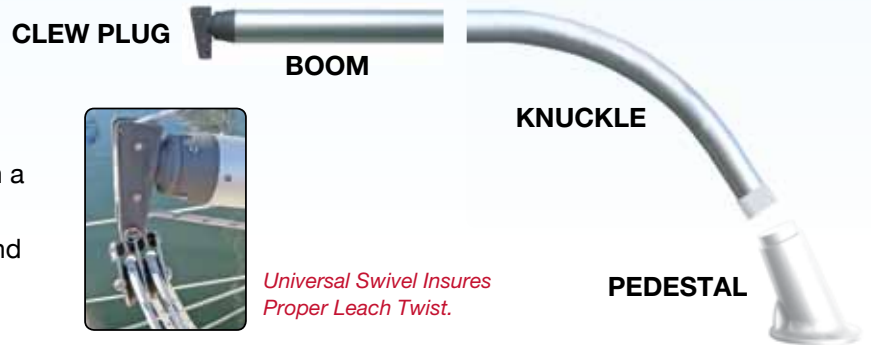

The typical base placement (center of the pedestal base) is 10% aft of the headstay. This is not a critical location, but rather a "Rule of Thumb". Various obstacles can obstruct the pedestal base position.

All knuckles are bent to 57 degrees. All pedestals are set at 23 degrees. All angles are calculated on a perfectly flat and level deck. Wedges will be required on many installations to make up for deck camber. A universal black molded urethane wedge which can be cut to fit is available from Forespar®

## HOYT JIB BOOM MODELS

Part#	Model No.	Tube Dia	Weight	Knuckle Length	Boom Tube Length	Suggested Maximum J	Yacht LOA	Base Dia	"A"
313101	250	2.5" OD	16lbs	2.25"	6'	10'	25' - 29'	7"	14"
313102	300	3.0" OD	24lbs	2.50"	11'	13'	30' - 35'	7-3/4"	17"
313103	350	3.5" OD	37lbs	2.75"	13'	17'	35' - 42'	8-3/4"	21"
313155	Universal Wedge (SOLD IN PAIRS)								

## ROLL-X FLOPPER STOPPER

### Removable Anchorage Stabilizer

The Roll-X Flopper Stopper limits the rocking and rolling of a rough anchorage. Exclusive baffle design provides superior stability.

- Can be Quickly Deployed and Removed
- Stainless Steel and Aluminum Construction
- Professional Installation Recommended



Part #	Boat Length
305301	Roll-X Stabilizer
305302	3" x 11'2" Pole Kit for Boats to 40'
305303	3 1/2" x 14' Pole Kit for Boats to 55'
305304	NEW Roll-X Storage Bag

## MULTIHULL SPRIT KIT



Articulating Sprit Adds Downwind Sail Functionality to Multihulls. This sprit kit can be fitted to most multihulls to allow for use of reaching spinnakers and drifter sails.

- Increases Downwind Performance
- Can be used with Continuous Line Furling Systems
- Professional Installation Recommended

Part #	Boat Length
305003	3" x 4' for 25-35 foot boats 25'-23'
305004	3-1/2" x 5' for 36-42 foot boats 36' to 42'
305005	4" x 6' for 43-50 foot boats 43' to 50'



# MARINE LABELS

These popular label sets are great for any racer or cruiser. Add safety and organization to your above and below deck systems. Remember, not everyone on board knows your boat as well as you do. All labels are self-adhesive, vinyl plastic, waterproof and won't fade. Perfect for flat, round or irregular surfaces of metal, fiberglass or paint.

## SAILBOAT LABELS

**100016**

FOREGUY	MAIN HALYARD	BOOM LIFT
	JIB HALYARD	
	STAYSAIL HAL'YD	
	SPINNAKER HAL'YD	
OUTHAUL	TOPPING LIFT	DOWNHAUL
	CUNNINGHAM	
	BOOM VANG	
	MAIN SHEET	

**100010**

1	1
2	2
3	3
4	4
5	5
6	6
7	7
8	8
9	9
10	10
11	11
12	12
13	13
14	14

**100011**

-10-
-9-
-8-
-7-
-6-
-5-
-4-
-3-
-2-
-1-
0-

**100013**

RUNNING BACK	BABYSTAY	FORESTAY
	#2 JIB HALYARD	
	#2 SPINN. HALYD	
	#2 CLEW REEF	
RUNNING BACK	SLAB REEF	BACKSTAY
	SHOOTER SHEET	
	BUTT LIFT	
	BUTT DOWNHAUL	

**100024**

STAYSAIL FURL	#1 TACK REEF	MAIN HALYARD
	#2 TACK REEF	
	#3 TACK REEF	
	#1 CLEW REEF	
JIB FURLER	#2 CLEW REEF	MAIN SHEET
	#3 CLEW REEF	
	STAYS'L SHEET	
	STAYS'L SHEET	

**100017**

**UPDATED**

Part No.	Model
100010	Track numbers
100011	One 0"-10" scale
100013	Spar labels
100014	Clew and winch labels
100016	Control lines
100017	Racing flag signals
100024	Stoppers Labels

**Helps Prevent Crew Snafus!**



# MARELON® WINCH

Molded of Marelon® for exceptional strength, this lightweight winch will easily handle up to 200 square feet of sail. This little winch is ideal for use on the modern trailer-sailor or the small racer. On larger boats it is great for out-hauls and other control lines with relatively low loads. Weighing in at less than one pound you will find many uses for this tough little winch. **Use four 1/4" fasteners (not included).**

- Product Of Ultra Light Composite Technology
- For Up To 200 Sq. Ft. Of Sail
- Only Weighs .86 Lbs.
- All Marelon® Construction
- No Corrosion
- Accepts Standard Star Drive Winch Handle
- 8:1 Power Ratio When Used With A 10" Handle
- 6:1 Power Ratio When Used With An 8" Handle

### DIMENSIONS

Height: 3-3/8", Base diameter: 3-5/8"  
 Top diameter: 3-1/4", Drum diameter: 2-7/16"  
 Four 1/4" fastener holes in 1-7/8" square pattern



Part No.	Description	Model No.
960003	Marelon® Winch	MW-6



# STEERING CONTROL ARM

Our new Steering Control Arm allows you make minor course adjustments without being directly in touch with your wheel. The tiller like system can be quickly attached or removed with push of a button.

- Greater Forward Visibility
- Easy Course Corrections Autopilot's Can't Perform
- Great for Relaxation While Maintaining Control



Part No.	Description
104018	Steering Control Arm

LABELS, MARELON WINCH, STEERING CONTROL ARM

# RAILFAST® HARDWARE

## ATTACH ACCESSORIES TO YOUR SIDE RAILS TO SAVE VALUABLE DECK SPACE!

Railfast Hardware allows you attach a wide variety of accessories to your round side rails. Great for sail or powerboats, your imagination is the only limit to how you can use Railfast Attachments. Fish cleaning boards, stoves, flag poles, GPS receivers, fenders, solar panels can now all be securely mounted to your rail without drilling.

The patented Railfast® mounting system offers an attractive, yet functional method for mounting gear to a boat railing. All Railfast® system parts are corrosion-proof nylon or stainless steel. An assembly tool and all necessary hardware included.

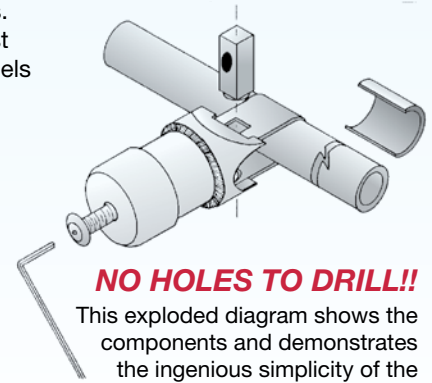

### NO HOLES TO DRILL!!

This exploded diagram shows the components and demonstrates the ingenious simplicity of the system. It installs in minutes on any 7/8", 1" or 1-1/4" rail and requires no drilling.

## DO IT YOURSELF!

The number of uses for the Railfast® mount is as unlimited as your own imagination! Assemblies are available that make it easy for you to create your own device to mount almost anything to your railing.

### MOUNTING BOSS

The Railfast® mounting boss consists of the rail clamp assembly and a cover piece with a flat surface, all secured by a single bolt. Mount fender baskets, running lights, solar panels, barbecues, etc.



Part No.	Model No.
156011	300-1" Rail
156031	300-1-1/4" Rail

### MOUNTING FLANGE *Great for Solar Panels*

Railfast® mounting flange-350 provides a flat, 4-hole mounting surface that can be adapted to a variety of uses. Mount cutting tables, outboard brackets etc.



Part No.	Model No.
156012	350-1" Rail
156032	350-1-1/4" Rail

### FLAG POLE SOCKET

Railfast® assembly and flag pole holder make installing flag poles a breeze. The holder can mount at any angle on a horizontal bow or stern rail and will accommodate flag poles with 1" base diameters. A set screw holds flag pole in place.



Part No.	Model No.
156006	324-FPH-1" Rail
156026	324-FPH-1-1/4" Rail

## RAILFAST® ANTENNA MOUNTS

Railfast® is a great way to install your antennas. It mounts quickly to 7/8", 1" or 1-1/4" railings, horizontally, vertically, or at any angle, providing a professional and secure mounting for standard VHF, CB, and Loran antennas up to 8' in length. A special internal feed-through channel accommodates Loran cable that is routed directly out the bottom of the coupler.

### NYLON ANTENNA MOUNT

Ideal for permanent fixed installation of antennas.

Part No.	Model No.
156009	311-N-1" Rail
156029	311-N-1-1/4" Rail



### NYLON ANTENNA MOUNT WITH HANDLE

Molded with a fiberglass additive for superior strength. Laydown handle for passing under bridges storage or trailering.

Part No.	Model No.
156008	311-NLH-1" Rail
156028	311-NLH-1-1/4" Rail



### UTILITY HOLDER

The Railfast® ring mounting bracket has a variety of uses including life rings, power cables, line or other accessories. Use in pairs to hold larger objects



Part No.	Model No.
156000	300-R-1" Rail
156020	300-R-1-1/4" Rail



### HORSESHOE HOLDER

The Railfast® horseshoe mounting bracket is a must for any sailboat. Electro-polished stainless steel it is bent precisely to hold a standard horseshoe buoy securely without the need of a retaining strap.

Part No.	Model No.
156001	300-H-1" Rail
156021	300-H-1-1/4" Rail



# ADJUSTABLE TABLE PEDESTALS

The Forespar® Table Pedestal System features the choice of gas charged, non-gas high/low and fixed length table pedestals and incorporates bases molded from our exclusive light weight and corrosion resistant Marelon®.

The bases are 9-3/4" diameter. The standard gas and non-gas high/low systems are 13" collapsed measured from the flange of each base with a 5" bury below the sole. The lower base is epoxied to the tube. Maximum height is 26". The base can be moved up or down upon request however, the overall length of the tubes stays constant. For example if you request a 2" bury, you will have a 16" collapsed height(see diagram). The upper mounting flange is a tapered "slip fit" to the tube. This may also be epoxied for added stability and strength. All tube is sold by the inch and includes any/all tapers required.

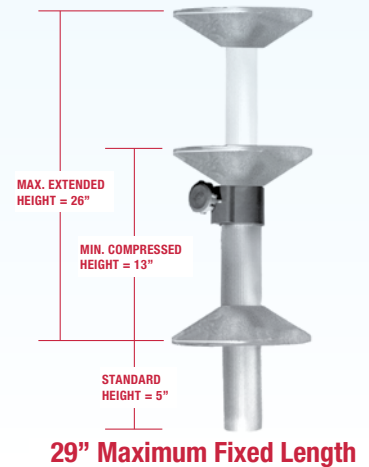

Part No.	Model	Part No.	Model
161001	Gas spring set-silver coated surface bases	164008	2-3/8"(60mm) "teak-look" surface base only
161004	Gas spring set-"teak-look" surface bases	164034	3"(76mm) plug/cap/cover
161003	Non-gas high/low set-silver coated surface bases	164035	2-3/8"(60mm) plug/cap/cover
161006	Non-gas high/low set-"teak-look" surface bases	170001	2-3/8"(60mm) fluted aluminum tube*
164021	3"(76mm) silver coated surface base only	170002	3"(76mm) fluted aluminum tube*
164009	3"(76mm) "teak-look" surface base only	170003	2-3/8"(60mm) brown anodized fluted aluminum tube
164011	2-3/8"(60mm) silver coated surface base only	170004	3"(76mm) brown anodized fluted aluminum tube
164008	2-3/8"(60mm) "teak-look" surface base only		

## MOTOR MATE™

Features heavy duty anodized aluminum, powder coated white for added corrosion resistance. The unit stores in its own 31" X 6" bag. Comes with tackle and will lift anything from the dinghy to the cockpit (or vice-versa) up to 100 lbs. Great for the dinghy motor, but also good for SCUBA tanks, ice, duffel bags, groceries, etc.

The Motor Mate™ uses a Railfast® mounted ring on the rail and a "toe" on the cockpit coaming directly under the rail.

- Light-Weight, Portable, Compact
- Ideal for Lifting Outboard Motors, Sea Bags, SCUBA Gear
- Lifting Capacity: 100 lbs. (the weight, approximately, of a 15 hp. outboard)
- Works Great for Both Power Boats & Sailboats

**Boom Length: 20"**  
**Assembled Height: 54"**  
**Weight: 12 lbs.**

Part No.	Description
153100	Motor Mate™
153104	Base Mount *
153105	Rail Mount *
153130	Cam Cleat Bracket
153109	Vinyl Bag *

\*Included with MOTOR MATE™

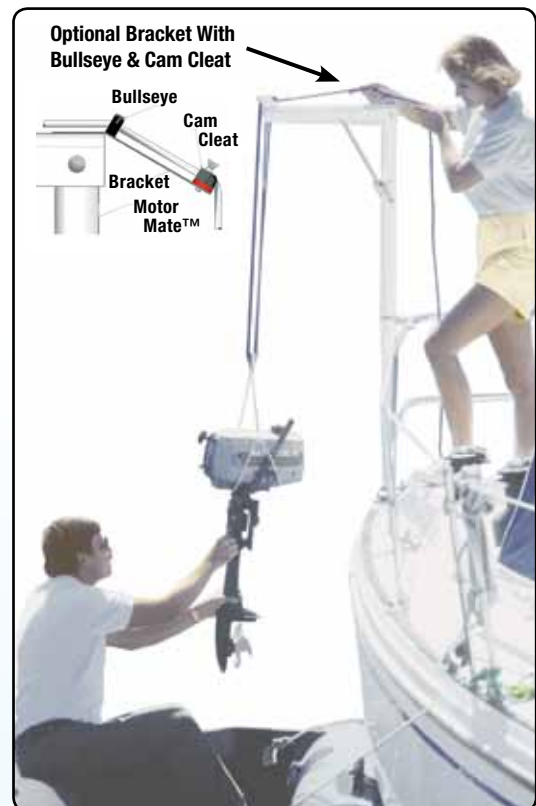

# NOVA DAVIT™

The Nova Davit™ system represents the “State of the Art” for styling and function. Versatile mounting designs assure a perfect fit with an offshore strength standard. Like all Nova products, a very high standard of finish will make the right statement about your boat. The neat folding feature stows the davit system flush with your boat’s stern. The maximum safe working load is 350 lbs. per pair (175 lbs. per arm).



**350 lbs. Safe Working Load Per Pair**



**Fits Rails from 23" to 32" High**

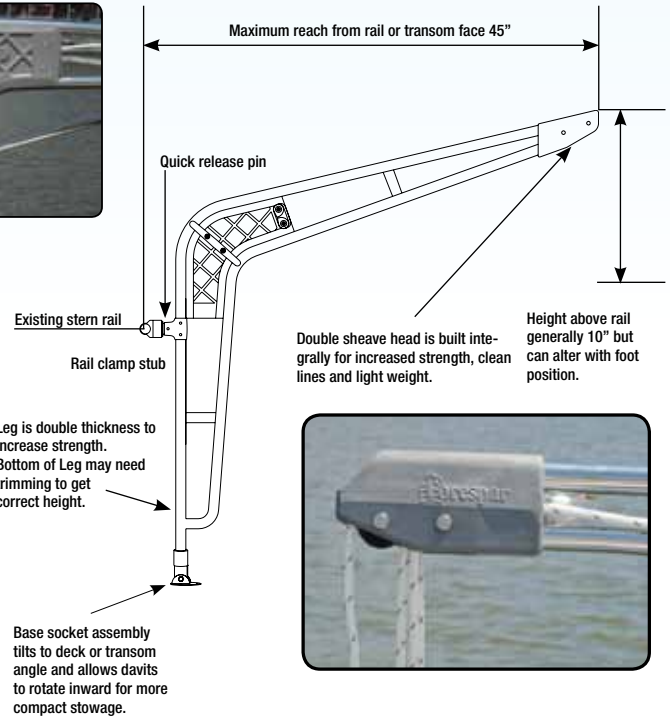

## Light Weight, Strong 316 Stainless Steel

Nova Davit™ Conveniently folds inwards to maintain boat slip length or remove them completely for stowage or racing.

Part No.	Model No.
153302	Nova Davit™
153447	Optional 1-1/4 Rail Mount Kit

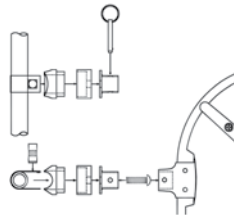

# NOVA LIFT™

Our Nova products combine elegant styling with superb strength and function. The Patented Nova Lifts use internally led purchase to keep the lifting arm centered over the load. Other brands swing left and right without control. Another valuable feature is the internal lead to your cockpit winch where you have loads of lifting power to make the job easy! No external block & tackle.

Nova Lift™ comes with a stainless steel lower mounting tube that will accommodate 30" height rails. Vessels with rails higher than 30" will require the use of a deck pad (not included) to raise the installation to the proper height.

The Nova Lift™ with winch is ideal for trawlers and motor yachts where sailboat winches are not available.

Part No.	Description
153311	Nova Lift™
153312	Nova Lift™ With Winch
153308	Outboard Motor Sling
153387	1-1/4" Rail Adaptor
153318	2-5" Optional Stand Off Bracket

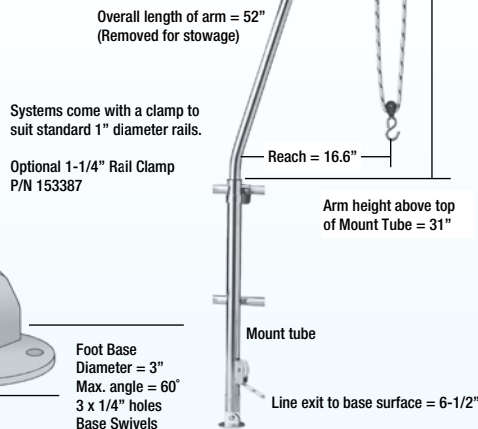

**Nova Lift™**



**Nova Lift™ With Winch**



**Stand Off Bracket**

**220 lbs. Maximum Load**

# QUIK DAVIT™

A hinged type davit system, Quik Davit quickly connects a dinghy to the back edge of almost any swim platform, allowing it to be tipped up and out of the water for easy storage without towing. The user simply snaps the pieces together to create a hinge that allows the dinghy to be pulled up onto the swim platform or transom. To release the dinghy you simply push it into the water and pull back the spring loaded easy grip release handles to unlock the connection.



**NEW**

- Safer And More Stable Dinghy Entry And Exit Point
- Solid 316 Stainless Steel And UV Resistant Composites
- Quickly Removable Davit Heads and Yokes Eliminate Tripping Hazard
- Exclusive Inflatable Adhesive Works On Both Hypalon and PVC Inflatables
- Fully Compatible With Most Weaver® System Heads & Dinghy Pads

Designed for inflatable dinghies up to 200 lbs in total weight (79 kg) and up to 11 feet (3.3 m) in length

Spring Loaded  
Easy Grip  
Release Handle



#153475

Part No.	Model
153470	Quik Davit Complete Kit (Including Heads, Pads, Adhesive, Fasteners)
153477	Fast Kit - Mounts for Davit Head Quick Removal
153475	Davit Head Kit - Includes 2 Snap Davit Heads and Fasteners
153476	Dinghy Pad Kit - Includes 2 Dinghy Pads
153492	4 oz Universal Adhesive Kit for Inflatables
153478	8 oz Universal Adhesive Kit for Inflatables



#153477

**Fast Kit for Quick Removal of Davit Heads**



#153478

## QUIK DAVIT™ HEAD RAISERS

Quik Davit heads with raised bases are used for Swim Platforms where the platform is too low to the water for normal hookup. Fits Fast Kit mount system. Sold as a pair.

Part No.	Model
153491-R1	Quik Davit Head Raiser - 1"
153491-R2	Quik Davit Head Raiser - 2"
153491-R3	Quik Davit Head Raiser - 3"
153491-R4	Quik Davit Head Raiser - 4"

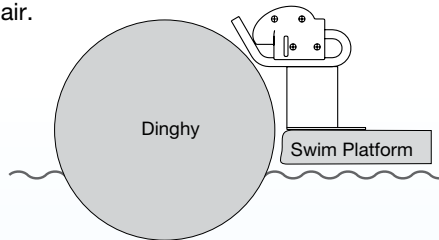

## QUIK DAVIT™ HEAD EXTENSIONS

Quik Davit heads with horizontal extension bases are used to clear curved or irregularly shaped edges of swim platforms, or to clear existing swim ladders. Fits Fast Kit mount system. Sold as a pair.

Part No.	Model
153491-E1	Quik Davit Head Extension - 1"
153491-E2	Quik Davit Head Extension - 2"
153491-E3	Quik Davit Head Extension - 3"
153491-E4	Quik Davit Head Extension - 4"

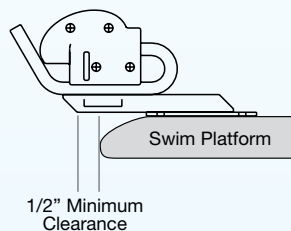

# LEISURE FURL IN-BOOM FURLING

## ADVANCED MAINSAIL MANAGEMENT™ WITH IN-BOOM MAINSAIL FURLING

Leisure Furl booms are custom made to order in the United States. Forespar is backed with 30+ years of experience and a reputation for delivering the highest quality spars and booms for the blue water cruisers and everyday sailors alike.

### Why Should I Choose Leisure Furl?

**Safety** - With all lines leading aft, Leisure Furl gives you the ability to reef and control the main from the safety of the cockpit. Leisure Furl eliminates the need for complicated lazy jacks or sending crew forward in heavy weather.

**Ease of Use** - Hoisting, furling or reefing is a one-person operation.

**Reefing** - Allows infinite reefing positions on all points of sail.

**Appearance** - The sail furls neatly and compactly into the boom, protecting the sail from harmful ultraviolet rays. Each boom is elegantly tapered for good looks and weight-savings.

## SAIL-SHAPING ADVANTAGES OF LEISURE FURL

**1** Leisure Furl's built-in controls ensure that sail shape is maximized when at full hoist or furled. They allow for efficient and uncompromising performance from all points of sail and enable infinite reefing positions.

**2** Leisure Furl allows mainsail control at any point of hoist. A perfect sail shape is ensured by the built-in sail controls.

**3** Leisure Furl offers complete control over foot shape and luff tension, without the need of a cunningham or outhaul. Full-length battens give shape and power to even an old sail.

**4** Leisure Furl enables a full roach in most cases, as opposed to the hollow cut leeches of most in-mast systems.

*Able To Accommodate Large Roach  
Mainsails As Used On Multihulls.*



**NEW**

## IN-MAST TO IN-BOOM FURLING LEISURE FURL CONVERSION KITS

Not happy with the performance of your current in-mast furling system? We can now convert your existing in-mast system to our state-of-the art Leisure Furl In-Boom mainsail furler with a custom conversion kit. Each conversion kit is custom designed, so contact us for further details.



# LEISURE FURL OFFSHORE SYSTEM

## THE SMART CHOICE FOR BOATS 33' - 80'

Over 4,000 systems in use, making ocean passages all over the world in all sea conditions. After 15 years of development, Leisure Furl is a highly efficient, safe and simple method of reefing and controlling the mainsail. The Forespar Leisure Furl is developed, marketed and built by a spar builder of the highest reputation. We have been building spars in the U.S. for over 40 years.

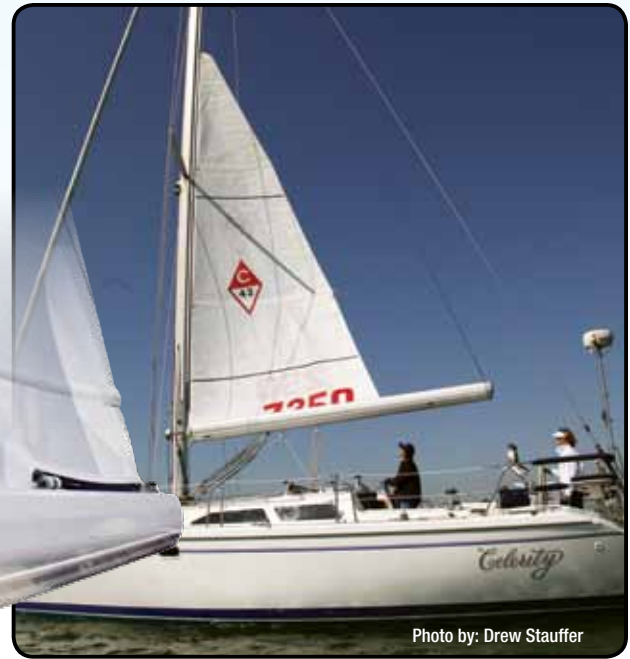

Photo by: Drew Stauffer

*When I ordered my new Catalina 42 this spring, I investigated boom-furling systems. I quickly learned that Leisure Furl is the leader. I have not been disappointed in my choice. Our Leisure Furl boom reefs and furls beautifully and the tapered profile is very good looking.*

Sincerely,  
Cal Marks (Marina del Rey)

### Leisure Furl™ Options Include

- Aluminum Construction
- Carbon Fiber Construction
- Hydraulic or Electric Drive
- Anodized or painted in any Awlgrip® Color

## Leisure Furl™ FEATURES

- Each boom is custom engineered and fabricated for your boat
- Each boom is elegantly tapered for attractiveness and weight savings
- Easily fitted to an existing mast without the need to unstep your mast
- Spar grade 6005 T5 heat treated aluminum alloy extrusions for superior strength
- All gooseneck fittings are high-strength 17-4 investment cast stainless steel



### Built-in Sail Cover

Each Leisure Furl™ boom comes standard with a built-in sail cover for convenience and ease of handling. The Sunbrella® sail cover protects the sail from the harmful elements.



### Manual Override

Each offshore system has a built-in manual backup in case of halyard or furling line failure. Winch handle control is easily accomplished at the mast. The internal ratchet allows the system to be locked in place for long passages.



### Load Bearing Points

Leisure Furl's unique design offers 3 separate load bearing points. The mainsail and boom loads are distributed primarily to the mandrel and drive shaft bearing while the mainsheet and vang loads are carried by the gooseneck fitting.



**SAILKOTE**  
RECOMMENDED  
FOR LUFF TRACK  
AND BOLT ROPE AP-  
PLICATIONS

## NEW Electric Leisure Furl™

With Electric Leisure Furl you can safely and easily hoist, furl and stow your mainsail with the push of a button.



### Leisure Furl™ CONVENIENCE

Remove Sail Cover & Ties and Stow Away  
Lower and Flake the Sail  
Tie Sail and Replace the Sail Cover

### Conventional Boom

15 minutes  
10 minutes  
15 minutes

### Leisure Furl™

30 seconds  
90 seconds  
30 seconds

# LEISURE FURL COASTAL SYSTEM

## HEAVY WEATHER IN-BOOM FURLING & REEFING FOR SAILBOATS 26'-33'

The Leisure Furl Coastal System offer smaller boats (26' - 33') the safety and convenience of In-Boom mainsail handling in a system specifically designed and sized to boats of this size.

Derived from our Leisure Furl family of big boat offshore furling and reefing booms, our Coastal model boom incorporates exceptional drive and universal technology with a minimum of moving parts. This powerful boom system incorporates an end boom drive system with a minimum of moving parts which is effective for smaller boat applications. Our Offshore, through the mast, drive system is used on more powerful mainsails on boats from 35 ft – 85 ft.

The aft drive mandrel uses fiber impregnated composite bearings similar to those used in the construction of big boat high load blocks. The forward universal allows complete freedom of rotation under the highest loads.

- **Five Year Limited Warranty**
- **Easily Fitted To An Existing Mast**
- **Custom Engineered For Your Boat**
- **Controllable Sail Shape**
- **Tapered for Attractiveness And Weight Savings**
- **Available in Carbon Fiber or Aluminum**



### Enjoy the Same Safety of In-Cockpit Mainsail Reefing & Handling Used by Larger Boats

Maximum Coastal System luff length (P) is 40' and maximum foot length (E) is 14'



*Our Leisure Furl Coastal, in boom, mainsail-furling system has been installed on our Catalina 30 for approximately six months now. We could not be more pleased.*

*The system has worked flawlessly from the day it was installed. It has given us the confidence to sail short-handed in conditions where we would have hesitated with a conventional reefing system. My wife especially likes not having to deal with the sail ties and the dirty mainsail cover.*

*The design, engineering and production quality of the Leisure Furl Coastal system is better than other systems that we looked at.*

## LEISURE FURL™ COASTAL SYSTEMS FEATURE



Catalina 30

### Hand Crafted Boom

Each boom is custom made at our plant in Southern California by professional riggers. The boom is tapered for refined styling and weight savings.



Morris 36

### Luff System

Leisure Furl™ uses high modulus PVC luff track.



### Reinforced Entry

Each Forespar Leisure Furl has an additional stainless steel frame at the front of the boom. This reinforces the already tough aluminum section.



### Built-in Sail Cover

Each Leisure Furl™ boom comes standard with a built-in sail cover for convenience and ease of handling. The Sunbrella® cover protects the sail.



# CUSTOM MASTS AND BOOMS

CUSTOM OR REPLACEMENT BOOMS AND SPARS FOR ALMOST ANY BOAT



## OFFSHORE • COASTAL • RACING

Forespar® builds superior quality aluminum and carbon fiber spar systems for builders of the finest yachts, worldwide. Our sales department establishes the customer relationship, develops the order and serves as the conduit for information during the project.

Engineering develops the design data using CAD systems and several proprietary computer programs to optimize the spar system. The manufacturing team then fabricates the spars in conjunction with a multilevel quality control system. The spar systems are finished using Awlgrip marine coatings, then assembled using the high quality components that our customers demand.

After passing the final inspection, the spars are packaged to be shipped anywhere in the world.

The result of the process is superior reliability and function for the offshore or casual sailor.

## ALUMINUM OR CARBON CONSTRUCTION

Hylas 70  
Mast & Leisure  
Furl Boom



## OVER 40 YEARS OF MAST AND BOOM BUILDING EXPERIENCE

Nantucket Splinter Custom  
Carbon Boom



Schock 40  
Carbon Mast

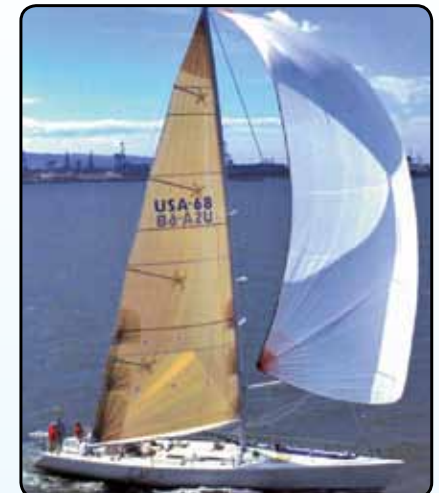

# MARELUBE™ MARINE LUBRICANTS

MareLube™ is Forespar's new family of three specifically formulated synthetic lubricants designed for various uses around your boat. Each contains PTFE and they work equally well in fresh or salt water. The family includes MareLube™ TEF 45™ for heavy wet use locations, MareLube™ EXTRA for general purpose lubrication needs, and MareLube™ Valve for marine valves and plumbing systems.

- Long Lasting PTFE Synthetic Lubrication
- Safe On Rubber, Plastic and Painted Surfaces
- Works Equally Well In Fresh Or Salt Water
- Formulated For Specific Uses For Maximum Effectiveness

## MARELUBE™ VALVE



### MareLube™ Valve Lubricant

MareLube Valve Lubricant is an advanced lubrication formula designed to keep valve seals and balls working smoothly in marine plumbing systems. It is a clear, non-staining and nontoxic lube that is perfect for traditional bronze fittings, as well as all composite plumbing fixtures like Forespar's Marelon® parts.

Part No	Description
770050	4 oz MareLube Valve Lubricant

### MareLube™ REACH Valve Lubricant

Proper lubrication is essential for all your boat's valves. Forespar's New MareLube™ REACH Kit offers an easy way to lubricate those hard-to-reach valves using a pre-loaded syringe of MareLube Valve lubricant and extension tube.

MareLube REACH kit includes: pre-loaded application syringe, extension hose and applicator brush.



Part No	Description
770049	MareLube REACH Kit



### MareLube™ Valve Liquid

Liquid MareLube Valve Lubricant is a non-toxic, biodegradable formula that can be conveniently poured directly into your drain system to lubricate your valves and seacocks without disassembly.

Available in an easy-pour 16oz bottle.

Part No	Description
770055	16 oz Liquid MareLube Valve Lubricant

# MARELUBE™ EXTRA

## MareLube™ Extra - General Purpose Lube

MareLube EXTRA is a great general-purpose marine lubricant perfect for those common uses around the boat. From hatches to sliding doors, EXTRA provides a long-lasting and water resistant PTFE lubrication barrier that controls rust and bi-metal corrosion. Available in 4oz jars, EXTRA is the perfect onboard lubricant to keep things working smoothly.



Part No	Description
770056	4 oz MareLube Extra

# MARELUBE™ TEF45™

MareLube™ TEF 45™ is a highly water-resistant synthetic lubricant grease containing 45% PTFE. This is the highest percentage PTFE available, which makes TEF 45™ perfect for heavy loads and bi-metal anti-corrosion applications like turnbuckles, spar fittings and motor lower units. TEF 45™ also works well at protecting against rust corrosion and anti-seize applications.



## MareLube™ TEF45™

MareLube TEF 45 is a long-lasting lubrication paste that is perfect when you need a heavy-duty lubricant that can withstand high-load use in wet locations. Available in either 4oz or 16oz jars.

Part No	Description
770067	4 oz MareLube TEF45
770068	16 oz MareLube TEF45

## MareLube™ TEF45™ Pre-Loaded Syringe Packs

Convenient pre-loaded syringe packs work great for those hard-to-reach applications where injection is needed. Available in 30cc and 6cc sizes - applicator brush included.

Part No	Description
770065	6cc MareLube TEF45 Syringe Pack
770066	30cc MareLube TEF45 Syringe Pack

## MareLube™ TEF45™ Large Quantity Packages

MareLube TEF45 is also available in large quantity packages ranging from the 12 oz caulk tube to the 40 lbs bucket, these high quantity packages are great for large jobs and OEM applications.



Part No	Description
770170	MareLube TEF 45 - 12 oz Caulk Tube
770171	MareLube TEF 45 - 8 lbs Pail
770172	MareLube TEF 45 - 40 lbs Bucket

# REFRESH™ DEODORIZERS

ReFresh™ is Forespar's family of all natural, environmentally safe cleaners and deodorizers that are specially formulated to work on tough marine based odors. Guaranteed to work, each of these modern green products is specifically formulated using naturally biodegradable ingredients to create effective, non-toxic alternatives to traditional chemical based cleaners. The new ReFresh™ family includes three specially formulated, non-diluted marine strength products for your most frequent needs.

- Non-Toxic and Biodegradable
- Naturally Attacks Odor Source
- Not A Cover-Up Fragrance



## ReFresh™ Head & Tank Deodorizer

A non-toxic and biodegradable marine head and waste tank treatment that can be directly poured into the system by flushing. It naturally eliminates odor sources for up to 4 months. Safe on bronze or Marelon plumbing systems. One ounce treats a 20-gallon tank.

## ReFresh™ Cleanup Concentrate

General-purpose marine grade deodorizer for cleanup or wash-down. It permanently eliminates odors by naturally attacking the source. Removes common boat odors such as bilge, fish, head and vomit, and can be used on almost any surface including fabric. Also works on gas and oil. Non-staining. 16 ounce bottles makes 10 quarts.

Part No	Description
770064	8 oz ReFresh Atomizer Spray Deodorizer
770063	16 oz ReFresh Head & Tank Deodorizer



Product Picture Not Available at Press Time

## Eco-Tank™ Holding Tank Treatment

ECO-Tank Pro holding tank treatment is a totally biodegradable, oxygen bearing bio stimulant. It rapidly stimulates aerobic capacity to eliminate waste, odor, and solid matter and tissue. Very effective, fast acting and well proven in marine heads.

Part No	Description
770270	70 Crystals Packets

# TEA TREE POWER® DEODORIZERS

## Marine Grade Odor Eliminators

Tea Tree Power™ is the all-natural marine grade odor eliminator containing a proprietary blend of 100% Australian Tea Tree Oil and other natural ingredients. Its powerful, yet pleasant smelling vapors, diffuse throughout your cabin and lockers, attacking and eliminating the source of unpleasant odors caused by mold, mildew, and bacteria.

## Tea Tree Power® Gel

Slowly evaporates to provide continuous, natural, and long-lasting odor control for up to 3 months. It penetrates deep into porous materials (cushions, carpets, and upholstery) delivering a deep cleaning with enduring odor protection.

## Tea Tree Power® Spray

Not a cover-up fragrance, Tea Tree Power Spray starts controlling odors on contact providing continuous, natural, and long-lasting odor control for up to 3 months. It penetrates porous materials (cushions, carpets, and upholstery) delivering a deep cleaning with enduring odor protection.



Part No	Description
770201	Tea Tree Power 2oz Gel
770202	Tea Tree Power 4oz Gel
770203	Tea Tree Power 8oz Gel
770204	Tea Tree Power 16oz Gel
770207	Tea Tree Power 8oz Spray
770205	Tea Tree Power Refill - 22oz
770206	Tea Tree Power Refill - 44oz





*MARINE GRADE COMPOSITE PLUMBING*

*U.L. APPROVED & ISO CERTIFIED*

*ABOVE AND BELOW WATERLINE*



# **MARELON®**

*COMPOSITE PLUMBING PARTS*

# MARELON® MARINE PLUMBING

## COMPOSITE, NON-CORROSIVE MARINE PLUMBING SYSTEM

Marelon® is the modern material for marine plumbing systems. Its non-corrosive proprietary formulation of polymer composite compounds uses a resins and additives to produce a superior marine-grade product that will not deteriorate like traditional bronze marine plumbing parts.

- For Use Above And Below Waterline
- Compatible With Traditional Bronze Fittings
- Precision Molded Plumbing Systems
- Complete Freedom From Corrosion
- U.L. Approved & ISO Certified
- A.B.Y.C. Compliant



The temperature range of Marelton® is: -40° F to +176° F or -40° C to +80° C

## TYPICAL INSTALLATIONS

### TYPICAL HEAD

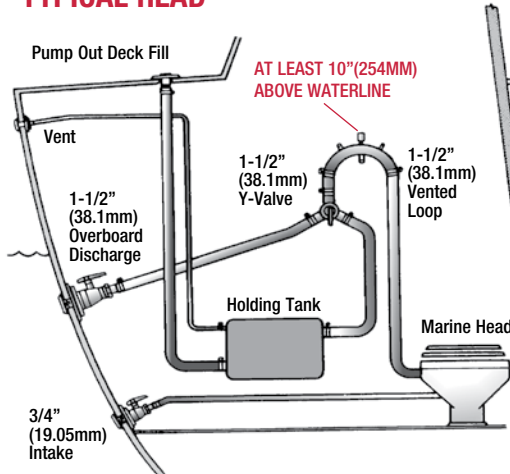

### SINK DRAIN

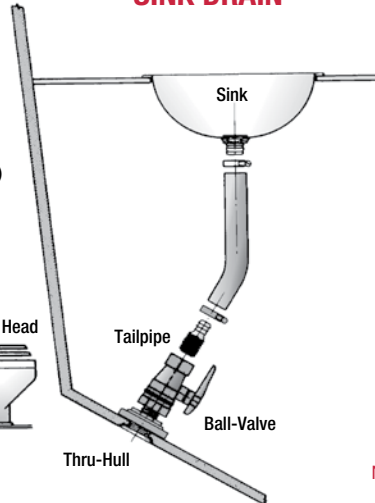

### COCKPIT DRAIN

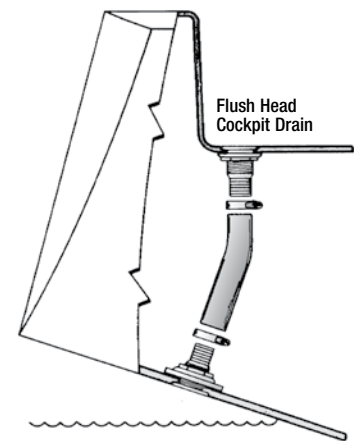

NOTE: IF A THRU-HULL IS TO BE INSTALLED LESS THAN 6" (152.4mm) ABOVE WATERLINE, A BALL-VALVE OR SEACOCK MUST ALSO BE USED.

## A WORD ON THREAD FORMS

### Industrial vs Marine

Industrial or household fittings typically use the NPT (National Pipe Tapered) tapered thread. The marine valves, thru-hulls, tailpipes and seacocks used in boats employ the NPSM (National Pipe Straight Mechanical) parallel thread form. Tapered industrial fittings are not intended to be joined with parallel marine fittings.

### Marelton® Valves and Fittings

Almost all Marelton® valves, thru-hulls and fittings use NPSM parallel thread forms that require thread compound or Teflon® tape to seal. There are two exceptions to using parallel threads in Marelton®. Our Marelton® "93 Series" plumbing system comes standard with buttress threaded thru-hulls that mate to buttress threaded valves. And our Marelton® "HC Series" line of reducing tailpipes all employ true NPT tapered threads.

### British vs United States Parallel Thread Standards

The American NPSM parallel thread standard has a thread flank angle of 60°. The British Standard Pipe, or BSP standard for parallel threads has a thread flank angle of 55°. Identification can also be made by inspecting the root and crest of the threads. The truncation of the root and crest of American standard threads are flat. The truncation of the root and crest of British standard threads are round.

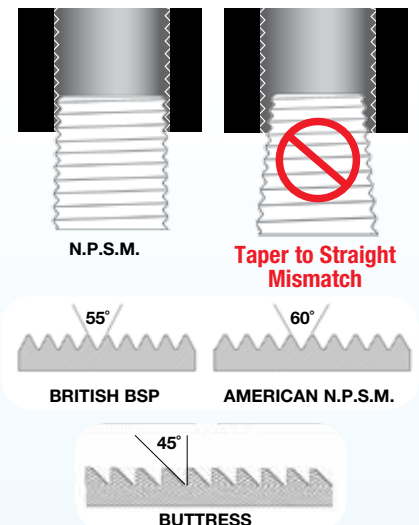

**LIMITED WARRANTY**  
Forespar® accepts no responsibility for valve or thru-hull components which are improperly installed, tampered with or have inadequate access for service and maintenance.

# FLANGE MOUNTING SEACOCKS

Forespar's Flange Mounted Seacocks made with Marelon® offer superior strength and corrosion resistance compared to conventional bronze type valves. Strong, lightweight, corrosion and electrolysis free, they make the ideal thru-hull valve.

Available in most common sizes and thread configurations, Marelon Seacocks can be used as replacement valves for most existing marine thru-hull fittings.



MF 849

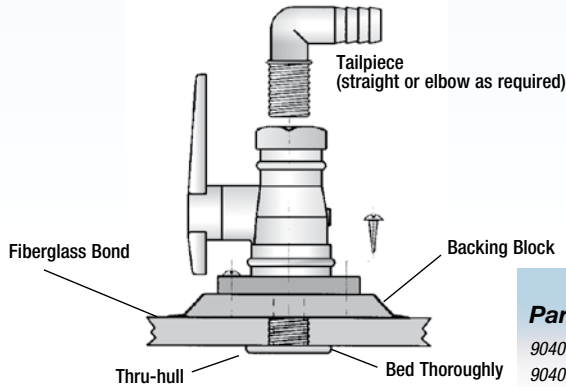

Part No.	Model No.	Thread Size	Height	Height w/Handle	Base
904009	MF 849 1/2	1/2"(12.7mm)	3"(76.2mm)	4"(101.6mm)	3"(76.2mm)
904010	MF 849 3/4	3/4"(19.05mm)	3"(76.2mm)	4"(101.6mm)	3"(76.2mm)
904011	MF 849 1-1/2	1-1/2"(38.1mm)	5"(127mm)	8"(203.2mm)	6"(152.4mm)

# MF 850 BALL VALVES

Forespar's MF 850 series of Ball Valves are precision molded in high strength Marelon®. Their great strength, light weight, and complete freedom from corrosion and electrolysis make them the ideal valve for controlling inlet and outlet water requirements above and below the waterline.

Our engineers opened and closed one of our 3/4"(19.05mm) valves 11,000 times, then submerged it in water with an air line pressurized to 40 p.s.i. connected to it. The result was an absolutely leak free condition with no evidence of internal seal wear. Valves sold throughout the U.S.A. have parallel marine type threads. If specified, B.S.P. are available outside of America.



MF 850

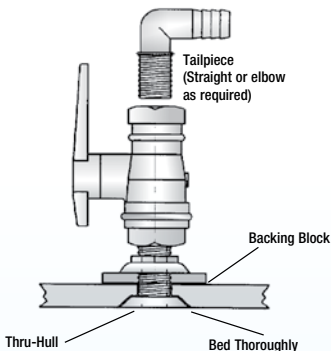

Part No.	Model No.	Thread Size	Body Dia.	Body Length	Length w/Handle
905100	MF 850 1/2"	1/2"(12.7mm)	1-7/8"(47.62mm)	3"(76.2mm)	4"(101.6mm)
905101	MF 850 3/4"	3/4"(19.05mm)	1-7/8"(47.62mm)	3"(76.2mm)	4"(101.6mm)
905102	MF 850 1"	1"(25.4mm)	2-3/4"(69.85mm)	4-3/4"(120.65mm)	5-1/2"(139.7mm)
905103	MF 850 1"-1/4"	1-1/4"(31.75mm)	2-3/4"(69.85mm)	4-7/8"(123.82mm)	5-3/4"(146.05mm)
905104	MF 850 1"-1/2"	1-1/2"(38.1mm)	3-1/2"(88.9mm)	5"(127mm)	7-1/2"(190.5mm)
905105	MF 850 2"	2"(50.08mm)	4-1/4"(107.95mm)	5-7/8"(149.22mm)	8"(203.2mm)



## VALVE MAINTENANCE WITH MARELUBE:

All our valves are non-corrosive, but like any moving part in a marine environment, they require regular inspection and lubrication. Do not fail to actuate the handle and lubricate the seals on a regular schedule.

For proper and easy valve lubrication, we recommend our new MareLube Reach valve lubrication kit. It allows you to inject the correct lubrication directly onto the valve's moving parts using a pre-loaded syringe and extension tube. Water pump grease or mineral oil can also be used if necessary.

MareLube REACH Kit - 770049 - See Page 32



# THRU-HULL CONNECTORS

Forespar® series of Thru-Hull Connectors are precision molded in high strength Marelon®. Their great strength, light weight and complete freedom from corrosion and electrolysis make them the ideal Thru-Hull Connectors for use above or below the waterline. All Thru-Hull Connectors must be installed with proper bedding compound. We recommend a maximum torque setting of 20 lb/ft. for Series 250, Series 251 and Series 253 Thru-Hull Connectors.

THE 'S' NOTATION IN MODEL NUMBERS (EG. CF 250S 1/2), INDICATES A THRU-HULL THAT HAS BEEN FITTED WITH A SCREEN.

## 250 SERIES

FULL THREADED/FLUSH HEAD



Part No.	Model No.	Thread Size	Length
906000	CF 250 1/2	1/2"(12.7mm)	2"(50.8mm)
906001	CF 250S 1/2	1/2"(12.7mm)	2"(50.8mm)
906002	CF 250 3/4	3/4"(19.05mm)	2.25"(57.15mm)
906003	CF 250S 3/4	3/4"(19.05mm)	2.25"(57.15mm)
906004	CF 250 1	1"(25.4mm)	2.375"(60.32mm)
906005	CF 250S 1	1"(25.4mm)	2.375"(60.32mm)
906006	CF 250 1-1/4	1-1/4"(31.75mm)	3"(76.2mm)
906007	CF 250S 1-1/4	1-1/4"(31.75mm)	3"(76.2mm)
906008	CF 250 1-1/2	1-1/2"(38.1mm)	3"(76.2mm)
906009	CF 250S 1-1/2	1-1/2"(38.1mm)	3"(76.2mm)

'S' DENOTES SCREENED

## 251 SERIES

FULL THREADED MUSHROOM HEAD



Part No.	Model No.	Thread Size	Length
906010	CF 251 1/2	1/2"(12.7mm)	2"(50.8mm)
906011	CF 251S 1/2	1/2"(12.7mm)	2"(50.8mm)
906012	CF 251 3/4	3/4"(19.05mm)	2.25"(57.15mm)
906013	CF 251S 3/4	3/4"(19.05mm)	2.25"(57.15mm)
906014	CF 251 1	1"(25.4mm)	2.375"(60.32mm)
906015	CF 251S 1	1"(25.4mm)	2.375"(60.32mm)
906016	CF 251 1-1/4	1-1/4"(31.75mm)	3"(76.2mm)
906017	CF 251S 1-1/4	1-1/4"(31.75mm)	3"(76.2mm)
906018	CF 251 1-1/2	1-1/2"(38.1mm)	3"(76.2mm)
906019	CF 251S 1-1/2	1-1/2"(38.1mm)	3"(76.2mm)
906020	CF 251 2	2"(50.8mm)	3"(76.2mm)
906021	CF 251S 2	2"(50.8mm)	3"(76.2mm)

'S' DENOTES SCREENED

## 253 SERIES

HOSE TAILPIPE/MUSHROOM HEAD



Part No.	Model No.	Hose I.D.
906022	CF 253 1/2	1/2" - 5/8"(12.7 - 15.87mm)
906023	CF 253S 1/2	1/2" - 5/8"(12.7 - 15.87mm)
906024	CF 253 3/4	3/4"(19.05mm)
906025	CF 253S 3/4	3/4"(19.05mm)
906026	CF 253 1	1"(25.4mm)
906027	CF 253S 1	1"(25.4mm)
906070	CF253 1-1/8	1-1/8"(28.57mm)
906071	CF253S 1-1/8	1-1/8"(28.57mm)
906028	CF 253 1-1/4	1-1/4"(31.75mm)
906029	CF 253S 1-1/4	1-1/4"(31.75mm)
906030	CF 253 1-1/2	1-1/2"(38.1mm)
906031	CF 253S 1-1/2	1-1/2"(38.1mm)
906032	CF 253 2	2"(50.8mm)
906033	CF 253S 2	2"(50.8mm)

'S' DENOTES SCREENED

## THRU-HULL MEASUREMENTS

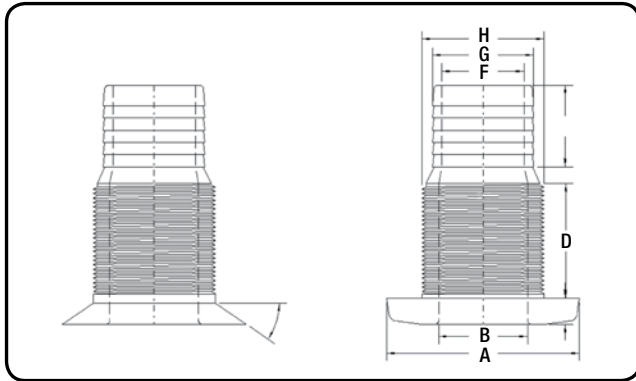

## FLUSH HEAD DRAIN



Part No.	Model No.	Thread Size & Hose I.D.	Thread Length
906038	CF254 1-1/4	1-1/4"(31.75mm)	1 3/4"(44.45mm)
906036	CF 254 1-1/2	1-1/2"(38.1mm)	1 3/4"(44.45mm)
906037	CF 254S 1-1/2	1-1/2"(38.1mm)	1 3/4"(44.45mm)
906034	CF 254 2	2"(50.8mm)	1 3/8"(34.92mm)
906035	CF 254S 2	2"(50.8mm)	1 3/8"(34.92mm)
906039	CF 254 1-5/8	1-5/8"(41.27mm)	1 3/8"(34.92mm)

'S' DENOTES SCREENED

## CORRESPONDING DIMENSION FROM ABOVE DRAWING

SERIES	A	B	C	D	E	F	G	H
<b>250</b>								
1/2"(12.7mm)	2.375(60.32mm)	.430(10.92mm)	.335(8.5mm)	2.000(50.8mm)	N/A	N/A	N/A	.810(20.57mm)
3/4"(19.05mm)	2.430(61.72mm)	.665(16.89mm)	.320(8.1mm)	2.250(57.15mm)	N/A	N/A	N/A	1.015(25.78mm)
1"(25.4mm)	2.835(72mm)	.875(22.22mm)	.320(8.1mm)	2.375(60.32mm)	N/A	N/A	N/A	1.285(32.63mm)
1-1/4"(31.75mm)	2.820(71.63mm)	1.115(28.32mm)	.325(8.25mm)	3.000(76.2mm)	N/A	N/A	N/A	1.635(41.52mm)
1-1/2"(38.1mm)	2.562(65.07mm)	1.380(35.05mm)	.320(8.1mm)	3.000(76.2mm)	N/A	N/A	N/A	1.850(46.99mm)
<b>251</b>								
1/2"(12.7mm)	1.500(38.1mm)	.448(11.37mm)	.256(6.5mm)	2.125(53.97mm)	N/A	N/A	N/A	.810(20.57mm)
3/4"(19.05mm)	2.084(52.93mm)	.690(17.52mm)	.335(8.5mm)	3.093(78.56mm)	N/A	N/A	N/A	1.028(26.11mm)
1"(25.4mm)	2.345(59.56mm)	.880(22.35mm)	.288(7.31mm)	2.400(60.96mm)	N/A	N/A	N/A	1.282(32.56mm)
1-1/4"(31.75mm)	2.650(67.31mm)	1.110(28.19mm)	.345(8.76mm)	2.950(74.93mm)	N/A	N/A	N/A	1.615(41.02mm)
1-1/2"(38.1mm)	2.940(74.67mm)	1.360(34.54mm)	.345(8.76mm)	2.950(74.93mm)	N/A	N/A	N/A	1.850(46.99mm)
<b>253</b>								
1/2"(12.7mm)	1.506(38.25mm)	.505(12.82mm)	.265(6.73mm)	1.490(37.84mm)	.975(24.76mm)	.439(11.15mm)	.657(16.68mm)	.812(20.62mm)
3/4"(19.05mm)	2.100(53.34mm)	.670(17.01mm)	.325(8.25mm)	1.677(42.59mm)	1.028(26.11mm)	.535(13.58mm)	.770(19.55mm)	1.015(25.78mm)
1"(25.4mm)	2.350(59.69mm)	.958(24.33mm)	.295(7.49mm)	1.695(43.05mm)	1.085(27.55mm)	.797(20.24mm)	1.015(25.78mm)	1.280(32.51mm)
1-1/4"(31.75mm)	2.675(67.94mm)	1.194(30.32mm)	.327(8.3mm)	1.818(46.17mm)	1.280(32.51mm)	1.021(25.93mm)	1.273(32.33mm)	1.615(41.02mm)
1-1/2"(38.1mm)	2.933(74.49mm)	1.350(34.29mm)	.345(8.76mm)	1.875(47.62mm)	1.280(32.51mm)	1.258(31.95mm)	1.530(38.86mm)	1.850(46.99mm)
2"(50.8mm)	3.511(89.17mm)	1.842(46.78mm)	.375(9.5mm)	1.875(47.62mm)	1.350(34.29mm)	1.610(40.89mm)	2.018(51.25mm)	2.320(58.92mm)
<b>254</b>								
1-1/4"(31.75mm)	2.805(71.24mm)	1.164(29.56mm)	.316(8.02mm)	1.500(38.1mm)	1.280(32.51mm)	.945(24mm)	1.260(32mm)	1.615(41.02mm)
1-1/2"(38.1mm)	2.805(71.24mm)	1.406(35.71mm)	.316(8.02mm)	1.500(38.1mm)	1.280(32.51mm)	1.115(28.32mm)	1.475(37.46mm)	1.850(46.99mm)
2"(50.8mm)	3.525(89.53mm)	1.672(42.46mm)	.325(8.25mm)	1.500(38.1mm)	1.300(33.02mm)	1.480(37.59mm)	2.018(51.25mm)	2.320(58.92mm)



# TAILPIPES / HOSE CONNECTORS

Our Tailpipes are also made from high-strength glass-reinforced Marelon®. Perfect choice for joining hose lines to Forespar® Ball Valves and Seacocks.

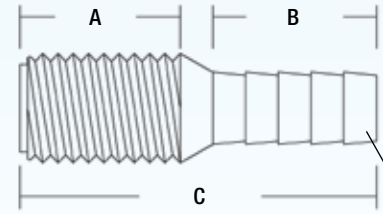

## TAPERED PIPE THREADS

Clear View Tailpipes & Hose Connectors

Part No.	Model No.	Thread Size	Tailpipe Dia.	A	B	C
905006	CF 252 1/2	1/2"(12.7mm)	5/8"(15.87mm)	1"(24.4mm)	1"(24.4mm)	2-1/4"(57.15mm)
905007	CF 252 3/4	3/4"(19.05mm)	3/4"(19.05mm)	1"(24.4mm)	1"(24.4mm)	2-3/8"(60.32mm)
905008	CF 252 1	1"(24.4mm)	1"(24.4mm)	1-1/2"(38.1mm)	1-1/16"(26.98mm)	2-7/8"(73.02mm)
905009	CF 252 1-1/4	1-1/4"(31.75mm)	1-1/4"(31.75mm)	1-5/8"(41.27mm)	1-1/4"(31.75mm)	3-1/4"(82.55mm)
905010	CF 252 1-1/2	1-1/2"(38.1mm)	1-7/16"(36.51mm)	1-7/16"(36.51mm)	1-1/8"(28.57mm)	2-5/8"(66.67mm)
905011	CF 252 2	2"(50.8mm)	2"(50.8mm)	1-11/16"(42.88mm)	1-1/4"(31.75mm)	3-1/4"(82.55mm)
905016	CF 252 1-1/8	1"(24.4mm)	1-1/8"(28.57mm)	1"(24.4mm)	1-1/16"(26.98mm)	2-7/8"(73.02mm)
905017	CF 252 1-1/2	1-1/2"(38.1mm)	1-1/4"(31.75mm)	1-7/16"(36.51mm)	1-1/4"(31.75mm)	2-5/8"(66.67mm)

Part No.	Model No.	Thread For Size	Tube I.D.
910146	HC 4x4	1/4"(6.35mm)	1/4"(6.35mm)
910147	HC 4x5	1/4"(6.35mm)	5/16"(7.93mm)
910148	HC 4x6	1/4"(6.35mm)	3/8"(9.52mm)
910149	HC 4x8	1/4"(6.35mm)	1/2"(12.7mm)
910150	HC 6x6	3/8"(9.52mm)	3/8"(9.52mm)
910154	HC 6x8	3/8"(9.52mm)	1/2"(12.7mm)
910156	HC 8x8	1/2"(12.7mm)	1/2"(12.7mm)
910157	HC 8x12	1/2"(12.7mm)	3/4"(12.7mm)
910158	HC 12x8	3/4"(19.05mm)	1/2"(12.7mm)
910159	HC 12x12	3/4"(19.05mm)	3/4"(19.05mm)
910160	HC 12x16	3/4"(19.05mm)	1"(24.4mm)
910168	HC 20x24	1-1/4"(31.75mm)	1-1/2"(38.1mm)

Add a "C" after the above part numbers for CLEAR VIEW fittings

## ELBOWS

Molded from high-strength Marelon®. Dimension 'A' indicates pipe thread size.



2 Female Threads

1 Male Threads

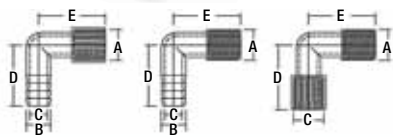

2 HECF Female/Barb

1 HECM Male/Barb

3 MEC Female/Male

Part No.	Model No.	A	B	C	D	E
1 901000	HECM 8	1/2"(12.7mm)	5/8"(15.87mm)	7/16"(11.11mm)	2"(50.8mm)	1-1/2"(38.1mm)
901001	HECM 12	3/4"(19.05mm)	3/4"(19.05mm)	1/2"(12.7mm)	2-1/8"(53.97mm)	1-5/8"(41.27mm)
901002	HECM 16	1"(24.4mm)	1"(24.4mm)	5/8"(15.87mm)	2-1/2"(63.5mm)	1-7/8"(47.62mm)
901003	HECM 20	1-1/4"(31.75mm)	1-1/4"(31.75mm)	7/8"(22.22mm)	2-3/4"(69.85mm)	2-5/16"(58.72mm)
901004	HECM 24	1-1/2"(38.1mm)	1-1/2"(38.1mm)	1-1/16"(26.98mm)	3-1/4"(82.55mm)	2-3/4"(69.85mm)
901005	HECM 32	2"(50.8mm)	2"(50.8mm)	1-1/2"(38.1mm)	3-5/8"(92.07mm)	3-1/4"(95.25mm)
901052	HECM 24/20	1-1/2"(38.1mm)	1-1/4"(31.75mm)	7/8"(22.22mm)	2-3/4"(69.85mm)	2-3/4"(69.85mm)
901053	HECM 16/16.125	1"(24.4mm)	1-1/8"(28.57mm)	29/32"(22.86mm)	2-1/2"(63.5mm)	1-7/8"(47.62mm)
2 901006	HECF 8	1/2"(12.7mm)	5/8"(15.87mm)	7/16"(11.11mm)	2"(50.18mm)	1-5/8"(41.27mm)
901007	HECF 12	3/4"(19.05mm)	3/4"(19.05mm)	9/16"(14.28mm)	2-3/16"(55.56mm)	1-3/4"(44.45mm)
901008	HECF 16	1"(24.4mm)	1"(24.4mm)	5/8"(15.87mm)	2-1/2"(63.5mm)	1-7/8"(47.62mm)
901009	HECF 20	1-1/4"(31.75mm)	1-1/4"(31.75mm)	7/8"(22.22mm)	2-3/4"(69.85mm)	2-1/2"(63.5mm)
901010	HECF 24	1-1/2"(38.1mm)	1-1/2"(38.1mm)	1-1/8"(28.57mm)	3-1/8"(79.37mm)	2-3/4"(69.85mm)
901011	HECF 32	2"(50.8mm)	2"(50.8mm)	1-9/16"(39.68mm)	3-5/8"(92.07mm)	3-1/4"(82.55mm)

Add a "C" after the above part numbers for CLEAR VIEW fittings

CLEAR VIEW not available on above

3 920207	MEC 8	1/2"(12.7mm)		1/2"(12.7mm)	1-5/16"(33.33mm)	1-7/16"(36.57mm)
920336	MEC 12	3/4"(19.05mm)		3/4"(19.05mm)	1-5/8"(41.27mm)	1-5/8"(41.27mm)

CLEAR VIEW not available on above

## FEMALE THREADED BARBED HOSE FITTING

This fitting is also made of high strength glass-reinforced Marelon®.

Part No.	Model No.
901014	1/2"(12.7mm) FPT to 1/2"(12.7mm) HOSE BARB
901015	3/4"(19.05mm) FPT to 3/4"(19.05mm) HOSE BARB
905012	1-1/2"(38.1mm) FPT to 3/4"(19.85mm) HOSE BARB
905013	1-1/2"(38.1mm) FPT to 1"(24.4mm) HOSE BARB
905015	1-1/2"(38.1mm) FPT to 1-1/8"(28.57mm) HOSE BARB
905014	1-1/2"(38.1mm) FPT to 1-1/2"(38.1mm) HOSE BARB

CLEAR VIEW not available on above



# VENTED LOOPS

Installing one of our vented loops will ensure that fluids will not siphon from tank to tank. Vented Loops are commonly used in the marine toilet system and engine cooling system. The simple valve system incorporated in the top of the loop allows air to enter the line when not in use, yet effectively seals as water or other fluid passes through. Molded in Marelon®, neither vent nor loop will corrode. The duckbill one way valve is designed to seal properly if particulate matter is present in fluids. The new MF-846 vent barb assembly option can be used in lieu of the standard MF-841 cap/duckbill. This option allows venting to the outside of the hull via a 1/4"(6.35mm) hose.

**NEW  
White Color  
Available**

Part No.	Model No.	Barb Size	Height	Width
903000	MF 840	1-1/2"(38.1mm)	5-1/4"(133.35mm)	7-3/4"(196.85mm)
903000W	MF 840 <b>White</b>	1-1/2"(38.1mm)	5-1/4"(133.35mm)	7-3/4"(196.85mm)
903001	MF 842	3/4"(19.05mm)	4-1/2"(114.3mm)	3-3/4"(95.25mm)
903001W	MF 842 <b>White</b>	3/4"(19.05mm)	4-1/2"(114.3mm)	3-3/4"(95.25mm)
903002	MF 841	Vent Cap Assembly		
903002W	MF 841 <b>White</b>	Vent Cap Assembly		
903003	MF-843	5/8"(15.87mm)	4-1/2"(114.3mm)	4"(101.6mm)
903004	MF-846	Vent Barb Assembly		
903007	MF-844	1"(25.4mm)	7"(177.8mm)	9"(228.6mm)
903007W	MF-844 <b>White</b>	1"(25.4mm)	7"(177.8mm)	9"(228.6mm)
903008	MF-845	1/2"(12.7mm)	5-1/4"(133.35mm)	4-1/4"(107.95mm)
903008W	MF-845 <b>White</b>	1/2"(12.7mm)	5-1/4"(133.35mm)	4-1/4"(107.95mm)
903018	MF-847	1-1/8"(28.57mm)	7"(177.8mm)	9"(228.6mm)
903011	MF-839	1-1/4"(28.57mm)	7"(177.8mm)	9"(228.6mm)
903011W	MF-839 <b>White</b>	1-1/4"(28.57mm)	7"(177.8mm)	9"(228.6mm)

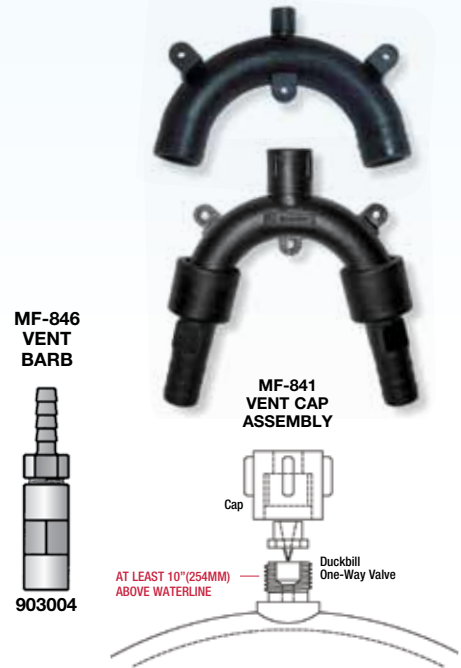

# 'Y' VALVES & CONNECTORS

Forespar® 'Y'-Valves and Connectors are molded from Marelon®. Offering an improved, stronger handle design, our valves are available in 1"(25.4mm) and 1-1/2"(38.1mm) barb size. 'Y'-Valves are an essential piece of equipment when the flow of water or other fluids are required to be conveniently diverted, as in a marine head application where a holding tank is utilized. They are easily mounted to a bulkhead. The valves are operated by a simple 120° movement. Positive stops are provided between positions. Replacement parts are available.

Our 'Y' Connectors can be used for connecting fluid lines. End plate may be removed for blockage relief etc. O-ring seal ensures leak free performance and is safe under pressure working conditions up to 40 P.S.I. Available with or without mounting flange.



### 'Y' CONNECTORS

Part No.	Model No.	Flange	Barb Size
902002	HYCF 16	Yes	1"(25.4mm)
902003	HYC 16	No	1"(25.4mm)
902004	HYCF 24	Yes	1-1/2"(38.1mm)
902005	HYC 24	No	1-1/2"(38.1mm)

### 'Y' VALVES

Part No.	Model No.	Barb Size
902000	MF 852	1-1/2"(38.1mm)
902001	MF 853	1"(25.4mm)
902006	'Y'-Valve Parts Kit (fits 1 & 1-1/2")	
902007	MF 854	3/4"(19.05mm)
902008	MF 855	1-1/8"(28.57mm)

**IT IS NOT RECOMMENDED TO INSTALL Y-VALVES BELOW THE WATERLINE**

# BULKHEAD FITTINGS

Our new Marelon Watertight Bulkhead fittings are designed to create a leak-free passageway through watertight bulkheads for plumbing and electrical wires.

Available in a wide variety of barb or thread and straight or elbow configurations, they can be adjusted for bulkhead thicknesses up to 1 1/4". Highly adaptable, they can be assembled to fit almost any space using Marelon adaptors, tailpipes, elbows, valves or standard hoses.

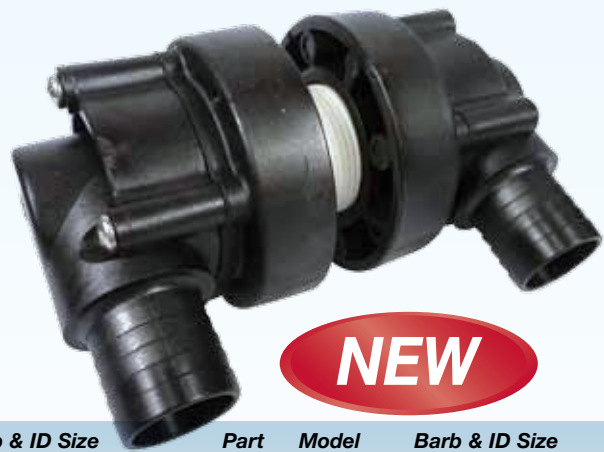

Part	Model	Barb & ID Size	Part	Model	Barb & ID Size	Part	Model	Barb & ID Size
910200	BHC	SB-SB 1/2"	910212	BHC	SB-EL 1/2"	910224	BHC	FE-SB 1/2"
910201	BHC	SB-SB 3/4"	910213	BHC	SB-EL 3/4"	910225	BHC	FE-SB 3/4"
910202	BHC	SB-SB 1"	910214	BHC	SB-EL 1"	910226	BHC	FE-SB 1"
910203	BHC	SB-SB 1-1/4"	910215	BHC	SB-EL 1-1/4"	910227	BHC	FE-SB 1-1/4"
910204	BHC	SB-SB 1-1/2"	910216	BHC	SB-EL 1-1/2"	910228	BHC	FE-SB 1-1/2"
910205	BHC	SB-SB 2"	910217	BHC	SB-EL2"	910229	BHC	FE-SB 2"
910206	BHC	EL-EL 1/2"	910218	BHC	FE-FE 1/2"	910230	BHC	FE-EL 1/2"
910207	BHC	EL-EL 3/4"	910219	BHC	FE-FE 3/4"	910231	BHC	FE-EL 3/4"
910208	BHC	EL-EL 1"	910220	BHC	FE-FE 1"	910232	BHC	FE-EL 1"
910209	BHC	EL-EL 1-1/4"	910221	BHC	FE-FE 1-1/4"	910233	BHC	FE-EL 1-1/4"
910210	BHC	EL-EL 1-1/2"	910222	BHC	FE-FE 1-1/2"	910234	BHC	FE-EL 1-1/2"
910211	BHC	EL-EL 2"	910223	BHC	FE-FE 2"	910235	BHC	FE-EL 2"

# SCOOP STRAINERS

These high-strength, high-speed strainers are also made of non-corrosive Marelon®. Two piece construction allows for greater ease in installation. Available in 3/4"(19.05mm) and 1-1/4"(31.75mm) thread sizes.

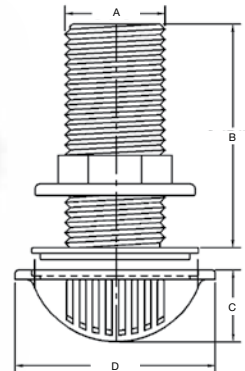

Part No.	Model No.	Thread Size	A	B	C	D
906059	MF 867 3/4	3/4"(19.05mm)	1-1/32"(26.18mm)	2-1/4"(57.15mm)	1"(25.4mm)	3-1/8"(79.37mm)
906060	MF 868 1-1/4	1-1/4"(31.75mm)	1-5/8"(41.27mm)	2-15/16"(74.42mm)	1"(25.4mm)	3-3/8"(85.72mm)
906061	MF 865 3/4	screen only			1"(25.4mm)	3-1/8"(79.37mm)
906062	MF 866 1-1/4	screen only			1"(25.4mm)	3-3/8"(85.72mm)

Screens only can be epoxied to the hull to eliminate additional holes in the gel-coat. Scoop screens can also be used over other thru-hulls (flush head styles are best) whenever a force feed is required.

# REMOTE OPERATED ROV™ VALVES

## SWITCH OPERATED VALVES OPEN AND CLOSE ON-DEMAND

Forespar® now offers remote operated ROV™ (Remote Operated Valves) to boat builders wishing to offer their customers the added convenience of remotely operating their seacocks without the need to go below, get on your knees and reach into the bilge to open or close the valves. Powerful sealed motors open or close the valve with a push of a button or flip of a switch. Contact Forespar for further information.

### OEM SALES ONLY

Part No.	Model
930145	1/2"- 3/4" valves
930146	1" - 1-1/4" valves
930147	1-1/2" - 2" valves

Please specify 12v or 24v systems

For OEM valve installations only

Ask your builder or yard to install FORESPAR ROV electric valves in your boat



# MARELON® 93 SERIES PLUMBING SYSTEMS

## COMPOSITE, NON-CORROSIVE MARINE PLUMBING SYSTEM

Marelon® is the perfect material for marine plumbing systems. Its non-corrosive proprietary formulation of polymer composite compounds uses a resins and additives to produce a superior marine-grade product that will not deteriorate like traditional bronze marine plumbing parts.

- For Use Above And Below Waterline
- Compatible With Traditional Bronze Fittings
- Precision Molded Plumbing Systems
- Complete Freedom From Corrosion
- U.L. Approved & ISO Certified
- A.B.Y.C. Compliant
- Forespar® “93” series of valves and thru-hull fittings meet all design criteria and exceed all mechanical property requirements specified by the International Standards Organization

*(ISO150/188) “Small Craft Seacocks and Thru-hull Fittings-Part 2: Non-Metallic”*



# THE MODERN SOLUTION FOR MARINE PLUMBING

## BENEFITS TO BUILDERS

- Lightweight, yet extremely strong injection-molded parts
- Complete freedom from any corrosion
- Complete freedom from electrolysis or reaction to any metals
- Outstanding operating temperature range (-22° to +176° F.)
- Uses in deck hardware (cleats, chocks) and marine plumbing
- Outstanding U.V. resistance and color fix
- Marelon® valves offer an unprecedented variety of designs
- Long term reliability



## BENEFITS TO THE BOAT OWNER

- No bonding (electrical) required
- Configurations to fit tight machinery spaces
- Minimal maintenance requirements
- Ease of installation with standard tools
- Accepts adhesives and coatings (bottom paints) easily
- Can be used on aluminum, steel, wood or FRP hull forms
- Excellent chemical resistance to harsh bilge cleaners
- Can be used with or on any metal fittings
- Long term reliability

**A.B.Y.C H-27, Seacocks, Thru-Hull Connections And Drain Plugs And ISO/DIS 9093-2 STANDARD, Small Craft - Seacocks & Thru-Hull Fittings - Non-Metallic**

**THE FORESPAR MARELON BALL VALVES AND THRU-HULL FITTINGS MEET AND EXCEED THE ABYC H-27 AND ISO 9093-2 STANDARDS AS PRESENTLY WRITTEN IN ALL RESPECTS.**

As to Physical Property Requirements:

	ABYC Standard	ISO Standard	Marelon Properties
Tensile Strength:	75mPa 10,900 psi	60mPa 9,715psi	121mPa 17,500psi
Flexural Mod.:	3480mPa 505,000psi	2700mPa 391,500psi	4826mPa 700,000psi
Impact Strength:	None	9Kj/m	117j/m
As to Strength Test:	2224N 500lbs.	1500N 337lbs.	2224N 500lbs

# FORESPAR'S® MARELON® INTEGRATED PLUMBING SYSTEM

Exceeding ABYC recommendations and meeting all UL standards; its unique design provides easy installation in a wide variety of valve configurations. It allows the OEM to design systems never before possible.

All Marelon® integrated valves are sold as a complete system. The assembly consists of thru-hull, valve body and tailpipe barb or female pipe thread end. The thru-hulls use a buttress style thread for exceptional strength and are not compatible with any other valves. Thru-hulls cannot be sold or used separately. All valves have one part number for the complete assembly. Each valve is factory assembled and pressure tested. Forespar® cannot be responsible for valves disassembled and modified or reassembled improperly.

In case of an emergency, all non-screened thru-hull style valves are supplied with a handle cap/bung that is designed to plug the thru-hull from the outside. This plug can be put in place while the vessel is in the water. The valve can then be removed from the king-nut and any blockage cleared. Warning – Never leave a boat unattended while bung is in place and valve is disassembled. This bung plug is for temporary use only. The bung can also be used during Winter storage to keep debris from collecting or insects from nesting inside thru-hull.

Per ABYC/UL requirements, a flat surface approximately the same diameter as the king-nut is needed inside the hull for proper installation. All valves are full port. The I.D. of the hose barb is carried thru the ball so there is no restriction of flow.

**Temperature Range: -40° F to +176° F, -40° C to +80° C**

## ANTI-VENTURI T-HULL

Custom tooled by Forespar®, these new thru-hulls have been tested on boats at varying rpm's and turn rates up to 45 mph. On a 3/4" generator intake line with this thru hull fitted, 0" to ~5" of vacuum was noted. This did not present a pressure situation which could potentially push water past the vanes of an older impeller and flood the cylinders or starve it of cooling water. The unique notch and lowered ramp in the leading edge (photo #1-front) provides a force-feed effect. To keep this force from overwhelming equipment impellers, the exit slot (photo #2-back) allows water flow to exit at a controlled rate. Installed and tested by the Monterey Boats team of engineers.

The new Forespar® "Anti-Venturi" head thru hull for use with the 1/2" & 3/4" Marelon® Integrated Plumbing Systems seacocks ("93" series flange style valves) is available now in 3/4". These have the Integrated Plumbing Systems buttress style thread-form to fit the Integrated System flanged seacocks only. To order this option on any flanged style Marelon® integrated valve add a "V" after the valves 6 digit part number.



**Compatible With Bronze**  
93 Series Valves Can Be Custom Ordered With NPT or BSP Threads



Front



Arrow Indicates Water Flow Direction

Part No.	Description
930171	Anti-Venturi T-Hull

## ENGINE FLUSH OUT VALVE

Engines running in salt or brackish water need to be flushed with fresh water after use to prevent costly corrosion during Winter or off-season storage. Forespar® has designed a single valve system that makes this maintenance procedure simple.



This Seacock/Y Valve configuration includes a brass garden hose connection to facilitate regular fresh water engine flushing valve includes thru-hull that must be used. A quick and easy way to flush inboard engine systems... an often difficult maintenance task.

Diameter Screened	Mushroom	Mushroom
1"(25.14mm)	931274	937474
1-1/4"(31.75mm)	931275	937475
1-1/2"(38.1mm)	931276	937476
2"(50.8mm)	931278	937478

## LOCKING HANDLE OPTION

Locking handle option for integrated Seacocks 1"(25.4mm) through 2"(50.8mm) sizes

Forespar offers an optional locking plate installed at the factory on any "93" series Integrated Seacocks. These new locking plates allow the handle to be set in the closed position and a pad-lock used to positively lock the valve closed. This new feature will satisfy the USCG requirements for locking overboard discharged head system seacocks in the closed, no discharge position.



Part No	Description
930136	Optional handle lock for 1"(25.4mm) & 1 -1 1/4"(31.75mm)
930137	Optional handle lock for 1 1/2"(38.1mm) & 2"(50.8mm)

Note: - Forespar does not supply the padlock. Valve locks are not sold separately and are not a retrofit item.

# MARELON® INTEGRATED PLUMBING SYSTEMS HOSE BARB “93” SERIES

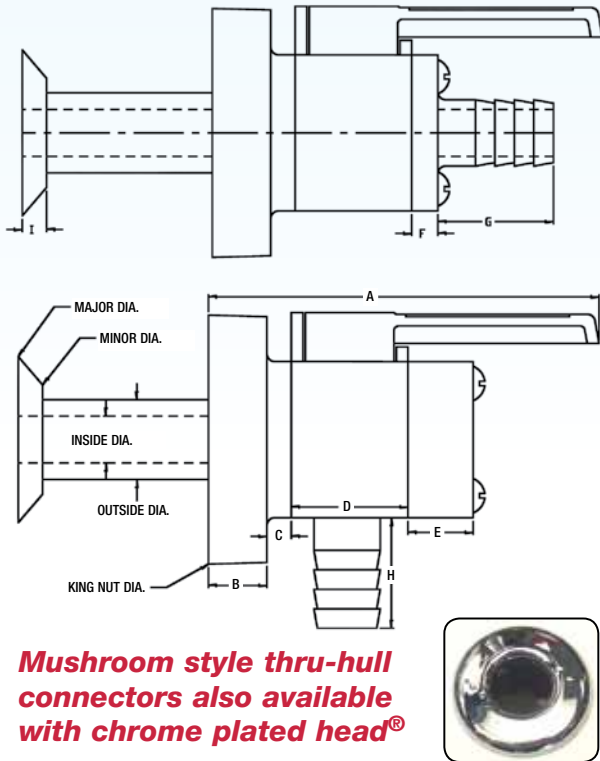

**Mushroom style thru-hull connectors also available with chrome plated head®**

DIMENSION	1/2" & 3/4" (12.7mm)&(19.05mm)	1"25 & 1-1/4" (25.4mm)&(31.75mm)	1-1/2" & 2" (38.1mm)&(50.8mm)
MAJOR DIA.	1.73(43.94mm)	2.20(55.88mm)	2.79(70.86mm)
MINOR DIA.	1.28(32.51mm)	1.70(43.18mm)	2.18(55.37mm)
OUTSIDE DIA.	1.1(27.94mm)	1.6(40.64mm)	2.1(53.34mm)
INSIDE DIA.	.62(15.74mm)	1.05(26.67mm)	1.64(41.65mm)
KING NUT DIA.	3.13(79.50mm)	3.75(95.25mm)	4.21(106.93mm)
A	4.48(113.79mm)	6.19(157.22mm)	7.63(193.80mm)
B	.91(23.11mm)	.98(24.89mm)	1.10(27.94mm)
C	.48(12.19mm)	.31(7.84mm)	.23(5.84mm)
D	1.20(30.48mm)	1.87(47.49mm)	1.57(39.87mm)
E	.52(13.20mm)	.75(19.05mm)	1.35(34.29mm)
F	.53(13.46mm)	.75(19.05mm)	.78(34.29mm)
G	1.31(33.27mm)	1"=1.25 (25.4mm)=(31.75mm) 1-1/4"=1.50 (31.75mm)=(38.1mm)	1.50(38.1mm)
H	1.44(36.57mm)	1.50(38.1mm)	1.75(44.45mm)
I	.24(6.09mm)	.23(5.84mm)	.24(6.09mm)

ALL DIMENSIONS IN INCHES

## HOSE BARB INNER (I.D.) ("93" SERIES ONLY)

- 1/2"(12.7mm) - .462"(11.73mm)
- 3/4"(19.05mm) - .52"(13.20mm)
- 1"(25.4mm) - .790"(20.06mm)
- 1-1/4"(31.75mm) - 1.05"(26.67mm)
- 1-1/2"(38.1mm) - 1.25"(31.75mm)
- 2"(50.8mm) - 1.54"(39.11mm)

## MARELON® THREADED VALVES

These valves are designed to meet the needs of builders and owners who require the benefits of the Marelon® integrated plumbing system, with female threads. This valve works great with A.N.P. Thru-Hulls. Forespar® offers this threaded valve in three of our most widely used configurations with N.P.S.M. or B.S.P threads.

All Marelon® Integrated Plumbing System valves come with a matched thru-hull, both of which use a buttress thread form that is very strong for synthetics. When these complete systems are ordered with either flush or mushroom non-screened thru-hulls the valves come with a cap in the handle that has a loop. This cap is an emergency thru-hull plug in case the valve must be disassembled to clear debris or be replaced completely **WITHOUT HAVING TO HAUL THE BOAT.**

If you want to use a Marelon® valve with an existing bronze or stainless steel thru-hull, we can (with prior notice) supply the valves with either the NPSM (National Pipe Straight Mechanical) or BSP (British Standard Pipe) threads that typically are used with bronze or stainless steel thru-hulls.

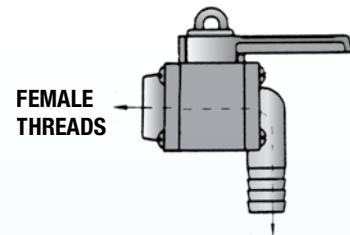
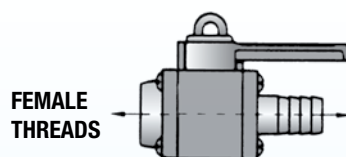
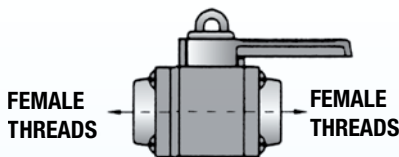

Valve P/N	Size
933332	1/2"(12.7mm)
933333	3/4"(19.05mm)
933334	1"(25.4mm)
933335	1-1/4"(31.75mm)
933336	1-1/2"(38.1mm)
933338	2"(50.8mm)

Valve P/N	Size
933342	1/2"(12.7mm)
933343	3/4"(19.05mm)
933344	1"(25.4mm)
933345	1-1/4"(31.75mm)
933346	1-1/2"(38.1mm)
933348	2"(50.8mm)

Valve P/N	Size
933352	1/2"(12.7mm)
933353	3/4"(19.05mm)
933354	1"(25.4mm)
933355	1-1/4"(31.75mm)
933356	1-1/2"(38.1mm)
933358	2"(50.8mm)

# MARELON® "93" SERIES OEM PLUMBING SYSTEMS

Original Equipment Manufacture

FORESPAR® "93" SERIES OF VALVES AND THRU-HULL FITTINGS MEET ALL DESIGN CRITERIA AND EXCEED ALL MECHANICAL PROPERTY REQUIREMENTS SPECIFIED BY THE INTERNATIONAL STANDARDS ORGANIZATION (ISO 150/188) "SMALL CRAFT SEACOCKS AND THRU-HULL FITTINGS-PART 2: NON-METALLIC"



Arrows Indicate Water Flow Direction

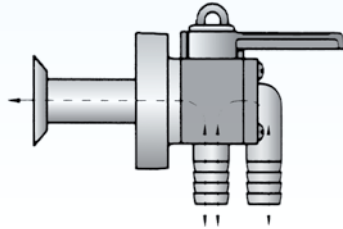

### Mushroom Thru-Hull Size

931252 1/2"(12.7mm)  
931253 3/4"(19.05mm)  
931254 1"(25.4mm)  
931255 1-1/4"(31.75mm)  
931256 1-1/2"(38.1mm)  
931258 2"(50.8mm)

### Flush Thru-Hull Size

932252 1/2"(12.7mm)  
932253 3/4"(19.05mm)  
932254 1"(25.4mm)  
932255 1-1/4"(31.75mm)  
932256 1-1/2"(38.1mm)  
932258 2"(50.8mm)

### Mushroom Screened Thru-Hull Size

937452 1/2"(12.7mm)  
937453 3/4"(19.05mm)  
937454 1"(25.4mm)  
937455 1-1/4"(31.75mm)  
937456 1-1/2"(38.1mm)  
937458 2"(50.8mm)

### Flush Screened Thru-Hull Size

936452 1/2"(12.7mm)  
936453 3/4"(19.05mm)  
936454 1"(25.4mm)  
936455 1-1/4"(31.75mm)  
936456 1-1/2"(38.1mm)  
936458 2"(50.8mm)

OEM SALES ONLY

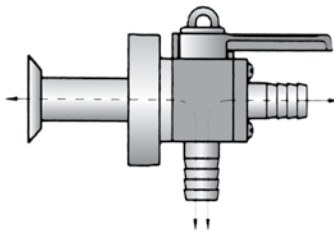

### Mushroom Thru-Hull Size

931242 1/2"(12.7mm)  
931243 3/4"(19.05mm)  
931244 1"(25.4mm)  
931245 1-1/4"(31.75mm)  
931246 1-1/2"(38.1mm)  
931248 2"(50.8mm)

### Flush Thru-Hull Size

932242 1/2"(12.7mm)  
932243 3/4"(19.05mm)  
932244 1"(25.4mm)  
932245 1-1/4"(31.75mm)  
932246 1-1/2"(38.1mm)  
932248 2"(50.8mm)

### Mushroom Screened Thru-Hull Size

937442 1/2"(12.7mm)  
937443 3/4"(19.05mm)  
937444 1"(25.4mm)  
937445 1-1/4"(31.75mm)  
937446 1-1/2"(38.1mm)  
937448 2"(50.8mm)

### Flush Screened Thru-Hull Size

936442 1/2"(12.7mm)  
936443 3/4"(19.05mm)  
936444 1"(25.4mm)  
936445 1-1/4"(31.75mm)  
936446 1-1/2"(38.1mm)  
936448 2"(50.8mm)

OEM SALES ONLY

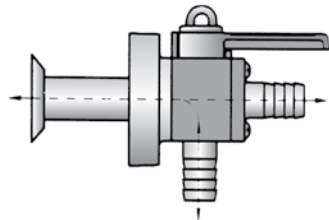

### Mushroom Thru-Hull Size

931542 1/2"(12.7mm)  
931543 3/4"(19.05mm)  
931544 1"(25.4mm)  
931545 1-1/4"(31.75mm)  
931546 1-1/2"(38.1mm)  
931548 2"(50.8mm)

### Flush Thru-Hull Size

932542 1/2"(12.7mm)  
932543 3/4"(19.05mm)  
932544 1"(25.4mm)  
932545 1-1/4"(31.75mm)  
932546 1-1/2"(38.1mm)  
932548 2"(50.8mm)

### Mushroom Screened Thru-Hull Size

937642 1/2"(12.7mm)  
937643 3/4"(19.05mm)  
937644 1"(25.4mm)  
937645 1-1/4"(31.75mm)  
937646 1-1/2"(38.1mm)  
937648 2"(50.8mm)

### Flush Screened Thru-Hull Size

936642 1/2"(12.7mm)  
936643 3/4"(19.05mm)  
936644 1"(25.4mm)  
936645 1-1/4"(31.75mm)  
936646 1-1/2"(38.1mm)  
936648 2"(50.8mm)

OEM SALES ONLY

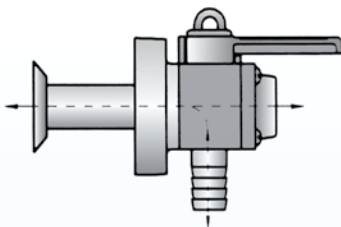

### Mushroom Thru-Hull Size

931532 1/2"(12.7mm)  
931533 3/4"(19.05mm)  
931534 1"(25.4mm)  
931535 1-1/4"(31.75mm)  
931536 1-1/2"(38.1mm)  
931538 2"(50.8mm)

### Flush Thru-Hull Size

932532 1/2"(12.7mm)  
932533 3/4"(19.05mm)  
932534 1"(25.4mm)  
932535 1-1/4"(31.75mm)  
932536 1-1/2"(38.1mm)  
932538 2"(50.8mm)

### Mushroom Screened Thru-Hull Size

937632 1/2"(12.7mm)  
937633 3/4"(19.05mm)  
937634 1"(25.4mm)  
937635 1-1/4"(31.75mm)  
937636 1-1/2"(38.1mm)  
937638 2"(50.8mm)

### Flush Screened Thru-Hull Size

936632 1/2"(12.7mm)  
936633 3/4"(19.05mm)  
936634 1"(25.4mm)  
936635 1-1/4"(31.75mm)  
936636 1-1/2"(38.1mm)  
936638 2"(50.8mm)

OEM SALES ONLY

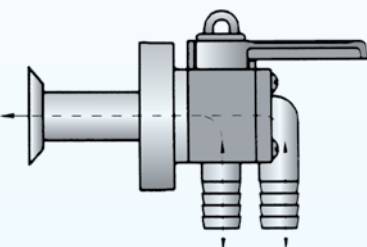

### Mushroom Thru-Hull Size

931552 1/2"(12.7mm)  
931553 3/4"(19.05mm)  
931554 1"(25.4mm)  
931555 1-1/4"(31.75mm)  
931556 1-1/2"(38.1mm)  
931558 2"(50.8mm)

### Flush Thru-Hull Size

932552 1/2"(12.7mm)  
932553 3/4"(19.05mm)  
932554 1"(25.4mm)  
932555 1-1/4"(31.75mm)  
932556 1-1/2"(38.1mm)  
932558 2"(50.8mm)

### Mushroom Screened Thru-Hull Size

937652 1/2"(12.7mm)  
937653 3/4"(19.05mm)  
937654 1"(25.4mm)  
937655 1-1/4"(31.75mm)  
937656 1-1/2"(38.1mm)  
937658 2"(50.8mm)

### Flush Screened Thru-Hull Size

936652 1/2"(12.7mm)  
936653 3/4"(19.05mm)  
936654 1"(25.4mm)  
936655 1-1/4"(31.75mm)  
936656 1-1/2"(38.1mm)  
936658 2"(50.8mm)



# Over 300 Builders Install Marelon

## The Modern Solution To Marine Plumbing

- Corrosion Resistant
- Valves and Thru-Hulls
- Below or Above Waterline
- Cert. UL, ABYC, ISO

**NOTE:** All "93" Series Seacocks come standard with buttress thread thru-hulls

**OPTIONAL THREADING** - NPSM or BSP Threaded Bases are available  
3/4" to 2" for use with existing thru-hulls



Arrows Indicate Water Flow Direction

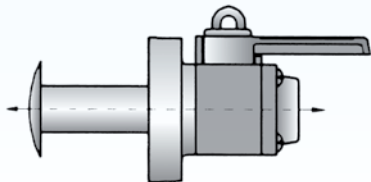

### Mushroom Thru-Hull Size

931132 1/2" (12.7mm)  
931133 3/4" (19.05mm)  
931134 1" (25.4mm)  
931135 1-1/4" (31.75mm)  
931136 1-1/2" (38.1mm)  
931138 2" (50.8mm)

### Flush Thru-Hull Size

932132 1/2" (12.7mm)  
932133 3/4" (19.05mm)  
932134 1" (25.4mm)  
932135 1-1/4" (31.75mm)  
932136 1-1/2" (38.1mm)  
932138 2" (50.8mm)

### Mushroom Screened Thru-Hull Size

937332 1/2" (12.7mm)  
937333 3/4" (19.05mm)  
937334 1" (25.4mm)  
937335 1-1/4" (31.75mm)  
937336 1-1/2" (38.1mm)  
937338 2" (50.8mm)

### Flush Screened Thru-Hull Size

936332 1/2" (12.7mm)  
936333 3/4" (19.05mm)  
936334 1" (25.4mm)  
936335 1-1/4" (31.75mm)  
936336 1-1/2" (38.1mm)  
936338 2" (50.8mm)

## OEM SALES ONLY

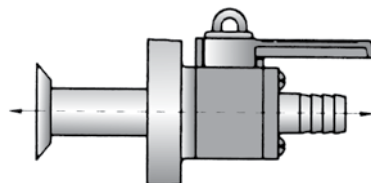

### Mushroom Thru-Hull Size

931142 1/2" (12.7mm)  
931143 3/4" (19.05mm)  
931144 1" (25.4mm)  
931145 1-1/4" (31.75mm)  
931146 1-1/2" (38.1mm)  
931148 2" (50.8mm)

### Flush Thru-Hull Size

932142 1/2" (12.7mm)  
932143 3/4" (19.05mm)  
932144 1" (25.4mm)  
932145 1-1/4" (31.75mm)  
932146 1-1/2" (38.1mm)  
932148 2" (50.8mm)

### Mushroom Screened Thru-Hull Size

937342 1/2" (12.7mm)  
937343 3/4" (19.05mm)  
937344 1" (25.4mm)  
937345 1-1/4" (31.75mm)  
937346 1-1/2" (38.1mm)  
937348 2" (50.8mm)

### Flush Screened Thru-Hull Size

936342 1/2" (12.7mm)  
936343 3/4" (19.05mm)  
936344 1" (25.4mm)  
936345 1-1/4" (31.75mm)  
936346 1-1/2" (38.1mm)  
936348 2" (50.8mm)

## OEM SALES ONLY

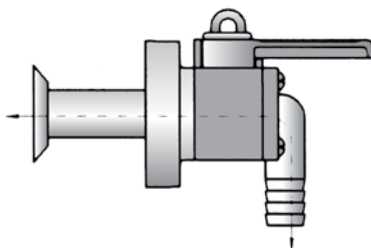

### Mushroom Thru-Hull Size

931152 1/2" (12.7mm)  
931153 3/4" (19.05mm)  
931154 1" (25.4mm)  
931155 1-1/4" (31.75mm)  
931156 1-1/2" (38.1mm)  
931158 2" (50.8mm)

### Flush Thru-Hull Size

932152 1/2" (12.7mm)  
932153 3/4" (19.05mm)  
932154 1" (25.4mm)  
932155 1-1/4" (31.75mm)  
932156 1-1/2" (38.1mm)  
932158 2" (50.8mm)

### Mushroom Screened Thru-Hull Size

937352 1/2" (12.7mm)  
937353 3/4" (19.05mm)  
937354 1" (25.4mm)  
937355 1-1/4" (31.75mm)  
937356 1-1/2" (38.1mm)  
937358 2" (50.8mm)

### Flush Screened Thru-Hull Size

936352 1/2" (12.7mm)  
936353 3/4" (19.05mm)  
936354 1" (25.4mm)  
936355 1-1/4" (31.75mm)  
936356 1-1/2" (38.1mm)  
936358 2" (50.8mm)

## OEM SALES ONLY

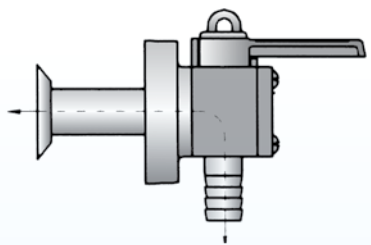

### Mushroom Thru-Hull Size

931262 1/2" (12.7mm)  
931263 3/4" (19.05mm)  
931264 1" (25.4mm)  
931265 1-1/4" (31.75mm)  
931266 1-1/2" (38.1mm)  
931268 2" (50.8mm)

### Flush Thru-Hull Size

932262 1/2" (12.7mm)  
932263 3/4" (19.05mm)  
932264 1" (25.4mm)  
932265 1-1/4" (31.75mm)  
932266 1-1/2" (38.1mm)  
932268 2" (50.8mm)

### Mushroom Screened Thru-Hull Size

937462 1/2" (12.7mm)  
937463 3/4" (19.05mm)  
937464 1" (25.4mm)  
937465 1-1/4" (31.75mm)  
937466 1-1/2" (38.1mm)  
937468 2" (50.8mm)

### Flush Screened Thru-Hull Size

936462 1/2" (12.7mm)  
936463 3/4" (19.05mm)  
936464 1" (25.4mm)  
936465 1-1/4" (31.75mm)  
936466 1-1/2" (38.1mm)  
936468 2" (50.8mm)

## OEM SALES ONLY

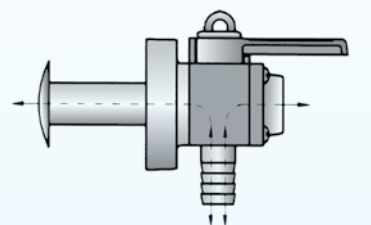

### Mushroom Thru-Hull Size

931232 1/2" (12.7mm)  
931233 3/4" (19.05mm)  
931234 1" (25.4mm)  
931235 1-1/4" (31.75mm)  
931236 1-1/2" (38.1mm)  
931238 2" (50.8mm)

### Flush Thru-Hull Size

932232 1/2" (12.7mm)  
932233 3/4" (19.05mm)  
932234 1" (25.4mm)  
932235 1-1/4" (31.75mm)  
932236 1-1/2" (38.1mm)  
932138 2" (50.8mm)

### Mushroom Screened Thru-Hull Size

937432 1/2" (12.7mm)  
937433 3/4" (19.05mm)  
937434 1" (25.4mm)  
937435 1-1/4" (31.75mm)  
937436 1-1/2" (38.1mm)  
937438 2" (50.8mm)

### Flush Screened Thru-Hull Size

936432 1/2" (12.7mm)  
936433 3/4" (19.05mm)  
936434 1" (25.4mm)  
936435 1-1/4" (31.75mm)  
936436 1-1/2" (38.1mm)  
936438 2" (50.8mm)

# SINK WASTES

Available in straight and 90° configurations, these drains are designed for 1" and 3/4" tubing. Models SW-3, SW-4 and SW-6 are bright chrome plated, non-corrosive plastic.



SW-1



SW-2



SW-3



SW-4



SW-6

Part No.	Model No.	Tail	Flange	Cut-Out	OD
907000	SW-1	Straight—For 1"(25.14mm) I.D.	1-3/4"(44.45mm)	1-5/16"(33.33mm)	2 7/16" x 2 7/16" x 1 5/8"
907014	SW-2	90°—For 1"(25.14mm) I.D.	1-3/4"(44.45mm)	1-5/16"(33.33mm)	3 3/16" x 2" x 2 1/2"
907015	SW-3	Straight—1-1/2"(38.11mm) screw	2-7/8"(73.02mm)	2"(50.8mm)	3" x 3" x 1 3/4"
907016		Replacement Sink Stopper			
907017	SW-4	90° - For 1"(25.14mm) I.D.	2-7/8"(73.02mm)	2"(50.8mm)	3 3/4" x 3" x 4 1/8"
907013	SW-5	(same as SW-1, for 3/4"(19.05mm) I.D.)	1-3/4"(44.45mm)	1-5/16"(33.33mm)	2 7/16" x 2 7/16" x 1 51/64"
907022	SW-6	Straight—For 1"(25.14mm) I.D.	2-7/8"(73.02mm)	2"(50.8mm)	3" x 3" x 3 1/8"
907027	SW-7	(same as SW-6, for 3/4"(19.05mm) I.D.)	2-7/8"(73.02mm)	2"(50.8mm)	3" x 3" x 3 5/16"

# TANK VENT

A new idea in fuel tank vents. For hulls with solid cores only. Unit press-fits into 3/4"(19.5mm) hole without the need of a nut. The stainless steel screen will not corrode and has no plating to chip.

## Tank Vent Installation

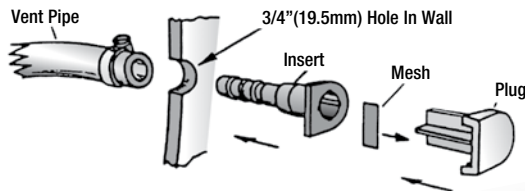

**Part No.** 907029  
**Model No.** MF 610



For 5/8"(15.87mm) hose.

# UTILITY DRAIN D-1

Fully threaded acetal utility drain.  
Thread length: 1-3/8"(34.92mm)  
Thread size: 1"(25.14mm)



**Part No.** 907028  
**Model No.** D-1

# DRAIN PLUG

Molded from Forespar's Marelon® and fitted with a neoprene seal; the Forespar® Drain Plug is carefully designed to not deteriorate and crack with age.



**Part No.** 907001  
**Model No.** MF 790

# DECK FILLS

Molded in Marelon® for lifetime durability, Forespar® Deck fills are available in three color-coded models. Each clearly marked for use with either water, fuel or waste. Easy-open cap is fitted with nylon retainer cord and rubber 'O'-ring to ensure a safe and efficient seal. Suitable for 1-1/2"(38.1mm) I.D. hose.

Part No.	Model No.	For use with:
907002	MF 830 F	Fuel
907003	MF 830 W	Water
907004	MF 830 WST	Waste
153000	Waste Adapter for 1.5"(38.1mm) threads	



Deck Flange is 4"(101.6mm) dia. Cutout: 2-1/8"(53.97mm)  
Hose Barb Length: 3"(76.2mm)

# GARBOARD DRAINS

For newer, thicker transoms, Forespar® designed a drain & plug assembly to fit up to 1-3/4”(44.45mm) thick transoms. Our Marelon® female 3/4”(19.05mm) elbows or female threaded barbed hose fitting (see page 40) can be screwed onto the end for hose attachment if needed. All Marelon® construction insures years of corrosion free use.

Part No.	Description
906081	GARBOARD DRAIN
906075	GARBOARD DRAIN (Short)
906076	GARBOARD DRAIN (Long)
906091	<b>NEW</b> GARBOARD DRAIN Black 2” dia.
906092	<b>NEW</b> GARBOARD DRAIN White 2” dia.



- GD-S #906075 (short) Usable length with 5 threads engaged is 2-1/2” (63.5mm) maximum, 1-7/16” (36.51mm) minimum.
- GD-L #906076 (long) Usable length with 5 threads engaged is 3-1/4” (82.55mm) maximum, 2-1/2” (63.5mm) minimum.
- Diameter of the flange (both ends) is 2” (50.8mm). Diameter of the body (female threaded unit) is 1-3/16” (30.16mm). This is the diameter of the hole needed to install the unit through the transom.
- The screw style plug with gasket comes with it standard. Color of the Marelon material is white (like all our T-hulls).

# OUTBOARD WELL DRAIN

The Forespar® outboard well drain offers a corrosion proof, easy-to-install replacement for the old fashioned brass fitting. Can also be used as a chafe guard to lead hose, wiring, steering cables, etc. through bulkheads, floor timbers and fiberglass panels. Barbs on O.D. ensure positive locking action. Designed to fit 1”(25.14mm) diameter hole.

**Flange is 1-1/4”(31.75mm) dia.**

Part No.	Model No.
907006	MF 795



# FLOWTECH™ PERFORMANCE VALVE

## THE RACER'S CHOICE

Flowtech™ free flow sea valves incorporate the valve body, thru-hull and the choice of all three sizes of hose pipe connections all in one set. These high performance valves are available for 3/4”(19.05mm), 1”(25.14mm) & 1-1/2”(38.1mm) hose sizes. The Flowtech™ valve pipe can be faired smooth to the boat's outer skin so that when the valve is closed, the internal plunger and valve pipe creates a flush, fair & fast outer surface. Made of Marelon®

### OEM SALES ONLY

**VALVE COMPONENTS ARE NOT COMPATIBLE WITH ANY OTHER MANUFACTURERS' PRODUCT**

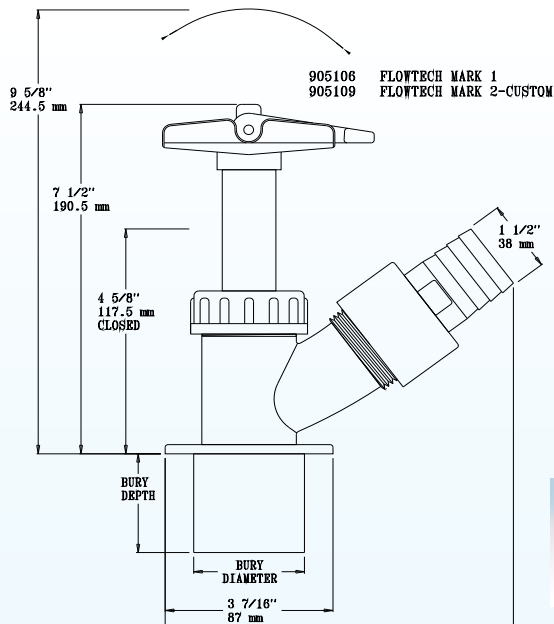

Description	P/N	Wt
Folwtech™ Valve Mark I	905106	1.502 oz
Folwtech™ Valve Mark II	905109	1.702 oz
Folwtech™ Mark I Repair Kit	905107	
Folwtech™ Mark II Repair Kit	905112	

Bury Info	Depth	Dia.
Folwtech™ Valve Mark I	1 3/8” (35 mm)	1 7/8” (47.6 mm)
Folwtech™ Valve Mark II	2 1/16” (52 mm)	2 1/4” (57 mm)

# WATER STRAINER

This water strainer is made of Marelon® (same material as our valves). It features a new universal mounting bracket and clear polycarbonate lid for ready inspection. The stainless steel strainer basket can be easily removed for cleaning. Intake and exit ports are 1-1/2"(38.1mm) ANP parallel threads standard. Reducers for 3/4"(19.05mm) I.D. hose are available separately. Diameter: 6.3"(160.02mm) Height: 6.1"(154.94mm). The flow rate is 40 GPM(151.41l/m) with 1-1/2"(38.1mm) ports.

(SEE REDUCERS AND ADAPTERS SHOWN BELOW)

The new mounting bracket allows the strainer exit port to be positioned in the proper direction by simply loosening the bracket clamp and rotating the entire housing. This will allow the OEM or aftermarket customer greater flexibility in installation.



Part No.	Model No./Description	Part No.	Model No./Description
906066	MF 810 Water Strainer	906065	s/s Basket only
906067	MF 811 Gasket Set	920178	Clear Cover only



# T-150 WATER STRAINER

Our new Marelon T-150 Strainer provides a compact installation alternative for raw water filtration without compromising filtration rates. It features a T-Head body design and unique mounting bracket that allows the T150 to be installed in tight or hard-to-reach locations where traditional raw water strainers will not fit. Despite its smaller size, it offers all the benefits of traditional "top basket" strainers.

The clear polycarbonate screw-on filter bucket offers easy viewing of the stainless steel filter basket without removal and its unique C clamp mounting bracket allows the strainer to be snapped into place and rotated as needed to face any direction to fit tight spaces.

The T-150 fits 1-1/2" Female NPSM (Parallel Threads) Ports to which you can attach a straight or 90° Hose Barb Tailpipe as needed. Adaptors are also available for 3/4", 1", 1-1/8" & 1-1/4" fittings.

(SEE REDUCERS AND ADAPTERS SHOWN BELOW)



Part No.	Model No./Description
906166	T-150 Water Strainer
920261	T-150 Clear Bowl
920262	T-150 Gasket
920265	T-150 Mesh Screen #20 (Extra Fine)
920264	T-150 Mesh Screen #8 (Standard)
906187	T-150 Mounting Bracket

# WATER STRAINER REDUCERS/ADAPTERS



Part No.	Model No.	Thread
901045	FTC 8	1/2"(12.7mm) female
901046	FTC 12	3/4"(19.05mm) female
901042	FTC 16	1"(25.14mm) female
901044	FTC 20	1-1/4"(31.75mm) female
901043	FTC 24	1-1/2"(38.1mm) female
901040	MTC 12-8	3/4"(19.05mm)-1/2"(12.7mm) male
901050	MTC 12-12	3/4"(19.05mm)-3/4"(19.05mm) male
901051	MTC 16-12	1"(25.14mm)-3/4"(19.05mm) male
901047	MTC 24-16	1-1/2"(38.1mm)-1"(25.14mm) male
901048	MTC 24-20	1-1/2"(38.1mm)-1-1/4"(31.75mm) male
901049	MTC 24-24	1-1/2"(38.1mm)-1-1/2"(38.1mm) male
910062	RB 24-16	1-1/2"(38.1mm) male- 1"(25.14mm) female
910063	RB 24-12	1-1/2"(38.1mm) male -3/4"(19.05mm) female

# REPLACEMENT PARTS

## AWNING POLES

For TAP 3-6, TAP 4-8, 6-12, 5-10 HD and 6-12 HD

Part No.	Model No./Description
504003	End Kit

## MAST CARS

AT-125-S/T-125-S

Part No.	Model No./Description
333010	Toggle/Knuckle assembly
331013	Plastic Runners

FC-125/FC-125-SP

Part No.	Model No./Description
332003	FC Flange only
332005	Hinge Pin
331013	Plastic Runners

## DECK CHOCKS

Part No.	Model No./Description
332007	DC-2 Spool replacement spool only
300005	DC-TS Post replacement post only

## DECK FILLS

Part No.	Model No./Description
907024	Red Fuel Cap
907025	Blue Water Cap
907026	Black Waste Cap

## SPINNAKER POLES

For EL-150 thru EL-300-EF

Part No.	Model No./Description
408025	Repair Kit

For XP-200 thru XP-450-EF

Part No.	Model No./Description
309080	Repair Kit

For TS-300 thru TS-450

Part No.	Model No./Description
309050	Repair Kit

## MAST LIGHTS

ML-1

Part No.	Description
132009	Replacement Lens ring (new)
132035	Bottom Bulb Assy.

ML-2

Part No.	Description
132009	Replacement Lens ring (new)
132025	WN 211 Top Bulb
132035	Bottom Bulb Assy.
132041	Top Lens and Cap Assy.

LED Bulbs

Part No.	Description
131300	ML-1 LED
132300	ML-2 LED
132325	ML-2 Top bulb-LED
132335	ML-1 & 2 Bottom bulb-LED

## RAILFAST®

Part No.	Description
002066	Screw 3/8"
156050	Base-Fiberglass
156052	Bracket strap
156053	Pin-square
156055	Bracket shim-7/8"
156056	Allen wrench
156058	Boss cover

## WHISKER POLES

ADJ 4-8

Part No.	Model No./Description
300026	Repair Kit
400006	Lock Repair Kit
404010	7/8" inner tube w/ lock
504002	1" outer tube

ADJ 6-12

Part No.	Model No./Description
300027	Repair Kit
400008	Lock Repair Kit
406015	1 1/8" inner tube w/ lock
406001	1 1/4" outer tube

HD 6-12 DL

Part No.	Model No./Description
304015	UEF-3 special inboard end
304018	UEF-5 outboard end
400009	Lock Repair Kit
406211	1 3/4" inner tube w/ lock
406202	1 7/8" outer tube

ADJ 7-17 DL

Part No.	Model No./Description
304018	UEF-5 outboard end
304057	UEF-3 inboard end
400010	Lock Repair Kit
407007	1 3/4" inner tube w/ lock
407008	1 7/8" middle tube w/ lock
406210	2" outer tube

## CARGO MATE™

Part No.	Description
153230	Deck Flange
153204	Base Mount
153207	33" extension
153232	Plug for Deck Mount
153233	Transom Ring Mount (Power)
153209	Storage Bag

## MOTOR MATE™

Part No.	Description
153104	Base Mount
153105	Rail Mount
153107	Bottom Tube only
153109	Vinyl Bag

## QUIK DAVIT™

Part No.	Description
153475	Davit Head Kit (sold in pairs)
153476	Dinghy Pad Kit (sold in pairs)
153477	Fast Kit™
153478	Universal Adhesive Kit

## NOVA LIFT™

Part No.	Description
153366A	Upper Arm Assembly
152250A	Lower Mount Tube Assembly

## THRU-HULL PARTS

Part No.	Description
907007	CF 249 1/2" nut only
907008	CF 249 3/4" nut only
907009	CF 249 1" nut only
907010	CF 249 1 1/4" nut only
907011	CF 249 1 1/2" nut only
907012	CF 249 2" nut only
403125	Small Mold Plug (OEM only)
403135	Large Mold Plug (OEM only)

## MARELON® PLUMBING SYSTEM PARTS

Parts No.	Description
930072	Cap/Plug/Bung
930073	Cap/Plug/Bung
930074	Cap/Plug/Bung

## LINE CONTROL™ WHISKER POLES

Replacement Inboard Ends

LC 10-18	Part No.	Model No./Description
	401035	EL-250-LC EF

LC 12-22	Part No.	Model No./Description
	402037	EL-300-LC EF
	304038	Ultra Collar

LC 13-24	Part No.	Model No./Description
	403104	LCC-1 Collar

LC 15-27	Part No.	Model No./Description
	405102	LCC-2 Collar

## TILLER EXTENSIONS

Part No.	Description
104004	TFP - Assembly Complete w/ Socket
104006	TFP - Socket (Receptacle) Only

## ULTRA END FITTINGS

Part No.	Description
304029	UXP - Repair Kit
304030	UTR 200 & 250- Repair Kit

## SAFETY GEAR

OP-120, OPST-120 Overboard Poles

Part No.	Model No./Description
202026	Flag
202132	Stainless Steel Clip
202020	Replacement Top Half With Flag

# FORESPAR® PRODUCTS POLICIES & CONTACTS

## QUALITY COMPONENTS

Whatever you order, you'll receive more for your money from Forespar®. For example, we only use Spectron 12® composite line on our bridles and heavy duty vinyl on our lanyard wire, not the thin coated type for sailmakers. Our castings are prime type 356 aluminum alloy, heat treated to T-6 condition for strength and a higher coefficient of elongation. This means a reduction in brittleness without reducing the heat treated strength.

## SUPERIOR ANODIZING

The clear anodizing used on our tubing meets military specifications, which means approximately three times the coating thickness of "commercial" grade anodizing. Our end fittings, where corrosion resistance is particularly important, are carefully machined, extensively deburred and then finished with a high quality, hard coat finish of 2 mil. minimum thickness anodizing. Our fittings are not dyed, painted or stained to cover up lesser quality, and we invite you to compare Forespar® fittings with those of any other manufacturer.

## ORDERING OPTIONS

**IMPORTANT** - There are three distinct ways to order our spinnaker poles, reaching struts and jib booms.

**1. CUSTOMIZED:** Poles may be ordered to the specific length required for your boat. Simply specify our Model No. and the exact overall length required.

**2. "KIT" FORM:** Everything for a complete pole job is included in our "Kit" packages. The tubing is supplied in the maximum length recommended for the particular diameter ordered. One end fitting is left unfastened so that the tubing can be cut to length, before final customizing. By keeping an inventory of kit poles, you can quickly and easily customize them to whatever length your customer requires. This eliminates "single item" freight costs and keeps your customer happy with fast immediate service.

**3. FITTINGS AND TUBING:** If you have the know how, and the simple tools necessary, you can order the component parts and save money by doing the assembly yourself. Simply specify the model numbers of the end fittings and tubing sizes required.

## PACKING

Every boom or strut is individually packed in its own shipping container for maximum protection and a "new" look when it arrives at its destination. Multi-packed items are protected by individual polyethylene bags.

## RETURNED MERCHANDISE

No returns will be accepted without prior agreement from Forespar® including instructions on method of shipment and return authorization number. Customized merchandise is not returnable. Any unused, undamaged merchandise accepted for return will be subject to a 20% return and handling charge.

## REPAIRS

Repairs necessary due to accident, misuse or normal wear and tear, will be made at customer's request. Charges for such repairs will include published price of replacement parts and reasonable labor costs. All merchandise being returned for repair must be shipped prepaid and include return address and repair instructions.

A Return Authorization Number from our Customer Service department is required.



Forespar Corporate Headquarters



# **FORESPAR®**

*MARINE PRODUCTS THAT PERFORM*

Learn more about maintenance and winterization we have.