

FURUNO

8.4" COLOR LCD RADAR

Model

1815



FULLY AUTOMATIC GAIN FOR SIMPLIFIED USE

Compact Radar Ensuring Safety at Sea

- ▶ Highly visible display makes it possible for you to recognize surrounding environment at a glance
- ▶ High sensitivity allows you to acquire other vessels, buoys and objects on the sea surface, and coasts
- ▶ Penetrate sudden fog or compensate for poor visibility in stormy weather
- ▶ Reliable coastline images, even in poor visibility
- ▶ Assist sailing in the night with high-sensitivity, reliable analyzing system
- ▶ Compact radome antenna with 4 kW transmitter output power
- ▶ Low power consumption of 38 W at the most
- ▶ Easy installation and intuitive operation
- ▶ Advanced auto-adjust settings for Gain/Sea clutter/Rain clutter
- ▶ Fast Target Tracking™ (TT)
- ▶ True trail mode
- ▶ True motion mode
- ▶ True view mode
- ▶ User-programmable function key
- ▶ Swivel mounting bracket to adjust the angle of the display unit

The MODEL1815 is an 8.4" color LCD radar designed for pleasure craft and small fishing boats. The Radar has easy-to-use, intuitive controls, while maintaining the high performance you expect from FURUNO products. Even in poor visibility such as fog or storms, the radar produces detailed pictures of coastline and targets at short ranges by utilizing narrow pulses and dual IF bandwidths. The waterproof display makes it ideal for exposed installations, such as fly bridges.

The MODEL1815 utilizes our Fast Target Tracking™, True Trail Mode and True View Mode technologies to ensure optimum performance in detecting and ranging targets of interest.



Menu settings
Cancel key

Menu selections
Cursor key

Enter key
AIS/TT select or acquire

Select display mode
Measure target

Alarm settings
Set Guard zone

Function settings: TLL

Rings Brill

Heading Line Brill

Display Color

Echo Color

Display Mode

Data Box

Trail Time

Trail Erase etc.

Select range scale
Adjust GAIN control
Reduce SEA/RAIN clutter

Show data box (nav/target/both)

Power ON/OFF
Switch Stand-by and Transmit
Display Brill

8.4" COLOR LCD RADAR

Model

1815

Fast Target Tracking™ (TT) function

Fast Target Tracking™ (TT) function manually or automatically acquires and tracks 10 targets. After selecting a target, it only takes a few seconds for a speed and course vector to be displayed. With accurate tracking information, estimation of other vessel's course and speed is made easier.

Target Tracking (TT) Symbols

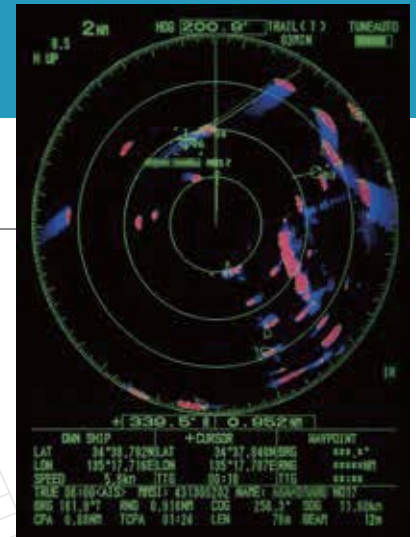

AIS display

When connecting a FURUNO FA-30/50 AIS unit, up to 100 AIS targets can be tracked and displayed on the Radar screen. The AIS improves safety during travel by sharing the status and position of your vessel with other AIS-equipped vessels nearby. You can easily read detailed information about other AIS equipped vessels nearby, such as speed and heading.

AIS Symbols



Sleeping AIS Target



Lost Target



Activated Target



Dangerous Target



Selected Target

True Trail mode

When using the True Trail Mode, moving objects will show up on the main screen with a gradational trail. These trails make it possible to see the movement of nearby vessels in the blink of an eye.

* Heading data and positional data are required.

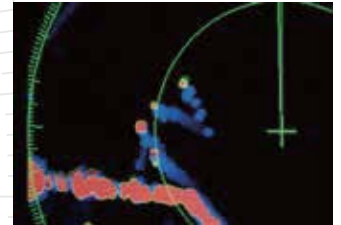

Gain/Sea/Rain setting menu

To display targets clearly and accurately, the gain must be adjusted. The MODEL1815 can do this automatically for you. By automatically adjusting the gain, the Radar eliminates unnecessary echoes and displays a clear image.

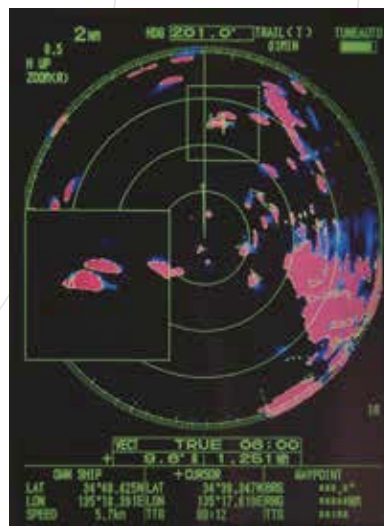

Zoom mode

The Zoom function expands the length and width of a selected target with the magnification of 2.0, in the zoom window.

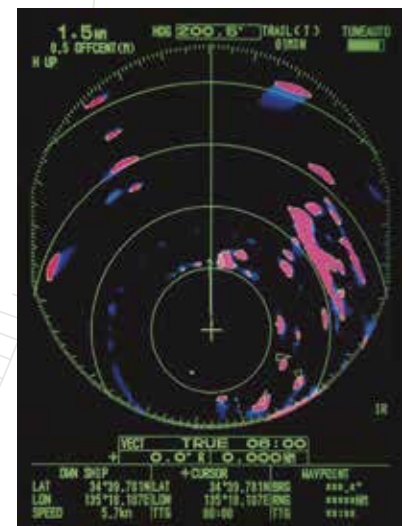

Off Center mode

Own ship position can be shifted to a pre-registered point on the screen. This allows the operator to focus on a specific area ahead of or around the vessel without losing track of the position.

Adjustable display colors

You can select the color scheme depending on your environment. From brightly sunlit to dark of the night, displayed images can always be seen.

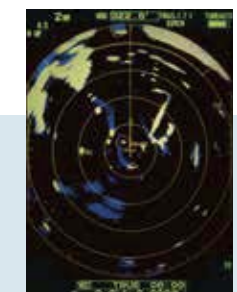

Swivel mounting bracket

The gimbal mount allows the display unit to swivel around when desktop mounted. You can adjust the angle of the display for optimal viewing comfort.



SPECIFICATIONS OF Model 1815

ANTENNA

Type \varnothing 488 mm (19") radome
 Beamwidth Horizontal 5.2°, Vertical 25°
 Rotation Speed 24 rpm

RF TRANSCEIVER

Frequency 9410 \pm 30 MHz (X-band)
 Pluslength & PRR 0.08 μ s/360 Hz (0.0625-0.5 NM)
 0.3 μ s/360 Hz (0.75-2 NM)
 0.8 μ s/360 Hz (3-36 NM)
 Peak Output Power 4 kW
 IF Frequency IF : 60 MHz
 BW: 20 MHz (0.0625 to 0.5 NM)
 4.5 MHz (0.75 to 36 NM)

DISPLAY

Display Type 8.4" color LCD
 Effective Display Area 128.2 (W) x 170.9 (H) mm
 Pixel Number 480 x 640 (VGA)
 Presentation Mode Head-up, Course-up*, North-up*, True view*
 True motion**

Target tracking (TT)* Up to 10 targets
 AIS** Up to 100 targets

Language

* Heading data required
 ** Heading data and position data required
 English, French, Spanish, German, Italian, Portuguese, Danish, Norwegian, Russian, Chinese, Thai, Vietnamese, Indonesian, Burmese, Korea, Japanese

Accuracy

Range : 1.0% of range in use or 0.01 NM, whichever is greater

Range and Range Ring Interval

Bearing : EBL accuracy \pm 1°
 Range : 0.0625, 0.125, 0.25, 0.5, 0.75, 1, 1.5, 2, 3, 4, 6, 8, 12, 16, 24, 36 NM

EchoTrail

Ring : 0.03125, 0.0625, 0.125, 0.125, 0.25, 0.25, 0.5, 0.5, 1, 1, 2, 2, 3, 4, 6, 12 NM
 Type : True* or relative trails
 Interval : 15, 30 s, 1, 3, 6, 15, 30 min., or continuous

Minimum Range

* Heading data required

Range Discrimination

25 m

Interface (NMEA0183 format)

Input : ALR, BWC, BWR, DBT, DPT, GGA, GLL, GNS, GSA,GSV, HDG, HDT, HDM, MTW, MWV, RMB, RMC, THS, TTM, VDM, VHW, VTG, VWR, WVT, XTE, ZDA
 Output : ACK, RSD, TLL, TTM

ENVIRONMENT

Temperature

Antenna Unit: -25 °C to +55 °C
 Display Unit : -15 °C to +55 °C

Waterproofing

Antenna Unit: IPX6
 Display Unit : IP56

POWER SUPPLY

12 -24 VDC: 3.2-1.6 A

EQUIPMENT LIST

Standard

1. Display Unit RDP-157
2. Antenna Unit RSB-127-120
3. Antenna Cable 10/15/20/30 m specify when ordering
4. Power Cable 3.3 m
5. Spare Parts & Installation Materials

Option

1. Antenna Bracket OP03-209
2. External Buzzer OP-3-21
3. NMEA Data Converter IF-NMEA2K2
4. Flush Mount Kit

Antenna Unit

6.5 kg 14.3 lb

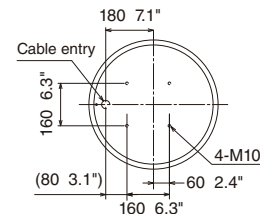
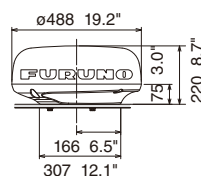

Display Unit

Bracket Mount 2.2 kg 4.9 lb
 Flush Mount 1.6 kg 3.5 lb

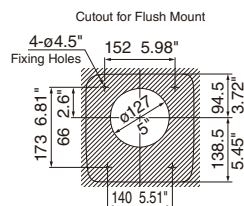
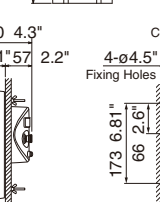
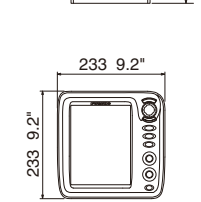
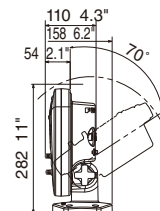
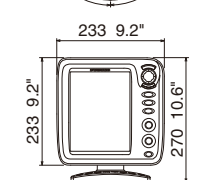
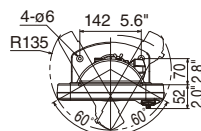

INTERCONNECTION DIAGRAM

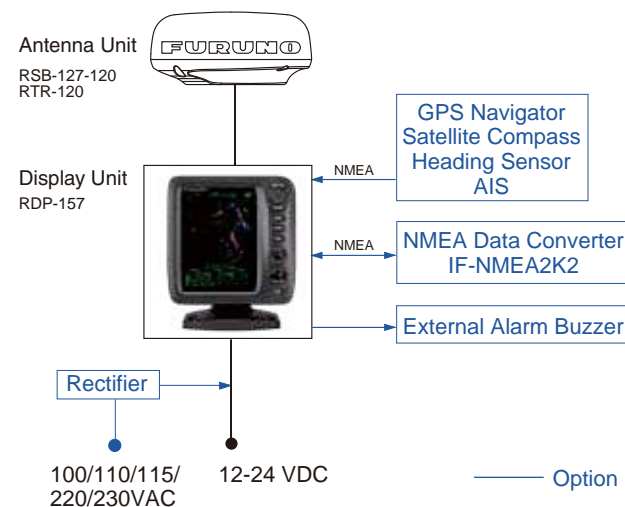

Beware of similar products

All brand and product names are registered trademarks, trademarks or service marks of their respective holders.

SPECIFICATIONS SUBJECT TO CHANGE WITHOUT NOTICE