

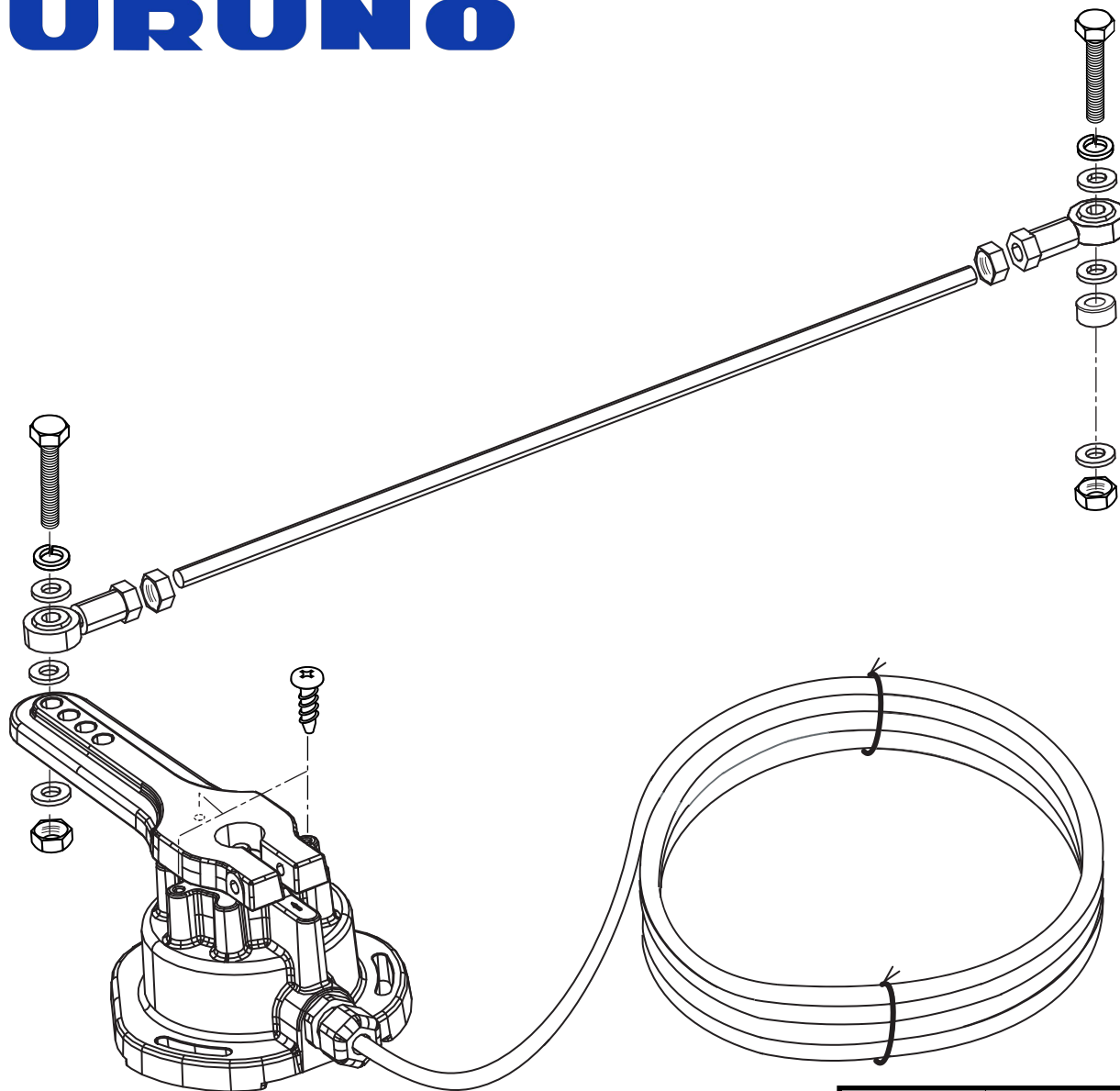







FURUNO



INSTALLATION MATERIALS
CP64-02601

	HEXAGONAL HEAD BOLT M6X40 SUS304 (000-158-853-10)	2
	SPRING WASHER M6 SUS304 (000-158-855-10)	2
	FLAT WASHER M6 SUS304 (000-158-854-10)	6
	ROD END ASSY. (2 PCS/SET) FAP-6112 (009-001-180)	1
	HEXAGONAL NUT M6 SUS304 (000-158-856-10)	4
	SELF TAPPING SCREW 4X20 SUS304 (000-158-850-10)	3
	CONNECTING ROD 64-024-4606-0 (100-328-060-10)	1
	SPACER 64-024-4612-0 (100-328-110-10)	1

MODEL	NAVPILOT-500/511/520/611			
APPROVED	CHECKED	DRAWN	UNIT	FAP-6112 RUDDER REFERENCE UNIT
16 Dec.2008	16 Dec.2008	16 Dec.2008		
Y.Kamba	T.Yoshida	S.Kubota	DWG.NO.	C7250-E04-A

Check out the collection of marine electronics & navigations we offer.