

FURUNO

5.7" Color LCD FISH FINDER

Model **FCV-628**

High resolution
fish echoes with
RezBoost™
technology!



NEW



RezBoost



FCV-628 uses revolutionary new RezBoost™ in resolution and target separation, utilizing

NEW

Fish Finder technology just took a big leap with RezBoost™!



RezBoost™

RezBoost™ is a revolutionary new signal processing technology developed by FURUNO that improves resolution and target separation when using conventional narrowband transducers. Spot individual game fish surrounding bait balls, as well as fish close to the seabed. With RezBoost™, not only can you expect higher resolution and crisper visuals, but also improvements in the ACCU-FISH™ function.

With RezBoost™ the capabilities of conventional narrowband transducers can be dramatically improved. Compared to conventional signal processing techniques (FDF), a RezBoost™ fish finder produces an image that is up to 8 times*¹ clearer.

A TruEcho CHIRP™ fish finder (requires a special transducer) produces an image that is up to 10 times*¹ clearer when compared with FDF. What can be done with a conventional narrowband transducer, just like the one you might have installed on your vessel, is truly impressive*².

*¹ RezBoost™ performance may vary depending on depth, range and signal frequency used.

*² The Enhanced mode of RezBoost™ requires a RezBoost™ capable thru-hull or transom mount transducer.

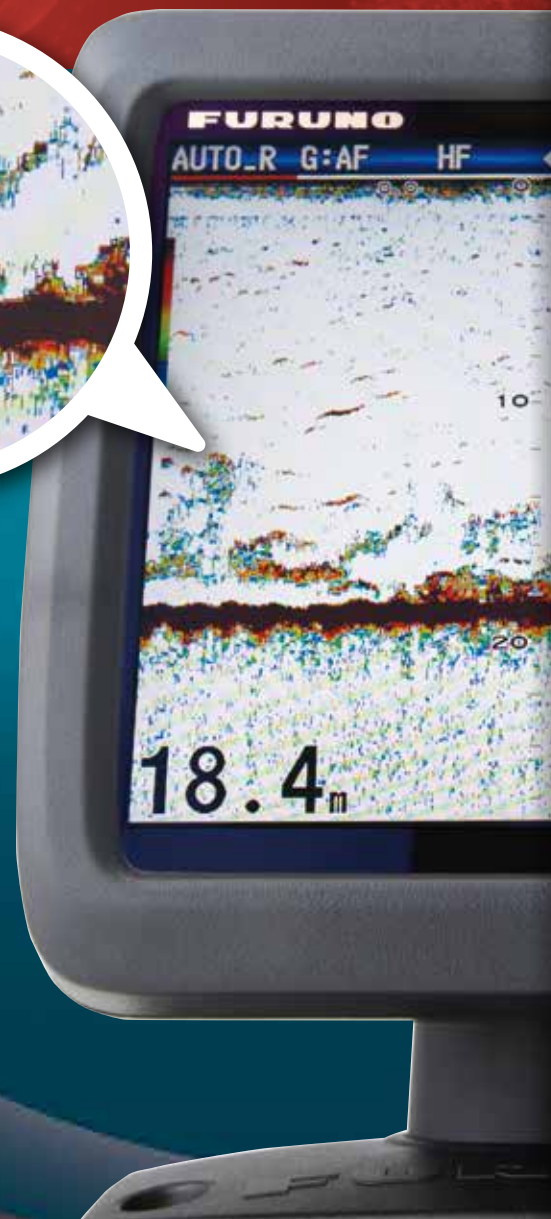

5.7" Color LCD FISH FINDER

Model **FCV-628**

technology, providing an incredible boost a compact narrowband transducer

NEW

- ▶ **Dual-frequency fish finder equipped with revolutionary new RezBoost™ signal processing technology**

Improved clarity and resolution that was previously impossible with conventional narrowband transducers has been made possible thanks to the new RezBoost™ technology.

- ▶ **ACCU-FISH™ - A unique fish size analyzer based on the latest digital technology**

- ▶ **Bottom Discrimination - Analyze bottom structure**

Provides an at-a-glance recognition of bottom composition with four types of graphical displays (Rocks/Sand/Gravel/Mud) when connected to a supported thru-hull or transom mount transducer.

- ▶ **White Line feature - Discriminate fish lying near the bottom**

The top edge of the bottom echo is displayed in white to clearly show bottom structures. This feature helps to discriminate between weeds and bottom fish distinctly.

- ▶ **Configurable Alarm function** (depth, fish echoes, etc.)

- ▶ **Share and display information on a chart plotter***

FURUNO's TLL (Target Lat/Lon) output allows you to interface the FCV-628 with your FURUNO chart plotter so that you can mark fishing grounds with various information (L/L, Depth, Water Temp, Fish size and Bottom type).

* Requires a chart plotter.

- ▶ **Fast transmission rate of 3,000 PRR** (Pulse Repetition Rate) per minute (at 5 m depth range)



technology, providing an incredible boost a compact narrowband transducer

FISH SIZE

BOTTOM

With RezBoost™ technology, the resolution is increased, leading to sharper and more defined echoes. Thanks to this increase in resolution, the accuracy of the ACCU-FISH™ function is also improved. ACCU-FISH™ is very useful when you need to determine fish size, but also has the added benefit of making fish echoes more visible when viewed from a distance. With ACCU-FISH™ you can spot individual fish echoes even from the deck on your vessel.

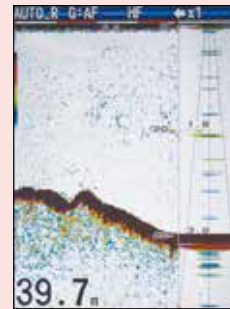

ACCU-FISH™ OFF



ACCU-FISH™ ON

ACCU-FISH™ identifies individual fish with size and fish mark function

Recognizes individual or multiple fish instantaneously

ACCU-FISH™ is a fish size assessment function of FCV-628 that is proprietary to FURUNO. In order to assess individual fish size, echo returns are evaluated based on strength and turned into fish size display on screen.

ACCU-FISH™ can detect fish size from 10 to 199 cm, in depths of 2 to 100 m.

ACCU-FISH



Display fish marks

The fish mark can be utilized to display individual fish echoes when they are detected. It helps beginners to identify fish echoes for a more engaging fishing experience. Fish marks are selectable from either a circle or square, as well as, two fish symbols. The fish symbols, displayed in two different sizes (Large: over 50 cm, Small: 10 to 49 cm), are a great help for anglers when identifying individual fish. The circle and square symbols identify individual fish without hiding the underlying echo.

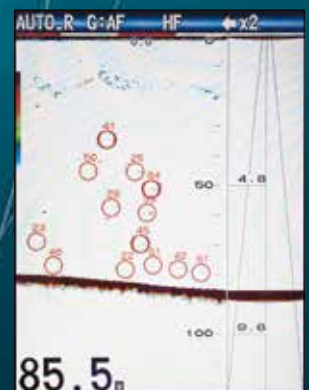

Circles displayed over fish echoes along with their approximate size.

In some instances, fish size indicated on FCV-628 may differ from actual size. Please read the operator's manual carefully before using this feature.

Bottom Discrimination function

FCV-628's Bottom Discrimination function enables the fish finder to indicate whether the bottom is composed mainly of rocks, gravel, sand or mud.

The Bottom Discrimination function provides you with valuable information that helps you locate rich fishing grounds, and boost your catch of the day.

Please keep the following in mind when using the Bottom Discrimination Sounder:

- 1) Use at a depth of 5 m - 100 m.
- 2) Use a transom or thru-hull mount transducer.
- 3) Install the transducer parallel to the bottom of the vessel.
- 4) To show a consistent display of the actual bottom, set the display range to "auto".
- 5) Enter the ship's draft value.
- 6) Use a ship speed of 10 kn or less.
- 7) In some instances, the bottom component indicated on the FCV-628 may differ from the actual bottom structure.
Please read the operator's manual carefully before using this feature.

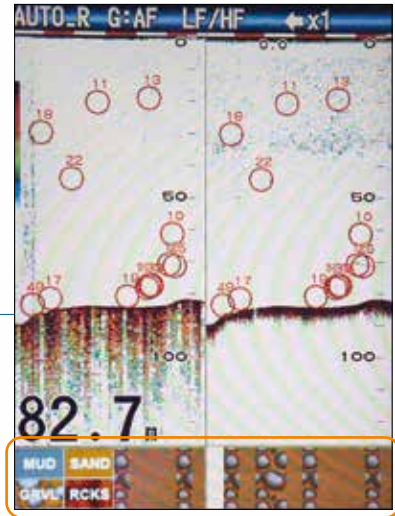

Graphic mode

The standard graphic display mode shows the most probable bottom composition by graphic or four colors.

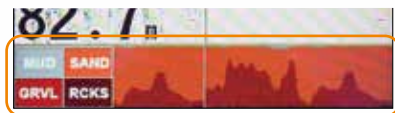

Probability mode

The probability display mode shows the most probable bottom composition in graph form.

White Line function distinguishes fish from the seabed

This function is useful for discriminating bottom fish as well as judging fish school density.

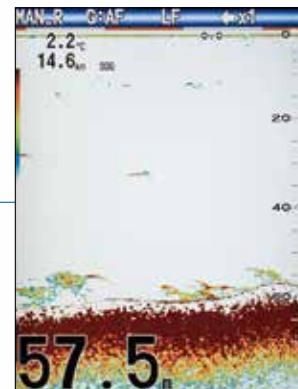

Fish Alarm function

When fish echoes appear in an area preset by the user, the FCV-628 will sound a loud alarm, as well as, display an alarm icon on screen.

The integrated alarm can also be set to be triggered by specific conditions for water depth, target depth, water temperature, bottom type and more.

You never have to miss a target again.

Setting	
Name	: ALARM1
Sound	: Sound1
Fish Type	: ACCU-FISH
From	: 4inch
Span	: +1inch
Fish Level	: Medium
Depth	
From	: 0m
Span	: +30m
Temperature	: Off
From	: 20.0°C
Span	: 1.0°C
Bottom Type	: Gravel
Bottom	: 0m
From	: 0m
Span	: +30m
▲/▼/◀/▶	: Select
[ENTER]	: Enter
[MENU]	: Back

Swivel mounting bracket

The gimbal mount allows the display unit to swivel around when desktop mounted. You can adjust the angle of the display for optimal viewing comfort.



SPECIFICATIONS OF FCV-628

GENERAL

Frequency 50 and 200 kHz
Output Power 600 W

DISPLAY

Display Type 5.7" color LCD
Effective Display Area 87.1 (W) x 116.2 (H) mm
Pixel Number 480 x 640 (VGA)
Display Single frequency (50 or 200 kHz), Dual-frequency, Zoom, Nav data, A-scope, Marker zoom, Bottom zoom, Bottom-lock, Bottom Discrimination, ACCU-FISH™, RezBoost™
Basic Range 2-1200 m*

Alarm *m, ft, fm, HR, pb can be selected in the menu
Bottom, Fish (Normal), ACCU-FISH™, Fish (B/L), Bottom Discrimination, Fish Level, Temperature, Speed, Arrival and Battery

Language English, French, Spanish, German, Italian, Portuguese, Greek, Polish, Danish, Swedish, Norwegian, Finnish, Chinese, Japanese, Thai, Vietnamese

Range Phasing up to 1200 m
Expansion Range Bottom-lock expansion: 2-10 m
Sectional expansion: 2-1200 m

Picture Advance Speed 8 steps: stop, 1/16, 1/8, 1/4, 1/2, 1, 2, 4

Pulselength & PRR 0.04 to 3.0 ms, Max 3,000 pulse/min
Interface (IEC61162-1, NMEA 0183 Ver 1.0/2.0/3.0)

Input: BWC, GGA, GLL, GNS, HDG, HDT, MDA, MTW, MWW, RMA, RMB, RMC, VHW, VTG, XTE, ZDA

Output: DBS, DBT, DPT, MTW*, RMB*, VHW*, TLL* by key operation

* External data required

ENVIRONMENT

Temperature -15°C to +55°C
Waterproofing IP56

POWER SUPPLY 12-24 VDC: 1.1-0.5 A

EQUIPMENT LIST

Standard

1. Display Unit CV-628
2. Installation Materials and Standard Spare Parts

Option

1. Speed/Temperature Sensor
ST-02MSB, ST-02PSB, T-04MSB, T-04MTB
2. Connector Kit for Connection of Speed & Temperature Sensor or Temperature Sensor
3. NMEA+Power Cable

Transducers (Specify when ordering)

520-5PSD, 520-5MSD, 520-PLD, 525-5PWD, 525T-PWD, 525T-BSD, 525T-LTD/12, 525T-LTD/20, 525STID-MSD, 525STID-PWD, SS60-SLTD/12, SS60-SLTD/20

DISPLAY UNIT

Bracket Mount 1.3 kg 2.9 lb

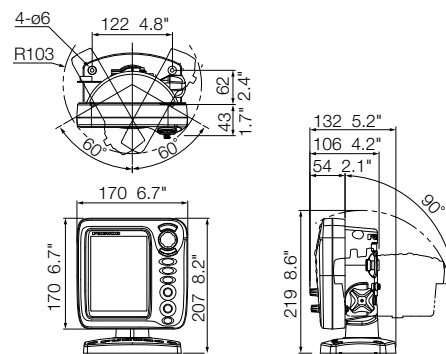

Flush Mount 0.9 kg 2 lb

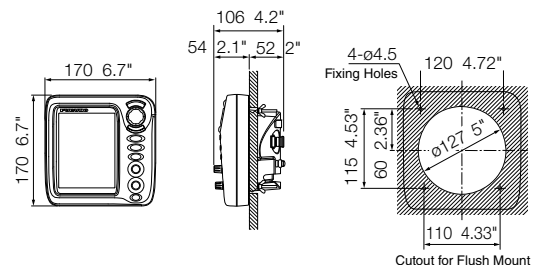

INTERCONNECTION DIAGRAM

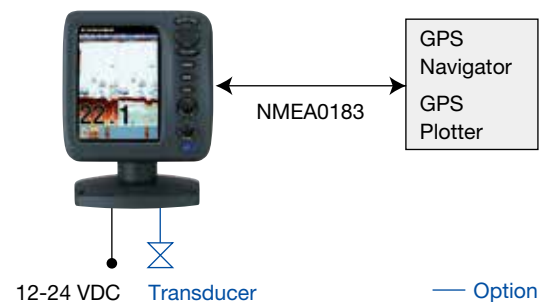

All brand and product names are registered trademarks, trademarks or service marks of their respective holders.

SPECIFICATIONS SUBJECT TO CHANGE WITHOUT NOTICE