

# FURUNO

## 12.1" Color LCD Marine Radar

Model **FR-8065/8125/8255**  
6 kW      12 kW      25 kW

*Furuno's advanced DSP technology brings a new level of performance to marine radar*

*DSP: Digital Signal Processing*



Auto Tuning



AIS



Target Tracking



Enhanced Sunlight Viewable



UHD  
Ultra High Definition

# Equipped with state of the art signal processing and UHD™ digital radar technology

The 12.1" color radar FR-8005 series features state of the art signal processing, which makes it easier to identify targets in heavy rain and poor visibility. The FR-8005 radar can discern between rain and surface reflections, providing the ability to find and track the movement of rain clouds as well as removing unnecessary echoes. For tracking the movement of other vessels at sea, "True Motion Trails" can be displayed as well as AIS/TT target-tracking with a zoom display function. When the vessel is in motion, the radar echoes move smoothly on the main display thanks to the "True View Mode".

- ▶ **One-touch auto-adjust settings for Gain/Sea clutter/Rain clutter.**
- ▶ **48 rpm high-speed antenna rotation. Displays information clearly in narrow passages and on high-speed vessels.**
- ▶ **Wide viewing angle LCD for great visibility from any direction.**

## Advanced Signal Processing

Even during rainfalls or severe weather conditions, radar echoes are clearly displayed, and unnecessary echoes can be removed instantly with ease. Compared with current radars (FR-8002 series) the technology for removing sea, rain and snow clutter has been greatly enhanced utilizing FURUNO's state of the art knowledge in digital signal processing.

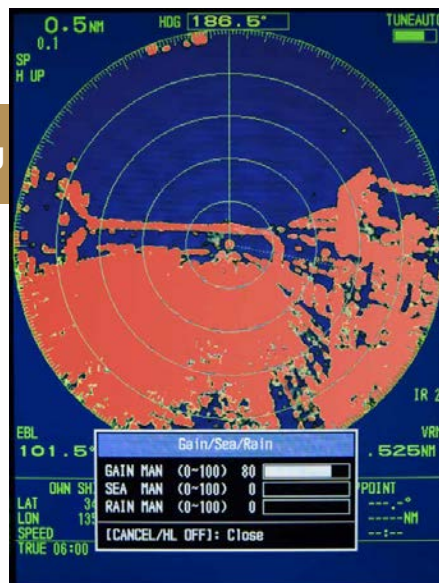

A/C Rain turned off, the marina is completely covered by the rain echo.



A/C Rain turned on, the marina appears clearly.

## Target-Tracking Zoom Display Function

When using the Target mode, vessels close by and vessels on intersecting courses are automatically displayed zoomed in. These targets will remain displayed for as long as they pose any concern. Target Trails are also displayed, making it easy for the user to determine the movements of individual vessels.

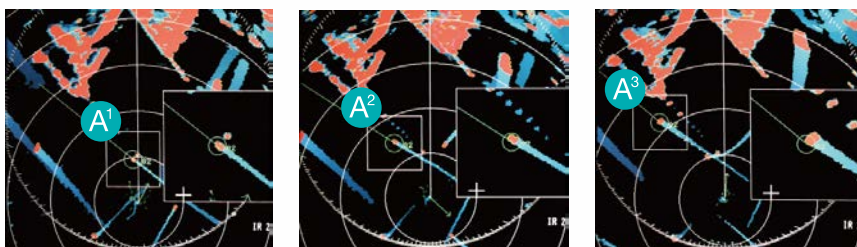

※ AIS transponder and ARP-11 are required to use the zoom display function

## True Trail Mode

When using the True Trail Mode, moving objects will show up on the main screen with a colorful trail. These trails make it possible to see the movement of nearby vessels in the blink of an eye.

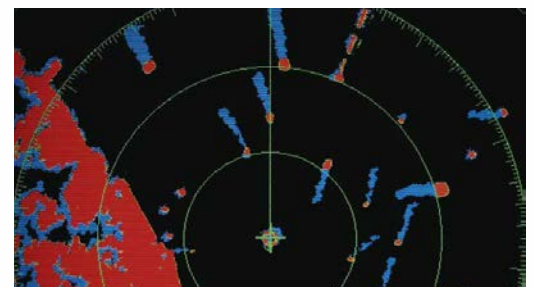

※ Heading data and positional data are required

# Signal processing technology!



## True View Mode

The radar echoes move smoothly on the main display thanks to the "True View Mode". The True View Mode is based on the head-up mode. During the radar sweep, the echoes move according to the heading of your ship. Since the echoes move in real-time, the discrepancy between an observed target and what is displayed on the radar screen is greatly reduced.

※Heading data is required to use the True View Mode

## Full-Screen Mode and Off-Center Mode

Make use of the whole display surface with the Full-Screen mode, giving you more information when making important decisions. When combining Full-Screen mode with Off-Center mode any target or point of interest can be observed in detail. The overlay information can be turned off, to observe targets obstructed by the text as well as providing an unobstructed radar view.

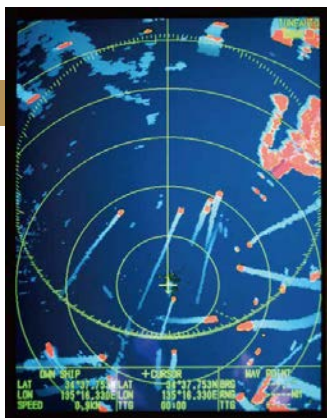

Off-center mode

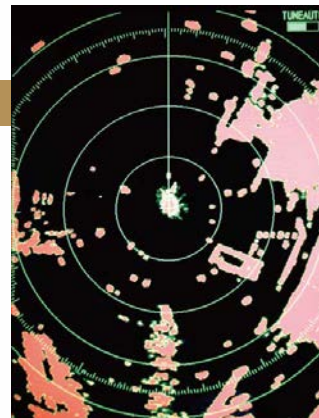

Without overlay information

## Target tracking (TT)\*1 and AIS display\*2

The Target Tracking (TT) feature continuously tracks and provides positional information for up to ten targets.

An AIS device-equipped FR-8005 series radar can track target heading, name, speed and direction of movement. With AIS it is possible to identify and track the movement of other vessels in heavy fog, during nighttime and otherwise difficult conditions. Another benefit is that with AIS you can identify obscured targets that the radar signals cannot reach, giving you more time to act. AIS can display up to 100 targets simultaneously, TT can display up to 10 different targets simultaneously.

\*1 The optional ARP-11, heading data and speed data are required

\*2 AIS receiver and heading data are required

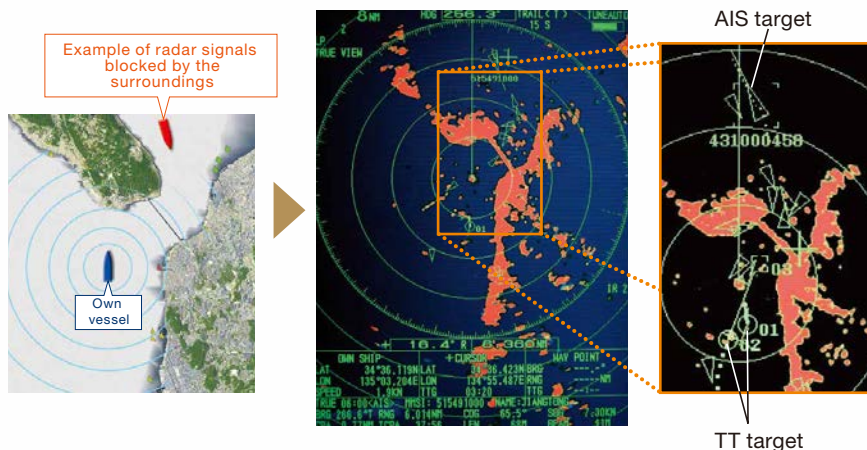

# 12.1" Color LCD Marine Radar

Model **FR-8065/8125/8255**

SPECIFICATIONS	FR-8065 (6 kW)	FR-8125 (12 kW)	FR-8255 (25 kW)
<b>GENERAL</b>			
Maximum Range Scale	72 NM	72 NM	96 NM
Range discrimination		25 m	
Bearing discrimination		XN12A: 1.9° XN13A: 1.2°	
Minimum Detection Range		25 m	
<b>ANTENNA</b>			
Length		4 ft (XN12A) or 6 ft (XN13A)*	
Rotation Speed		24 rpm or 48 rpm*	
Wind Load		24 rpm: 100 kn 48 rpm: 70 kn	
Beamwidth (Horizontal)		XN12A: 1.9° XN13A: 1.35°	
Beamwidth (Vertical)		22°	
<b>RF TRANSCEIVER</b>			
Frequency		9410±30 MHz (X-band), PON	
Output Power	6 kW	12 kW	25 kW
<b>DISPLAY</b>			
Screen Size		12.1 inch color LCD	
Pixel Number		800 (V) x 600 (H) pixels (SVGA)	
<b>POWER SUPPLY</b>			
Power Supply		24 VDC	
Power Consumption	24 rpm: 86.4 W 48 rpm: 93.6 W	24 rpm: 93.6 W 48 rpm: 108 W	24 rpm: 127.2 W 48 rpm: 136.8 W
<b>INTERFACE</b>			
Input / Output	Input: NMEA0183 Ver. 1.5/2.0/3.0/4.0, AD-10 format Output: NMEA0183 Ver. 1.5/2.0/3.0/4.0		
<b>ENVIRONMENT</b>			
Temperature	Antenna Unit: -25 °C to +55 °C Display Unit: -15 °C to +55 °C		
Waterproofing	Antenna Unit: IPX6 Display Unit: IPX5 (front) IPX2 (rear)		
<b>EQUIPMENT LIST</b>			
Standard	Display Unit, Antenna Unit, Power Supply Unit (for FR-8255 only), Installation materials and spare parts, Cable assy.		
Option	Auto Plotter Kit ARP-11, External Alarm Buzzer OP03-21, Cable assy., Flush Mount Kit OP03-228		

\*Specify the antenna length and rotation speed when ordering.

## DIMENSIONS

### Antenna Unit

XN12A: 25 kg 55.1 lb  
XN13A: 27 kg 59.5 lb

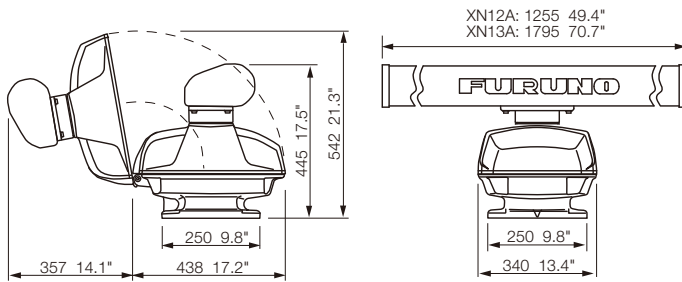

### Display Unit RDP-154 5.8 kg 12.8 lb

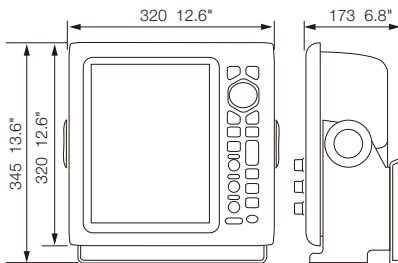

### Power Supply Unit PSU-008 2.7 kg 6 lb

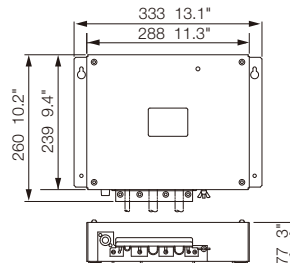

## INTERCONNECTION DIAGRAM

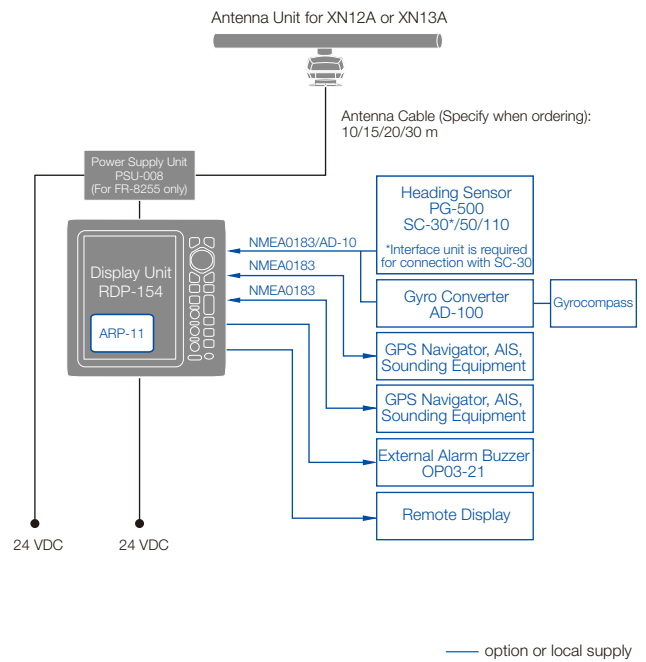

Beware of similar products

All brand and product names are registered trademarks, trademarks or service marks of their respective holders.

SPECIFICATIONS SUBJECT TO CHANGE WITHOUT NOTICE  
PLEASE READ THE MANUAL BEFORE USING THE UNIT