



Apollo™ RA770 Installation Instructions

Important Safety Information

⚠ WARNING

Failure to follow these warnings and cautions could result in personal injury, damage to the vessel, or poor product performance.

See the *Important Safety and Product Information* guide in the product box for product warnings and other important information.

This device must be installed according to these instructions.

Disconnect the vessel's power supply before beginning to install this product.

Before applying power to this product, make sure it has been correctly grounded, following the instructions in the guide.

⚠ CAUTION

Always wear safety goggles, ear protection, and a dust mask when drilling, cutting, or sanding.

NOTICE

When drilling or cutting, always check what is on the opposite side of the surface.

You must read all installation instructions before beginning the installation. If you experience difficulty during the installation, contact FUSION® Product Support.

What's In the Box

- Mounting gasket
- Four 8-gauge, self-tapping screws
- Two screw covers
- Power and speaker wiring harness
- Auxiliary-in, line-out, and subwoofer-out wiring harnesses
- 2 m (6 ft.) NMEA 2000® drop cable
- Dust cover

Tools Needed

- Phillips screwdriver
- Electric drill
- Drill bit (size varies based on surface material and screws used)
- Rotary cutting tool or jigsaw
- Silicone-based marine sealant (optional)

Mounting Considerations

- The stereo must be mounted on a flat surface.
- The stereo must be mounted in a location that allows open airflow around the rear of the stereo for heat ventilation.
- If you are installing the stereo in a location that may be exposed to water, it must be mounted within 45 degrees below or 15 degrees above the horizontal plane.

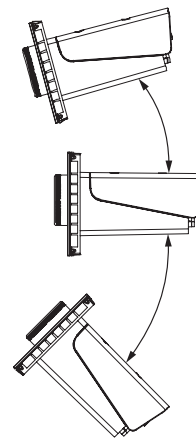

- If you are installing the stereo in a location that may be exposed to water, you should install any connected cables with a drip loop to allow water to drip down off the cable and avoid damage to the stereo.
- If you need to mount the stereo outside a boat, it must be mounted in a location far above the waterline, where it is not submerged.
- If you need to mount the stereo outside a boat, it should be mounted in a location where it cannot be damaged by docks, pilings, or other pieces of equipment.
- To avoid interference with a magnetic compass, the stereo should be installed at least 15 cm (5.9 in.) away from a compass.

Mounting the Stereo

NOTICE

Be careful when cutting the hole to mount the stereo. There is only a small amount of clearance between the case and the mounting holes, and cutting the hole too large could compromise the stability of the stereo after it is mounted.

Be careful when installing the stereo in an aluminum boat or a boat with a conductive hull, if you require the electrical system to be isolated from the boat hull.

Do not apply grease or lubricant to the screws when fastening the stereo to the mounting surface. Grease or other lubricants can cause damage to the stereo housing.

Before you can mount the stereo in a new location on the mounting surface, you must select a location in accordance with the mounting considerations.

- 1 Trim the template and make sure it fits at the mounting location.
- 2 Adhere the template to the mounting surface.
- 3 Using a drill bit appropriate for the mounting surface, drill a hole inside the corner of the dashed line on the template to prepare the mounting surface for cutting.
- 4 Using a rotary-cutting tool, cut the mounting surface along the inside of the dashed line on the template.
- 5 Place the stereo in the cutout ① to test the fit.

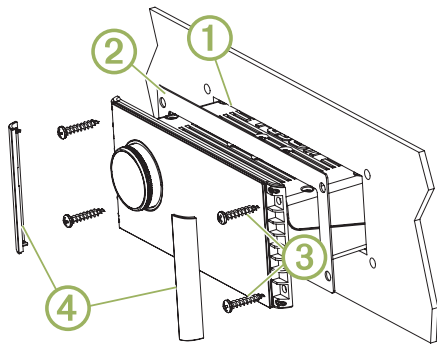

- 6 If necessary, use a file and sandpaper to refine the size of the cutout.
- 7 After the stereo fits correctly in the cutout, ensure the mounting holes on the stereo line up with the pilot holes on the template.
- 8 If the mounting holes on the stereo do not line up, mark the new pilot-hole locations.
- 9 Using an appropriately sized drill bit for the mounting surface and screw type, drill the pilot holes.
- 10 Remove the template from the mounting surface.
- 11 Make the necessary wiring connections ([Connection Considerations, page 2](#)).
- 12 Select an option:
 - If you are installing the stereo in a dry location, place the included mounting gasket ② on the back of the stereo.
 - If you are installing the stereo in a location that is exposed to water, apply silicone-based marine sealant on the mounting surface around the cutout.

NOTICE

Do not install the included mounting gasket if you applied sealant to the mounting surface. Using sealant and the mounting gasket may reduce water resistance.

- 13 Place the stereo into the cutout.
- 14 Secure the stereo to the mounting surface using the included screws ③.
You should hand-tighten the screws when securing the stereo to the mounting surface to avoid overtightening them.
- 15 Snap the screw covers in place ④.

Connection Considerations

For the stereo to function correctly, you must connect it to power, to speakers, and to input sources. You should carefully plan the layout of the stereo, speakers, input sources, optional NMEA 2000 network, and optional FUSION PartyBus™ devices or network before making any connections.

Port Identification

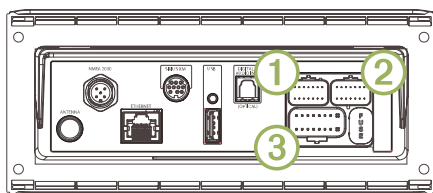

Item	Description
ANTENNA	Connects the stereo to a typical AM/FM antenna. If you are installing the stereo on a boat with a metal hull, you must use a ground-dependent antenna. If you are installing the stereo on a boat with a non-metal hull, you must use a ground-independent antenna. See the installation instructions provided with your antenna for more information.
NMEA 2000	Connects the stereo to a NMEA 2000 network (NMEA 2000 System Wiring Diagram, page 4). Connects to an NRX series remote control directly (Configuring an Optional Wired Remote, page 4).
ETHERNET	Connects the stereo to another FUSION PartyBus stereo, zone stereo, or network (FUSION PartyBus Networking, page 4).
SIRIUS XM	Connects the stereo to a SiriusXM® Connect Tuner to receive SiriusXM stations where available (not included). Connects to a FUSION DAB module to receive DAB stations where available (not included).
USB	Connects the stereo to a USB source.
DIGITAL AUDIO IN	Connects the stereo to an optical digital audio source, such as TV or DVD player.
FUSE	Contains the 15 A fuse for the device.
①	Connects the stereo to the wiring harness for auxiliary input 2, and for the line and subwoofer outputs for zones 3 and 4.
②	Connects the stereo to the wiring harness for auxiliary input 1, and for the line and subwoofer outputs for zones 1 and 2.
③	Connects the stereo to the power and speaker wiring harness.

Wiring Harness Wire and Connector Identification

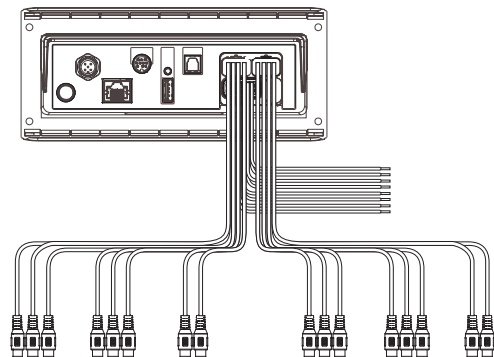

Wire or RCA Connector Function	Bare Wire Color or RCA Label Name	Notes
Ground (-)	Black	Connects to the negative terminal of a 12 Vdc power source capable of supplying 15 A. You should connect this wire before connecting the yellow wire. All accessories connected to the stereo must share a common ground location (Connecting to Power, page 3).
Power (+)	Yellow	Connects to the positive terminal of a 12 Vdc power source capable of supplying 15 A.
Ignition	Red	Connects to a separately-switched, 12 Vdc connection, such as an ignition bus, to turn the stereo on and off. If you are not using a switched 12 Vdc connection, you must connect this to the same source as the yellow (power) wire

Wire or RCA Connector Function	Bare Wire Color or RCA Label Name	Notes
Amplifier on	Blue	Connects to optional external amplifiers, enabling them to turn on when the stereo turns on.
Telemute	Brown	Activates when connected to ground. For example, when you connect this wire to a compatible, hands-free mobile kit, the audio mutes or the input switches to Aux1 when a call is received and the kit connects this wire to ground. You can enable this functionality from the settings menu.
Dim	Orange	Connects to the boat's illumination wire to dim the stereo screen when the lights are on. The gauge of the illumination wire must be suitable for the fuse supplying the circuit it is connected to.
Speaker zone 1 left (+)	White	
Speaker zone 1 left (-)	White/black	
Speaker zone 1 right (+)	Gray	
Speaker zone 1 right (-)	Gray/black	
Speaker zone 2 left (+)	Green	
Speaker zone 2 left (-)	Green/black	
Speaker zone 2 right (+)	Purple	
Speaker zone 2 right (-)	Purple/black	
Zone 1 line out (left) Zone 1 line out (right) Zone 1 subwoofer out	ZONE 1 ZONE 1 SUB OUT	Provides output to an external amplifier, and is associated with the volume control for zone 1. Each subwoofer cable provides a single mono output to a powered subwoofer or subwoofer amplifier.
Zone 2 line out (left) Zone 2 line out (right) Zone 2 subwoofer out	ZONE 2 ZONE 2 SUB OUT	Provides output to an external amplifier, and is associated with the volume control for zone 2. Each subwoofer cable provides a single mono output to a powered subwoofer or subwoofer amplifier.
Auxiliary in 1 left Auxiliary in 1 right	AUX IN 1	Provides an RCA stereo line input for audio sources, such as a CD or MP3 player.
Zone 3 line out (left) Zone 3 line out (right) Zone 3 subwoofer out	ZONE 3 ZONE 3 SUB OUT	Provides output to an external amplifier, and is associated with the volume control for zone 3. Each subwoofer cable provides a single mono output to a powered subwoofer or subwoofer amplifier.
Zone 4 line out (left) Zone 4 line out (right) Zone 4 subwoofer out	ZONE 4 ZONE 4 SUB OUT	Provides output to an external amplifier, and is associated with the volume control for zone 4. Each subwoofer cable provides a single mono output to a powered subwoofer or subwoofer amplifier.
Auxiliary in 2 left Auxiliary in 2 right	AUX IN 2	Provides and RCA stereo line input for audio sources, such as a CD or MP3 player.

to the battery. This provides power to the stereo and a constant trickle-power standby feed.

You should connect the red signal wire to the same battery through the ignition or another manual switch to turn the stereo on and off. If you are not routing the red wire through the ignition or another manual switch, you can connect the red wire to the yellow wire, and connect them both to the positive (+) battery terminal.

You must connect the power wires to the battery through a 15 A fuse or a 15 A circuit breaker.

If it is necessary to extend the yellow power and black ground wires, use 14 AWG (2.08 mm²) wire. For extensions longer than 1 m (3 ft.), use 12 AWG (3.31 mm²) wire. If it is necessary to extend the red wire, use 22 AWG (0.33 mm²) wire.

- 1 Route the yellow power ①, red signal ②, and black ground ③ wires to the battery, and route the wiring-harness plug to the stereo.

Do not connect the wiring harness to the stereo until all of the bare wire connections have been made.

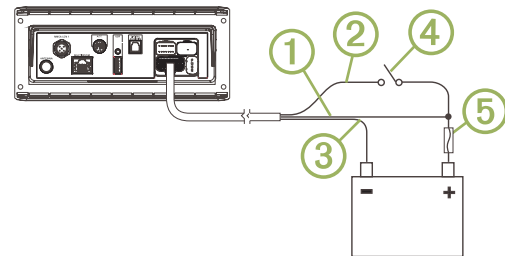

- 2 Connect the black wire to the negative (-) battery terminal.
- 3 If you are routing the red wire through the ignition or another manual switch ④, connect the red signal wire to the ignition or switch.
- 4 Connect the red wire to the yellow wire, install a 15 A fuse ⑤ as close to the battery as possible, and connect both wires to the positive (+) battery terminal.

NOTE: If you are running the red wire through a fused switch, it is not necessary to connect the red wire to the yellow wire or to add another fuse to the red wire.

Speaker Zones

You can group speakers in one area into a speaker zone. This enables you to control the audio level of the zones individually. For example, you could make the audio quieter in the cabin and louder on deck.

Up to two pairs of speakers can be connected per channel of each zone, in parallel. A zone can support no more than four speakers using the on-board amplifier.

Zones 1 and 2 are powered by the on-board amplifier. To use the RCA line outputs and the RCA subwoofer outputs for zones 1 and 2, you must connect external amplifiers.

Zones 3 and 4 are available as line-level outputs only. To use the RCA line outputs and the RCA subwoofer outputs for zones 3 and 4, you must connect external amplifiers.

You can set the balance, volume limit, tone, subwoofer level, subwoofer frequency, and name for each zone, and configure other zone-specific settings.

Connecting to Power

When connecting the stereo to power, you must connect both power wires. You should connect the yellow power wire directly

Single-Zone System Wiring Example

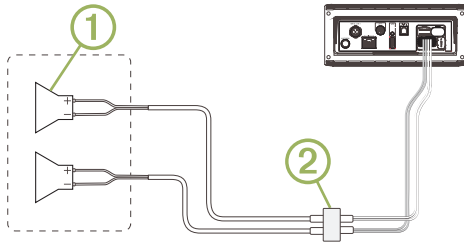

①	Speakers
②	Water-tight connection

Extended System Wiring

This diagram illustrates a system installation with an external amplifier and subwoofer connected to zone 2 on the stereo. You can connect an amplifier and subwoofer to any or all of the four zones on the stereo.

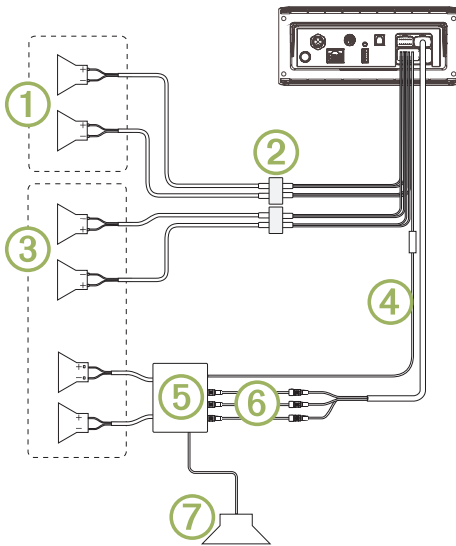

Item	Description
①	Zone 1 speakers
②	Water-tight connection
③	Zone 2 speakers
④	Amplifier-on signal wire You must connect this wire to each amplifier connected to a zone line out.
⑤	Powered amplifier connected to the zone 2 line out
⑥	Zone 2 line out and subwoofer out Each subwoofer cable provides a single mono output to a powered subwoofer or subwoofer amplifier.
⑦	Subwoofer

NMEA 2000 System Wiring Diagram

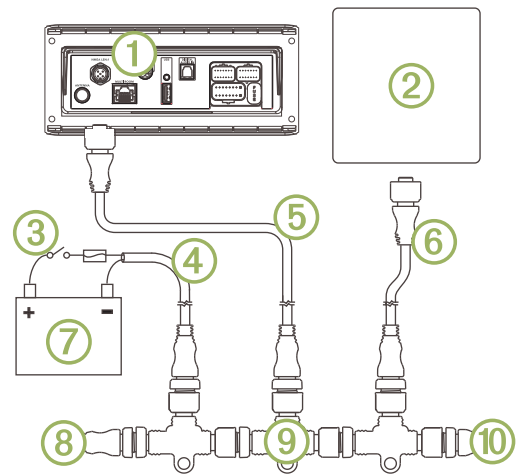

①	Stereo
②	Supported chartplotter MFD or compatible FUSION NMEA 2000 remote control
③	In-line switch
④	NMEA 2000 power cable
⑤	NMEA 2000 drop cable from the stereo, up to 6 m (20 ft.)
⑥	NMEA 2000 drop cable from the chartplotter MFD or compatible FUSION NMEA 2000 remote control
⑦	9 to 16 Vdc power supply
⑧	NMEA 2000 terminator or backbone cable
⑨	NMEA 2000 T-connector
⑩	NMEA 2000 terminator or backbone cable

Configuring an Optional Wired Remote

NOTICE

The stereo is configured by default to work with a NMEA 2000 network, and the NRX POWER option should be enabled only when an optional remote is connected directly to the stereo. Enabling this option when the stereo is connected to a NMEA 2000 network may damage other devices on the NMEA 2000 network.

If you connect an optional wired NRX remote directly to the stereo, and not through a NMEA 2000 network, additional configuration is needed.

1 Select > > **NMEA**.

2 Select an option:

- If you connected both your stereo and your optional wired remote to a NMEA 2000 network, make sure the **NRX POWER** option is not selected. This enables the optional remote to receive power from the NMEA 2000 network.
- If you connected the optional wired remote directly to the stereo through the NMEA 2000 connector, select the **NRX POWER** option. This enables the stereo to supply power to the optional remote.

FUSION PartyBus Networking

The FUSION PartyBus networking feature allows you to connect multiple compatible stereos and zone stereos together on a network, using a combination of wired or wireless connections.

A FUSION PartyBus stereo, such as an Apollo RA770 stereo, can stream sources to other FUSION PartyBus devices connected to the network. Connected FUSION PartyBus devices can also control media playback on the FUSION PartyBus stereo. A FUSION PartyBus zone stereo, such as an Apollo SRX400 zone stereo can stream from a FUSION

PartyBus stereo, but cannot stream sources to other FUSION PartyBus devices on the network.

You can connect up to eight FUSION PartyBus devices on a network.

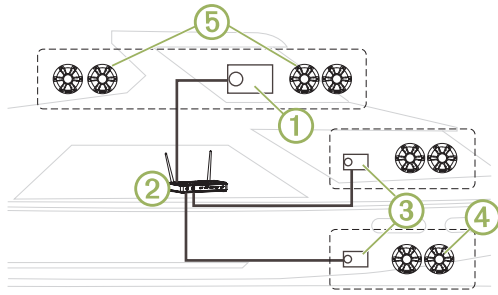

In the image above, one Apollo RA770 stereo ① connects to a wireless router ② and to two Apollo SRX400 zone stereos ③. The two FUSION PartyBus stereo zone stereos can stream sources from the FUSION PartyBus stereo.

A FUSION PartyBus zone stereo is not the same thing as a speaker zone. It is an independent stereo that can either play media from connected sources or stream from a FUSION PartyBus stereo on the network. You can connect a FUSION PartyBus zone stereo, such as an Apollo SRX400 zone stereo, to a single speaker zone ④. You can connect a FUSION PartyBus stereo, such as an Apollo RA770 stereo, to multiple speaker zones ⑤ to cover a larger area with that stereo. FUSION PartyBus devices cannot control the speaker volume of another stereo. You can adjust the volume of speakers or speaker zones connected directly to the stereo only.

Wired Networking Considerations

When you are planning your network installation, observe the following considerations for all wired connections.

- Wired connections are more reliable than wireless connections. When planning your network, you should use network cables to connect FUSION PartyBus devices to the network when possible.
- You must connect devices using standard Cat5e or Cat6 network cables with RJ45 connectors.
- You can use one network cable to directly connect two compatible devices.
- You may need to use wired network switches and wired or wireless network routers when you connect more than two compatible stereos to a network.
- If you install a router on the network, it should be configured to be the DHCP server by default. See your router instructions for more information.
- If you do not install a router on the network, you must configure one FUSION PartyBus device to be the DHCP server.

Wired Network Example for Direct Connections

You must configure one FUSION PartyBus device as a DHCP server when connecting two devices together directly.

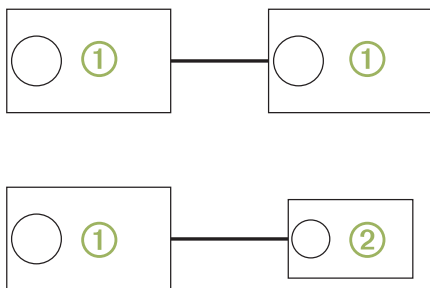

①	FUSION PartyBus stereo
②	FUSION PartyBus zone stereo

Wired Network Example with a Switch or Router

You must use wired network switches, a wired network router, or both to connect more than two FUSION PartyBus devices.

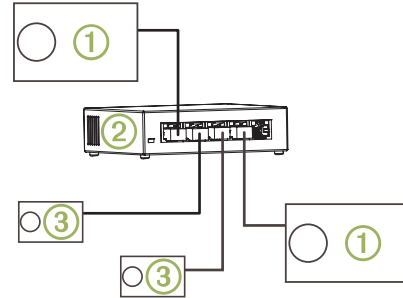

①	FUSION PartyBus stereo
②	Wired network switch or wired network router
③	FUSION PartyBus zone stereo

Wireless Networking Considerations

When you are planning your network, observe the following considerations for all wireless connections.

- Wired connections are more reliable than wireless connections. You should plan your network to use network cables, but if it is not possible, FUSION PartyBus devices are Wi-Fi® compatible. You can connect them to wireless routers or access points.
- You can configure a FUSION PartyBus device as a wireless access point, so you can connect devices within wireless range.
- If you install a wireless router on the network, it should be configured to be the DHCP server by default. See your wireless router instructions for more information.
- If you do not install a router or wireless router on the network, you must configure one FUSION PartyBus device to be the DHCP server.
- You can configure any FUSION PartyBus device on the wired network to be a wireless access point, even if you install a wireless router or additional wireless access points on the network. This would be useful to allow access to devices in range of the stereo but not in range of the other wireless access points.
- If you connect a FUSION PartyBus device to the network wirelessly, you cannot connect any additional wired FUSION PartyBus devices to that device.
- You can connect a smartphone to the wireless network to control any stereo on the network using the FUSION-Link™ app.
- You can connect an Apple® device to the wireless network to stream media to a single stereo on the network using Apple AirPlay®.

Wireless Access Point Example

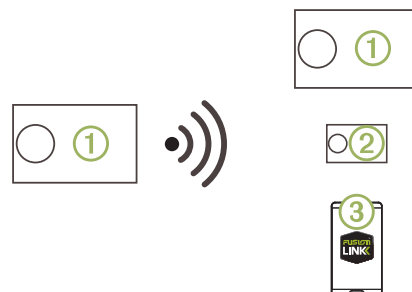

①	FUSION PartyBus stereo
②	FUSION PartyBus zone stereo
③	Smartphone using the FUSION-Link app

Wireless Network Example with a Wired Switch or Router

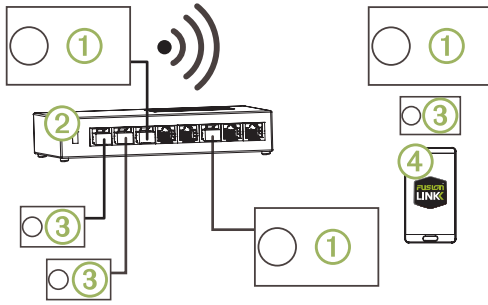

①	FUSION PartyBus stereo
②	Wired network switch or wired network router
③	FUSION PartyBus zone stereo
④	Smartphone using the FUSION-Link app.

Wireless Network Example with a Wireless Router or Access Point

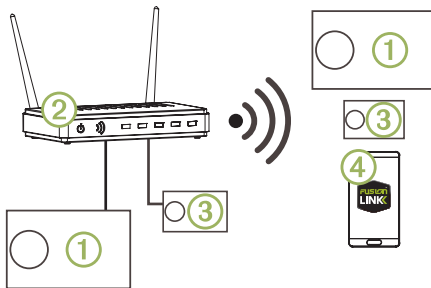

①	FUSION PartyBus stereo
②	Wireless network router or wireless access point
③	FUSION PartyBus zone stereo
④	Smartphone using the FUSION-Link app

Constructing a Network

You should have a basic understanding of networking when building a network for FUSION PartyBus devices.

These instructions guide you through the basics of building and configuring a network, and should apply to most situations. If you need to perform advanced networking tasks, such as assigning static IP addresses to devices on the network or configuring advanced settings on a connected router, you may need to consult a networking professional.

- 1 Determine the installation location of the FUSION PartyBus devices you want to connect to the network.

NOTE: Wired connections are more reliable than wireless connections. When planning your network, you should run network cables instead of using wireless connections when possible.

- 2 Determine the installation location of any needed network routers or switches.
- 3 Route Cat5e or Cat6 network cable to the installation locations of the stereos, switches, and router.
- 4 Connect the network cables to the stereos, switches, and router.

NOTICE

Do not completely install the stereos yet. You should test the network before you install the stereos.

- 5 Turn on all devices connected to the network, including wireless devices.
- 6 Select an option:
 - If you are not using a network router (wired or wireless), configure one FUSION PartyBus device to be the DHCP server (*Setting the FUSION PartyBus Device as the DHCP Server*, page 6). All other stereos should use their default configuration (automatic IP).
 - If you are using a network router (wired or wireless), consult the documentation provided with your router to configure the router as the DHCP server, if necessary. All stereos should use their default configuration (automatic IP).
- 7 Configure a stereo as a wireless access point, if necessary (*Setting the FUSION PartyBus Device as a Wireless Access Point*, page 6).
- 8 Configure a FUSION PartyBus stereo or zone stereo to connect to a wireless access point or router, if necessary (*Connecting the FUSION PartyBus Device to a Wireless Access Point*, page 6).
- 9 Test the network by viewing the list of FUSION PartyBus devices from each device on the network and select an option:
 - If any FUSION PartyBus devices are not available to the network, troubleshoot the network (*Network Troubleshooting*, page 7).
 - If all FUSION PartyBus devices are available to the network, complete the installation for each stereo, if necessary.

Network Configuration

TIP: You can select the network status icon from any screen to open the network configuration menu.

Setting the FUSION PartyBus Device as the DHCP Server

If you connected two FUSION PartyBus devices together directly, or connected more than two together using a network switch and did not install a router, you must configure only one FUSION PartyBus stereo to be the DHCP server.

Select **≡** > **⚙** > **NETWORK** > **ADVANCED** > **DHCP SERVER** > **DHCP ENABLED** > **SAVE**.

Setting the FUSION PartyBus Device as a Wireless Access Point

Before you can connect additional FUSION PartyBus devices or smartphones to a FUSION PartyBus device wirelessly, you must configure at least one device as a wireless access point. This is not necessary if you installed a wireless router or other wireless access point on the network.

- 1 Select **≡** > **⚙** > **NETWORK** > **WI-FI ACCESS POINT**.
- 2 Select **SSID**, and enter the SSID, or name, for the wireless access point.
- 3 Select **AP SECURITY**, and select the security type for the access point (optional).

NOTE: It is strongly recommended that you set the AP SECURITY using WPA2 PERSONAL. It is the most widely-used and secure wireless security protocol.
- 4 Select **PASSWORD**, and enter a password for the access point (optional).
- 5 If necessary, select **COUNTRY**, and select your region.
- 6 Select **SAVE**.

Connecting the FUSION PartyBus Device to a Wireless Access Point

- 1 Select **≡** > **⚙** > **NETWORK** > **WI-FI CLIENT** > **SSID**.
A list of wireless access points within range appears.
- 2 Select the FUSION PartyBus wireless access point.

3 Select an option:

- To enter the password, select **PASSWORD**, enter the password, and select **✓**.
- If you are connecting to the wireless access point using WPS, verify that WPS has been enabled on the access point, and select **WPS**.

NOTE: It can take up to two minutes to successfully connect to the access point after you select **WPS**.

4 Select **SAVE**.

Resetting Network Settings

You can reset all network settings for this stereo to the factory default values.

Select **≡** > **⚙** > **NETWORK** > **RESET** > **YES**.

Advanced Network Configuration

You can perform advanced networking tasks on a FUSION PartyBus device, such as defining DHCP ranges and setting static IP addresses. See the owner's manual for more information.

Network Troubleshooting

If you cannot see or connect to FUSION PartyBus devices on the network, check the following:

- Verify that only one device, either a stereo or a router, is configured as a DHCP server.
- Verify that all FUSION PartyBus devices, network switches, routers, and wireless access points are connected to the network and turned on.
- Verify that wireless FUSION PartyBus devices are connected to a wireless router or wireless access point on the network.
- If you configured static IP addresses, verify that every device has a unique IP address, that the first three sets of numbers in the IP addresses match, and that the subnet masks on every device are identical.
- If you have made configuration changes that might be causing networking issues, reset all network settings to factory defaults.

Stereo Information

Specifications

General	
Weight	750 g (26.5 oz.)
Water resistance	IEC 60529 IPX7 (front of stereo only, when properly installed)
Operating temperature range	From 0 to 50°C (from 32 to 122°F)
Storage temperature range	From -20 to 70°C (from -4 to 158°F)
Input voltage	From 10.8 to 16 Vdc
Current (max.)	15 A
Current (muted)	Less than 900 mA
Current (off, standby mode enabled)	110 mA
Current (off, standby mode disabled)	80 mA
Fuse	15 A mini blade-type
NMEA 2000 LEN	1 (50 mA)
Bluetooth® wireless range	Up to 10 m (30 ft.)
ANT® wireless range	Up to 3 m (10 ft.)
Wireless frequencies/protocols	Wi-Fi 2.4 GHz @ +15 dBm nominal Bluetooth 2.4 GHz @ +10 dBm nominal ANT 2.4 GHz @ +4 dBm nominal
Compass-safe distance	15 cm (5.9 in.)

On-board, Class D Amplifier	
Output music power per channel	4 x 70 W max. 2 ohm
Total output peak power	280 W max.
Output power per channel	4 x 43 W RMS at 14.4 Vdc input, 2 ohm, 10% THD* 4 x 26 W RMS at 14.4 Vdc input, 4 ohm, 10% THD*
Line output level (max.)	5.5 V (peak to peak)
Aux input level (typical)	1 V RMS

*The stereo may limit the output power to prevent the amplifier from overheating, and to maintain the audio dynamics.

Tuner	Europe and Australasia	USA	Japan
FM radio frequency range	87.5 to 108 MHz	87.5 to 107.9 MHz	76 to 95 MHz
FM frequency step	50 kHz	200 kHz	50 kHz
AM radio frequency range	522 to 1620 kHz	530 to 1710 kHz	522 to 1620 kHz
AM frequency step	9 kHz	10 kHz	9 kHz

Stereo Dimension Drawings

Front Dimensions

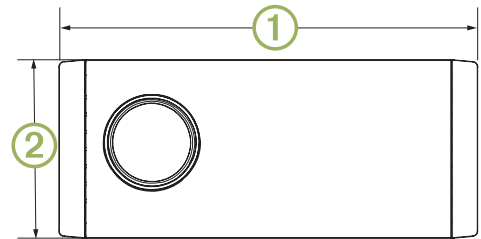

①	192 mm (7.56 in.)
②	82 mm (3.23 in.)

Side Dimensions

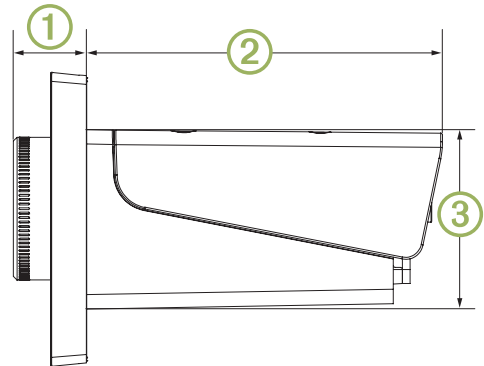

①	20.4 mm (0.8 in.)
②	99 mm (3.9 in.)
③	50 mm (1.97 in.)

Top Dimensions

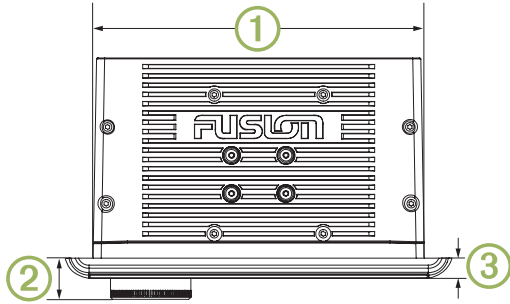

①	164 mm (6.5 in.)
②	20.4 mm (0.8 in.)
③	10 mm (0.39 in.)

Registering Your Apollo RA770

Help us better support you by completing our online registration today.

- Go to fusionentertainment
- Keep the original sales receipt, or a photocopy, in a safe place.

Software Updates

For best results, you should update the software in all FUSION devices at the time of installation to ensure compatibility.

You can update the software using the FUSION-Link remote control app on your compatible Apple or Android™ device, or using a USB flash drive.

To download the app and update the device software, go to the Apple App StoreSM or the Google Play™ store. For software updates and instructions on updating the device using the USB flash drive, go to the device product page at fusionentertainment/marine.

