

FUSION[®] Apollo[™] RA770

OWNER'S MANUAL



Getting Started

⚠ WARNING

See the *Important Safety and Product Information* guide in the product box for product warnings and other important information.

Stereo Controls



① Dial	<ul style="list-style-type: none"> Turn to adjust the volume. <ul style="list-style-type: none"> When adjusting the volume, press to switch between zones. When adjusting the volume, press and hold for at least one second to adjust the subwoofer levels. On a screen with tabs, press and hold for at least one second to switch the tab. Turn to move through the menus or adjust a setting. When in a menu, press to select the highlighted option.
② Source Icon	<ul style="list-style-type: none"> Press to change the source (Selecting a Source, page 1). Hold to open the PARTYBUS menu (FUSION PartyBus Networking, page 8).
③ ≡	Select to open a menu for the current source. Not available on all sources.
⚙	Select to open the stereo settings menu.
⏻	<ul style="list-style-type: none"> Press to turn on the stereo. Press to mute the stereo. Press and hold to turn off the stereo.

Selecting a Source

1 Select the source icon.

The source icon is in the lower-left corner of the stereo screen, and shows the source that is currently selected.

2 Select a source.

TIP: On the source selection screen you can turn the dial to highlight and select a source.

Playback Controls

The on-screen playback controls may change depending on the source selected.

NOTE: After playing media for about five seconds, the playback controls are hidden by the gesture screen. You can swipe down on the screen to view the playback controls ([Gesture Screen, page 1](#)).

⏸	Select to pause media playback.
▶	<ul style="list-style-type: none"> Select to play media or resume media playback. DAB source: press to scan for DAB stations.

⏮	<ul style="list-style-type: none"> Select to skip to the previous track, when using an applicable source. Hold to rewind the track when using an applicable source. AM, FM, or SiriusXM (in Live Mode) source: <ul style="list-style-type: none"> Select to tune to the previous station or preset. Hold for faster tuning (manual mode only). SiriusXM (in Replay Mode) source: <ul style="list-style-type: none"> Select to skip to the previous track. Hold to rewind the current track. DAB source: Select to return to the previous DAB station in the ensemble. When you reach the beginning of the current ensemble, the stereo automatically changes to the last available station in the previous ensemble.
⏭	<ul style="list-style-type: none"> Select to skip to the next track, when using an applicable source. Hold to fast-forward the track when using an applicable source. AM, FM, or SiriusXM (in Live Mode) source: <ul style="list-style-type: none"> Select to tune to the next station or preset. Hold for faster tuning (manual mode only). SiriusXM (in Replay Mode) source: <ul style="list-style-type: none"> Select to skip to the next track, if applicable. Hold to fast-forward the current track, if applicable. DAB source: Select to advance to the next DAB station in the ensemble. When you reach the end of the current ensemble, the stereo automatically changes to the first available station in the next ensemble.
⏪	Select to cycle through the tuning modes (auto or manual) and presets. Press and hold to save the current station as a preset.
⏩	Hold to switch between Replay Mode and Live Mode (Using Replay Mode, page 5). Replay Mode: press to pause and play the channel. Live Mode: Select to cycle through the tuning modes (manual or category) and presets.
+	On the Aux or OPTICAL source, select to increase the gain for the connected source.
-	On the Aux or OPTICAL source, select to decrease the gain for the connected source.

Gesture Screen

After playing media for about five seconds, a screen appears showing track information and album art only. You can use the touchscreen to interact with this screen.

- You can swipe left or right to change the track or preset.
- You can touch the screen for about one second to pause playback or mute the audio, depending on the source.
- You can swipe down to return to the playback controls screen.

NOTE: You can disable this screen in the settings ([Power Options, page 9](#)).

Stereo Screen

The information displayed on the stereo screen varies depending on the source selected. The on-screen playback controls may change depending on the source selected ([Playback Controls, page 1](#)). This example shows the stereo playing a track from USB device connected to the USB port.



①	Source
②	Network status (<i>Network Status Icons</i> , page 12)
③	Album art (if available from a compatible source)
④	Track details (if available)
⑤	Elapsed time, track duration, and the current track number out of the total number of tracks in the playlist (if available)
⑥	Select to change the source (<i>Selecting a Source</i> , page 1).
Source icon	

Adjusting the Backlight and Dial Brightness

NOTE: If you connected the dim wire on the wiring harness to the boat's illumination wire, the backlight and dial dim automatically when the boat lights are on. This may affect how you adjust the brightness setting.

- 1 Select > > **BRIGHTNESS**.
- 2 Adjust the brightness level.

Enabling Standby Mode

You can set the stereo to enter a low-power standby mode when you turn off the ignition or hold . When you turn on the ignition or press again, it takes less than the typical 30 seconds to turn on.

NOTE: When the stereo is in low-power standby mode, it continues to draw current from the battery. The maximum current draw in standby mode is 110 mA.

Select > > **POWER OPTIONS** > **STANDBY MODE**.

The stereo now enters standby mode when you hold .

Media Player Connection

CAUTION

Always disconnect your media player from the stereo when not in use and do not leave it in your vessel. This helps reduce the risk of theft and damage from extreme temperatures.

Do not remove the media player or use your stereo in a distracting manner while operating the vessel. Check and obey all marine laws in association with use.

The stereo accepts a variety of media players, including smartphones and other mobile devices. You can connect a compatible media player using a Bluetooth® wireless connection or a USB connection to the USB port. The stereo can play media from Universal Plug and Play (UPnP) devices, such as a Network Attached Storage (NAS) device connected to the same network. The stereo can play media from compatible Apple® device connected to the same network using the AirPlay® feature.

USB Device Compatibility

You can use a USB flash drive or the USB cable included with your media player to connect a media player or mobile device to the USB port.

The stereo is compatible with iAP2 Apple devices such as the iPhone® X, iPhone 8 Plus, iPhone 8, iPhone 7 Plus, iPhone 7, iPhone SE, iPhone 6s Plus, iPhone 6s, iPhone 6 Plus, iPhone 6, iPhone 5s, iPhone 5c, iPhone 5, and iPod touch® (5th and 6th generation).

The stereo is compatible with Android™ devices that support MTP mode.

The stereo is compatible with media players and other USB mass storage devices, including USB flash drives. Music on USB drives must meet these conditions:

- The USB mass storage device must be formatted using the FAT32 or NTFS file system.
- The music files must be formatted as MP3, AAC (.m4a), or FLAC, files.

- If you connect a portable hard drive, you must connect it to an external power source. The USB port on this stereo cannot provide power for a portable hard drive.

Connecting a USB Device

You can connect a USB device to the USB port on the stereo.

- 1 Locate the USB port on the back of the stereo.
- 2 Connect the USB device to the USB port.
- 3 Select the USB source.

Connecting an Auxiliary Device

You can connect various auxiliary devices to the stereo. These devices have either RCA connectors, a line output, or a headphone output jack.

- 1 Locate the auxiliary connectors on the wiring harness.
- 2 If necessary, connect an RCA-to-3.5 mm adapter cable to the auxiliary device.
- 3 Connect the auxiliary device to the AUX IN RCA connectors on the wiring harness.
- 4 Select the **Aux** source.

Optical Audio Connection

You can connect devices with an optical audio output to the stereo using an optical audio cable. Televisions, DVD players, CD players, and other devices may supply digital optical audio output.

This stereo supports PCM audio only. You may have to change the settings on your device to output PCM audio.

NOTE: Because streaming audio over the FUSION PartyBus™ network introduces a slight delay, streaming content from a television or DVD player may not be ideal. You can disable OPTICAL as a streaming source in the settings, if needed (*General Settings*, page 9).

Connecting to a Garmin® Watch

For a list of a compatible Garmin watches, go to [fusionentertainment](#)



For more information about the watch, see the watch manual at [garmin/manuals](#).

- 1 Following the instructions in the watch manual, install the FUSION-Link Lite™ app from the Connect IQ™ store onto the watch.
- 2 On the stereo, select the **BT** source.
- 3 Select > **DISCOVERABLE**.
The stereo remains discoverable for two minutes.
- 4 Bring the watch within 3 m (10 ft.) of the stereo.
NOTE: Stay 10 m (33 ft.) away from other ANT® devices while pairing.
- 5 Open the FUSION-Link Lite app on the watch.
The first time you open the app on the watch, the watch automatically pairs with and connects to the stereo. If you need to pair to another stereo, in the FUSION-Link Lite app, select **Settings** > **Pair new**.
- 6 Control the audio playback using the FUSION-Link Lite app on the watch.

After the devices are paired, they connect automatically when they are turned on, within range, and the app is open on the watch.



Connecting an Apple Device Using AirPlay

- 1 From the settings menu on your Apple device, connect to the same wireless network as your compatible FUSION® stereo.
NOTE: You can connect some Apple devices to the network using a wired Ethernet connection, if applicable. Go to the Apple website for more information.

- 2 On your Apple device, open the music app you want to stream to the stereo.
- 3 From the music app or program, select  or , and select the name of the stereo.
- 4 If necessary, start playing music on the app.
The stereo changes to the AirPlay source automatically and plays audio from your Apple device.
NOTE: On some AirPlay devices, adjusting the volume on the device affects the volume level on the stereo.
NOTE: You cannot stream the AirPlay source to other stereos on the network using the FUSION PartyBus feature.

Setting an AirPlay Password

You can set a password that a user must enter when connecting to the stereo using the AirPlay feature.

- 1 Select  >  > **AirPlay PASSWORD**.
- 2 Enter a password.

NOTE: The AirPlay password is case-sensitive.

When connecting to this stereo using the AirPlay feature, the user must enter the password on their Apple device.

Connecting a UPnP Device

You must connect your stereo to a network, either wired or wirelessly, to play media from a UPnP device, such as a NAS device.

- 1 Connect your UPnP device to the same network as the stereo, referring to the instructions provided with your UPnP device and router if necessary.
- 2 Select the UPnP source on the stereo ([Selecting a Source, page 1](#)).

You can browse and play media from the UPnP device the in same way that you would from a USB flash drive ([Controlling Music Playback on a Connected Android Device, USB Flash Drive, or Media Player, page 4](#)).

Audio Control

Adjusting the Volume

- 1 Turn the dial to open the volume screen.
- 2 Select an option:
 - Use the touchscreen to adjust the volume levels for each zone.
 - Use the dial to adjust the volume for the highlighted zone.
- 3 If necessary, press the dial to switch between zones.

TIP: To control all zones at the same time, you can press the dial until GLOBAL is highlighted, or use the touchscreen to adjust the GLOBAL zone.

Muting all Connected Stereos

You can quickly mute the audio from this stereo or from all stereos connected to the network ([FUSION PartyBus Networking, page 8](#)).

- 1 From any source, select .
The mute symbol appears and audio from this stereo is silenced.
- 2 Select **MUTE SYSTEM**.
Audio from all connected stereos is silenced.
- 3 Select **UNMUTE SYSTEM**.
Audio is restored to all connected stereos.



Adjusting the Tones

- 1 Select  >  > **ZONE**.
- 2 Select a zone.

- 3 Select **TONE**.
- 4 Select an option:
 - Use the slider bar to adjust the level of each tone.
 - Press the dial to select a tone, and turn the dial to adjust the level for the tone.



Disabling the Loud Setting for a Zone

The LOUD setting maintains frequency response at low volumes and increases perceived loudness at high volumes. This setting is enabled by default in all zones.

- 1 Select  >  > **ZONE**.
- 2 Select a zone.
- 3 Select **LOUD** to clear the check box.

Adjusting the Gain for an Auxiliary Device

You can adjust the gain for a connected auxiliary device to achieve a volume level similar to that of other media sources. You can adjust the gain in 1 dB increments. You can also adjust the gain for digital sources using an optical audio connection.

- 1 Select an auxiliary source.
- 2 Select an option:
 - To increase the gain, select .
 - To decrease the gain, select .



NOTE: To achieve the best audio quality when using a portable media player with headphone output, it may be necessary to adjust the volume control on the media player, instead of adjusting the gain.

Speaker Zones

You can group speakers in one area into a speaker zone. This enables you to control the audio level of the zones individually. For example, you could make the audio quieter in the cabin and louder on deck.

You can set the balance, volume limit, tone, subwoofer level, subwoofer frequency, and name for each zone, and configure other zone-specific settings ([Speaker Zone Settings, page 9](#)).

Adjusting the Audio Settings for a Zone

- 1 Select  >  > **ZONE**.
- 2 Select a zone.
- 3 Select **MORE**.
- 4 Select one or more options:



NOTE: Not all options are available for all zones.

 - To limit the maximum volume output of this zone, select **VOLUME LIMIT**, and adjust the level.
 - To set the subwoofer level for this zone, select **SUB LEVEL**, and adjust the level.
 - To adjust the right and left speaker balance of this zone, select **BALANCE**, and adjust the balance.

Adjusting the Subwoofer Filter

You can use the subwoofer filter setting to control the subwoofer cutoff frequency for each zone, which can enhance the blend of the sound produced by the speakers and the subwoofer. Audio signals above the selected frequency are not passed to the subwoofer.

NOTE: If a DSP setting has been applied to zone, this setting cannot be changed on the stereo. You can view the DSP setting for the optimal cutoff frequency as calculated by the DSP controller, but cannot adjust it.

- 1 Select  >  > **ZONE**.
- 2 Select a zone.
- 3 Select **SUB FREQ**.

- 4 Select a frequency.

DSP Settings



This stereo features digital signal processing (DSP). You can select pre-configured DSP settings for FUSION speakers and amplifiers to optimize audio reproduction in their installed locations.

All DSP settings are configured using the FUSION-Link™ remote control app (*FUSION-Link Remote Control App, page 11*).

Configuring the DSP Settings

You must download and install the FUSION-Link remote control app on your compatible Apple or Android device before you can configure the DSP settings (*FUSION-Link Remote Control App, page 11*).

You can configure the DSP settings to optimize the sound on each zone with the installed speakers, amplifiers, and environment.

- 1 From the settings menu on your Apple or Android device, connect to the stereo using Bluetooth technology, or connect to the same wireless network as the stereo.
- 2 Open the FUSION-Link remote control app on your compatible Apple or Android device.
- 3 If necessary, select the stereo you want to configure.
- 4 Select .
- 5 If necessary, select the **MUSIC SETTINGS** tab.
- 6 Select **Zone**.
- 7 Select a zone.
- 8 Select **DSP SETTINGS**.
- 9 Configure the DSP settings as needed, depending on the models of FUSION speakers and amplifiers connected to the zone.
- 10 Repeat these steps for each zone.
- 11 After you have finished configuring the DSP settings for all zones, select an option:
 - On an Apple device, select  > **Zone** > **SETTINGS** > **SEND DSP SETTINGS**
 - On an Android device, select  > **Zone** > **SEND DSP SETTINGS**.

Bluetooth Device Playback

You can pair the stereo to up to eight Bluetooth media devices.

You can control the playback using the stereo controls on all Bluetooth devices, and on some devices you can browse the music collection from the menu on the stereo. On Bluetooth devices that do not support media browsing, you should select the song or playlist on the media device.

The availability of song information such as song title, artist name, track duration, and album art depends on the capability of the media player and music application.

Connecting a Compatible Bluetooth Device

You can play media from a compatible Bluetooth device using the Bluetooth wireless connection.

You can control the music playback with the media app on a Bluetooth device or using the FUSION-Link remote control app (*FUSION-Link Remote Control App, page 11*).

- 1 Select the **BT** source.
- 2 Select  > **DISCOVERABLE** to make the stereo visible to your compatible Bluetooth device.
- 3 Enable Bluetooth on your compatible Bluetooth device.
- 4 Bring the compatible Bluetooth device within 10 m (33 ft.) of the stereo.

- 5 On your compatible Bluetooth device, search for Bluetooth devices.
- 6 On your compatible Bluetooth device, select the stereo from the list of detected devices.
- 7 On your compatible Bluetooth device, follow the on-screen instructions to pair and connect to the discovered stereo.

When pairing, your compatible Bluetooth device may ask you to confirm a code on the stereo. The stereo does not display a code, but it does connect correctly when you confirm the message on the Bluetooth device.
- 8 If your compatible Bluetooth device does not immediately connect to the stereo, repeat steps 1 through 7.

The DISCOVERABLE setting is disabled automatically after two minutes.

NOTE: On some Bluetooth devices, adjusting the volume on the device affects the volume level on the stereo.

Bluetooth Range Information

The stereo and Bluetooth wireless devices have a range of 10 m (33 ft.). For optimal performance, the Bluetooth wireless device should also have a clear line of sight to the stereo.

Selecting a Different Bluetooth Source

When you have more than one Bluetooth device paired to the stereo, you can select a different source when needed. You can pair the stereo with up to eight Bluetooth devices.

- 1 With the **BLUETOOTH** source selected, select .
- 2 Select a Bluetooth device.

Bluetooth Source Settings

With the **BLUETOOTH** source selected, select .

DISCOVERABLE: Allows the stereo to be visible to Bluetooth devices. This setting turns off automatically after two minutes to prevent possible interruption to audio after pairing a Bluetooth device to the stereo.

REMOVE DEVICE: Removes the Bluetooth device from the stereo. To listen to audio from this Bluetooth device again, you must pair the device again.

USB Device Playback

You can connect various USB media players, USB flash drives, and smartphones to the stereo. How you access the USB source depends on the type of connected media player or smartphone.

Media Player	Source Selections
Android device	MTP
Apple device	IPOD
USB flash drive	USB
MP3 media player (as a mass-storage device)	USB NOTE: If your MP3 media player does not support mass-storage when connected using USB, you must connect it to the stereo as an auxiliary device (<i>Connecting an Auxiliary Device, page 2</i>).

NOTE: The availability of song information such as song title, artist name, and track duration depends on the capability of the media player and music application.

Controlling Music Playback on a Connected Android Device, USB Flash Drive, or Media Player

- 1 Connect a compatible Android device, USB flash drive, or media player to the stereo.

- 2 Select the appropriate source on the stereo.
 - 3 Select .
 - 4 If necessary, select the name of the device or USB drive to view the file structure.
 - 5 Select a song to begin music playback.
- You can use the stereo controls to select, play, pause, and skip tracks.

Controlling Music Playback on a Connected Apple Device

- 1 Connect a compatible Apple smartphone or media player to the stereo using USB or Bluetooth (if available).
- 2 Select the appropriate source on the stereo.
- 3 Launch a music application on the connected device, and begin playback.

You can use the music application or the stereo controls to select, play, pause, and skip tracks.

Radio

To listen to AM or FM radio, you must have a suitable marine AM/FM antenna properly connected to the stereo and be within range of a broadcasting station. For instructions on connecting an AM/FM antenna, see the stereo installation instructions.

To listen to SiriusXM® radio, you must have the appropriate equipment and subscriptions (*SiriusXM Satellite Radio, page 5*). For instructions on connecting a SiriusXM Connect Vehicle Tuner, see the stereo installation instructions.

To listen to DAB stations, you must have the appropriate equipment (*DAB Playback, page 8*). For instructions on connecting a DAB adapter and antenna, see the installation instructions provided with your adapter and antenna.

Setting the Tuner Region



You must select the region you are in to receive AM and FM stations properly.

If you are connected to a compatible SiriusXM tuner and antenna, and have a subscription (USA only), you must select the region you are in to receive SiriusXM stations properly.



NOTE: SiriusXM is not available in all regions.



If you are connected to a compatible DAB module and antenna (not included), you must select the region you are in to receive DAB stations properly.

NOTE: DAB stations are not available in all regions.

- 1 Select  >  > **TUNER REGION**.
- 2 Select the region you are in.

Changing the Radio Station

- 1 Select an applicable source, such as **FM**.
- 2 Select  repeatedly to move through the tuning modes, and select an option:
 - Select **Auto** to scan and stop on the next available station.
 - Select **Manual** to select a station manually.
 - Select **Preset** to select a saved station preset.
- 3 Select  or  to tune to the station.

When in Manual tuning mode, you can hold  or  to quickly advance through the stations.

SiriusXM Satellite Radio

Only SiriusXM brings you more of what you love to listen to, all in one place. Get over 140 channels, including commercial-free music plus the best sports, news, talk, comedy and

entertainment. Welcome to the world of satellite radio. A SiriusXM Vehicle Tuner and subscription are required.

Enabling the SiriusXM Source

You must enable the SiriusXM source before you can listen to SiriusXM Satellite Radio.

Select  >  > **TUNER REGION > USA**.

Locating the SiriusXM Radio ID

You must have the radio ID of your SiriusXM Connect Tuner before you can activate your SiriusXM subscription. You can locate the SiriusXM Radio ID on the back of the SiriusXM Connect Tuner or its packaging, or by tuning your stereo to channel 0.

With the SiriusXM source selected, select  > **CHANNELS > All Channels > 000 Radio ID**.

The SiriusXM Radio ID does not include the letters I, O, S, or F.

Activating a SiriusXM Subscription

- 1 With the SiriusXM source selected, tune to channel 1.

You should be able to hear the preview channel. If not, check the SiriusXM Connect Tuner and antenna installation and connections, and try again.
- 2 Tune to channel 0 to locate the Radio ID.
- 3 Contact SiriusXM listener.
- 4 Provide the Radio ID.

The activation process usually takes 10 to 15 minutes, but can take up to an hour. For the SiriusXM Connect Tuner to receive the activation message, it must be turned on and receiving the SiriusXM signal.
- 5 If the service is not activated within the hour

Selecting a Category

You can control which categories of channels are available when using the CATEGORY tuning method.







- 1 With the SiriusXM source selected, select  > **CATEGORY**.
- 2 Select a category.

Using Replay Mode

You can use Replay Mode to control playback of a SiriusXM broadcast.

NOTE: The device enables Replay Mode automatically when playing saved preset channels.

- 1 If necessary, hold  to enable Replay Mode.

 changes to Replay Mode, and a progress bar appears.
- 2 Select an option:
 - Tap  to pause and resume playback.
 - Hold  to exit Replay Mode.
 - Hold  or  to rewind or fast-forward the track.
 - Tap  or  to skip backward or forward in increments.

NOTE: If you fast-forward or skip forward to the end of the progress bar, the stereo exits Replay Mode automatically.

Alerts

Adding an Artist or Song Alert

You can set alerts for artists and songs so that when a particular song or a song from a particular artist begins to play on any music channel, you can quickly tune to that channel.

- 1 While a particular song or a song from a particular artist is playing, select **≡** > **ADD ALERT** > **SAVE ARTIST/SONG**.
- 2 Select the song or the artist.

Adding Teams for Game Alerts

You can set alerts for sports teams so that when a game featuring a saved team begins to play on any sports channel, you can quickly tune to that channel.

NOTE: A Game Alert is different than a SportsFlash™ alert. A Game Alert lets you know when a game begins, while a SportsFlash alert lets you know when an exciting play occurs during a game.

- 1 Select **≡** > **ADD ALERT** > **GAME ALERT TEAMS**.
- 2 Select a sports league.
- 3 Select a team to fill the check box and add a Game Alert.
- 4 Repeat steps 2 and 3 for each team you want to add to the list of Game Alerts.

Adding Teams from a Live Game

While listening to a game, you can quickly add a team playing to your list of Game Alert teams.

- 1 While listening to a game on a channel, select **≡** > **ADD ALERT** > **SAVE TEAMS**.
A list of teams playing in the current game appears.
- 2 Select the team or teams to add to your list of Game Alert teams.

Viewing Active Alerts

You can review active Artist, Song, and Game Alerts.

- 1 Select **≡** > **ACTIVE ALERTS**.
- 2 Select a category.

Managing Alerts

You can manage your saved alerts to select which ones you want to receive. You can delete saved alerts you do not want.

- 1 Select **≡** > **SXM SETTINGS** > **ALERTS MANAGEMENT**.
- 2 Select an option:
 - To enable saved alerts for songs only, artists only, or both artists and songs, select **ENABLE BY TYPE**, and select a type.
 - To enable saved alerts for specific artists only, select **ENABLE ARTISTS**, and select the artists.
 - To enable saved alerts for specific songs only, select **ENABLE SONGS**, and select the songs.
 - To enable saved game alerts for specific teams, select **ENABLE TEAMS**, and select the teams.
 - To delete all saved alerts for songs, artists, or teams, select **DELETE BY TYPE**, and select a type.
 - To delete saved alerts for specific artists, select **DELETE ARTISTS**, and select the artists.
 - To delete saved alerts for specific songs, select **DELETE SONGS**, and select the songs.
 - To delete saved Game Alerts for specific teams, select **DELETE TEAMS**, and select the teams.

TuneMix™ Feature

Starting and Stopping a TuneMix Collection

Before you can start playing a TuneMix collection, you must create one ([Creating and Customizing a TuneMix Collection, page 6](#)).

The TuneMix feature enables you mix your favorite music channels to create a custom listening experience.

- 1 Select **≡** > **TUNEMIX**.
- 2 Select a TuneMix collection.
The stereo begins playing the TuneMix collection.
- 3 To stop playing a TuneMix collection, select **≡** > **CHANNELS**, and select a channel.
The stereo stops playing the TuneMix collection and begins playing the selected channel.

Creating and Customizing a TuneMix Collection

You can create up to 10 unique TuneMix collections on the stereo.

- 1 Select **≡** > **SXM SETTINGS** > **TUNEMIX SETUP**.
- 2 Select a TuneMix collection.
- 3 Select a channel to fill the check box and add it to the TuneMix collection.
- 4 After you are finished customizing the TuneMix collection, select **<**.
- 5 Repeat steps 2 through 4 for each TuneMix collection you want to customize.

SportsFlash Feature

The SportsFlash feature alerts you to key plays from your favorite teams during a live game. When an exciting play happens, a SportsFlash alert appears, and you can tune to the broadcast and hear the play. When the SportsFlash alert ends, you can choose to return to the previous channel, or remain tuned to the game.

To receive SportsFlash alerts, your subscription package must include play-by-play sports channels for the sports leagues you want to include in the alerts.

You can enable, disable, or delete SportsFlash alerts that you have added ([Managing Alerts, page 6](#)).

NOTE: A SportsFlash is different than a Game Alert. A SportsFlash alert lets you know when an exciting play occurs during a game, while a Game Alert lets you know when a game begins.

Adding Teams to Receive SportsFlash Alerts

- 1 Select **≡** > **SPORTSFLASH** > **TEAM SELECT**.
- 2 Select a sports league.
- 3 Select a team to fill the check box and add a SportsFlash alert.
- 4 Repeat steps 2 and 3 for each team you want to add to the list of SportsFlash alerts.

Changing SportsFlash Team Priority

If more than one team for which you have set up SportsFlash alerts are playing at the same time, you can adjust the team priority to hear SportsFlash alerts from your preferred team first.

- 1 Select **≡** > **SPORTSFLASH** > **TEAM PRIORITIES**.
A list of your selected SportsFlash teams appears, in order of priority.
- 2 Select a team to move it up one priority level in the list.
- 3 Repeat the previous step with each team you want to reorder until the priority list is ordered the way you prefer.

Enabling the TuneStart™ Feature

When you enable the TuneStart feature and tune to a preset channel, the stereo starts the current song from the beginning of the song instead of starting it from the point it is at in the live broadcast.

NOTE: The TuneStart feature is available when tuning to preset channels only.

If necessary, select **≡ > SXM SETTINGS > TUNESTART**.

When the TuneStart feature starts a song from the beginning, a progress bar appears and you can control the track using the same controls as Replay Mode (*Using Replay Mode, page 5*).

Parental Controls

The parental control feature allows you to limit access to any SiriusXM channels, including those with mature content. When the parental control feature is enabled, you must enter a passcode to tune to the locked channels. You can also change the 4-digit passcode.

Unlocking the Parental Controls

You can unlock the parental controls to access locked channels.

- 1 With the **SiriusXM** source selected, select **≡ > PARENTAL**.
- 2 Select the **UNLOCK** check box.
- 3 Enter the passcode.

TIP: The default passcode is 0000.

The parental controls remain unlocked until you turn off the vehicle or until you lock them again.

SiriusXM Troubleshooting

Advisory	Description	Resolutions
Check Antenna	The radio has detected a fault with the SiriusXM antenna. The antenna cable may be disconnected or damaged.	<ul style="list-style-type: none"> • Verify the antenna cable is connected to the SiriusXM Connect Vehicle Tuner. • Inspect the antenna cable for damage and kinks. Replace the antenna if the cable is damaged. SiriusXM products are available at your local car audio retailer.
Check Tuner	The stereo is having difficulty communicating with the SiriusXM Connect Vehicle Tuner. The tuner may be disconnected or damaged.	Verify the SiriusXM Connect Vehicle Tuner cable is connected securely to the stereo.
No Signal	The SiriusXM Connect Vehicle Tuner is having difficulty receiving the SiriusXM satellite signal.	<ul style="list-style-type: none"> • Verify the SiriusXM antenna is outdoors with a clear view of the sky. • Verify the SiriusXM antenna is mounted securely. • Remove obstructions above or next to the SiriusXM antenna. • Inspect the cable antenna for damage and kinks. Replace the antenna if the cable is damaged. SiriusXM products are available at your local car audio retailer or at shop.siriusxm • Consult the SiriusXM Connect Vehicle Tuner installation instructions for more information on antenna installation.
Subscription Updated	The radio has detected a change in your SiriusXM subscription status.	<ul style="list-style-type: none"> • Select any button to clear the message. •
Channel Not Available	The channel you requested is not a valid SiriusXM channel, or the channel that you were listening to is no longer available. You may see this message briefly the first time you connect a new SiriusXM Connect Vehicle Tuner.	Go to siriusxm for more information about the SiriusXM channel lineup.
Channel Not Subscribed	The channel you requested is not included in your SiriusXM subscription package, or the channel you were listening to is no longer included in your SiriusXM subscription package.	
Channel Locked	The channel you requested is locked by the parental control feature.	Refer to the parental control section in the owner's manual to unlock channels.

Clearing SiriusXM Data

You can clear all entered SiriusXM user information, such as favorite teams and alerts.

Use the **FACTORY RESET** option in the settings menu to reset the stereo (*Update Options, page 11*).

Locking Channels

- 1 With the **SiriusXM** source selected, select **≡ > PARENTAL**.
- 2 Select the **UNLOCK** check box.
- 3 Enter the passcode.
TIP: The default passcode is 0000.
- 4 Select **LOCK/UNLOCK**.

A list of available channels appears.

- 5 Select one or more channels to lock, and select **↵**.
- 6 Clear the **UNLOCK** check box to lock the parental controls.

You cannot access the locked channels while the parental controls are locked. You must unlock the parental controls to tune the locked channels.

Clearing All Locked Channels

- 1 With the **SiriusXM** source selected, select **≡ > PARENTAL > UNLOCK**.
- 2 Enter the passcode.
- 3 Select **≡ > PARENTAL > CLEAR ALL LOCKED**.

Changing the Parental Control Passcode

- 1 With the **SiriusXM** source selected, select **≡ > PARENTAL > UNLOCK**.
- 2 Enter the passcode.
- 3 Select **≡ > PARENTAL > CHANGE PIN**.
- 4 Follow the on-screen instructions.

NOTE: The factory reset setting resets all data in the stereo, including AM and FM presets, zone settings, etc. in addition to clearing all SiriusXM user information.

DAB Playback

When you connect a compatible Digital Audio Broadcasting (DAB) module and antenna, such as the MS-DAB100A to the Apollo RA770 stereo, you can tune in to and play DAB stations.

DAB broadcasts are not available in all regions. When the stereo is not set to a compatible region, the DAB source is not available.

Setting the Tuner Region

You must select the region you are in to receive DAB stations properly.

- 1 Select > > **TUNER REGION**.
- 2 Select the region you are in.

Scanning for DAB Stations

Before you can scan for DAB stations, you must connect a compatible DAB module and antenna (not included) to the stereo. Because DAB signals are broadcast in select countries only, you must also set the tuner region to a location where DAB signals are broadcast.

- 1 Select the **DAB** source.
- 2 Select to scan for available DAB stations.

When scanning is complete, the first available station in the first ensemble found begins playing.

NOTE: After the first scan is complete, you can select again to re-scan for DAB stations. When the re-scan is complete, the system starts playing the first station in the ensemble you were listening to when you started the re-scan.

Changing DAB Stations

- 1 Select the **DAB** source.
- 2 If necessary, select to scan for local DAB stations.
- 3 Select or to change the station.

When you reach the end of the current ensemble, the stereo automatically changes to the first available station in the next ensemble.

Selecting a DAB Station from a List

- 1 Select the **DAB** source.
- 2 If necessary, select to scan for local DAB stations.
- 3 Select > **BROWSE** > **STATIONS**.
- 4 Select a station from the list.

Selecting a DAB Station from a Category

- 1 Select the **DAB** source.
- 2 If necessary, select to scan for local DAB stations.
- 3 Select > **BROWSE** > **CATEGORIES**.
- 4 Select a category from the list.
- 5 Select a station from the list.

Presets

You can save your favorite AM stations and FM stations as presets for easy access.

You can save your favorite SiriusXM channels if you are connected to an optional SiriusXM tuner and antenna.

You can save your favorite DAB stations if you are connected to an optional DAB antenna.

Saving a Station as a Preset

- 1 With an applicable source selected, tune the stereo to a station or a channel.
- 2 Select the **PRESETS** tab.

- 3 Select .

TIP: You can quickly save the selected AM/FM station or DAB channel as a preset by holding .

Selecting a Preset from a List

- 1 With an applicable source selected, select the **PRESETS** tab.
- 2 Select a preset from the list.

Removing Presets

- 1 With an applicable source selected, select the **PRESETS** tab.
- 2 Select .
- 3 Select each preset you want to remove.
- 4 When you are finished removing presets, select .

FUSION PartyBus Networking

The FUSION PartyBus networking feature allows you to connect multiple compatible stereos and zone stereos together on a network, using a combination of wired or wireless connections.

A FUSION PartyBus stereo, such as an Apollo RA770 stereo, can stream sources to other FUSION PartyBus devices connected to the network. Connected FUSION PartyBus devices can also control media playback on the FUSION PartyBus stereo. A FUSION PartyBus zone stereo, such as an Apollo SRX400 zone stereo can stream from a FUSION PartyBus stereo, but cannot stream sources to other FUSION PartyBus devices on the network.

You can connect up to eight FUSION PartyBus devices on a network wirelessly.

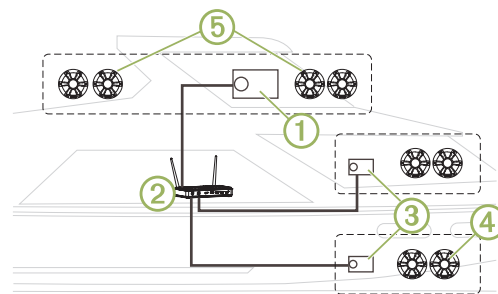

In the image above, one Apollo RA770 stereo ① connects to a wireless router ② and to two Apollo SRX400 zone stereos ③. The two FUSION PartyBus stereo zone stereos can stream sources from the FUSION PartyBus stereo.

A FUSION PartyBus zone stereo is not the same thing as a speaker zone. It is an independent stereo that can either play media from connected sources or stream from a FUSION PartyBus stereo on the network. You can connect a FUSION PartyBus zone stereo, such as an Apollo SRX400 zone stereo, to a single speaker zone ④. You can connect a FUSION PartyBus stereo, such as an Apollo RA770 stereo, to multiple speaker zones ⑤ to cover a larger area with that stereo. FUSION PartyBus devices cannot control the speaker volume of another stereo. You can adjust the volume of speakers or speaker zones connected directly to the stereo only.

Streaming from a FUSION PartyBus Device on the Network

Before you can stream from a device on the network, you must set up and configure your FUSION PartyBus devices according to the installation instructions.

NOTE: You cannot stream the Apple AirPlay source to other stereos on the network using the FUSION PartyBus feature.

- 1 Select the source icon.

The source icon is in the lower-left corner of the stereo screen, and shows the source that is currently playing.

2 Select **PARTYBUS**

TIP: You can press and hold the source icon to show available FUSION PartyBus devices.

The device shows a list of available FUSION PartyBus devices on the network.

3 Select the device you want to stream from.

The stereo begins streaming the same source as the connected FUSION PartyBus device, and a green border appears around the device screen. All media playback functions affect both devices.

Stopping Streaming from a FUSION PartyBus Device on the Network

If you are streaming from a FUSION PartyBus device on the network, you must disconnect from the device before you can play local sources on the stereo.

1 Select the source icon.

The source icon is in the lower-left corner of the stereo screen, and shows the source that is currently playing.

2 Select **PARTYBUS > LEAVE PARTYBUS**.

TIP: You can press and hold the source icon to quickly leave the FUSION PartyBus network.

Network UPnP Playback

This stereo can play content from Universal Plug and Play (UPnP) devices connected to the network, such as computers and media servers. You must connect your UPnP device to the same network as the stereo using a wired or wireless connection, and you must configure the device to share media over the network. See the owner's manual from your UPnP device for more information.

After you have connected your UPnP device to the network and configured it to share media, the UPnP source appears on the source selection screen of each stereo on the network (*Selecting a Source, page 1*).

General Settings

Select  > .

NOTE: When a check box is filled, the option is on. When the check box is clear, the option is off.

ZONE: Enables you to configure the speaker zones (*Speaker Zone Settings, page 9*).

BRIGHTNESS: Adjusts the screen and dial backlight brightness (*Adjusting the Backlight and Dial Brightness, page 2*).

TUNER REGION: Sets the region used by the FM, AM, DAB, and SiriusXM sources.

LANGUAGE: Sets the language on the device.

DEVICE NAME: Sets a name for this stereo.

TELEMUTE: Sets the behavior of the mute function when the device is connected to a hands-free mobile phone. When a call is received, the device can either mute the audio or broadcast the call through the Aux1 input. See your hands-free kit instructions.

SEARCHING: Enables FUSION Alpha Search Technology (FAST), which allows you to quickly search for tracks by letter or number. You can select a number to enable the FAST menu if your music device contains more than the selected number of items.

AirPlay PASSWORD: Sets a password that a user must enter when connecting to the stereo using the AirPlay feature (*Setting an AirPlay Password, page 3*).

POWER OPTIONS: Adjusts power settings, such as the power-save mode (*Power Options, page 9*).

PARTYBUS SETTINGS: Sets the sources the device can stream over the FUSION PartyBus network. You may want to disable some sources, such as OPTICAL, because streaming over the network introduces a small audio lag that is not desirable in some situations.

NETWORK: Enables you to configure the device network settings (*Network Configuration, page 10*).

UPDATE: Updates the stereo or connected devices (*Update Options, page 11*).

ABOUT: Shows the software version information for the stereo.

Speaker Zone Settings

Setting a Zone Name

You can set a name for a speaker zone to make it easier to identify.

1 Select  >  > **ZONE**.

2 Select a zone.

3 Select **ZONE NAME**.

4 Use the on-screen keyboard to enter a name, and select .

Linking Zones

You can link zones 1 and 2 to keep the volume levels synchronized. Adjusting the volume of either of the linked zones affects both zones.

Select  >  > **ZONE > ZONE 2 > LINK TO ZONE 1**.

When zones 1 and 2 are linked,  appears on zones 1 and 2 on the volume screen.

NOTE: After zones 1 and 2 are linked, you cannot adjust the volume of each zone individually.

Enabling Volume Control of Zone 3 or 4 from a Connected Amplifier

By default the volume of zones 3 and 4 are controlled by the stereo. You can control the volume of these zones using the connected amplifier instead.

1 Select  >  > **ZONE**.

2 Select zone 3 or zone 4.

3 Select **VOLUME CONTROL** to clear the check box.

The audio signal from the zone is provided to the amplifier as a fixed-line-level output.

Disabling a Zone

You can disable an unused zone and remove it from the audio level pages. When a zone is disabled, you cannot change any of the settings for that zone. You can disable zones 2, 3, and 4 only.

1 Select  >  > **ZONE**.

2 Select a zone.

3 Select **ZONE ENABLED** to clear the check box.

Disabling the Internal Amplifiers

If you do not connect speakers directly to zones 1 and 2, you can disable the internal amplifiers to reduce power consumption.

1 Select  >  > **ZONE**.

2 Select **INTERNAL AMP ON** to clear the check box.

Power Options

Select  >  > **POWER OPTIONS**.

NOTE: When a check box is filled, the option is on. When the check box is clear, the option is off.

POWER SAVE: Disables the LCD backlight after one minute of inactivity to save battery power.

STANDBY MODE: Enables a low-power standby instead of turning off the stereo completely. When enabled, the stereo turns on much faster, but the stereo uses more battery when in standby mode than when turned off (*Enabling Standby Mode, page 2*).

GESTURE SCREEN: Enables the screen that hides the playback controls to show track info and album art only when playing media (*Gesture Screen, page 1*).

NRX POWER: Turns on or off the power the stereo provides to optional NRX series wired remote controls not on a NMEA 2000® network (*Configuring an Optional Wired Remote, page 11*).





SYSTEM OFF: Sends a signal to turn off on all devices connected to the network.

Network Configuration

TIP: You can select the network status icon from any screen to open the network configuration menu.



Setting the FUSION PartyBus Device as the DHCP Server

If you connected two FUSION PartyBus devices together directly, or connected more than two together using a network switch or wireless access point and did not install a router, you must configure only one FUSION PartyBus stereo to be the DHCP server.

- 1 Select  >  > **NETWORK > ADVANCED > ETHERNET IP > STATIC IP > SAVE.**
- 2 Select  >  > **NETWORK > ADVANCED > DHCP SERVER > DHCP ENABLED > SAVE.**
You can configure the IP address range of the DHCP server (*DHCP Settings, page 10*).



Setting the FUSION PartyBus Device as a Wireless Access Point

Before you can connect additional FUSION PartyBus devices or smartphones to a FUSION PartyBus device wirelessly, you must configure at least one device as a wireless access point. This is not necessary if you installed a wireless router or other wireless access point on the network.

- 1 Select  >  > **NETWORK > WI-FI ACCESS POINT.**
- 2 Select **SSID**, and change the default SSID, or name, for the wireless access point (optional).
- 3 Select **AP SECURITY**, and change the security type for the access point (optional).
NOTE: It is strongly recommended that you use the default WPA2 PERSONAL AP SECURITY setting. It is the most widely-used and secure wireless security protocol.
- 4 Select **PASSWORD**, and change the default password for the access point (optional).
- 5 If necessary, select **COUNTRY**, and select your region.
- 6 Select **CHANNEL**, and select a channel range for the access point (optional).
- 7 Select **SAVE**.

You can adjust the wireless access point configuration at any time (*Wireless Access Point Settings, page 10*).

Connecting the FUSION PartyBus Device to a Wireless Access Point

- 1 Select  >  > **NETWORK > WI-FI CLIENT > SSID.**
A list of wireless access points within range appears.
- 2 Select the FUSION PartyBus wireless access point.
- 3 Select an option:
 - To enter the password, select **PASSWORD**, enter the password, and select .

- If you are connecting to the wireless access point using WPS, verify that WPS has been enabled on the access point, and select **WPS**.



NOTE: It can take up to two minutes to successfully connect to the access point after you select **WPS**.

4 Select **SAVE**.

Advanced Network Configuration

You can perform advanced networking tasks on a FUSION PartyBus device, such as defining DHCP ranges and setting static IP addresses.

Wireless Access Point Settings

Select  >  > **NETWORK > ADVANCED > WI-FI ACCESS POINT.**

NOTE: You must configure the device to be a wireless access point before you can change the settings (*Setting the FUSION PartyBus Device as a Wireless Access Point, page 10*).

SSID: Sets the SSID, or name, for the network.

AP SECURITY: Sets the type of wireless security protocol used by the access point.

NOTE: It is strongly recommended that you set the AP SECURITY using WPA2 PERSONAL. It is the most widely-used and secure wireless security protocol.

PASSWORD: Sets the password for the access point. This is not available when the AP SECURITY setting is set to NONE.

COUNTRY: Sets the region where the stereo is located. Different regions may use different channels on the wireless spectrum, so you should set this to best accommodate local wireless devices.

CHANNEL: Sets the access point to use a group of channels in the high, low, or middle range of the available spectrum for your region. You may experience better performance if you set the channel in a range with fewer broadcasting access points.

DHCP SERVER: Sets the device to act as a wireless access point and the DHCP server on the network (*DHCP Settings, page 10*).

WPS: Initiates a Wi-Fi® Protected Setup (WPS) connection. Devices with a WPS button or setting can connect to the access point on this stereo when the WPS connection is active.

NOTE: It can take up to two minutes to successfully connect to the access point after you select WPS.

DHCP Settings

Select  >  > **NETWORK > ADVANCED > DHCP SERVER.**

DHCP ENABLED: Sets the device as the DHCP server on the network.

START IP: Sets the first IP address in the IP-address range of the DHCP server.

END IP: Sets the final IP address in the IP-address range of the DHCP server.

Setting a Static IP Address

If the stereo is configured as a DHCP server, it is automatically assigned the IP address of 192.168.0.1. You can change this IP address.

If the stereo is a client on the network and you do not want the DHCP server to automatically assign an IP address to the stereo, you can set a static IP address.

NOTE: Every device on the network must have a unique IP address. If you select a static IP address that is the same as the IP address on the network, the devices will not work properly.

- 1 Select  >  > **NETWORK > ADVANCED.**

2 Select an option:

- If the stereo is connected using an Ethernet cable, select **ETHERNET IP > STATIC IP**.
- If the stereo is set as a wireless access point or wireless client, select **WI-FI STATIC IP**.

3 Select an option:

- To set the IP address, select **IP**, and enter the IP address.
- To set the subnet mask, select **MASK**, and enter the subnet mask.

NOTE: The subnet mask must match all other devices on the network to work properly. A typical subnet mask is 255.255.255.0.

- To set the default gateway IP address, select **GATEWAY**, and enter the gateway IP address.

NOTE: The default gateway is typically set as the IP address of the DHCP server on the network.

4 Select **SAVE**.

Resetting Network Settings

You can reset all network settings for this stereo to the factory default values.

Select  >  > **NETWORK > RESET > YES**.

Update Options

Select  >  > **UPDATE**.

NOTICE

Do not turn off the stereo or disconnect the power during a software update. Turning off the power during a software update may cause the stereo to become unresponsive.

NOTE:

- When possible, you should perform device updates using the FUSION-Link app on a smartphone connected to the same network as the stereo. You should use a USB flash drive only if necessary.
- The stereo may restart a few times when updating. This is normal.
- You can program only newer versions of software on the stereo.

STEREO: Updates the stereo using a valid software update file on a connected USB flash drive.

NRX REMOTE: Updates an optional NRX remote connected to the NMEA 2000 port or NMEA 2000 network using a valid software update file on a connected USB flash drive.

DAB MODULE: Updates an optional DAB module connected to the SIRIUS XM port using a valid software update file on a connected USB flash drive.

FACTORY RESET: Restores all settings to the factory default values.

Additional Stereo Control Options

FUSION-Link Remote Control App

You can use the FUSION-Link remote control app on your compatible Apple or Android device to adjust the stereo volume, change the source, control playback, select and manage radio presets, and adjust some stereo settings. You can use the app to set up and configure DSP profiles on the stereo. You can use the app to update the stereo software wirelessly.

The app communicates with the stereo using a wireless connection to the mobile device. You must connect your compatible device to the stereo using Bluetooth or Wi-Fi technology to use the app.

If the stereo is connected to a network with a Wi-Fi access point, the app can communicate with the stereo using the network for greater range than a Bluetooth connection.

NOTE: You must connect the app using a Wi-Fi connection to update the stereo software wirelessly. You cannot update device software using a Bluetooth connection.

For information about the FUSION-Link remote control app for compatible Apple or Android devices, go to the Apple App StoreSM or the Google PlayTM store.

FUSION-Link™ Network Technology

FUSION-Link network technology allows you to fully control compatible FUSION entertainment systems on compatible multi-function displays installed at the helm, flybridge, or navigation station of the vessel. This provides integrated entertainment control and a less cluttered console.

The partnered multi-function display becomes the portal on which you can control all audio on the vessel, no matter where on the vessel the connected stereo is installed. The FUSION-Link equipped stereo can be installed out of sight if space is an issue and users need to access the stereo only to replace removable media.

FUSION-Link technology on this device can communicate using existing industry-standard network connections including Ethernet and Wi-Fi wireless technology.

FUSION-Link technology offered on this device can communicate using existing industry-standard NMEA 2000 networks.

For a list of FUSION-Link capable products from companies partnered with FUSION.

NMEA 2000 Remote Control and Display

The stereo can be controlled by compatible FUSION wired remote controls installed in the audio zones throughout the vessel. Operating the entertainment system from the remote control is similar to operating it from the main stereo.

FUSION wired remote controls operate over an existing NMEA 2000 network, so wiring the remote controls directly to the stereo is not necessary. All remote controls connected to the same NMEA 2000 network as the stereo can control the stereo.

If your vessel does not have a NMEA 2000 network, you can directly connect a single FUSION remote control or create a FUSION remote control network to connect multiple FUSION wired remote controls directly to the NMEA 2000 connector on the stereo. See the installation instructions provided with your stereo and remote for more information.

The FUSION wired remote control can also serve as an NMEA[®] display showing NMEA navigation data or vessel performance data from other NMEA devices on an existing NMEA 2000 network. See the instructions provided with your remote control for information on supported NMEA 2000 PGN information.

Configuring an Optional Wired Remote

NOTICE

The stereo is configured by default to work with a NMEA 2000 network, and the NRX POWER option should be enabled only when an optional remote is connected directly to the stereo. Enabling this option when the stereo is connected to a NMEA 2000 network may damage other devices on the NMEA 2000 network.

If you connect an optional wired NRX remote directly to the stereo, and not through a NMEA 2000 network, additional configuration is needed.

1 Select  >  > **NMEA**.

2 Select an option:

- If you connected both your stereo and your optional wired remote to a NMEA 2000 network, make sure the **NRX POWER** option is not selected. This enables the optional remote to receive power from the NMEA 2000 network.
- If you connected the optional wired remote directly to the stereo through the NMEA 2000 connector, select the **NRX POWER** option. This enables the stereo to supply power to the optional remote.

NMEA 2000 Information

NMEA 2000 is the most popular marine standard for data communication within vessels. It has become the standard for sending navigation and engine management data within vessels. FUSION introduces an industry-first product by incorporating NMEA 2000 functionality in its audio remote control devices. This enables the user to monitor a series of NMEA sentences available over the NMEA 2000 network on a connected remote control.

Go to [fusionentertainment](#) for a full list of supported NMEA sentences.

Appendix

Registering Your Apollo RA770

Help us better support you by completing our online registration today.

- Go to [fusionentertainment](#)
- Keep the original sales receipt, or a photocopy, in a safe place.

Troubleshooting

The stereo does not respond to key presses

- Hold  until the stereo turns off, and turn it on again to reset the stereo.
- Disconnect power to the stereo for two minutes to reset the stereo.

The stereo keeps locking up when connected to an Apple device

- Press and hold the power button to reset the stereo.
- Reset the Apple device. Go to [apple](#) for more information.
- Make sure you have the latest version of iTunes® and the latest operating software on your Apple device.

The stereo is not finding my connected Apple device

- Make sure your Apple device supports Interface Accessory Protocol 2 (iAP2). This stereo is not compatible with iAP1 devices.
- Make sure you have the latest version of iTunes and the latest operating software on your Apple device.
- Make sure you have the latest version of the FUSION-Link application on your Apple device.
- Reset the Apple device.
Go to [apple](#) for more information.
- Contact your FUSION dealer or send an email to FUSION from [fusionentertainment](#)

My Apple AirPlay audio is interrupted by short breaks

- Make sure the Apple device is not covered or obstructed.
- Make sure the Apple device has a good connection to the same Wi-Fi network as the stereo.
- Make sure the Apple device is not connected to the stereo using Bluetooth technology and Wi-Fi.

Using both a Bluetooth and a Wi-Fi connection may cause playback interruptions.

My Bluetooth audio is interrupted by short breaks

- Ensure the media player is not covered or obstructed.
Bluetooth technology performs best with line-of-sight operation.
- Bring the media player within 10 m (33 ft.) of the stereo.
- Turn off the **DISCOVERABLE** setting after pairing a Bluetooth device to the stereo.

The stereo does not display all song information from my Bluetooth source

The availability of song information such as song title, artist name, track duration, and album cover artwork depends on the capability of the media player and music application.





Network Troubleshooting

If you cannot see or connect to FUSION PartyBus devices on the network, check the following:

- Verify that only one device, either a stereo or a router, is configured as a DHCP server.
- Verify that all FUSION PartyBus devices, network switches, routers, and wireless access points are connected to the network and turned on.
- Verify that wireless FUSION PartyBus devices are connected to a wireless router or wireless access point on the network.
- If you configured static IP addresses, verify that every device has a unique IP address, that the first three sets of numbers in the IP addresses match, and that the subnet masks on every device are identical.
- If you have made configuration changes that might be causing networking issues, reset all network settings to factory defaults.

Network Status Icons

A network-status icon is shown on some screens of the stereo. You can refer to this table to understand the appearance of the icon and help diagnose issues with the FUSION PartyBus network ([Network Troubleshooting](#), page 12).

	The stereo is configured for a wired network connection and connected correctly to a wired network using an Ethernet cable.
	The stereo is configured for a wired network connection, but cannot detect the wired network. An Ethernet cable may not be connected or there may be other problems with the network.
	The stereo is configured as a wireless access point.
	The stereo is configured as a wireless client and connected to a wireless access point. The number of bars indicates the signal strength.
	The stereo is configured as a wireless client, but is not connected to a wireless access point. There may be a problem with the connection settings or with the wireless access point.

Specifications

General	
Weight	750 g (26.5 oz.)
Water resistance	IEC 60529 IPX7 (front of stereo only, when properly installed)
Operating temperature range	From 0 to 50°C (from 32 to 122°F)
Storage temperature range	From -20 to 70°C (from -4 to 158°F)
Input voltage	From 10.8 to 16 Vdc
Current (max.)	15 A
Current (muted)	Less than 900 mA
Current (off, standby mode enabled)	110 mA

General	
Current (off, standby mode disabled)	80 mA
Fuse	15 A mini blade-type
NMEA 2000 LEN	1 (50 mA)
Bluetooth wireless range	Up to 10 m (30 ft.)
ANT wireless range	Up to 3 m (10 ft.)
Wireless frequencies/protocols	Wi-Fi 2.4 GHz @ +15 dBm nominal Bluetooth 2.4 GHz @ +10 dBm nominal ANT 2.4 GHz @ +4 dBm nominal
Compass-safe distance	15 cm (5.9 in.)

On-board, Class D Amplifier	
Output music power per channel	4 x 70 W max. 2 ohm
Total output peak power	280 W max.
Output power per channel	4 x 43 W RMS at 14.4 Vdc input, 2 ohm, 10% THD* 4 x 26 W RMS at 14.4 Vdc input, 4 ohm, 10% THD*
Line output level (max.)	5.5 V (peak to peak)
Aux input level (typical)	1 V RMS

*The stereo may limit the output power to prevent the amplifier from overheating, and to maintain the audio dynamics.

Tuner	Europe and Australasia	USA	Japan
FM radio frequency range	87.5 to 108 MHz	87.5 to 107.9 MHz	76 to 95 MHz
FM frequency step	50 kHz	200 kHz	50 kHz
AM radio frequency range	522 to 1620 kHz	530 to 1710 kHz	522 to 1620 kHz
AM frequency step	9 kHz	10 kHz	9 kHz

Stereo Dimension Drawings

Front Dimensions

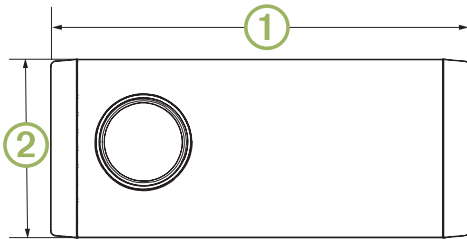

①	192 mm (7.56 in.)
②	82 mm (3.23 in.)

Side Dimensions

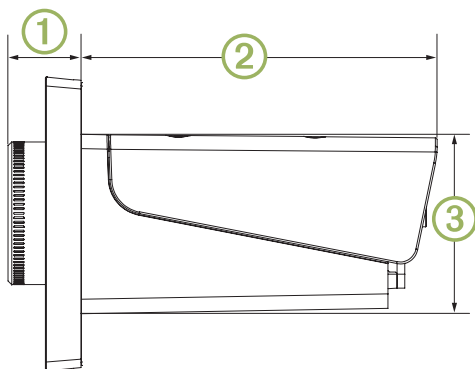

①	20.4 mm (0.8 in.)
②	99 mm (3.9 in.)
③	50 mm (1.97 in.)

Top Dimensions

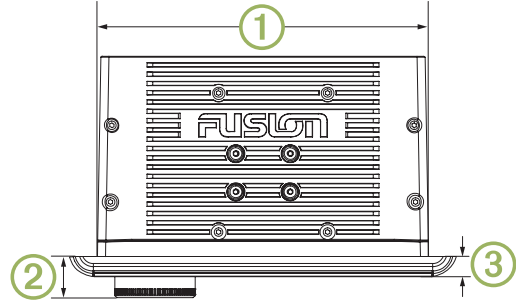

①	164 mm (6.5 in.)
②	20.4 mm (0.8 in.)
③	10 mm (0.39 in.)