

Element™ Blocks



WARNING! Strictly follow all instructions to avoid an accident, damage to your vessel, personal injury or death.

Contents

Introduction

Features	2
Terms	2

Specifications

45 mm blocks	3
60 mm blocks	4
80 mm blocks	5

Line deflection and loading

Line angle deflection and loading factors	6
---	---

Shackle position

Fixed shackle, rotating 90°	7
Swivel shackle, changing from locked	7

Cam cleat adjustments

Adjusting cam arm angle	8
Flipping cam for up release	8

Mounting footblocks

Mounting specifications and warnings	9
--------------------------------------	---

Mounting stand-up blocks

45 mm blocks	10
60 mm and 80 mm blocks	11

Mounting mastbase blocks for forkhead fittings

60 mm and 80 mm blocks	12
------------------------	----

Reeving blocks

4:1 and 5:1 reeving sequence	13
6:1 reeving sequence	14

Maintenance and Warranty

Maintenance, specific and general	15
Warranty reference	15



Features

- Strong durable sideplates** are forged aluminum with hardcoat anodizing.
- Tough sheaves** made from fiber reinforced nylon.
- Proven bearing system** where sheave spins on a stainless axle.
- Versatile cam assembly** adjusts and locks in several positions.
- Adaptable cam cleat** flips around for up or down release.
- Multifunctional headpost lock** fixes shackle in either direction or swivel position.

Terms

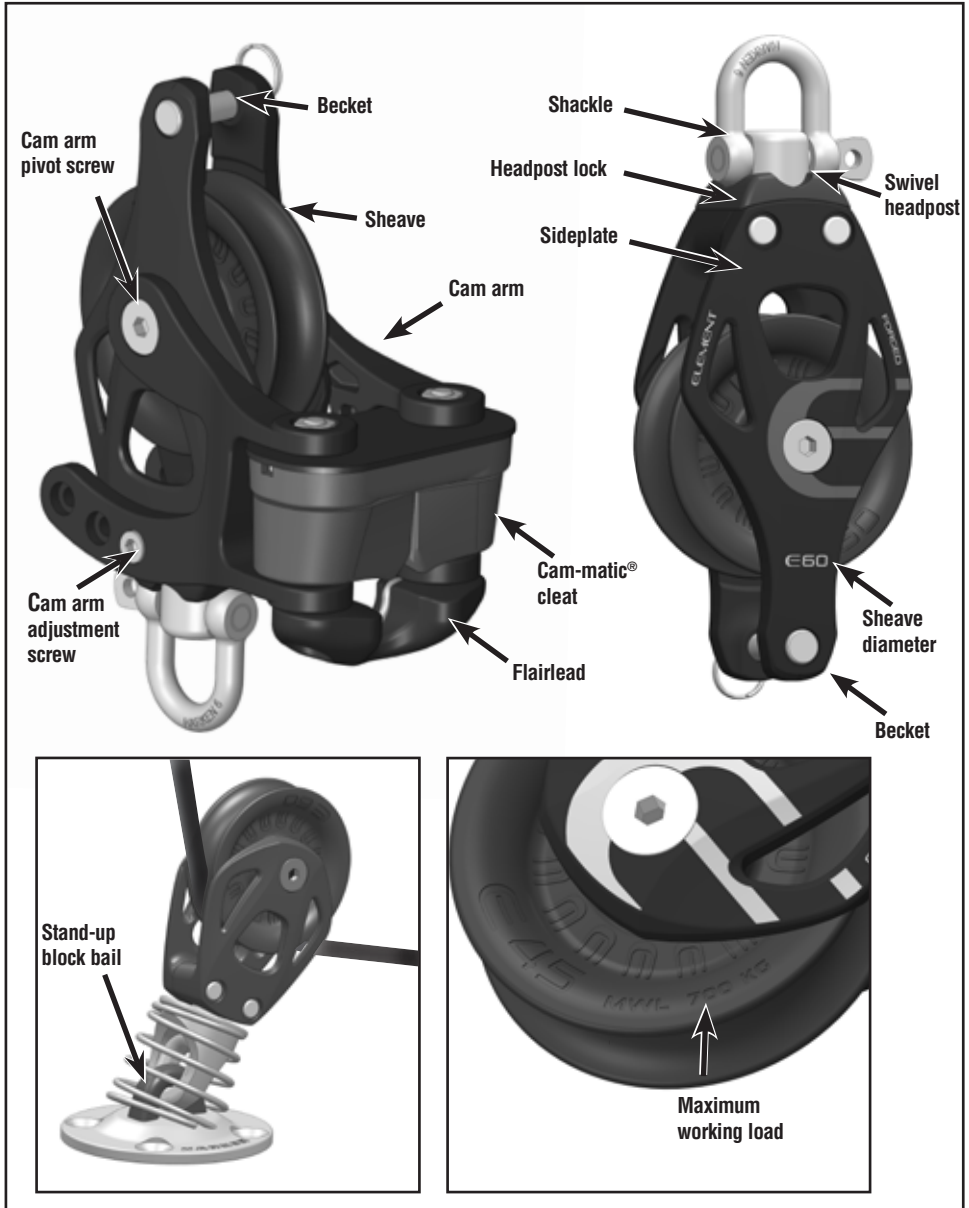

Specifications - 45 mm Blocks



Part No.	Description	Max line* Ø		Maximum working load		Breaking load	
		mm	in	kg	lb	kg	lb
6230	Single/swivel	12	1/2	700	1543	1400	3086
6231	Single/swivel/becket	12	1/2	700	1543	1400	3086
6232	Fiddle/swivel	8	5/16	700	1543	1400	3086
6233	Fiddle/swivel/becket	8	5/16	700	1543	1400	3086
6234	Fiddle/150 Cam-Matic/swivel/becket	8	5/16	550	1213	1100	2426
6235	Fiddle/150 Cam-Matic/swivel	8	5/16	408	900	816	1800
6236	Single/150 Cam-Matic/swivel/becket	12	1/2	272	600	544	1200
6238	Double/swivel	12	1/2	875	1929	1750	3858
6239	Double/swivel/becket	12	1/2	875	1929	1750	3858
6240	Triple/swivel	12	1/2	1050	2315	2100	4630
6241	Triple/swivel/becket	12	1/2	1050	2315	2100	4630
6242	Triple/150 Cam-Matic/swivel	12	1/2	680	1499	1360	2998
6243	Triple/150 Cam-Matic/swivel/becket	12	1/2	816	1799	1632	3598
6250	Single/swivel/stand-up**	12	1/2	700	1543	1400	3086
6251	Single/swivel/stand-up/becket**	12	1/2	700	1543	1400	3086

*Tip: When selecting line diameter, use one size smaller for smooth running blocks.

**Mounts using integral U fastener

Footblocks

45 mm



1 3/4"

Part No.	Description	Fasteners (FH) mm	Max line* Ø		Maximum working load		Breaking load	
			mm	in	kg	lb	kg	lb
6237	Single footblock	6	12	1/2	700	1543	1400	3086

*Tip: When selecting line diameter, use one size smaller for smooth running blocks.

Specifications - 60 mm Blocks



Part No.	Description	Max line* Ø		Maximum working load		Breaking load	
		mm	in	kg	lb	kg	lb
6220	Single mastbase for 8 mm (5/16") pin	14	9/16	1100	2425	2200	4850
6260	Single/swivel	14	9/16	1100	2425	2200	4850
6261	Single/swivel/becket	14	9/16	1100	2425	2200	4850
6262	Fiddle/swivel	10	3/8	1100	2425	2200	4850
6263	Fiddle/swivel/becket	10	3/8	1100	2425	2200	4850
6264	Fiddle/150 Cam-Matic/swivel/becket	10	3/8	550	1213	1100	2426
6265	Fiddle/150 Cam-Matic/swivel	10	3/8	408	900	816	1800
6266	Single/150 Cam-Matic/swivel/becket	12	1/2	272	600	544	1200
6269	Double/swivel	14	9/16	1375	3032	2750	6064
6270	Double/swivel/becket	14	9/16	1375	3032	2750	6064
6272	Triple/swivel	14	9/16	1650	3638	3300	7276
6273	Triple/swivel/becket	14	9/16	1650	3638	3300	7276
6274	Triple/150 Cam-Matic/swivel	12	1/2	680	1499	1360	2998
6275	Triple/150 Cam-Matic/swivel/becket	12	1/2	816	1799	1632	3598
6277	Single/swivel/stand-up**	14	9/16	1100	2425	2200	4850
6278	Single/swivel/stand-up/becket**	14	9/16	1100	2425	2200	4850

*Tip: When selecting line diameter, use one size smaller for smooth running blocks.

**Use 6 mm (1/4") flathead fasteners

Footblocks



Part No.	Description	Fasteners (FH) mm	Max line* Ø		Maximum working load		Breaking load	
			mm	in	kg	lb	kg	lb
6267	Single	8	14	9/16	1100	2425	2200	4850
6268	Single/lockoff	8	14	9/16	1100	2425	2200	4850
6271	Double	8	14	9/16	725	1600	1450	3200
6276	Single/lockoff/left	8	14	9/16	1100	2425	2200	4850

*Tip: When selecting line diameter, use one size smaller for smooth running blocks.

Specifications - 80 mm Blocks

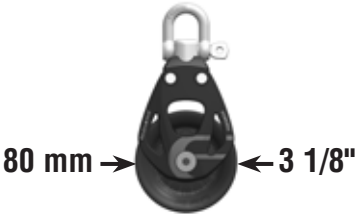

Part No.	Description	Max line* Ø		Maximum working load		Breaking load	
		mm	in	kg	lb	kg	lb
6221	Single Mastbase for 10 mm (3/8") pin	16	5/8	2200	4850	4400	9700
6290	Single/swivel	16	5/8	2200	4850	4400	9700
6291	Single/swivel/becket	16	5/8	2200	4850	4400	9700
6292	Fiddle/swivel	14	9/16	2200	4850	4400	9700
6293	Fiddle/swivel/becket	14	9/16	2200	4850	4400	9700
6296	Double/swivel	16	5/8	2750	6064	5500	12128
6297	Double/swivel/becket	16	5/8	2750	6064	5500	12128
6280	Single/swivel/stand-up**	16	5/8	2200	4850	4400	9700

*Tip: When selecting line diameter, use one size smaller for smooth running blocks.

**Use 8 mm (5/16") flathead fasteners

Footblocks



Part No.	Description	Fasteners (FH) mm	Max line* Ø		Maximum working load		Breaking load	
			mm	in	kg	lb	kg	lb
6294	Single	10	16	5/8	2200	4850	4400	9700
6295	Single/lockoff	10	16	5/8	2200	4850	4400	9700
6298	Double	10	16	5/8	1450	3197	2900	6394
6299	Single/lockoff/left	10	16	5/8	2200	4850	4400	9700

*Tip: When selecting line diameter, use one size smaller for smooth running blocks.

Block Loading vs Angle of Deflection

Block load increases when the line turns at a greater angle. See examples below. Select blocks carefully.

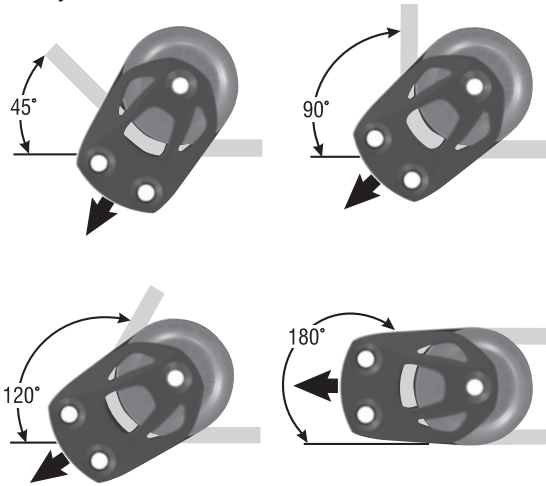

Angle of deflection	Load factor	Angle of deflection	Load factor	Angle of deflection	Load factor
30°	52%	90°	141%	150°	193%
45°	76%	105°	159%	160°	197%
60°	100%	120°	173%	180°	200%
75°	122%	135°	185%	—	—



WARNING! Block loads increase when the line turns at a greater angle. Block loads double when the line turns 180 degrees. Use block loading factors. Select blocks and application carefully.

180° angle of deflection



90° angle of deflection

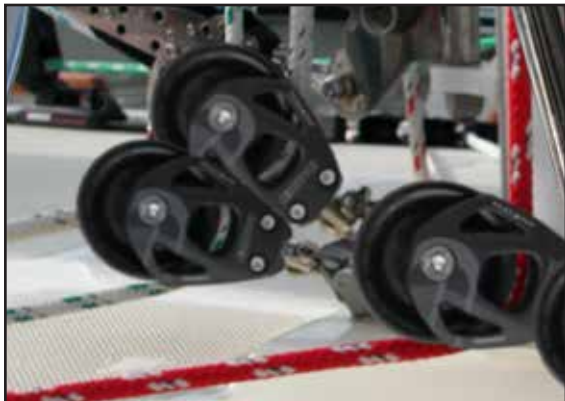

Shackle Rotation

Shackle blocks lock in two directions or swivel to keep line from twisting. Removable headpost lock allows shackle to be fixed or to swivel.



Fixed shackle, rotating 90° - Remove shackle, rotate headpost 90° and reinstall shackle.



Swivel shackle - To change shackle from locked to swivel, remove headpost lock and reinstall shackle.

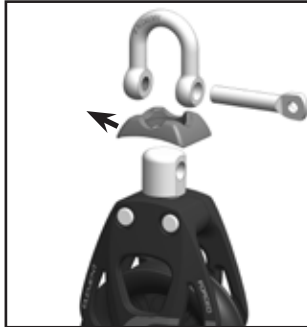

Adjusting Cam Arm Angle

To adjust cam arm angle:

1. Loosen center screws.
2. Remove cam arm adjuster screws.
3. Rotate cam arm to desired position and reinstall screws.

Note: Use threadlocking solution such as blue Loctite® adhesive on screws.



Flipping Cam for Up-Release

The cam can flip to change from down release to up release.

1. Remove nuts and cam arm screws, keeping them in flairlead. Slip cam out.
2. Flip the cam and fasteners around as shown.

Note: Make sure that cam pawls open out from the block and cutout in flairlead faces away from block.

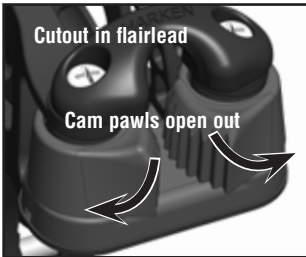

3. Slip fasteners and flairlead through arms and cam. Secure with nuts. Note: Use threadlocking solution such as blue Loctite adhesive on screws.

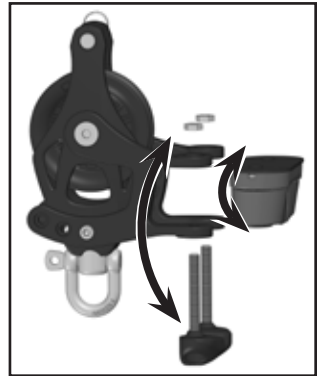

Mounting Footblock



WARNING! You must mount to solid deck construction using specified fasteners in all mounting holes and nuts, washers or backing plates to achieve correct maximum working load to avoid a failure leading to an accident.

Refer to dimensions below for planning location of block. Make sure block bisects the angle as shown in line deflection images on page 6.

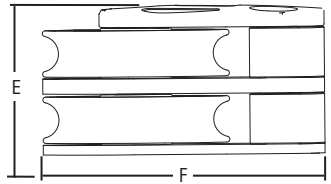
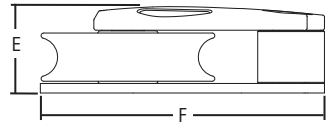
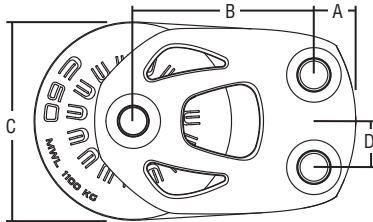

Part No.	A		B		C		D		E		F	
	mm	in	mm	in	mm	in	mm	in	mm	in	mm	in
6237	11	7/16	41.5	1 5/8	45	1 3/4	9.5	3/8	24.5	15/16	74.5	2 15/16
6267												
6268	12.5	1/2	54.5	2 5/32	60.0	2 3/8	14.0	9/16	29.5	1 3/16	97.5	3 13/16
6276												
6271*	12.5	1/2	54.5	2 5/32	60.0	2 3/8	14.0	9/16	55	2 3/16	97.5	3 13/16
6294												
6295	19.5	3/4	61.0	2 13/32	80.0	3 1/8	19.8	25/32	34.5	1 3/8	121	4 3/4
6299												
6298*	19.5	3/4	61.0	2 13/32	80.0	3 1/8	19.8	25/32	61	2 3/8	121	4 3/4

*Double blocks

Install using sealant in holes. **Tip:** Put slight bevel at top of hole to allow sealant to mass around upper part of hole.

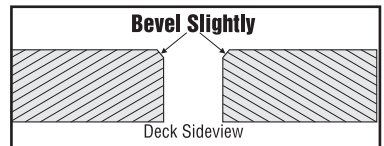

Mounting Stand-up Blocks - 45 mm

Planning installation - Make sure the bail of the padeye is aligned with the load. See image below



WARNING! You must mount to solid deck construction using supplied nuts, washers or backing plates to achieve correct maximum working load to avoid a failure leading to an accident.

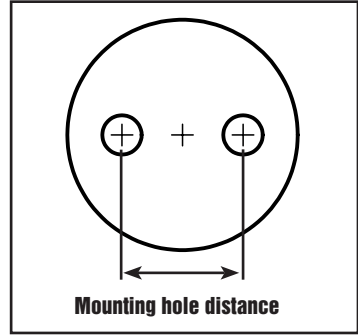
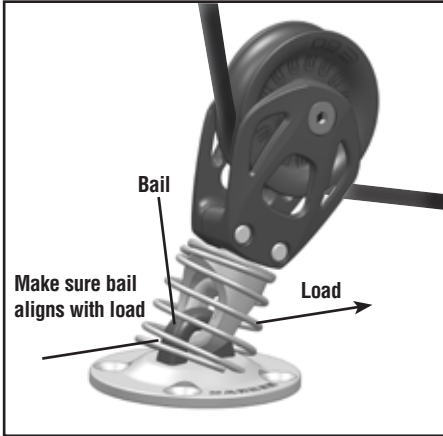

Stand-up block	Bail thread size	Drill size for clearance hole	Mounting hole distance
6250, 6251	6 mm	6.25 mm	20 mm
45 mm	1/4"	17/64"	13/16"

Install using sealant in holes. **Tip:** Put slight bevel at top of hole to allow sealant to mass around upper part of hole.

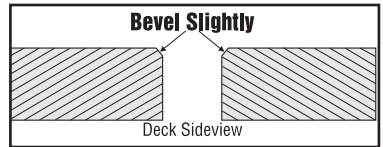

Mounting Stand-up Blocks - 60 mm and 80 mm

Planning installation - Make sure the bail of the padeye is aligned with the load. See image below



WARNING! You must mount to solid deck construction using specified fasteners in all mounting holes and nuts, washers or backing plates to achieve correct maximum working load to avoid a failure leading to an accident.

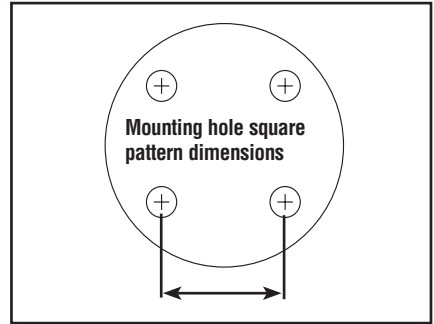
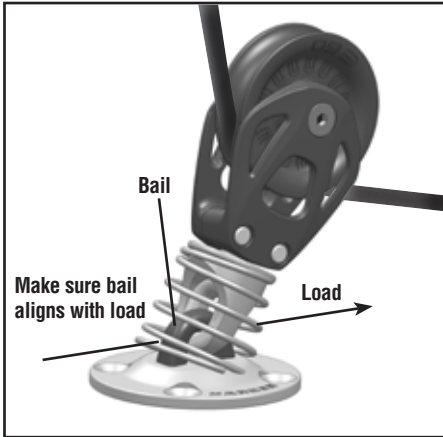

Stand-up block	Flathead screw size 	Drill size for clearance hole 	Mounting hole square pattern dimension
6277, 6278 60 mm	6 mm	6.25 mm	41 mm
	1/4"	17/64"	1 5/8"
6280 80 mm	8 mm	8.25 mm	46 mm
	5/16"	21/64"	1 13/16"

Install using sealant in holes. **Tip:** Put slight bevel at top of hole to allow sealant to mass around upper part of hole.

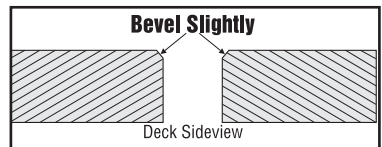

Masbase Blocks for Forkhead Fittings

Use with mastbase forkhead mastbase fittings. Examples include fittings supplied by Z-Spars and Sparcraft.



Forkhead fitting

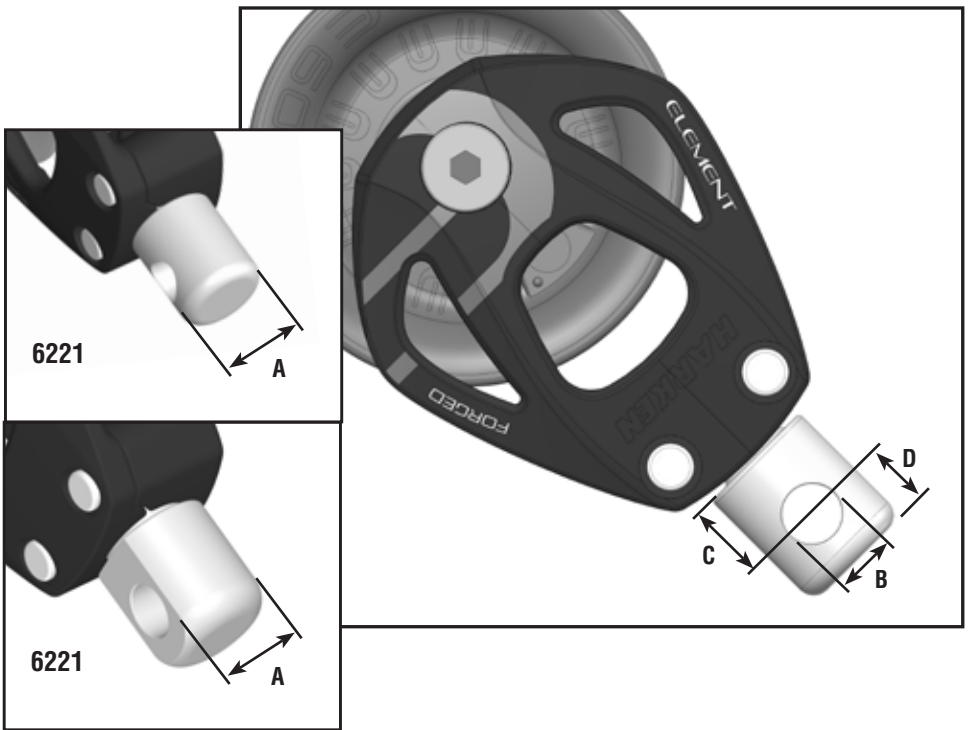

Block	Pin sized used	A Fit Dimension	B Hole Ø	C Ø CL to top	D Ø CL to bottom
6220 60 mm	8 mm	16.76 mm	8.2 mm	11.15 mm	8.71 mm
	5/16"	.660"	.323"	.439"	.343"
6221 80 mm	10 mm	18.29 mm	10.31 mm	13.31 mm	10.67 mm
	3/8"	.720	.406"	.524"	.420"

Reeving Blocks

Use splice or knot to deadend sheet to becket. Use the sequences below to reeve blocks.

Note: Upper and lower blocks will be at right angles to each other.

Reeving diagrams shown without block structure for clarity.

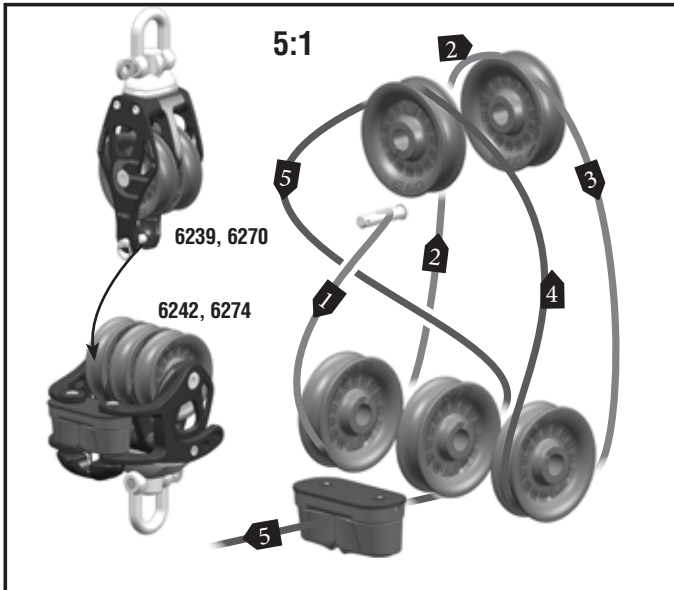

Reeving Blocks (continued)

Reeving diagrams shown without block structure for clarity.

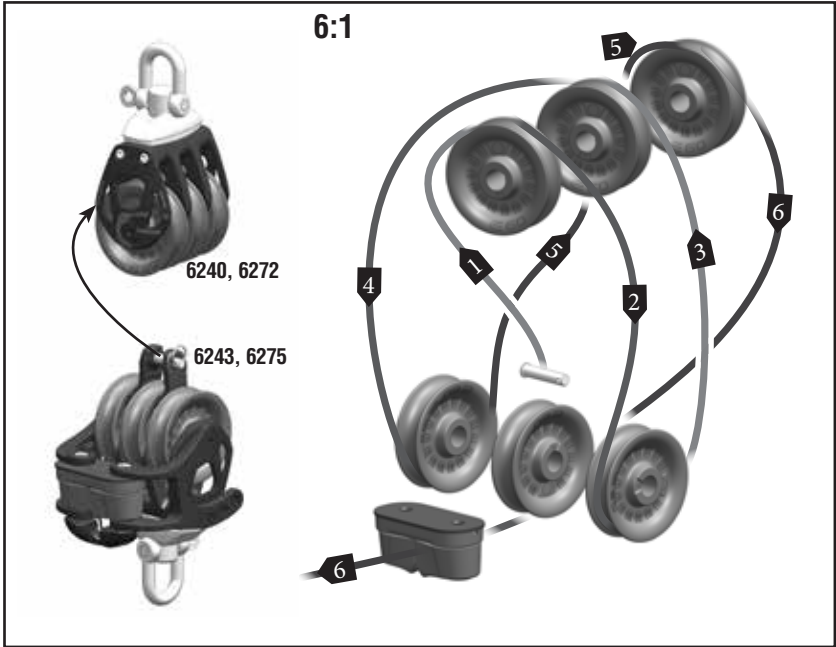

Maintenance

Periodically inspect all fasteners and shackles to make sure they are secure.



Keep your equipment clean and free-running by frequently flushing with fresh water. Periodically clean with mild detergent and water solution. Spin sheave to distribute soap solution evenly. Flush with fresh water.

Note: Sheave is not removable.

If block has cam cleat, flush balls in cam cleats while rotating pawls.

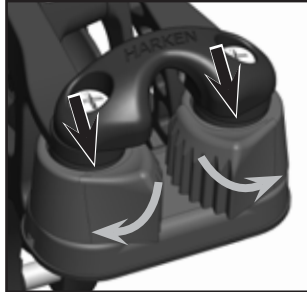

General Maintenance

Harken equipment is designed for minimal maintenance. However, some upkeep is required to give the best service and comply with the Harken limited warranty.

Keep your equipment clean and free-running by frequently flushing with fresh water. Periodically clean with mild detergent and water solution. Spin sheaves to distribute soap solution evenly. Flush with fresh water.

IMPORTANT! Exposure to some teak cleaners and other caustic solutions can result in discoloration of part and is not covered under the Harken warranty.