

Hella marine 

Vision and Innovation

WORLD LEADING LED TECHNOLOGY FOR NEW BUILDING AND REFITTING



**CABIN LIGHTING • GENERAL LIGHTING • THEATRE LIGHTING
CRUISE • FERRY • COMMERCIAL**



Hella marine

Vision and Innovation

Lighting enhances life's experiences

A Cruise Ship is made to offer experiences of relaxation, recreation, and adventure. High-quality lighting helps create the perfect environment for these experiences to the most important of our senses: eyesight. With light, HELLA knows how to paint pictures that convince the eye. Hella Marine lights are preferred choice of architects leading shipyards and owners.



Hella marine is certified to the international quality standard ISO 9001:2008 for:

'The Design and Manufacture of Marine Navigation Lighting, General Lighting, LED Based Lighting and Associated Electronic Control Units.
The Design and Manufacture of Automotive Lighting and Signalling Equipment, General Lighting, Optical Products and Plastic Components.'



The Hella marine Advantage

At sea, power is often a scarce resource. Highly efficient and durable LED lighting has a substantial role to play in conserving energy and enhancing a vessel without sacrificing functionality or compromising safety.

Our vision is to provide world leading products that set benchmarks for quality, reliability, safety and energy efficiency. Hella marine 'Fit and Forget' LED lighting is firmly established as the solution of choice that meets long term reliability and economic considerations for astute owners and operators.



5 Year Warranty

All Hella marine LED based lighting products carry a Five-Year Warranty providing peace of mind that the product will stand the test of time.

For more information visit: www.hellamarine.com/en/about/warranty/



Electromagnetic Compatibility (EMC)

All Hella marine LED products are designed with components that suppress possible interference, both emission as well as susceptibility to emissions, to the limits prescribed in international standards. This prevents possible interference with radio, communication, navigation and other electrical equipment onboard.



Class Leading Efficiency

Combining efficient LED sources with advanced optic technology, Hella marine LED products deliver more light output per watt than incandescent based lamps with significant energy savings.

Ultra low heat signatures reduce heat onboard and prevent damage to surrounding materials.



Outstanding UV and Impact Resistance

Hella marine lamps utilise advanced impact resistant polymers that will not yellow or deteriorate in the harsh marine environment.



HELLA MARINE ADVANTAGE FOR VARIOUS USES

- PUBLIC AREAS

PAGES: 6-9, 18-19, 22-27, 30-31, 36-39

- CABINS

PAGES: 10-13, 20-21, 30, 32-35

- SUITES

PAGES: 10-13, 20-21, 28-29,

- CORRIDORS

PAGES: 30, 32-33,

- SPAS

PAGES: 14, 20-21, 28-29

- THEATRES

PAGES: 15, 40

- TECHNICAL AREAS

PAGES: 36-39, 41-42

S80 FAMILY, DESIGNED FOR MARINE USE



A totally new product family based on marine needs

2nd generation marine lighting

Over 10 ships

Suitable for several areas

Modular concept

Designed for LED

Fire protection options



S80 SERIES FOR PUBLIC AREAS



S80 FIXED



500 lm
LIGHT OUTPUT

6W
POWER
CONSUMPTION

1-10
DIM

82 mm
CUTOUT

IP 23
PROTECTION
CLASS

90
CRI

PART NUMBERING

connector	opening angle	white			black			silver			gold		
		2700 K	3000 K	4000 K	2700 K	3000 K	4000 K	2700 K	3000 K	4000 K	2700 K	3000 K	4000 K
1 x Wago	60°	347022-007	347022-017	347022-027	347022-067	347022-077	347022-087	347022-127	347022-137	347022-147	347063-007	347063-017	347063-027
1 x Wago	40°	347022-487	347022-497	347022-507	347022-517	347022-527	347022-537	347022-547	347022-557	347022-567	347063-127	347063-137	347063-147
1 x Wago	20°	347022-577	347022-587	347022-597	347022-607	347022-617	347022-627	347022-637	347022-647	347022-657	347063-247	347063-257	347063-267
1 x Ensto	60°	347022-247	347022-257	347022-267	347022-307	347022-317	347022-327	347022-367	347022-377	347022-387	347063-067	347063-077	347063-087
1 x Ensto	40°	347022-187	347022-197	347022-207	347022-217	347022-227	347022-237	347022-427	347022-437	347022-447	347063-187	347063-197	347063-207
1 x Ensto	20°	347022-457	347022-467	347022-477	347022-667	347022-677	347022-687	347022-697	347022-707	347022-717	347063-307	347063-317	347063-327

S82 FIXED



800 lm
LIGHT OUTPUT

11W
POWER
CONSUMPTION

1-10
DIM

82mm
CUTOUT

IP 23
PROTECTION
CLASS

90
CRI

PART NUMBERING

connector	opening angle	white			black			silver			gold		
		2700 K	3000 K	4000 K	2700 K	3000 K	4000 K	2700 K	3000 K	4000 K	2700 K	3000 K	4000 K
1 x Wago	60°	347023-007	347023-017	347023-027	347023-067	347023-077	347023-087	347023-127	347023-137	347023-147	347064-007	347064-017	347064-027
1 x Wago	40°	347023-487	347023-497	347023-507	347023-517	347023-527	347023-537	347023-547	347023-557	347023-567	347064-127	347064-137	347064-147
1 x Wago	20°	347023-577	347023-587	347023-597	347023-607	347023-617	347023-627	347023-637	347023-647	347023-657	347064-247	347064-257	347064-267
1 x Ensto	60°	347023-247	347023-257	347023-267	347023-307	347023-317	347023-327	347023-367	347023-377	347023-387	347064-067	347064-077	347064-087
1 x Ensto	40°	347023-187	347023-197	347023-207	347023-217	347023-227	347023-237	347023-427	347023-437	347023-447	347064-187	347064-197	347064-207
1 x Ensto	20°	347023-457	347023-467	347023-477	347023-667	347023-677	347023-687	347023-697	347023-707	347023-717	347064-307	347064-317	347064-327

S80 PRODUCTS

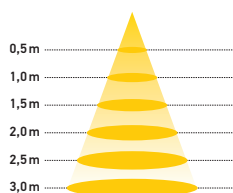

Luminous Intensity Distance / Lux 3000 K	white			black			silver			gold		
	60°	40°	20°	60°	40°	20°	60°	40°	20°	60°	40°	20°
0,5m	0,6m / 1918	0,3m / 3889	0,2m / 13875	0,6m / 3016	0,3m / 6116	0,2m / 21822	0,6m / 3016	0,3m / 6116	0,2m / 21822	0,6m / 3016	0,3m / 6116	0,2m / 21822
1,0m	1,1m / 479	0,7m / 972	0,4m / 3469	1,1m / 754	0,7m / 1529	0,4m / 5456	1,1m / 754	0,7m / 1529	0,4m / 5456	1,1m / 754	0,7m / 1529	0,4m / 5456
1,5m	1,7m / 213	1,0m / 432	0,6m / 1542	1,7m / 335	1,0m / 680	0,6m / 2425	1,7m / 335	1,0m / 680	0,6m / 2425	1,7m / 335	1,0m / 680	0,6m / 2425
2,0m	2,3m / 120	1,4m / 243	0,8m / 867	2,3m / 189	1,4m / 382	0,8m / 1364	2,3m / 189	1,4m / 382	0,8m / 1364	2,3m / 189	1,4m / 382	0,8m / 1364
2,5m	2,8m / 77	1,7m / 156	1,0m / 555	2,8m / 121	1,7m / 245	1,0m / 873	2,8m / 121	1,7m / 245	1,0m / 873	2,8m / 121	1,7m / 245	1,0m / 873
3,0m	3,4m / 53	2,1m / 108	1,2m / 385	3,4m / 84	2,1m / 170	1,2m / 606	3,4m / 84	2,1m / 170	1,2m / 606	3,4m / 84	2,1m / 170	1,2m / 606

S82 PRODUCTS

Luminous Intensity Distance / Lux 3000 K	white			black			silver			gold		
	60°	40°	20°	60°	40°	20°	60°	40°	20°	60°	40°	20°
0,5m	0,6m / 1918	0,3m / 3889	0,2m / 13875	0,6m / 3016	0,3m / 6116	0,2m / 21822	0,6m / 3016	0,3m / 6116	0,2m / 21822	0,6m / 3016	0,3m / 6116	0,2m / 21822
1,0m	1,1m / 479	0,7m / 972	0,4m / 3469	1,1m / 754	0,7m / 1529	0,4m / 5456	1,1m / 754	0,7m / 1529	0,4m / 5456	1,1m / 754	0,7m / 1529	0,4m / 5456
1,5m	1,7m / 213	1,0m / 432	0,6m / 1542	1,7m / 335	1,0m / 680	0,6m / 2425	1,7m / 335	1,0m / 680	0,6m / 2425	1,7m / 335	1,0m / 680	0,6m / 2425
2,0m	2,3m / 120	1,4m / 243	0,8m / 867	2,3m / 189	1,4m / 382	0,8m / 1364	2,3m / 189	1,4m / 382	0,8m / 1364	2,3m / 189	1,4m / 382	0,8m / 1364
2,5m	2,8m / 77	1,7m / 156	1,0m / 555	2,8m / 121	1,7m / 245	1,0m / 873	2,8m / 121	1,7m / 245	1,0m / 873	2,8m / 121	1,7m / 245	1,0m / 873
3,0m	3,4m / 53	2,1m / 108	1,2m / 385	3,4m / 84	2,1m / 170	1,2m / 606	3,4m / 84	2,1m / 170	1,2m / 606	3,4m / 84	2,1m / 170	1,2m / 606

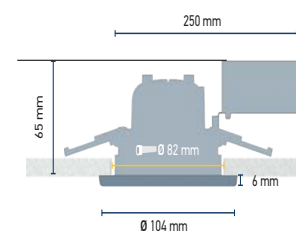



S80 SERIES FOR PUBLIC AREAS ADJUSTABLE SPOTS



S80 TILT&TWIST



500 lm
LIGHT OUTPUT

6W
POWER CONSUMPTION

1-10
DIM

82 mm
CUTOUT

IP 23
PROTECTION CLASS

90
CRI

PART NUMBERING

connector	opening angle	white			black			silver			gold		
		2700 K	3000 K	4000 K	2700 K	3000 K	4000 K	2700 K	3000 K	4000 K	2700 K	3000 K	4000 K
1 x Wago	60°	347042-007	347042-017	347042-027	347042-067	347042-077	347042-087	347042-127	347042-137	347042-147	347039-007	347039-017	347039-027
1 x Wago	40°	347042-487	347042-497	347042-507	347042-517	347042-527	347042-537	347042-547	347042-557	347042-567	347039-127	347039-137	347039-147
1 x Wago	20°	347042-577	347042-587	347042-597	347042-607	347042-617	347042-627	347042-637	347042-647	347042-657	347039-247	347039-257	347039-267
1 x Ensto	60°	347042-247	347042-257	347042-267	347042-307	347042-317	347042-327	347042-367	347042-377	347042-387	347039-067	347039-077	347039-087
1 x Ensto	40°	347042-187	347042-197	347042-207	347042-217	347042-227	347042-237	347042-427	347042-437	347042-447	347039-187	347039-197	347039-207
1 x Ensto	20°	347042-457	347042-467	347042-477	347042-667	347042-677	347042-687	347042-697	347042-707	347042-717	347039-307	347039-317	347039-327

S82 TILT&TWIST



800 lm
LIGHT OUTPUT

11W
POWER CONSUMPTION

1-10
DIM

82 mm
CUTOUT

IP 23
PROTECTION CLASS

90
CRI

PART NUMBERING

connector	opening angle	white			black			silver			gold		
		2700 K	3000 K	4000 K	2700 K	3000 K	4000 K	2700 K	3000 K	4000 K	2700 K	3000 K	4000 K
1 x Wago	60°	347043-007	347043-017	347043-027	347043-067	347043-077	347043-087	347043-127	347043-137	347043-147	347024-007	347024-017	347024-027
1 x Wago	40°	347043-487	347043-497	347043-507	347043-517	347043-527	347043-537	347043-547	347043-557	347043-567	347024-127	347024-137	347024-147
1 x Wago	20°	347043-577	347043-587	347043-597	347043-607	347043-617	347043-627	347043-637	347043-647	347043-657	347024-247	347024-257	347024-267
1 x Ensto	60°	347043-247	347043-257	347043-267	347043-307	347043-317	347043-327	347043-367	347043-377	347043-387	347024-067	347024-077	347024-087
1 x Ensto	40°	347043-187	347043-197	347043-207	347043-217	347043-227	347043-237	347043-427	347043-437	347043-447	347024-187	347024-197	347024-207
1 x Ensto	20°	347043-457	347043-467	347043-477	347043-667	347043-677	347043-687	347043-697	347043-707	347043-717	347024-307	347024-317	347024-327

S80 PRODUCTS

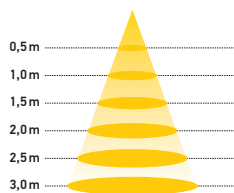

Luminous Intensity Distance / Lux 3000 K	60°			40°			20°		
	0,6m / 1918	0,3m / 3889	0,2m / 13875	1,1m / 479	0,7m / 972	0,4m / 3469	1,7m / 213	1,0m / 432	0,6m / 1542
2,3m / 120	2,8m / 77	3,4m / 53	1,4m / 243	1,7m / 156	2,1m / 108	0,8m / 867	1,0m / 555	1,2m / 385	

S82 PRODUCTS

Luminous Intensity Distance / Lux 3000 K	60°			40°			20°		
	0,6m / 3016	0,3m / 6116	0,2m / 21822	1,1m / 754	0,7m / 1529	0,4m / 5456	1,7m / 335	1,0m / 680	0,6m / 2425
2,3m / 189	2,8m / 121	3,4m / 84	1,4m / 382	1,7m / 245	2,1m / 170	0,8m / 1364	1,0m / 873	1,2m / 606	

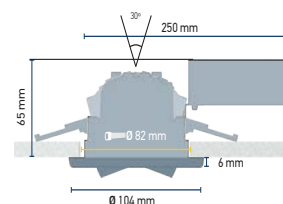

S80 SERIES FOR CABINS AND SUITES



S80 B0 CABINLIGHT 230V



500 lm
LIGHT OUTPUT

9W
POWER CONSUMPTION

on/off
DIM

84 mm
CUTOUT

IP 23
PROTECTION CLASS

90
CRI

PART NUMBERING

connector	opening angle	white			black			silver			gold		
		2700 K	3000 K	4000 K	2700 K	3000 K	4000 K	2700 K	3000 K	4000 K	2700 K	3000 K	4000 K
1 x Wago	60°	347025-007	347025-017	347025-027	347025-067	347025-077	347025-087	347025-127	347025-137	347025-147	347070-007	347070-017	347070-027
1 x Wago	40°	347025-487	347025-497	347025-507	347025-517	347025-527	347025-537	347025-547	347025-557	347025-567	347070-127	347070-137	347070-147
1 x Wago	20°	347025-577	347025-587	347025-597	347025-607	347025-617	347025-627	347025-637	347025-647	347025-657	347070-247	347070-257	347070-267
1 x Ensto	60°	347025-247	347025-257	347025-267	347025-307	347025-317	347025-327	347025-367	347025-377	347025-387	347070-067	347070-077	347070-087
1 x Ensto	40°	347025-187	347025-197	347025-207	347025-217	347025-227	347025-237	347025-427	347025-437	347025-447	347070-187	347070-197	347070-207
1 x Ensto	20°	347025-457	347025-467	347025-477	347025-667	347025-677	347025-687	347025-697	347025-707	347025-717	347070-307	347070-317	340070-327

S80 B0 CABINLIGHT 24V



500 lm
LIGHT OUTPUT

6,5W
POWER CONSUMPTION

on/off
DIM

84 mm
CUTOUT

IP 23
PROTECTION CLASS

90
CRI

PART NUMBERING

connector	opening angle	white			black			silver			gold		
		2700 K	3000 K	4000 K	2700 K	3000 K	4000 K	2700 K	3000 K	4000 K	2700 K	3000 K	4000 K
1 x Wago	60°	347084-007	347084-017	347084-027	347084-067	347084-077	347084-087	347084-127	347084-137	347084-147	347094-007	347094-017	347094-027
1 x Wago	40°	347084-487	347084-497	347084-507	347084-517	347084-527	347084-537	347084-547	347084-557	347084-567	347094-127	347094-137	347094-147
1 x Wago	20°	347084-577	347084-587	347084-597	347084-607	347084-617	347084-627	347084-637	347084-647	347084-657	347094-247	347094-257	347094-267
1 x Ensto	60°	347084-247	347084-257	347084-267	347084-307	347084-317	347084-327	347084-367	347084-377	347084-387	347094-067	347094-077	347094-087
1 x Ensto	40°	347084-187	347084-197	347084-207	347084-217	347084-227	347084-237	347084-427	347084-437	347084-447	347094-187	347094-197	347094-207
1 x Ensto	20°	347084-457	347084-467	347084-477	347084-667	347084-677	347084-687	347084-697	347084-707	347084-717	347094-307	347094-317	340094-327

S80 B0 CABINLIGHT

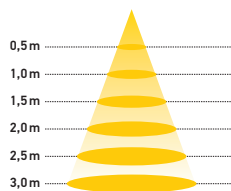

Luminous Intensity Distance / Lux 3000 K			
	60°	40°	20°
0,5m	0,6m / 1918	0,3m / 3889	0,2m / 13875
1,0m	1,1m / 479	0,7m / 972	0,4m / 3469
1,5m	1,7m / 213	1,0m / 432	0,6m / 1542
2,0m	2,3m / 120	1,4m / 243	0,8m / 867
2,5m	2,8m / 77	1,7m / 156	1,0m / 555
3,0m	3,4m / 53	2,1m / 108	1,2m / 385

S80 B0 CABINLIGHT

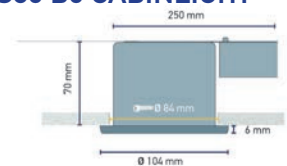

S80 B0 CABINLIGHT 24V

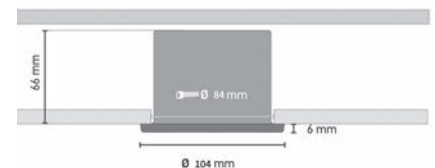

S80 SERIES FOR CABINS AND SUITES

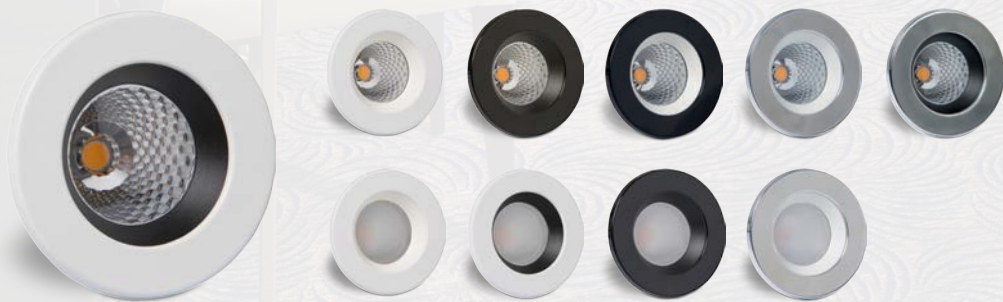

S80 B0 CABINLIGHT IP55



500 lm LIGHT OUTPUT	9W POWER CONSUMPTION	on/off DIM	84 mm CUTOUT	IP55 PROTECTION CLASS	90 CRI
-------------------------------	--------------------------------	----------------------	------------------------	---------------------------------	------------------

PART NUMBERING

connector	opening angle	white			black			silver			gold		
		2700 K	3000 K	4000 K	2700 K	3000 K	4000 K	2700 K	3000 K	4000 K	2700 K	3000 K	4000 K
1 x Wago	90°	347067-037	347067-047	347067-057	347067-097	347067-107	347067-117	347067-157	347067-167	347067-177	347077-037	347077-047	347077-057
1 x Wago	60°	347067-007	347067-017	347067-027	347067-067	347067-077	347067-087	347067-127	347067-137	347067-147	347077-007	347077-017	347077-027
1 x Wago	40°	347067-487	347067-497	347067-507	347067-517	347067-527	347067-537	347067-547	347067-557	347067-567	347077-127	347077-137	347077-147
1 x Wago	20°	347067-577	347067-587	347067-597	347067-607	347067-617	347067-627	347067-637	347067-647	347067-657	347077-247	347077-257	347077-267
1 x Ensto	90°	347067-277	347067-287	347067-297	347067-337	347067-347	347067-357	347067-397	347067-407	347067-417	347077-097	347077-107	347077-117
1 x Ensto	60°	347067-247	347067-257	347067-267	347067-307	347067-317	347067-327	347067-367	347067-377	347067-387	347077-067	347077-077	347077-087
1 x Ensto	40°	347067-187	347067-197	347067-207	347067-217	347067-227	347067-237	347067-427	347067-437	347067-447	347077-187	347077-197	347077-207
1 x Ensto	20°	347067-457	347067-467	347067-477	347067-667	347067-677	347067-687	347067-697	347067-707	347067-717	347077-307	347077-317	347077-327

S80 B0 CABINLIGHT IP55 24V



500 lm LIGHT OUTPUT	6,5W POWER CONSUMPTION	on/off DIM	84 mm CUTOUT	IP55 PROTECTION CLASS	90 CRI
-------------------------------	----------------------------------	----------------------	------------------------	---------------------------------	------------------

PART NUMBERING

connector	opening angle	white			black			silver			gold		
		2700 K	3000 K	4000 K	2700 K	3000 K	4000 K	2700 K	3000 K	4000 K	2700 K	3000 K	4000 K
1 x Wago	90°	347035-037	347035-047	347035-057	347035-097	347035-107	347035-117	347035-157	347035-167	347035-177	347095-037	347095-047	347095-057
1 x Wago	60°	347035-007	347035-017	347035-027	347035-067	347035-077	347035-087	347035-127	347035-137	347035-147	347095-007	347095-017	347095-027
1 x Wago	40°	347035-487	347035-497	347035-507	347035-517	347035-527	347035-537	347035-547	347035-557	347035-567	347095-127	347095-137	347095-147
1 x Wago	20°	347035-577	347035-587	347035-597	347035-607	347035-617	347035-627	347035-637	347035-647	347035-657	347095-247	347095-257	347095-267
1 x Ensto	90°	347035-277	347035-287	347035-297	347035-337	347035-347	347035-357	347035-397	347035-407	347035-417	347095-097	347095-107	347095-117
1 x Ensto	60°	347035-247	347035-257	347035-267	347035-307	347035-317	347035-327	347035-367	347035-377	347035-387	347095-067	347095-077	347095-087
1 x Ensto	40°	347035-187	347035-197	347035-207	347035-217	347035-227	347035-237	347035-427	347035-437	347035-447	347095-187	347095-197	347095-207
1 x Ensto	20°	347035-457	347035-467	347035-477	347035-667	347035-677	347035-687	347035-697	347035-707	347035-717	347095-307	347095-317	347095-327

S80 B0 CABINLIGHT IP55

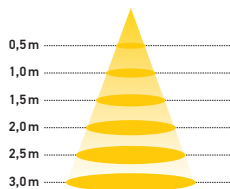

Luminous Intensity Distance / Lux 3000 K	60°			40°			20°		
	0,6m / 1918	0,3m / 3889	0,2m / 13875	1,1m / 479	0,7m / 972	0,4m / 3469	1,7m / 213	1,0m / 432	0,6m / 1542
	2,3m / 120	1,4m / 243	0,8m / 867	2,8m / 77	1,7m / 156	1,0m / 555	3,4m / 53	2,1m / 108	1,2m / 385

S80 B0 CABINLIGHT IP55

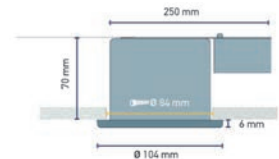

S80 B0 CABINLIGHT 24V IP55

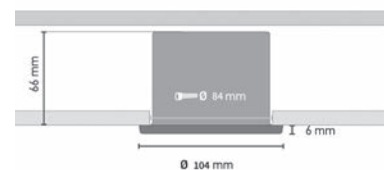

S80 SERIES FOR SPA



S82 SPA IP55

800 lm
LIGHT OUTPUT

11W
POWER CONSUMPTION

1-10
DIM

82 mm
CUTOUT

IP 55
PROTECTION CLASS

90
CRI



PART NUMBERING

connector	opening angle	white			black			silver			gold		
		2700 K	3000 K	4000 K	2700 K	3000 K	4000 K	2700 K	3000 K	4000 K	2700 K	3000 K	4000 K
1 x Wago	90°	347033-037	347033-047	347033-057	347033-097	347033-107	347033-117	347033-157	347033-167	347033-177	347072-037	347072-047	347072-057
1 x Wago	60°	347033-007	347033-017	347033-027	347033-067	347033-077	347033-087	347033-127	347033-137	347033-147	347072-007	347072-017	347072-027
1 x Wago	40°	347033-487	347033-497	347033-507	347033-517	347033-527	347033-537	347033-547	347033-557	347033-567	347072-127	347072-137	347072-147
1 x Wago	20°	347033-577	347033-587	347033-597	347033-607	347033-617	347033-627	347033-637	347033-647	347033-657	347072-247	347072-257	347072-267
1 x Ensto	90°	347033-277	347033-287	347033-297	347033-337	347033-347	347033-357	347033-397	347033-407	347033-417	347072-097	347072-107	347072-117
1 x Ensto	60°	347033-247	347033-257	347033-267	347033-307	347033-317	347033-327	347033-367	347033-377	347033-387	347072-067	347072-077	347072-087
1 x Ensto	40°	347033-187	347033-197	347033-207	347033-217	347033-227	347033-237	347033-427	347033-437	347033-447	347072-187	347072-197	347072-207
1 x Ensto	20°	347033-457	347033-467	347032-477	347033-667	347032-677	347033-687	347032-697	347033-707	347033-717	347072-307	347072-317	347073-327

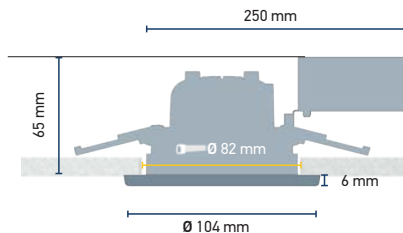

	Luminous Intensity Distance / Lux 3000 K		
	60°	40°	20°
0,5m	0,6m / 1739	0,3m / 4122	0,2m / 20999
1,0m	1,1m / 435	0,7m / 1031	0,4m / 5250
1,5m	1,7m / 193	1,0m / 458	0,6m / 2333
2,0m	2,3m / 109	1,4m / 258	0,8m / 1312
2,5m	2,8m / 70	1,7m / 154	1,0m / 720
3,0m	3,4m / 48	2,1m / 115	1,2m / 583

S82 ADJUSTABLE PINHOLE



S82 PINHOLE

700 lm
LIGHT OUTPUT

11W
POWER
CONSUMPTION

1-10
DIM

86 mm
CUTOUT

IP 23
PROTECTION
CLASS

90
CRI



PART NUMBERING

connector	opening angle	white			black			silver			gold		
		2700 K	3000 K	4000 K	2700 K	3000 K	4000 K	2700 K	3000 K	4000 K	2700 K	3000 K	4000 K
1 x Wago	40°	347.049-007	347.049-017	347.049-027	347.049-037	347.049-047	347.049-057	347.049-067	347.049-077	347.049-087	347049-427	3347049-437	347049-447
1 x Wago	20°	347.049-187	347.049-197	347.049-207	347.049-217	347.049-227	347.049-237	347.049-247	347.049-257	347.049-267	347049-367	347049-377	347049-387
1 x Ensto	40°	347.049-097	347.049-107	347.049-117	347.049-127	347.049-137	347.049-147	347.049-157	347.049-167	347.049-177	347049-457	347049-467	347049-477
1 x Ensto	20°	347.049-277	347.049-287	347.049-297	347.049-307	347.049-317	347.049-327	347.049-337	347.049-347	347.049-357	347049-397	347049-407	347049-417

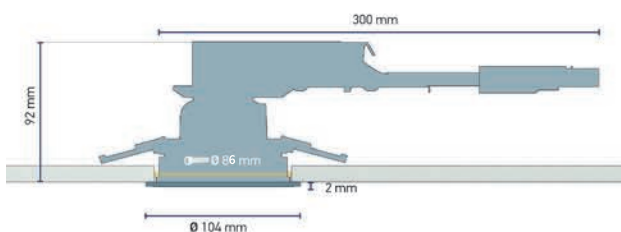

	Luminous Intensity Distance / Lux 3000K	
	40°	20°
0,5m	0,3m / 3606	0,2m / 18374
1,0m	0,7m / 902	0,4m / 4594
1,5m	1,0m / 400	0,6m / 2041
2,0m	1,4m / 225	0,8m / 1148
2,5m	1,7m / 134	1,0m / 630
3,0m	2,1m / 100	1,2m / 510



S80 AND S82 PRODUCT INFORMATION:

S80 500 lm			
Tilt & Twist / Fixed		B0 Fixed	
IP23 T	IP55 F	IP23 F	IP55 F
500 lm	500 lm	350 lm	350 lm

S82 800 lm			
Tilt & Twist / Fixed		B0 Fixed	
IP23 T	IP55 F	IP23 F	IP55 F
800 lm	800 lm	500 lm	500 lm

SHIPPING	
pack type	carton
QTY of luminaires	10 pcs
length	0.48 m
width	0.30 m
height	0.26 m
gross weight	5.6 kg

OPTIONS				
Beam angle	20	40	60	90
Color temp K	2700	3000	4000	
IP Class	IP23	IP55		

HOW YOU CAN SPECIFY YOUR PRODUCT									
Type	Class of fire	Intensity	Lens	Type of trim	Color of frame-work	Color of trim	Connector	Poles	Control
Tilt&Twist	C	350lm	Clear	Basic	White	White	Wago	2-pole	ON/OFF
Fixed	B0	450lm	Milky	Ambient	Black	Black	Ensto	3-pole	1-10
Pinhole	B15	500lm				Chrome	Wieland	5-pole	24V
		700lm					Gold		DALI
		800lm				Painted			
		900lm				Gold			



S100 SERIES FOR PUBLIC AREAS



CHANGEABLE DECORATIVE TRIM

ADJUSTABLE UP TO 30°

LED S102

11 W
POWER
CONSUMPTION

700 lm
LIGHT
OUTPUT

PART NUMBERING

opening angle	White trim			Chrome trim			Gold trim		
	2700 K	3000 K	4000 K	2700 K	3000 K	4000 K	2700 K	3000 K	4000 K
90° diffused	345.567-397	345.567-437	345.567-477	345.567-517	345.567-557	345.567-597	345.567-637	345.567-677	345.567-717
60°	345.567-407	345.567-447	345.567-487	345.567-527	345.567-567	345.567-607	345.567-647	345.567-687	345.567-727
40°	345.567-417	345.567-457	345.567-497	345.567-537	345.567-577	345.567-617	345.567-657	345.567-697	345.567-737
15°	345.567-427	345.567-467	345.567-507	345.567-547	345.567-587	345.567-627	345.567-667	345.567-707	345.567-747

1-10V
DIM

IP23
PROTECTION
CLASS

ELEVATOR
FIXING

2700 K
3000 K
4000 K
COLOUR
TEMP

90
CRI

108MM
CUT OUT

**CABLE HARNESS,
LOOP THROUGH IP20**

5 pole male	5 pole female
NCC51S.G	NCC52S.G
Ensto	Ensto

SHIPPING

pack type	carton
QTY of luminaires	10 pcs
length	0.48 m
width	0.30 m
height	0.26 m
gross weight	7 kg

DIMENSIONS

trim diameter	120 mm
height	50 mm
installation cut out	108 mm
weight	555 g

OPTICAL OPTIONS

Clear lens	345.041-00
Diffused lens 90°	345.041-02
Reflector 60°	345.036-00
Reflector 40°	345.036-01
Reflector 20°	345.036-02

LUMINAIRE

type	Hella S102, S104, S105
tilt	+30-15° / IP 23
fixing method	elevator

DRIVER

Helvar 30W 1-10	LCIx30-E-AN-250/500
VAC	198-264
freq	50-60 Hz
1-10 V dimmable	

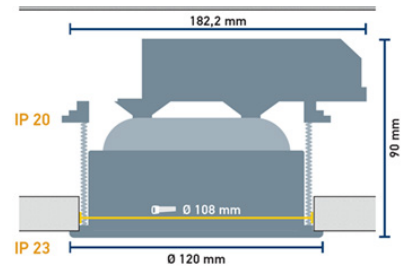

Luminous Intensity Distance / Lux 3000 K

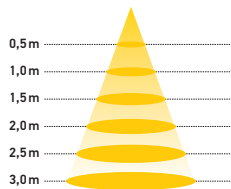

LED S102 / Ø/lx

60°	40°
0,6m / 2600	0,3m / 5200
1,1m / 650	0,7m / 1300
1,7m / 290	1,0m / 580
2,3m / 160	1,4m / 325
2,8m / 105	1,7m / 210
3,4m / 72	2,1m / 145

LED S104 / Ø/lx

60°
0,6m / 4300
1,1m / 1100
1,7m / 480
2,3m / 270
2,8m / 175
3,4m / 120

LED S105 / Ø/lx

60°
0,6m / 6700
1,1m / 1700
1,7m / 750
2,3m / 420
2,8m / 270
3,4m / 190

LED S104

15 W
POWER
CONSUMPTION

1150lm
LIGHT
OUTPUT

PART NUMBERING

opening angle	White trim			Chrome trim			Gold trim		
	2700 K	3000 K	4000 K	2700 K	3000 K	4000 K	2700 K	3000 K	4000 K
90° diffused	345.597-397	345.597-437	345.597-477	345.597-517	345.597-557	345.597-597	345.597-637	345.597-677	345.597-717
60°	345.597-407	345.597-447	345.597-487	345.597-527	345.597-567	345.597-607	345.597-647	345.597-687	345.597-727
40°	345.597-417	345.597-457	345.597-497	345.597-537	345.597-577	345.597-617	345.597-657	345.597-697	345.597-737
15°	345.597-427	345.597-467	345.597-507	345.597-547	345.597-587	345.597-627	345.597-667	345.597-707	345.597-747

LED S105

20 W
POWER
CONSUMPTION

1800lm
LIGHT
OUTPUT

PART NUMBERING

opening angle	White trim			Chrome trim			Gold trim		
	2700 K	3000 K	4000 K	2700 K	3000 K	4000 K	2700 K	3000 K	4000 K
90° diffused	345.598-397	345.598-437	345.598-477	345.598-517	345.598-557	345.598-598	345.598-637	345.598-677	345.598-717
60°	345.598-407	345.598-447	345.598-487	345.598-527	345.598-567	345.598-607	345.598-647	345.598-687	345.598-727
40°	345.598-417	345.598-457	345.598-497	345.598-537	345.598-577	345.598-617	345.598-657	345.598-697	345.598-737
15°	345.598-427	345.598-467	345.598-507	345.598-547	345.598-587	345.598-627	345.598-667	345.598-707	345.598-747

S100 SERIES FOR SPAS AND OUTDOOR AREAS



ENERGY EFFICIENT

DURABLE DOWNLIGHT

LED S102

11W
POWER
CONSUMPTION

700 lm
LIGHT
OUTPUT

PART NUMBERING

opening angle	White trim			Stainless steel trim		
	2700 K	3000 K	4000 K	2700 K	3000 K	4000 K
90° diffused	345.575-007	345.575-047	345.575-087	345.575-127	345.575-167	345.575-207
60°	345.575-017	345.575-057	345.575-097	345.575-137	345.575-177	345.575-217
40°	345.575-027	345.575-067	345.575-107	345.575-147	345.575-187	345.575-227
15°	345.575-037	345.575-077	345.575-117	345.575-157	345.575-197	345.575-237

Luminous Intensity Distance / Lux 3000 K

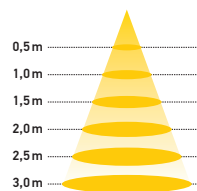

LED S102 Ø / lx

	60°	40°
0,5m	0,6m / 2600	0,3m / 5200
1,0m	1,1m / 650	0,7m / 1300
1,5m	1,7m / 290	1,0m / 580
2,0m	2,3m / 160	1,4m / 325
2,5m	2,8m / 105	1,7m / 210
3,0m	3,4m / 72	2,1m / 145

1-10V
DIM

IP55
PROTECTION
CLASS

**SPRING
CLIP**
FIXING

2700 K
3000 K
4000 K
COLOUR
TEMP

90
CRI

102MM
CUT OUT

CABLE HARNESS, LOOP THROUGH IP20	
5 pole male	5 pole female
NCC51S.G	NCC52S.G
Ensto	Ensto

SHIPPING	
pack type	carton
QTY of luminaires	10 pcs
length	0.48 m
width	0.30 m
height	0.26 m
gross weight	7 kg

DIMENSIONS	
trim diameter	115 mm
height	50 mm
installation cut out	102 mm
weight	785 g

OPTICAL OPTIONS	
Clear lens	345.041-00
Diffused lens 90°	345.041-02
Reflector 60°	345.036-00
Reflector 40°	345.036-01
Reflector 20°	345.036-02

LUMINAIRE	
type	Hella S102, S104, S105
fixed / IP55	
fixing method	spring clips

DRIVER	
Helvar 30W 1-10	LCI30-E-AN-250/500
VAC	198-264
freq	50-60 Hz
1-10 V dimmable	

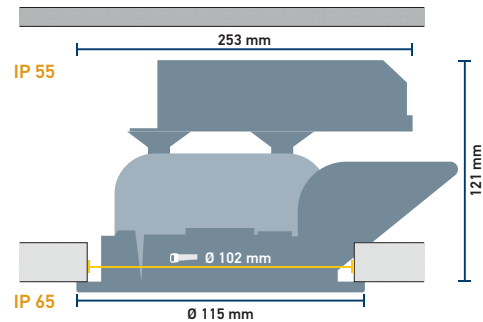

LED S104

15 W
POWER
CONSUMPTION

1150lm
LIGHT
OUTPUT

PART NUMBERING						
opening angle	White trim			Stainless steel trim		
	2700 K	3000 K	4000 K	2700 K	3000 K	4000 K
90° diffused	345.584-007	345.584-047	345.584-087	345.584-127	345.584-167	345.584-207
60°	345.584-017	345.584-057	345.584-097	345.584-137	345.584-177	345.584-217
40°	345.584-027	345.584-067	345.584-107	345.584-147	345.584-187	345.584-227
15°	345.584-037	345.584-077	345.584-117	345.584-157	345.584-197	345.584-237

Luminous Intensity Distance / Lux 3000 K



LED S105

20 W
POWER
CONSUMPTION

1800lm
LIGHT
OUTPUT

PART NUMBERING						
opening angle	White trim			Stainless steel trim		
	2700 K	3000 K	4000 K	2700 K	3000 K	4000 K
90° diffused	345.586-007	345.586-047	345.586-087	345.586-127	345.586-167	345.586-207
60°	345.586-017	345.586-057	345.586-097	345.586-137	345.586-177	345.586-217
40°	345.586-027	345.586-067	345.586-107	345.586-147	345.586-187	345.586-227
15°	345.586-037	345.586-077	345.586-117	345.586-157	345.586-197	345.586-237

Luminous Intensity Distance / Lux 3000 K

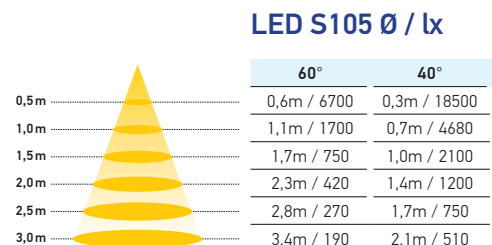

S100 SERIES FOR PUBLIC AREAS



HIGH-QUALITY FLAT METAL DECORATIVE TRIM

**AVAILABLE ALSO IN STAINLESS
STEEL AND ALUMINIUM FINISH**

WITH BUILT-IN 230V DRIVER

SPRING FIXING

DIM
FUNCTION

IP23
PROTECTION
CLASS

SPRING
FIXING

2700 K
3000 K
4000 K
COLOUR
TEMP

90
CRI

102MM
CUT OUT

CABLE HARNESS, LOOP THROUGH IP20	
3 pole male	3 pole female
NAC31S.W	NAC32S.W
Ensto	Ensto

SHIPPING	
pack type	carton
QTY of luminaires	10 pcs
length	0.48 m
width	0.30 m
height	0.26 m
gross weight	5 kg

DIMENSIONS	
trim diameter	115 mm
height	50 mm
installation cut out	102 mm
weight	345 g

LUMINAIRE	
type	Hella S100, S102
tilt ±20° / IP23	
fixing method	springs

DRIVER	
type	integrated
VAC	198-264
freq	50-60 Hz
leading edge / trailing edge dimmable	

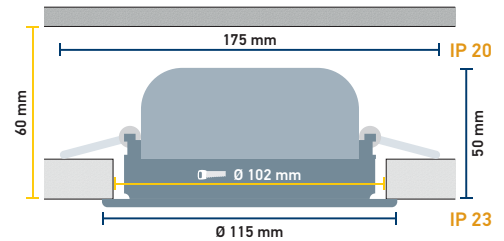

LED S100i

6 W
POWER
CONSUMPTION

350 lm
LIGHT
OUTPUT

Luminous Intensity Distance /
Lux 3000 K

opening angle	White trim			Chrome trim		
	2700 K	3000 K	4000 K	2700 K	3000 K	4000 K
90° diffused	346.750-247	346.750-067	346.750-157	346.750-267	346.750-077	346.750-167
60°	346.750-257	346.750-007	346.750-097	346.750-217	346.750-037	346.750-127
40°	346.750-197	346.750-017	346.750-107	346.750-227	346.750-047	346.750-137
15°	346.750-207	346.750-027	346.750-117	346.750-237	346.750-057	346.750-147

LED S100i Ø / lx

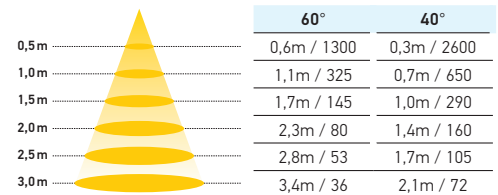

LED S102i

11 W
POWER
CONSUMPTION

700 lm
LIGHT
OUTPUT

Luminous Intensity Distance /
Lux 3000 K

opening angle	White trim			Chrome trim		
	2700 K	3000 K	4000 K	2700 K	3000 K	4000 K
90° diffused	346.755-247	346.755-067	346.755-157	346.755-267	346.755-077	346.755-167
60°	346.755-187	346.755-007	346.755-097	346.755-217	346.755-037	346.755-127
40°	346.755-197	346.755-017	346.755-107	346.755-227	346.755-047	346.755-137
15°	346.755-207	346.755-027	346.755-117	346.755-237	346.755-057	346.755-147

LED S102i Ø / lx

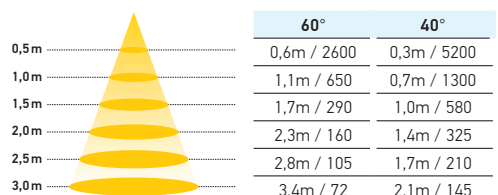

S100 SERIES FOR PUBLIC AREAS



WITH BUILT-IN 230V DRIVER

ELEVATOR FIXING

DIM
FUNCTION

IP23
PROTECTION
CLASS

ELEVATOR
FIXING

2700 K
3000 K
4000 K
COLOUR
TEMP

90
CRI

108_{MM}
CUT OUT

**CABLE HARNESS,
LOOP THROUGH IP20**

3 pole male	3 pole female
NAC31S.W	NAC32S.W
Ensto	Ensto

SHIPPING

pack type	carton
QTY of luminaires	10 pcs
length	0.48 m
width	0.30 m
height	0.26 m
gross weight	5,5 kg

DIMENSIONS

trim diameter	120 mm
height	93,2 mm
installation cut out	108 mm
weight	420 g

TRIM OPTIONS

White trim	345.373-00
Chrome trim	345.373-22
Gold trim	345.373-33
Black trim	345.373-22

LUMINAIRE

type	Hella S100, S102
fixed / IP 23	
fixing method	elevator

DRIVER

type	integrated
VAC	198-264
freq	50-60 Hz
leading edge / trailing edge dimmable	

**Luminous Intensity Distance /
Lux 3000 K**

LED S100i Ø / lx

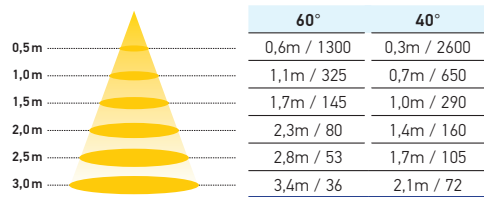

**Luminous Intensity Distance /
Lux 3000 K**

LED S102i Ø / lx

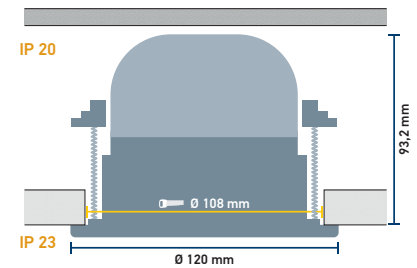
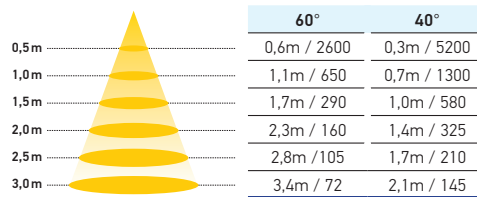

LED S100i

6 W
POWER
CONSUMPTION

350 lm
LIGHT
OUTPUT

opening angle	White trim			Chrome trim			Gold trim		
	2700 K	3000 K	4000 K	2700 K	3000 K	4000 K	2700 K	3000 K	4000 K
90° diffused	346.826-007	346.826-047	346.826-087	346.826-127	346.826-167	346.826-207	346.826-247	346.826-287	346.826-327
60°	346.826-017	346.826-057	346.826-097	346.826-137	346.826-177	346.826-217	346.826-257	346.826-297	346.826-337
40°	346.826-027	346.826-067	346.826-107	346.826-147	346.826-187	346.826-227	346.826-267	346.826-307	346.826-347
15°	346.826-037	346.826-077	346.826-117	346.826-157	346.826-197	346.826-237	346.826-277	346.826-317	346.826-357

LED S102i

700 lm
LIGHT
OUTPUT

11 W
POWER
CONSUMPTION

opening angle	White trim			Chrome trim			Gold trim		
	2700 K	3000 K	4000 K	2700 K	3000 K	4000 K	2700 K	3000 K	4000 K
90° diffused	346.755-547	346.755-377	346.755-427	346.755-567	346.755-367	346.755-437	346.755-267	346.755-087	346.755-447
60°	346.755-517	346.755-277	346.755-397	346.755-577	346.755-337	346.755-457	346.755-607	346.755-177	346.755-487
40°	346.755-557	346.755-287	346.755-407	346.755-587	346.755-347	346.755-467	346.755-617	346.755-777	346.755-497
15°	346.755-537	346.755-297	346.755-417	346.755-597	346.755-357	346.755-477	346.755-627	346.755-787	346.755-507

S100 SERIES FOR PUBLIC AREAS



RECESSED INVISIBLE LIGHT SOURCE

WITH BUILT-IN 230V DRIVER

DIM
FUNCTION

IP23
PROTECTION
CLASS

ELEVATOR
FIXING

2700 K
3000 K
4000 K
COLOUR
TEMP

90
CRI

108^{MM}
CUT OUT

LUMINAIRE	
type	Hella S100, S102
fixed / IP23	
fixing method	elevator

CABLE HARNESS, LOOP THROUGH IP20	
3 pole male	3 pole female
NAC31S.W	NAC32S.W
Ensto	Ensto

DIMENSIONS	
trim diameter	120 mm
height	93,2 mm
installation cut out	108 mm
weight	420 g

DRIVER	
type	integrated
VAC	198-264
freq	50-60 Hz
leading edge / trailing edge dimmable	

SHIPPING	
pack type	carton
QTY of luminaires	10 pcs
length	0.48 m
width	0.30 m
height	0.26 m
gross weight	5,5 kg

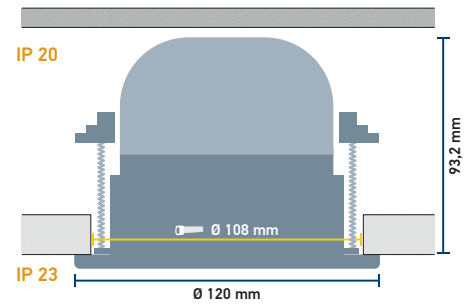

LED S100i

6 W
POWER
CONSUMPTION

350 lm
LIGHT
OUTPUT

PART NUMBERING									
opening angle	White trim			Chrome trim			Gold trim		
	2700 K	3000 K	4000 K	2700 K	3000 K	4000 K	2700 K	3000 K	4000 K
90° diffused	346.826-007	346.826-047	346.826-087	346.826-127	346.826-167	346.826-207	346.826-247	346.826-287	346.826-327
60°	346.826-017	346.826-057	346.826-097	346.826-137	346.826-177	346.826-217	346.826-257	346.826-297	346.826-337
40°	346.826-027	346.826-067	346.826-107	346.826-147	346.826-187	346.826-227	346.826-267	346.826-307	346.826-347
15°	346.826-037	346.826-077	346.826-117	346.826-157	346.826-197	346.826-237	346.826-277	346.826-317	346.826-357

LED S102i

11 W
POWER
CONSUMPTION

700 lm
LIGHT
OUTPUT

PART NUMBERING									
opening angle	White trim			Chrome trim			Gold trim		
	2700 K	3000 K	4000 K	2700 K	3000 K	4000 K	2700 K	3000 K	4000 K
90° diffused	346.828-007	346.828-047	346.828-087	346.828-127	346.828-167	346.828-207	346.828-247	346.828-287	346.828-327
60°	346.828-017	346.828-057	346.828-097	346.828-137	346.828-177	346.828-217	346.828-257	346.828-297	346.828-337
40°	346.828-027	346.828-067	346.828-107	346.828-147	346.828-187	346.828-227	346.828-267	346.828-307	346.828-347
15°	346.828-037	346.828-077	346.828-117	346.828-157	346.828-197	346.828-237	346.828-277	346.828-317	346.828-357

Luminous Intensity Distance / Lux 3000 K

LED S100i Ø / lx

Distance	60°		40°	
	Distance	Lux	Distance	Lux
0,5m	0,6m	1300	0,3m	2600
1,0m	1,1m	325	0,7m	650
1,5m	1,7m	145	1,0m	290
2,0m	2,3m	80	1,4m	160
2,5m	2,8m	53	1,7m	105
3,0m	3,4m	36	2,1m	72

Luminous Intensity Distance / Lux 3000 K

LED S102i Ø / lx

Distance	60°		40°	
	Distance	Lux	Distance	Lux
0,5m	0,6m	2600	0,3m	5200
1,0m	1,1m	650	0,7m	1300
1,5m	1,7m	290	1,0m	580
2,0m	2,3m	160	1,4m	325
2,5m	2,8m	105	1,7m	210
3,0m	3,4m	72	2,1m	145

S100 SERIES FOR SPA AND WET AREAS



**ENERGY EFFICIENT AND DURABLE
DOWNLIGHT FOR INDOOR IP55 USE**

**AVAILABLE ALSO IN STAINLESS STEEL
AND ALUMINIUM FINISH**

WITH BUILT-IN 230V DRIVER

DIM
FUNCTION

IP55
PROTECTION
CLASS

SPRING
FIXING

2700 K
3000 K
4000 K
COLOUR
TEMP

90
CRI

102^{MM}
CUT OUT

LUMINAIRE	
type	Hella S100, S102
fixed / IP55 indoor use	
fixing method	springs

CABLE HARNESS, LOOP THROUGH IP20	
3 pole male	3 pole female
NAC31S.W	NAC32S.W
Ensto	Ensto

DIMENSIONS	
trim diameter	115 mm
height	50 mm
installation cut out	102 mm
weight	350 g

DRIVER	
type	integrated
VAC	198-264
freq	50-60 Hz
leading edge / trailing edge dimmable	

SHIPPING	
pack type	carton
QTY of luminaires	10 pcs
length	0.48 m
width	0.30 m
height	0.26 m
gross weight	5 kg

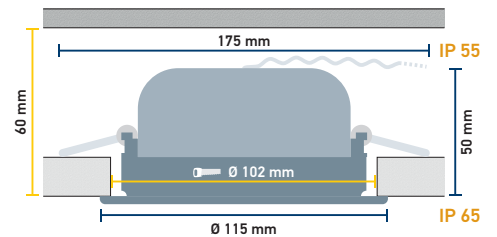

LED S100i

6 W
POWER
CONSUMPTION

350 lm
LIGHT
OUTPUT

Luminous Intensity Distance / Lux 3000 K

opening angle	White trim			Chrome trim		
	2700 K	3000 K	4000 K	2700 K	3000 K	4000 K
90° diffused	346.760-277	346.760-037	346.760-157	346.760-287	346.760-047	346.760-167
60°	346.760-247	346.760-007	346.760-127	346.760-337	346.760-097	346.760-217
40°	346.760-257	346.760-017	346.760-137	346.760-347	346.760-107	346.760-227
15°	346.760-267	346.760-027	346.760-147	346.760-357	346.760-117	346.760-237

LED S100i Ø / lx

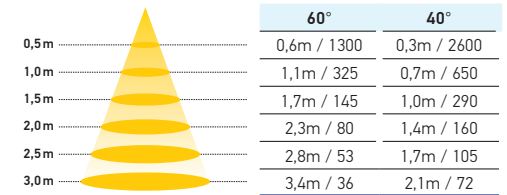

LED S102i

11 W
POWER
CONSUMPTION

700 lm
LIGHT
OUTPUT

Luminous Intensity Distance / Lux 3000 K

opening angle	White trim			Chrome trim		
	2700 K	3000 K	4000 K	2700 K	3000 K	4000 K
90° diffused	346.765-277	346.765-037	346.765-157	346.765-287	346.765-047	346.765-167
60°	346.765-247	346.765-007	346.765-127	346.765-337	346.765-097	346.765-217
40°	346.765-257	346.765-017	346.765-137	346.765-347	346.765-107	346.765-227
15°	346.765-267	346.765-027	346.765-147	346.765-357	346.765-117	346.765-237

LED S102i Ø / lx

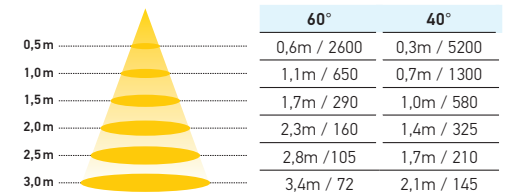

S23 SERIES FOR CABINS, FURNITURES, PUBLIC AREAS, CABIN ENTRANCE

COMPACT LED TECHNOLOGY FOR REDUCED HEAT AND LOW ENERGY CONSUMPTION



LED S23 FIXED

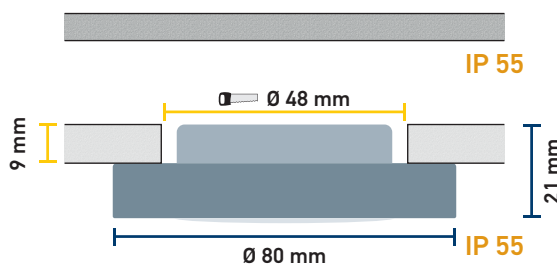

PART NUMBERING

Lens	White trim			Chrome trim			Black trim		
	2700 K	3000 K	4000 K	2700 K	3000 K	4000 K	2700 K	3000 K	4000 K
Clear lens	346.680-107	346.680-117	346.680-127	346.680-227	346.680-237	346.680-247	346.680-167	346.680-177	346.680-187
Diffused lens	346.680-137	346.680-147	346.680-157	346.680-257	346.680-267	346.680-277	346.680-197	346.680-207	346.680-217

LUMINAIRE

type Hella S23

fixed / IP55

fixing method screws

CABLE HARNESS, LOOP THROUGH IP20

3 pole male 3 pole female

NAC31S.W NAC32S.W

Ensto Ensto

DRIVER KIT ELT 10W ON/OFF

LC 110/350-B incl connec. 345.545-13

2 luminaires / driver

ordered separately

DIMENSIONS

diameter 80 mm

height 20 mm

installation cut out 48 mm

weight 150 g

SHIPPING

pack type carton

QTY of luminaires 10 pcs

length 0.48 m

width 0.30 m

height 0.26 m

gross weight 3 kg

DRIVER KIT HELVAR 30W 1-10

LC1X30-E-AN incl connec. 345.095-751

4 luminaires / driver

ordered separately

Luminous Intensity Distance / Lux 3000 K LED S23 FIXED / LED S23 ADJUSTABLE Ø / lx

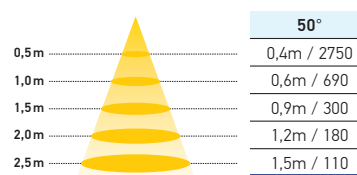

4,5 W
POWER
CONSUMPTION

350 mA

IP55
PROTECTION
CLASS

SCREW
FIXING

330 lm
LIGHT
OUTPUT

2700 K
3000 K
4000 K
COLOUR
TEMP

90
CRI

48 MM
CUT OUT

S23 SERIES FOR PUBLIC AREAS

ADJUSTABLE ART- LIGHT

INVISIBLE LIGHT SOURCE



LED S23 ADJUSTABLE

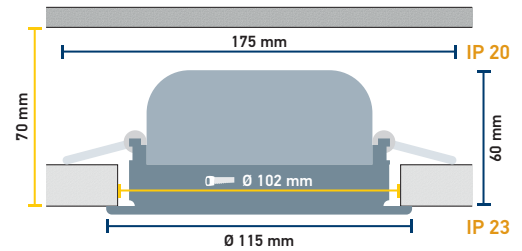

LUMINAIRE

type	Hella S23
tilt ±20° / IP 23	
fixing method	springs

CABLE HARNESS, LOOP THROUGH IP20

3 pole male	3 pole female
NAC31S.W	NAC32S.W
Ensto	Ensto

DIMENSIONS

trim diameter	115 mm
height	60 mm
installation cut out	102 mm
weight	250 g

SHIPPING

pack type	carton
QTY of luminaires	10 pcs
length	0.48 m
width	0.30 m
height	0.26 m
gross weight	3 kg

DRIVER KIT HELVAR 30W 1-10

LC1X30-E-AN incl connec.	345.095-751
4 luminaires / driver	
ordered separately	

DRIVER KIT ELT 10W ON/OFF

LC 110/350-B incl connec.	345.545-13
2 luminaires / driver	
ordered separately	

PART NUMBERING

Lens	White recessed frame & white trim			Black recessed frame & satin chrome trim		
	2700 K	3000 K	4000 K	2700 K	3000 K	4000 K
Clear lens	346.690-107	346.690-117	346.690-127	346.690-227	346.690-237	346.690-247
Diffused lens	346.690-137	346.690-147	346.690-157	346.690-257	346.690-267	346.690-277
Lens	Black recessed frame & black trim			Gold recessed frame & gold trim		
	2700 K	3000 K	4000 K	2700 K	3000 K	4000 K
Clear lens	346.690-167	346.690-177	346.690-187	346.690-287	346.690-297	346.690-307
Diffused lens	346.690-197	346.690-207	346.690-217	346.690-317	346.690-327	346.690-337

4,5W
POWER CONSUMPTION

350 mA

IP23
PROTECTION CLASS

SPRING
FIXING

330 lm
LIGHT OUTPUT

2700 K
3000 K
4000 K
COLOUR TEMP

90
CRI

102 MM
CUT OUT

G100 SERIES FOR CORRIDORS AND CABINS



UNIQUE LENS DESIGN TO REDUCE GLARE

WITH BUILT-IN 230V DRIVER

- G100i REPLACES 13W CFL LIGHT**
- G102i REPLACES 18W CFL LIGHT**

**AVAILABLE ALSO IN EMERGENCY
AND NIGHT LIGHT VERSIONS**

B0 / B15 APPROVED

ON/OFF
FUNCTION

IP23
PROTECTION
CLASS

SCREW
FIXING

2700 K
3000 K
4000 K
COLOUR
TEMP

85
CRI

**143-
155MM**
CUT OUT

Public ✓
B0 ✓
FIRE ZONES



LUMINAIRE

type	Hella G100, G102
IP23	
fixing method	screws
body depth	40mm

SHIPPING

pack type	carton
QTY of luminaires	12 pcs
length	0.48m
width	0.30m
height	0.26m
gross weight	10.2kg

**CABLE HARNESS,
LOOP THROUGH IP20**

3 pole male	3 pole female
NAC31S.W	NAC32S.W
Ensto	Ensto

DIMENSIONS

Diameter	186 mm
installation height	60 mm
installation cut out	143mm (up to 155mm)
weight	650 g

TRIM OPTIONS

White rounded trim	346.571-00
White tapered trim	346.571-40
White square trim	346.571-20
Chrome round trim	346.571-01
Chrome tapered trim	346.571-41
Chrome square trim	346.571-21

7,5W
POWER
CONSUMPTION

450 lm
LIGHT
OUTPUT

12,5W
POWER
CONSUMPTION

750 lm
LIGHT
OUTPUT

LED G100i

PART NUMBERING

Protection class	White rounded trim, concave lens		
	2700 K	3000 K	4000 K
IP23	347.200-007	347.200-017	347.200-027
	Chrome tapered trim, concave lens		
	2700 K	3000 K	4000 K
IP23	347.200-037	347.200-047	347.200-057
	White rounded, flat lens		
	2700 K	3000 K	4000 K
IP23	347.200-067	347.200-077	347.200-087
	Chrome tapered, flat lens		
	2700 K	3000 K	4000 K
IP23	347.200-097	347.200-107	347.200-117

LED G102i

PART NUMBERING

Protection class	White rounded trim, concave lens		
	2700 K	3000 K	4000 K
IP23	347.201-007	347.201-017	347.201-027
	Chrome tapered trim, concave lens		
	2700 K	3000 K	4000 K
IP23	347.201-037	347.201-047	347.201-057
	White rounded, flat lens		
	2700 K	3000 K	4000 K
IP23	347.201-067	347.201-077	347.201-087
	Chrome tapered, flat lens		
	2700 K	3000 K	4000 K
IP23	347.201-097	347.201-107	347.201-117

Luminous Intensity Distance / Lux 3000 K

LED G100i / G102i Ø / lx

	85°	85°
0,5m	1m / 1900	1m / 3200
1,0m	2,1m / 475	2,1m / 800
1,5m	3,1m / 210	3,1m / 350
2,0m	4,2m / 120	4,2m / 200
2,5m	5,2m / 75	5,2m / 125
3,0m	6,3m / 50	6,3m / 85

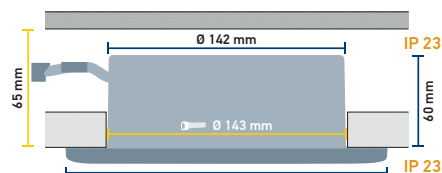

G100 SERIES IP44 FOR CABINS



UNIQUE LENS DESIGN TO REDUCE GLARE

WITH BUILT-IN 230V DRIVER

- G100i REPLACES 13W CFL LIGHT**
- G102i REPLACES 18W CFL LIGHT**

**AVAILABLE ALSO IN EMERGENCY
AND NIGHT LIGHT VERSIONS**

ON/OFF
FUNCTION

IP44
PROTECTION
CLASS

SCREW
FIXING

2700 K
3000 K
4000 K
COLOUR
TEMP

85
CRI

**143-
155MM**
CUT OUT

Public
B0
FIRE ZONES



LUMINAIRE	
type	Hella G100 , G102
IP44	
fixing method	screws
body depth	40 mm

SHIPPING	
pack type	carton
QTY of luminaires	12 pcs
length	0.48 m
width	0.30 m
height	0.26 m
gross weight	10.2 kg

CABLE HARNESS, LOOP THROUGH IP20	
3 pole male	3 pole female
NAC31S.W	NAC32S.W
Ensto	Ensto

DIMENSIONS	
Diameter	186 mm
installation height	60 mm
installation cut out	143 mm (up to 155 mm)
weight	650 g

TRIM OPTIONS	
White rounded trim	346.571-00
White tapered trim	346.571-40
White square trim	346.571-20
Chrome round trim	346.571-01
Chrome tapered trim	346.571-41
Chrome square trim	346.571-21

7,5W
POWER
CONSUMPTION

450 lm
LIGHT
OUTPUT

12,5 W
POWER
CONSUMPTION

750 lm
LIGHT
OUTPUT

LED G100i

PART NUMBERING				
Protection class	White rounded trim, concave lens			
	2700 K	3000 K	4000 K	
IP44	347.202-007	347.202-017	347.202-027	
IP44	Chrome tapered trim, concave lens			
	2700 K	3000 K	4000 K	
	347.202-037	347.202-047	347.202-057	
IP44	White rounded, flat lens			
	2700 K	3000 K	4000 K	
	347.202-067	347.202-077	347.202-087	
IP44	Chrome tapered, flat lens			
	2700 K	3000 K	4000 K	
	347.202-097	347.202-107	347.202-117	

LED G102i

PART NUMBERING				
Protection class	White rounded trim, concave lens			
	2700 K	3000 K	4000 K	
IP44	347.203-007	347.203-017	347.203-027	
IP44	Chrome tapered trim, concave lens			
	2700 K	3000 K	4000 K	
	347.203-037	347.203-047	347.203-057	
IP44	White rounded, flat lens			
	2700 K	3000 K	4000 K	
	347.203-067	347.203-077	347.203-087	
IP44	Chrome tapered, flat lens			
	2700 K	3000 K	4000 K	
	347.203-097	347.203-107	347.203-117	

Luminous Intensity Distance / Lux 3000 K

LED G100i / G102i Ø / lx

Distance (m)	85°		85°	
	1m / 1900	1m / 3200	2,1m / 475	2,1m / 800
1,0m	2,1m / 475	2,1m / 800	3,1m / 210	3,1m / 350
1,5m	4,2m / 120	4,2m / 200	5,2m / 75	5,2m / 125
2,0m	6,3m / 50	6,3m / 85		

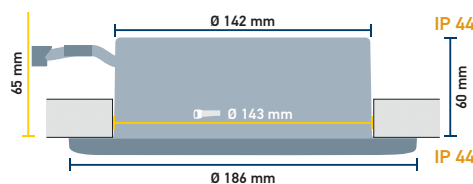

G100 SERIES DIMMABLE LIGHT FOR PUBLIC AND CREW AREAS



– REPLACES 13W CFL LIGHT





1-10
FUNCTION

SCREW
FIXING

2700 K
3000 K
4000 K
COLOUR
TEMP

85
CRI

143-
155MM
CUT OUT

Public ✓
B0 ✓
FIRE ZONES

LUMINAIRE

type	Hella G102, G104
IP23, IP44	
fixing method	screws
body depth	40 mm

**CABLE HARNESS,
LOOP THROUGH IP20**

5 pole male	5 pole female
NCC51S.G	NCC52S.G
Ensto	Ensto

DIMENSIONS

Diameter	186 mm
installation height	60 mm
installation cut out	143 mm (up to 155 mm)
weight	650 g

TRIM OPTIONS

White rounded trim	346.571-00
White tapered trim	346.571-40
White square trim	346.571-20
Chrome round trim	346.571-01
Chrome tapered trim	346.571-41
Chrome square trim	346.571-21

SHIPPING

pack type	carton
QTY of luminaires	12 pcs
length	0.48 m
width	0.30 m
height	0.26 m
gross weight	10.2 kg

Luminous Intensity Distance / Lux 3000 K

LED G102 / LED G104 Ø / lx

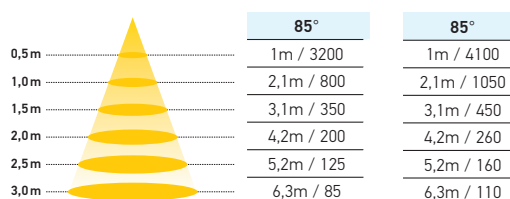

12,5W
POWER
CONSUMPTION

750 lm
LIGHT
OUTPUT

IP23
PROTECTION
CLASS

18W
POWER
CONSUMPTION

1000lm
LIGHT
OUTPUT

IP23
PROTECTION
CLASS

LED G102

PART NUMBERING

Protection class	White rounded trim, concave lens		
	2700 K	3000 K	4000 K
IP23	347.205-007	347.205-017	347.205-027
Chrome tapered trim, concave lens			
	2700 K	3000 K	4000 K
IP23	347.205-037	347.205-047	347.205-057
White rounded, flat lens			
	2700 K	3000 K	4000 K
IP23	347.205-067	347.205-077	347.205-087
Chrome tapered, flat lens			
	2700 K	3000 K	4000 K
IP23	347.205-097	347.205-107	347.205-117

LED G104

PART NUMBERING

Protection class	White rounded trim, concave lens		
	2700 K	3000 K	4000 K
IP23	347.208-007	347.208-017	347.208-027
Chrome tapered trim, concave lens			
	2700 K	3000 K	4000 K
IP23	347.208-037	347.208-047	347.208-057
White rounded, flat lens			
	2700 K	3000 K	4000 K
IP23	347.208-067	347.208-077	347.208-087
Chrome tapered, flat lens			
	2700 K	3000 K	4000 K
IP23	347.208-097	347.208-107	347.208-117

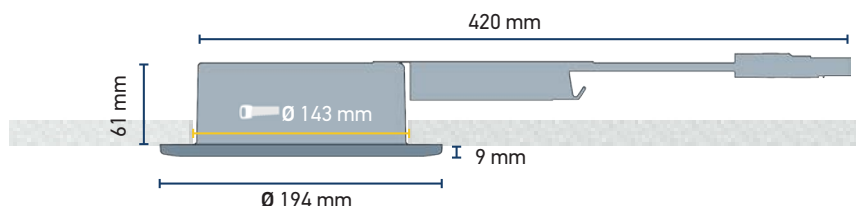

G100 SERIES DIMMABLE LIGHT FOR PUBLIC AND CREW AREAS



UNIQUE LENS DESIGN TO REDUCE GLARE

REPLACES 18W CFL LIGHT

1-10
FUNCTION

SCREW
FIXING

2700 K
3000 K
4000 K
COLOUR
TEMP

85
CRI

143MM
CUT OUT

Public ✓
B0 ✓
FIRE ZONES



LUMINAIRE	
type	Hella G100 , G102
IP44	
fixing method	screws
body depth	40mm

DIMENSIONS	
Diameter	186 mm
installation height	60 mm
installation cut out	143mm (up to 155mm)
weight	650 g

CABLE HARNESS, LOOP THROUGH IP20	
5 pole male	5 pole female
NCC51S.G	NCC52S.G
Ensto	Ensto

TRIM OPTIONS	
White rounded trim	346.571-00
White tapered trim	346.571-40
White square trim	346.571-20
Chrome round trim	346.571-01
Chrome tapered trim	346.571-41
Chrome square trim	346.571-21

SHIPPING	
pack type	carton
QTY of luminaires	12 pcs
length	0.48 m
width	0.30 m
height	0.26 m
gross weight	10.2 kg

Luminous Intensity Distance / Lux 3000 K

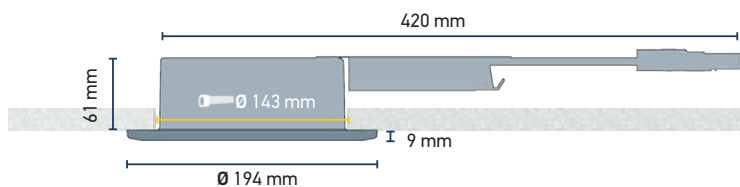
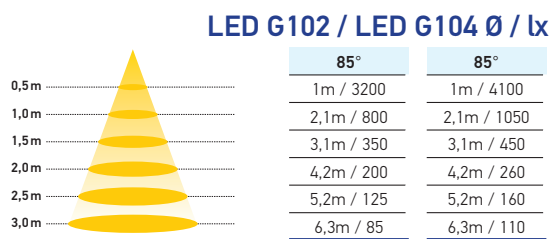

LED G102

12,5 W
POWER
CONSUMPTION

750 lm
LIGHT
OUTPUT

IP44
PROTECTION
CLASS

18 W
POWER
CONSUMPTION

1000lm
LIGHT
OUTPUT

IP44
PROTECTION
CLASS

PART NUMBERING			
Protection class	White rounded trim, concave lens		
	2700 K	3000 K	4000 K
IP44	347.207-007	347.207-017	347.207-027
Chrome tapered trim, concave lens			
Protection class	2700 K	3000 K	4000 K
	IP44	347.207-037	347.207-047
White rounded, flat lens			
Protection class	2700 K	3000 K	4000 K
	IP44	347.207-067	347.207-077
Chrome tapered, flat lens			
Protection class	2700 K	3000 K	4000 K
	IP44	347.207-097	347.207-107

PART NUMBERING			
Protection class	White rounded trim, concave lens		
	2700 K	3000 K	4000 K
IP44	347.209-007	347.209-017	347.209-027
Chrome tapered trim, concave lens			
Protection class	2700 K	3000 K	4000 K
	IP44	347.209-037	347.209-047
White rounded, flat lens			
Protection class	2700 K	3000 K	4000 K
	IP44	347.209-067	347.209-077
Chrome tapered, flat lens			
Protection class	2700 K	3000 K	4000 K
	IP44	347.209-097	347.209-107



LED S105 THEATRE

20W
POWER
CONSUMPTION

1-10V
DIM

DALI
DIM

DMX
DIM

IP23
PROTECTION
CLASS

1600lm
LIGHT
OUTPUT

3000 K
COLOUR
TEMP

90
CRI

40°
ANGLE

BOLT
FIXING

**Luminous Intensity Distance /
Lux 3000 K**

LED S105 THEATRE Ø / lx

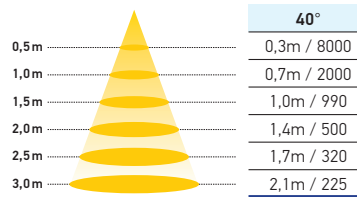

LUMINAIRE

type	Hella S105 Theatre
fixing method	bolt on, fixing for 48-51mm diameter pipe
installation	recess (rigid arms)

SHIPPING

pack type	carton
QTY of luminaires	4 pcs
length	0.49m
width	0.30 m
height	0.27 m
gross weight	11,5 kg

DIMENSIONS

Diameter	108 mm
Height	170 mm
Angle	40°
weight	2500 g

PART NUMBERING

Dimming	Black powder coat 3000 K
1-10V	345.520-007
DMX	345.520-017

CABLE SET

5x0,75mm² 5m	345.359-207
--------------------------------	-------------



CORNER LIGHT

TECHNICAL AND CREW AREAS

7W / 14W
POWER
CONSUMPTION

230 V
50/60 Hz

IP23
PROTECTION
CLASS

SCREW
FIXING

1600lm
LIGHT OUTPUT
714MM

800lm
LIGHT OUTPUT
414MM

3000K
4000K
COLOUR
TEMP



The Corner Light is a wall or corner mounted light for corridors. It has been designed and developed with an LED light source and provides excellent light distribution. The robust design, expert thermal management and optical design of the luminaire makes the Corner Light an optimal choice for technical and crew areas.

LUMINAIRE	
type	Hella Linear Corner Light
fixing method	with mounting brackets & screws

DIMENSIONS	
length	414 mm / 714 mm
height	69 mm / 98 mm
depth	98 mm / 69 mm

CABLE CONNECTION, LOOP THROUGH	
	bear cable connection
	optional, customized integrated connector

PRODUCT VERSIONS			
Length, colour temp	Lumen value	Power consumption	Product number
414 mm, 3000K	800 lm (equals 14W T5)	7W	346.960-007
714 mm, 3000K	1600 lm (equals 28W T5)	14W	346.960-027
414 mm, 4000K	800 lm (equals 14W T5)	7W	346.960-047
714 mm, 4000K	1600 lm (equals 28W T5)	14W	346.960-067

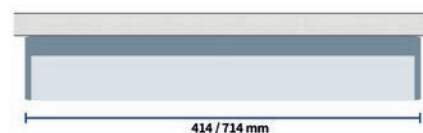
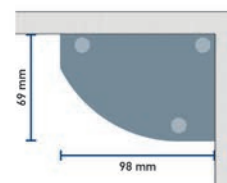

Illuminance angle, long side to ceiling

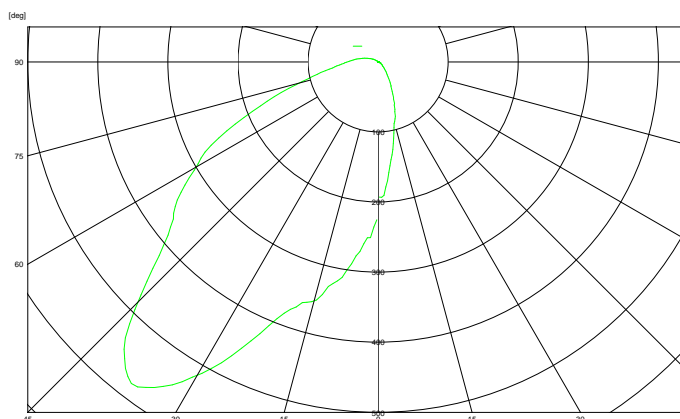

CEILING LIGHT

TECHNICAL AREAS

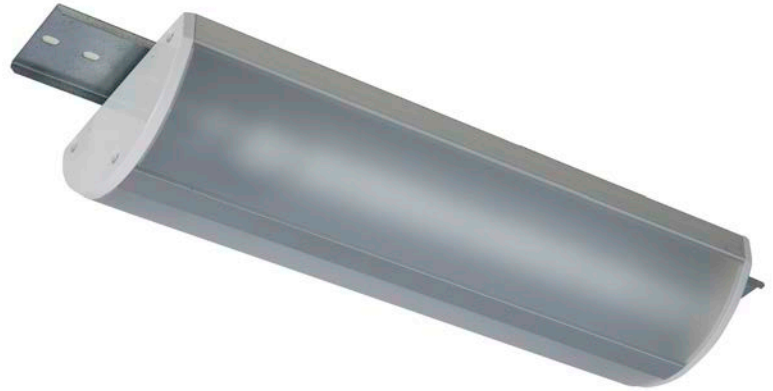

14W/ 28W POWER CONSUMPTION	230 V 50/60 Hz	IP44 PROTECTION CLASS	SCREW FIXING
3200lm LIGHT OUTPUT 714MM	1600lm LIGHT OUTPUT 414MM	3000K 4000K COLOUR TEMP	

The Ceiling Light is ceiling mounted light for engine rooms. It has been designed and developed with an LED light source and provides excellent light distribution. The robust design, expert thermal management and optical design of the luminaire makes Ceiling Light an optimal choice for engine room conditions.

LUMINAIRE	
type	Hella Linear LED Light Engine room
fixing method	with mounting brackets & screws (optimized for rail fixing)

DIMENSIONS	
length	414mm / 714mm
height	67mm
width	153mm

CABLE CONNECTION, LOOP THROUGH
bear cable connection
optional, customized integrated connector

PRODUCT VERSIONS			
Length, colour temp	Lumen value	Power consumption	Product number
414 mm, 3000K	1600 lm (equals 2 x 14W T5)	14W	346.950-007
714 mm, 3000K	3200 lm (equals 2 x 28W T5)	28W	346.950-027
414 mm, 4000K	1600 lm (equals 2 x 14W T5)	14W	346.950-047
714 mm, 4000K	3200 lm (equals 2 x 28W T5)	28W	346.950-067



Illuminance angle

