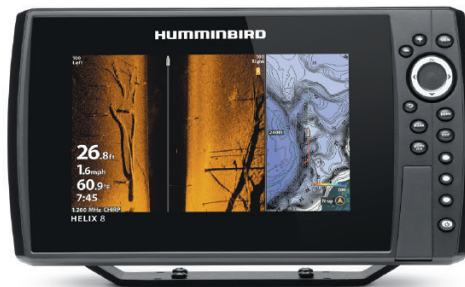
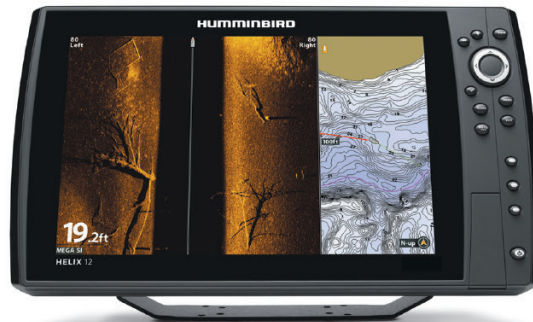


# HELIX Series


## Operations Manual


532509-5EN\_A





# THANK YOU!


Thank you for choosing Humminbird®, the #1 name in marine electronics. Humminbird has built its reputation by designing and manufacturing top quality, thoroughly reliable marine equipment. Your Humminbird is designed for trouble-free use in even the harshest marine environment. We encourage you to read this manual carefully in order to get the full benefit from all the features and applications of your Humminbird product.


 **WARNING!** This device should not be used as a navigational aid to prevent collision, grounding, boat damage, or personal injury. When the boat is moving, water depth may change too quickly to allow time for you to react. Always operate the boat at very slow speeds if you suspect shallow water or submerged objects.


 **WARNING!** The electronic chart in your Humminbird unit is an aid to navigation designed to facilitate the use of authorized government charts, not to replace them. Only official government charts and notices to mariners contain all of the current information needed for the safety of navigation, and the captain is responsible for their prudent use.


 **WARNING!** Humminbird is not responsible for the loss of data files [waypoints, routes, tracks, groups, recordings, etc.] that may occur due to direct or indirect damage to the unit's hardware or software. It is important to back up your control head's data files periodically. Data files should also be saved to your computer before restoring the control head defaults or updating the software. See the following sections of your Humminbird manual: **Manage Screen Snapshots and Recordings** and **Manage your Navigation Data: Import/Export Navigation Data**.


 **WARNING!** Disassembly and repair of this electronic unit should only be performed by authorized service personnel. Any modification of the serial number or attempt to repair the original equipment or accessories by unauthorized individuals will void the warranty.


 **WARNING!** Do NOT leave the control head microSD or SD card slot cover open. The slot cover should always be closed to prevent water damage to the unit.


 **WARNING!** Do not travel at high speed with the unit cover installed on the control head. Remove the unit cover before traveling at speeds above 20 mph.


 **WARNING!** The user shall maintain 20 cm separation from the RF device to ensure compliance with RF exposure.


 **NOTE:** Some features discussed in this manual require a separate purchase, and some features are only available on international models. Every effort has been made to clearly identify those features. Please read the manual carefully in order to understand the full capabilities of your model.

 **NOTE:** The illustrations in this manual may not look the same as your product, but your unit will function in a similar way.

 **NOTE:** To purchase accessories for your control head,

 **NOTE:** The procedures and features described in this manual are subject to change without notice. This manual was written in English and may have been translated to another language. Humminbird is not responsible for incorrect translations or discrepancies between documents.

 **NOTE:** Product specifications and features are subject to change without notice.

 **NOTE:** Humminbird verifies maximum stated depth in saltwater conditions, however actual depth performance may vary due to transducer installation, water type, thermal layers, bottom composition, and slope.

**ROHS STATEMENT:** Product designed and intended as a fixed installation or part of a system in a vessel may be considered beyond the scope of Directive 2002/95/EC of the European Parliament and of the Council of 27 January 2003 on the restriction of the use of certain hazardous substances in electrical and electronic equipment.

**ATTENTION INTERNATIONAL CUSTOMERS:** Products sold in the U.S. are not intended for use in the international market. Humminbird international units provide international features and are designed to meet country and regional regulations. Languages, maps, time zones, units of measurement, and warranty are examples of features that are customized for Humminbird international units purchased through our authorized international distributors.

360 Imaging®, AUTOCHART®, AUTOCHART® LIVE, ChartSelect®, CoastMaster™, Contour XD™, Down Imaging®, DualBeam PLUS™, Fish ID+™, FishSmart™, HELIX®, Humminbird®, HumminbirdPC™, ICE HELIX® CHIRP Series, i-Pilot® Link™, LakeMaster®, MEGA Down Imaging™, MEGA Down Imaging+™, MEGA Imaging™, MEGA Side Imaging™, MEGA Side Imaging+™, Real Time Sonar™, RTS™, RTS Window™, Side Imaging®, SI™, Structure ID™, SwitchFire®, UniMap™, WhiteLine™, X-Press™ Menu, are trademarked by or registered trademarks of Johnson Outdoors Marine Electronics, Inc.

Adobe, Acrobat, Adobe PDF, and Reader are either registered trademarks or trademarks of Adobe Systems Incorporated in the United States and/or other countries.

Baekmuk Batang, Baekmuk Dotum, Baekmuk Gulim, and Baekmuk Headline are registered trademarks owned by Kim Jeong-Hwan.

The *Bluetooth*® word mark and logos are registered trademarks owned by the Bluetooth SIG, Inc. and any use of such marks by Johnson Outdoors, Inc. is under license. Other trademarks and trade names are those of their respective owners.

microSD and SD are trademarks or registered trademarks of SD-3C, LLC in the United States, other countries or both.

Navionics® Gold, HotMaps™, and HotMaps™ Premium, Navionics® Classic Charts, Navionics+™, and Platinum™ Cartography are trademarked by or registered trademarks of Navionics S.p.A.



NMEA 2000® is a registered trademark of the National Marine Electronics Association.

# TABLE OF CONTENTS

---

<b>Warnings</b>	<b>2</b>	Review Down Imaging History and Zoom In/Out . . . . .	87
<b>Introduction</b>	<b>7</b>	Navigation in Down Imaging Views . . . . .	89
<b>Using Humminbird Manuals on your Mobile Device or PC</b>	<b>9</b>	<b>Display a Side Imaging View On-Screen</b>	<b>91</b>
<b>Getting Started</b>	<b>10</b>	Understand the Side Imaging View . . . . .	93
<b>HELIX Control Head</b>	<b>19</b>	Customize the Side Imaging View . . . . .	95
<b>Update Software</b>	<b>25</b>	Adjust Settings While you Fish. . . . .	98
<b>Menu System Overview</b>	<b>26</b>	Review Side Imaging History and Zoom In/Out . . . . .	105
Open an X-Press Menu. . . . .	26	Navigation in Side Imaging Views . . . . .	107
Open the Main Menu. . . . .	26	<b>Ice Fishing Overview</b>	<b>109</b>
Select a Menu . . . . .	27	Understand the Flasher View . . . . .	110
Change a Menu Setting . . . . .	27	Adjust Settings While you Fish. . . . .	111
Tips for Using the Menu System . . . . .	28	Move the Depth Cursor . . . . .	115
Change the User Mode (Angler or Custom). . . . .	29	Zoom In/Out in Flasher View. . . . .	116
Close the Menu System. . . . .	29	Using Sonar Zoom View in Ice Fishing Mode. . . . .	118
<b>Views</b>	<b>30</b>	Charge Glow-in-the-Dark Lures . . . . .	120
Display a View. . . . .	30	<b>Manage Screen Snapshots and Recordings</b>	<b>121</b>
Show your Favorite Views . . . . .	31	<b>Chart Overview</b>	<b>129</b>
Save a View to the VIEW SHORTCUT Key . . . . .	31	Display a Chart View On-Screen . . . . .	130
Display Digital Readouts . . . . .	32	Select a Map Source. . . . .	132
Combo Views . . . . .	36	Customize the Bird's Eye View . . . . .	138
<b>Set up Sonar</b>	<b>37</b>	Customize the Chart Instrument View . . . . .	139
<b>Display a Sonar View On-Screen</b>	<b>50</b>	Customize the Chart View . . . . .	140
Understand the Sonar Views . . . . .	52	Display Chart Overlays . . . . .	144
Customize the Sonar View . . . . .	53	Display Humminbird LakeMaster	
Adjust Sonar Display Settings . . . . .	58	Contour Lines and Depth Ranges . . . . .	146
Adjust Settings While you Fish. . . . .	62	Display Humminbird CoastMaster	
Compare Sonar Beams (Split Sonar View) . . . . .	67	Contour Lines and Depth Ranges . . . . .	148
Review Sonar History . . . . .	68	Change the Chart Orientation and Motion Mode . . . . .	150
Zoom In/Zoom Out . . . . .	69	<b>Navigation Overview</b>	<b>152</b>
Navigation in Sonar Views. . . . .	73	Navigation Alarms Overview . . . . .	154
<b>Display a Down Imaging View On-Screen</b>	<b>76</b>	Man Overboard (MOB) Navigation . . . . .	155
Understand the Down Imaging View. . . . .	78	<b>Waypoints</b>	<b>157</b>
Customize the Down Imaging View. . . . .	79	<b>Routes</b>	<b>166</b>
Adjust Settings While you Fish. . . . .	82	<b>Tracks</b>	<b>171</b>
		<b>Search</b>	<b>174</b>

# TABLE OF CONTENTS

---

<b>Manage your Navigation Data</b>	<b>176</b>
Manage Waypoints . . . . .	179
Manage Routes . . . . .	183
Manage Tracks . . . . .	190
Manage Groups . . . . .	192
Search and Organize . . . . .	196
Import/Export Navigation Data . . . . .	198
Delete All Navigation Data and Reset . . . . .	198
<b>AutoChart Live Overview</b>	<b>199</b>
Plan your Map . . . . .	199
Prepare the Control Head for Mapping . . . . .	200
Record your Custom Map . . . . .	203
Stop Recording . . . . .	204
Correct Data . . . . .	204
Using AutoChart Live in Ice Fishing Mode . . . . .	205
Open the AutoChart Live Menu . . . . .	206
Display the AutoChart Live Map . . . . .	206
Customize the AutoChart Live Map Display Settings . . . . .	208
Customize the Bottom Hardness Display Settings . . . . .	213
Customize the Vegetation Display Settings . . . . .	217
<b>Set Up a NMEA 2000 Network</b>	<b>221</b>
Understand the NMEA 2000 Instrument View . . . . .	225
<b>Manage your Control Head</b>	<b>226</b>
<b>Maintenance</b>	<b>232</b>
<b>Troubleshooting</b>	<b>233</b>
<b>Specifications</b>	<b>235</b>
<b>Statements and Acknowledgements</b>	<b>328</b>
<b>Contact Humminbird</b>	<b>330</b>



# INTRODUCTION

The instructions in this manual describe the HELIX control head operations. Review the following table to understand the features that apply to your control head.

Model	Sonar (2D)	Down Imaging	Side Imaging	CHIRP	Ethernet (optional)	GPS (Charts and Navigation)
HELIX GPS G2						✓
HELIX SONAR G2	✓					External GPS, trackplotting [separate purchase required]
HELIX DI G2	✓	✓				External GPS, trackplotting [separate purchase required]
HELIX CHIRP DI G2	✓	✓		✓		External GPS, trackplotting [separate purchase required]
HELIX CHIRP GPS G2/G2N	✓			✓	G2N models only	✓
HELIX CHIRP DI GPS G2/G2N	✓	✓		✓	G2N models only	✓
HELIX CHIRP SI GPS G2/G2N	✓	✓	✓	✓	G2N models only	✓
HELIX CHIRP MEGA SI GPS G2N	✓	MEGA	MEGA	✓	✓	✓
HELIX CHIRP MEGA DI GPS G2N	✓	MEGA		✓	✓	✓
ICE HELIX CHIRP G2	✓			✓		External GPS, trackplotting [separate purchase required]
ICE HELIX CHIRP GPS G2/G2N	✓			✓	G2N models [in Open Water Mode only]	✓
ICE HELIX CHIRP GPS G3/G3N	✓			✓	G3N models [in Open Water Mode only]	✓
HELIX CHIRP GPS G3/G3N	✓			✓	G3N models only	✓
HELIX CHIRP MEGA DI GPS G3/G3N	✓	MEGA		✓	G3N models only	✓
HELIX CHIRP MEGA SI GPS G3/G3N	✓	MEGA	MEGA	✓	G3N models only	✓
HELIX CHIRP MEGA DI+ GPS G3N	✓	MEGA+		✓	✓	✓
HELIX CHIRP MEGA SI+ GPS G3N	✓	MEGA+	MEGA+	✓	✓	✓
HELIX CHIRP GPS G4N	✓			✓	✓	✓
HELIX CHIRP MEGA DI GPS G4N	✓	MEGA		✓	✓	✓
HELIX CHIRP MEGA DI+ GPS G4N	✓	MEGA+		✓	✓	✓
HELIX CHIRP MEGA SI+ GPS G4N	✓	MEGA+	MEGA+	✓	✓	✓

**Operations Summary Guide:** For an overview of functions, see the Operations Summary Guide (or Quick Start Guide) included with your product.

**Accessories:** Some of the features shown in this manual require a separate purchase. Radar, AIS, Compass/Heading Sensor, Ethernet, i-Pilot Link, etc. require a separate purchase.



# USING HUMMINBIRD MANUALS ON YOUR MOBILE DEVICE OR PC

The Humminbird manuals for your control head and accessories can be downloaded to your mobile device or PC. If you prefer to use a hard copy for reference, this manual may be printed.

## Download the Manual to your Mobile Device

1. Download the free Adobe Acrobat Reader app to your mobile device.
2. Go to our Web site Support > Manuals.
3. Select the PDF for your control head model or accessory, and save it to your device.
4. Open the Adobe Acrobat Reader app.
5. Open the Humminbird manual.

## Download the Manual to your PC

1. Download the free Adobe Acrobat Reader software it on your PC.
2. Go to our Web site and click Support > Manuals.
3. Select the PDF for your control head model or accessory, and save it to your device.
4. Open Adobe Acrobat Reader.
5. Open the Humminbird manual.

**Jump to a Section:** Click a section name in the Bookmarks panel. Bookmarks can be expanded and collapsed by clicking on the plus [+] or minus [-] icons.

**Search for Words or Phrases:** Press and hold the Ctrl F keys on your PC keyboard. Type the word(s) into the text box. **Print:** If you prefer to use a hard copy for reference, this manual may be printed.

### Using the Manual




## GETTING STARTED

---

The procedures in this section describe how to get started with your control head. Some of the settings in this section are a one-time set up, and other settings [such as checking the GPS reception] you will use each time you hit the water.

### Power On

Follow the instructions below to power on your Humminbird control head.

1. Press the  POWER key.
2. When the Title screen is displayed, press the MENU key.


#### Title Screen



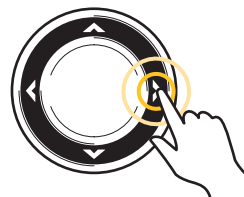
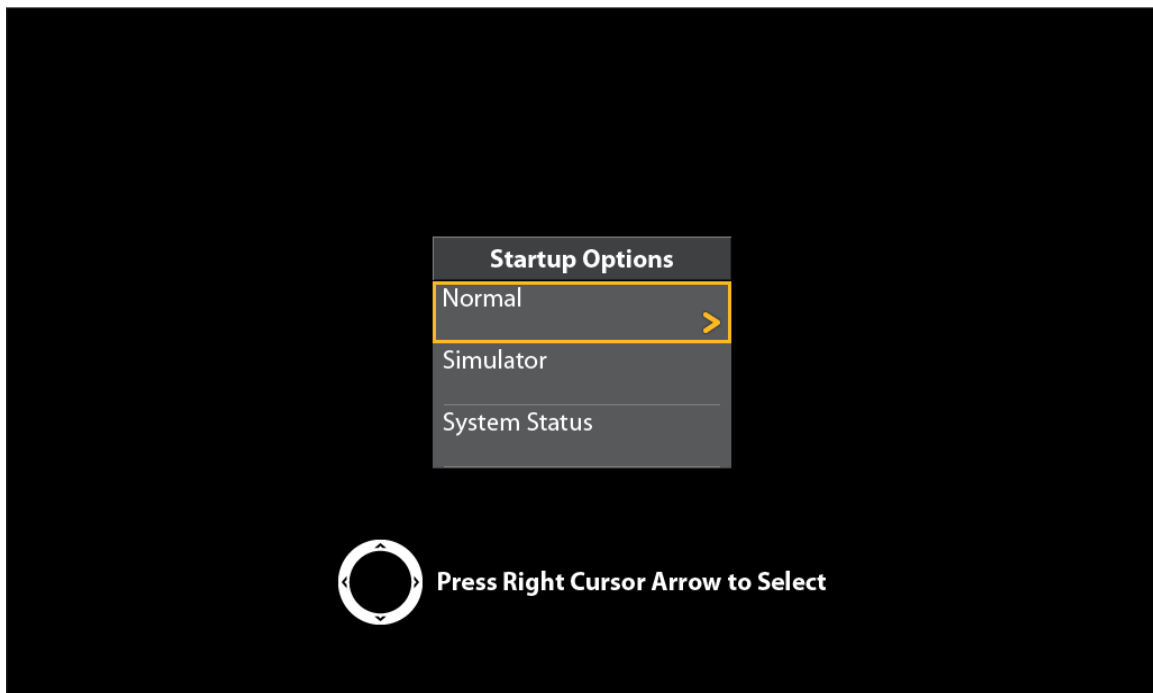
Press the MENU key

3. Select Normal. Press the RIGHT Cursor key.

Normal	Normal mode is required for on-the-water operation. If a functioning transducer is connected to the control head, Normal will be selected automatically, and your control head can be used on the water.
Simulator	To learn how to use your control head, select Simulator. You can save menu settings and navigation data in Simulator mode (see <i>Chart Overview</i> and <i>Navigation Overview</i> for more information).
System Status	To view system information for software version, GPS reception, and accessory connections, select System Status. See <i>Check Accessory Connections</i> and <i>Check GPS Reception</i> for more information.

 **NOTE:** If you wait too long to select a start-up option, the system will start the mode that is already highlighted. If your control head goes into Demonstration mode, please note that menu settings cannot be saved in this mode (see *Manage your Control Head*).

### Starting Normal Mode for on-the-water Operations



Press the  
RIGHT Cursor key

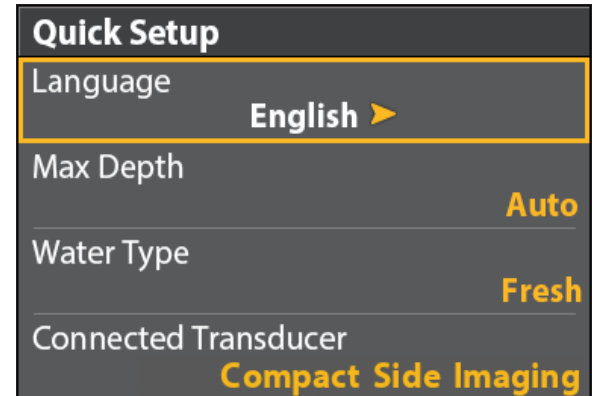
## Quick Setup


If this is the first time the unit has been powered on [after installation or after restoring defaults], the Quick Setup menu will display.

### Set up the Control Head

1. Use the Cursor Control key to change the settings.
2. **Close:** Press the EXIT key.

#### Quick Setup Menu



<p><b>Language</b></p>	<p>The available languages are determined by your Humminbird model.</p> <p> <b>WARNING!</b> Do NOT enable Asian Mode if you do not require Asian languages. Before you select Asian Mode, contact Technical Support for important information.</p>
<p><b>Max Depth</b></p>	<p>Set the maximum depth of the body of water. When Max Depth is set to Auto, the control head will acquire bottom readings as needed [within the capabilities of the unit]. When Max Depth is set to match your water maximum depth, the control head will not attempt to acquire sonar data below that depth, so more detail will be shown on the display.</p> <p><b>Side Imaging units</b> default to the Side Imaging range setting if the SI Range is set deeper than the Max Depth. See the <i>Side Imaging</i> section for more information.</p>
<p><b>Water Type</b></p>	<p>Water Type affects the accuracy of deep water depth readings and configures the control head for operation in fresh or salt water.</p> <p>In salt water, you can also choose the shallow or deep setting. If the depth is more than 330 ft [100 m], select Salt [deep].</p>
<p><b>Connected Transducer</b></p>	<p>The control head will automatically select the transducer that was included with your control head. If your model is compatible with an accessory transducer, and it is connected to the control head, select the transducer in the system so the beams are activated and the related views are added to the control head.</p>



**NOTE:** To change the Max Depth, Water Type, and the Connected Transducer after the initial Setup, see **Set up Sonar**.

## Check Accessory Connections

If you've connected other separate-purchase equipment to the control head, such as AIS, Compass/Heading Sensor, and more, use these instructions to confirm the equipment is detected and communicating with the control head. You can also check Ethernet accessory connections from this view.

1. Press and hold the VIEW key.
2. Select System > Accessory Test.

**Confirm all accessories are listed as Connected.** If you have a temp/speed wheel, the wheel must move for it to be detected.

**Unconnected:** If an accessory is listed as Unconnected, check the cable and power connections to confirm they are secure and powered on. Review the installation guide that was included with your accessory to confirm it is installed correctly.

To change the NMEA 2000 network, see *Set Up a NMEA 2000 Network*.

### Confirming Accessories are Detected (HELIX 9 CHIRP SI GPS G2N)

Depth		ft		Accessory Test	
40.6		360 Imaging		UNCONNECTED	unconnected (not detected by the control head)
Temp		GPS		CONNECTED	
69.4		i-Pilot		UNCONNECTED	connected
N 50°40.952'		NMEA2K Gateway		CONNECTED	
W 001°03.177'		CHIRP-Radar		CONNECTED	
Time		Remote		UNCONNECTED	
1:00		Speed		UNCONNECTED	
Speed		Temperature		CONNECTED	
5.6					



**NOTE:** The menus for installed accessories are typically included in the Accessory tab in the Main Menu. See your accessory guide for details.

## Check GPS Reception

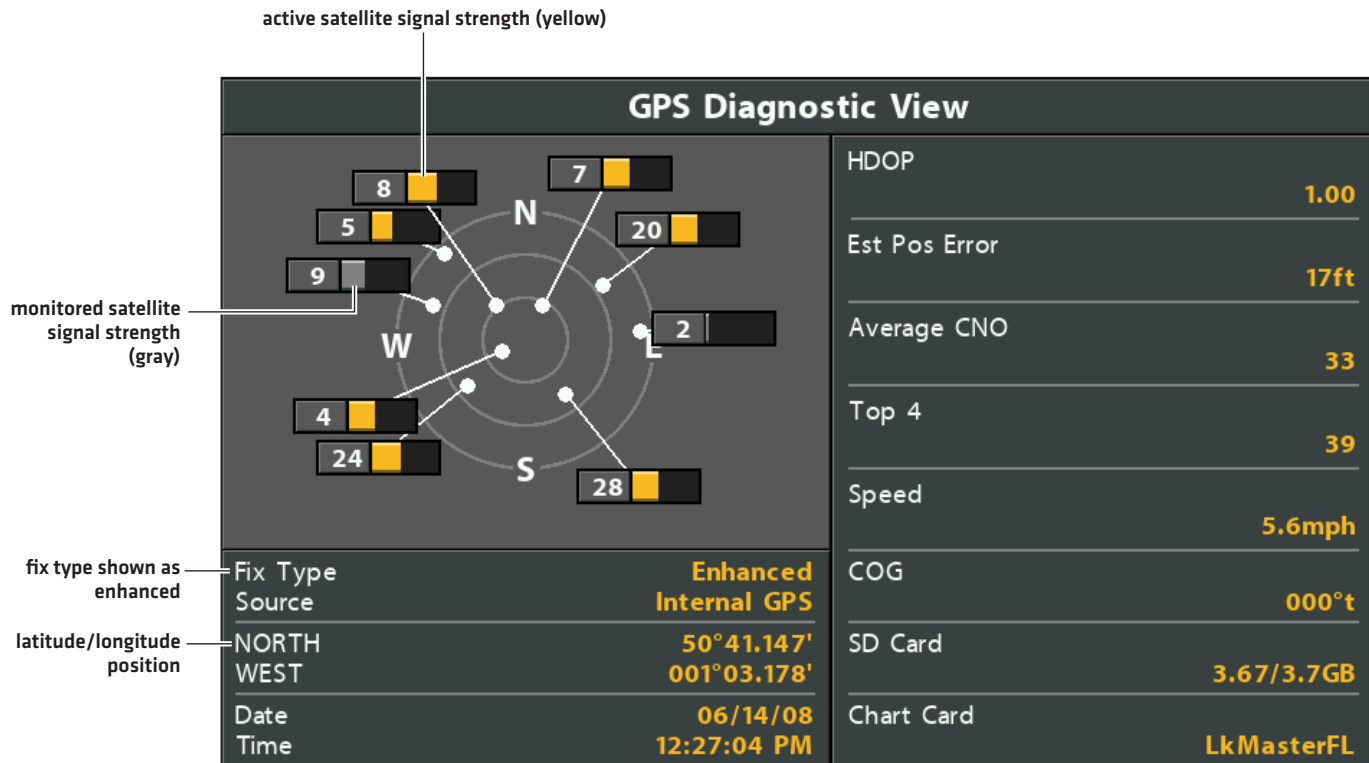
If your control head includes internal GPS, or if it is connected to an External GPS receiver, use the instructions in this section to confirm the control head has GPS reception.

1. Press and hold the VIEW key.
2. Select System > GPS Diagnostic View.

**Confirm GPS Fix Type** is shown as Enhanced or 3D.

**Confirm that the latitude/longitude position** readout is displayed.

### Reviewing GPS Reception



**GPS Reception:** The sky chart displays the satellite number and signal strength bar.

**GPS Fix Type:** reported as No Fix, 2D Fix, 3D Fix, or Enhanced. An Enhanced Fix has been augmented using information from WAAS, EGNOS, or MSAS.

**HDOP [the Horizontal Dilution of Precision]:** a GPS system parameter which depends on the current satellite configuration. HDOP is used to calculate the Estimated Position Error.



**NOTE:** To manually change your GPS source, change the output frequency, or turn on GLONASS, see **Manage your Control Head**.

## Set Alarms

When an alarm is turned on, an alert will sound or display on the control head to indicate the threshold has been exceeded.

### Turn on Alarms and Adjust Settings

1. **Main Menu:** Press the MENU key twice.

OR

To open the Main Menu from a System View, press the MENU key once.

2. Select the **Alarms** tab.
3. Select an alarm menu. Press the RIGHT or LEFT Cursor keys to adjust the threshold.

<b>Depth Alarm</b>	The alarm will be triggered when the depth becomes equal to or less than the menu setting. Transducer required.
<b>Fish ID Alarm</b>	The alarm will be triggered when a fish is detected based on the menu setting. See <b>Adjust Sonar Display Settings</b> for more information.
<b>Low Battery Alarm</b>	The alarm will be triggered when the input battery voltage is equal to or less than the menu setting. The battery must be connected to the control head. Set the alarm to a level that will alert you when the battery is low but at a level that is high enough to start the engine and run essential electronics. See your control head installation guide for more information.
<b>Temp. Alarm</b>	The alarm will be triggered when the water temperature detected by the control head is equal to the temp alarm setting. Input from the built-in transducer temperature sensor or a temperature accessory is required.
<b>Off Course Alarm</b>	Sets how far the boat can move off course during navigation before an alarm will be triggered. GPS required. See <b>Navigation Overview</b> for more information.
<b>Arrival Alarm</b>	Sets how close the boat must be to the destination waypoint before the alarm will be triggered. GPS required. See <b>Navigation Overview</b> for more information.
<b>Drift Alarm</b>	Sets how far the boat can move from its anchored position outside the drift alarm perimeter before an alarm will be triggered. GPS required. See <b>Navigation Overview</b> for more information.



**NOTE:** The available alarms are determined by the connected equipment, so your control head may provide more or less options than the information shown here. If there are accessories installed, review the accessory guide for alarm information.

4. **Close:** Press the EXIT key twice.

### Exit an Alarm

If an alarm is triggered during control head operation, you can close it or silence it using these instructions.



1. Press any key on the control head.

## Change Units of Measurement

Use the instructions in this section to change the units of measurement format.

### HELIX G3/G3N and older

1. **Main Menu:** Press the MENU key twice.
2. Select the Setup tab.
3. Select Units - Depth, Units - Distance, etc., and adjust each unit setting as needed.
4. **Close:** Press the EXIT key.



**NOTE:** You can also change the time and date format, language, and installation offsets from this menu. See **Manage your Control Head** for more information.

### HELIX G4N

1. **Main Menu:** Press the MENU key twice.
2. Select the Data Sources tab.
3. Select Units and press the RIGHT Cursor key to open the **Units** menu.
4. Select each unit as needed and use the RIGHT or LEFT Cursor keys to adjust the setting.
5. **Close:** Press the EXIT key.

## Reset the Triplog

The Triplog includes the timer for elapsed time, distance traveled since last reset, and average speed. Use the following instructions to reset the triplog. To display the Triplog as a digital readout, see **Views: Display Digital Readouts**.

### HELIX G3/G3N and older

1. **Main Menu:** Press the MENU key twice.
2. Select the **Setup** tab.
3. Select Triplog Reset.
4. Press the RIGHT Cursor key.
5. Follow the on-screen prompts.

### HELIX G4N

1. **Main Menu:** Press the MENU key twice.
2. Select the **Data Sources** tab.
3. Select Reset Trip Log.
4. Press the RIGHT Cursor key.
5. Follow the on-screen prompts.

## Turn on/off Sounds

Use the instructions in this section to choose the category of sounds you want to hear from your control head.

1. **Main Menu:** Press the MENU key twice.
2. Select the **Setup** tab.
3. Select Sound Control.
4. Select All Sounds or Alarms Only.

**To receive a sound alert from an alarm,** Sound Control must be set to All Sounds or Alarms Only.

**Change the Alarm Tone:** Select the **Alarms** tab > Alarm Tone.

## Change the User Mode

The User Mode determines how many menu options are displayed in the menu system. Select **Angler** to see fewer menu options that are used more often. Select **Custom** to see all the menu options available in the menu system.

Instructions in this manual marked with **Main Menu (Custom User Mode)** indicate that the menu system User Mode must be set to Custom for the selected menu to be shown. If you do not see the menu in the system, change the User Mode to Custom. See **Menu System Overview** for details.

1. **Main Menu:** Press the MENU key twice.
2. Select the **Setup** tab.
3. Select User Mode.
4. Select Angler or Custom.



## Set up Sonar

If you've installed an accessory transducer, or to refine your sonar settings or turn on/off Ice Fishing Mode, see **Set up Sonar** for details.

## Set up Chart Preferences

If you've installed a microSD or SD map card, see **Chart Overview** to set up the map source.

## Pair a Phone with the Control Head (HELIX G2N/G3N/G4N Series only)

If you have a HELIX G2N, G3N or G4N Series control head, you can pair a phone with it using **Bluetooth** wireless technology.

### Pair a Phone with the Control Head

#### HELIX G2N and G3N

1. **Main Menu:** On the HELIX control head, press the MENU key twice.
2. **Open the Phone Bluetooth Menu:** Select the Accessories tab.  
Select Phone Bluetooth. Press the RIGHT Cursor key.
3. Select Bluetooth.
4. Select On.
5. Select Connect New Phone. Press the RIGHT Cursor key.  
It will take a moment for this option to appear in the menu.
6. Follow the on-screen prompts to start the pairing process.  
If the phone is not found, select Search for Phone. Press the RIGHT Cursor key.
7. When the phone name displays in the menu, select it. Press the RIGHT Cursor key.
8. Check your phone. When prompted, tap Pair on your phone.
9. In your phone Settings menu, turn on Show Notifications.

#### HELIX G4N

1. **Main Menu:** On the HELIX control head, press the MENU key twice.
2. **Open the Phone Bluetooth Menu:** Select the Accessories tab.  
Select Phone Bluetooth. Press the RIGHT Cursor key.
3. Select Connect Phone. Press the RIGHT Cursor key.
4. Follow the on-screen prompts to start the pairing process through your phone.
5. When prompted, tap Pair on your phone.
6. In your phone Settings menu, turn on Show Notifications.

### Change the Phone Bluetooth Alert Format

Use the following instructions to select an alert format on the control head or turn off alerts.

1. On the HELIX control head, open the Phone Bluetooth menu.



**NOTE:** In your phone Settings menu, confirm that **Bluetooth** is turned on and **Show Notifications** is turned on.

2. Select Text Message Alerts or Phone Call Alerts.

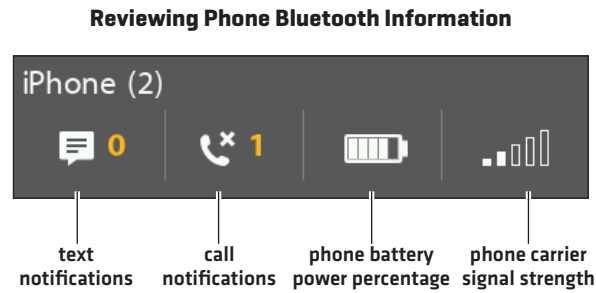
Press the RIGHT or LEFT Cursor keys to select an alert format. To turn off notifications, select off.

3. Select Sounds. Select On or Off.

## Review Phone Bluetooth Notifications

Use the Views X-Press Menu to review notifications.

1. Press and hold the VIEW key.



## Adjust the Backlight

1. Press the POWER key.
2. Select Light.
3. Adjust the Backlight setting from Dim to 10 [brightest].

## Start Standby Mode

To conserve power while the control head is not in-use, start Standby mode.

1. Press the POWER key.
2. Select Standby.
3. Press the RIGHT Cursor key.
4. **Turn off:** Press the POWER key.

## Power Off

Use the following instructions to power off your control head. Your control head should always be turned off using the POWER key.

**If you are currently navigating,** you should save the current track before powering off.

### Save the Current Track

1. **Chart X-Press Menu:** With a Chart View displayed on-screen, press the MENU key once.
2. Select Save Current Track.
3. Press the RIGHT Cursor key.

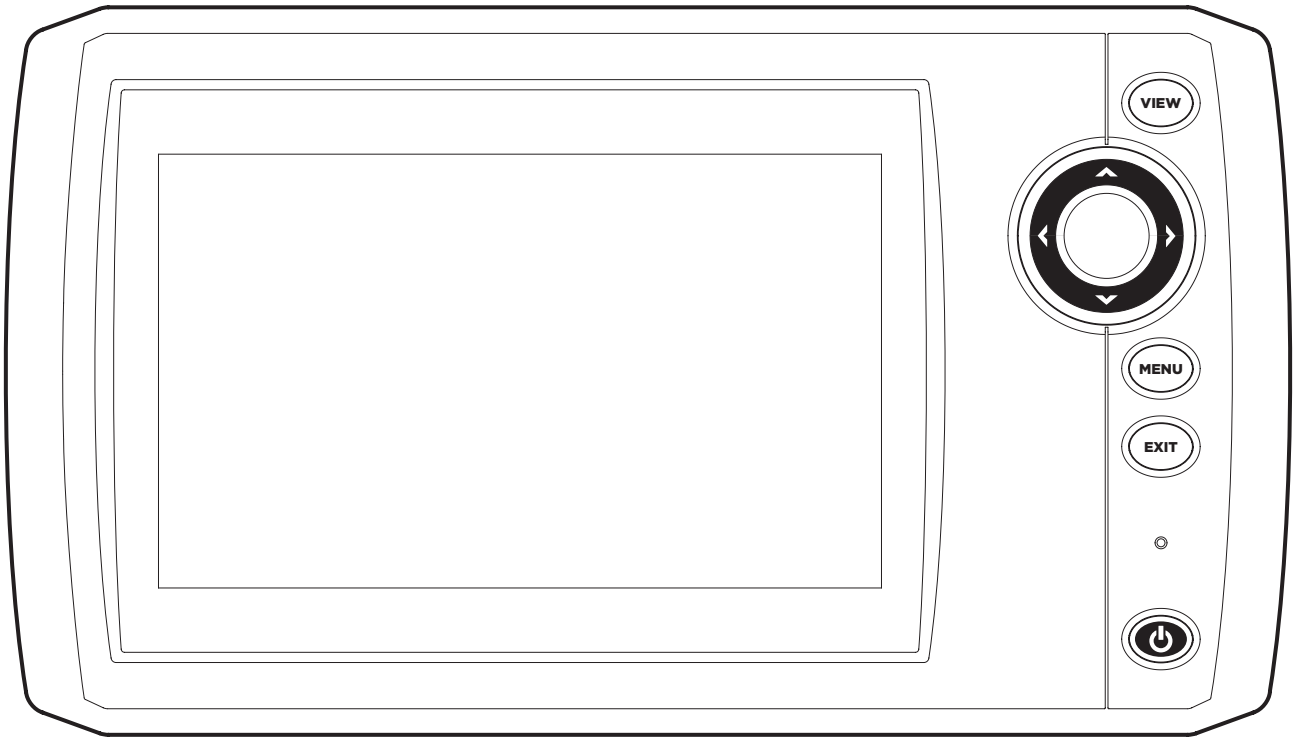
### Power Off

1. Press and hold the POWER key.

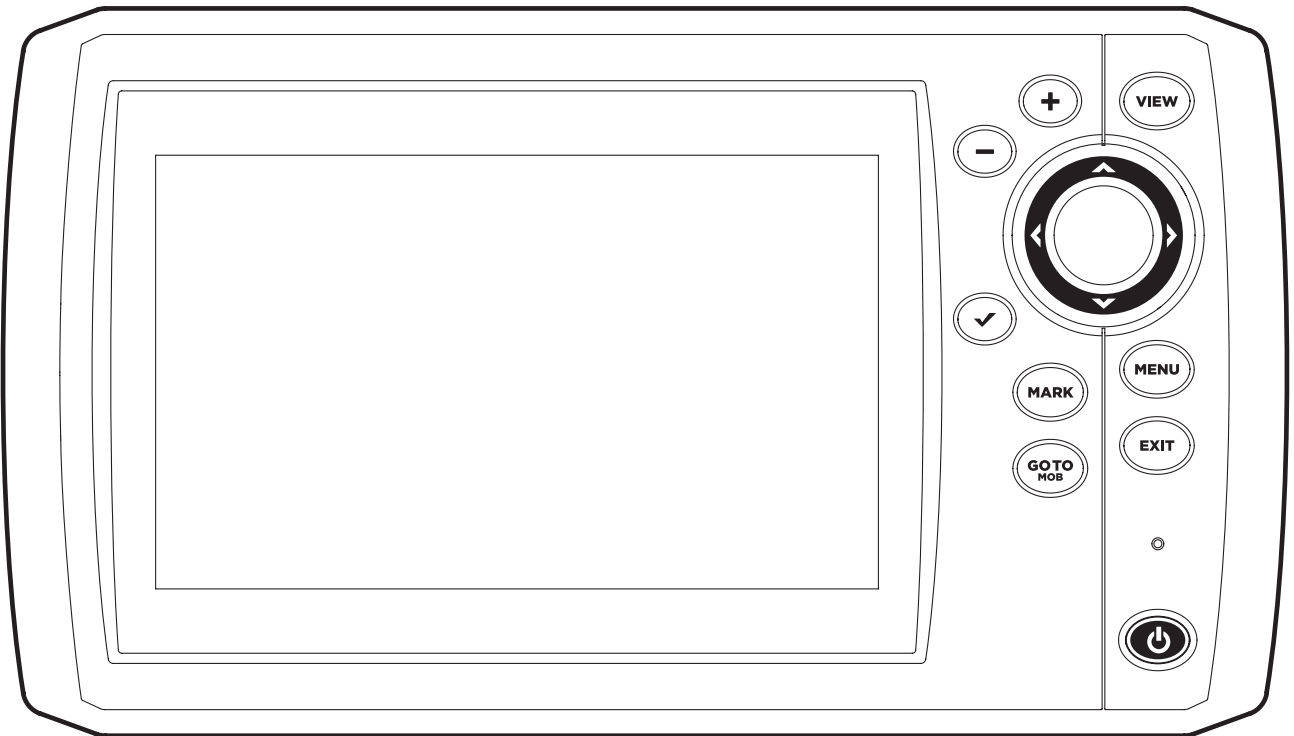
# HELIX CONTROL HEAD

---

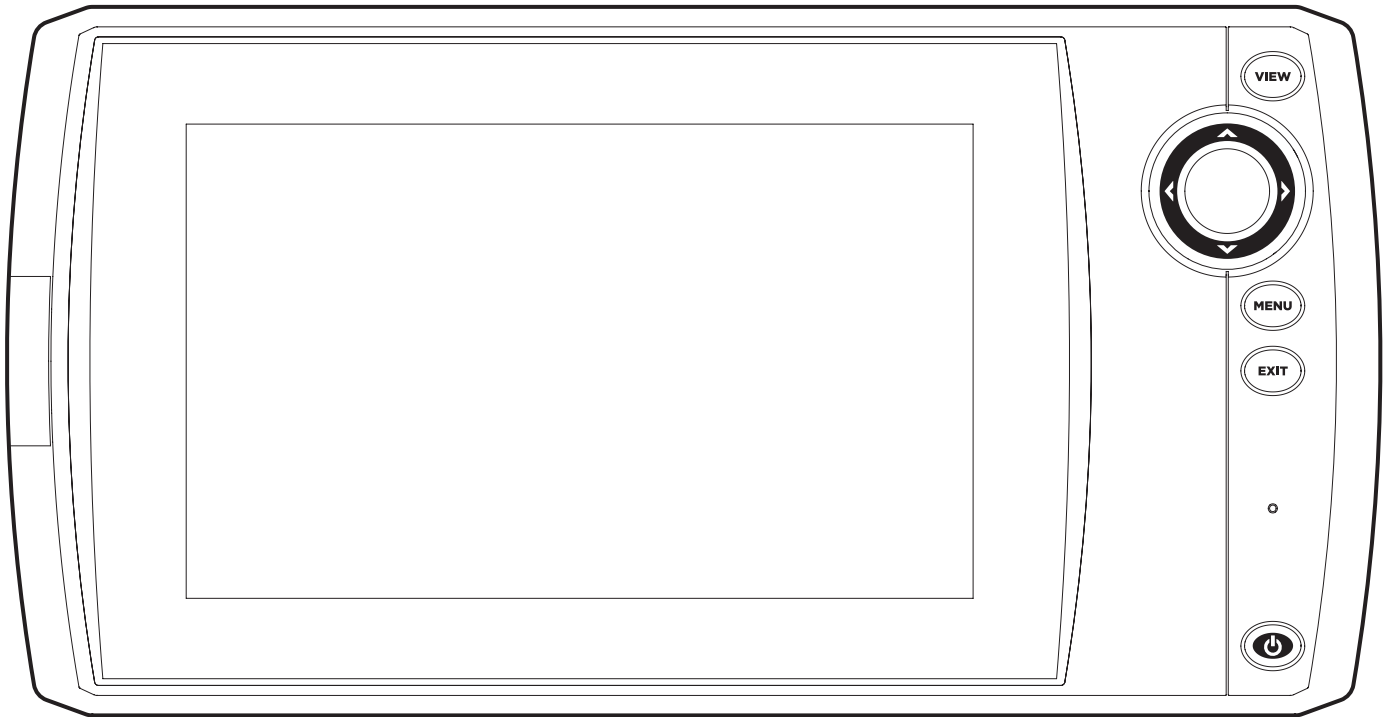
HELIX 5 SONAR G2, HELIX 5 DI G2, ICE HELIX 5 CHIRP G2



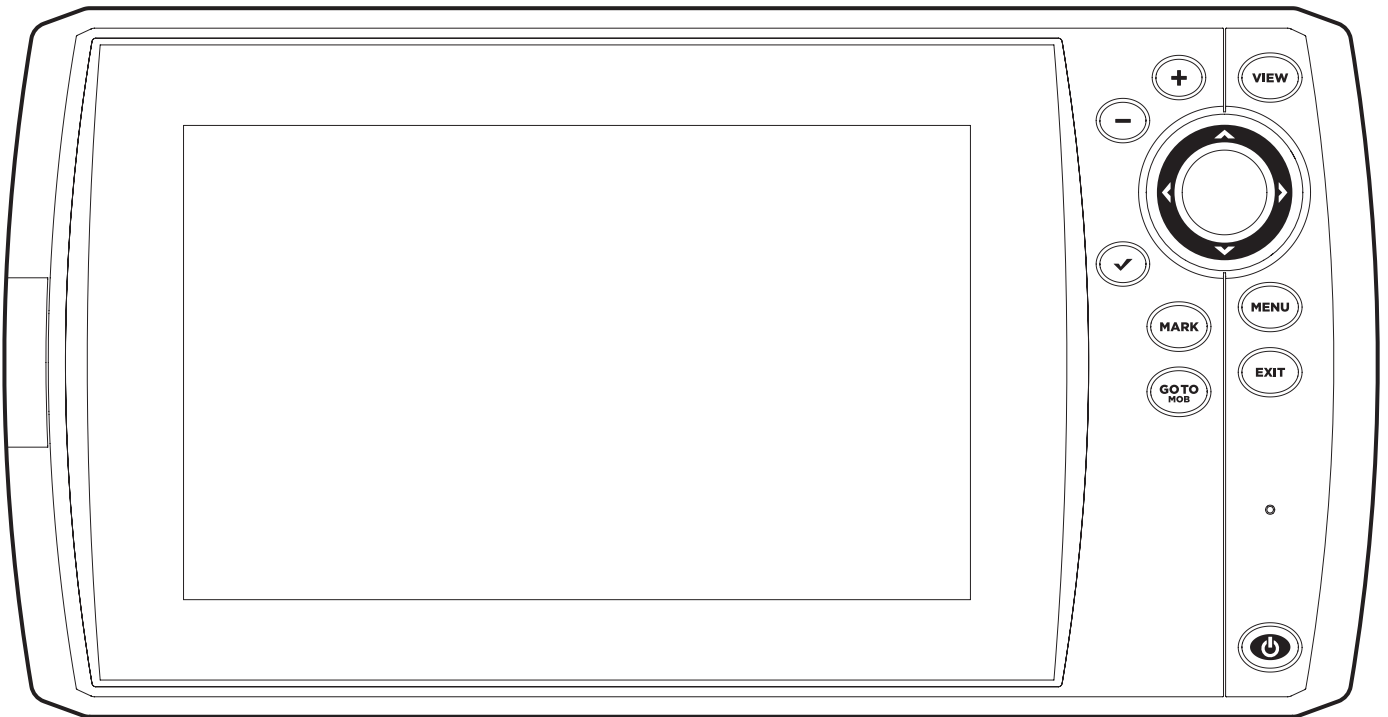
ICE HELIX 5 CHIRP GPS G2



**HELIX 7 SONAR G2, HELIX 7 CHIRP DI G2**



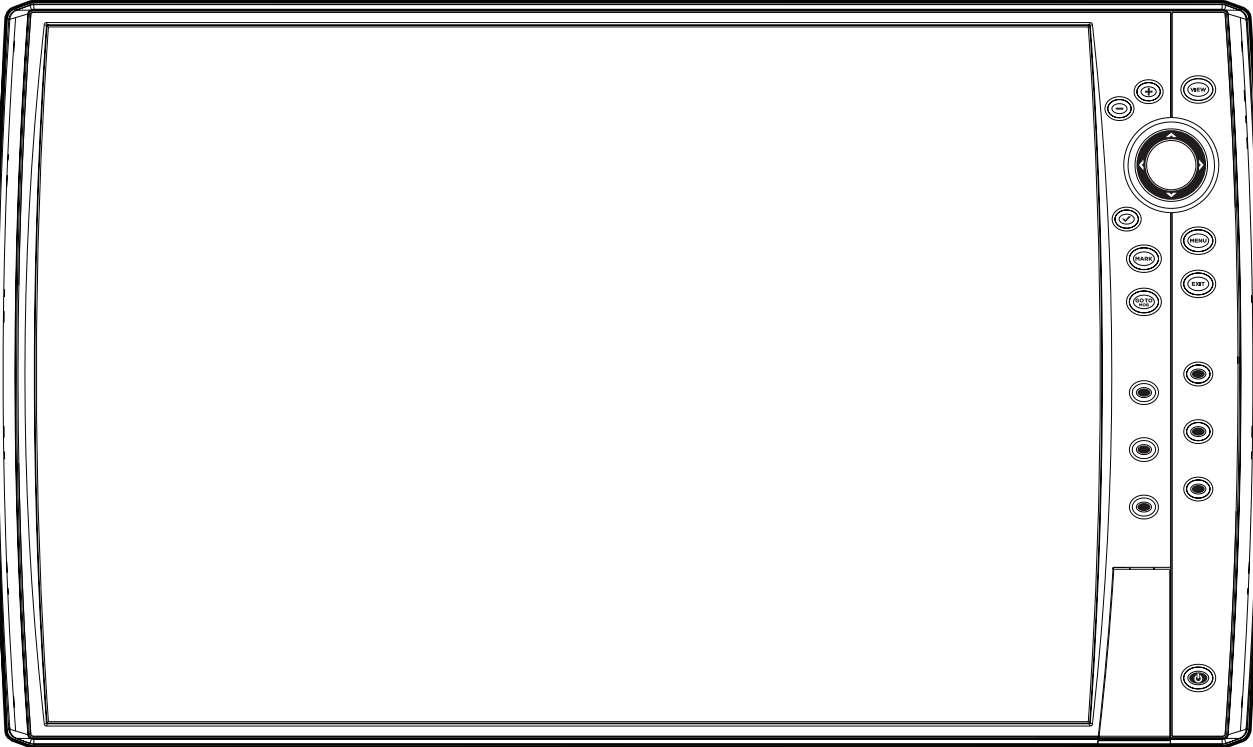
**HELIX 7 G2/G2N and G3/G3N Series Models (with Internal GPS), ICE HELIX 7 CHIRP GPS G3/G3N**



**HELIX 8, 9, 10, 12 G2N/G3N/G4N Series**



**HELIX 15 G4N**



## Control Head Keys

The available keys are determined by your control head model. Your control head might not include all the keys shown in this section.

### ZOOM IN (+)/ZOOM OUT (-) KEYS

Press the ZOOM keys to change the scale of the view. **For a closer view**, press the ZOOM IN [+] key. **For a wider view**, press the ZOOM OUT [-] key. You can also magnify the cursor selection. You can also press these keys to adjust the sensitivity in sonar views [Sonar, DI, SI].

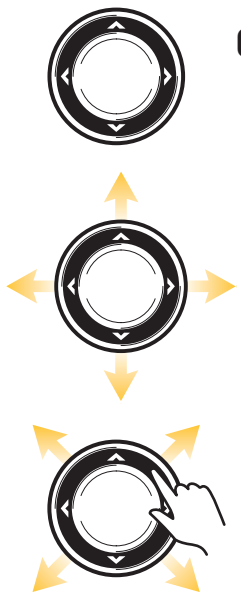
### VIEW KEY

Press and hold the VIEW key to open the Views X-Press menu, or press the VIEW key repeatedly until the view you want to use is displayed on the screen. Press the EXIT key to display the previous view. See **Views** for details.

### CHECK/INFO KEY

In the Chart View, press the CHECK/INFO key to see information about the cursor position or about objects located near the cursor position. If the cursor is not active, the Chart Info submenu will open. See **Navigation Overview** for details.

In Sonar Views, press this key once to switch frequencies [if available]. See each sonar section [Sonar, DI, SI] for details.



### CURSOR CONTROL KEY [LEFT, RIGHT, UP, or DOWN Cursor keys]

Press the arrows on the Cursor Control key to move through the menu system, select menus, and change or activate menu settings. See **Menu System Overview** for details.

Also, press any arrow on the Cursor Control key to move the cursor on the view.

To move the cursor diagonally, press in between the arrows.

### MARK KEY

Press the MARK key to save a waypoint at the boat position. If the cursor is active, press the MARK key twice to save a waypoint at the cursor position. See **Navigation Overview** for details.

If a microSD or SD card is installed, press and hold this key to save a Screen Snapshot. See **Manage Screen Snapshots and Recordings** for details.

### MENU KEY

To open the X-Press Menu for the on-screen view and operation mode, press the MENU key once. To open the Main Menu, press the MENU key twice. See **Menu System Overview** for details.

### GO TO/MAN OVERBOARD (MOB) KEY

With an active cursor, press the GOTO key twice to create a waypoint and start navigation towards that waypoint. If the cursor is not active, press the GOTO key, and choose from the saved navigation data.

To start Man Overboard navigation, press and hold the GOTO key. See **Navigation Overview** and **Man Overboard [MOB] Navigation** for details.

### EXIT KEY

Press the EXIT key to close a menu, close a dialog box, turn off an alarm, or exit Cursor mode.

Also, press the EXIT key to scroll through the View Rotation in reverse order. See **Views** for details.

### VIEW SHORTCUT KEY

Press and hold a VIEW SHORTCUT key to save a shortcut to the on-screen view. You can save one view on each VIEW SHORTCUT key. See **Views** for details.

### POWER KEY

Press the POWER key to power on the control head. To power off, press and hold the POWER key.

During operation, press the POWER key. The backlight can be adjusted from this menu. You can also turn on/off Sonar, change the view background color, and start Standby mode.

## SD Card or microSD Card Slot

Your control head may be compatible with an SD or microSD card [separate purchase required]. Use it to update software, add detailed charts to your control head, import/export navigation data, and save sonar recordings and screen snapshots. Use the instructions in this section to install the card.

**Add Maps:** see *Chart Overview*.

**Import/Export Navigation data:** See *Manage your Navigation Data*.

**Sonar Recordings and Screen Snapshots:** See *Manage Screen Snapshots and Recordings*.

**Software Updates:** For details, see *Update Software*.

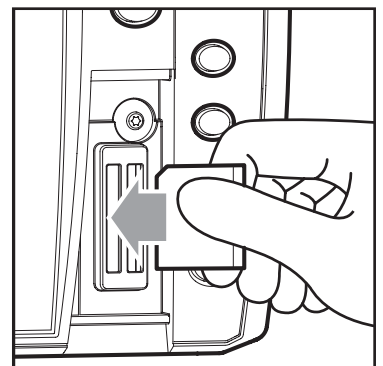
**CAUTION!** Before the control head software is updated or restored to system defaults, export your navigation data [see *Update Software*].

### Insert an SD Card

Follow these steps if your control head is compatible with SD cards.

1. Remove the SD card slot cover.
2. Position the SD card so that the label faces to the left.
3. Insert the card into the slot until it clicks into place.
4. Replace the slot cover so it is secure.
5. **Remove:** Press the card into the slot and then release it. The card will eject. Pull the card carefully from the slot.

**NOTE:** Do not leave the SD card slot cover open. The slot cover should always be closed to prevent water damage to the unit.



Insert the SD card with the label facing to the left

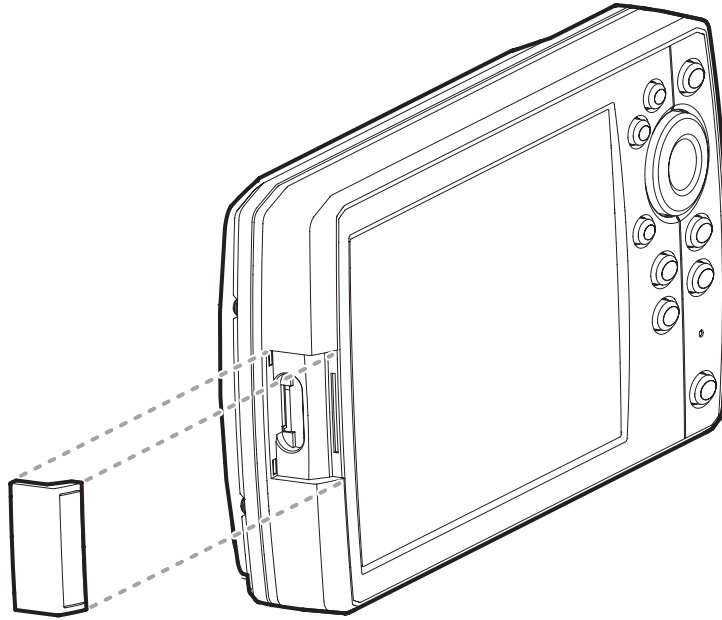
### Insert a microSD Card

Follow these steps if your control head is compatible with microSD cards.

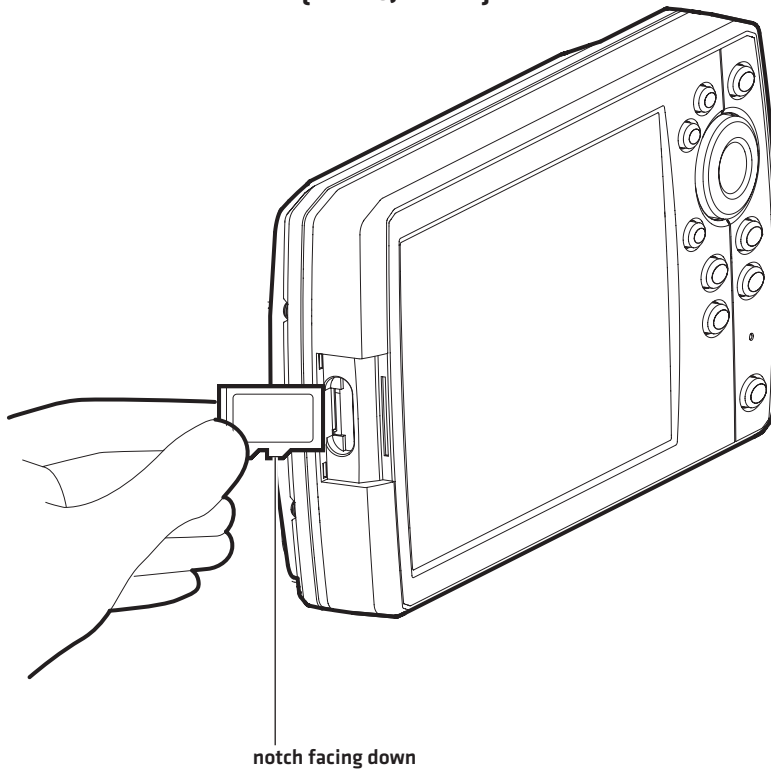
1. Remove the microSD card slot cover.
2. **Side Card Slot:** Position the microSD card so that the label faces the front of the control head and the card notches face down.  
**Front Card Slot:** Position the microSD card so that the label faces to the left and the card notches face up.
3. Insert the card into the slot until it clicks into place.
4. Replace the slot cover so it is secure.
5. **To Remove:** Press the card into the slot and then release it. The card will eject. Pull the card carefully from the slot.

**NOTE:** Do not leave the card slot cover open. The slot cover should always be closed to prevent water damage to the unit.

**Removing the microSD Card Slot Cover (HELIX 5, HELIX 7)**



**Installing a microSD Card (magnified view)  
(HELIX 5, HELIX 7)**





## UPDATE SOFTWARE

---

You can also download HumminbirdPC, which allows you to manage your waypoints, routes, and tracks on your personal computer.



**NOTE:** It is important to back up your control head's data files [waypoints, routes, tracks, groups, recordings, etc.] periodically. Data files should also be saved to your PC before restoring the unit's defaults or updating the software. See **Manage your Navigation Data: Import/Export Navigation Data** and **Manage Screen Snapshots and Recordings** for more information. Also, contact Humminbird Technical Support with any questions.

**Required Equipment:** Personal computer with Internet access, and a formatted microSD or SD card. See **HELIX Control Head** for compatibility details.

### Register your Humminbird Products

Register your Humminbird product and sign up to receive the latest Humminbird news, including software updates and new product announcements.

1. Go to our Web Support > Register your Product.
2. Follow the on-screen instructions to register your product.

### Update the Control Head Software

Use the following instructions to download software updates

1. Install a formatted microSD or SD card into the slot on your PC.
2. **Download:** Click Support > Software Updates. The available software updates are listed as **Downloads** under each product.
  - Under Downloads, click the file name. Confirm the file name is for your control head model.
  - Read the instructions in the dialog box and select Download.
  - Follow the on-screen prompts to save the software file to the microSD or SD card.
3. Install the microSD or SD card with the updated software file into the control head card slot.
4. **Power On:** The control head will recognize the new software and run through a series of prompts to confirm the software installation.

# MENU SYSTEM OVERVIEW

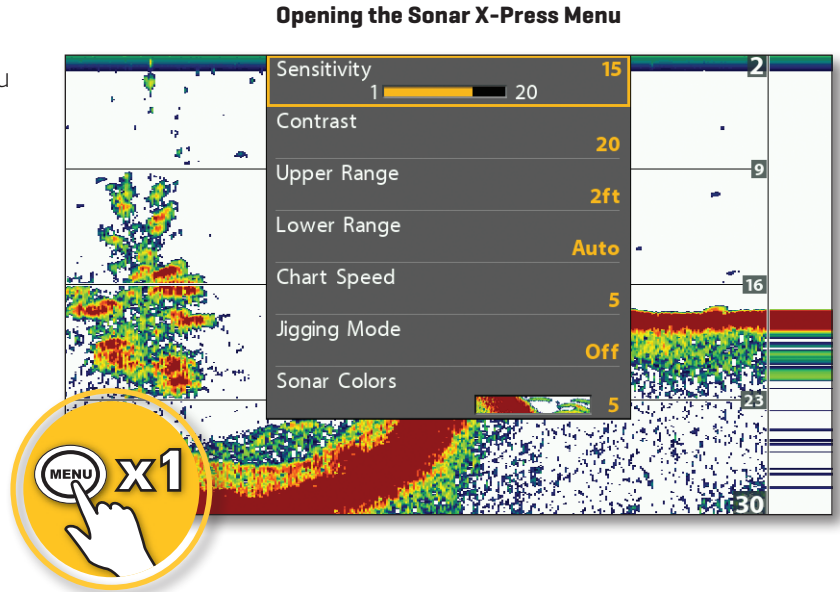
The menu system provides menu options that are determined by the operations mode, on-screen view, and connected accessories.

## Open an X-Press Menu

The X-Press Menu displays menus that are related to the on-screen view and the operations mode [such as navigation]. In this illustration, the Sonar X-Press Menu is displayed because the Sonar View is displayed on the screen.

### Open the X-Press Menu

1. Press the VIEW key repeatedly until the view you want is displayed on-screen.
2. Press the MENU key once.

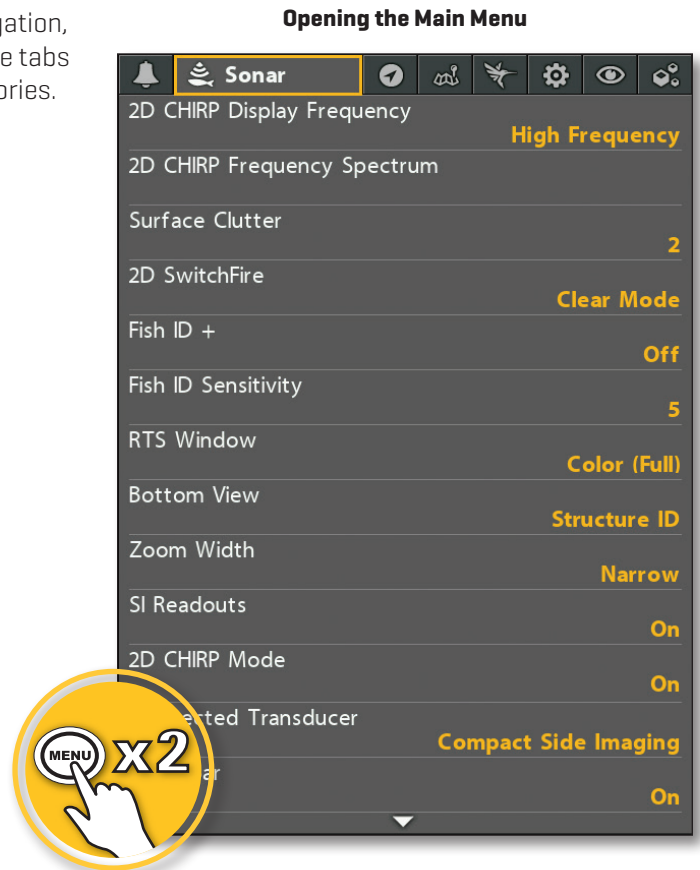


## Open the Main Menu

The main menu is divided into tabbed categories [Alarms, Sonar, Navigation, Chart, Humminbird Chart, Setup, Views, and Accessories]. The available tabs and menus are determined by your model and the connected accessories.

### Open the Main Menu

1. Press the MENU key twice.

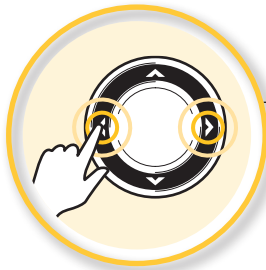


## Select a Menu

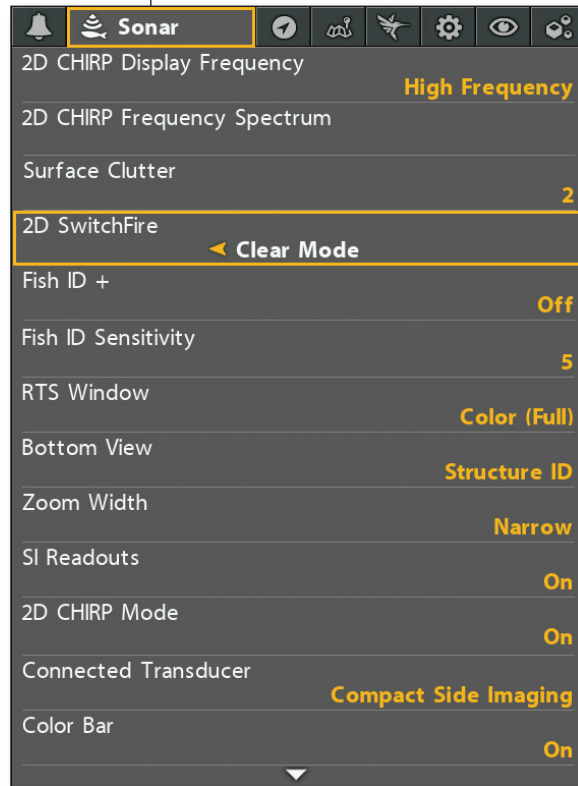
Use the Cursor Control key to select a menu in the Main Menu or X-Press Menu.

### Select a Tab (Main Menu)

1. Press the RIGHT or LEFT Cursor keys.

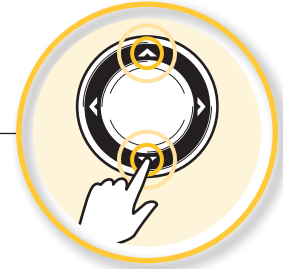


Select a Tab



### Select a Menu

1. Press the DOWN or UP Cursor keys.



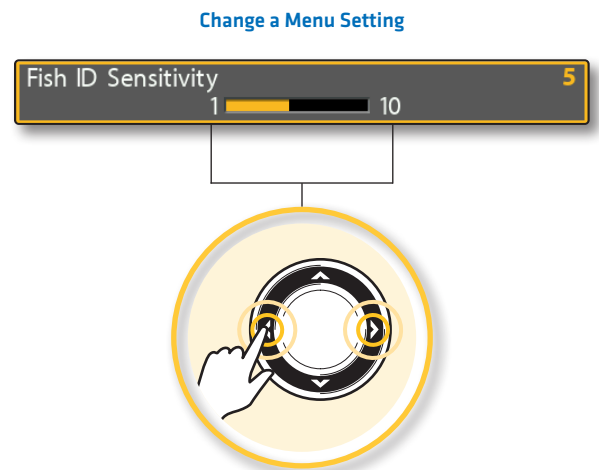
Select a Menu

## Change a Menu Setting

Use the Cursor Control key to change menu settings or start an action. When you change a menu setting, the view will update immediately.

### Adjust a Menu Setting

1. Press the RIGHT or LEFT Cursor keys.

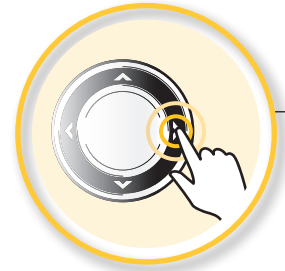


## Start an Action/Open a Submenu

1. If a menu has a right arrow on it, press the RIGHT Cursor key to start the action or open the submenu.

Start an Action or Open a Submenu

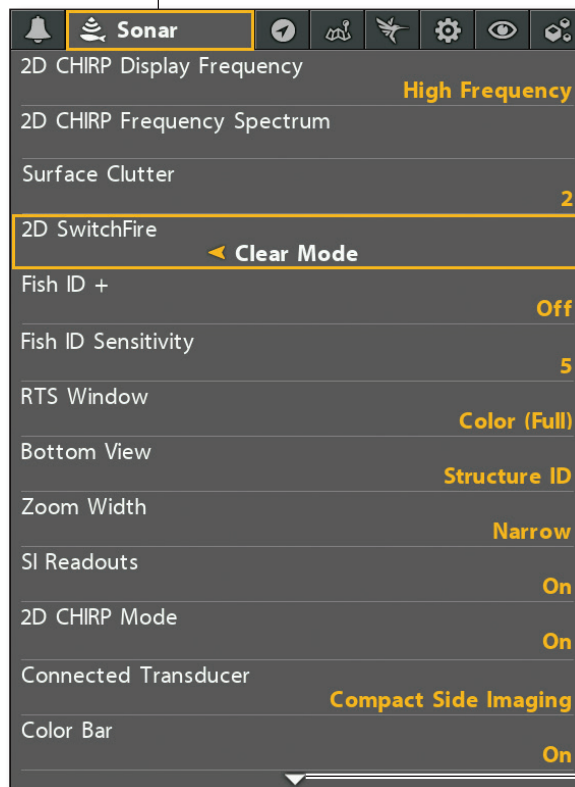
Waypoints, Routes, Tracks



## Tips for Using the Menu System

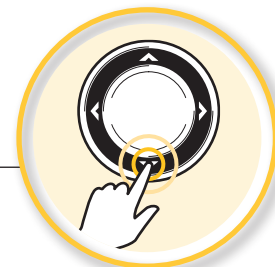
You can move through the menu system quickly using the following tips.

Jump to the Bottom of the Tab



EXIT

Jump to the Top of the Tab



See More Menus

## Change the User Mode (Angler or Custom)

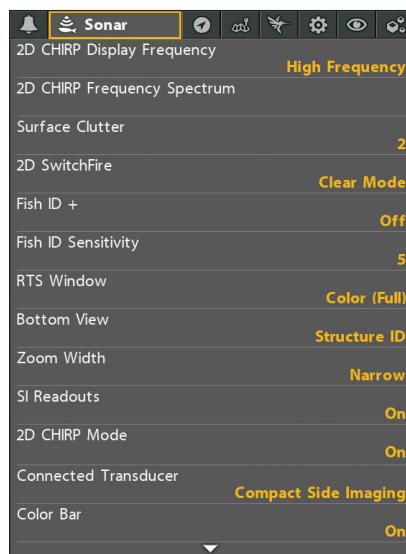
The User Mode determines how many menus are shown in the menu system. Select **Angler** to see fewer menus that are used more often. Select **Custom** to see all the menus available in the menu system.

**Main Menu [Custom User Mode]:** Instructions in this manual marked with **Main Menu [Custom User Mode]** indicate that the menu system User Mode must be set to Custom for the selected menu to be shown. If you do not see the menu in the system, change the User Mode to Custom.

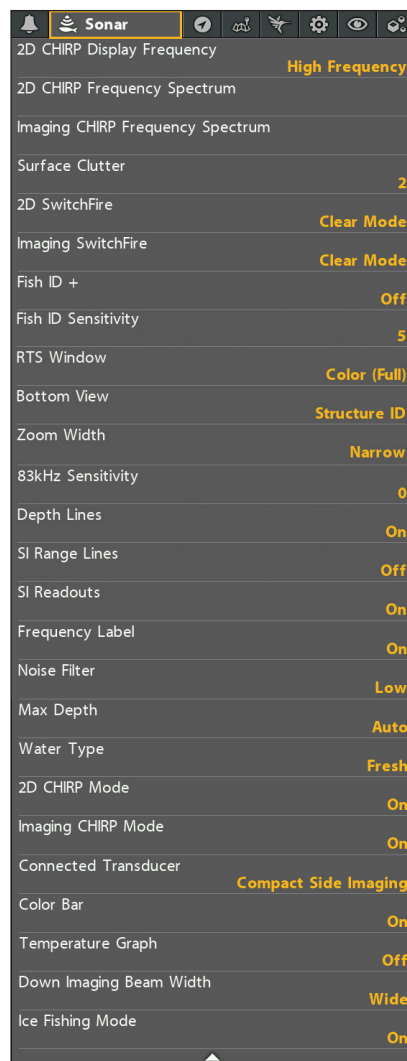
### Change the User Mode

1. **Main Menu:** Press the MENU key twice.
2. Select the **Setup** tab.
3. Select User Mode.
4. Select Angler or Custom.

**Main Menu: Sonar Tab  
(User Mode set to Angler)**



**Main Menu: Sonar Tab  
(User Mode set to Custom)**



## Close the Menu System

Use the EXIT key to go back through the menu system or close the menu system.



**Back:** Press the EXIT key to close the current menu and go back one level in the menu system.

**Close:** Press the EXIT key repeatedly until the menu system is closed.

# VIEWS

The HELIX control head has many options to display data on-screen, and the data can be displayed in a variety of ways. There are also several ways to quickly display a view on-screen. To see the list of views available on your control head, see **Show your Favorite Views**.

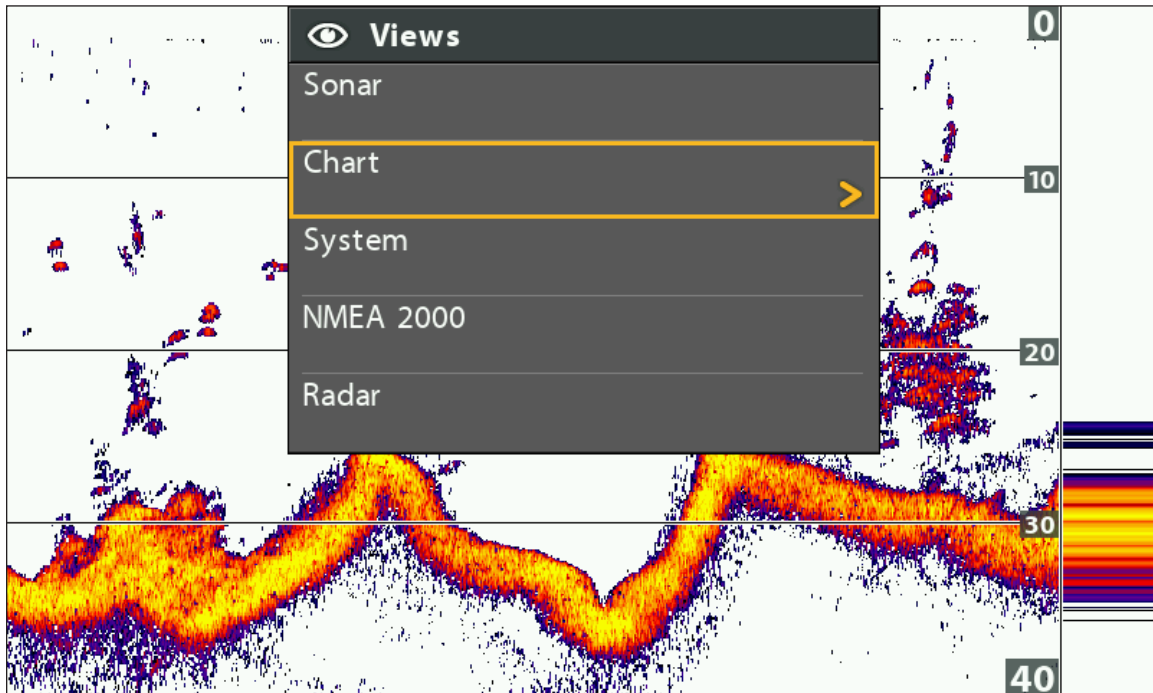
## Display a View

The available views are determined by the control head model, installed transducer, and connected accessories.

### Display a View from the Views X-Press Menu

1. Press and hold the VIEW key.
2. Select a view category. Press the RIGHT Cursor key.
3. Select a view. Press the RIGHT Cursor key.

Selecting a View to Display on the Screen



OR



OR



Press and Hold to Open  
the Views X-Press Menu

Forward: Press to go  
to the Next View

Back: Press to go to  
the Previous View

Press to Display  
a Saved View

## Display the Next/Previous View

**Next View:** Press the VIEW key repeatedly until the view you want is displayed on-screen.

**Previous View:** Press the EXIT key repeatedly until the view you want is displayed on-screen.

## Display a Saved View

1. Press a VIEW SHORTCUT key.

You can save one view on each VIEW SHORTCUT key. See **Save a View to a VIEW SHORTCUT key** for more information.

## Show your Favorite Views

You can display or hide any view so that each time you press the VIEW key, only your favorite views are displayed on the screen. You can also use the Views tab to see the list of views available on your control head. The available views are determined by your control head model, installed transducer, and connected accessories.

## Show/Hide a View

1. **Main Menu:** Press the MENU key twice.
2. Select the **Views** tab.
3. Select a view.
4. Select Hidden or Visible.

## Hide Sonar Views

If you're using your control head for GPS/Navigation functions only, use these instructions to hide all sonar views from the view rotation. This setting also deactivates sonar.

1. Press the POWER key.
2. Select Sonar.
3. Select Off.



**NOTE:** You can also turn on/off Sonar from the Main Menu > Setup tab > Sonar.

Main Menu: Views Tab

View Name	Status
Sonar View	Visible
Big Digits View	Hidden >
Down Imaging View	Visible
Side Imaging View	Visible
Down/Sonar Combo View	Visible
Side/Sonar Combo View	Visible
Sonar Zoom View	Visible
Split Sonar View	Visible
Down/Side Combo View	Visible
Side/Side Combo View	Visible
Down/Side/Sonar Combo View	Visible
Chart View	Visible

## Save a View to a VIEW SHORTCUT key (HELIX 8, 9, 10, 12 only)

Another way to display your favorite views quickly is to save them on the VIEW SHORTCUT keys. You can program the VIEW SHORTCUT keys to display a saved view immediately. **You can save one view on each key.**



With the view you want to save displayed on-screen, press and hold one of the VIEW SHORTCUT keys for several seconds.

## Display Digital Readouts

Digital Readout data can be displayed as an overlay, or it can be displayed in data boxes on the views. You can also choose which digital readouts you want to display. The format and readouts you choose will be applied to all views.

**Accessories:** The available digital readouts are determined by the installed equipment, so if you connect accessories, additional readouts will be available.

**Format:** You can change the digital readout format from the Setup Tab. See *Manage your Control Head: Change Digital Readout Formats* for details.

### Select the Digital Readout Type

Use the instructions in this section to display digital readouts in boxes or as overlays. You can also choose to hide the digital readouts completely.

1. **Main Menu:** Press the MENU key twice. Select the **Setup** tab.
2. Select Digital Readouts.
3. Select one of the following options:

<b>Boxes</b>	Digital Readouts are displayed in boxes on the view. See the illustration <i>Digital Readouts with Boxes Selected</i> . You can customize which digital readouts are displayed [see <i>Customize Digital Readouts</i> ].
<b>Overlay</b>	The digital readouts are displayed as an overlay on the view. See the illustrations <i>Digital Readouts with Overlay Selected</i> . These digital readouts are fixed and cannot be changed.
<b>Off</b>	The digital readouts will be hidden completely. To hide individual digital readouts instead of all, see <i>Customize Digital Readouts</i> .

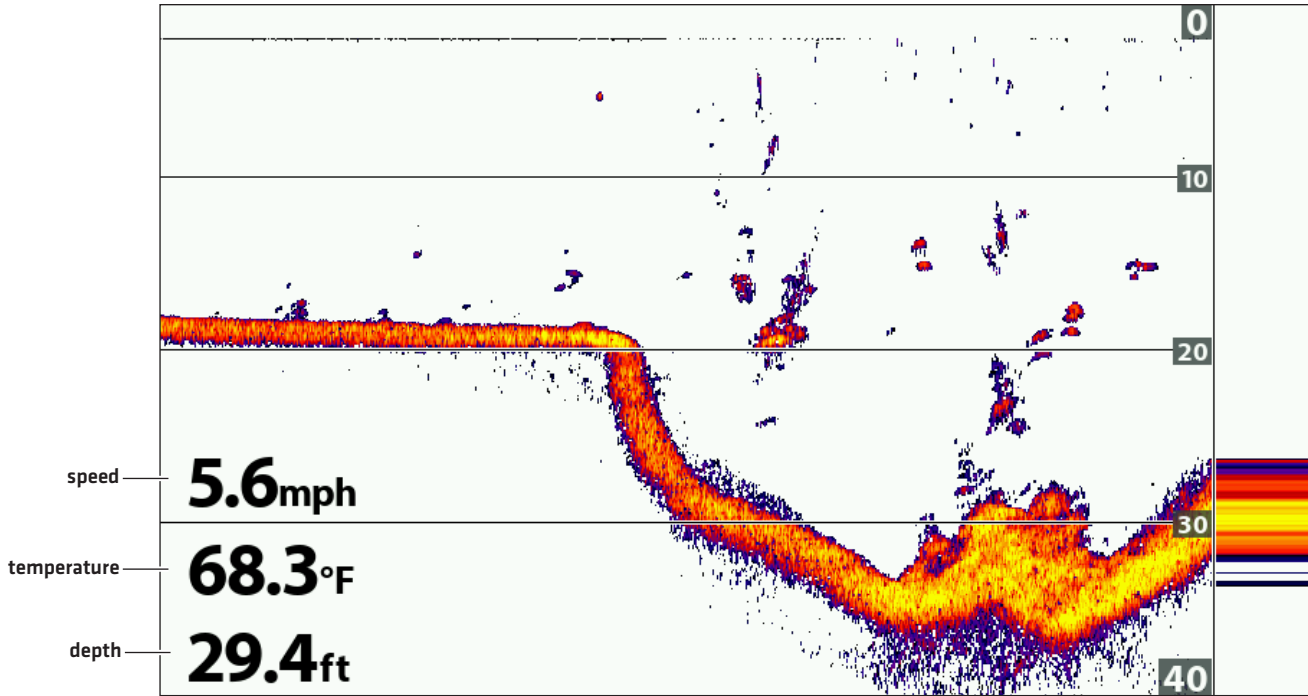
### Show/Hide Digital Readouts on the Side Imaging View (Side Imaging models only)

If you have Digital Readouts set to Boxes on all views, you can hide the digital readout boxes on the Side Imaging View exclusively.

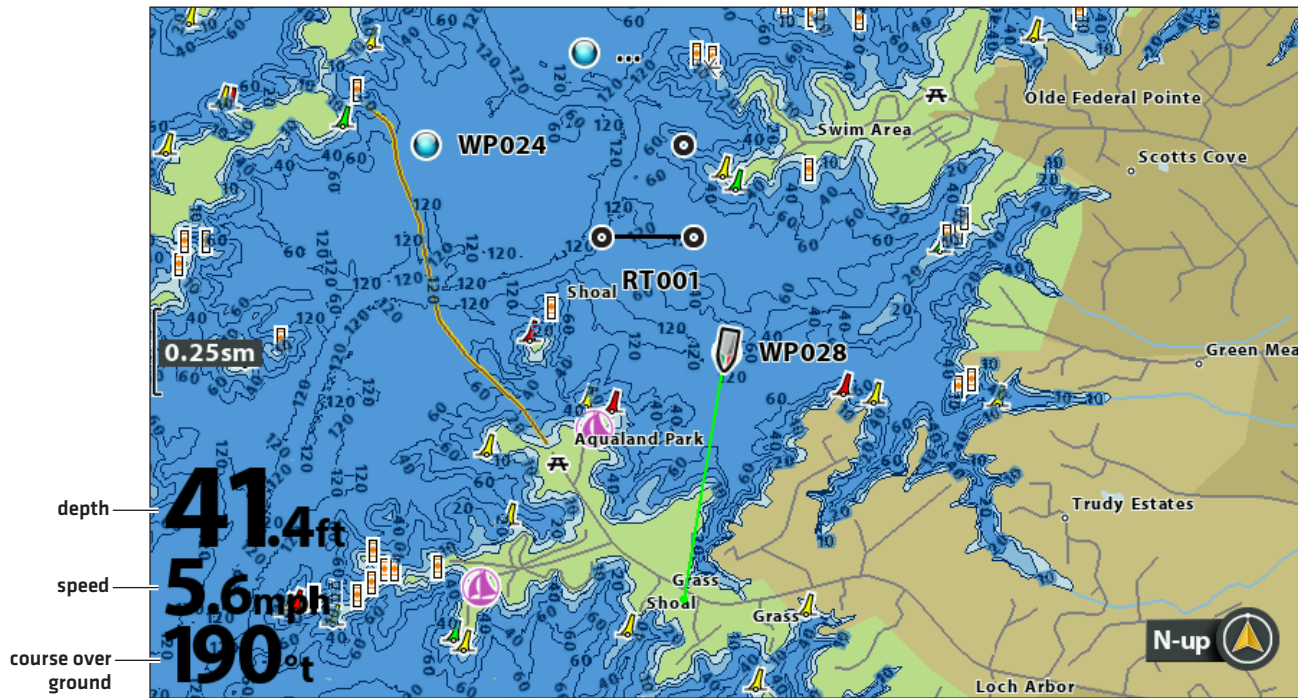
1. **Main Menu:** Press the MENU key twice. Select the **Sonar** tab.
2. Select SI Readouts.
3. Select On [show] or Off [hide].



Digital Readouts with Overlay Selected (Sonar View)



Digital Readouts with Overlay Selected (Chart View [Map Source: Humminbird Basemap])



## Customize Digital Readouts

If you have Digital Readouts set to Boxes, you can select the data that will be displayed in each box. Use the **Select Readouts** or **Edit Data Boxes** menu to set your standard digital readouts. Use the **Select Nav Readouts** or **Edit Navigation Data Boxes** menu to set the digital readouts that will be displayed during navigation.

### HELIX G3/G3N and older

1. **Main Menu [Custom User Mode]:** Press the MENU key twice. Select the **Setup** tab.
2. Select **Select Readouts** or **Select Nav Readouts**. Press the RIGHT Cursor key.
3. Select a readout window [Readout 1, 2, 3, etc.].
4. Select a digital readout.

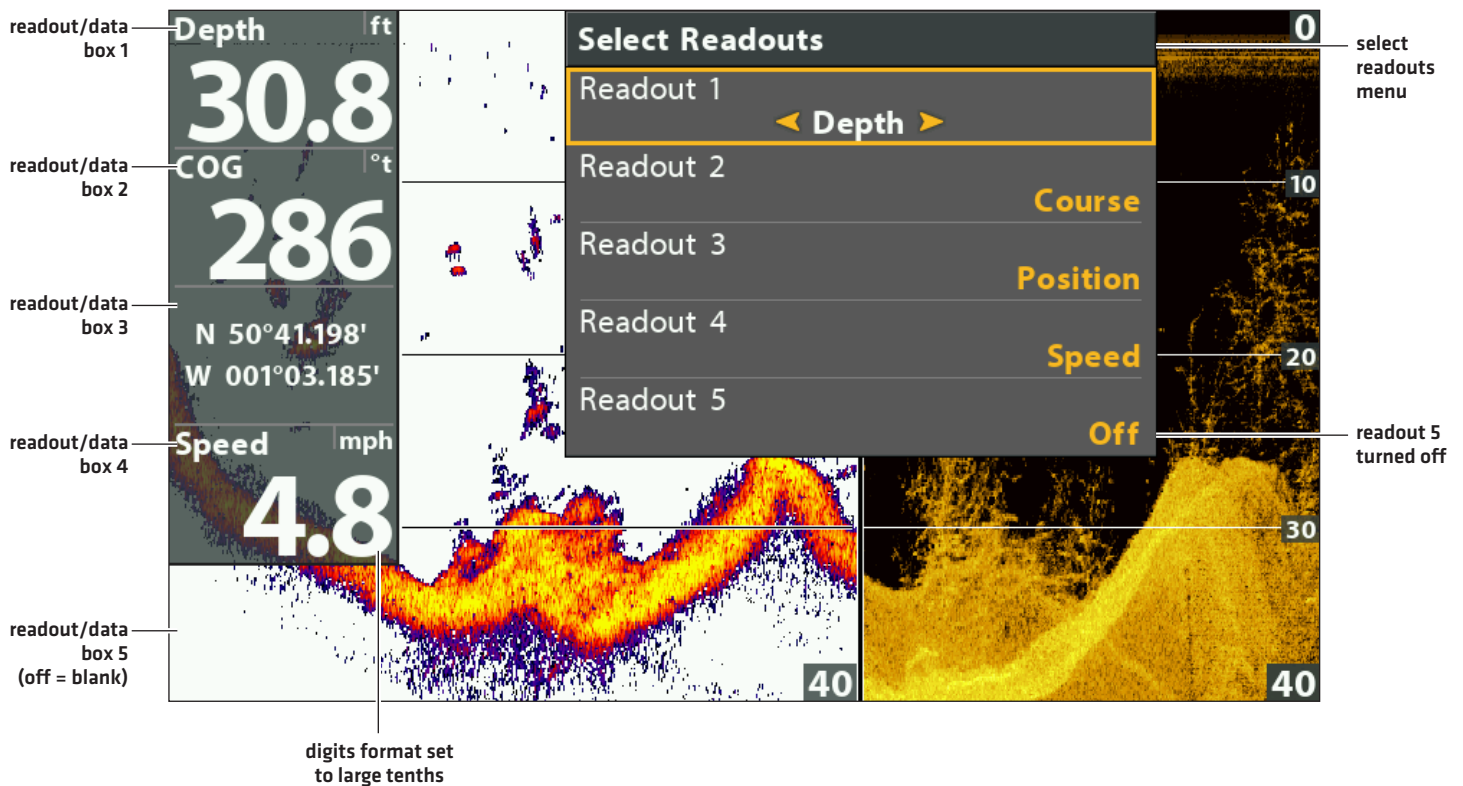
**Hide:** To hide a readout window, select Off.

### HELIX G4N

1. **Main Menu [Custom User Mode]:** Press the MENU key twice. Select the **Setup** tab.
2. Select **Edit Data Boxes** or **Edit Navigation Data Boxes**. Press the RIGHT Cursor key.
3. Select a Data Box [Data Box 1, 2, 3, etc.].
4. Select a digital readout.

**Hide:** To hide a data box, select Hide Data Box.

### Digital Readouts with Boxes Selected (Down/Sonar Combo View)



## Understand Digital Readouts

The following table displays the digital readouts that are available in the Select Readouts menu or the Select Nav Readouts menu. The available digital readouts are determined by the installed equipment.

Label	Name	Description	Navigation Readout
Bearing	Bearing	The direction to a destination waypoint measured in degrees from north.	✓
COG	Course Over Ground [Course]	The direction the boat is traveling measured in degrees from North. When the COG is equal to Bearing, the boat is said to be on course and will arrive at the destination in the most efficient manner.	✓
Depth	Depth	The depth of the water from the transducer or digital depth sensor to the bottom. This measurement includes the depth offset setting.  If the depth number is flashing, it means the unit is having trouble locating the bottom. This usually happens if the water is too deep, the transducer is out of the water, the boat is moving too fast, etc.	
DTG	Distance to Go [Distance]	The distance between the boat position and the next waypoint on the route.	✓
ETA	Estimated Time of Arrival	The estimated time of arrival to the next waypoint on the route.	✓
Position [#]	GPS	The latitude and longitude coordinates of the boat position based on the GPS receiver installation location.	✓
Speed	Speed	Speed is the measurement of the boat's progress across a given distance based on the speed measurement provided by the GPS.	✓
Temp [#]	Temperature	The detected water temperature by the transducer's internal temperature probe or an accessory temperature sensor.	
Time	Time	The current time.	
Time + Date	Time + Date	The current time and date.	
Timer	Timer	The digital readout for the timer set in the Alarms tab (see <b>Manage your Control Head: Start the Timer</b> ).	
Triplog	Triplog	The elapsed time since the triplog was last reset, the distance traveled since last reset, and the average speed during timed interval. To reset the triplog, see <b>Getting Started: Reset the Triplog</b> .	✓
TTG	Time to Go	The estimated time required to reach the next waypoint on the route. TTG is calculated using the SOG [Speed Over Ground] and DTG [Distance to Go].	✓
VLТ	Voltage	Power supplied to the control head.	
XTE	Cross Track Error	The straight-line distance of the boat from the intended route. XTE measures how far the boat is off course.	✓



# SET UP SONAR

The available sonar views and menus on the control head are determined by the connected transducer and the selected transducer source.

Most of the settings in this section were set up when you first powered on the unit using the Quick Setup Menu. Use the instructions in this section to adjust those settings, set up an accessory transducer, or refine the information shown on-screen.

## Set up an Accessory Transducer (Optional)

The control head will automatically select the transducer that was included with your control head. If your model is compatible with an accessory transducer, and it is connected to the control head, select the transducer in the system so the beams are activated and the related views are added to the control head. See **Getting Started: Quick Setup** for more information.



**NOTE:** For more information about accessory transducers, download the [Transducer Compatibility Guide](#)

1. **Main Menu:** Press the MENU key twice. Select the **Sonar** tab.
2. Select Connected Transducer.
3. Select the transducer connected to the unit.

To **reselect your control head's default transducer**, press and hold the LEFT Cursor key to select the first transducer listed.

To adjust the depth offset, see [Manage your Control Head](#).

## Adjust the Noise Filter (Optional)

If interference appears on the sonar views from sources such as your boat engine, turbulence, or other sonar devices, use Noise Filter to limit the interference.

1. **Main Menu [Custom User Mode]:** Press the MENU key twice. Select the **Sonar** tab.
2. Select Noise Filter.
3. Select a filter setting, where 1 is the lightest filter and 4 filters the most interference.

**Off:** removes all filtering.

Higher settings are useful when there is excessive trolling motor noise. However, in some deep water situations, higher settings may hinder the control head's ability to find the bottom.

## Change the Max Depth (Optional)

The Max Depth was set when you first configured the unit with the Quick Setup dialog box [see **Getting Started: Quick Setup**]. Use the instructions in this section to adjust the maximum depth setting.

1. **Main Menu [Custom User Mode]:** Press the MENU key twice. Select the **Sonar** tab.
2. Select Max Depth.
3. Select one of the following:

**Auto:** the control head will acquire bottom readings as needed [within the capabilities of the unit].

**Set to match the body of water depth:** the control head will not attempt to acquire sonar data below that depth, so more detail will be shown on the display.



**NOTE:** Side Imaging units default to the Side Imaging range setting if the SI Range is set deeper than the Max Depth. See the **Side Imaging** section for more information.

## Select the Digital Depth Source

Depending on the depth, the control head will automatically choose the 2D conical beams or the Down Imaging beams to display the depth digital readout. If the depth is deeper than 350 ft, or if you connect an ice transducer to the control head, set the Digital Depth Source to 2D Element.



**NOTE:** Selecting the Digital Depth Source is available on the following models: DI, CHIRP DI, CHIRP MEGA DI, CHIRP MEGA DI+, CHIRP MEGA SI, and CHIRP MEGA SI+.

1. **Main Menu [Custom User Mode]:** Press the MENU key twice. Select the **Sonar** tab.
2. Select Digital Depth Source.
3. Select Auto or 2D Element.

**Auto:** The control head will acquire the digital depth as needed.

**2D Element:** Select 2D Element if the depth is deeper than 350 feet. Down Imaging is not available with this setting.

## Turn on Max DI (CHIRP MEGA SI models only)

Max DI [On] is typically used for deep water to provide the maximum strength for the Down Imaging signal. Max DI [Off] typically provides the best resolution in shallow water.

1. **Main Menu [Custom User Mode]:** Press the MENU key twice. Select the **Sonar** tab.
2. Select Max DI.
3. Select On or Off.

## Change DI Frequency Presets (CHIRP MEGA DI+ and CHIRP MEGA SI+ models only)

Increased Range is typically used for deep water to provide the maximum strength for the Down Imaging signal. Increased Detail typically provides the best resolution in shallow water.

1. **Main Menu [Custom User Mode]:** Press the MENU key twice. Select the **Sonar** tab.
2. Select DI Frequency.
3. Select Increased Detail [default] or Increased Range.

## Change the Water Type

The Water Type was set when you first configured the unit with the Quick Setup dialog box [see **Getting Started: Quick Setup**]. Water Type affects the accuracy of deep water depth readings and configures the control head for operation in fresh or salt water. Use the instructions in this section to change the Water Type setting.

1. **Main Menu [Custom User Mode]:** Press the MENU key twice. Select the **Sonar** tab.
2. Select Water Type.
3. Select one of the following for your water type and depth conditions:

**Fresh**

**Salt [shallow]**

**Salt [deep]:** If the depth is more than 330 ft [100 m], select Salt [deep].

## Change the Side Imaging Orientation (CHIRP MEGA SI, CHIRP MEGA SI+ models only)

Use SI Orientation to switch how the Side Imaging beams are displayed in the Side Imaging View. This menu option can be used if the port and starboard beams are reversed during installation, which might be the case if a transducer is installed incorrectly. For further assistance, contact Humminbird Technical Support.

1. **Main Menu [Custom User Mode]:** Press the MENU key twice. Select the **Sonar** tab.
2. Select SI Orientation
3. Select Normal or Reverse.

## Set up Ice Fishing (ICE HELIX CHIRP, HELIX 5 and 7 G2/G2N, HELIX 7 G3 and HELIX 7, 8, 9 and 10 G3N models only)

If you have a compatible CHIRP model and want to use it for ice fishing, Ice Fishing mode must be turned on. See *Ice Fishing Overview: Turn on Ice Fishing Mode* for more information.

## Turn off Sonar

If you're using your control head for GPS/Navigation functions only, use these instructions to hide all sonar views from the view rotation. When it is set to Off, this setting also stops the unit from pinging, so all sonar operation is deactivated.

1. Press the POWER key.
2. Select Sonar.
3. Select Off.



**NOTE:** You can also turn on/off Sonar from the Main Menu > Setup tab > Sonar.

## Turn on/off CHIRP (optional, CHIRP models only)

To use CHIRP sonar, CHIRP mode must be turned on. The menu options are determined by the installed transducer and control head model.



**NOTE:** Humminbird has provided the best settings for your unit. You can use the settings included with your control head, or you can adjust these advanced options.

## Turn on/off 2D CHIRP

1. **Main Menu [Custom User Mode]:** Press the MENU key twice. Select the **Setup** tab.
2. Select CHIRP Configuration. Press the RIGHT Cursor key.  
If the menu is not shown in the Setup tab, select the **Sonar** tab.
3. Select 2D CHIRP Mode.
4. Select On or Off. [Default = On]

## Turn on/off Down Imaging CHIRP


1. **Main Menu [Custom User Mode]:** Press the MENU key twice. Select the **Setup** tab.
2. Select CHIRP Configuration.
3. Select DI CHIRP Mode or Imaging CHIRP Mode. Press the RIGHT Cursor key.
4. Select On or Off. [Default = On]

## Turn on/off Side Imaging CHIRP

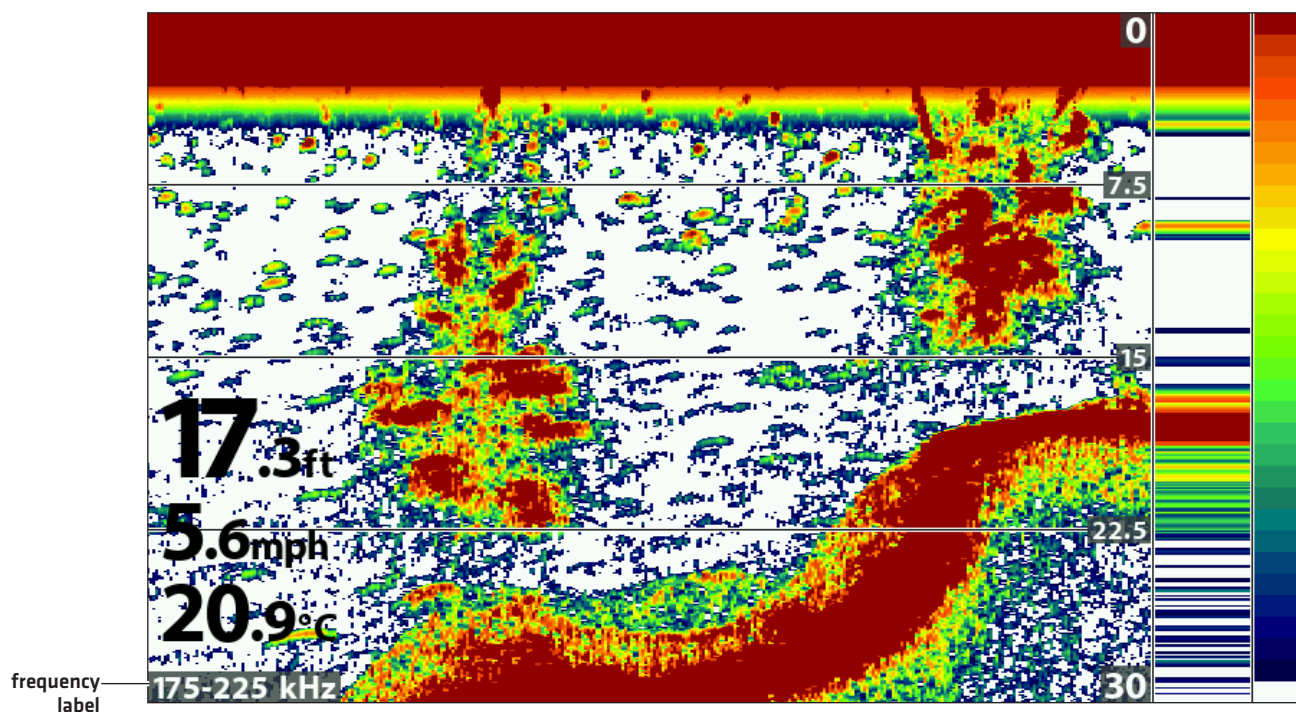
1. **Main Menu [Custom User Mode]:** Press the MENU key twice. Select the **Setup** tab.
2. Select CHIRP Configuration. Press the RIGHT Cursor key.
3. Select SI CHIRP Mode or Imaging CHIRP Mode.
4. Select On or Off. [Default = On]

## Select Frequencies for the 2D Sonar View (optional)

Use the instructions in this section to select the frequencies that will be used for the 2D Sonar views. The menu options are determined by the installed transducer and control head model.

 **NOTE:** You can also change the frequency in the 2D Sonar View while you fish by pressing the CHECK key [see the **2D Sonar View** section: **Adjust Settings While you Fish**].

### Display Frequency for the 2D Sonar View (HELIX 7 CHIRP GPS G2)



## Select Frequencies for the (2D) Sonar View

1. **Main Menu:** Press the MENU key twice. Select the **Sonar** tab.
2. Select 2D Display Frequency.

**Dual Beam CHIRP Models:** Select 2D CHIRP Display Frequency.

**Dual Spectrum CHIRP Models:** Select Display Spectrum.


3. Select a frequency.

For details, see the tables in *Understand Transducer Frequencies* and refer to your transducer model.

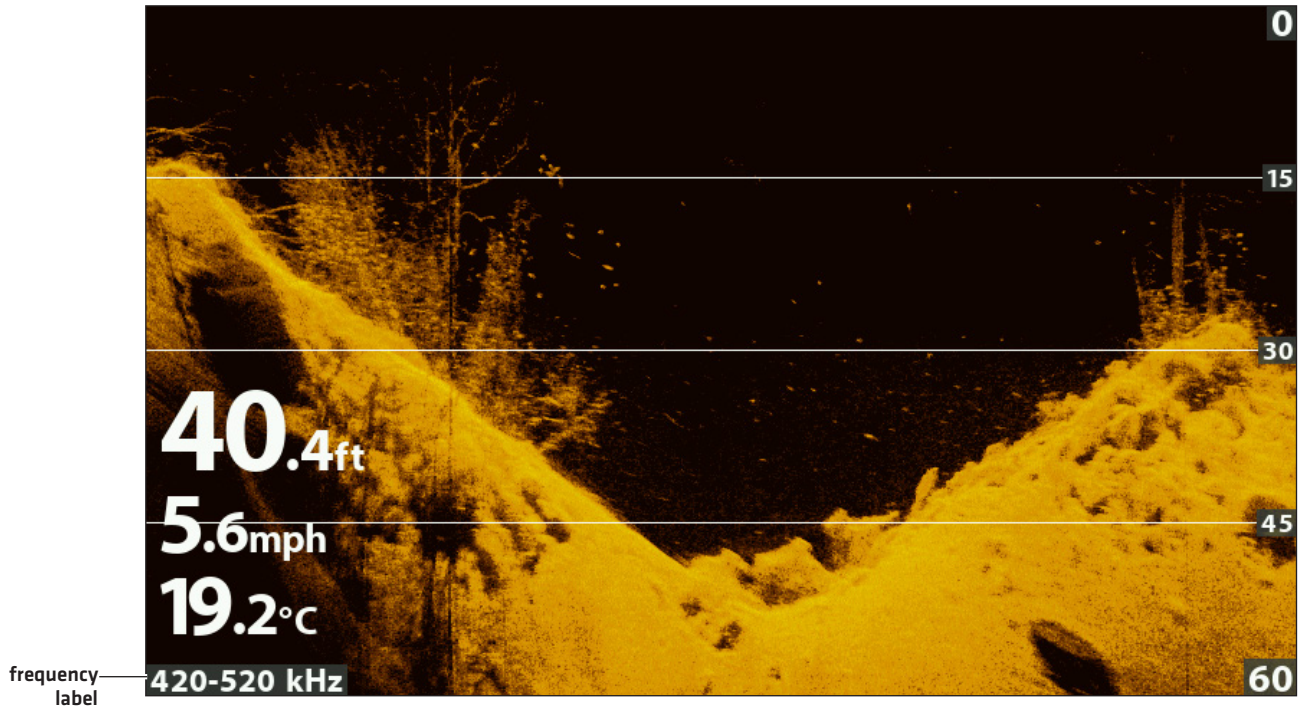


## Select a Frequency for the Down Imaging View (optional)

Use the instructions in this section to choose a frequency that will be used for the Down Imaging View. The menu options are determined by the installed transducer and control head model.

 **NOTE:** You can also change the frequency in the Down Imaging View while you fish by pressing the CHECK key [see the **Down Imaging** section: **Adjust Settings While you Fish**].

### Display Frequency for the Down Imaging View (HELIX 9 CHIRP DI GPS G2N)



## Select a Frequency for the Down Imaging View

1. **Main Menu:** Press the MENU key twice. Select the **Sonar** tab.
2. **DI Models:** Select Imaging Display Frequency.  
**CHIRP DI, CHIRP MEGA, CHIRP MEGA+ Models:** Select DI CHIRP Display Frequency.
3. Select a frequency.

For details, see the tables in **Understand Transducer Frequencies** and refer to your transducer model.

## Set the Down Imaging Beam Width (optional, XNT 9 SI 180 T only)

If the XNT 9 SI 180 T [Compact Side Imaging transducer] is installed, you can set the width of the beam [side to side] used for the Down Imaging View. To see only the data directly under your boat, select Narrow. Medium reveals more information, while Wide displays the maximum information available from the Down Imaging beam width. See *Understand the Down Imaging View* for more information.

1. **Main Menu [Custom User Mode]:** Press the MENU key twice. Select the **Sonar** tab.
2. Select Down Imaging Beam Width.
3. Press the RIGHT or LEFT Cursor keys to select a width.

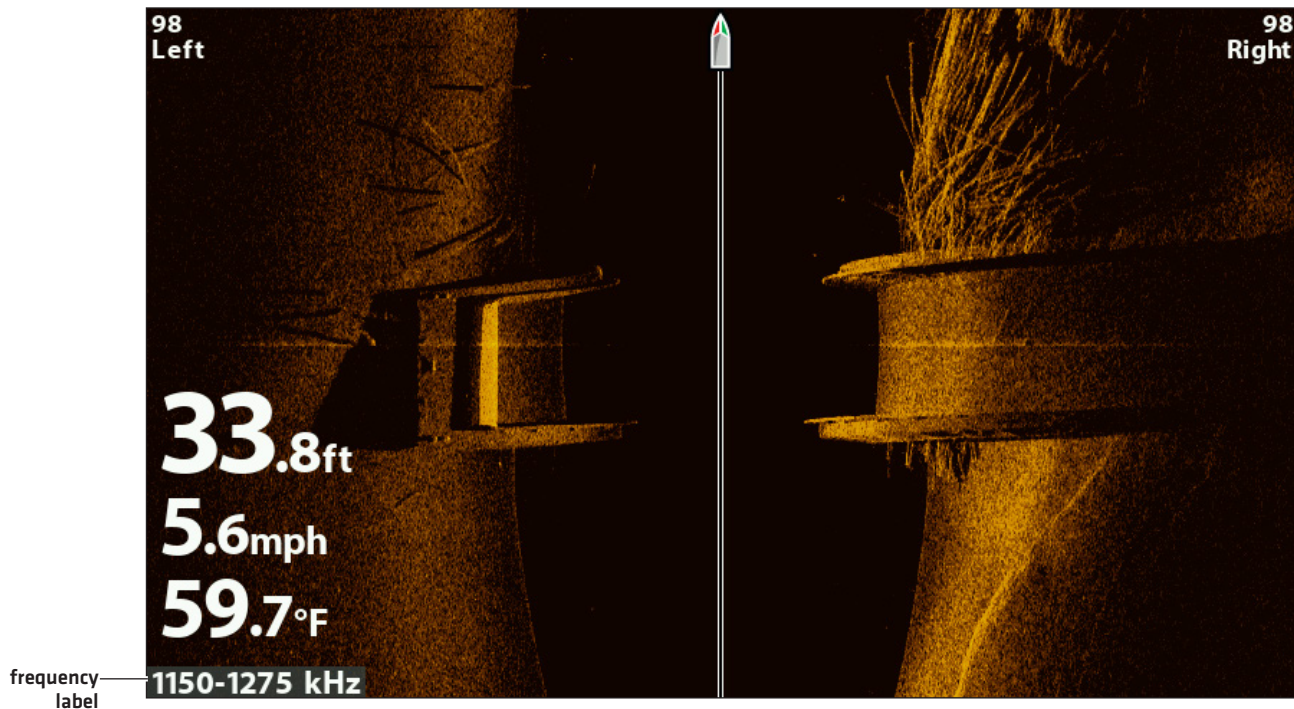
## Select a Frequency for the Side Imaging View (optional, CHIRP MEGA SI, CHIRP MEGA SI+ models only)

Use the instructions in this section to choose a frequency that will be used for the Side Imaging View.



**NOTE:** You can also change the frequency in the Side Imaging View while you fish by pressing the CHECK key [see the *Side Imaging* section: **Adjust Settings While you Fish**].

### Display Frequency for the Side Imaging View [CHIRP MEGA SI] [HELIX 9 CHIRP SI GPS G2N]

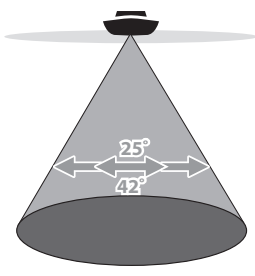
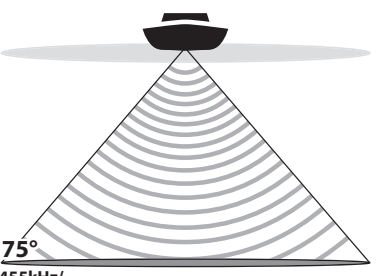
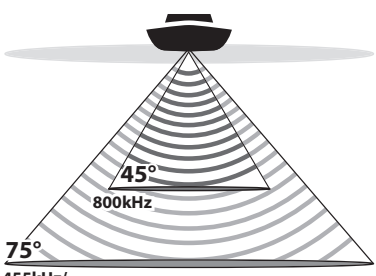


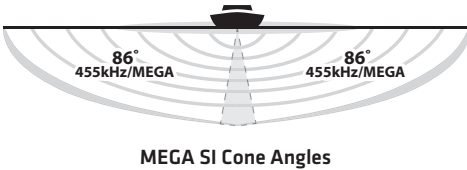
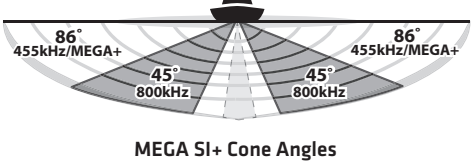
## Select a Frequency for the Side Imaging View

1. **Main Menu:** Press the MENU key twice. Select the **Sonar** tab.
2. Select SI CHIRP Display Frequency.
3. Select a frequency.

For details, see the tables in *Understand Transducer Frequencies* and refer to your transducer model.

## Understand Transducer Frequencies

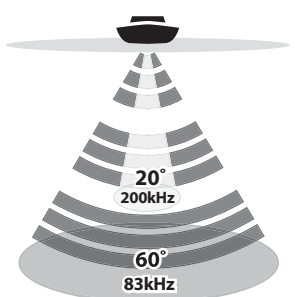
High Wide Transducers				
<b>2D Models</b> XNT 9 HW T XNT 9 HW XP 9 HW T XP 9 HW XTM 9 HW T XPTH 9 HW T XPT 9 HW T	<b>MEGA DI Models</b> XNT 9 MDI T XNT 9 HW MDI 75 T XNM 9 HW MDI 75 T	<b>MEGA DI+ Models</b> XM 9 HW MDI T XTM 9 HW MDI T	<b>MEGA SI Models</b> XNT 9 HW MSI 150 T XTM 9 HW MSI 150 T	<b>MEGA SI+ Models</b> XM 9 HW MSI T XT M 9 HW MSI T XPTH 9 HW MSI T
2D Display				
 <p>Dual Spectrum Cone Angles</p>	<b>Full</b>	Select Full Beam [default] to use the complete frequency range.		
	<b>Narrow</b>	Select Narrow Beam for increased bottom detail and better target separation.		
	<b>Wide</b>	Select Wide Beam to maximize coverage and show big, clearly defined fish arches.		
DI Display				
 <p>MEGA DI Cone Angles</p>	<b>MEGA</b>	Select MEGA for the highest resolution, sharpness, and depth [up to 125 ft].  *For MEGA SI models, the range is up to 75 ft.		
	<b>455 kHz</b>	Select 455 kHz for deep water and overall coverage [up to 350 ft].		
DI+ Display				
 <p>MEGA DI+ Cone Angles</p>	<b>MEGA+</b>	Select MEGA+ for the highest resolution, sharpness, and depth [up to 200 ft].		
	<b>800 kHz</b>	Select 800 kHz as an alternative frequency with sharp returns [up to 125 ft].		
	<b>455 kHz</b>	Select 455 kHz for deep water and overall coverage [up to 400 ft].		

SI Display		
 <p>MEGA SI Cone Angles</p>	MEGA	Select MEGA for the highest resolution, sharpness, and range (up to 250 ft side to side).
	455 kHz	Select 455 kHz for deep water and overall coverage (up to 800 ft side to side).
SI+ Display		
 <p>MEGA SI+ Cone Angles</p>	MEGA+	Select MEGA for the highest resolution, sharpness, and range (up to 400 ft side to side).
	800 kHz	Select 800 kHz as an alternative frequency with sharp returns (up to 250 ft side to side).
	455 kHz	Select 455 kHz for deep water and overall coverage (up to 800 ft side to side).

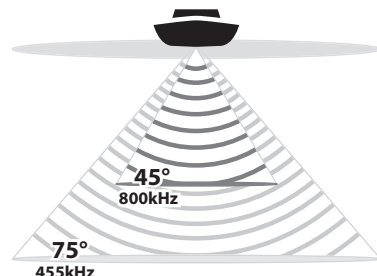
## 83/200 kHz Transducers

<b>2D Models</b>	<b>DI Models</b>	<b>SI Models</b>
XNT 9 20 T XNT 9 20 XP 9 20 T XP 9 20 XTM 9 20 T XPTH 9 20 T XPT 9 20 T XAP 9 20	XTM 9 WIDE DI 20 T	XNT 9 SI 180 T XTM 9 SI 180 T XHS 9 HDSI 180 T XTM 9 HDSI 180 T XPTH 9 HDSI 180 T XM 9 20 MSI T XTM 9 20 MSI T XPTH 9 20 MSI T

### 2D Display

 <p style="text-align: center; margin-top: 5px;"><b>DualBeam Cone Angles</b></p>	<b>Medium (83 kHz) Frequency</b>	Select Medium Frequency for deep water [more than 800 feet]. Medium Frequency can be used for deep returns at high speed. If Medium Frequency is selected, the high frequency beam pings in the background but is not displayed.
	<b>High (200 kHz) Frequency</b>	Select High Frequency for more detail at shallower depths [less than 800 feet]. If High Frequency is selected, the medium frequency beam is not available.
	<b>Medium/ High (83/200 kHz) Frequency</b>	Select Medium/High Frequency to ensure both beams ping continuously, so the sonar history is not interrupted if the Sonar View is closed.  The returns from both beams are blended by starting with the wide beam return, dimming it, and then overlaying it with the narrow beam return. The narrow beam sonar returns will stand out from the wide beam sonar returns.

### DI Display

 <p style="text-align: center; margin-top: 5px;"><b>DI Cone Angles</b></p>	<b>455 kHz (CHIRP)</b>	Select 455 kHz CHIRP for greater bottom coverage in deep water [up to 350 feet].
	<b>800 kHz (CHIRP)</b>	Select 800 kHz CHIRP for shallow water and the sharpest image.

SI Display		
<p>SI Cone Angles</p>	<b>MEGA [CHIRP]</b>	Select MEGA CHIRP for the highest resolution, sharpness, and range (up to 250 ft side to side).
	<b>800 kHz [CHIRP]</b>	Select 800 kHz CHIRP as an alternative frequency with sharp returns (up to 250 ft side to side).
	<b>455 kHz [CHIRP]</b>	Select 455 kHz CHIRP for deep water and overall coverage (up to 800 ft side to side).

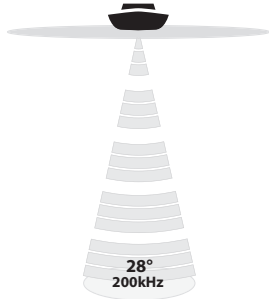
50/200 kHz Transducers		
<b>Models</b> XNT 9 DB 74 T XTH 9 DB 74 P		
2D Display		
<p>50/200 kHz Cone Angle</p>	<b>50 kHz [Low]</b>	Select 50 kHz for deep water (more than 1500 feet). 50 kHz can be used for deep returns at high speed. If 50 kHz is selected, the 200 kHz beam pings in the background but is not displayed.
	<b>200 kHz [High]</b>	Select 200 kHz for faster pinging and shallower water (less than 800 feet).

## 200/455 kHz Transducers

### Models

XNT 9 DI T  
XTM 9 SI 25 T

### 2D Display



2D Cone Angles

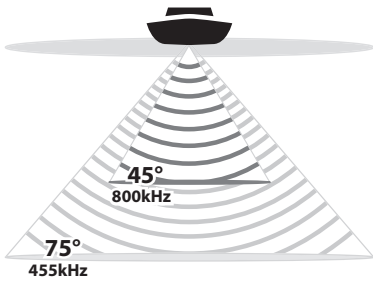
High  
[200 kHz]

Select High Frequency for greater bottom coverage in deep water [up to 600 feet].

High  
[455 kHz]

Select High [455 kHz] Frequency for shallow water [up to 350 feet].

### DI Display



DI Cone Angles

455 kHz

Select 455 kHz for greater bottom coverage in deep water [up to 350 feet].


800 kHz

Select 800 kHz for shallow water and the sharpest image.

## Adjust the CHIRP Frequency Spectrum (optional, CHIRP models only)

Your control head has been configured with the best settings for a wide range of fishing conditions, and we recommend using the default start and end CHIRP frequency spectrum included with your unit. However, you can adjust the CHIRP Frequency Spectrum to limit the interferences on the display or refine the settings to your preference. The menu options are determined by the installed transducer and control head model.

**Requirements:** CHIRP mode must be turned on. The menus are also determined by the display frequency you have selected for each view.

 **WARNING!** If an accessory transducer is installed, confirm it is configured in the control head. See **Set up an Accessory Transducer** for details.

### Adjust the 2D CHIRP Frequency Spectrum

1. **Main Menu [Custom User Mode]:** Press the MENU key twice. Select the **Setup** tab.
2. Select CHIRP Configuration. Press the RIGHT Cursor key.  
If the menu is not shown in the **Setup** tab, select the **Sonar** tab.
3. Select 2D CHIRP Frequency Spectrum. Press the RIGHT Cursor key.
4. Select a frequency menu.
5. Press the RIGHT or LEFT Cursor keys to select a setting.
6. **Repeat:** Repeat steps 4 and 5 to adjust the Start Frequency and End Frequency for each beam.
7. **Close:** Press the EXIT key.

### Adjust the Down Imaging CHIRP Frequency Spectrum

1. **Main Menu [Custom User Mode]:** Press the MENU key twice. Select the **Setup** tab.
2. Select CHIRP Configuration. Press the RIGHT Cursor key.  
If the menu is not shown in the **Setup** tab, select the **Sonar** tab.
3. Select DI CHIRP Frequency Spectrum or Imaging CHIRP Frequency Spectrum. Press the RIGHT Cursor key.
4. Select a frequency menu.
5. Press the RIGHT or LEFT Cursor keys to select a setting.
6. **Repeat:** Repeat steps 4 and 5 to adjust the Start Frequency and End Frequency for each beam.
7. **Close the Submenu:** Press the EXIT key.

### Adjust the Side Imaging CHIRP Frequency Spectrum

1. **Main Menu [Custom User Mode]:** Press the MENU key twice. Select the **Setup** tab.
2. Select CHIRP Configuration. Press the RIGHT Cursor key.  
If the menu is not shown in the **Setup** tab, select the **Sonar** tab.
3. Select SI CHIRP Frequency Spectrum. Press the RIGHT Cursor key.
4. Select a frequency menu.
5. Press the RIGHT or LEFT Cursor keys to select a setting.
6. **Repeat:** Repeat steps 4 and 5 to adjust the Start Frequency and End Frequency for each beam.
7. **Close the Submenu:** Press the EXIT key.



## Reset CHIRP Configuration Settings

Use the following instructions to reset the CHIRP menu settings to the factory defaults.

1. **Main Menu [Custom User Mode]:** Press the MENU key twice. Select the **Setup** tab.
2. Select CHIRP Configuration. Press the RIGHT Cursor key.
3. Select Local CHIRP Configuration Reset. Press the RIGHT Cursor key.

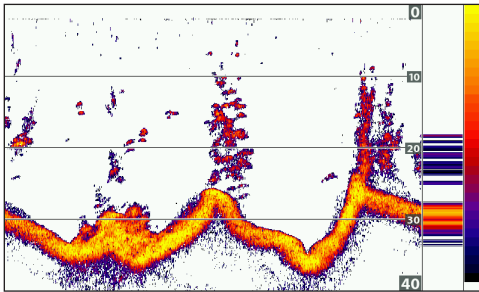
# DISPLAY A SONAR VIEW ON-SCREEN

There are a variety of views available to display sonar data. You can customize the view by showing or hiding information [see *Customize the Sonar View*], and you can adjust the sonar settings to refine the information displayed on-screen [see *Adjust Sonar Display Settings* and *Adjust Settings While you Fish*]. The changes you make are applied to all traditional 2D sonar views.

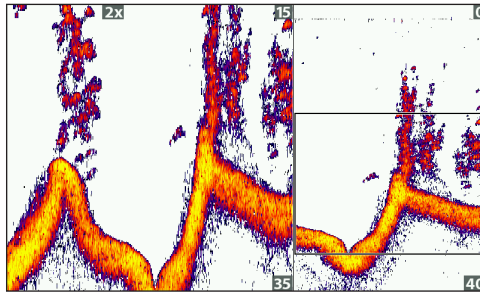
## Display a Sonar View

1. Press and hold the VIEW key.
2. Select Sonar > Sonar View, Sonar Zoom View, Split Sonar View, etc.

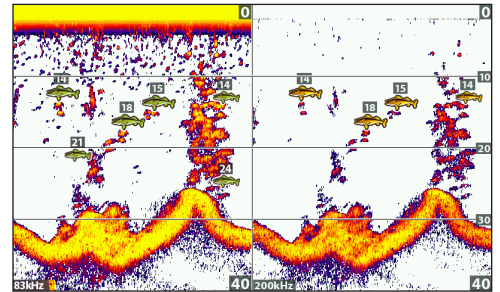
**Sonar View**



**Sonar Zoom View**



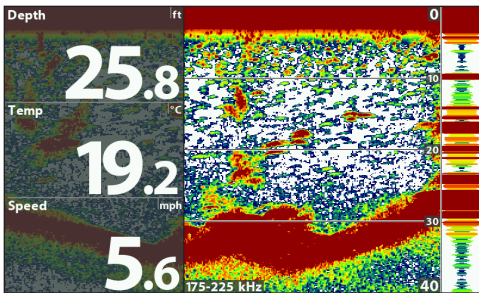
**Split Sonar View**



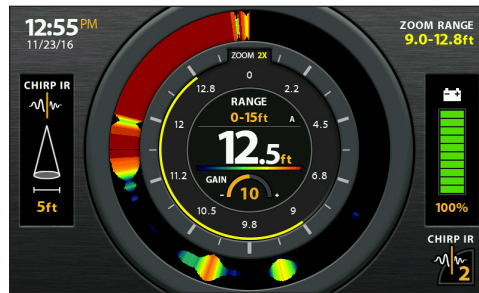
For more information, see *Review Sonar History and Zoom In/Zoom Out.*

For more information, see *Compare Sonar Beams.*

**Big Digits View**



**Flasher View (ICE HELIX CHIRP)**



For more information, see *Display the Flasher View On-Screen.*

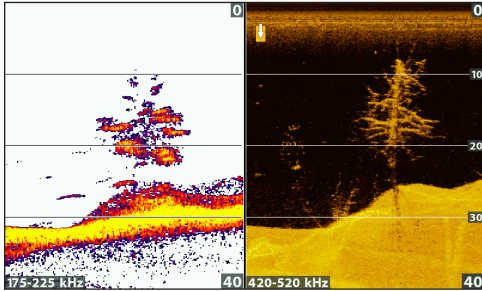


**NOTE:** The available views are determined by your control head model and the installed transducer. For a complete list of the views available on your control head, press the MENU key twice, and select the Views tab. See each related section of the manual [*Views, Down Imaging, Side Imaging, Navigation Overview, etc.*] for more information.

## Display a Sonar Combo View

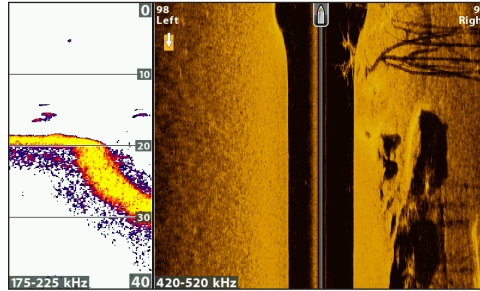
1. Press and hold the VIEW key.
2. To open a Sonar Combo View, select Sonar.  
To open a Chart Combo View [Sonar and Chart together], select Chart.
3. Select a view to display on-screen.

### Sonar > Down/Sonar Combo View



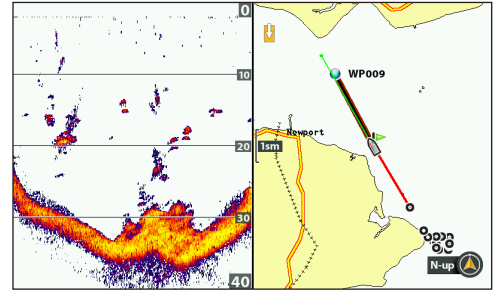
For more information, see the *Down Imaging* section.

### Sonar > Side/Sonar Combo View



For more information, see the *Side Imaging* section.

### Chart > Chart/Sonar Combo View (Map Source: Contour XD)



For more information, see *Navigation Overview*.



**NOTE:** The available views are determined by your control head model and the installed transducer. For a complete list of the views available on your control head, press the MENU key twice, and select the Views tab. See each related section of the manual [*Views*, *Down Imaging*, *Side Imaging*, *Navigation Overview*, etc.] for more information.

# UNDERSTAND THE SONAR VIEWS

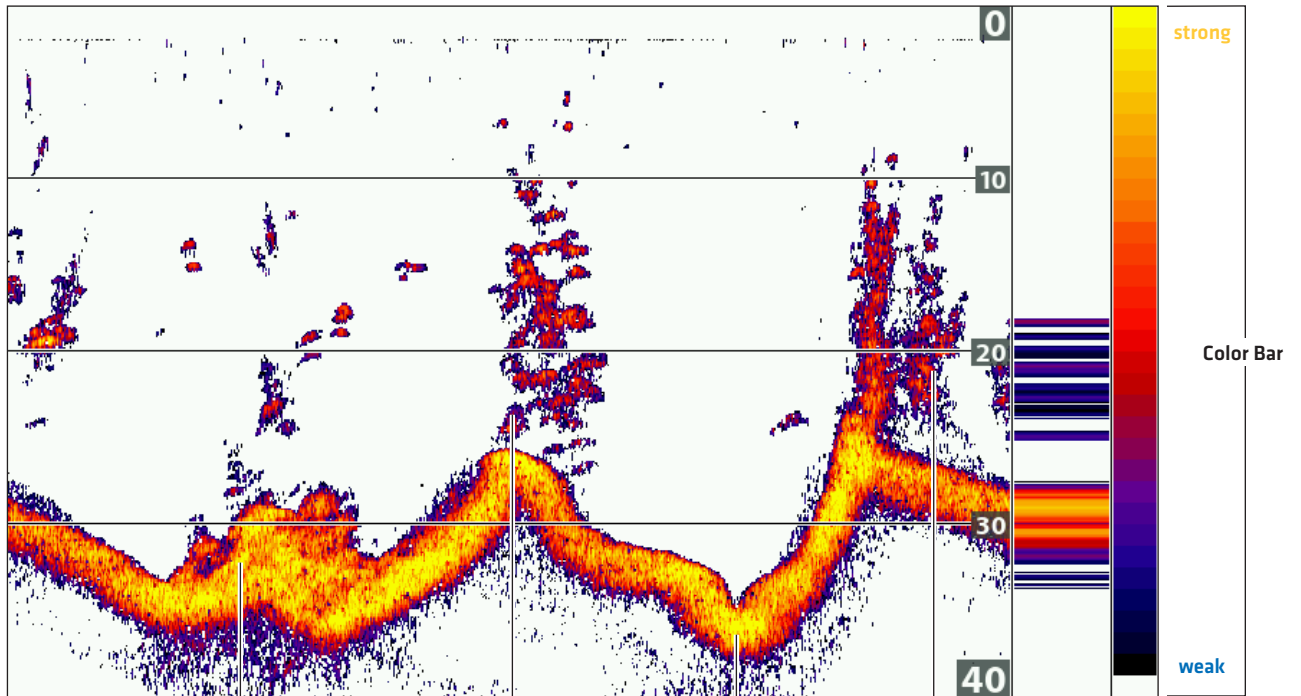
As the boat moves, the unit charts the changes in depth on the display to create a profile of the bottom contour. The Sonar View displays the sonar return intensity with different colors.

Strong returns often result from rocky or hard bottoms [compacted sediment, rocks, fallen trees], while weaker returns often result from soft bottoms [sand, mud], vegetation, and small fish.

The colors used to represent high, medium, to low intensity returns are determined by the palette you choose in the Sonar Colors menu [see *Customize the Sonar View*].

The control head displays the return intensity based on the Sonar Colors and Bottom View menu settings. You can display the RTS Window [Real Time Sonar], turn on/off fish symbols [Fish ID+], change the SwitchFire mode, adjust sensitivity, and more.

2D Sonar View: Sonar Colors Palette 1



strong returns  
(possibly rocks, tree limbs,  
or other structure)

weak returns  
(possibly vegetation  
or small fish)

strong returns  
(possibly compacted  
sediment or rocks)

medium returns

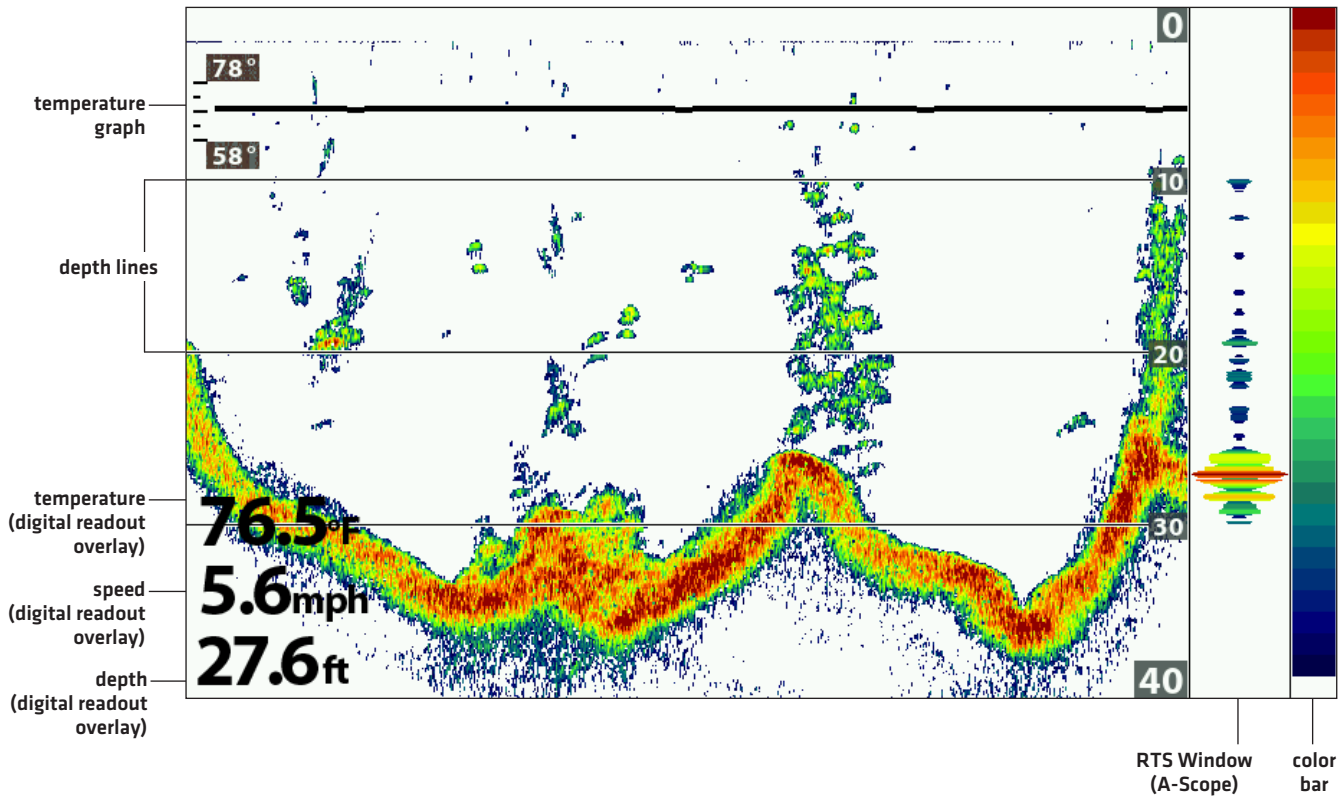


Sonar History – Historical returns scroll left across the view.

# CUSTOMIZE THE SONAR VIEW

You can customize the sonar views by showing or hiding information, such as the temperature graph, depth lines, color bar, and RTS Window. You can also change the color palette.

Customizing the Sonar View

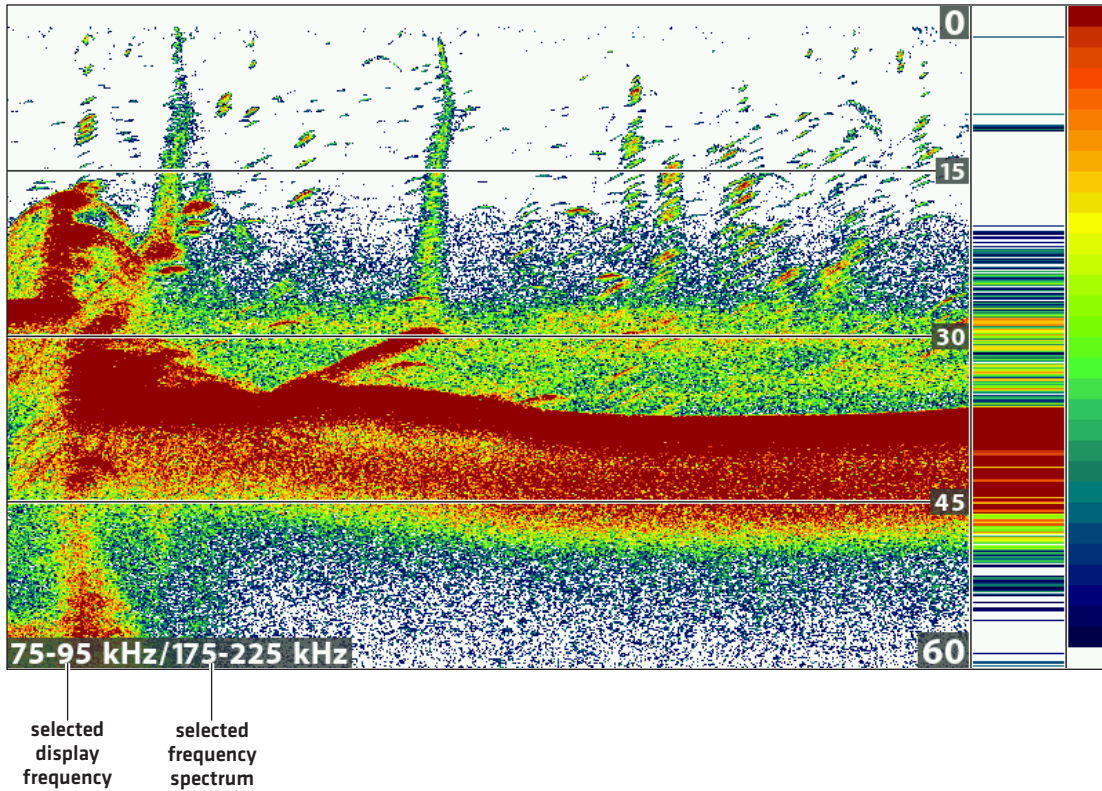


## Show/Hide the Frequency Label

The Frequency Label displays the currently selected frequencies. See **Set up Sonar**.

1. **Main Menu:** Press the MENU key twice. Select the **Sonar** tab.
2. Select Frequency Label.
3. Select On [show] or Off [hide].

**2D Sonar View with Frequency Label Turned On (HELIX 9 CHIRP SI GPS G2N)**



## Customize the RTS Window

The RTS Window plots the depth and intensity of a sonar return. It updates at the fastest rate possible for depth conditions and shows only the returns from the bottom, structure, and fish that are within the transducer beam. When you use the cursor to review sonar history, the sonar history will freeze, but the RTS Window will continue to display sonar returns in real time. See **Review Sonar History and Zoom In/Zoom Out**.

1. **Main Menu:** Press the MENU key twice. Select the **Sonar** tab.
2. Select RTS Window.
3. Select the type of RTS Window to display.

<b>Mono</b>	Sonar returns are displayed in black.
<b>Color [Full]</b>	Sonar returns are displayed in color, and they fill the width of the RTS Window.
<b>Color [A-Scope]</b>	Sonar returns are displayed in color. The size of the displayed lines correspond with the intensity of the sonar returns from the transducer beam[s].
<b>Off</b>	The RTS Window is hidden.

## Show/Hide Data on the Sonar View

The settings in this section are shared with the Down Imaging View, so turning them on or off will change what is shown on the Sonar Views and the Down Imaging Views.

1. **Main Menu [Custom User Mode]:** Press the MENU key twice. Select the **Sonar** tab.
2. Select a menu and change it to On [show] or Off [hide].

<b>Depth Lines</b>	The depth lines show incremental marks between the upper and lower depth range. See <b>Adjust Sonar Display Settings</b> for details.
<b>Color Bar</b>	The Color Bar shows the palette selected on the Sonar View [see <b>Change the View Colors</b> ] from weak to strong returns.
<b>Temperature Graph</b>	The temperature graph displays the temperature changes over the recent sonar history. A temperature input from the installed transducer or temp/speed accessory is required to enable this feature.

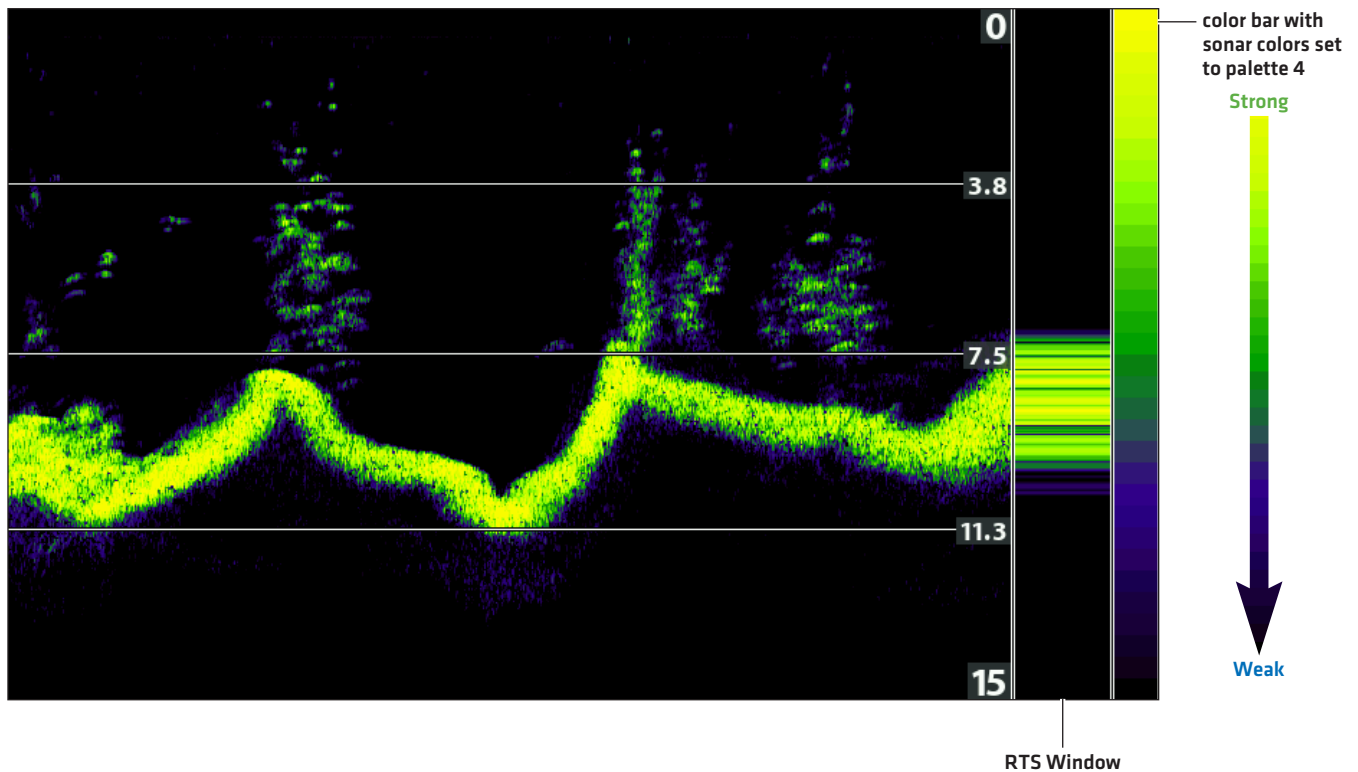


**NOTE:** Digital readouts can be displayed as an overlay, or they can be displayed in data boxes [see **Views: Display Digital Readouts**].

## Change the View Colors

The Sonar Colors menu changes the colors used to display sonar returns on the view.

### Sonar View with Customized Sonar Colors



### Change the Sonar Colors Palette

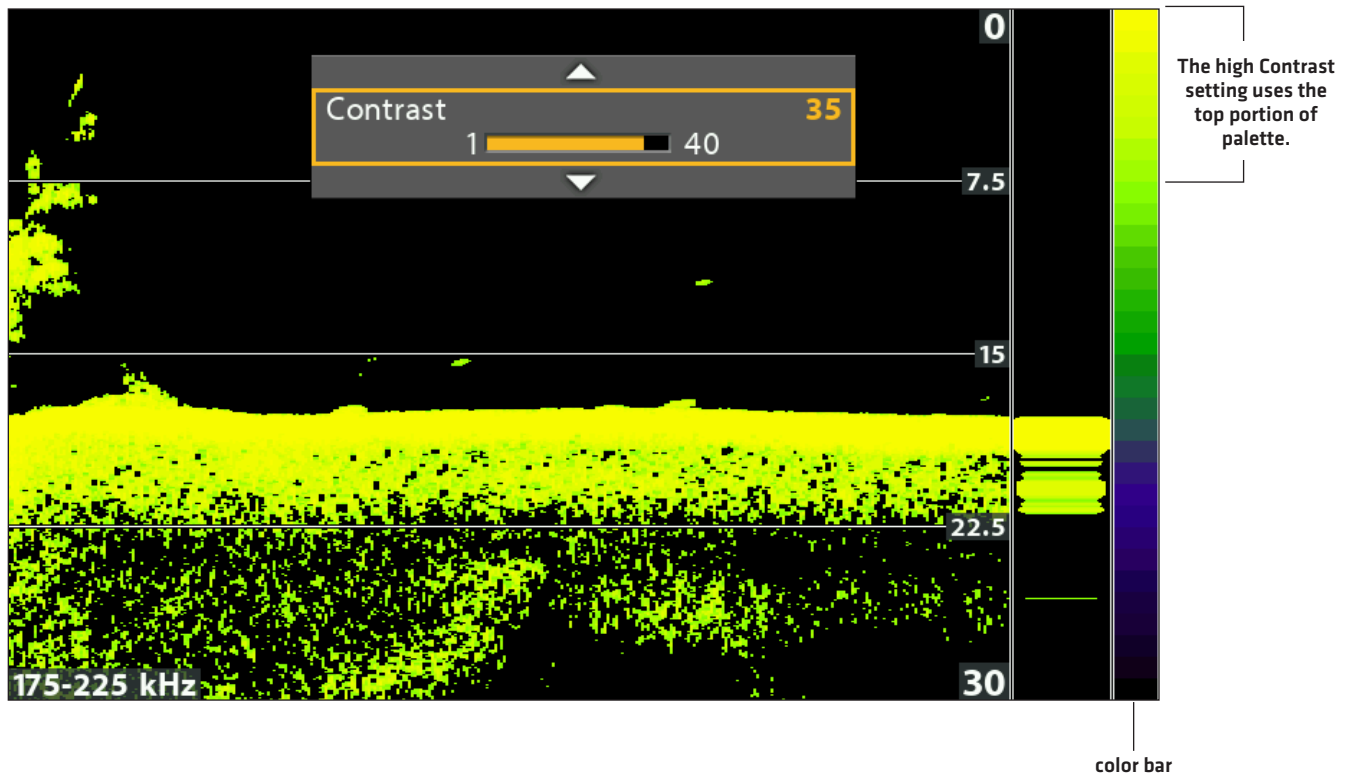
1. **Sonar X-Press Menu:** With a Sonar View displayed on-screen, press the MENU key once.
2. Select Sonar Colors.
3. Select a palette.



**NOTE:** To display or hide the Color Bar, see *Show/Hide Data on the Sonar View*.



## Adjusting the Contrast



### Select a Range of the Palette (Contrast)

Contrast allows you to choose a range of the Sonar Colors palette to display sonar returns. To see the current palette, display the Color Bar on the Sonar View.



**NOTE:** To display or hide the Color Bar, see *Show/Hide Data on the Sonar View*.

When Contrast is set to 20 [default], the entire Sonar Colors palette [represented by the Color Bar] is used to display weak and strong sonar returns. As you increase the Contrast, the top range of the Color Bar is used to display all sonar returns [whether weak or strong]. As you decrease the Contrast, the bottom range of the Color Bar is used to display all sonar returns [whether weak or strong].

1. **Sonar X-Press Menu:** With a Sonar View displayed on-screen, press the MENU key once.
2. Select Contrast.
3. Press the RIGHT or LEFT Cursor keys to move the selection higher or lower on the color bar.

# ADJUST SONAR DISPLAY SETTINGS

Use the instructions in this section to adjust how the sonar returns are shown on the Sonar View, so you can tune into what you want to see in the display. The settings in this section are optional. You can use the default display settings for the Sonar View, or you can customize it with your preferences.

## Filter Surface Clutter

Use Surface Clutter to reduce the noise that may appear at the top of the view caused by algae and aeration. The lower the setting, the less surface clutter will be displayed. A higher setting allows more surface clutter to be displayed.



**NOTE:** You can also adjust the Noise Filter [see **Set up Sonar: Adjust the Noise Filter**].

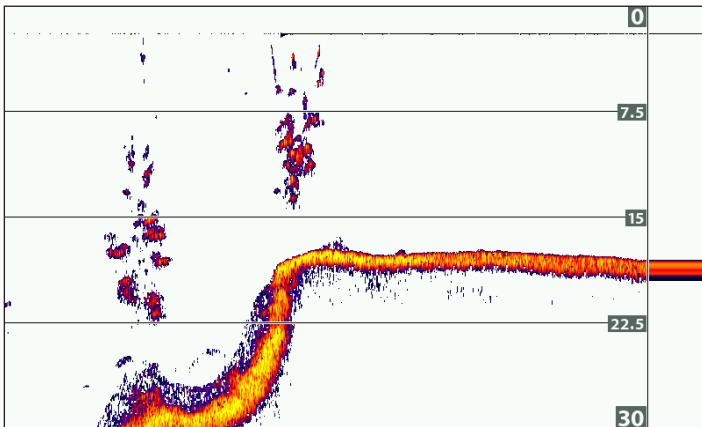
1. **Main Menu:** Press the MENU key twice. Select the **Sonar** tab.
2. Select Surface Clutter.
3. Press the RIGHT or LEFT Cursor keys to adjust the setting.

## Change the 2D SwitchFire Mode

SwitchFire controls how the sonar returns are displayed in the Sonar Views.

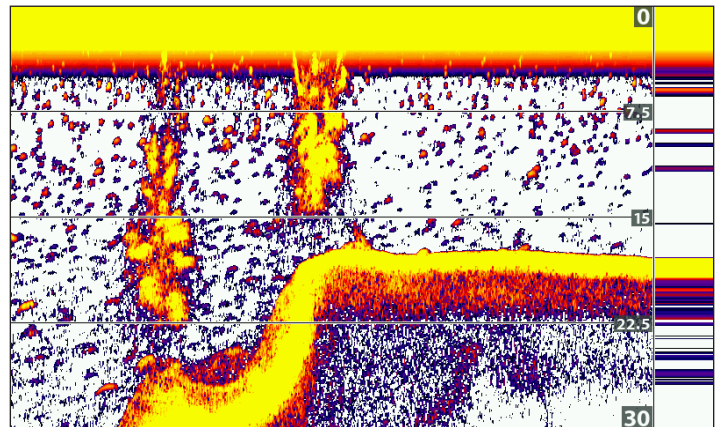
1. **Main Menu:** Press the MENU key twice. Select the **Sonar** tab.
2. Select 2D SwitchFire.
3. Select Clear Mode or Max Mode.

**2D SwitchFire: Clear Mode**



Choose Clear Mode to see less clutter and more fish size accuracy on the display. When Clear Mode is selected, the clutter is filtered, and sonar returns are interpreted to provide more details about the objects within the transducer beam, regardless of their location. In other words, a large arch on the display means a large fish has been detected.

**2D SwitchFire: Max Mode**

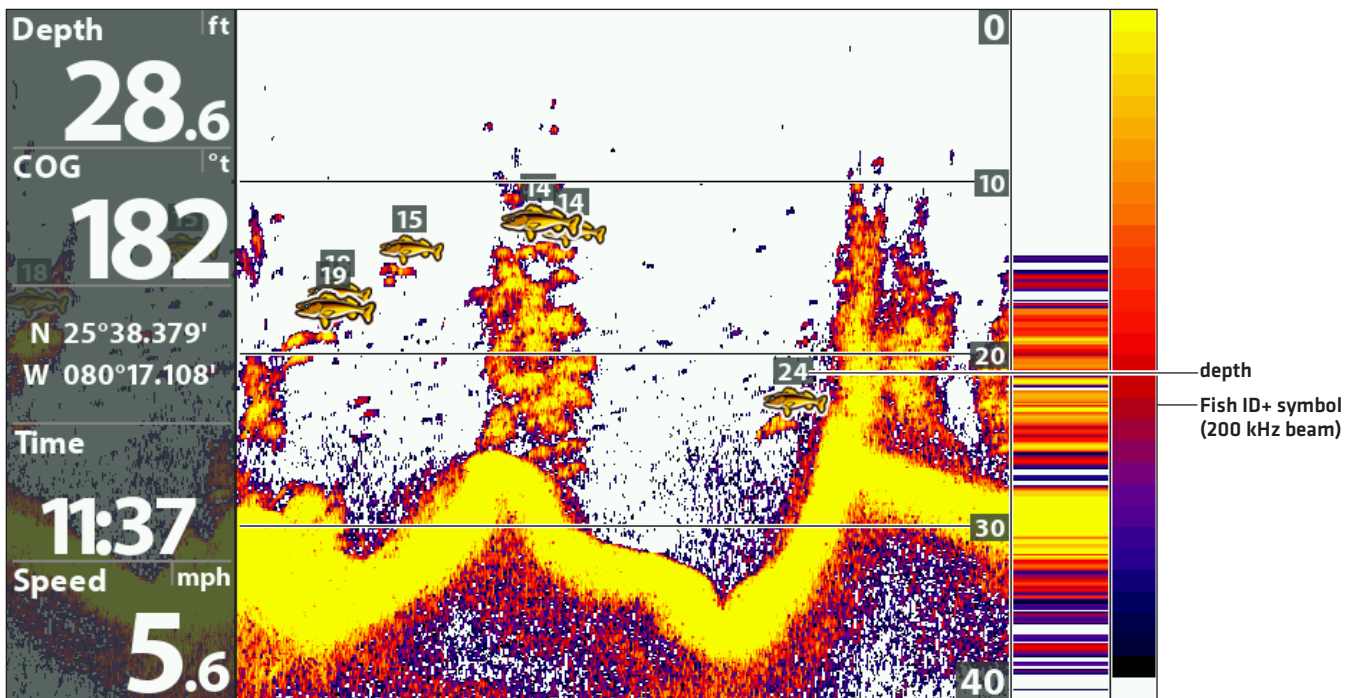


Choose Max Mode to see only raw sonar returns on the display. When Max Mode is selected, you will see the maximum sonar information available within the transducer beam, so more fish arches and better jig tracking are shown.

## Turn on/off Fish ID+ Settings

Fish ID+ uses advanced signal processing to interpret sonar returns and will display a fish symbol on the Sonar View when very selective requirements are met. Also, if Fish ID+ is turned on, you can adjust the sensitivity used for detection and receive alerts with the Fish ID Alarm turned on.

Fish ID+ Turned On



### Turn on/off Fish ID+

When Fish ID+ is turned on, fish symbols will be shown on the Sonar View. The color of the fish symbols indicates the sonar beam location, and the fish depth is shown above the symbol.

When Fish ID+ is turned off, the control head shows only the raw sonar returns on the display.

1. **Main Menu:** Press the MENU key twice. Select the **Sonar** tab.
2. Select Fish ID+.
3. Select On or Off.

On	<p>Fish Symbols will display in the Sonar View when a fish is detected.</p> <p>Orange Fish Symbols = targets detected in the 200 kHz narrow beam and Dual Spectrum.</p> <p>Green Fish Symbols = targets detected in the 83 kHz wide beam or 455 kHz beam [DI, CHIRP DI only].</p>
Off	<p>Raw sonar returns are shown on the Sonar View. If a fish is detected, the returns appear as arches on the display to indicate potential targets.</p>

## Adjust the Fish ID Sensitivity

Use Fish ID Sensitivity to adjust the threshold used for detecting a fish with Fish ID+. To display only larger species of fish as fish symbols, select a low setting. To see smaller fish species or baitfish, select a high setting. Fish ID+ must be turned on to enable this menu.

1. Turn on Fish ID+.
2. **Main Menu:** Press the MENU key twice. Select the **Sonar** tab.
3. Select Fish ID Sensitivity.
4. Press the RIGHT or LEFT Cursor keys to adjust the setting.

**1** = low sensitivity [large fish only]

**10** = high sensitivity [All: small fish up to large fish]

## Turn on the Fish ID Alarm

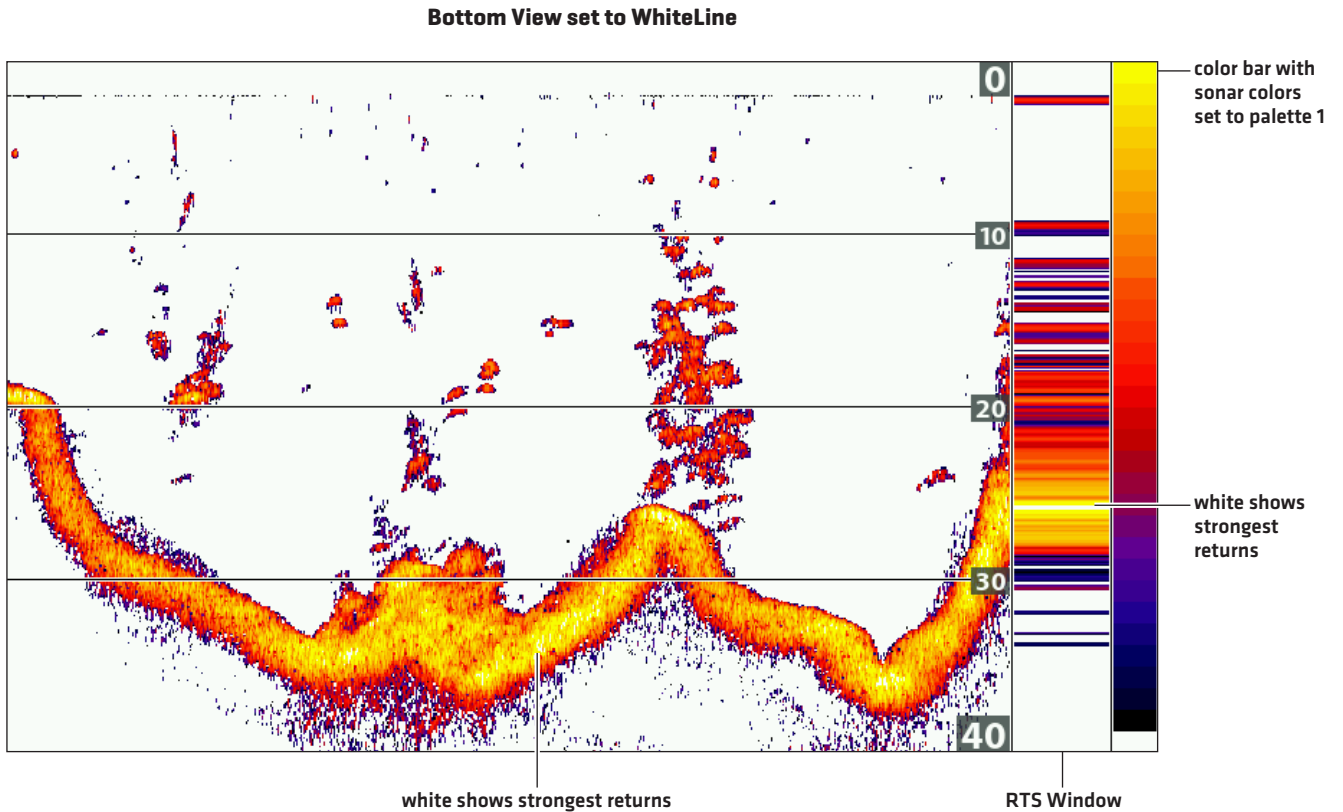
To receive an on-screen alert when a fish is detected, turn on the Fish ID Alarm. Fish ID+ must be turned on to enable this alarm.

1. Turn on Fish ID+.
2. **Main Menu:** Press the MENU key twice. Select the **Alarms** tab.
3. Select Fish ID Alarm.
4. Select one of the following icons:



## Set the Bottom View Display

Bottom View selects the method used to represent bottom and structure on the display. Bottom View is also affected by the palette selected in Sonar Colors [see *Customize the Sonar View: Change the View Colors*].



## Change the Bottom View Setting

1. **Main Menu:** Press the MENU key twice. Select the **Sonar** tab.
2. Select Bottom View.
3. Select one of the following modes:

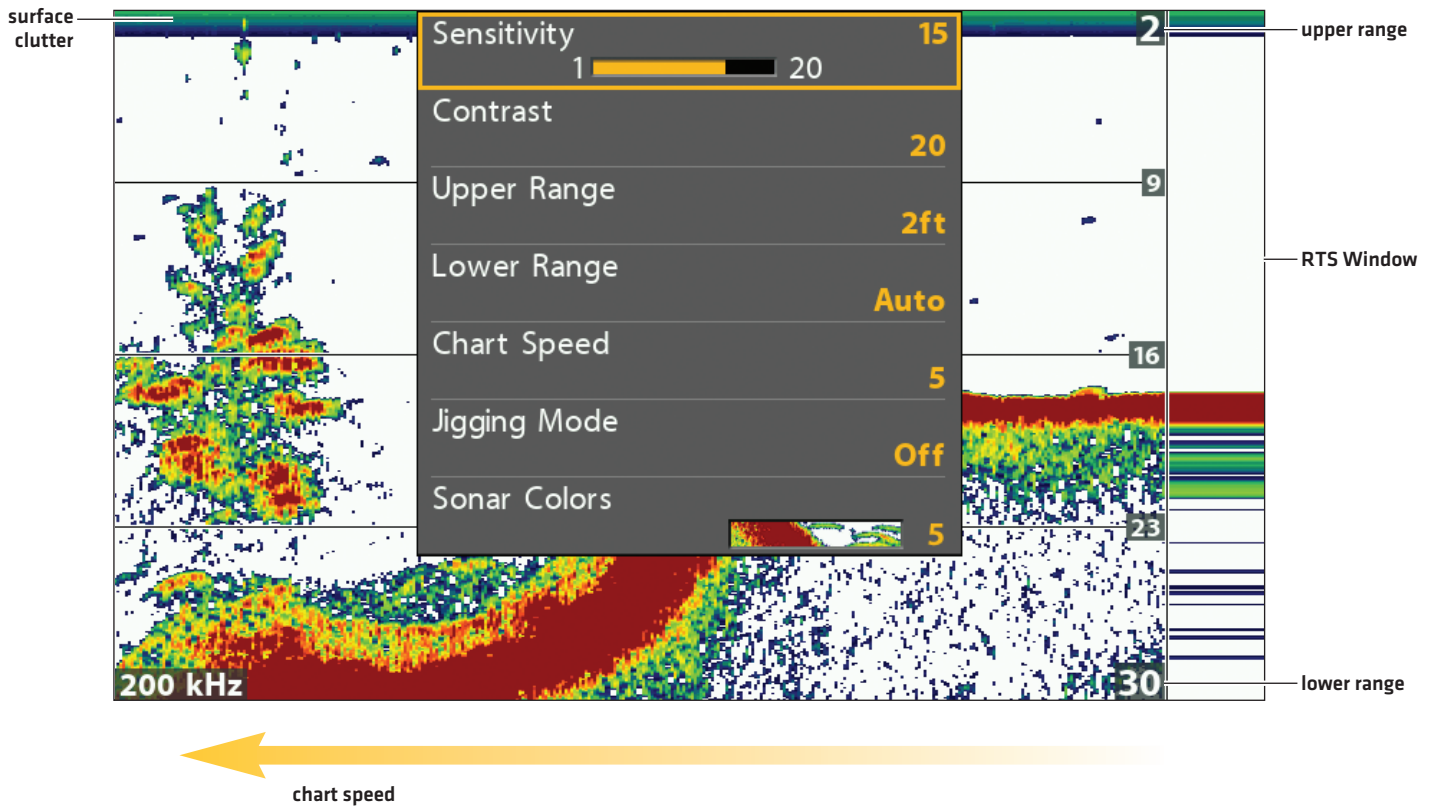
<b>Structure ID</b>	Structure ID will display the strongest return as specified by the palette selected in the Sonar Colors menu.
<b>WhiteLine</b>	WhiteLine highlights the strongest sonar returns in white. This has the benefit of clearly defining the bottom on the display.

# ADJUST SETTINGS WHILE YOU FISH

(SONAR X-PRESS MENU)

The X-Press Menu provides menu options to adjust the sensitivity and range as you fish. You can also control how fast the sonar history scrolls across the screen. The menus allow you to see more or less of the sonar returns from the transducer beams as you adjust each setting. Also, you can use key shortcuts on the view.

Adjusting Settings from the Sonar X-Press Menu (HELIX 7 CHIRP SI GPS G2)



## Adjust the Sensitivity

Sensitivity controls how much detail is shown on the view. To eliminate the clutter from the display that is sometimes present in murky or muddy water, decrease the sensitivity. When operating in very clear water or greater depths, increase the sensitivity to see weaker returns.

### Adjust the Sensitivity using the X-Press Menu

Use the following instructions to adjust the sensitivity.

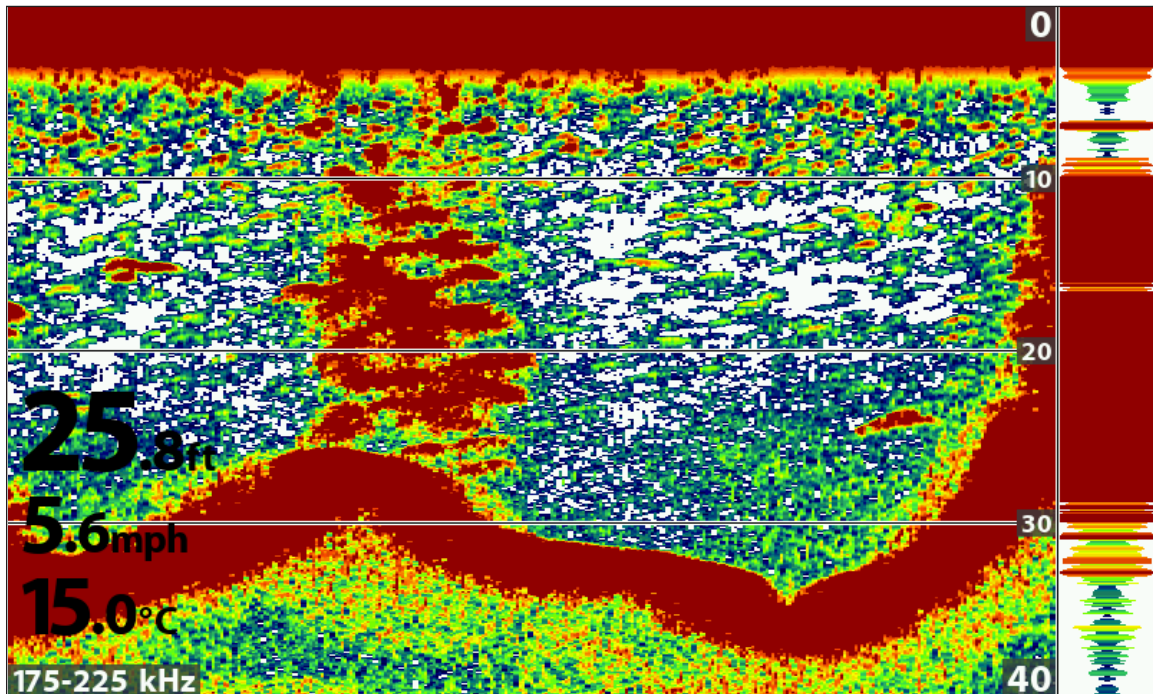
1. **Sonar X-Press Menu:** With a Sonar View displayed on-screen, press the MENU key once.
2. Select Sensitivity.
3. Press the RIGHT or LEFT Cursor keys to increase or decrease the sensitivity.

### Adjust the Sensitivity using the ZOOM Keys

If your control head includes +/-ZOOM keys, you can use them to adjust the sensitivity.

1. With a Sonar View displayed on-screen, press the +ZOOM key or -ZOOM key.

#### Adjusting the Sensitivity using the +/-ZOOM Keys



Increase Sensitivity



Decrease Sensitivity

## Adjust Beam Sensitivity

Your control head model may allow you to adjust the sensitivity of individual frequencies. The available frequencies are determined by your control head model and the installed transducer. Use the following instructions to adjust a single beam.

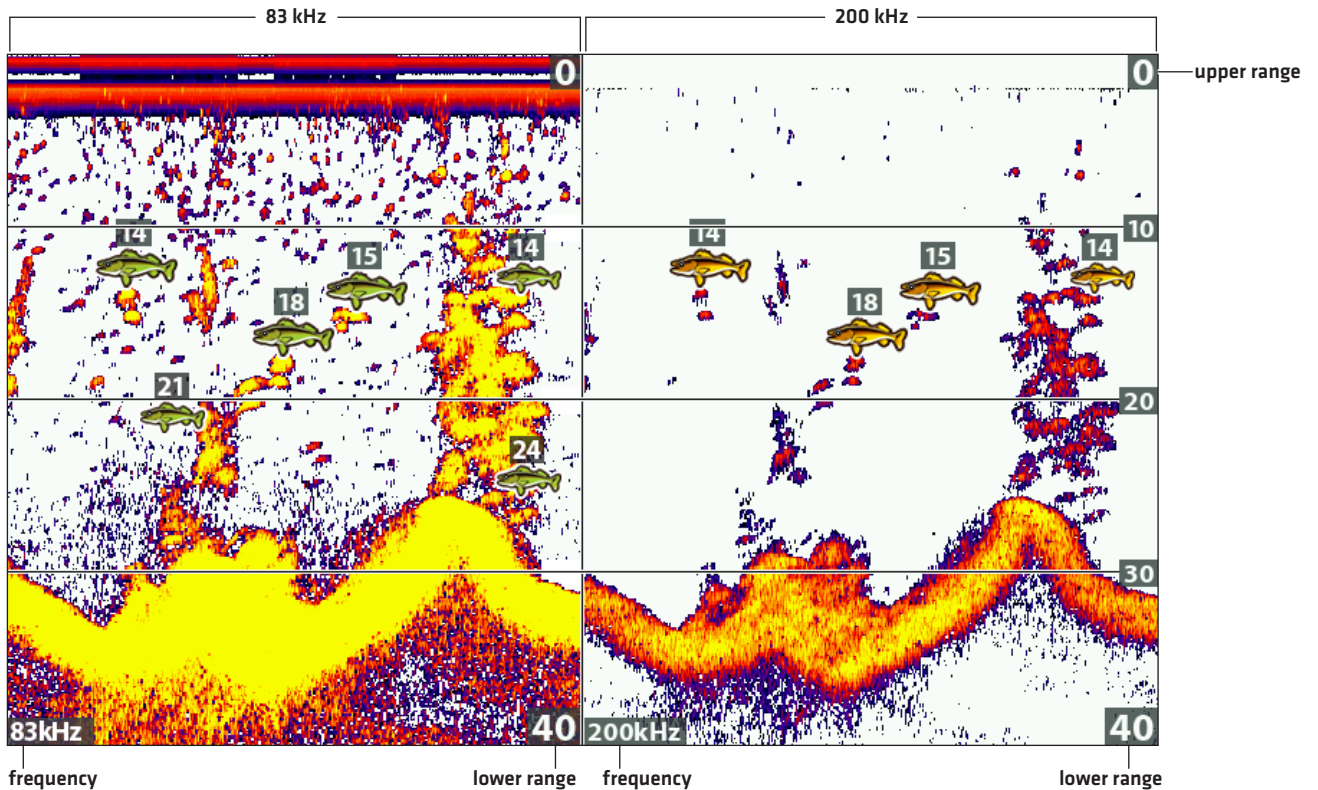
1. **Main Menu [Custom User Mode]:** Press the MENU key twice. Select the **Sonar** tab.
2. Select 83 kHz Sensitivity or 455 kHz Sensitivity.

**CHIRP Models:** Select Medium Sensitivity Offset or High [455 kHz] Sensitivity Offset [DI, CHIRP DI models only].

3. Press the RIGHT or LEFT Cursor keys to increase or decrease the sensitivity.

For example, in the illustration shown below, the sensitivity of the 83 kHz beam in the Split Sonar View can be adjusted without affecting the sensitivity of the 200 kHz sonar returns. For more information about this view, see **Compare Sonar Beams**.

**Increasing the Sensitivity of the 83 kHz Beam (83 kHz/200 kHz)**



## Select a Range of the Palette (Contrast)

Contrast allows you to choose a range of the Sonar Colors palette to display sonar returns. To see the current palette, display the Color Bar on the Sonar View. For details, see **Customize the Sonar View: Change the View Colors** and **Show/Hide Data on the Sonar View**.

When Contrast is set to 20 [default], the entire Sonar Colors palette [represented by the Color Bar] is used to display weak and strong sonar returns. As you increase the Contrast, the top range of the Color Bar is used to display all sonar returns [whether weak or strong]. As you decrease the Contrast, the bottom range of the Color Bar is used to display all sonar returns [whether weak or strong].

1. **Sonar X-Press Menu:** With a Sonar View displayed on-screen, press the MENU key once.
2. Select Contrast.
3. Press the RIGHT or LEFT Cursor keys to move the selection higher or lower on the color bar.



## Set the Upper/Lower Range

Upper Range and Lower Range control how much of the water column is displayed on the view. For example, if you are only interested in the area between 20 and 50 feet deep, set the Upper Range to 20 and the Lower Range to 50. The view will not display sonar returns outside of the set ranges, and greater detail for the selected range will be displayed.

1. **Sonar X-Press Menu (Custom User Mode):** With a Sonar View displayed on-screen, press the MENU key once.
2. Select Upper Range. Press the RIGHT or LEFT Cursor keys to adjust the setting.
3. Select Lower Range. Select Auto or set a specific depth [manual].

**Auto:** The Lower Range will be adjusted by the control head to follow the bottom automatically.

**Manual:** The control head locks onto the depth you select.



**NOTE:** There must be a difference of 10 feet between the upper and lower range settings.

## Change the Chart Speed

Chart Speed controls how fast the sonar history moves across the view and how much detail is shown. A faster speed is preferred by most anglers, and the sonar history moves quickly across the view. To slow down the sonar history display, select a lower setting. Regardless of the Chart Speed setting, the RTS Window will update at the maximum rate possible for depth conditions.

1. **Sonar X-Press Menu:** With a Sonar View displayed on-screen, press the MENU key once.
2. Select Chart Speed.
3. Press the RIGHT or LEFT Cursor keys to adjust the setting.

## Turn on/off Jigging Mode (CHIRP SI, CHIRP MEGA SI, CHIRP MEGA SI+ models only)

If you have a CHIRP SI, CHIRP MEGA SI or CHIRP MEGA SI+ model and a Dual Beam SI transducer, you can use Jigging Mode to refine the sonar returns shown in the Sonar View.



**NOTE:** This feature is only available when a Dual Beam SI transducer is connected. Jigging Mode is not needed with High Wide Dual Spectrum CHIRP transducers.

1. **Sonar X-Press Menu:** With a Sonar View displayed on-screen, press the MENU key once.
2. Select Jigging Mode.
3. Select On or Off.

<b>On</b>	Turn on Jigging Mode if you've selected Medium or Medium/High Frequency in the 2D CHIRP Display Frequency menu [with 2D CHIRP Mode turned on], or if you've selected 83 kHz or 83/200 kHz in the 2D Display Frequency menu [with 2D CHIRP Mode turned off]. When Jigging Mode is turned on, the sonar returns are refined on the view, and the chart speed slows down to show more detail.
<b>Off</b>	Turn off Jigging Mode if you've selected Low Frequency in the 2D CHIRP Display Frequency menu [with 2D CHIRP Mode turned on], or if you've selected 200 kHz in the 2D Display Frequency menu [with 2D CHIRP Mode turned off]. Turn off Jigging Mode to display the sonar history at the selected chart speed and see coarser returns on the display.

## Change the Sonar Colors Palette

The Sonar X-Press Menu allows you to quickly change the display palette while you fish. See *Customize the Sonar View: Change the View Colors* for more information.

1. **Sonar X-Press Menu:** With a Sonar View displayed on-screen, press the MENU key once.
2. Select Sonar Colors.
3. Select a palette.



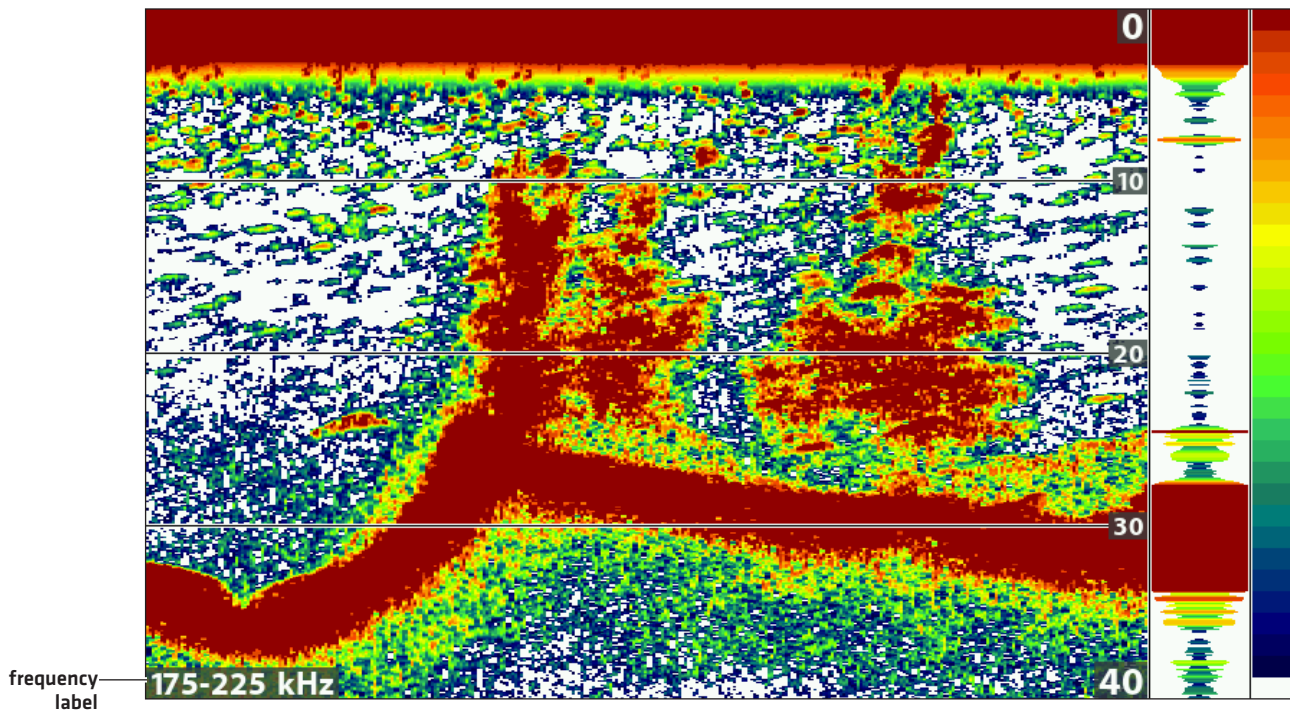
**NOTE:** To display or hide the Color Bar, see *Customize the Sonar View*.

## Switch Frequencies

If the transducer includes more than one downbeam frequency, use the CHECK/INFO key to quickly change the frequency used in the 2D Sonar View. For more information see *Sonar Overview* and *Set up Sonar*.

1. With a Sonar View displayed on-screen, press the CHECK/INFO key.

### Using the CHECK key to Switch Frequencies



Switch Frequencies

# COMPARE SONAR BEAMS

## (SPLIT SONAR VIEW)

Split Sonar View displays sonar returns from each down beam frequency on separate sides of the view. You can use this view to make side by side comparisons between the sonar returns from both beams. The beams are determined by your Humminbird model and the installed transducer.

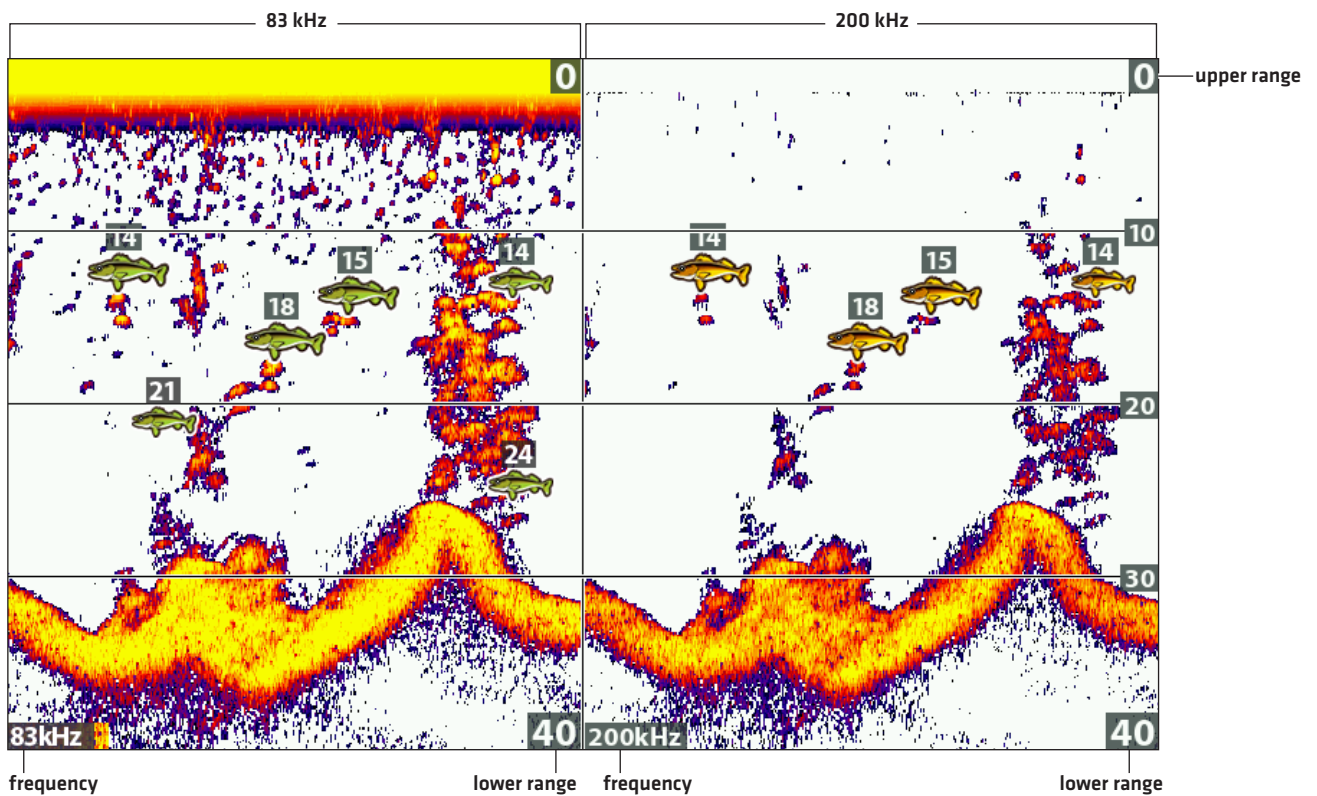
**Frequencies:** Use this view to compare the 83 kHz and 200 kHz beams. If you have a DI or CHIRP DI model, 455 kHz and 200 kHz will be displayed side by side in this view. When 2D CHIRP Mode is turned on, you can also compare beams.

**Fish ID+:** It is also helpful to turn on Fish ID+ in Split Sonar View so you can see where the fish are located within each transducer beam (see *Adjust Sonar Display Settings: Turn on/off Fish ID+ Settings*).

### Display the Split Sonar View

1. Press and hold the VIEW key.
2. Select Sonar > Split Sonar View.

Reviewing Beams Separately in Split Sonar View [83 kHz/200 kHz]



# REVIEW SONAR HISTORY

Press any arrow on the Cursor Control key, and the sonar history will freeze and the cursor will display on-screen. If you move the cursor over a sonar return, digital readouts for the cursor position are displayed on the view. The RTS Window continues to update at the fastest rate possible for depth conditions [see *Customize the Sonar View*].

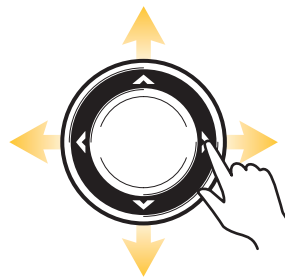
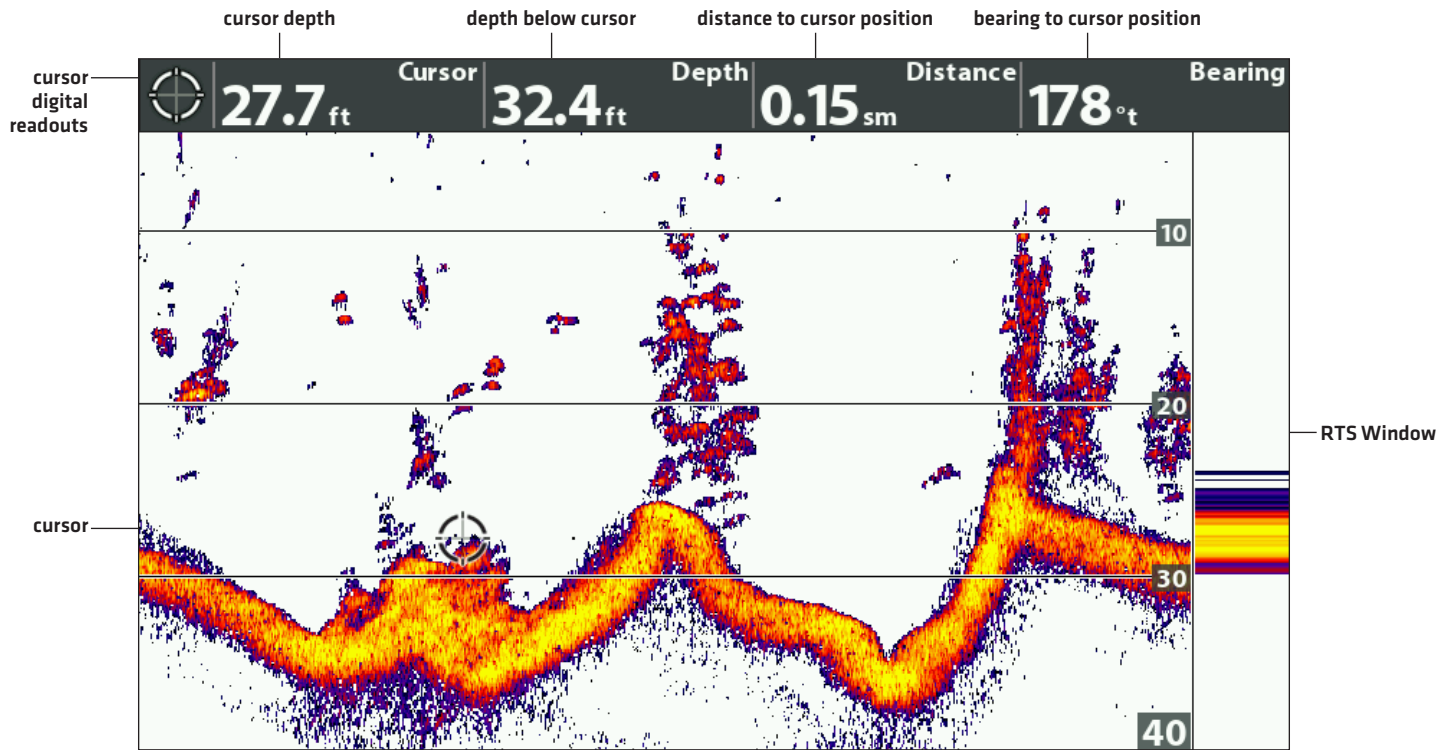
## Freeze the Sonar History

1. Press any arrow on the Cursor Control key.
2. Move the cursor over a sonar return.



**NOTE:** To mark a waypoint or start navigation to the cursor position, see *Navigation in Sonar Views*.

### Reviewing the Depth of the Cursor Position



Move the Cursor

## Zoom In/Zoom Out

---

Use the Sonar Zoom View to see a magnified view of the bottom and structure. For example, if there are fish close to the bottom or near structure [tree, vegetation, etc.], Sonar Zoom View makes it easier to see the separate sonar returns that might be displayed close together.

### Display the Sonar Zoom View

1. Press and hold the VIEW key.
2. Select Sonar > Sonar Zoom View.

### Zoom In/Zoom Out using the ZOOM Keys

If your control head includes +/- ZOOM keys, use the instructions in this section to use the ZOOM feature.

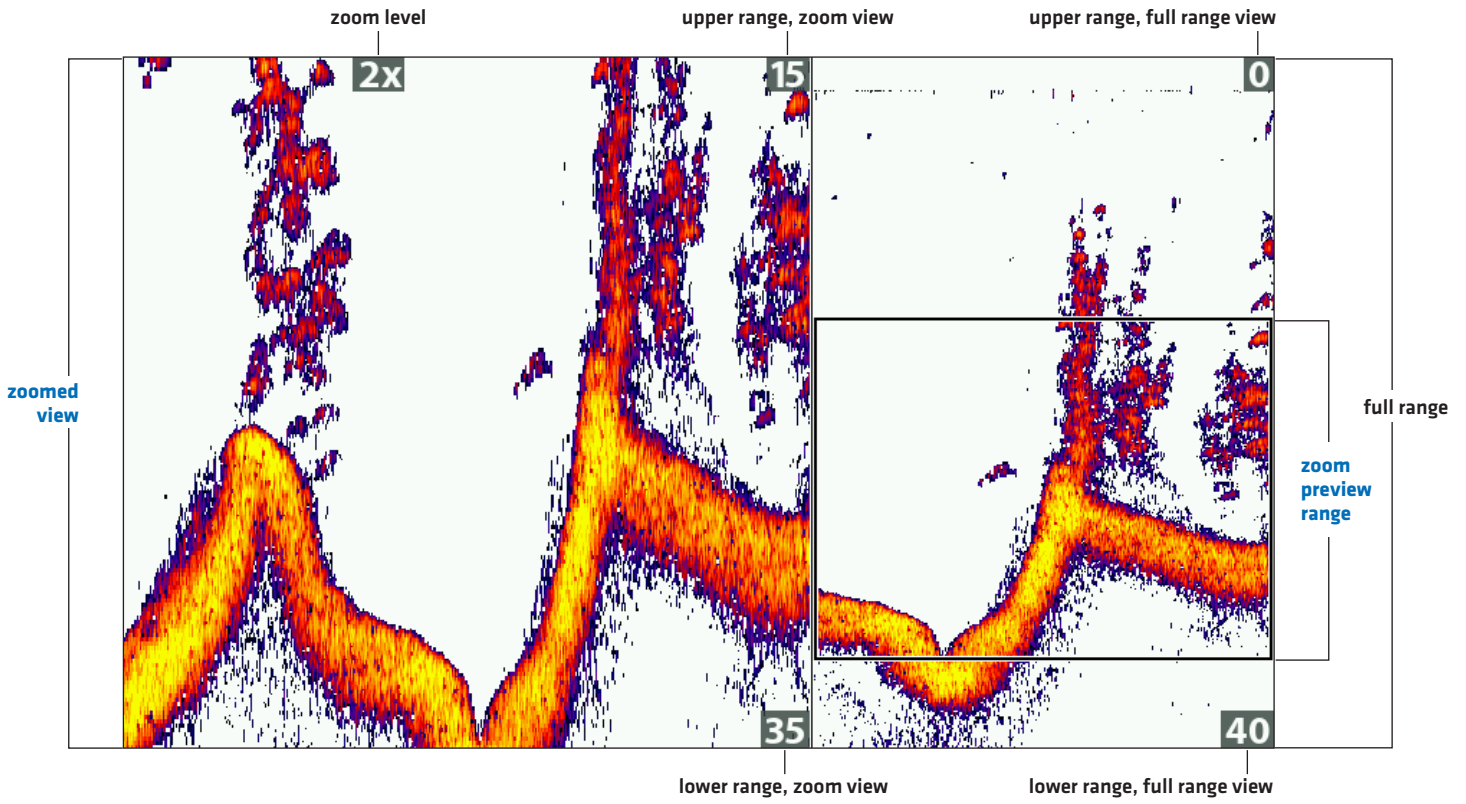
### Magnify Bottom Structure (Zoom In/Out)

1. Display the Sonar Zoom View on-screen.
2. **Zoom In:** Press the +ZOOM key.  
**Zoom Out:** Press the -Zoom key.

### Magnify the Cursor Position (Zoom In/Out)

1. Display the Sonar Zoom View on-screen.
2. Use the Cursor Control key to move the cursor to a position on the view.
3. **Zoom In:** Press the +ZOOM key.  
**Zoom Out:** Press the -Zoom key.
4. **Close:** Press the EXIT key.

### Magnifying Sonar Returns in Sonar Zoom View (Bottom Lock Off)

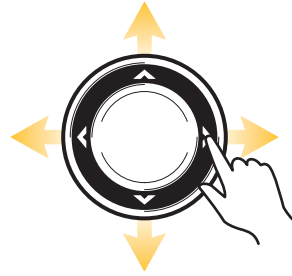


ZOOM In



ZOOM Out

OR



Move the Cursor



ZOOM In

## Zoom In/Zoom Out using the X-Press Menu

If your control head does not include ZOOM keys, you will use the Zoom Level menu to use the ZOOM feature.

### Magnify Bottom Structure (Zoom In/Out)

1. Display the Sonar Zoom View on-screen.
2. Press the MENU key once.
3. Select Zoom Level.
4. Press the RIGHT or LEFT Cursor keys to adjust the setting.

### Magnify the Cursor Position (Zoom In/Out)

1. Display the Sonar Zoom View on-screen.
2. Use the Cursor Control key to move the cursor to a position on the view.
3. Press the MENU key once.
4. Select Zoom Level.
5. Press the RIGHT or LEFT Cursor keys to adjust the setting.
6. **Close:** Press the EXIT key.

## Adjust Sonar Zoom View Display Settings

### Turn on/off Bottom Lock

Use Bottom Lock and Bottom Range to focus on the bottom and control how much of the water column is shown in Sonar Zoom View. Bottom Lock continuously graphs the bottom at a constant point on the display regardless of changes in depth. This “flattens” out the bottom contour but is effective at showing fish on or near the bottom.

1. **Sonar X-Press Menu:** With a Sonar Zoom View displayed on-screen, press the MENU key once.
2. Select Bottom Lock. Press the RIGHT Cursor key to select On.
3. Press the UP Cursor key. Select Bottom Range.
4. Press the RIGHT or LEFT Cursor keys to adjust the range. The range is measured up from the bottom.

**Low Setting:** useful for seeing low-lying bottom structure or details of the bottom return.

**High Setting:** useful for seeing large structure in deeper water.



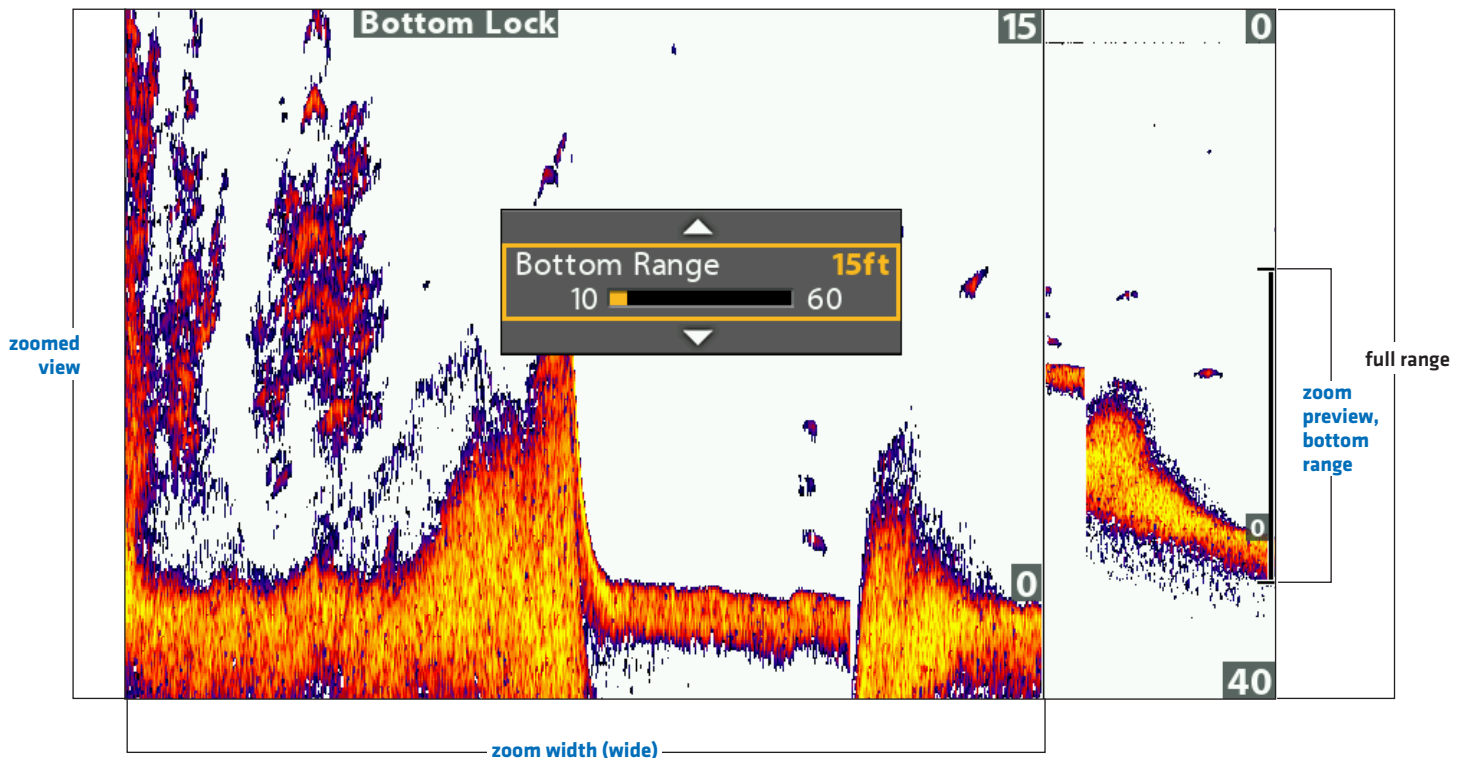
**NOTE:** If you see a wavy band on the view that mirrors the change in depth, the Bottom Range might be set deeper than the actual water depth. In this case, decrease the Bottom Range setting.

### Change the Width of the Zoomed View

Use the instructions in this section to change the width of the zoomed view in Sonar Zoom View.

1. **Main Menu:** Press the MENU key twice. Select the **Sonar** tab.
2. Select Zoom Width.
3. Press the RIGHT or LEFT Cursor keys to adjust the setting.

#### Setting the Bottom Range and Zoom Width (Bottom Lock On)





# NAVIGATION IN SONAR VIEWS

To mark waypoints and start navigation, the control head must have a GPS Fix from a connected or internal GPS receiver. See *Getting Started* for more information.

## Mark a Waypoint

You can mark a waypoint at the boat position or the cursor position. Waypoints are saved to the Waypoint Management dialog box [see *Manage your Navigation Data*].

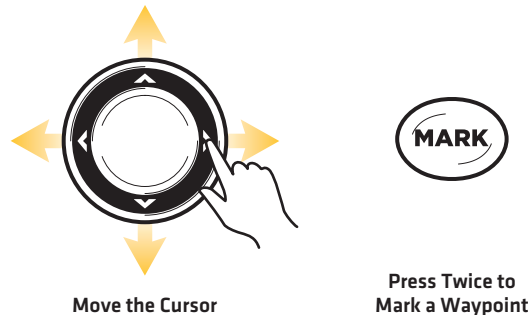
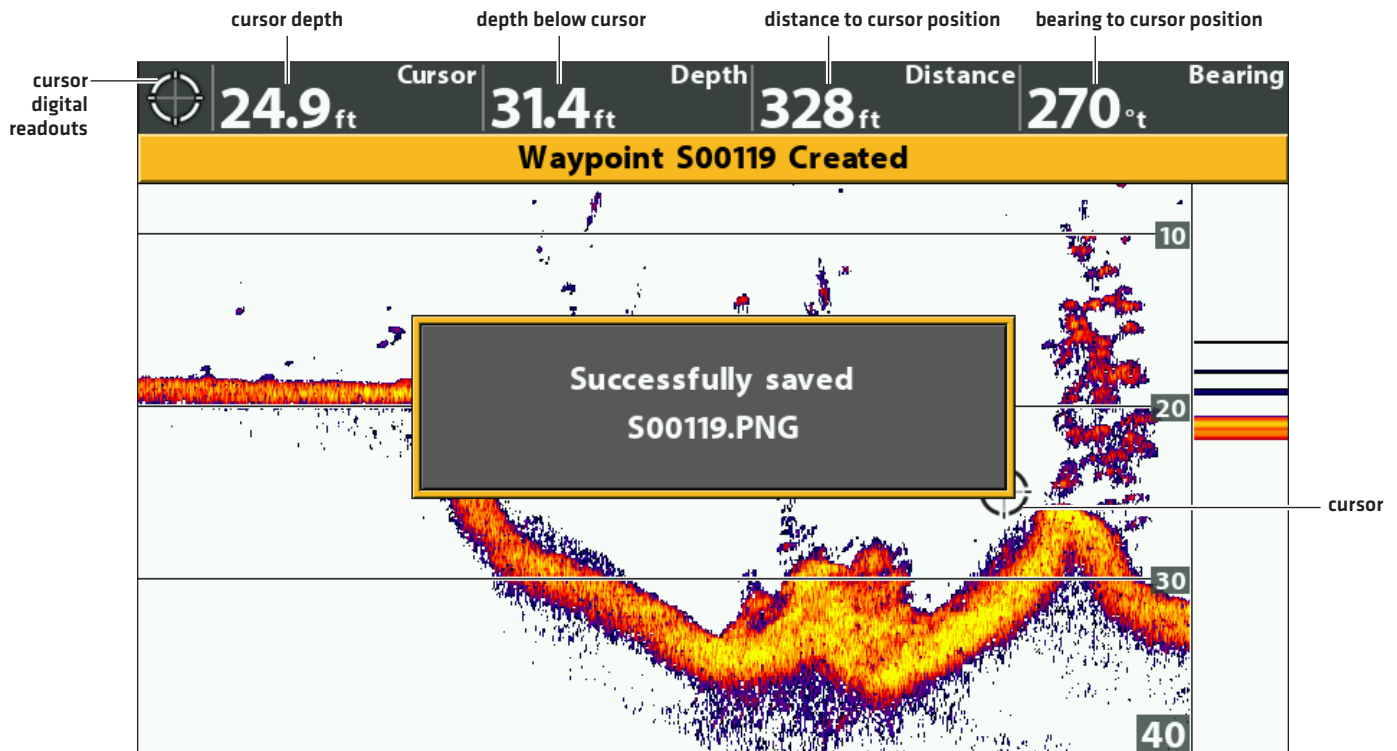
### Mark a Waypoint at the Boat Position

1. Press the MARK key.

### Mark a Waypoint at the Cursor Position

1. Use the Cursor Control key to move the cursor to a position on the view.
2. Press the MARK key twice.

Marking a Waypoint at the Cursor Position



## Navigate to a Position

Use the instructions in this section to start navigation to a position in the view. See *Navigation Overview* for more information about these features.

### Navigate to the Cursor Position

1. Use the Cursor Control key to move the cursor to a position on the view.
2. Press the GOTO key twice.

When you press the GOTO key, a waypoint will be marked at the cursor position.

### Navigate to a Saved Position

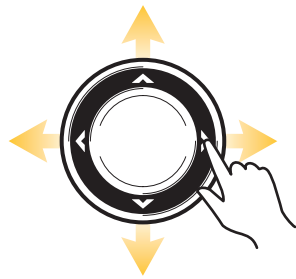
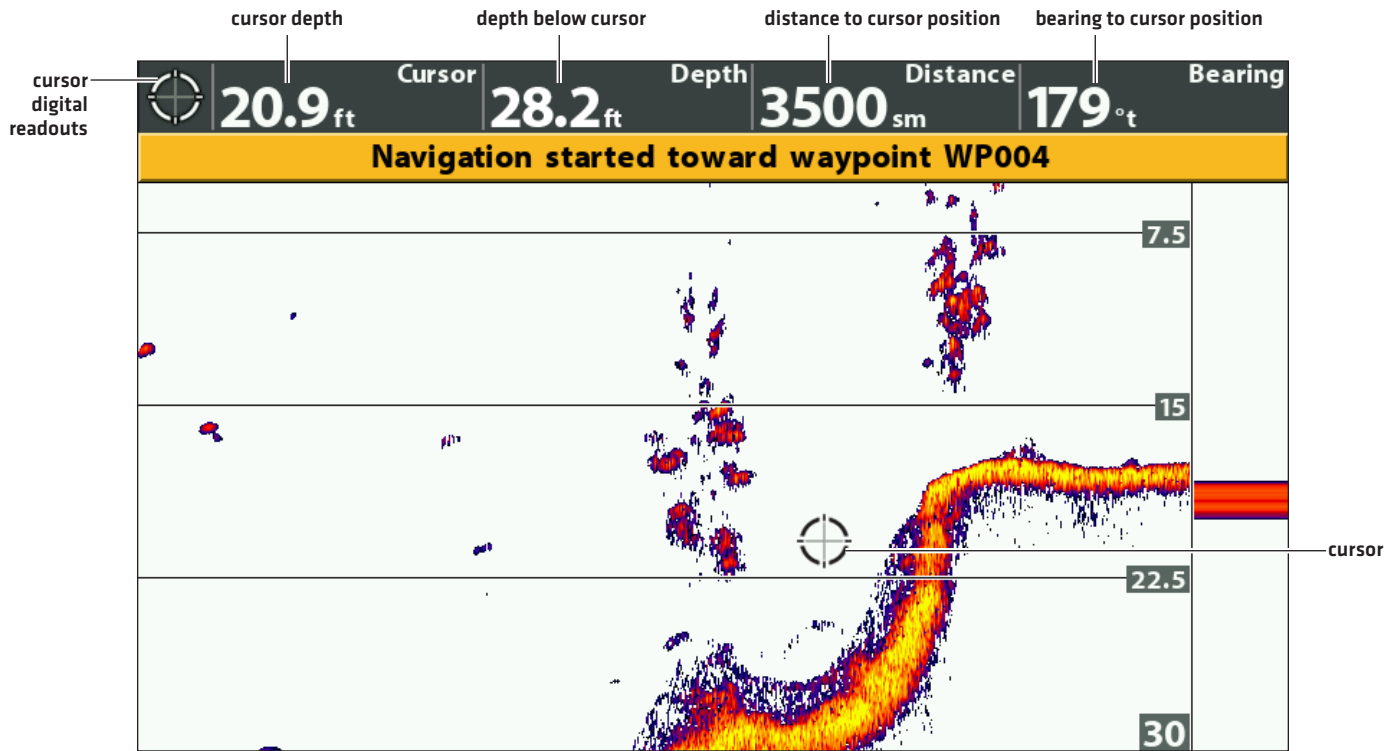
If you press the GOTO key, you can choose to start navigation from a list of saved waypoints and routes.

1. Press the GOTO key.
2. Select Nav Data. Press the RIGHT Cursor key.
3. Use the Cursor Control key to select a saved waypoint or route.
4. Press the RIGHT Cursor key to start navigation.

### Cancel Navigation

1. Press the MENU key once.
2. Select Cancel Navigation. Press the RIGHT Cursor key.

### Starting Navigation to the Cursor Position



Move the Cursor



Press Twice to Start Navigation

# DISPLAY A DOWN IMAGING VIEW ON-SCREEN

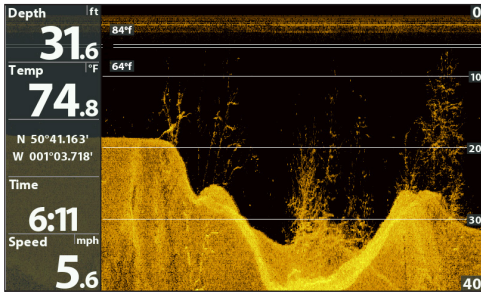
(DOWN IMAGING AND SIDE IMAGING MODELS ONLY)

There are a variety of views available to display Down Imaging data. You can also customize the view by showing or hiding information [see *Customize the Down Imaging View*], and you can adjust the sonar settings to refine the information displayed on-screen [see *Adjust Settings While you Fish*]. The changes you make are applied to all Down Imaging views.

## Display a Down Imaging View

1. Press and hold the VIEW key.
2. Select Sonar > Down Imaging View.

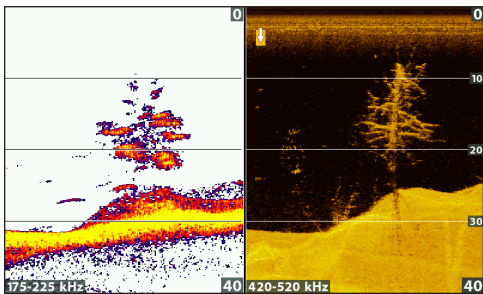
Down Imaging View



## Display a Down Imaging Combo View

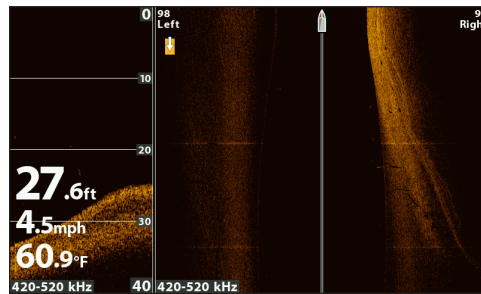
1. Press and hold the VIEW key.
2. To open a Down Imaging Combo View, select Sonar.  
To open a Chart Combo View [Down Imaging and Chart together], select Chart.
3. Select a view to display on-screen. Press the RIGHT Cursor key.

Sonar > Down/Sonar Combo View



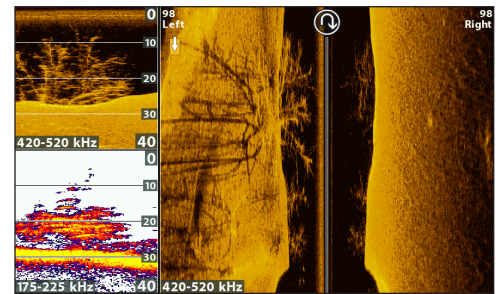
For more information, see the *Sonar* section.

Sonar > Down/Side Combo View



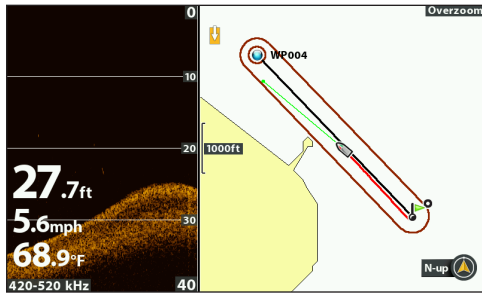
For more information, see the *Side Imaging* section.

Sonar > Down/Side/Sonar Combo View



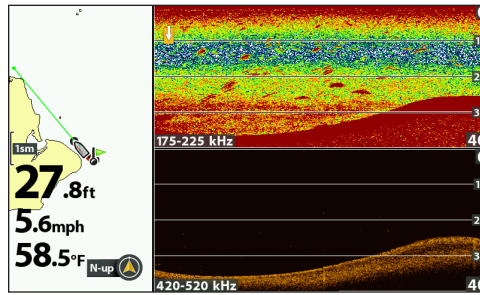
For more information, see the *Sonar* and *Side Imaging* sections.

Chart > Chart/Down Combo View  
[Map Source: Contour XD]



For more information, see  
*Navigation Overview.*

Chart > Chart/Sonar/Down Combo View  
[Map Source: Contour XD]



For more information, see  
the *Sonar* and *Navigation* sections.



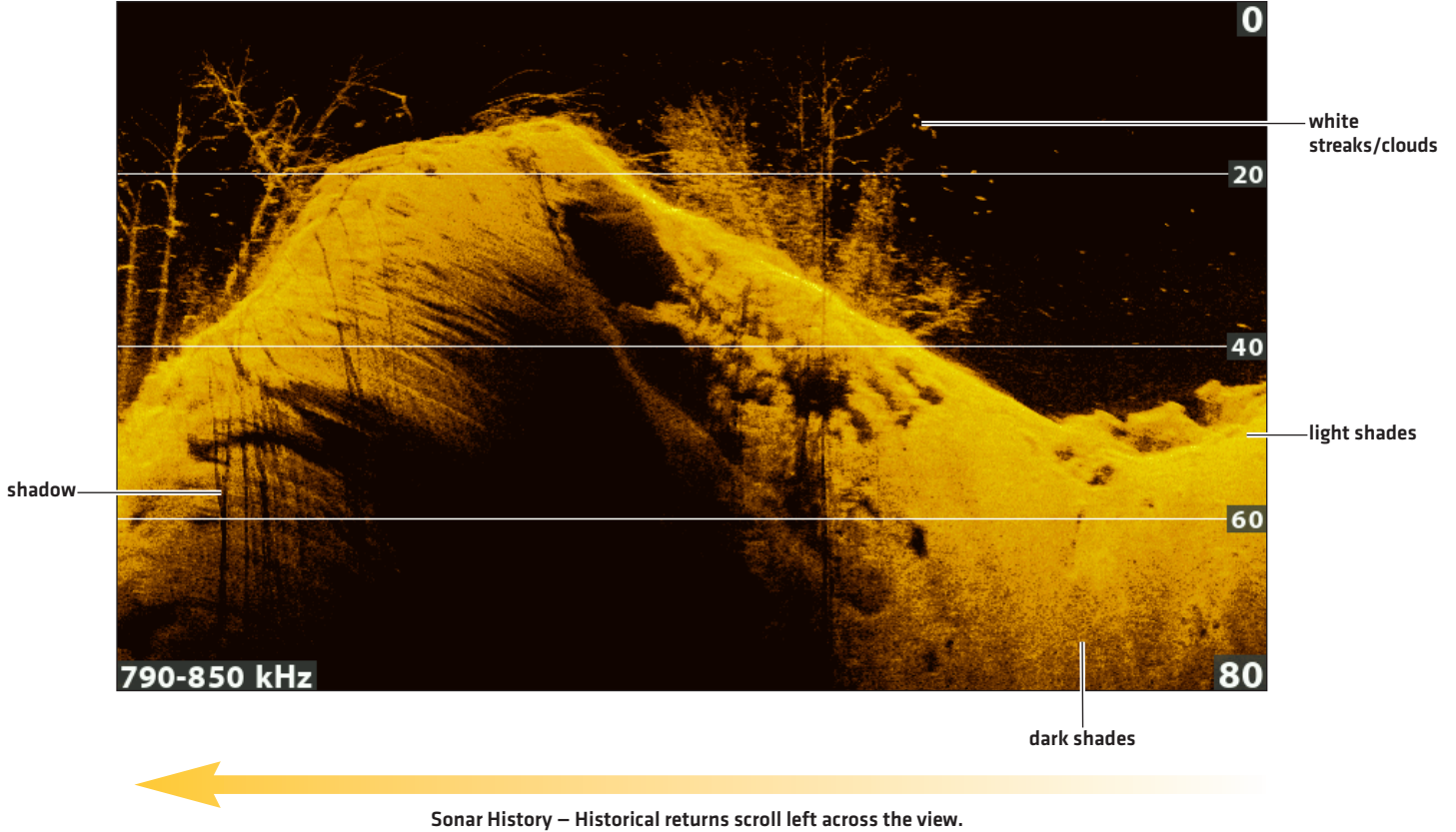
**NOTE:** The available views are determined by your control head model and the installed transducer. For a complete list of the views available on your control head, press the MENU key twice, and select the Views tab. See each related section of the manual [*Views, Sonar, Side Imaging, Navigation Overview, etc.*] for more information.

# UNDERSTAND THE DOWN IMAGING VIEW

The images you see on the Down Imaging display are produced using sonar technology. Each time the unit pings, a strip of data representing all the echoes received by the transducer are put together on the display to form the image that you see. Like traditional 2D Sonar, the sonar history scrolls left across the screen.

Down Imaging beams “illuminate” the bottom contour, structure, and fish. The beams are wide [side to side] but very thin from front to back.

**Down Imaging View (HELIX 9 CHIRP DI GPS G2N)**



Use the light and dark parts of the display to interpret the objects under your boat as follows:

**Dark shades** represent soft returns [mud, sand] or descending terrain.

**Light shades** represent denser terrain [timber, rocks] or rising terrain. A very hard bottom may appear as white on the display.

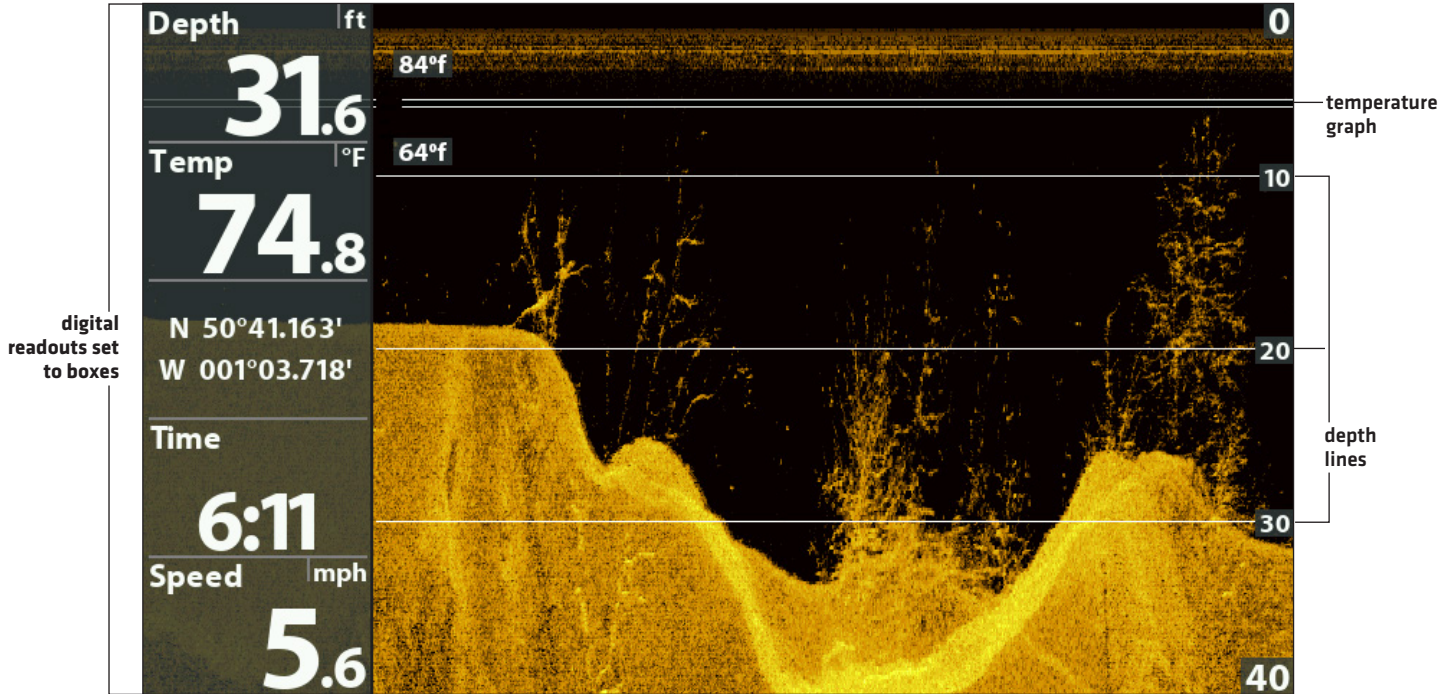
**White Streaks** or **Clouds** may represent fish on the display.


**Shadows** are not caused by light but by the lack of a sonar return. Objects standing on the bottom cause a sonar shadow to appear on the display. The longer the shadow, the taller the object. Fish may also cast shadows. You can use the shadow to interpret where the fish or object is located in relation to the bottom.

# CUSTOMIZE THE DOWN IMAGING VIEW

You can customize the Down Imaging views by showing or hiding information, such as depth lines, temperature graph, and digital readouts. You can also change the color palette.

## Customizing the Down Imaging View



 **NOTE:** Digital readouts can be displayed as an overlay, or they can be displayed in data boxes [see **Views: Display Digital Readouts**].

## Show/Hide Depth Lines

The depth lines show incremental marks between the upper and lower depth range. See **Adjust Settings While you Fish** for details. The Depth Lines menu is shared with the Sonar View, so turning them on or off will affect the Sonar Views and the Down Imaging Views.

1. **Main Menu [Custom User Mode]:** Press the MENU key twice. Select the **Sonar** tab.
2. Select Depth Lines.
3. Select On [show] or Off [hide].

## Show/Hide the Temperature Graph

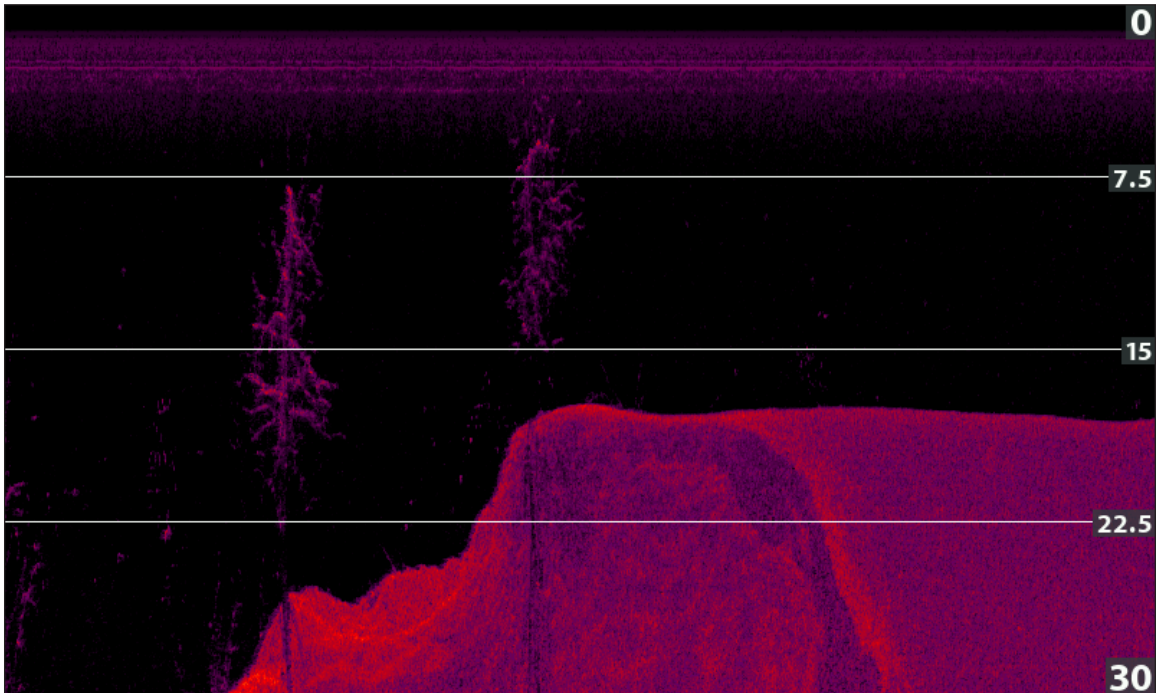
The temperature graph displays the temperature changes over the recent sonar history. A temperature input from the installed transducer or temp/speed accessory is required to enable this feature. The Temperature Graph menu is shared with the Sonar View, so turning it on or off will affect the Sonar Views and the Down Imaging Views.

1. **Main Menu:** Press the MENU key twice. Select the **Sonar** tab.
2. Select Temperature Graph.
3. Select On [show] or Off [hide].

## Change the View Colors

The DI Colors menu changes the palette used to display sonar returns on the view.

**Down Imaging View with Palette 10 Selected (DI Colors)**



### Change the Down Imaging Colors Palette

1. **Down Imaging X-Press Menu:** With a Down Imaging View displayed on-screen, press the MENU key once.
2. Select DI Colors.
3. Select a palette.

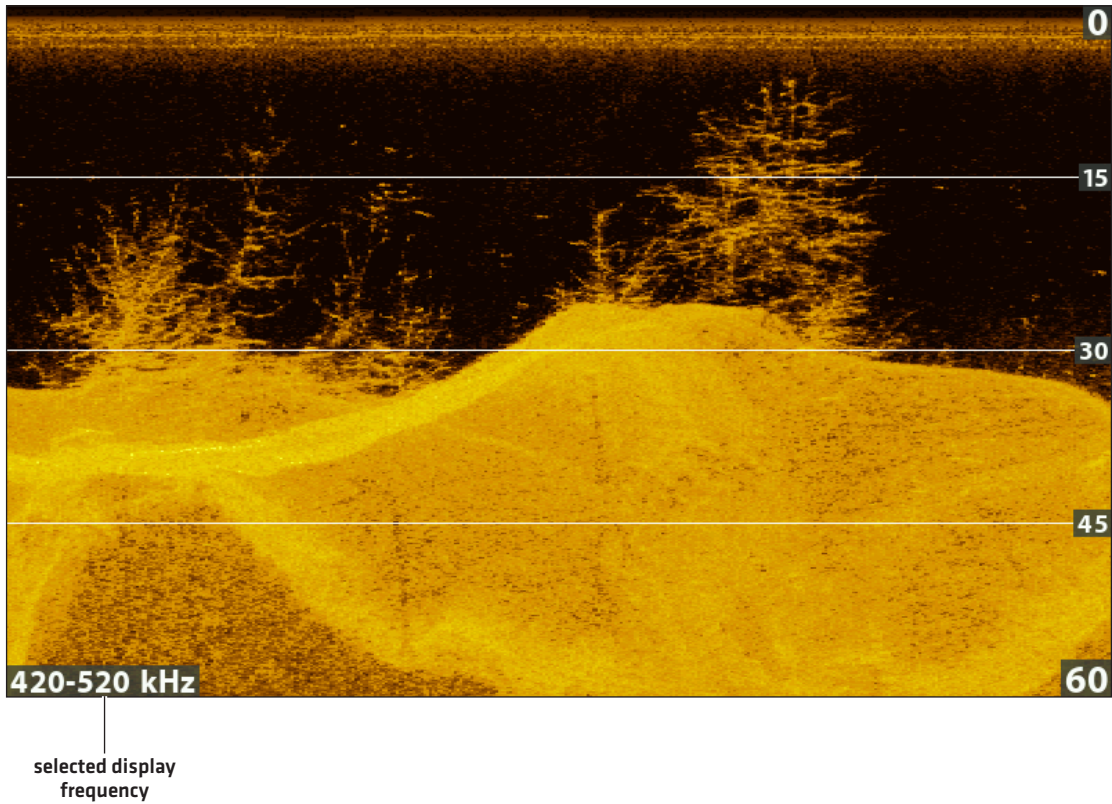


## Show/Hide the Frequency Label

The Frequency Label displays the currently selected frequencies. See **Set up Sonar**.

1. **Main Menu:** Press the MENU key twice. Select the **Sonar** tab.
2. Select Frequency Label.
3. Select On [show] or Off [hide].

**Down Imaging View with the Frequency Label Turned On**

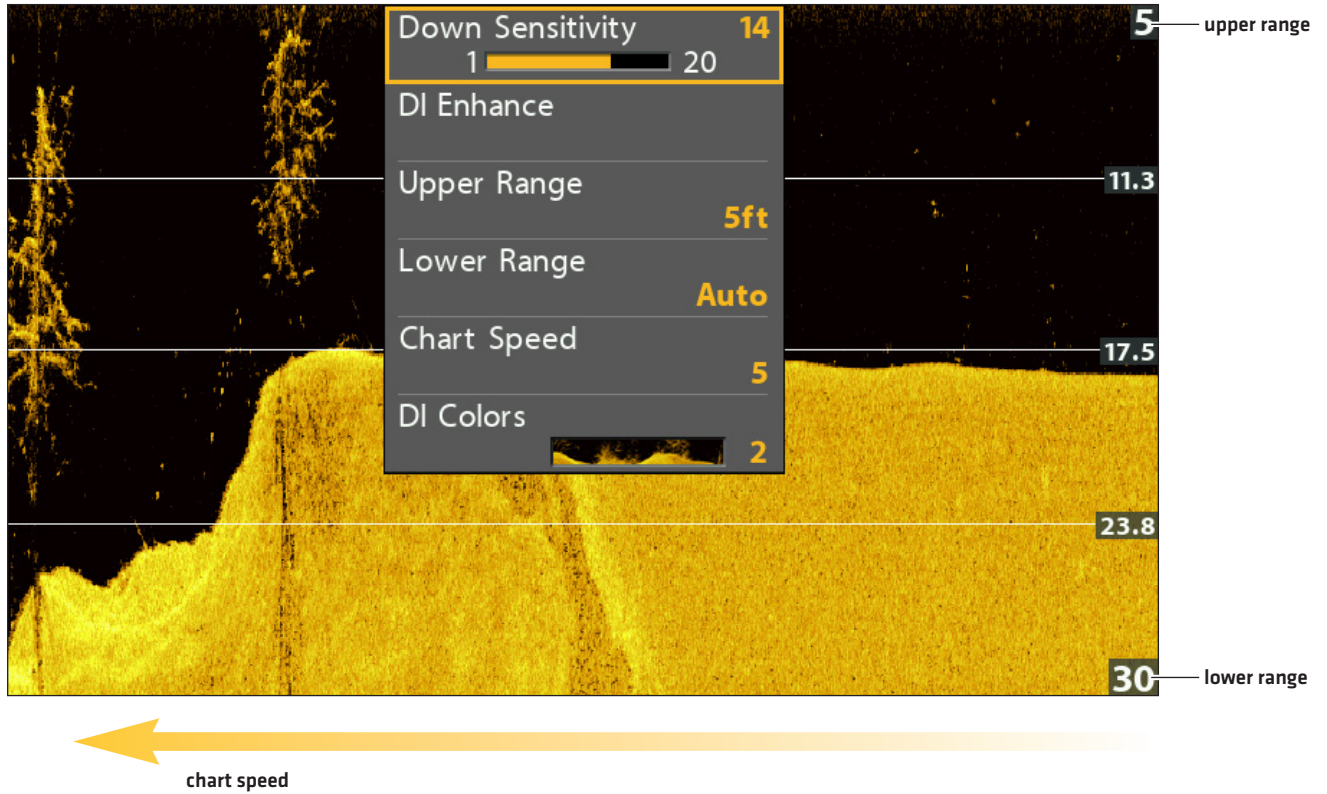


# ADJUST SETTINGS WHILE YOU FISH

(DOWN IMAGING X-PRESS MENU)

The X-Press Menu provides menu options to adjust the sensitivity and range as you fish. You can also control how fast the sonar history scrolls across the screen. The menus allow you to see more or less of the sonar returns from the transducer beams as you adjust each setting. Also, you can use key shortcuts on the view.

Adjusting Settings from the Down Imaging X-Press Menu



## Adjust Sensitivity

Sensitivity controls how much detail is shown on the view. You can adjust sensitivity from the X-Press Menu or the DI Enhance menu [see *Enhance the Down Imaging View*]. The sensitivity can also be adjusted using the +/- ZOOM keys.

**Decrease the sensitivity** to eliminate the clutter from the display that is sometimes present in murky or muddy water. When operating in very clear water or greater depths, **increase the sensitivity** to see weaker returns.

### Adjust the Sensitivity using the X-Press Menu

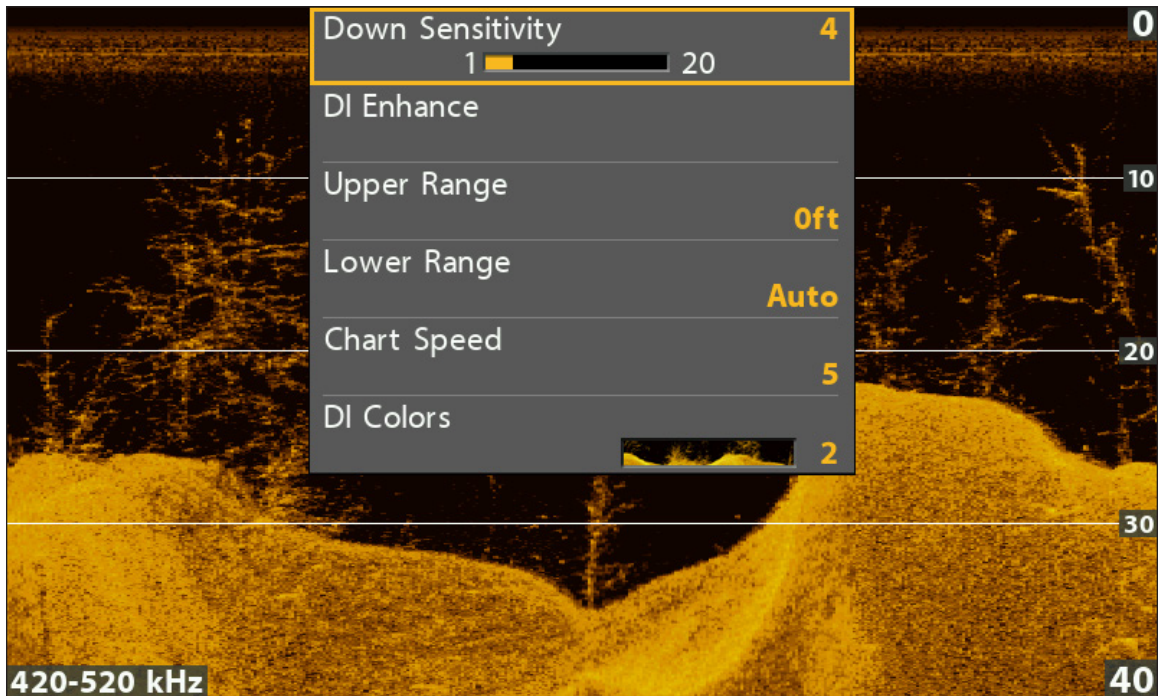
1. **Down Imaging X-Press Menu:** With a Down Imaging View displayed on-screen, press the MENU key once.
2. Select Down Sensitivity.
3. Press the RIGHT or LEFT Cursor keys to increase or decrease the sensitivity.

### Adjust the Sensitivity using the ZOOM Keys

If your control head includes +/-ZOOM keys, you can use them to adjust the sensitivity.

1. With a Sonar View displayed on-screen, press the +ZOOM key or -ZOOM key.

#### Adjusting the Sensitivity using the +/-ZOOM Keys



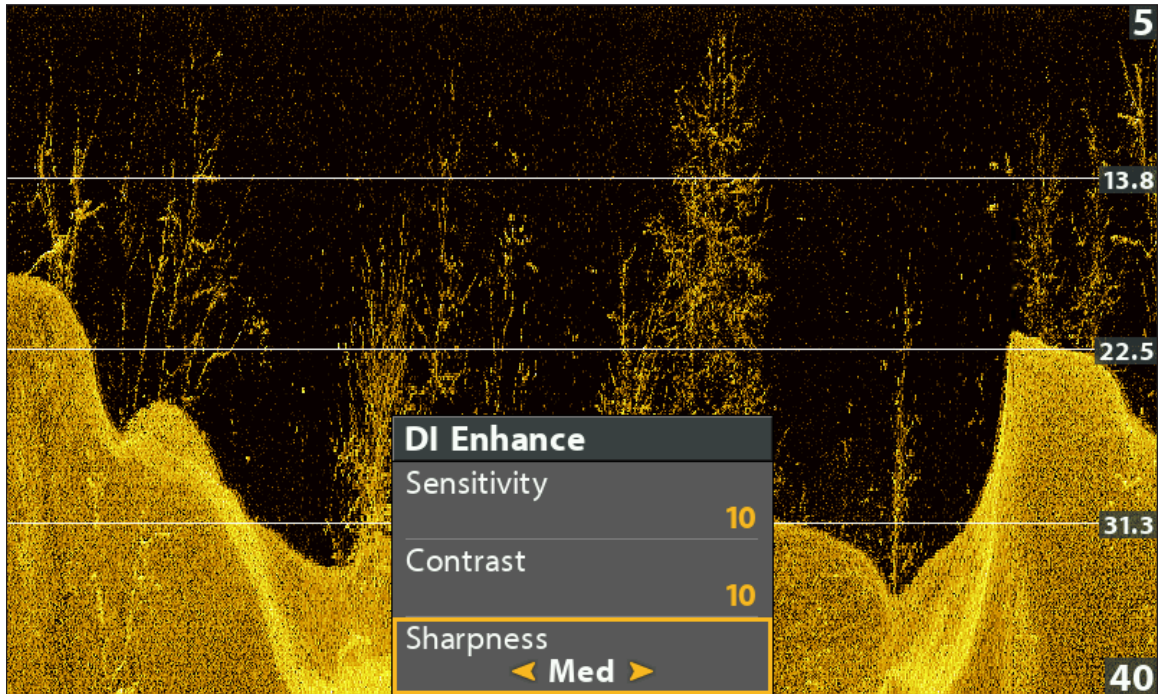
Increase Sensitivity

Decrease Sensitivity

## Enhance the Down Imaging View

The DI Enhance menu allows you to adjust the sensitivity, contrast, and sharpness on the Down Imaging View. As you adjust each setting, the changes are displayed immediately on the view.

### Enhancing the Down Imaging View



### Enhance the Down Imaging View

1. **Down Imaging X-Press Menu:** With a Down Imaging View displayed on-screen, press the MENU key once.
2. Select DI Enhance. Press the RIGHT Cursor key.
3. Use the Cursor Control key to select each menu and adjust the setting.

<p><b>Sensitivity</b></p>	<p>Sensitivity controls how much detail is shown on the view. <b>Decrease the sensitivity</b> to eliminate the clutter from the display that is sometimes present in murky or muddy water. When operating in very clear water or greater depths, <b>increase the sensitivity</b> to see weaker returns that may be of interest. This menu can also be adjusted from the Down Imaging X-Press Menu (DI Sensitivity).</p>
<p><b>Contrast</b></p>	<p>Adjust the Contrast setting to accent the light and dark parts of the Down Imaging data to provide greater definition. To intensify the strong returns, increase the contrast. To intensify the weak returns, decrease the contrast.</p>
<p><b>Sharpness</b></p>	<p>Turn on sharpness and select a filter level to sharpen the edges of the Down Imaging data.</p>

## Set the Upper/Lower Range

Upper Range and Lower Range control how much of the water column is displayed on the view. For example, if you are only interested in the area between 20 and 50 feet deep, set the Upper Range to 20 and the Lower Range to 50. The view will not display sonar returns outside of the set ranges, and greater detail for the selected range will be displayed.

1. **Down Imaging X-Press Menu [Custom User Mode]:** With a Down Imaging View displayed on-screen, press the MENU key once.
2. Select Upper Range. Press the RIGHT or LEFT Cursor keys to adjust the setting.
3. Select Lower Range. Select Auto or set a specific depth [manual].

**Auto:** The Lower Range will be adjusted by the control head to follow the bottom automatically.

**Manual :** The control head locks onto the depth you select.



**NOTE:** There must be a difference of 10 feet between the upper and lower range settings.

## Change the Chart Speed

Chart Speed controls how fast the sonar history moves across the view and how much detail is shown.

1. **Down Imaging X-Press Menu:** With a Down Imaging View displayed on-screen, press the MENU key once.
2. Select Chart Speed.
3. Press the RIGHT or LEFT Cursor keys to adjust the setting.

## Change the DI Colors

The Down Imaging X-Press Menu allows you to quickly change the display palette while you fish. See **Customize the Down Imaging View: Change the View Colors** for more information.

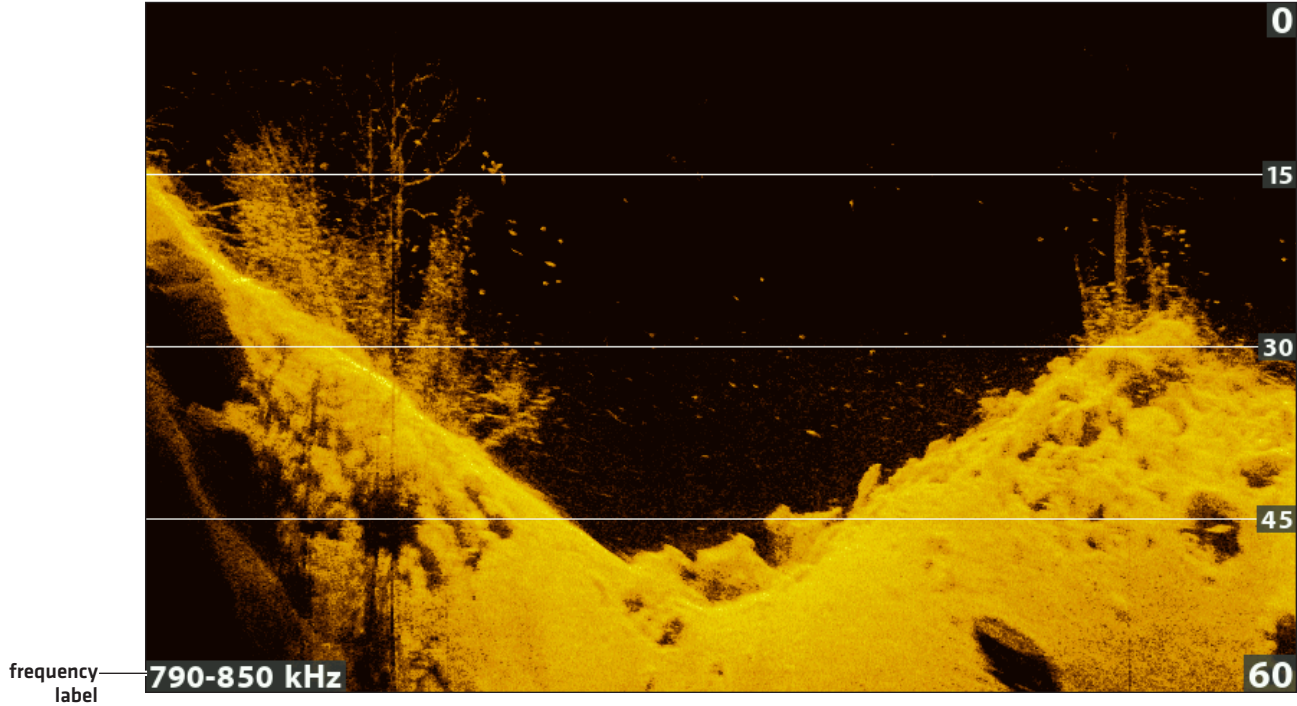
1. **Down Imaging X-Press Menu:** With a Down Imaging View displayed on-screen, press the MENU key once.
2. Select DI Colors.
3. Select a palette.

## Switch Frequencies

If the transducer includes more than one frequency for Down Imaging, use the CHECK/INFO key to quickly change the frequency used in the Down Imaging View. For more information see *Sonar Overview* and *Set up Sonar*.

1. With a Down Imaging View displayed on-screen, press the CHECK/INFO key.

### Using the CHECK key to Switch Frequencies (HELIX 9 CHIRP DI GPS G2N)



Switch Frequencies

## REVIEW DOWN IMAGING HISTORY AND ZOOM IN/OUT

---

In addition to adjusting the sonar settings while you fish, you can freeze the sonar history, magnify sonar returns, and review position information.

### Freeze the Down Imaging View

Press any arrow on the Cursor Control key, and the sonar history will freeze and the cursor will display on-screen. If you move the cursor over a sonar return, digital readouts for the cursor position are displayed on the view.

1. Press any arrow on the Cursor Control key.
2. Move the cursor over a sonar return.
3. Review the cursor position and depth information in the digital readouts.



**NOTE:** To mark a waypoint or start navigation to the cursor position, see **Navigation in Down Imaging Views**.

### Zoom In/Zoom Out using the X-Press Menu

If your control head does not include ZOOM keys, you will use the X-Press menu to magnify a selected part of the view.

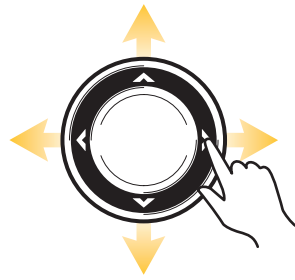
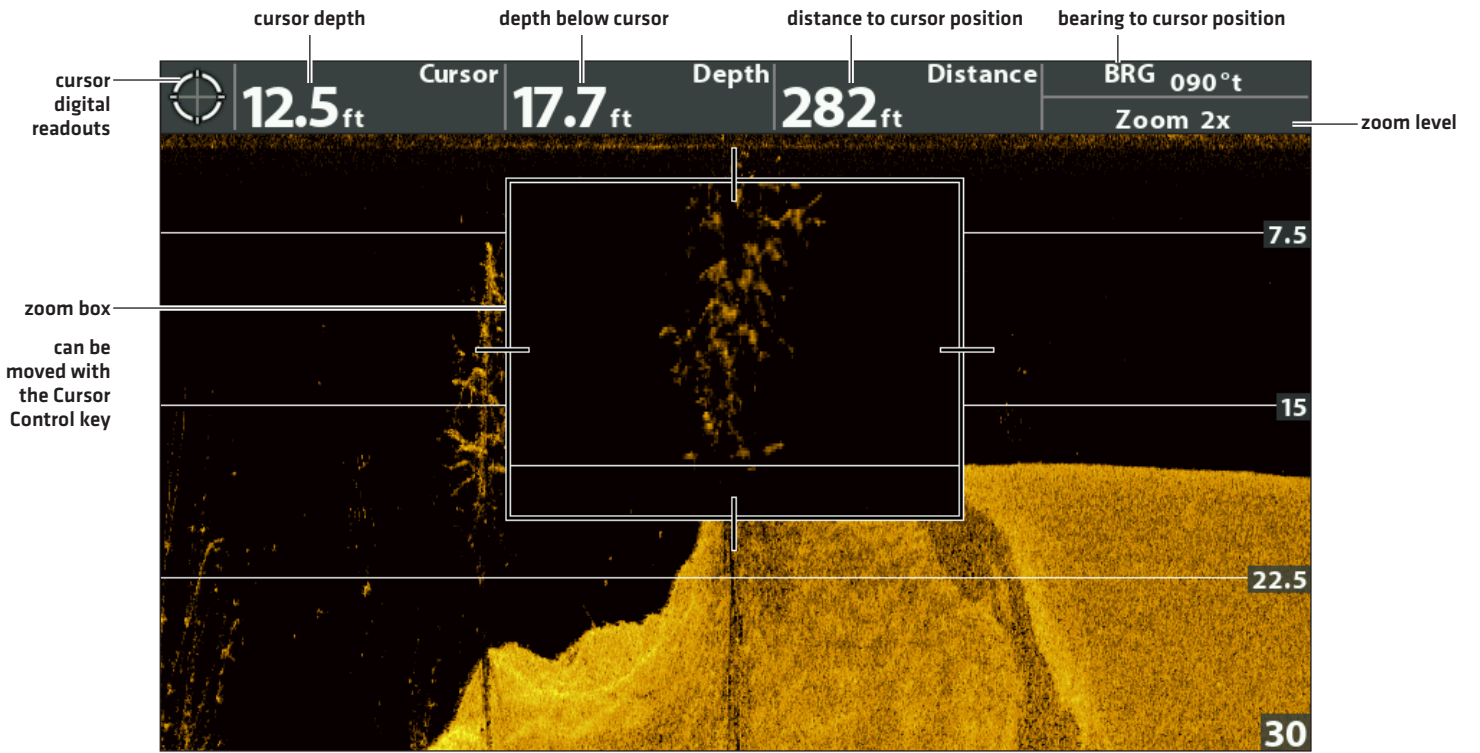
1. Use the Cursor Control key to move the cursor to a position on the view.
2. Press the MENU key once.
3. Select DI Zoom.
4. Press the RIGHT or LEFT Cursor keys to adjust the setting.
5. **Close:** Turn off DI Zoom.

### Zoom In/Zoom Out using the ZOOM Keys

If your control head includes +/-ZOOM keys, use the instructions in this section to magnify the selected part of the view.

1. Use the Cursor Control key to move the cursor to a position on the view.
2. **Zoom In:** Press the +ZOOM key.  
**Zoom Out:** Press the -ZOOM key.
3. **Close:** Press the EXIT key.

### Zooming into the Down Imaging History



Move the Cursor



ZOOM In



ZOOM Out



# NAVIGATION IN DOWN IMAGING VIEWS

To mark waypoints and start navigation, the control head must have a GPS Fix from a connected or internal GPS receiver. See *Getting Started* for more information.

## Mark a Waypoint

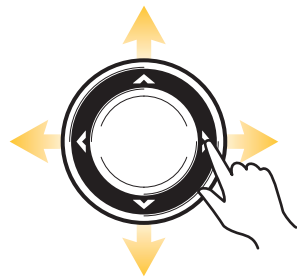
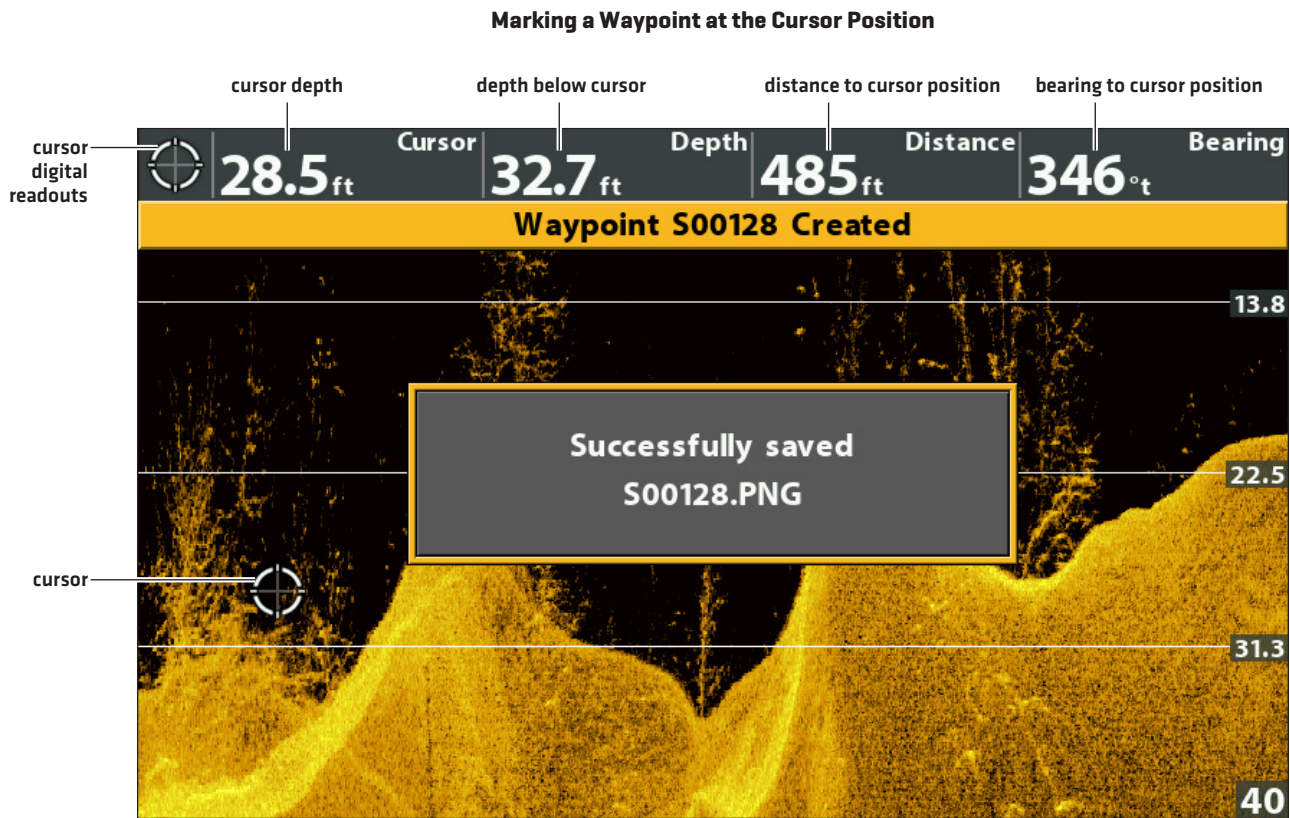
You can mark a waypoint at the boat position or the cursor position. Waypoints are saved to the Waypoint Management dialog box [see *Manage your Navigation Data*].

### Mark a Waypoint at the Boat Position

1. Press the MARK key.

### Mark a Waypoint at the Cursor Position

1. Use the Cursor Control key to move the cursor to a position on the view.
2. Press the MARK key twice.



Move the Cursor



Press Twice to Mark a Waypoint

## Navigate to a Position

Use the instructions in this section to start navigation to a position in the view. See *Navigation Overview* for more information about these features.

### Navigate to the Cursor Position

1. Use the Cursor Control key to move the cursor to a position on the view.
2. Press the GOTO key twice.

When you press the GOTO key, a waypoint will be marked at the cursor position.

### Navigate to a Saved Position

If you press the GOTO key, you can choose to start navigation from a list of saved waypoints and routes.

1. Press the GOTO key.
2. Select Nav Data. Press the RIGHT Cursor key.
3. Use the Cursor Control key to select a saved waypoint or route.
4. Press the RIGHT Cursor key to start navigation.

### Cancel Navigation

1. Press the MENU key once.
2. Select Cancel Navigation. Press the RIGHT Cursor key.

## DISPLAY A SIDE IMAGING VIEW ON-SCREEN

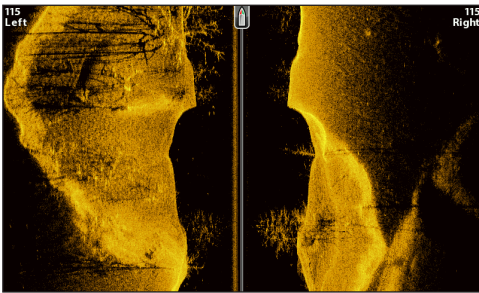
(CHIRP SI, CHIRP MEGA SI, CHIRP MEGA SI+ ONLY)

There are a variety of views available to display Side Imaging data. You can also customize the view by showing or hiding information [see *Customize the Side Imaging View*], and you can adjust the sonar settings to maximize the information displayed on-screen [see *Adjust Settings While you Fish*]. The changes you make are applied to all Side Imaging views.

### Display a Side Imaging View

1. Press and hold the VIEW key.
2. Select Sonar > Side Imaging View.

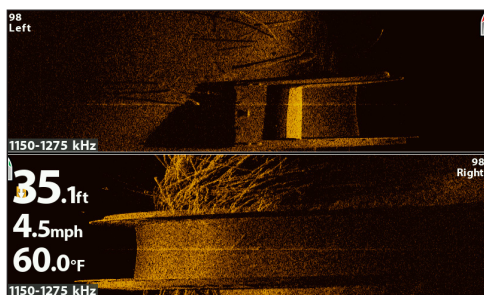
#### Side Imaging View



### Display a Side Imaging Combo View

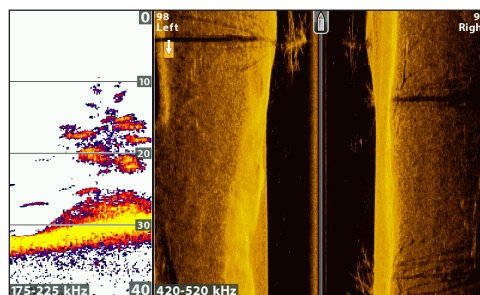
1. Press and hold the VIEW key.
2. To open a Side Imaging Combo View, select Sonar.  
To open a Chart Combo View [Side Imaging and Chart together], select Chart.
3. Select a view to display on-screen. Press the RIGHT Cursor key.

#### Sonar > Side/Side Combo View



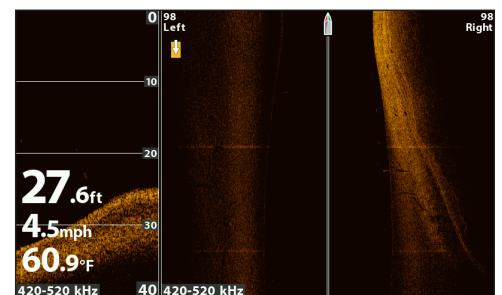
For more information, see  
*Adjust Settings While you Fish: Display Beams.*

#### Sonar > Side/Sonar Combo View



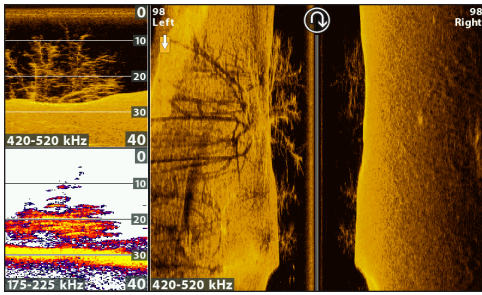
For more information, see  
the *Sonar* section.

#### Sonar > Down/Side Combo View



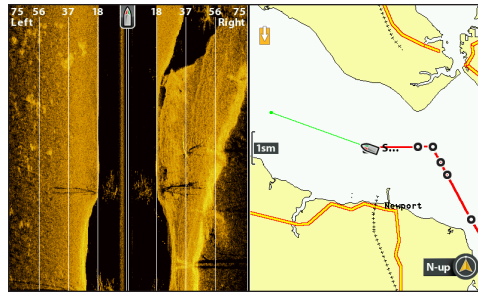
For more information, see  
the *Down Imaging* section.

### Sonar > Down/Side/Sonar Combo View



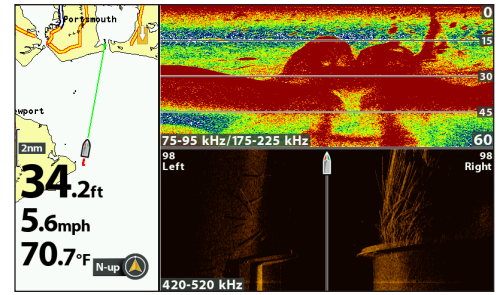
For more information, see the *Sonar* and *Down Imaging* sections.

### Chart > Chart/Side Combo View [Map Source: Contour XD]



For more information, see *Navigation Overview*.

### Chart > Chart/Sonar/Side Combo View [Map Source: Contour XD]



For more information, see the *Sonar* and *Navigation* sections.



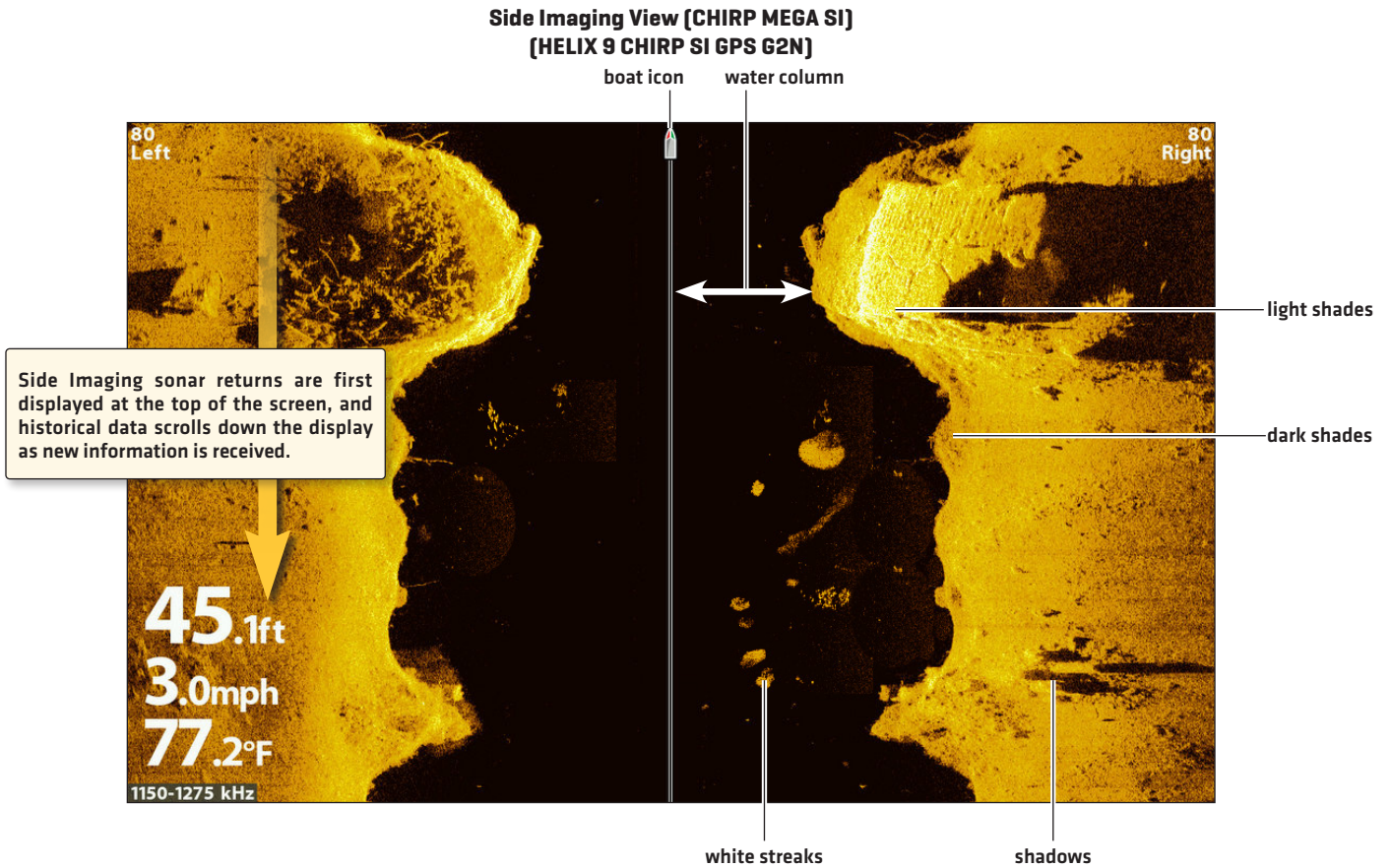
**NOTE:** The available views are determined by your control head model and the installed transducer. For a complete list of the views available on your control head, press the MENU key twice, and select the Views tab. See each related section of the manual [*Views*, *Sonar*, *Down Imaging*, *Navigation Overview*, etc.] for more information.

# UNDERSTAND THE SIDE IMAGING VIEW

Side Imaging beams “illuminate” the bottom contour, structure, and fish. The side beam coverage is very thin from front to back, yet very wide from top to bottom. The bottom composition determines the intensity of the sonar return, and upward slopes that face the transducer reflect sonar better than downward slopes that face away from the transducer.

## For Best Side Imaging Performance

- Boat Speed: trolling
- Straight line navigation
- Minimum turning time and wave turbulence



Use the light and dark parts of the display to interpret the objects on the view as follows:

**Shadows:** The longer the shadow, the taller the object. Fish also cast shadows, and their distance from the bottom can be interpreted by their shadow.

**Light Shades** represent denser terrain [possibly compacted sediment, timber, rocks] or rising terrain.

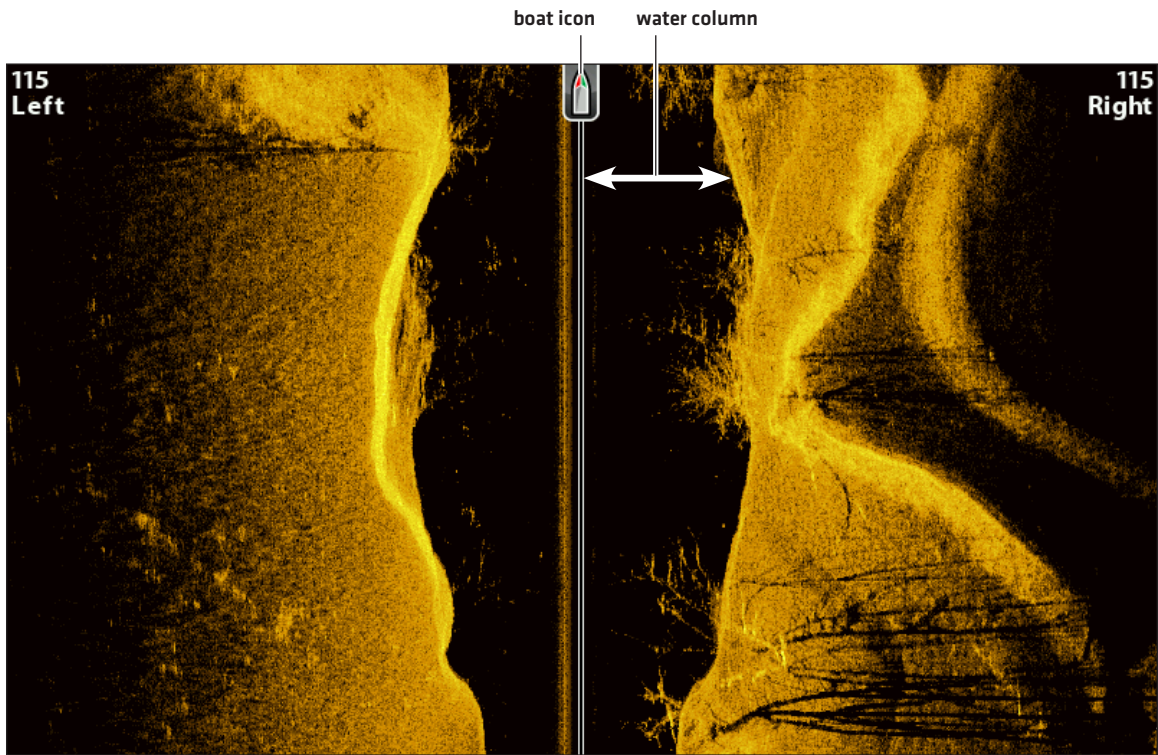
**Water Column:** shows the relative depth of the water under the boat at any given time. Variations in the width of the water column show variations in the distance to the bottom as the boat passes over. See the illustration *Interpreting the Side Imaging View*.

**White Streaks** or **Clouds** may represent fish on the display.

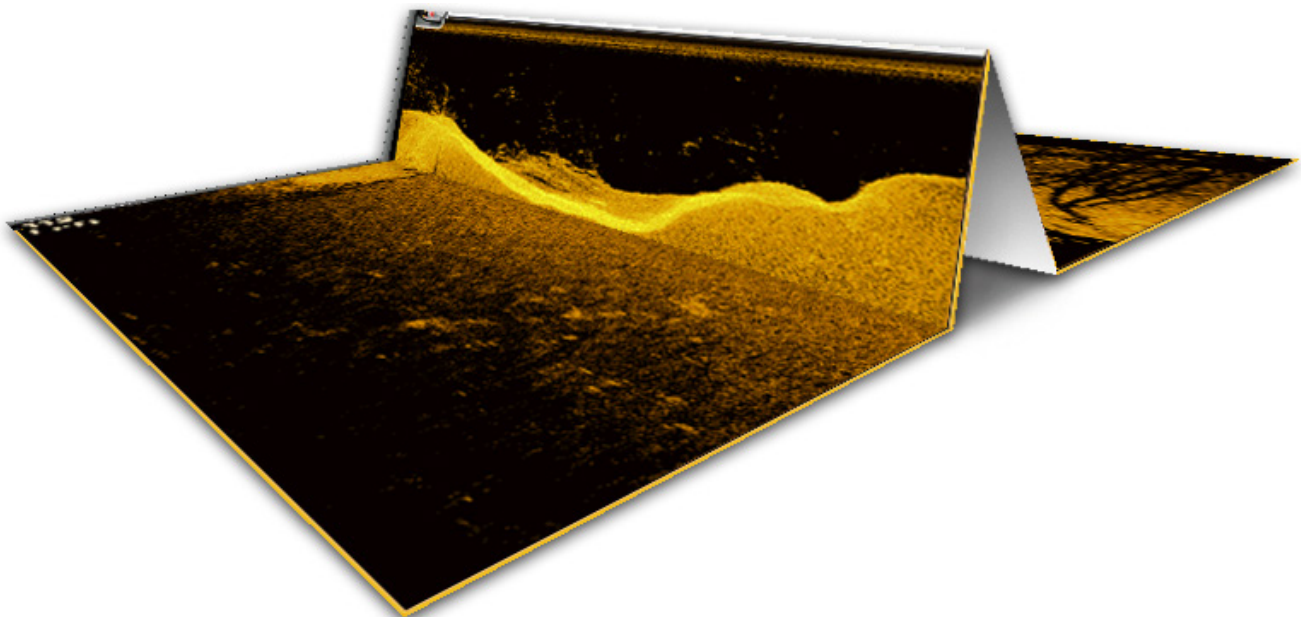
**Dark Shades** represent soft returns [possibly sand or mud] or descending terrain.

To visualize how Side Imaging works, the Side Imaging View illustration can be folded down the middle and then folded again at the lowest point of the water column. The raised area reveals the water column with its relative depth of the water under the boat. In the Side Imaging View, variations in the width of the water column show variations in the distance to the bottom as the boat passes over.

### Side Imaging View



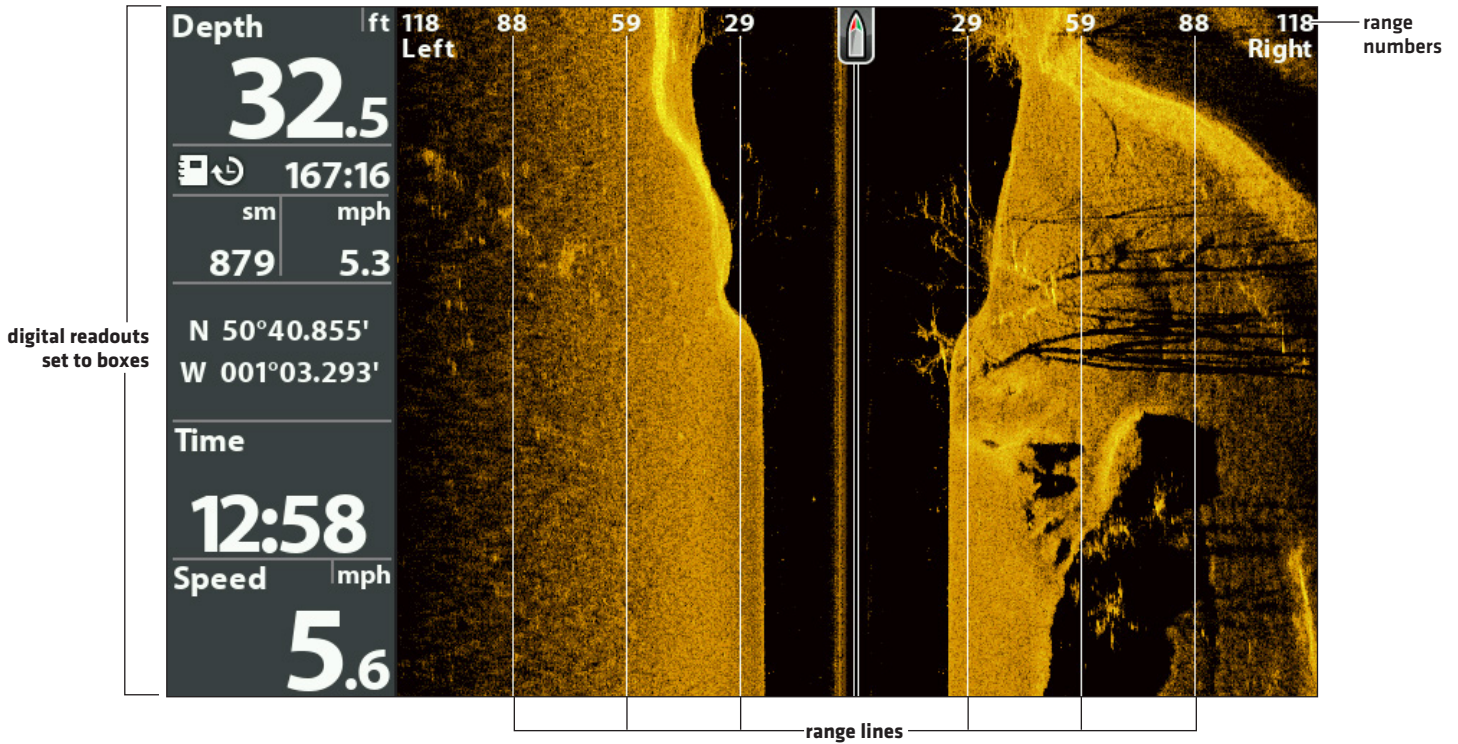
### Interpreting the Side Imaging View



# CUSTOMIZE THE SIDE IMAGING VIEW

The settings in this section are optional. You can use the default settings for the view, or you can customize it with your preferences.

## Showing Digital Readouts and SI Range Lines



### Show/Hide SI Range Lines

SI Range Lines divide each side beam range into equal sections on the Side Imaging View. Use the range lines to estimate the location of objects. You can show or hide range lines on the view.

**NOTE:** The range numbers are estimated and should not be used for measurement. If SI Range Lines and Contour Mode are turned on, the SI Range Lines will remain on the display, but the individual range numbers will not be available.

1. **Main Menu:** Press the MENU key twice. Select the **Sonar** tab.
2. Select SI Range Lines.
3. Select On [show] or Off [hide].

### Show/Hide Digital Readouts on the Side Imaging View

If you have Digital Readouts set to Boxes on all views, you can hide the digital readout boxes on the Side Imaging View exclusively. For details, see **Views: Display Digital Readouts**.

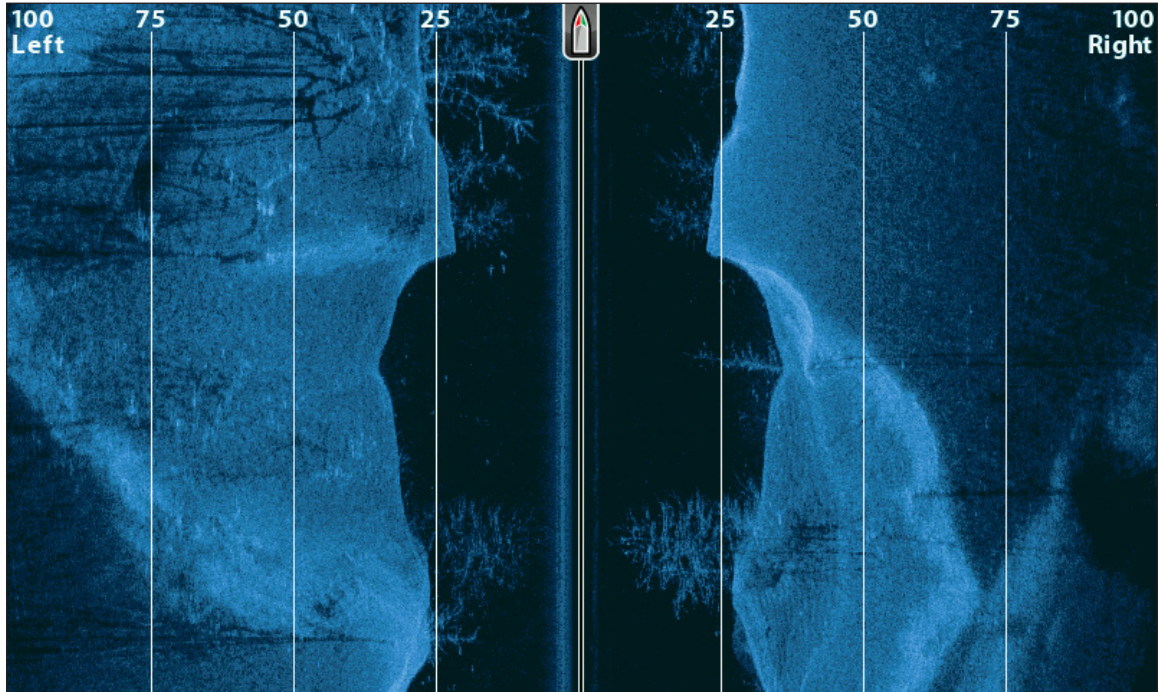
1. **Main Menu:** Press the MENU key twice. Select the **Sonar** tab.
2. Select SI Readouts.
3. Select On [show] or Off [hide].

## Change the View Colors

The SI Colors menu changes the colors used to display sonar returns on the view.

1. **Side Imaging X-Press Menu:** With a Side Imaging View displayed on-screen, press the MENU key once.
2. Select SI Colors.
3. Select a palette.

**Side Imaging View with Palette 1 Displayed**



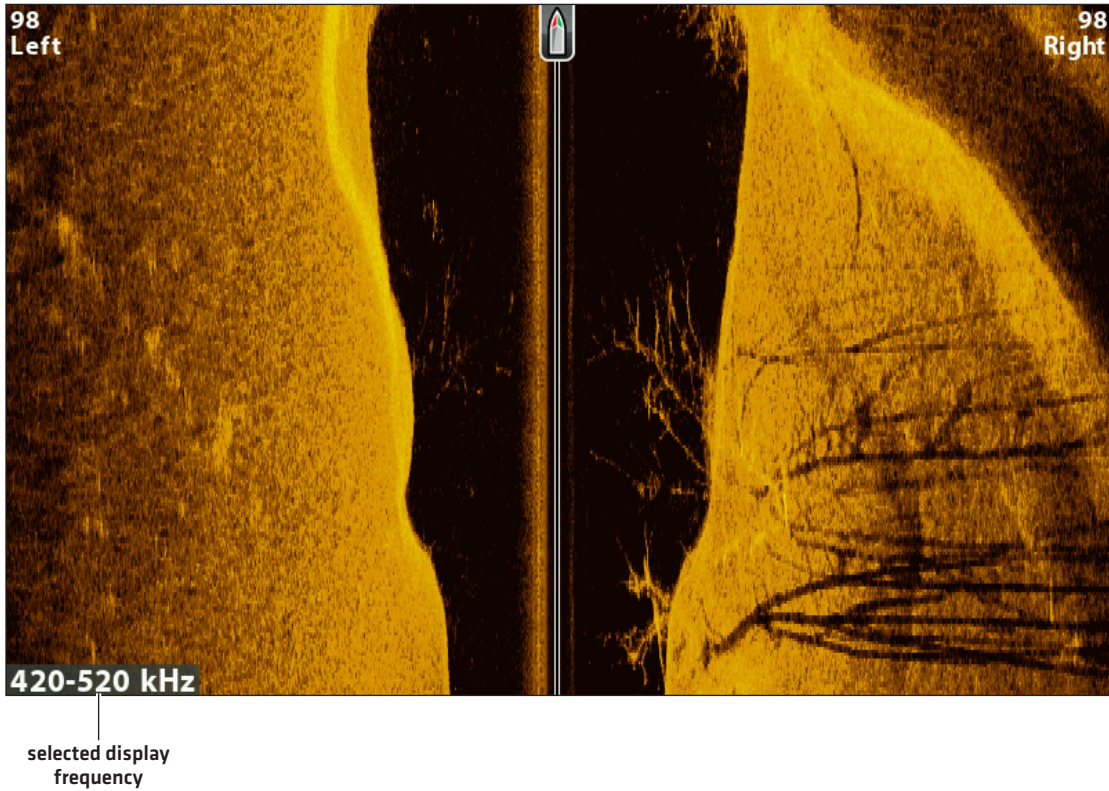


## Show/Hide the Frequency Label

The Frequency Label displays the currently selected frequencies. See **Set up Sonar**.

1. **Main Menu:** Press the MENU key twice. Select the **Sonar** tab.
2. Select Frequency Label.
3. Select On [show] or Off [hide].

### Side Imaging View with the Frequency Label Turned On



The X-Press Menu provides menu options to adjust the sensitivity and range as you fish. You can also control how fast the sonar history scrolls down the screen. The menu options allow you to see more or less of the sonar returns from the transducer beams as you adjust each setting. Also, you can use key shortcuts on the view.

### Adjust Sensitivity

Sensitivity controls how much detail is shown on the view. You can adjust sensitivity from the X-Press Menu or the Enhance menu [see *Enhance the Side Imaging View*]. The sensitivity can also be adjusted using the +/- ZOOM keys.

**Decrease the sensitivity** to eliminate the clutter from the display that is sometimes present in murky or muddy water. When operating in very clear water or greater depths, **increase the sensitivity** to see weaker returns.

### Adjust the Sensitivity using the X-Press Menu

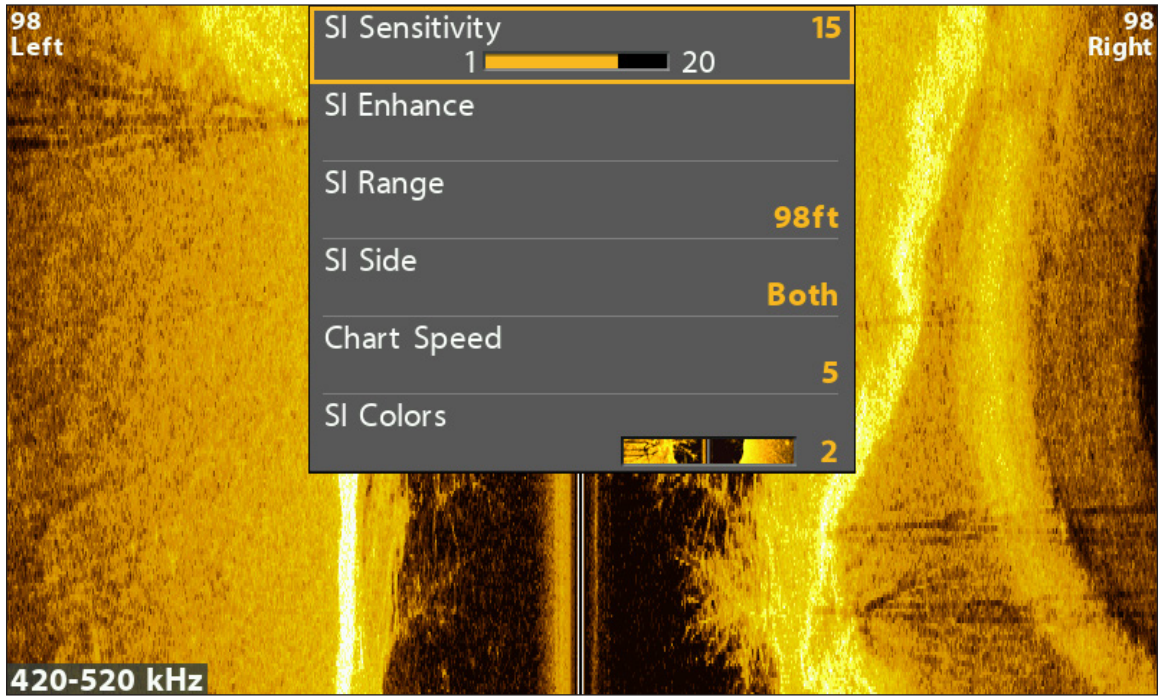
1. **Side Imaging X-Press Menu:** With a Side Imaging View displayed on-screen, press the MENU key once.
2. Select SI Sensitivity.
3. Press the RIGHT or LEFT Cursor keys to increase or decrease the sensitivity.

### Adjust the Sensitivity using the ZOOM Keys

If your control head includes +/-ZOOM keys, you can use them to adjust the sensitivity.

1. With a Sonar View displayed on-screen, press the +ZOOM key or -ZOOM key.

### Adjusting the Sensitivity using the +/-ZOOM Keys



Increase Sensitivity

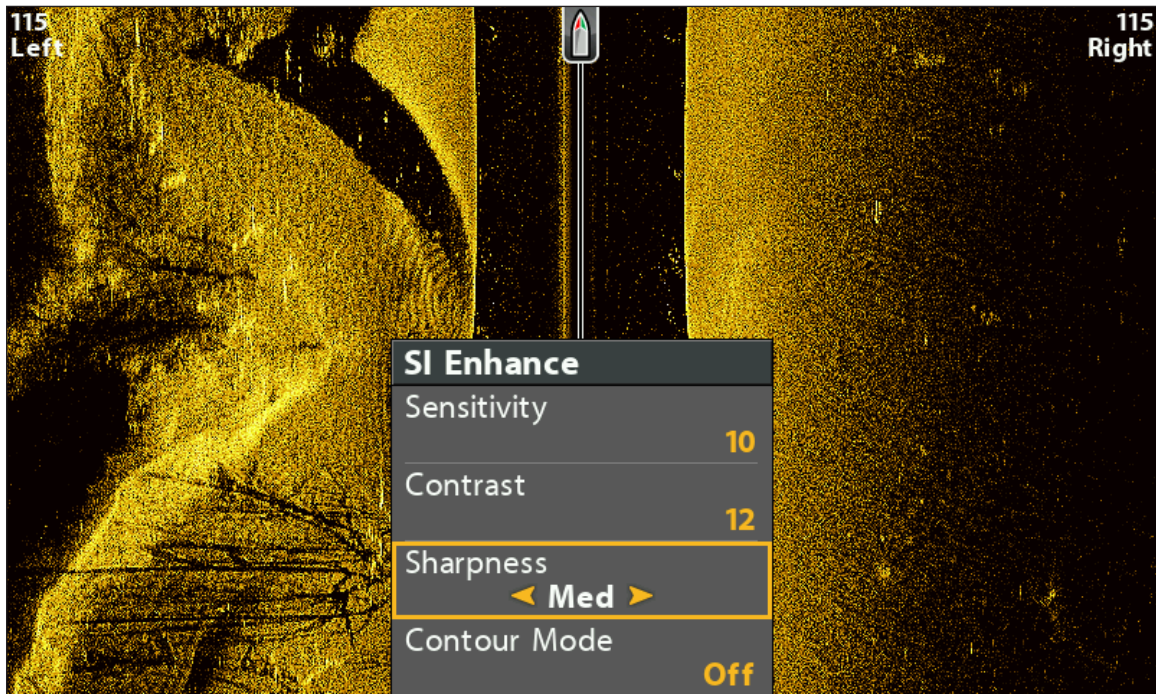


Decrease Sensitivity

## Enhance the Side Imaging View

The SI Enhance menu allows you to adjust the sensitivity, contrast, and sharpness on the Side Imaging View. As you adjust each setting, the changes are displayed immediately on the view, so you can fine tune the display. You can also turn on/off the Contour Mode from this menu so the water column is displayed or hidden on the view.

### Enhancing the Side Imaging View

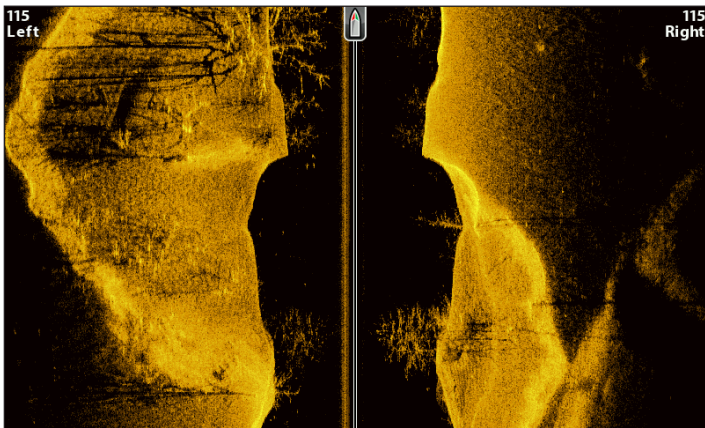


### Enhance the Side Imaging View

1. **Side Imaging X-Press Menu:** With a Side Imaging View displayed on-screen, press the MENU key once.
2. Select SI Enhance. Press the RIGHT Cursor key.
3. Use the Cursor Control key to select each menu and adjust the setting.

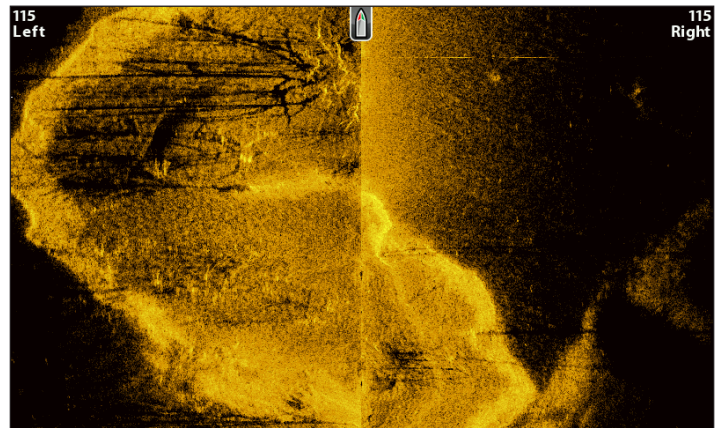
<p><b>Sensitivity</b></p>	<p>Sensitivity controls how much detail is shown on the view. <b>Decrease the sensitivity</b> to eliminate the clutter from the display that is sometimes present in murky or muddy water. When operating in very clear water or greater depths, <b>increase the sensitivity</b> to see weaker returns that may be of interest. This menu can also be adjusted from the Side Imaging X-Press Menu [SI Sensitivity].</p>
<p><b>Contrast</b></p>	<p>Adjust the Contrast setting to accent the light and dark parts of the Side Imaging data to provide greater definition. To intensify the strong returns, increase the contrast. To intensify the weak returns, decrease the contrast.</p>
<p><b>Sharpness</b></p>	<p>Turn on sharpness and select a filter level to sharpen the edges of the Side Imaging data.</p>
<p><b>Contour Mode</b></p>	<p>Contour Mode controls how the water column is displayed in the Side Imaging Views. <b>When Contour Mode is turned off</b>, the water column is displayed on the view. The location of a target on the display is based on the slant range to the target.</p> <p><b>When Contour Mode is turned on</b>, the bottom is graphed at a constant point on the display, regardless of changes in depth. The Side Imaging beams are divided by a vertical line. The water column is removed from the view, which allows the display to show targets at their linear horizontal distance. The location of a target may be easier to interpret when the water column is removed.</p>

**Contour Mode Off**



The water column is displayed on the Side Imaging View.

**Contour Mode On**



The water column is removed from the Side Imaging View.

## Adjust the Side Imaging Range

SI Range sets the deepest range that will be displayed on the Side Imaging views. Choose a low range number to focus on a shorter distance of the water column and see greater detail on the view. Choose a higher range number to see farther into the water and see an overview of details on the screen.

1. **Side Imaging X-Press Menu:** With a Side Imaging View displayed on-screen, press the MENU key once.
2. Select SI Range.

**Auto:** The Range will be adjusted by the control head to follow the bottom automatically.

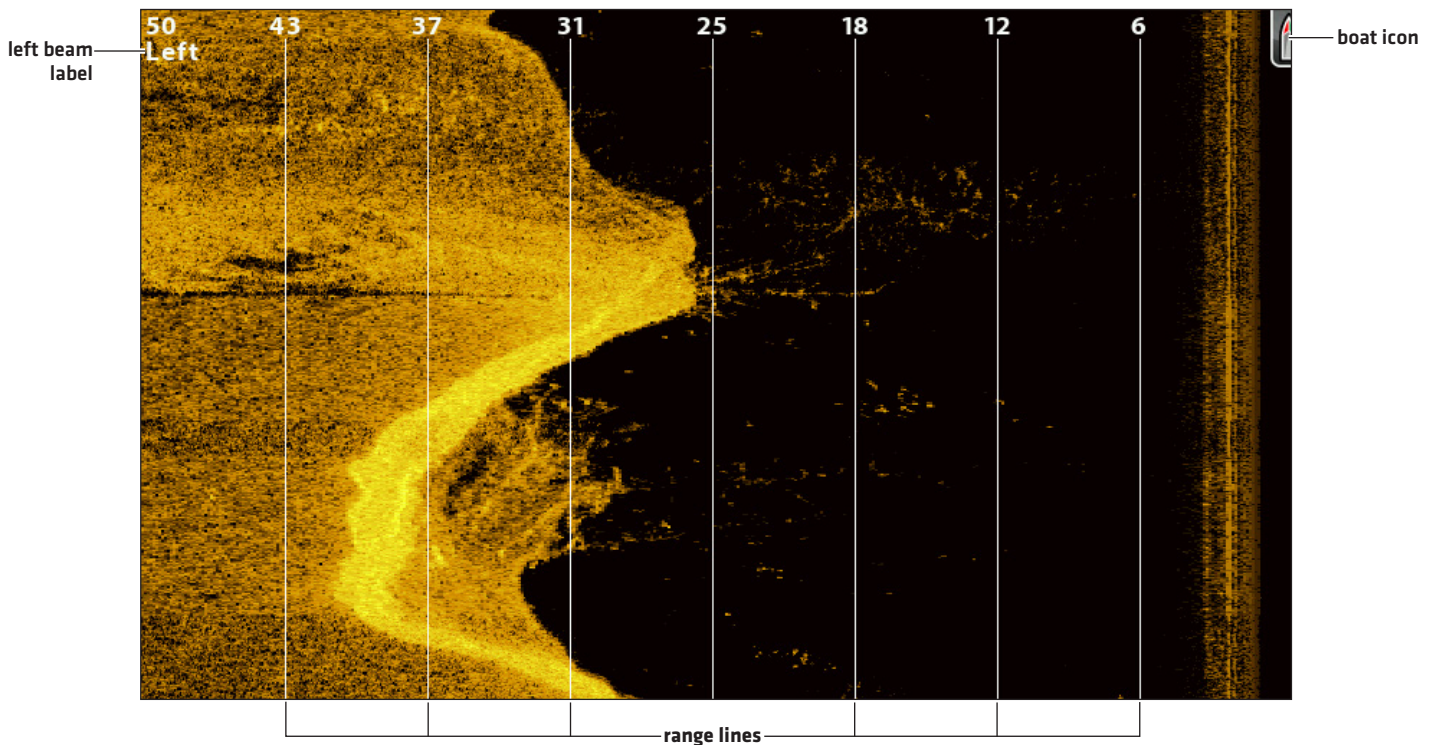
**Manual:** The control head locks onto the depth you select.

**Side Imaging units** default to the Side Imaging range setting if the **SI Range** is set deeper than the Max Depth. See **Set up Sonar** for more information.

## Display Beams

Use SI Side to select which Side Imaging beam will be shown on the display.

Side Imaging View with the Left Beam Displayed



## Select Beams to Display on the View

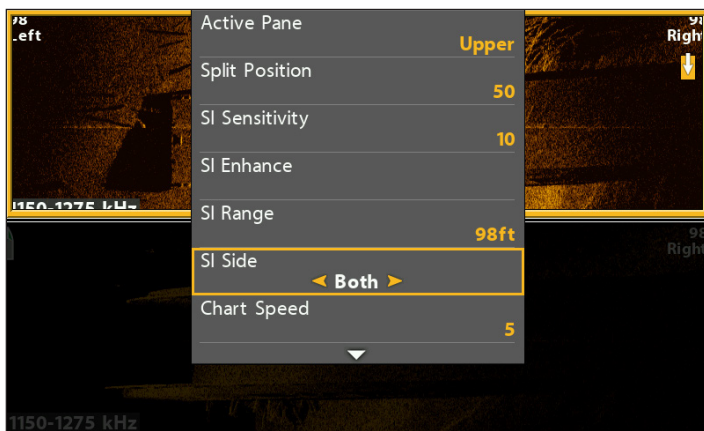
1. **Side Imaging X-Press Menu:** With a Side Imaging View displayed on-screen, press the MENU key once.
2. Select SI Side.
3. Select a beam or both beams to display.

## Select Beams to Display on the Side/Side Combo View

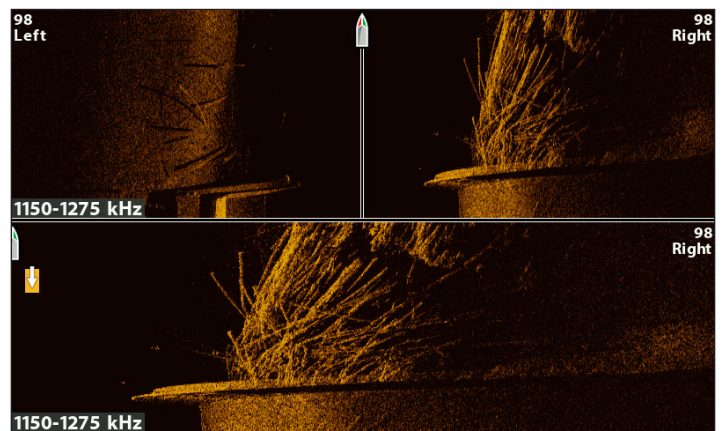
Use the Side/Side Combo View to focus on each side or one side.

1. Press and hold the VIEW key.
2. Select Sonar > Side/Side Combo View.
3. Press the RIGHT Cursor key.
4. **X-Press Menu:** Press the MENU key once.
5. Select Active Pane.
6. Select Upper or Lower.
7. Select SI Side.
8. Select a beam or both beams to display.

### Selecting Both Beams for the Upper Active Pane



### Side/Side Combo View (CHIRP MEGA SI)



## Change the Chart Speed

Chart Speed controls how fast the sonar history moves down the view and how much detail is shown.

1. **Side Imaging X-Press Menu:** With a Side Imaging View displayed on-screen, press the MENU key once.
2. Select Chart Speed.
3. Press the RIGHT or LEFT Cursor keys to adjust the setting.

## Change the View Colors

The Side Imaging X-Press Menu allows you to quickly change the display palette while you fish. See *Customize the Side Imaging View: Change the View Colors* for more information.

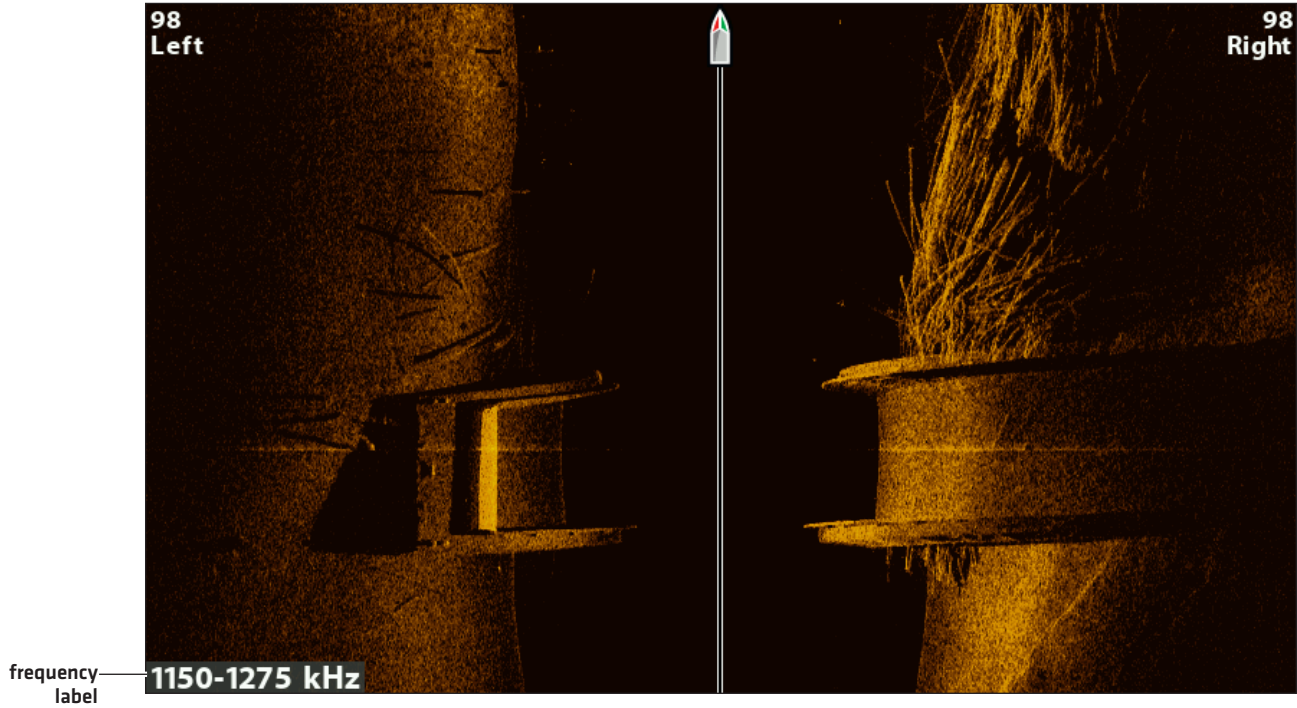
1. **Side Imaging X-Press Menu:** With a Side Imaging View displayed on-screen, press the MENU key once.
2. Select SI Colors.
3. Select a palette.

## Switch Frequencies (CHIRP MEGA SI, CHIRP MEGA SI+ models only)

If the transducer includes more than one Side Imaging frequency, use the CHECK/INFO key to quickly change the frequency used in the Side Imaging View. For more information see *Sonar Overview* and *Set up Sonar*.

1. With a Side Imaging View displayed on-screen, press the CHECK/INFO key.

### Using the CHECK key to Switch Frequencies (CHIRP MEGA SI) (HELIX 9 CHIRP SI GPS G2N)



Switch Frequencies



## REVIEW SIDE IMAGING HISTORY AND ZOOM IN/OUT

---

In addition to adjusting the sonar settings while you fish, you can freeze the sonar history, magnify sonar returns, and review position information.

### Freeze the Side Imaging View

Press any arrow on the Cursor Control key, and the sonar history will freeze and the cursor will display on-screen. If you move the cursor over a sonar return, digital readouts for the cursor position are displayed on the view.

1. Press any arrow on the Cursor Control key.
2. Move the cursor over a sonar return.
3. Review the cursor position and depth information in the digital readouts.



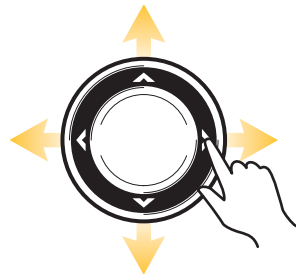
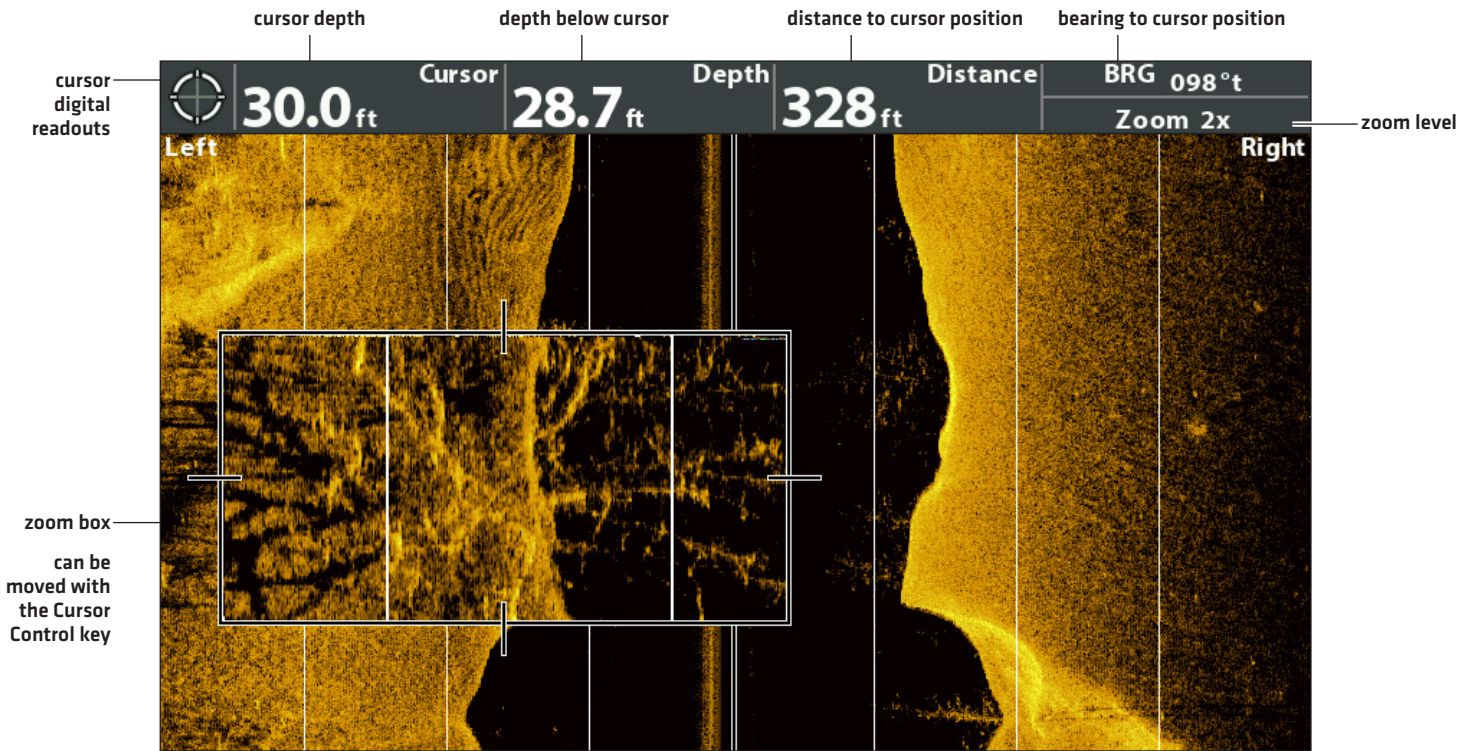
**NOTE:** To mark a waypoint or start navigation to the cursor position, see *Navigation in Side Imaging Views*.

### Zoom In/Zoom Out

To take a closer look, use the ZOOM keys to magnify the selected part of the view.

1. Use the Cursor Control key to move the cursor to a position on the view.
2. **Zoom In:** Press the +ZOOM key.  
**Zoom Out:** Press the -ZOOM key.
3. **Close:** Press the EXIT key.

## Zooming In/Out



Move the Cursor



ZOOM In



ZOOM Out

# NAVIGATION IN SIDE IMAGING VIEWS

---

To mark waypoints and start navigation, the control head must have a GPS Fix from a connected or internal GPS receiver. See *Getting Started* for more information.

## Turn on/off SI Navigation

SI Navigation controls how the boat icon is displayed in Side Imaging Views. See *Navigate to a Position* for more information. **If SI Navigation is turned on**, an arrow icon indicates the direction the boat needs to turn to reach the next waypoint during navigation.

**If SI Navigation is turned off**, the boat icon will not change during navigation although you can still mark waypoints and start navigation from a Side Imaging View.

1. **Main Menu:** Press the MENU key twice. Select the **Nav** tab.
2. Select SI Navigation.
3. Select On or Off.

## Mark a Waypoint

You can mark a waypoint at the boat position or the cursor position. Waypoints are saved to the Waypoint Management dialog box [see *Manage your Navigation Data*].

### Mark a Waypoint at the Boat Position

1. Press the MARK key.

### Mark a Waypoint at the Cursor Position

1. Use the Cursor Control key to move the cursor to a position on the view.
2. Press the MARK key twice.

## Navigate to a Position

Use the instructions in this section to start navigation to a position in the view. See *Navigation Overview* for more information about these features.

### Navigate to the Cursor Position

1. Use the Cursor Control key to move the cursor to a position on the view.
2. Press the GOTO key twice.

When you press the GOTO key, a waypoint will be marked at the cursor position.

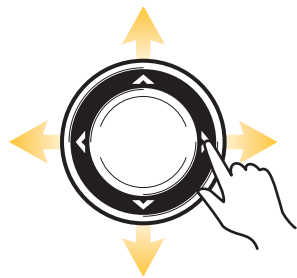
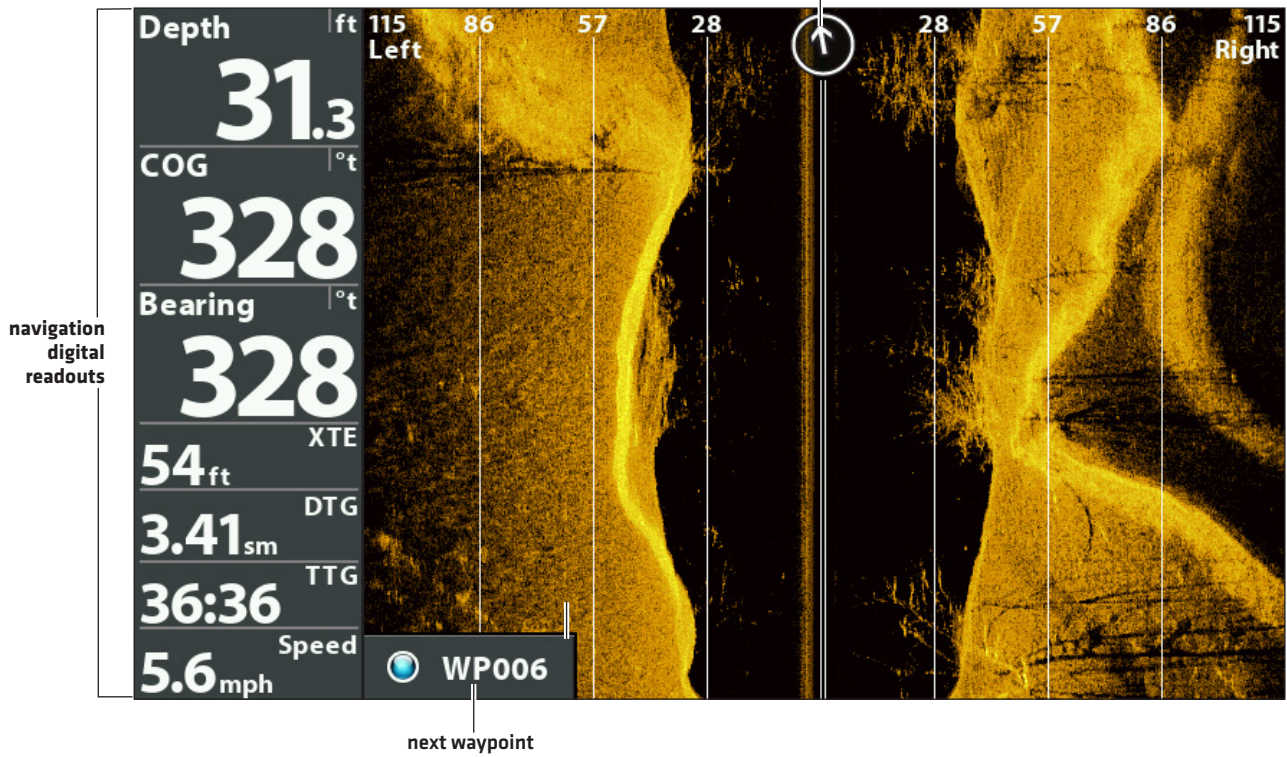
### Navigate to a Saved Position

If you press the GOTO key, you can choose to start navigation from a list of saved waypoints and routes.

1. Press the GOTO key.
2. Select Nav Data. Press the RIGHT Cursor key.
3. Use the Cursor Control key to select a saved waypoint or route.
4. Press the RIGHT Cursor key to start navigation.

## Navigating to a Waypoint

direction to turn the boat to reach the next waypoint (SI Navigation On)



Move the Cursor



Press Twice to Start Navigation

## Cancel Navigation

1. Press the MENU key once.
2. Select Cancel Navigation. Press the RIGHT Cursor key.

# ICE FISHING OVERVIEW

## (ICE HELIX CHIRP, HELIX 5 AND 7 G2/G2N, HELIX 7 G3 AND HELIX 7, 8, 9 AND 10 G3N MODELS ONLY)

If you have a compatible CHIRP model and want to use it for ice fishing, Ice Fishing mode must be turned on. To enable Ice Fishing mode, see the instructions below.

### Turn on Ice Fishing Mode

If you have an ICE HELIX CHIRP model, proceed to **Display the Flasher View On-Screen**.

1. **Preparation:** Confirm your control head software is up to date. See **Update Software**.
2. **Main Menu:** Press the MENU key twice. Select the **Sonar** tab.
3. Select Ice Fishing.
4. Press the RIGHT Cursor key.

The control head will automatically restart.

To return to Open Water mode, repeat step 2 and select Open Water.

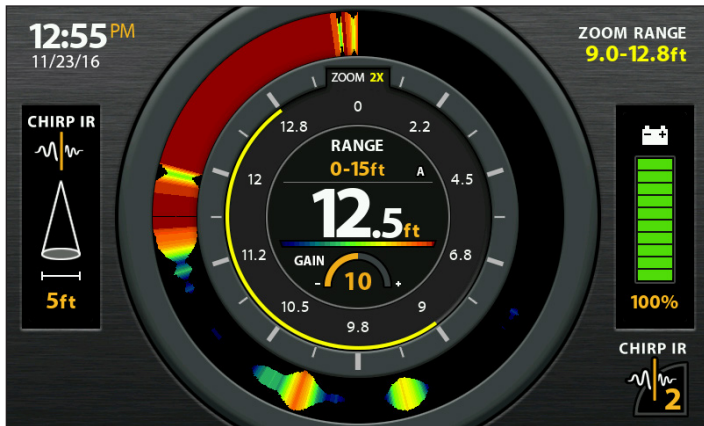
## DISPLAY THE FLASHER VIEW ON-SCREEN

Flasher View provides two ways to view sonar data in traditional flasher format. The view is available on ICE HELIX CHIRP models and compatible HELIX 5 and 7 G2/G2N, HELIX 7 G3 and HELIX 7, 8, 9 and 10 G3N models with Ice Fishing mode turned on.

### Display the Flasher View

1. Press and hold the VIEW key.
2. Select Sonar > Flasher View.

**Flasher View with CHIRP IR Turned On  
(CHIRP models only)**



**Flasher View  
(HELIX models without CHIRP)**



### Select the Digital Depth Source (DI, CHIRP DI models only)

If you connect an ice transducer to the HELIX DI G2, HELIX CHIRP DI G2, or HELIX CHIRP DI GPS G2/G2N control head, set the Digital Depth Source to 2D Element. See **Set up Sonar** for details.

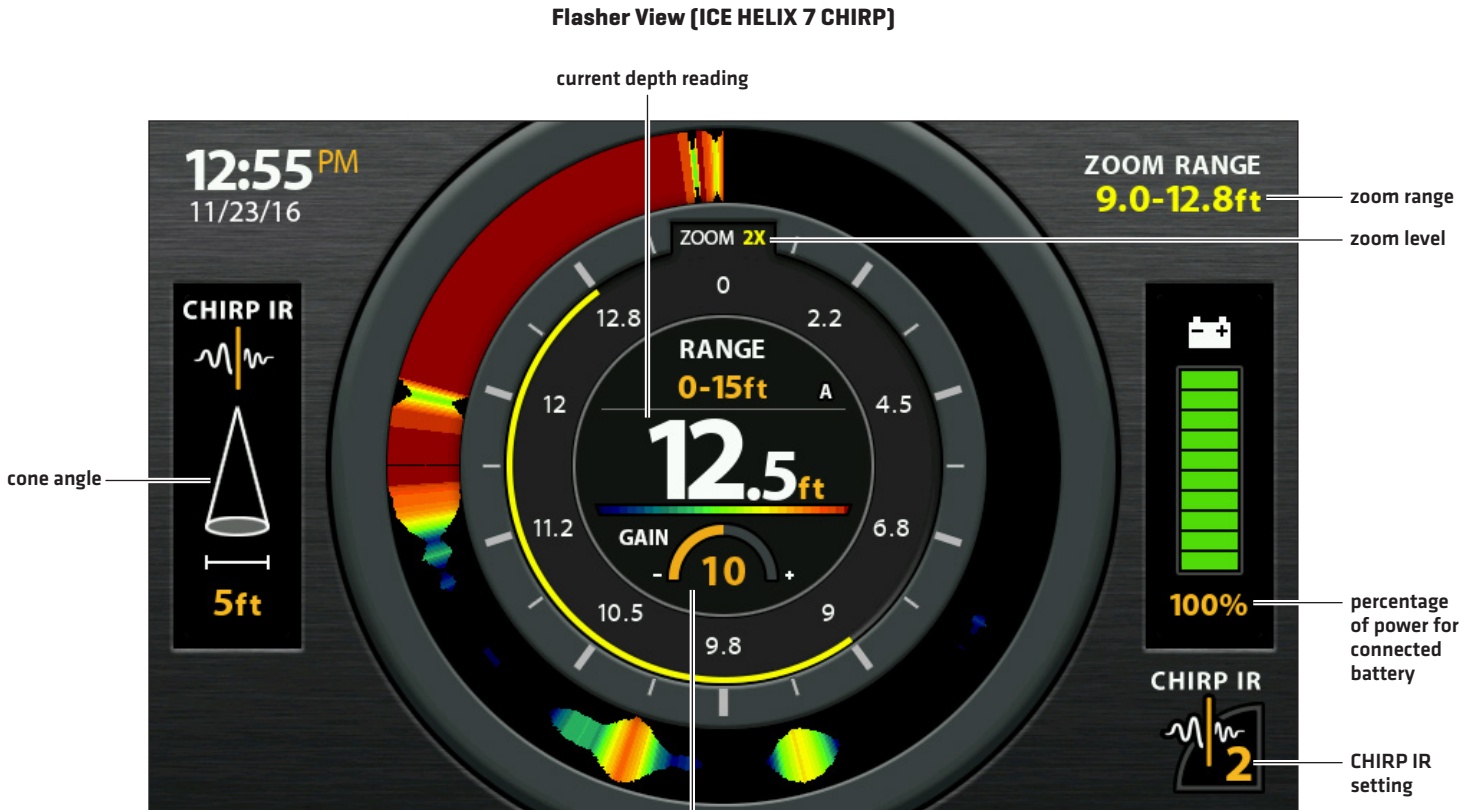
1. **Main Menu [Custom User Mode]:** Press the MENU key twice. Select the **Sonar** tab.
2. Select Digital Depth Source.
3. Select 2D Element.

# UNDERSTAND THE FLASHER VIEW

Like a traditional sonar view, the Flasher View displays the sonar return intensity with different colors. The view is maximized with information you need for ice fishing, including the current depth, connected battery power percentage, and related menu settings.

Strong returns often result from rocky or hard bottoms [compacted sediment, rocks, fallen trees], while weaker returns often result from soft bottoms [sand, mud], vegetation, and small fish.

The colors used to represent high, medium, to low intensity returns are determined by the palette you choose [see *Adjust Settings While you Fish: Change the Sonar Colors Palette*].

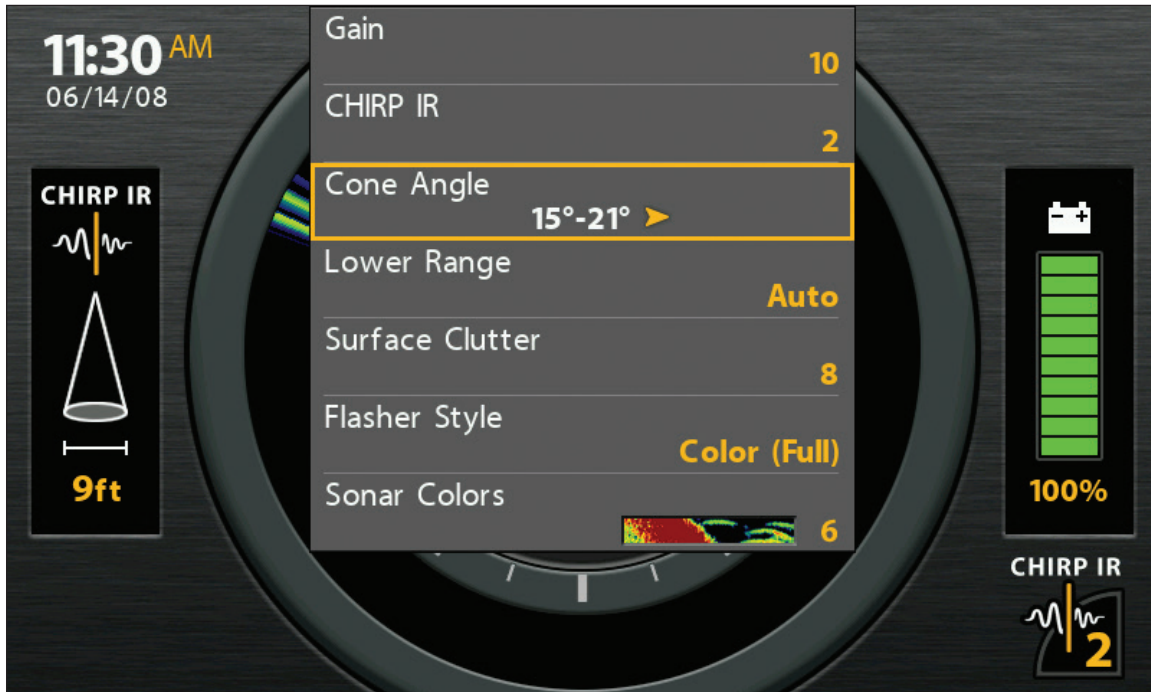


Related menu settings are displayed in the center of the flasher view and include the current depth range and lower range mode indicator (Auto [A] or Manual [M]), sonar color palette, and gain.

## ADJUST SETTINGS WHILE YOU FISH

The X-Press Menu provides menu options to adjust the sensitivity and range as you fish. The menus allow you to see more or less of the sonar returns from the transducer beams as you adjust each setting. Also, you can use key shortcuts on the views.

### Adjusting Settings from the X-Press Menu (ICE HELIX 7 CHIRP)



### Adjust the Gain (Sensitivity)

Gain [or Sensitivity, depending on your control head model] controls how much detail is shown on the view. To eliminate the clutter from the display that is sometimes present in murky or muddy water, decrease the gain. When operating in very clear water or greater depths, increase the gain to see weaker returns.

### Adjust the Gain using the X-Press Menu

Use the following instructions to adjust the gain.

1. **Flasher X-Press Menu:** With the Flasher View displayed on-screen, press the MENU key once.
2. Select Gain.
3. Press the RIGHT or LEFT Cursor keys to increase or decrease the gain.



**KEY SHORTCUT:** In Sonar View, press the +ZOOM key to increase the gain and the -ZOOM key to decrease the gain [GPS models only].

## Adjust for Interference (CHIRP models only)

If you are fishing near other ICE flashers or transducers, use CHIRP IR [Interference Rejection] to reduce interference or noise on the sonar display.

### Set the CHIRP Interference Rejection (CHIRP IR) using the X-Press Menu

1. **Flasher X-Press Menu:** With the Flasher View displayed on-screen, press the MENU key once.
2. Select CHIRP IR.
3. Press the RIGHT or LEFT Cursor keys to adjust the setting.



**KEY SHORTCUT:** With the Flasher View displayed on-screen, press the CHECK/INFO key to adjust the CHIRP IR setting [GPS models only].

## Set the Cone Angle (CHIRP models only)

Use the following instructions to set the angle of the sonar beam. CHIRP IR must be turned off to set the Cone Angle.

1. **Flasher X-Press Menu:** With the Flasher View displayed on-screen, press the MENU key once.
2. Select Cone Angle.
3. Press the RIGHT or LEFT Cursor keys to adjust the setting.

15°	Select 15° for a narrowly focused down beam.
21°	Select 21° for a wide down beam and larger coverage area.
15°-21°	Select 15°-21° to use the full frequency range for your transducer.

## Set the Upper/Lower Range

Upper Range and Lower Range control how much of the water column is displayed on the view. For example, if you are only interested in the area between 20 and 50 feet deep, set the Upper Range to 20 and the Lower Range to 50. The view will not display sonar returns outside of the set ranges, and greater detail for the selected range will be displayed.

1. **Flasher X-Press Menu:** With the Flasher View displayed on-screen, press the MENU key once.
2. Select Upper Range. Press the RIGHT or LEFT Cursor keys to adjust the setting.
3. Select Lower Range. Select Auto or set a specific depth [manual].

**Auto:** The Lower Range will be adjusted by the control head to follow the bottom automatically.

**Manual :** The control head locks onto the depth you select.



**NOTE:** There must be a difference of 10 feet between the upper and lower range settings.



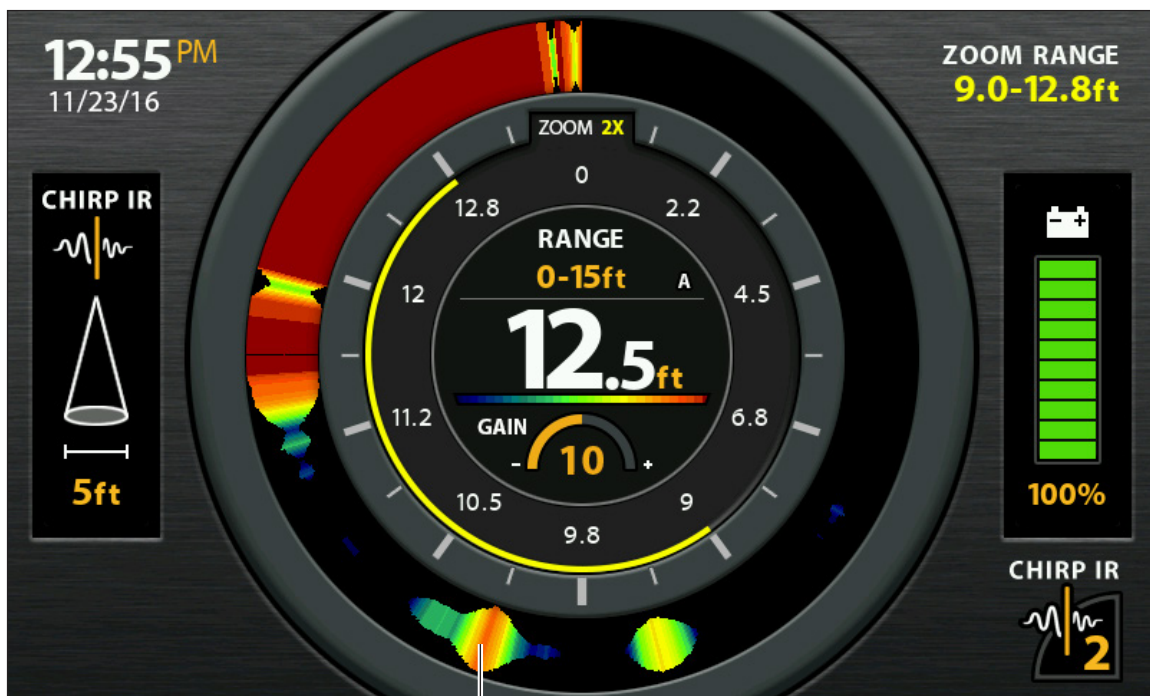
## Change the Flasher Window Style

The Flasher Window displays the depth and intensity of the sonar returns. You can change the display style for the sonar returns using the instructions below. You can also change the sonar colors used for sonar returns. For details, see *Change the Sonar Colors Palette*.

1. **Flasher X-Press Menu:** With the Flasher View displayed on-screen, press the MENU key once.
2. Select Flasher Style.
3. Select the type of Flasher Style to display.

Color [Full]	Sonar returns are displayed in color, and they fill the width of the Flasher Window.
Color [A-Scope]	Sonar returns are displayed in color. The size of the displayed lines correspond with the intensity of the sonar returns from the transducer beam(s).

### Flasher Style Set to Color [A-Scope]



The size of the sonar returns correspond with the intensity of the sonar returns from the transducer beam(s).

## Select a Range of the Palette (Contrast)

Contrast allows you to choose a range of the Color Palette to display sonar returns. For details, see *Change the Sonar Colors Palette*.

When Contrast is set to 20 [default], the entire palette is used to display weak and strong sonar returns. As you increase the Contrast, fewer colors within the selected palette are used to display the sonar returns [whether weak or strong].

1. **Main Menu [Custom User Mode]:** Press the MENU key twice. Select the **Sonar** tab.
2. Select Contrast.
3. Press the RIGHT or LEFT Cursor keys to increase or decrease the contrast.

## Change the Sonar Colors Palette

The X-Press Menu allows you to quickly change the display palette while you fish. The Color Palette menu shows a preview of the palette, and the weak to strong sonar return range is displayed from left to right.

1. **Flasher X-Press Menu:** With the Flasher View displayed on-screen, press the MENU key once.
2. Select Sonar Colors.
3. Select a palette.


## Switch Frequencies (key shortcut for GPS models only)

If the transducer includes more than one down beam frequency, use the CHECK/INFO key to quickly change the frequency used in the Flasher View. For more information see *Set up Sonar*.

1. Press the CHECK/INFO key.

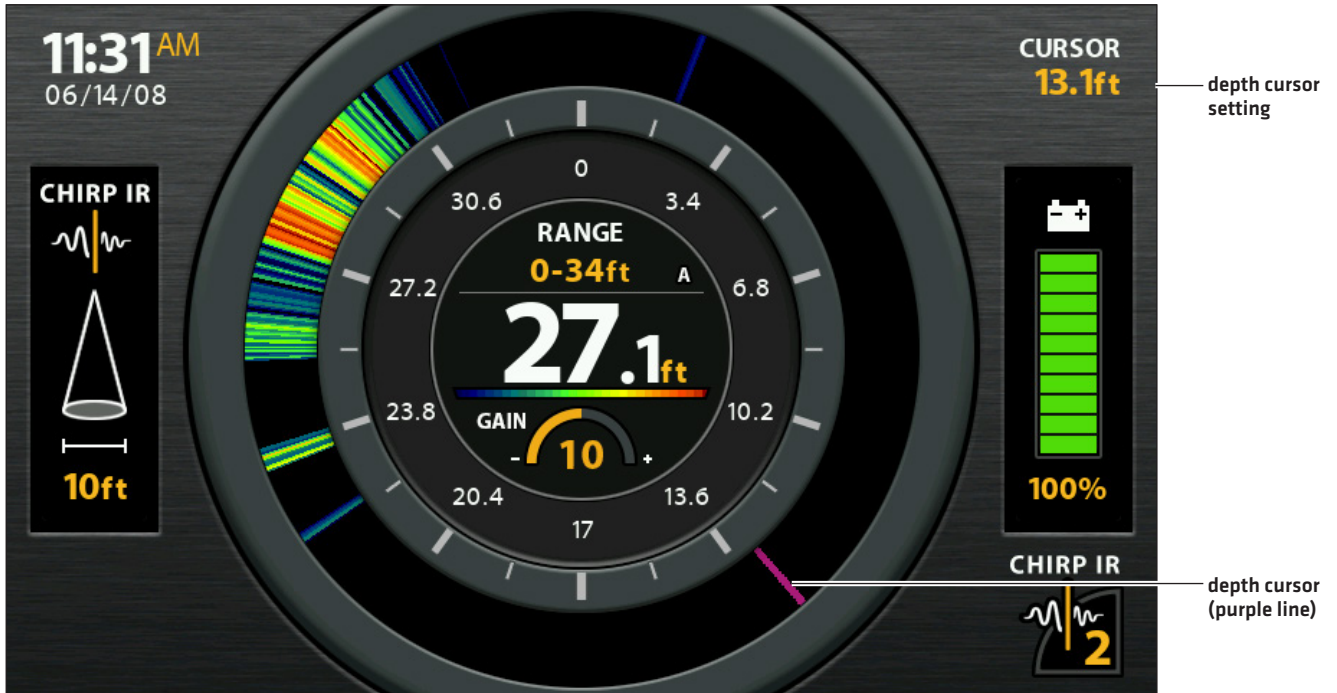
# MOVE THE DEPTH CURSOR

Use the Depth Cursor to identify a depth on the Flasher View.

 **NOTE:** Ice Fishing Mode must be turned on to enable this feature [see *Ice Fishing Overview: Turn on Ice Fishing Mode*].

1. **Activate:** Press the DOWN Cursor key, and the purple cursor line will display on the dial.
2. **Adjust the Cursor:** Press the UP or DOWN Cursor keys.
3. **EXIT:** Press the EXIT key.

Flasher View with Depth Cursor Displayed



Move the Cursor

## ZOOM IN/OUT IN FLASHER VIEW

---

The Zoom feature displays a 2x magnified view of the area you choose on the Flasher View.



**NOTE:** Ice Fishing Mode must be turned on to enable this feature [see *Ice Fishing Overview: Turn on Ice Fishing Mode*].

### ZOOM In/Out using the ZOOM Keys (GPS models only)

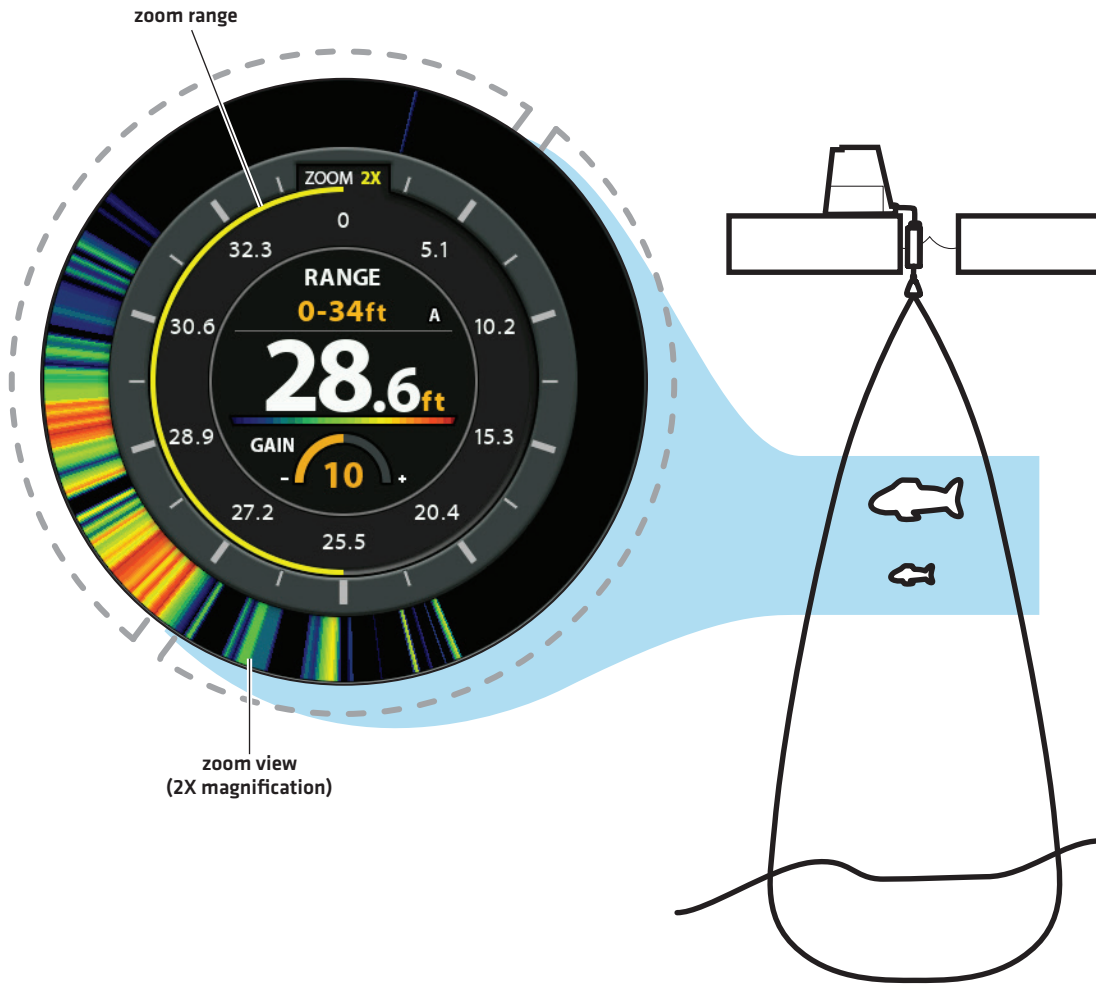
1. **Activate:** Press the +ZOOM key.
2. **Adjust the Zoom Range:** Press the RIGHT or LEFT Cursor keys to move the white zoom lines on the flasher dial.
3. **Close Zoom:** Press -ZOOM key.

### ZOOM In/Out using the Flasher X-Press Menu

If your control head model does not include ZOOM keys, you will use the Zoom Level menu.

1. **Flasher X-Press Menu:** With the Flasher View displayed on-screen, press the MENU key once.
2. Select Zoom Level.
3. Select 2X.
4. **Adjust the Zoom Range:** Press the RIGHT or LEFT Cursor keys to move the white zoom lines on the flasher dial.
5. **Close Zoom:** Press the MENU key. Select Zoom Level > 1X.

## Magnifying Sonar Returns in the Flasher View



ZOOM In  
(GPS models only)



Move the Zoom Range

# USING SONAR ZOOM VIEW IN ICE FISHING MODE

(ICE HELIX CHIRP, HELIX 5 AND 7 G2/G2N, HELIX 7 G3 AND HELIX 7, 8, 9 AND 10 G3N MODELS ONLY)

Sonar Zoom View provides additional ways to view sonar data for ice fishing. To enable Ice Fishing mode, see *Ice Fishing Overview: Turn on Ice Fishing Mode*.

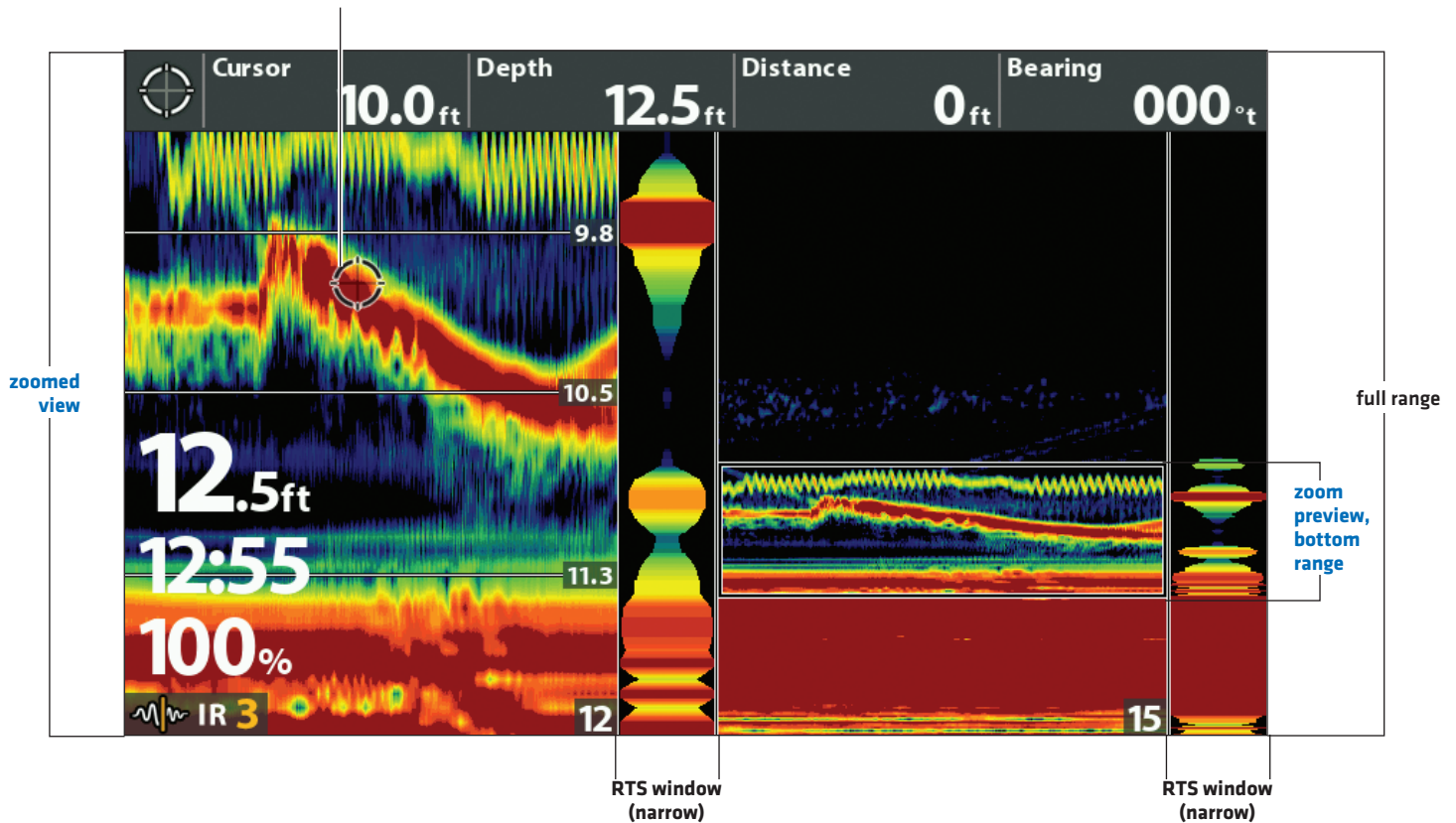
## Display the Sonar Zoom View

1. Press and hold the VIEW key.
2. Select Sonar > Sonar Zoom View.

To zoom in and out in Sonar Zoom View using the ZOOM keys or X-Press Menu, see *Display a Sonar View On-Screen: Zoom In/Zoom Out*.

### Sonar Zoom View (ICE HELIX 7 CHIRP)

Active Cursor and Cursor Dialog Box (see *Show the Cursor*)



Scroll Up and Down the Water Column



ZOOM In (GPS models only)



ZOOM Out (GPS models only)

## Show the Cursor

To move the cursor in Sonar Zoom View, you must activate the cursor in the X-Press Menu.

1. **Sonar X-Press Menu:** With the Sonar Zoom View displayed on-screen, press the MENU key once.
2. Select Show Cursor.
3. Press the RIGHT Cursor key.

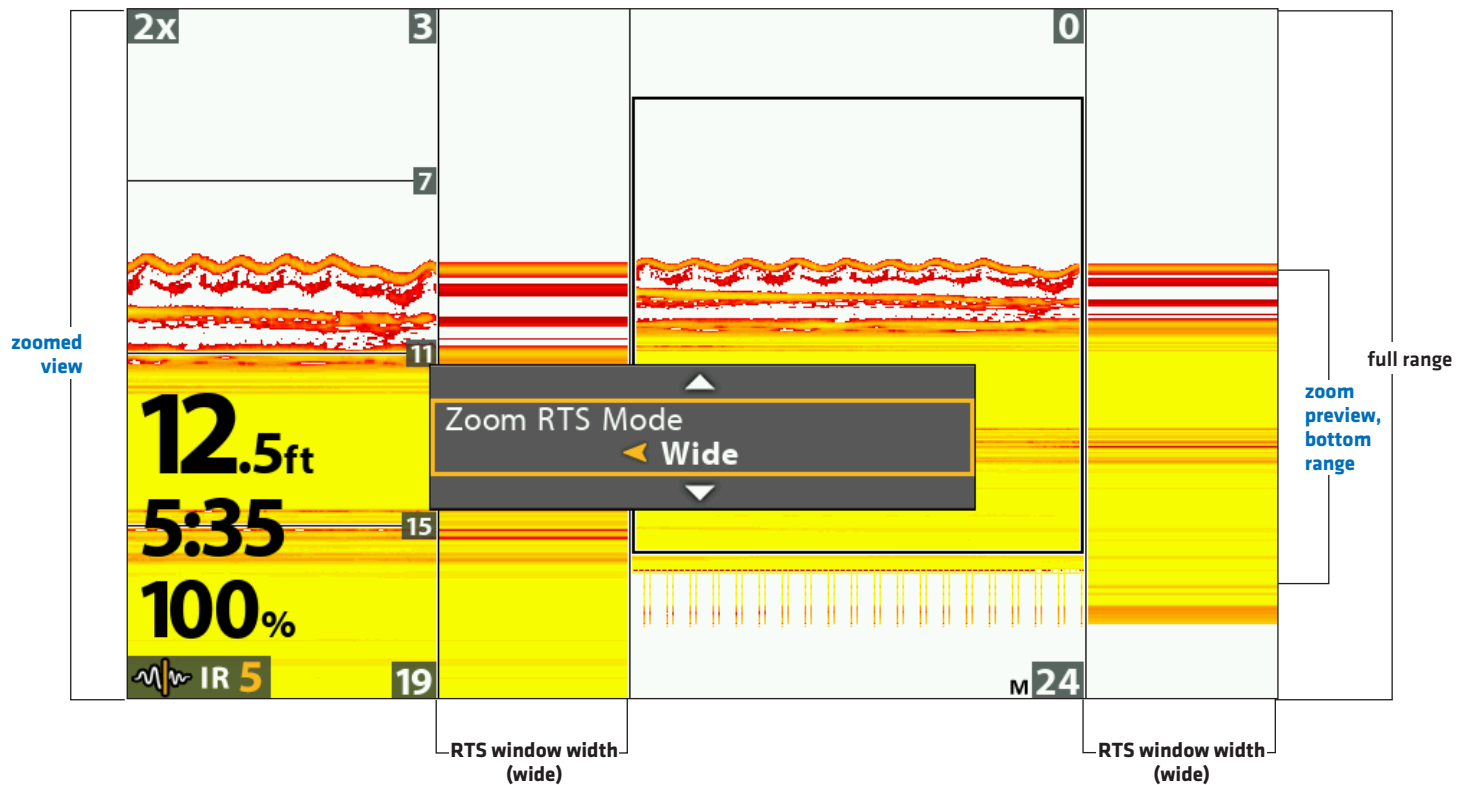
## Adjust the Zoom RTS Window

The RTS Window plots the depth and intensity of a sonar return. It updates at the fastest rate possible for depth conditions and shows only the returns from the bottom, structure, and fish that are within the transducer beam. To customize the RTS Window display, see *Customize the Sonar View: Customize the RTS Window*.

In Sonar Zoom View, you can adjust the width of the RTS Zoom window. See below.

1. **Sonar X-Press Menu:** With the Sonar Zoom View displayed on-screen, press the MENU key once.
2. Select Zoom RTS Mode.
3. Press the RIGHT or LEFT Cursor keys to adjust the setting.

### Setting the RTS Window Width



## Show/Hide Digital Readouts

Use the Declutter feature to hide digital readouts in a Sonar view when your control head is in Ice Fishing Mode.

1. **Sonar X-Press Menu:** With a Sonar view displayed on-screen, press the MENU key once.
2. Select Declutter.
3. Press the RIGHT Cursor key.
4. Press Exit.

## CHARGE GLOW-IN-THE-DARK LURES

---

Your control head can be used to charge glow-in-the-dark lures.



**NOTE:** Ice Fishing Mode must be turned on to enable this feature [see *Ice Fishing Overview: Turn on Ice Fishing Mode*].

### Using the Jig Charger

Use the Power X-Press Menu to activate the jig charger. Your screen will display white at full brightness for 10 seconds. Hold the glow-in-the-dark lure in front of the screen during this time to charge it.

1. **Power X-Press Menu:** Press the POWER key once.
2. Select Jig Charge.
3. Press the LEFT Cursor key to extend the charging duration by 10 seconds. Press the RIGHT Cursor key to exit the charging screen early.



# MANAGE SCREEN SNAPSHOTS AND RECORDINGS

Snapshot and Recording View displays the saved screen snapshots and recordings from the installed microSD or SD card (separate purchase required). Use this view to review the snapshot and recording file details, start recording, and adjust the recording settings.



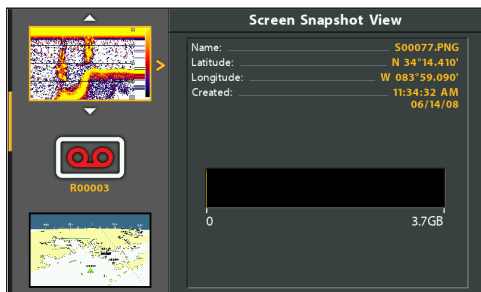
**NOTE:** Also, this feature can be helpful in troubleshooting any sonar-related issues. If you contact Humminbird Technical Support for sonar troubleshooting assistance, you may be asked to perform one of the tasks in this section. See **Email Files to Technical Support** for details.

## Display the Snapshot and Recording View

To view the saved screen snapshots from the installed microSD or SD Card, open the Snapshot and Recording View. If Screen Snapshot Waypoint is turned on when the screen snapshot is taken, you can view the saved file from Chart View.

1. Press and hold the VIEW key.
2. Select System > Snapshot and Recording View.

### Snapshot and Recording View



## Enable Screen Snapshot and Recording

To enable Screen Snapshot and Recording, a microSD or SD card must be installed in the control head. See **HELIX Control Head** for more information. If Screen Snapshot Waypoint is turned on, a waypoint will also be saved at the boat or cursor location when you take a screen snapshot. The waypoint is saved with the same file name as the screen snapshot.



**CAUTION!** On the microSD or SD card, you will see that a DAT (or a .TXT) file is created for every .PNG screen snapshot. This data file is required for viewing the screen snapshots from your control head, so don't delete these files.

## Enable Screen Snapshot and Recording

1. Install a microSD or SD card into the control head card slot. See **HELIX Control Head** for compatibility details.


## Enable Marking a Waypoint with each Screen Snapshot

If Screen Snapshot Waypoint is turned on, a waypoint will also be saved at the boat or cursor location when you take a screen snapshot. The waypoint is saved with the same file name as the screen snapshot.

1. **Main Menu:** Press the MENU key twice. Select the **Accessories** tab.
2. Select Screen Snapshot Waypoint.
3. Select On.

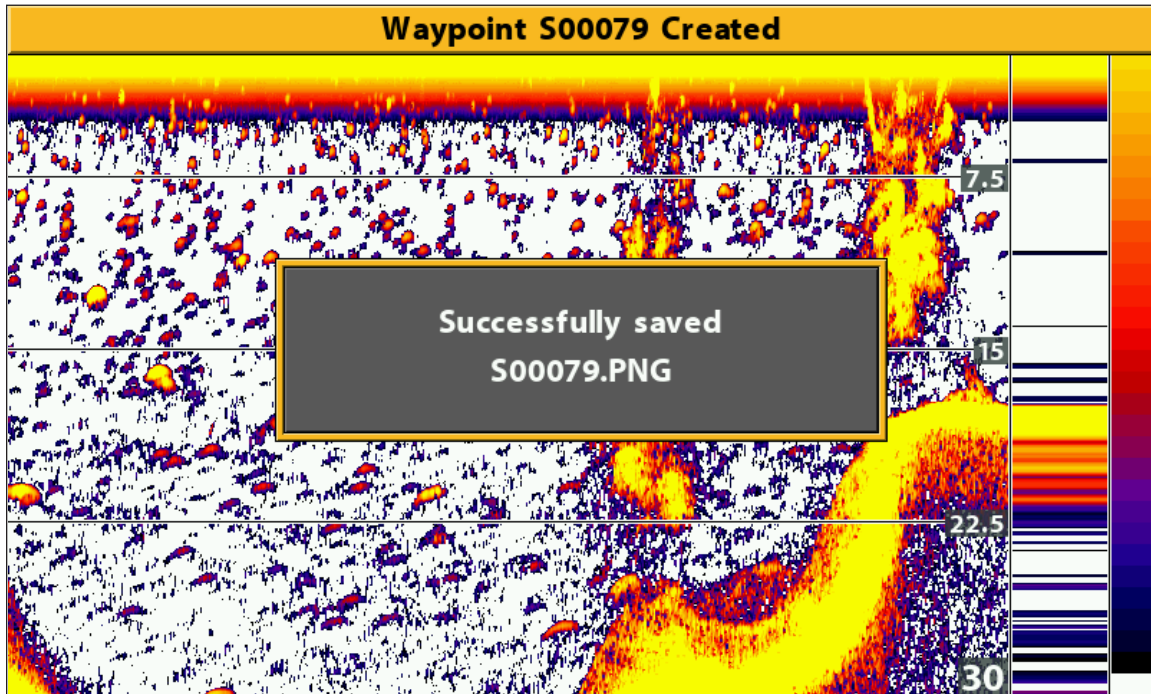
## Take Screen Snapshots

**Screen Snapshots** are saved pictures of the view on the screen. The screen snapshot will include the menus, dialog boxes, warnings, and messages that were active when the screen snapshot was taken. If Screen Snapshot Waypoint is turned on, a waypoint will also be saved at the boat or cursor location when you take a screen snapshot.

 **NOTE:** A microSD or SD card must be installed in the control head to use the Snapshot and Recording features. See **HELIX Control Head** for compatibility details.

1. From any view or cursor location you want to capture, press and hold the MARK key.


### Taking a Screen Snapshot



Press and Hold to  
Take a Screen Snapshot

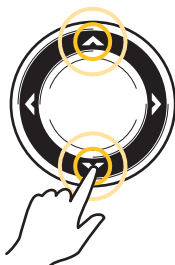
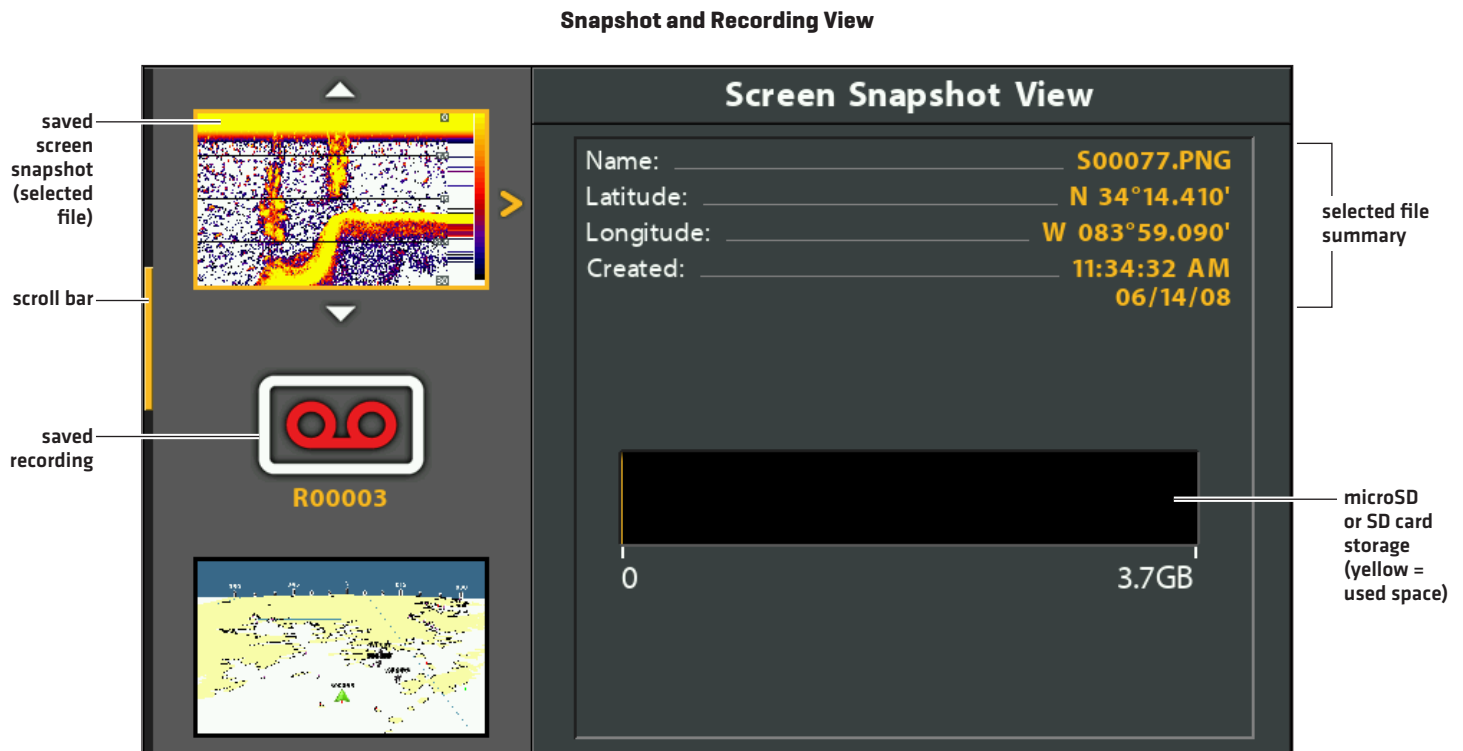
## Manage Saved Screen Snapshots

Saved Screen Snapshots can be viewed from the Snapshot and Recording View. If Screen Snapshot Waypoint is turned on when the screen snapshot is taken, you can view the saved file from the Chart View.

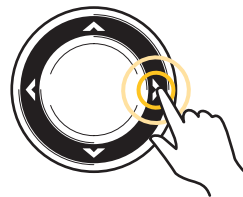
 **NOTE:** A microSD or SD card must be installed in the control head to use the Snapshot and Recording features. See **HELIX Control Head** for compatibility details.

### Display a Saved Screen Snapshot from Snapshot and Recording View

1. Display the Snapshot and Recording View on-screen.
2. **Select a Snapshot:** Press the UP or DOWN Cursor keys to scroll through the saved files.
3. **Display:** Press the RIGHT Cursor key.
4. **Close:** Press the LEFT Cursor key.



Scroll through the List



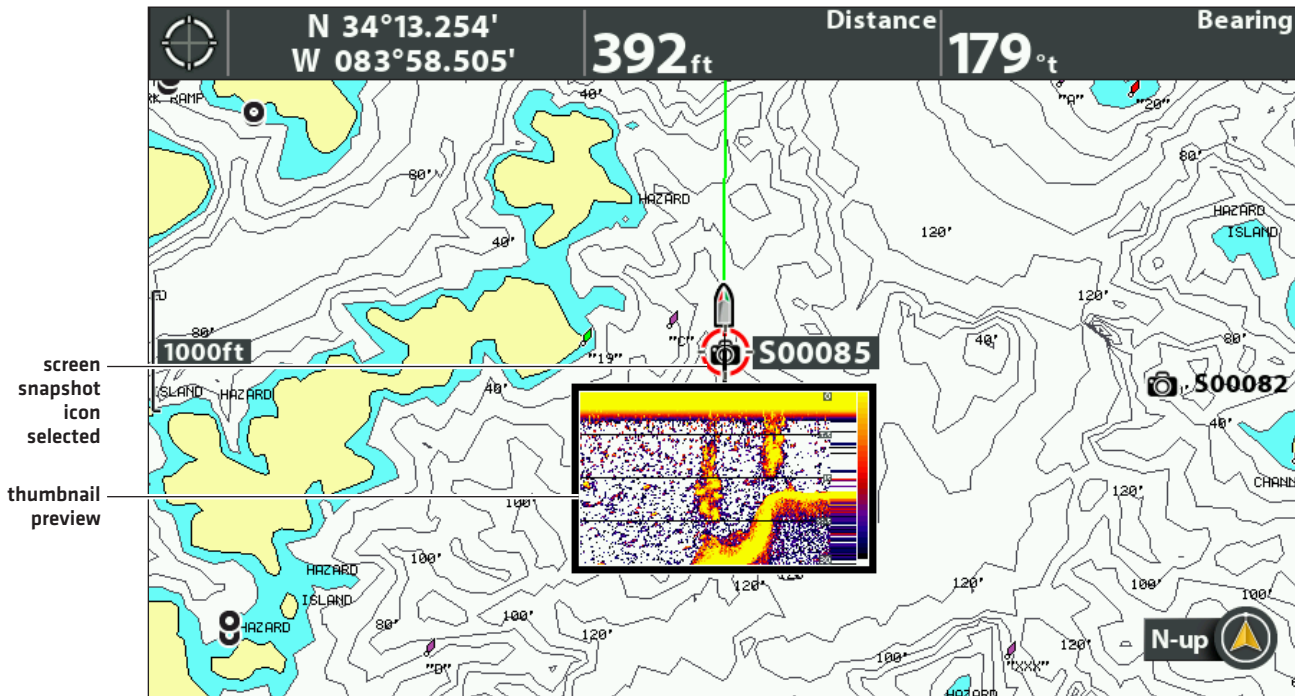
Display

## Display a Saved Screen Snapshot from Chart View

If Screen Snapshot Waypoint is turned on when the screen snapshot is taken, you can view the saved file from the Chart View [see *Enable Marking a Waypoint with each Screen Snapshot*].

1. Display a Chart View on-screen.
2. **Select a Snapshot:** Use the Cursor key to select a screen snapshot icon.
3. **Display:** Press the CHECK/INFO key.

### Selecting a Screen Snapshot in Chart View (Map Source: Contour XD)



4. **Close:** Press the EXIT key.

## Delete a Screen Snapshot

1. Display the Snapshot and Recording View on-screen.
2. **Select a Snapshot:** Press the UP or DOWN Cursor keys to scroll through the saved files.
3. Press the MENU key.
4. Select Delete Image. Press the RIGHT Cursor key.

## Delete all Screen Snapshots

1. Display the Snapshot and Recording View on-screen.
2. Press the MENU key.
3. Select Delete All Images. Press the RIGHT Cursor key.

## Record and Playback

The Recording feature records active sonar information. When the recording is played back, the views that were active during the recording are available in Playback. You can play a saved recording from the Snapshot and Recording View.



**NOTE:** A microSD or SD card must be installed in the control head to use the Snapshot and Recording features. See **HELIX Control Head** for compatibility details.

### Start Recording

1. Display the Snapshot and Recording View on-screen.
2. Press the MENU key.
3. Select Start Recording. Press the RIGHT Cursor key.

**File Name:** A waypoint will also be created at the boat location, and the recording shares the same file name as the waypoint [.SON].

**Use Different Views:** To use different views on the control head and continue recording, press the EXIT key.

**Not Available:** Taking screen snapshots and playback mode are not available during recording.

### Stop Recording

1. **X-Press Menu:** From any view, press the MENU key once.
2. Select Stop Recording. Press the RIGHT Cursor key.

## Play a Recording

1. Display the Snapshot and Recording View on-screen.
2. **Select a Recording:** Press the UP or DOWN Cursor keys to scroll through the saved files.
3. **Start Playback:** Press the RIGHT Cursor key.

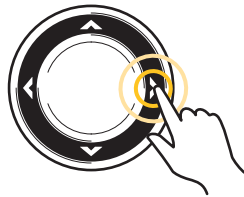
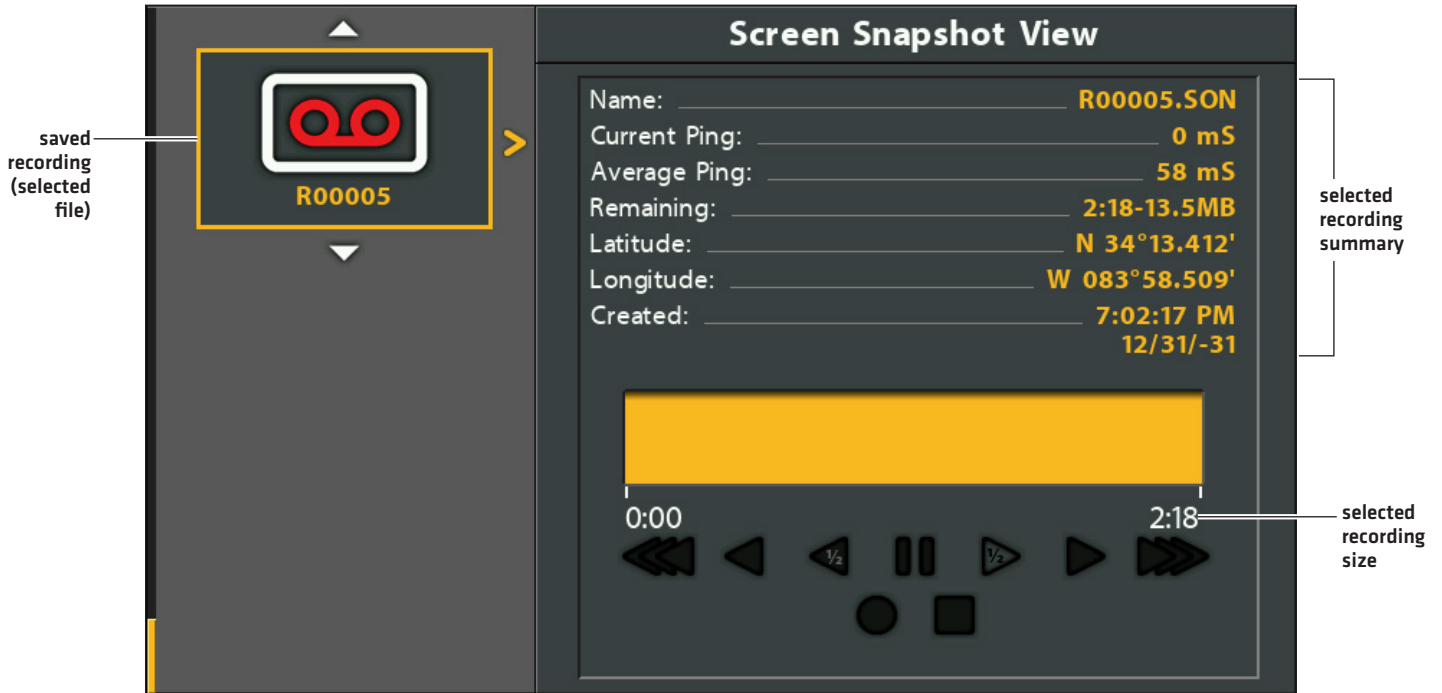
**Navigation** is cancelled during playback.

**Use Different Views:** To use different views on the control head and continue playback, press the EXIT key.

**Adjust Sonar:** Use the X-Press Menu to adjust sonar settings during playback. You can also use the cursor.

**Mark Waypoints:** Press the MARK key to mark waypoints during playback.

### Selecting a Recording to Play

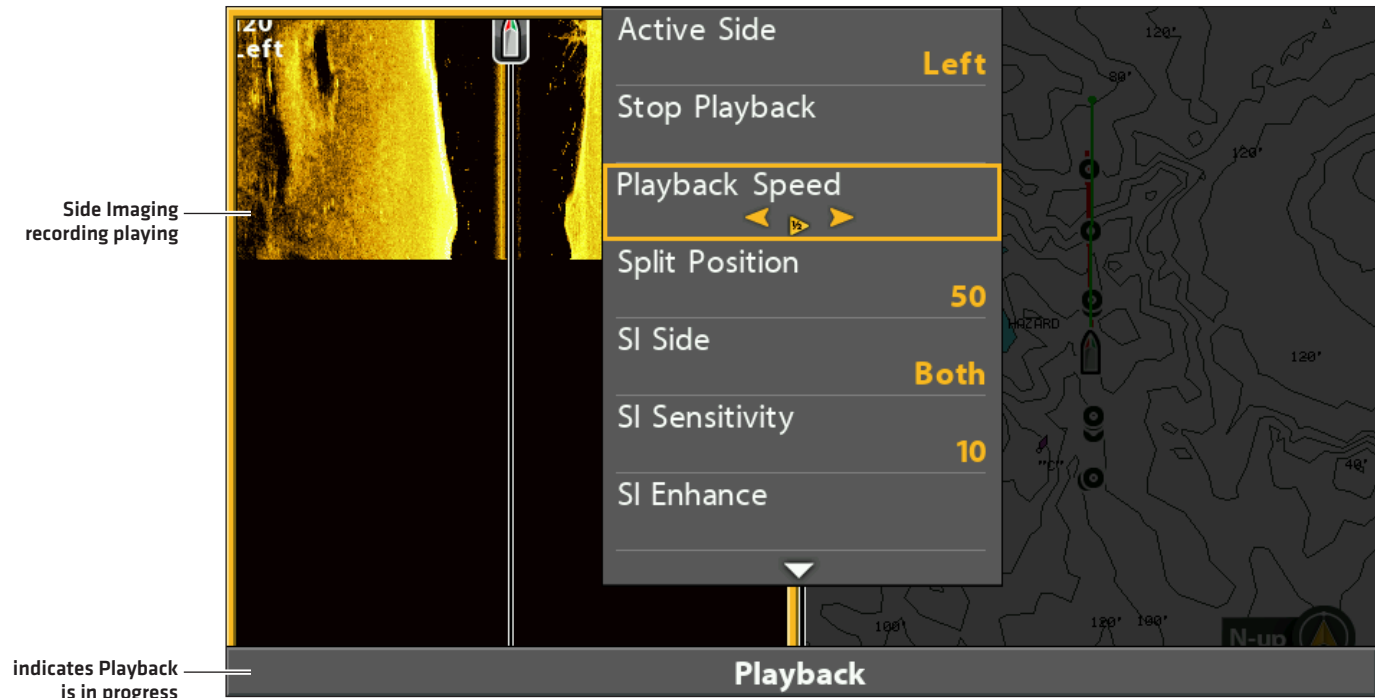


Start Playback

## Adjust Playback Speed

1. **X-Press Menu:** From any view, press the MENU key once.
2. Select Playback Speed.
3. Press the RIGHT or LEFT keys to adjust playback speed or pause.

### Adjusting the Playback Speed



## Stop Playback

1. **X-Press Menu:** From any view, press the MENU key once.
2. Select Stop Playback. Press the RIGHT Cursor key.

## Delete a Recording

1. Display the Snapshot and Recording View on-screen.
2. **Select a Recording:** Press the UP or DOWN Cursor keys to scroll through the saved files.
3. Press the MENU key.
4. Select Delete Recording. Press the RIGHT Cursor key.

## Delete all Saved Recordings

1. Display the Snapshot and Recording View on-screen.
2. Press the MENU key.
3. Select Delete All Recordings. Press the RIGHT Cursor key.

## Email Files to Technical Support

If you're working with Humminbird Technical Support to troubleshoot a sonar-related issue, they may ask you to send a screen snapshot or recording to them for review. Use the instructions in this section to email a saved screen snapshot or recording to Humminbird Technical Support.

### Email a Saved Screen Snapshot

1. Install the SD or microSD card [and adapter] with the saved screen snapshots and recordings into your personal computer.



**CAUTION!** On the microSD or SD card, you will see that a DAT [or a .TXT] file is created for every .PNG screen snapshot. This data file is required for viewing the screen snapshots from your control head, so don't delete these files. See **HELIX Control Head** for compatibility details.

2. Open your email account and compose a new message.

If Technical Support has provided a customer number, include it in the subject line.

3. Attach the screen snapshot files to the message. For each screen snapshot, attach the Sxxxxx.PNG file.

**Folder:** Screen Snapshots are saved in the SNAPSHOT folder on the microSD or SD card.

**File Names:** The .PNG file and .DAT file for each screen snapshot have the same name. Unless you have edited the name, screen snapshots start with S.

4. Repeat step 3 for each screen snapshot.
5. Send the email to Humminbird Technical Support.



**NOTE:** If the attached files are large, you may need to use win-zip or a similar program to compress the files and send them via email.

### Email a Saved Recording

1. Install the microSD or SD card adapter with the saved screen snapshots and recordings into your personal computer.



**CAUTION!** On the microSD or SD card, you will see that a DAT [or a .TXT] file is created for every recording folder. This data file is required for viewing the recordings on your control head, so don't delete these files. See **HELIX Control Head** for compatibility details.

2. Open your email account and compose a new message.

If Technical Support has provided a service number, include it in the subject line.

3. Attach the Rxxxxx.DAT file for the recording to the message.

**Folder:** Recordings are saved in the RECORD folder on the microSD or SD card.

4. Attach all the files in the Rxxxxx folder to the message. Open the RECORD folder, and open the folder with the Recording name.

**Folder:** Recordings are saved in the RECORD folder on the microSD or SD card. Unless you have edited the name, recordings start with R. Open the Rxxxxx folder for the recording. For example, to send the files for the R00001 recording, open the R00001 folder.

**File Names:** Attach all the .SON files and .IDX files in the recording folder.

5. Repeat step 3 and 4 for each recording.
6. Send the email to Humminbird Technical Support.



**NOTE:** If the attached files are large, you may need to use win-zip or a similar program to compress the files and send them via email.

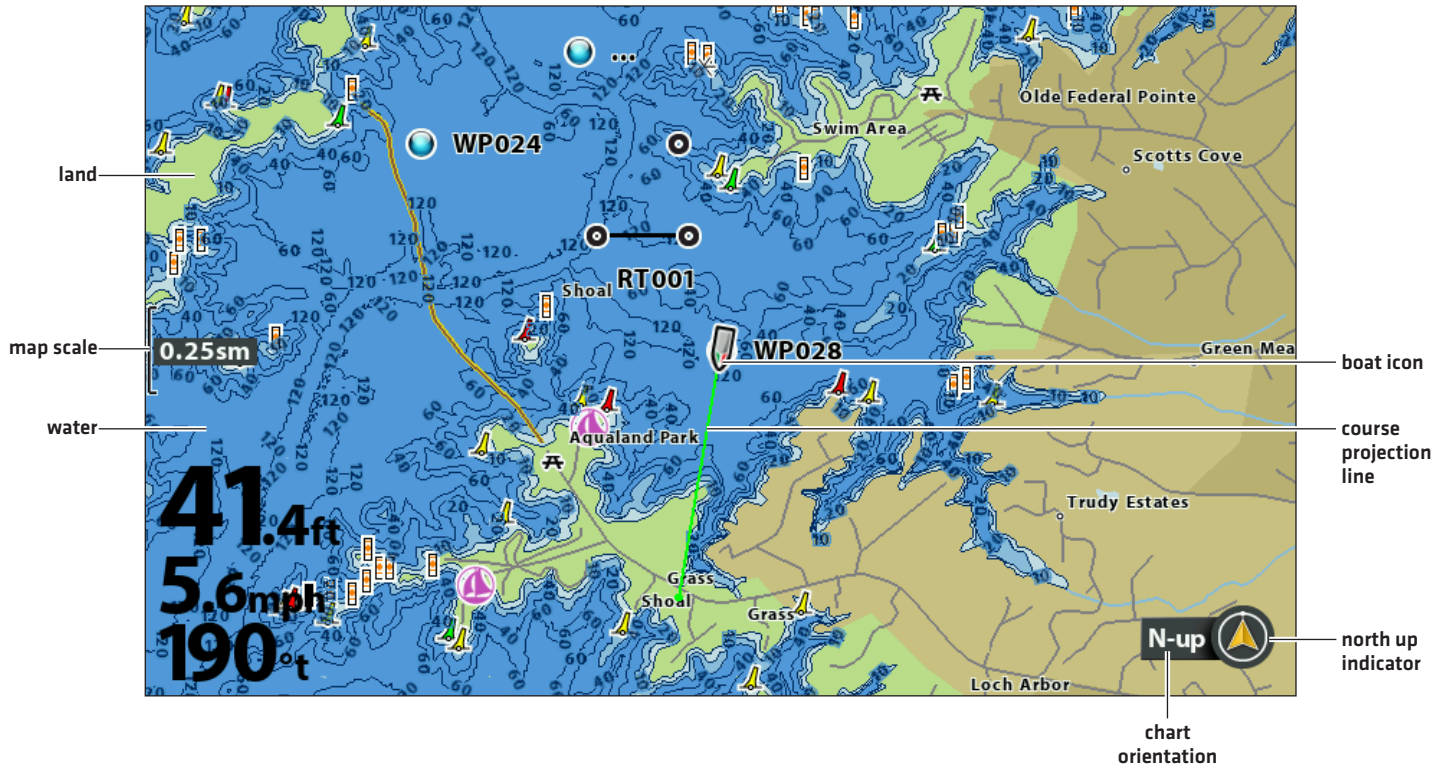


# CHART OVERVIEW

To enable the chart and navigation features, the control head must have a GPS Fix from an internal or external GPS receiver (see **Getting Started** to check the sensor reception). Some of these features also require a compass/heading sensor to be connected to the control head.

The selected map source also influences the menu system. When you change the map source, the menu options for the chart views change, allowing you to add navigation data, shading, or alarms. See **Select a Map Source** for details.

**Chart View with Built-in Humminbird Basemap (HELIX 9 CHIRP MDI GPS)**



- ⊙ When the boat is stationary, it is drawn as a circle.
- 🚤 When the boat is in motion, it changes to a boat shape, pointed in the direction of motion.

# DISPLAY A CHART VIEW ON-SCREEN

There are a variety of views available to display charts and navigation. The views can be customized and displayed as a Combo View.

## Display a Chart View or Bird's Eye View

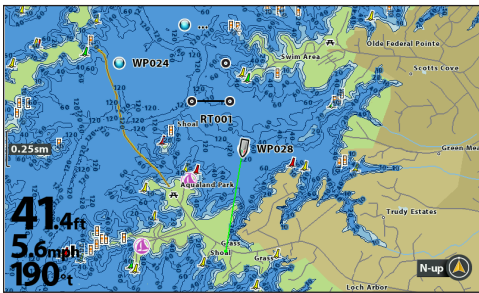
Bird's Eye View is only available when Contour XD or a Navionics map card is selected as the map source.

1. Press and hold the VIEW key.
2. Select Chart > Chart View or Chart Instrument View.

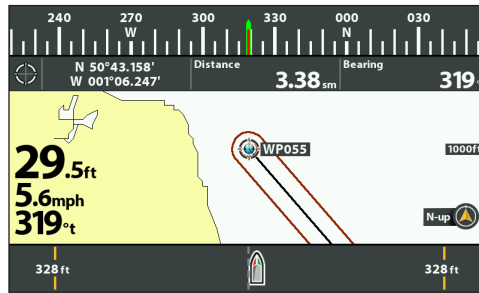
OR

Select Chart > Bird's Eye View.

**Chart View**  
(Map Source: Humminbird Basemap)

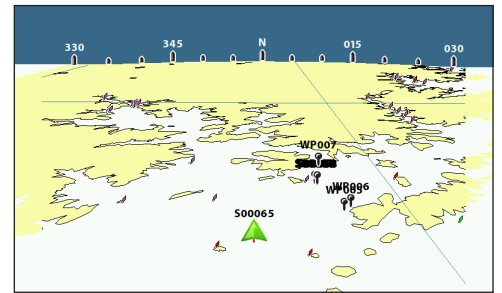


**Chart Instrument View**  
(Map Source: Contour XD)



For more information, see  
*Customize the Chart Instrument View.*

**Bird's Eye View**  
(with Contour XD or Navionics only)



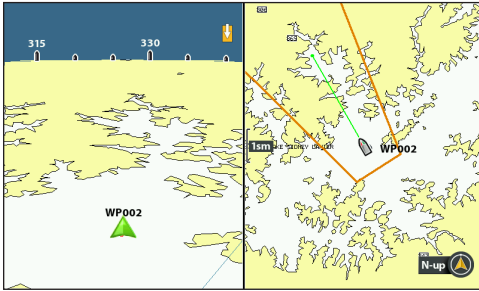
For more information, see  
*Customize the Bird's Eye View.*

## Display a Chart Combo View

You can select a variety of Chart Combo Views or Chart/Sonar Combo Views.

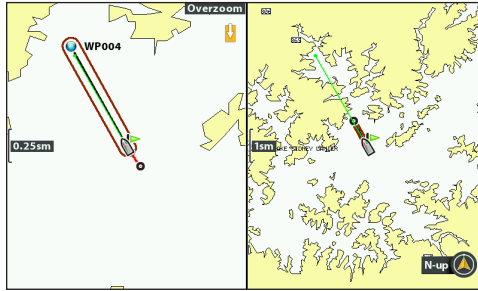
1. Press and hold the VIEW key.
2. Select Chart.
3. Select a view to display on-screen. Press the RIGHT Cursor key.

### Chart > Chart/Bird's Eye Combo View [with Contour XD or Navionics only]

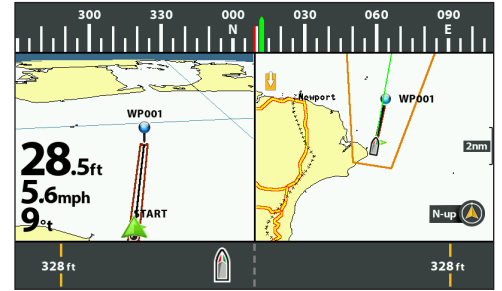


For more information, see  
*Customize the Bird's Eye View.*

### Chart > Chart/Chart Combo View [Map Source: Contour XD]

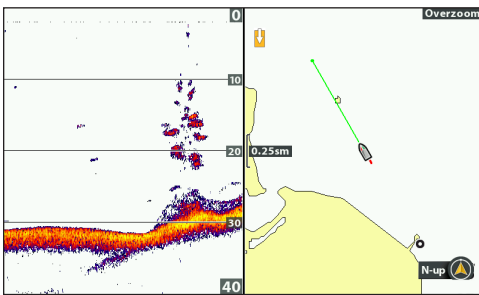


### Chart > Chart/BE Instrument View [with Contour XD or Navionics only]



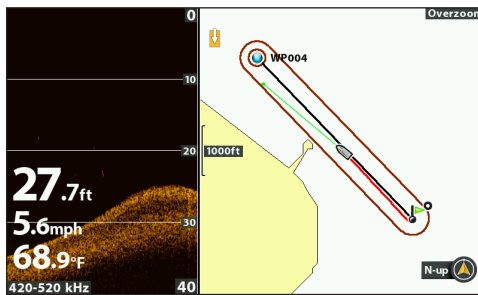
For more information, see  
*Customize the Chart Instrument View and  
Customize the Bird's Eye View.*

### Chart > Chart/Sonar Combo View [Map Source: Contour XD]



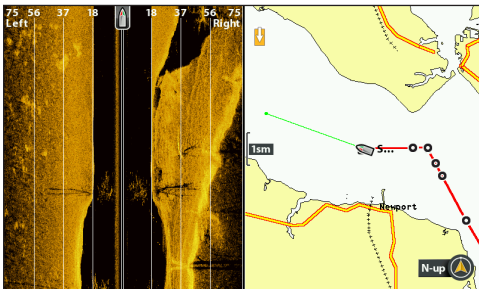
For more information, see the  
*Sonar* section.

### Chart > Chart/Down Combo View [Map Source: Contour XD]



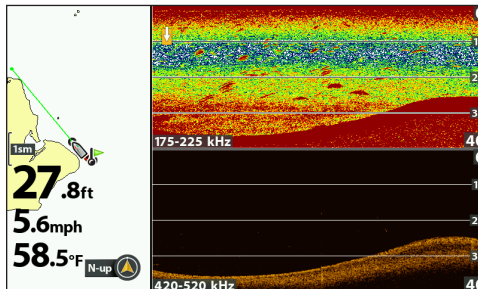
For more information, see the  
*Down Imaging* section.

### Chart > Chart/Side Combo View [Map Source: Contour XD]



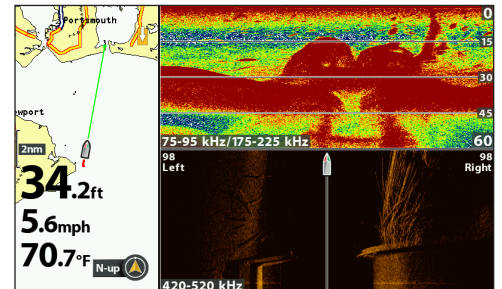
For more information, see the  
*Side Imaging* section.

### Chart > Chart/Sonar/Down Combo View [Map Source: Contour XD]



For more information, see the  
*Sonar and Down Imaging* sections.

### Chart > Chart/Sonar/Side Combo View [Map Source: Contour XD]



For more information, see the  
*Sonar and Side Imaging* sections.

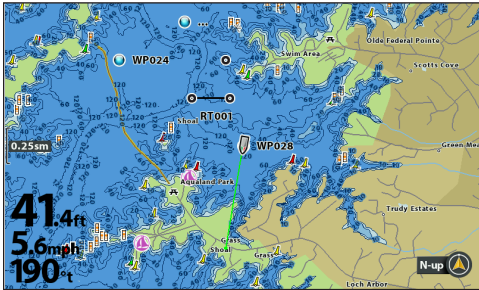


**NOTE:** The available views are determined by your control head model and the installed transducer. For a complete list of the views available on your control head, press the MENU key twice, and select the Views tab. See each related section of the manual [*Views, Sonar, Side Imaging, Navigation Overview, etc.*] for more information.

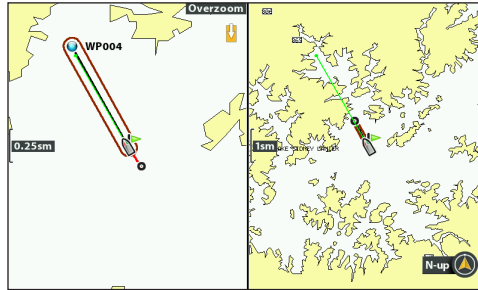
## SELECT A MAP SOURCE

The HELIX control head includes built-in maps, including the Humminbird Basemap and Contour XD. You can also install a microSD or SD map card with additional chart information for a particular location [separate purchase required]. See *HELIX Control Head* for compatibility details.

### Chart View (Map Source: Humminbird Basemap)



### Chart/Chart Combo View (Map Source: Contour XD)



**NOTE:** Your control head may require a software update to display the Humminbird Basemap.

## Install a microSD or SD Map/Chart Card

When you install a microSD or SD map or chart card, the control head automatically chooses the best map to display. You can also change the map source manually. If your control head has two cards installed, you can choose which map source you want to use [HELIX 8, 9, 10, 12 only].

1. Install a microSD or SD map/chart card into the control head card slot. See *HELIX Control Head* for compatibility details.



**NOTE:** Do not leave the card slot cover open. The slot cover should always be closed to prevent water damage to the unit.

## Change the Map Source

When you install a microSD or SD map/chart card, the map source is changed automatically to match the microSD or SD map/chart card map source. You can also change the map source manually.

When you change the map source, the available views and menus for the chart views also change, allowing you to add navigation data, shading, alarms, and more.

1. **Main Menu:** Press the MENU key twice. Select the **Chart** tab.
2. Select Map Source.
3. Select the installed map/chart card location or a built-in map.

**Auto:** The best available map will be selected automatically.

## Change Map Options

### Change the Map Coordinate System (optional, Contour XD and Navionics map cards only)

Use Map Datum to change the map coordinate system used by the control head to match those of a paper map. Almost all electronic charts use the WGS84 Map Datum and most likely do not require a setting change. [Default = WGS84]

1. **Main Menu [Custom User Mode]:** Press the MENU key twice. Select the **Chart** tab.
2. Select Map Datum.
3. Press the RIGHT or LEFT Cursor keys to change the setting.

## Apply an Offset to the Map (optional, Contour XD and Navionics map cards only)

Use Set Map Offset to move the chart position on-screen and correct a position error in the cartography. This setting applies to all charts, not just the chart that requires correction.



**NOTE:** This feature is not available with Humminbird LakeMaster map cards or CoastMaster chart cards.

1. Display a Chart View on-screen.
2. Use the Cursor Control key to move the cursor to the position where the map offset will be applied.
3. **Main Menu [Custom User Mode]:** Press the MENU key twice. Select the **Chart** tab.
4. Select Set Map Offset.
5. Press the RIGHT Cursor key.
6. Follow the on-screen prompts.

**Clear Map Offset:** Select **Main Menu [Advanced User Mode] > Chart** tab > Clear Map Offset.

## Select a New Map (optional, Contour XD and Navionics map cards only)

If the installed map card includes additional maps, use the following instructions to display map borders and select a different map.

1. **Main Menu:** Press the MENU key twice. Select the **Chart** tab.
2. Select Map Borders.
3. Select MMC/SD Only or All Visible.
4. Display a Chart View on-screen.
5. Use the Cursor Control key to move the cursor within the dotted lines of a map border.
6. Press the +ZOOM key repeatedly to display the map details.

See *Customize the Chart View: Customize the Chart Detail Level*.

## Change the Simulation Position (optional)

Simulator mode allows you to save menu settings and navigation data while you learn to use your control head. To start simulation mode, see **Getting Started**. To change the simulation position shown on the Chart View, use the following instructions.

Simulation mode is not intended for on the water use. If you are on the water, use Normal mode. See **Getting Started** for details.

1. Display a Chart View on-screen.
2. Use the Cursor Control key to move the cursor to a position on the view.
3. **Main Menu [Custom User Mode]:** Press the MENU key twice. Select the **Chart** tab.
4. Select Set Simulation Position.
5. Press the RIGHT Cursor key.

The boat icon will move to the new position.

**Clear the Track:** Press the MENU key once. Select Clear Current Track.

## Set up Humminbird ChartSelect

ChartSelect allows you to purchase a Humminbird chart online and download it to a blank microSD or SD Card.

To display purchased ChartSelect charts and/or overlays, see *Display Chart Overlays*.

### Encrypt a microSD or SD Card

Use the Encrypt SD Card menu to prepare a blank microSD or SD card for ChartSelect. See *HELIX Control Head* for compatibility details.



**WARNING!** Do not use this menu with a microSD or SD map card installed. You must use a blank microSD or SD card with this menu. See the ChartSelect and FishSmart User Guide before proceeding.

1. **Main Menu:** Press the MENU key twice. Select the **Setup** tab.
2. Select Encrypt SD Card.
3. Press the RIGHT Cursor key.

## Set up Humminbird LakeMaster

When a Humminbird LakeMaster map card is installed and selected as the map source, additional menus are added to the menu system. The menu options are determined by the map card you purchased.

**Compatible Map Sources:** Humminbird LakeMaster, LakeMaster PLUS, ZeroLine Map Card, AUTOCHART PC, etc.



**NOTE:** A Humminbird LakeMaster map card must be installed and selected as the map source to enable this feature [see **Change the Map Source**].

To display purchased ChartSelect charts and/or overlays, see *Display Chart Overlays*.

### Set the Water Level Offset

When you start your trip for the day, it is important to note if the water level is higher or lower than normal. For example, if you know the lake is down 3 feet, set the Water Level Offset to -3.

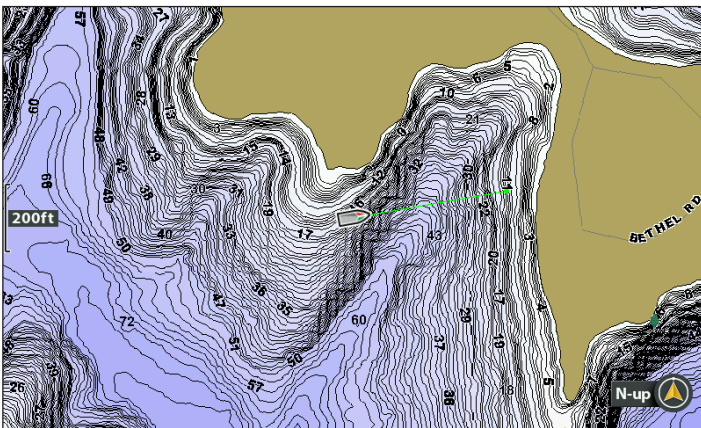
1. **Main Menu:** Press the MENU key twice. Select the **HB Chart** tab.
2. Select Water Level Offset.
3. Press the RIGHT or LEFT Cursor keys to adjust the setting.

If the water level is higher than normal, set a [+] positive amount.

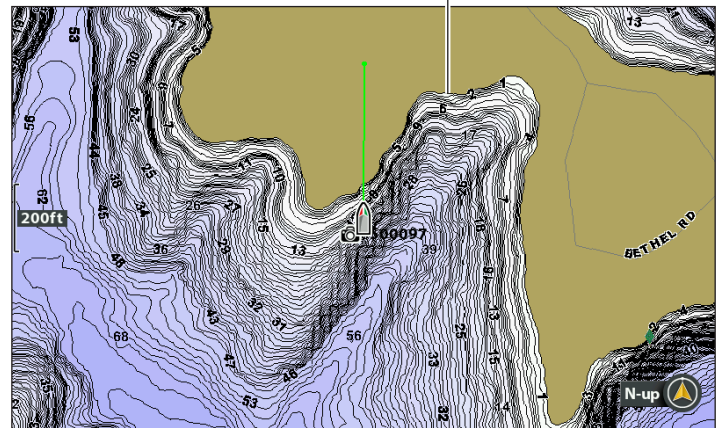
If the water level is lower than normal, set a [-] negative amount.

If the water level has not changed [normal], set Water Level Offset to [0] zero.

**Water Level Offset (Set to 0 = Off)**



**Water Level Offset Adjusted to -4**



If the water is lower than normal, set the Water Level Offset to a negative number, and the land will extend visually on the map (as shown above). If the water is higher than normal, set the Water Level Offset to a (+) positive amount, and the water line will extend visually on the map.




**NOTE:** For additional LakeMaster map card menus, see *Display Humminbird LakeMaster Contour Lines and Depth Ranges* in this manual.

## Set up Humminbird CoastMaster

When a Humminbird CoastMaster chart card is installed and selected as the map source, additional menus are added to the menu system.

**Compatibility:** Humminbird CoastMaster chart cards are available to use with **HELIX G3, G3N and G4N** control heads with chartplotting capabilities.

 **NOTE:** A Humminbird CoastMaster chart card must be installed and selected as the map source to enable this feature [see **Change the Map Source**].

**Automatic Display:** The map displayed on the Chart View is based on your latitude/longitude position and the chart card installed in the control head, so your current position will be displayed automatically. GPS reception is required for the correct position to be displayed.

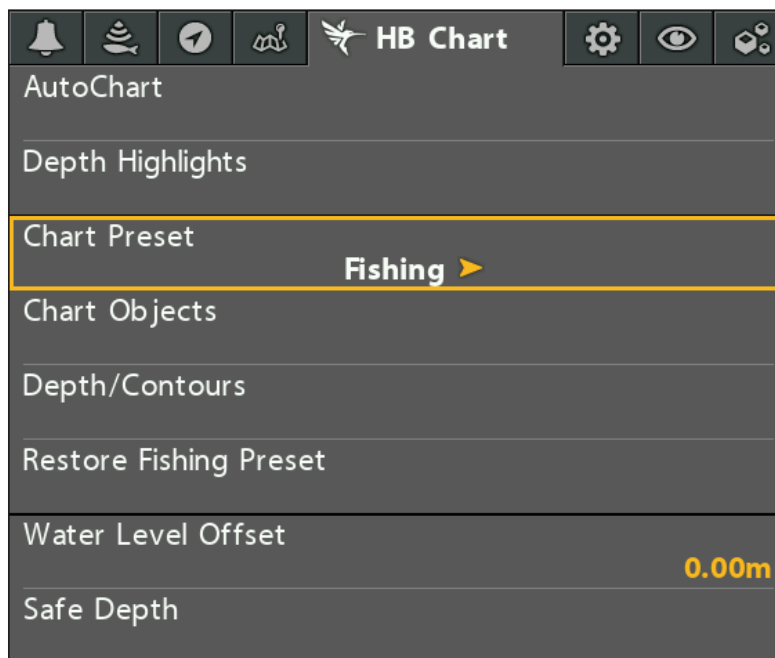
If your current position is not displayed, confirm you have GPS reception and that your CoastMaster Chart Card is installed. Also, review the Map Source:

### Select a Chart Preset

Use Chart Presets to quickly alternate between settings. You can use the default Fishing or Navigation settings provided, or you can create a custom User preset with your preferences. The Fishing and Navigation presets are also fully customizable. You can restore each preset back to its default settings at any time.

1. **Main Menu:** Press the MENU key twice. Select the **HB Chart** tab.
2. Select Chart Preset.
3. Press the RIGHT or LEFT Cursor keys to select your Chart Preset.

#### Select a Chart Preset



 **NOTE:** For additional CoastMaster chart card menus, see **Display Humminbird CoastMaster Contour Lines and Depth Ranges** in this manual.

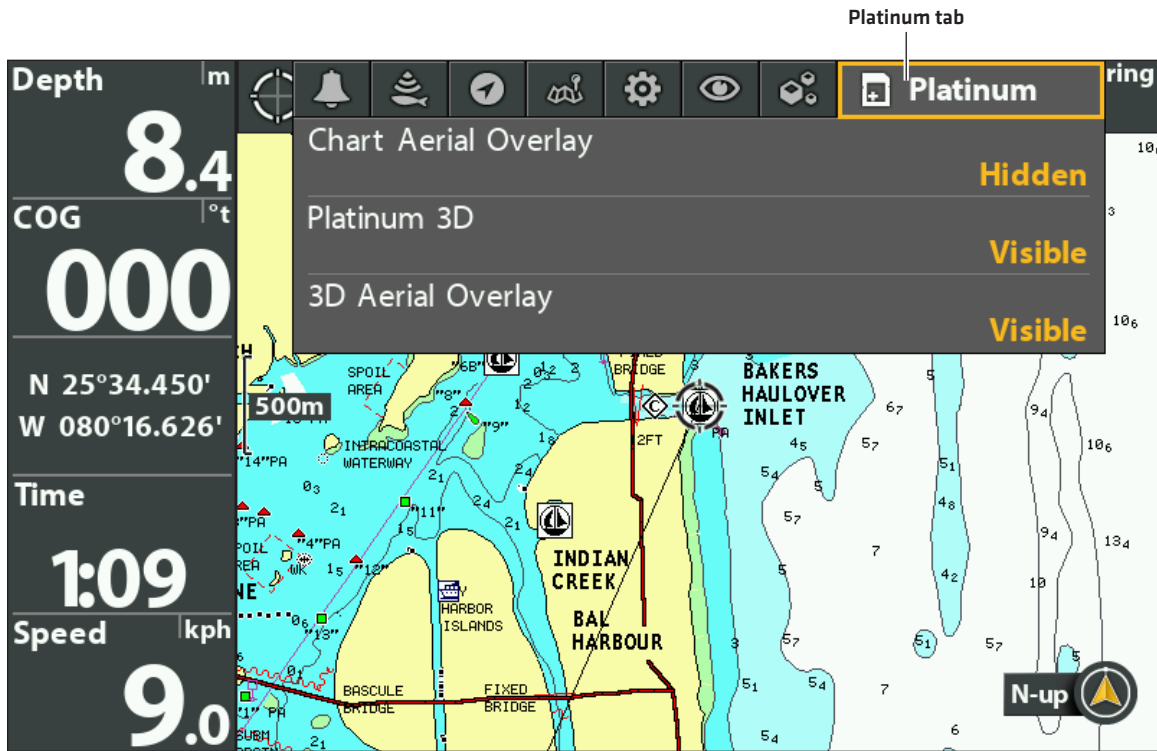



## Set up Navionics

When a Navionics map card is installed and selected as the map source, additional menus are added to the menu system. The menu options are determined by the map card you purchased, and they are available in the Chart tab [see [Customize the Chart View](#)] and/or the Platinum tab.

**Compatible Map Sources:** Navionics+, Navionics Gold, HotMaps, HotMaps Premium, and Platinum+.

### Selecting the Navionics Platinum Tab



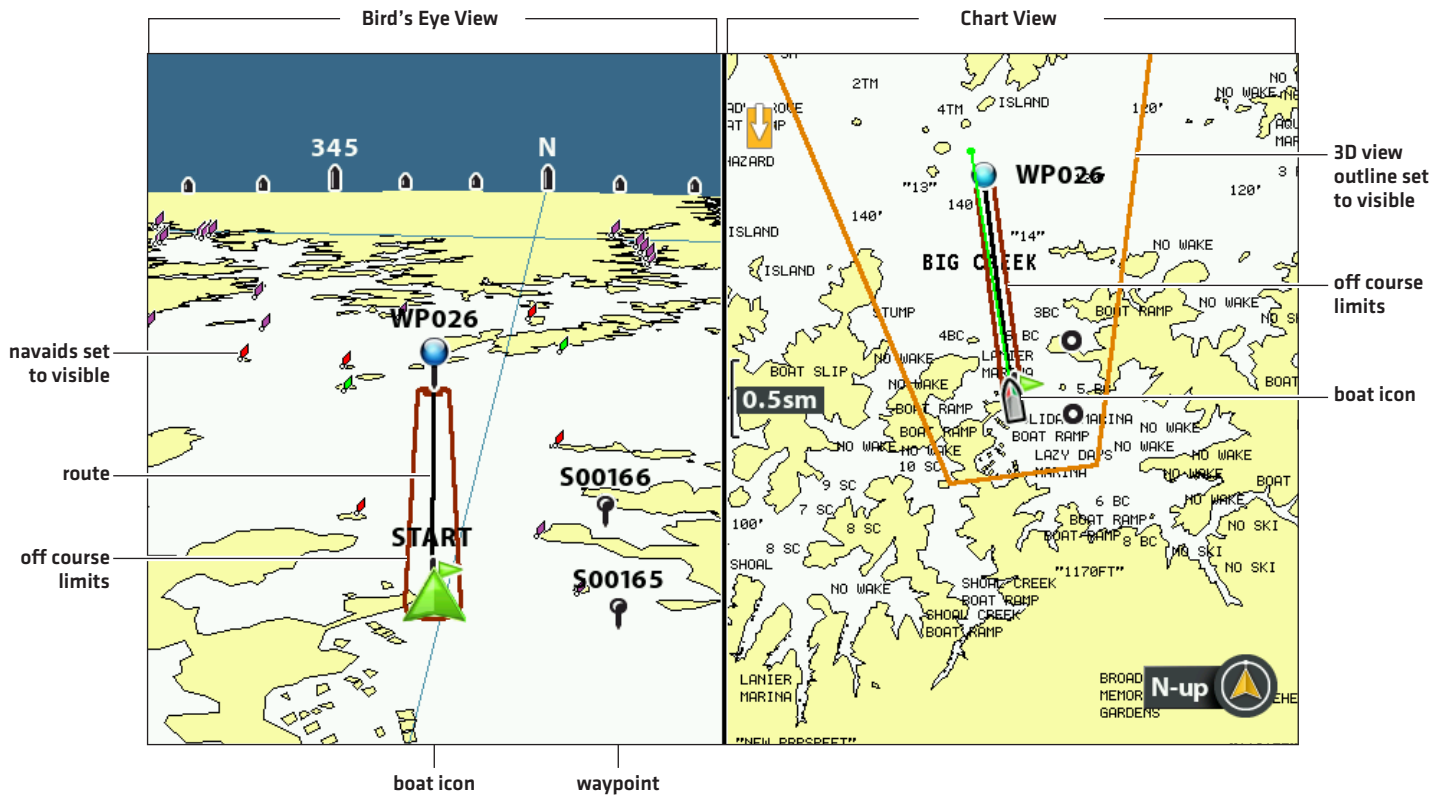
 **NOTE:** A Navionics map card must be installed and selected as the map source to enable these features [see [Change the Map Source](#)]. For details and additional features related to your Navionics map card, see your Navionics map card user guide.

# CUSTOMIZE THE BIRD'S EYE VIEW

(CONTOUR XD AND NAVIONICS ONLY)

Nav aids on Bird's Eye View allows you to add navigational aids to the Bird's Eye View, such as lights or buoys. The available settings are determined by the installed map card and the selected map source.

## Chart/Bird's Eye Combo View



### Show/Hide Nav aids

1. **Main Menu:** Press the MENU key twice. Select the **Chart** tab.
2. Select Nav aids on Bird's Eye View.
3. Select Visible or Hidden.

### Show/Hide the Bird's Eye Outline

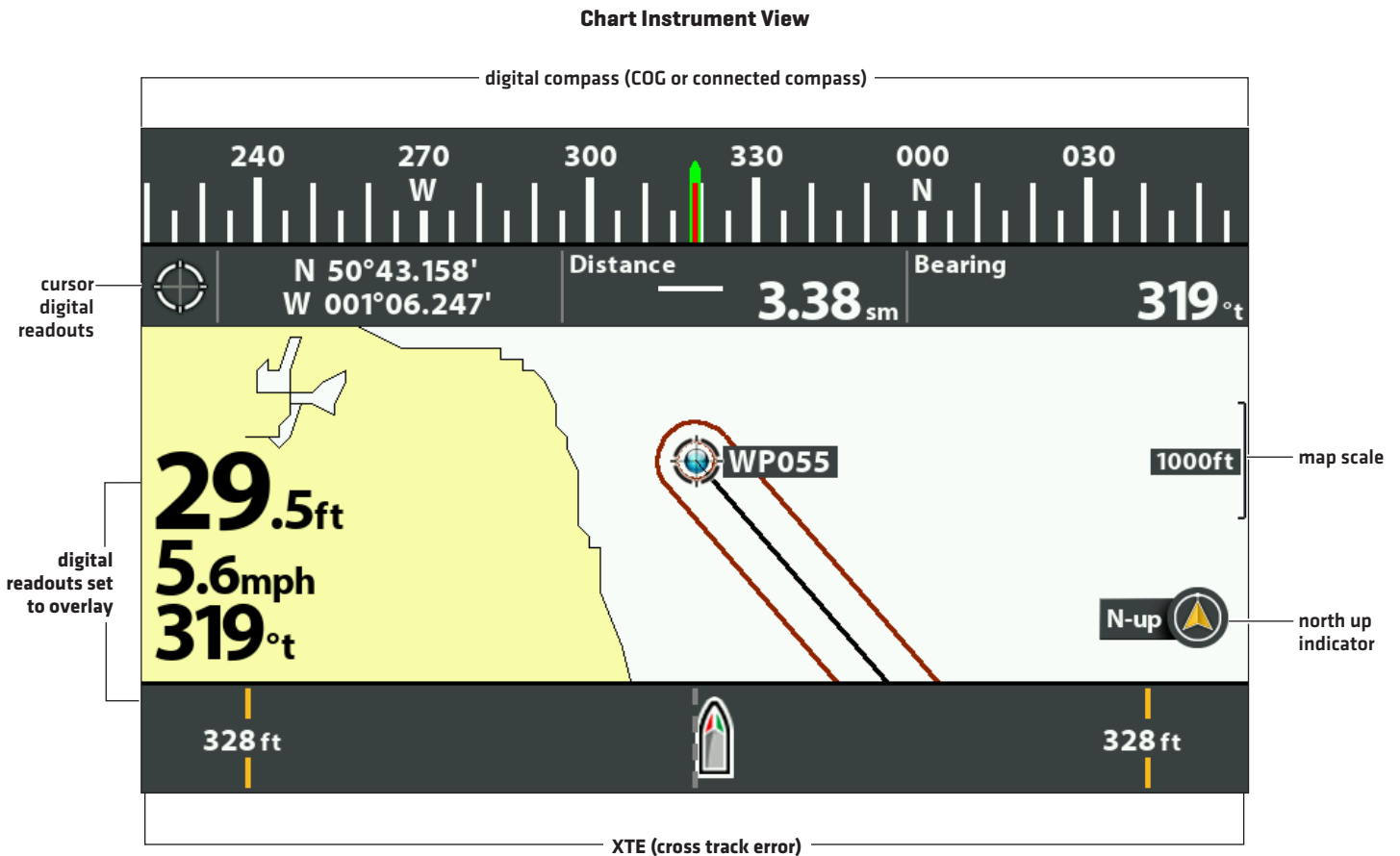
If you use the Chart/Bird's Eye View, you can display a line on the Chart View that shows the portion of the view that is used in the Bird's Eye View.


1. **Main Menu:** Press the MENU key twice. Select the **Nav** tab.
2. Select 3D View Outline.
3. Select Visible or Hidden.

# CUSTOMIZE THE CHART INSTRUMENT VIEW

The Chart Instrument View displays a digital compass and XTE [Cross Track Error] graphic on the Chart View. If a compass is not installed, the COG [Course Over Ground] provides the data source for the digital compass.

The Chart Instrument View shares the same menu settings as the Chart View. For customization information, see *Customize the Chart View*.

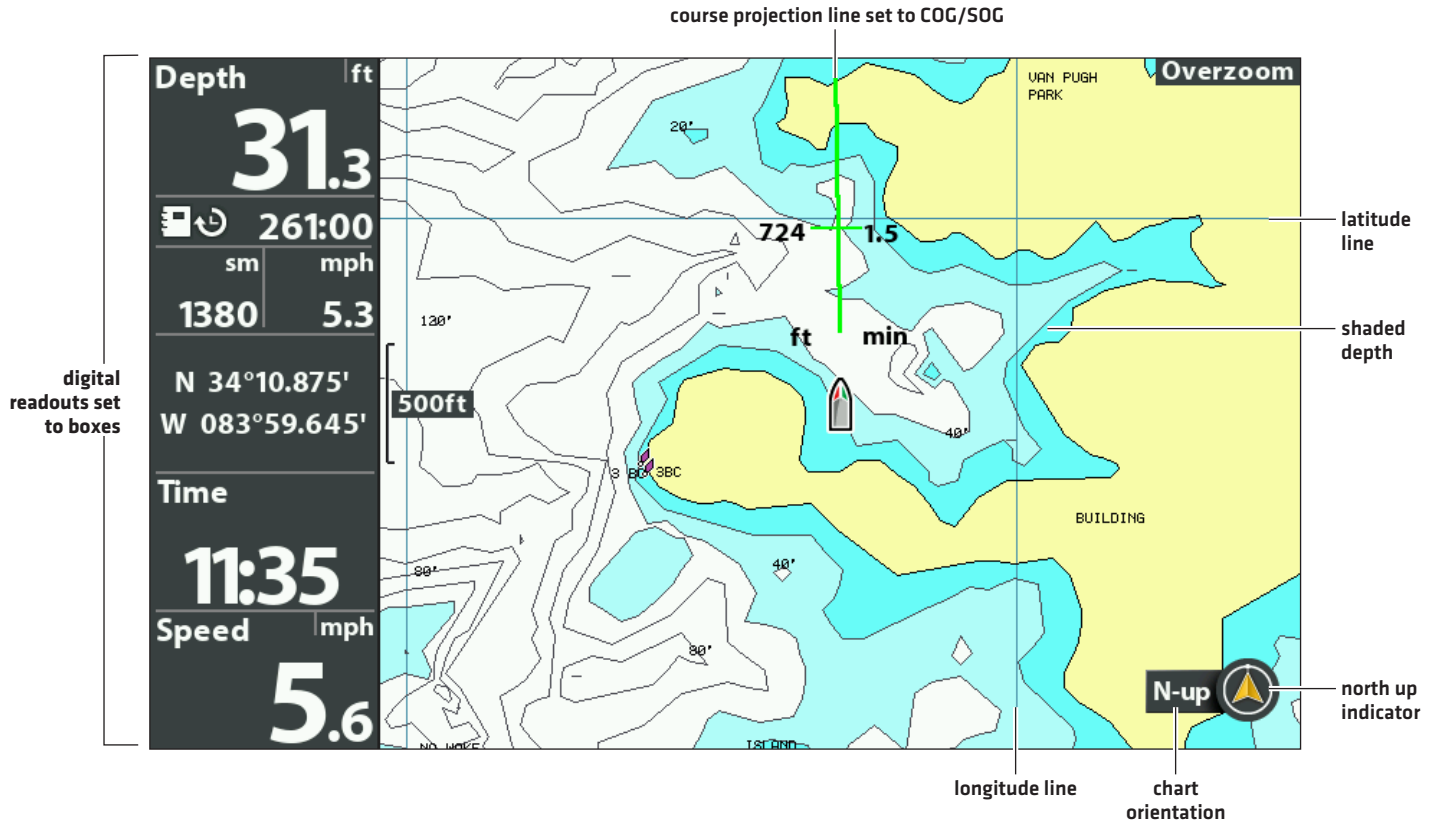



 **NOTE:** Digital readouts can be displayed as an overlay, or they can be displayed in data boxes [see *Views: Display Digital Readouts*].

# CUSTOMIZE THE CHART VIEW

The settings in this section are optional. You can use the default settings for the chart appearance and map source, or you can customize the Chart View.

## Customizing the Chart View (Map Source: Contour XD)



 **NOTE:** Digital readouts can be displayed as an overlay, or they can be displayed in data boxes [see **Views: Display Digital Readouts**].

## Change the Background Color

The Background menu changes the color of the background on the view. This menu also changes the background color for the Bird's Eye View.

1. Press the POWER key.
2. Select Background.
3. Select a color.

## Show/Hide the North Up Indicator Icon

The North Up Indicator displays the direction of True North. The icon also displays the chart orientation, and it will change as the orientation and the data source change. To set the Chart Orientation, see **Change the Chart Orientation and Motion Mode**.

1. **Main Menu:** Press the MENU key twice. Select the **Chart** tab.
2. Select North Up Indicator.
3. Select Off [hidden] or On [visible].

## Show/Hide the Course Projection Line

The course projection line is an arrow or line extending from the bow of the boat icon. It projects the current course and shows where the boat will go if you continue on your present course.

1. **Main Menu:** Press the MENU key twice. Select the **Nav** tab.
2. Select Course Projection Line.
3. Select a display setting.

<b>Hidden</b>	The Course Projection line will not be displayed.
<b>Standard</b>	arrow
<b>Single Vector</b>	line
<b>COG/SOG</b>	A line with tick marks will be displayed at set intervals from the boat. The tick marks are based on the speed calculation.

## Show/Hide Latitude/Longitude Lines

Use the following instructions to show or hide latitude and longitude lines on the Chart View.

1. **Main Menu:** Press the MENU key twice. Select the **Chart** tab.
2. Select Lat/Lon Grid.
3. Select Visible or Hidden.

## Adjust the Depth Shading

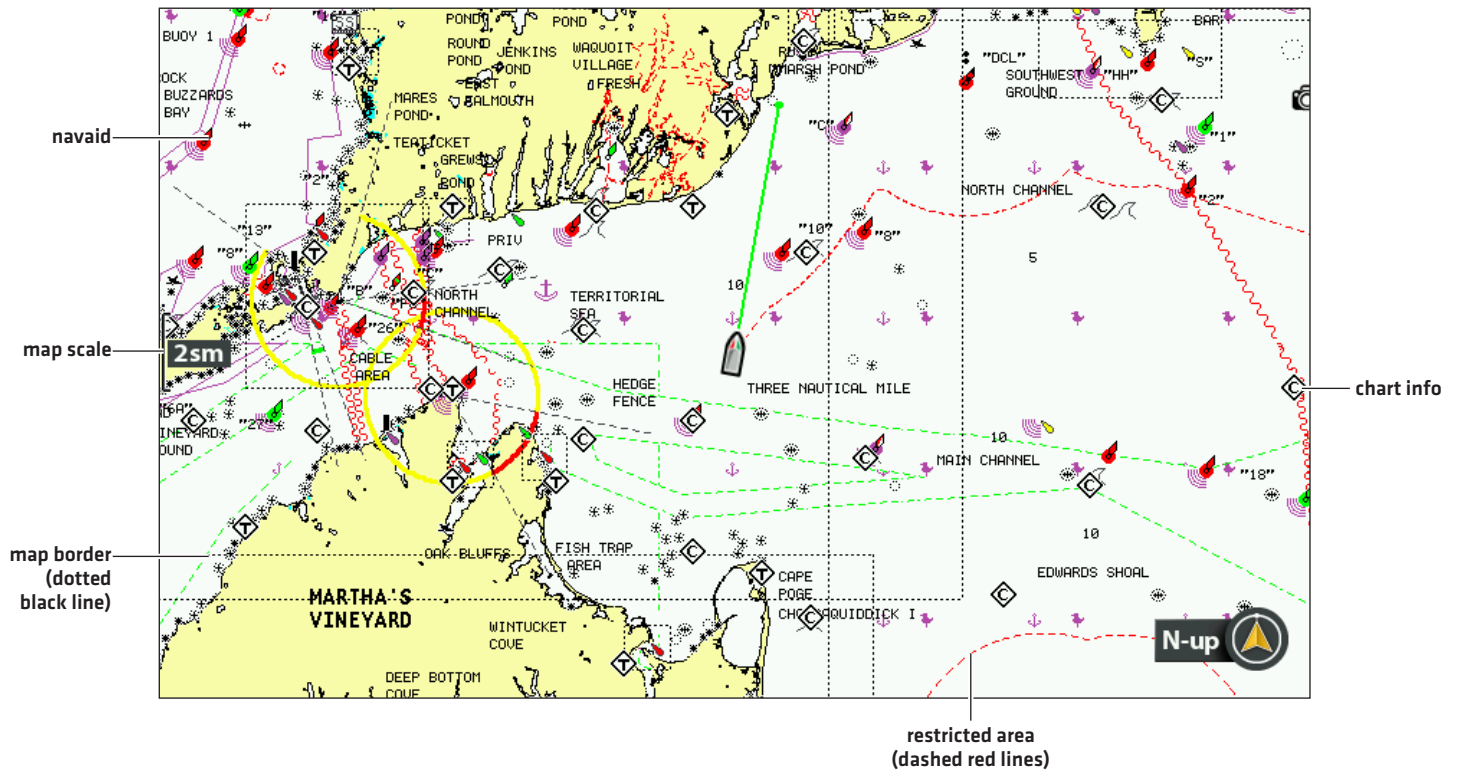
Shaded Depth allows you to change the depth used for shading on the Chart View. The available settings are determined by the installed map card and selected map source.

1. **Main Menu:** Press the MENU key twice. Select the **Chart** tab.
2. Select Shaded Depth.
3. Press the RIGHT or LEFT Cursor keys to adjust the setting.

## Customize the Chart Detail Level

Use the following instructions to add or hide chart details and nav aids on the Chart View and the Bird's Eye View.

### Navionics Chart Displayed with Chart Detail set to Navigation



## Select a Chart Detail Level

Chart Detail Level allows you to add details and layers to the chart views. The available settings are determined by the installed map card and selected map source.

1. **Main Menu:** Press the MENU key twice. Select the **Chart** tab.
2. Select Chart Detail Level.
3. Press the RIGHT or LEFT Cursor keys to select one of the following:

<b>Basic</b>	shows land areas, ports, obstructions, and restricted areas
<b>Navigation</b>	In addition to the Basic level, Navigation shows nav aids, landmarks, ferryways, and navigation routes.
<b>Underwater</b>	In addition to the Basic and Navigation information, Underwater shows depth contours, fishing areas, underwater wrecks, tides, and currents.
<b>Custom (Custom User Mode)</b>	Select Custom to select specific chart detail layers. You can show or hide chart layers such as navigation canals, boundaries, restricted areas, coastline, bridges, and more. See <b>Select Custom Chart Layers</b> .

## Select Custom Chart Layers

1. **Main Menu [Custom User Mode]:** Press the MENU key twice. Select the **Chart** tab.
2. Select Chart Detail Level.
3. Select Custom.
4. Press the DOWN Cursor key.
5. Select Custom Chart Layers. Press the RIGHT Cursor key.
6. Use the Cursor key to select a layer and turn it on [visible] or off [hidden].

## Simplify the Chart Detail Level

Use Chart Declutter to remove all chart layers except for land outlines, waypoints, routes, and tracks. The chart will clear for 10 seconds, and then it will refresh to its previous display settings.

1. **Chart X-Press Menu:** With a Chart View displayed on-screen, press the MENU key once.
2. Select Chart Declutter.
3. Press the RIGHT Cursor key.

## Show/Hide Map Borders

The dotted lines of a map border indicate an area that contains a different map. See **Select a Map Source: Select a New Map** for details. The available settings are determined by the installed map card and selected map source.

1. **Main Menu:** Press the MENU key twice. Select the **Chart** tab.
2. Select Map Borders.
3. Select Hidden, MMC/SD only, or All Visible.

## Show/Hide Spot Soundings

Spot Soundings are depth measurements shown on the chart. The available settings are determined by the installed map card and selected map source.

1. **Main Menu:** Press the MENU key twice. Select the **Chart** tab.
2. Select Spot Soundings.
3. Select Visible or Hidden.

## Increase the Text Size

Turn on Easy View Text to increase the size of the text displayed on the chart view. The available settings are determined by the installed map card and selected map source.

1. **Main Menu:** Press the MENU key twice. Select the **Chart** tab.
2. Select Easy View Text.
3. Select On or Off.

# DISPLAY CHART OVERLAYS

(LAKEMASTER PLUS MAP CARD AND CHARTSELECT MAPS ONLY)

If you purchased a Humminbird LakeMaster PLUS map card or ChartSelect lake maps [that are saved to an encrypted SD card], you can select a base layer and add overlays to the Chart View to add more detail to your map.

The available settings are determined by the installed map card and selected map source. The LakeMaster map card or SD card with ChartSelect chart layers must be selected as the map source. See **Select a Map Source: Select a New Map** for details.



**NOTE:** Overlays cannot be used when Humminbird Basemap or ContourXD is selected as the map source.

## Display/Hide a Base Layer

Use the following instructions to change the Base Layer for the Chart View. The selected Base Layer will also be applied to the left window of the Chart/Chart Combo View and the Chart window in Chart Combo Views.

1. **Main Menu:** Press the MENU key twice. Select the **HB Chart** tab.
2. Select Base Layer. Press the RIGHT Cursor key.
3. Select 2D Map or Aerial.

To remove the selected Base Layer, select Base/Overlay Reset.

## Display/Hide Overlays

Use the following instructions to select a chart overlay for the Chart View. The selected Base Layer will also be applied to the left window of the Chart/Chart Combo View and the Chart window in Chart Combo Views.

1. **Main Menu:** Press the MENU key twice. Select the **HB Chart** tab.
2. Select Overlay Options. Press the RIGHT Cursor key.
3. Select Map Overlay.
4. Select 2D Map or Aerial.

To remove the selected overlay, select Off.

## Adjust the Overlay Transparency

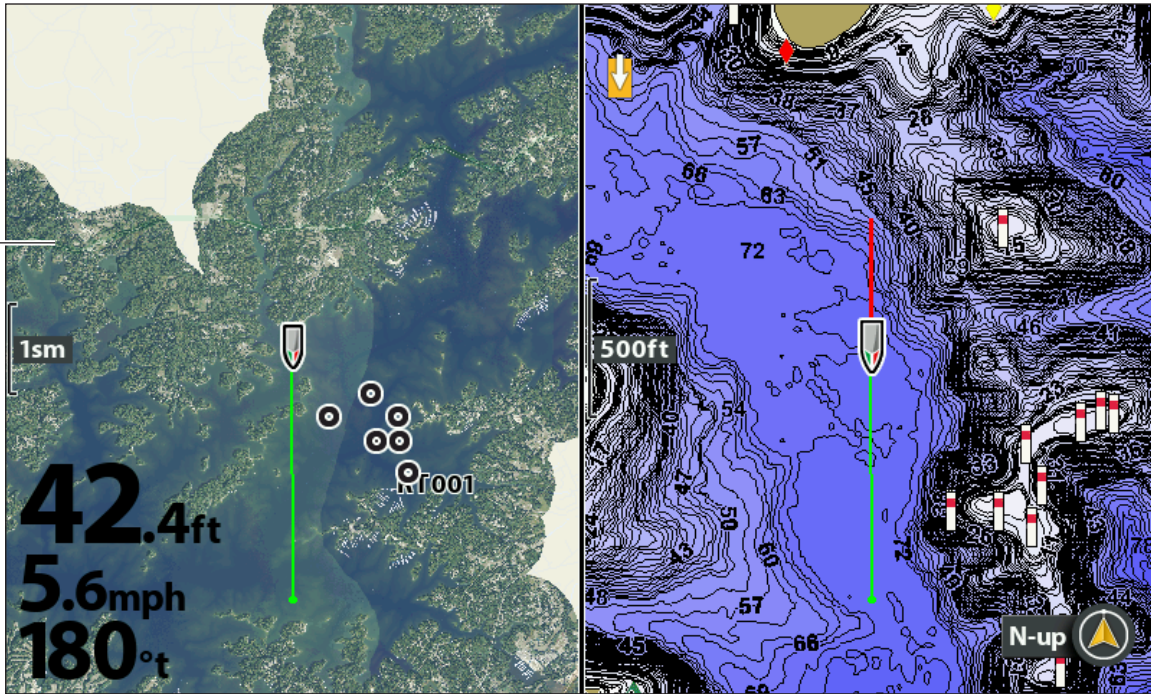
Use the following instructions to adjust the transparency of the displayed overlay.

1. **Main Menu:** Press the MENU key twice. Select the **HB Chart** tab.
2. Select Overlay Options.
3. Select Overlay Transparency.



Chart/Chart Combo View with Base Layer (set to 2D) and Overlay (set to Aerial)

The selected Base Layer will be applied to the left window.



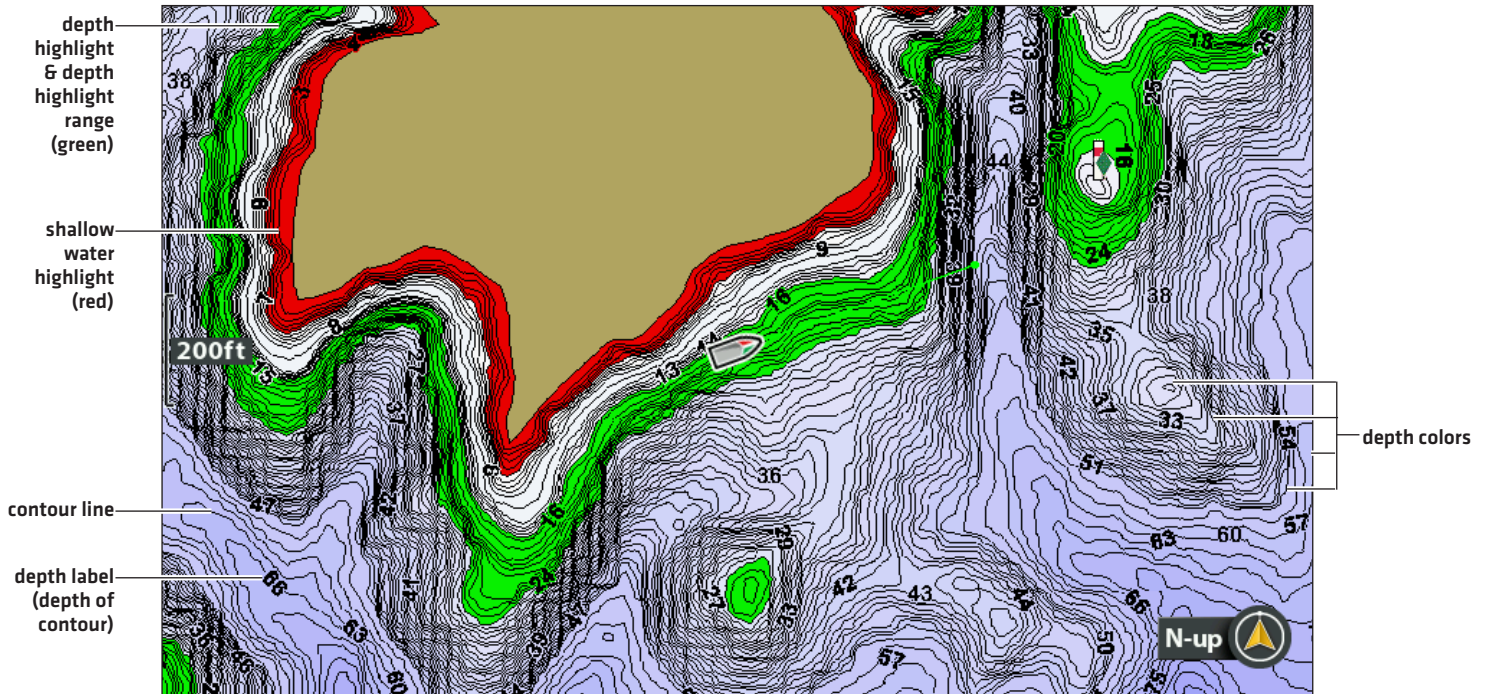
# DISPLAY HUMMINBIRD LAKEMASTER CONTOUR LINES AND DEPTH RANGES

When you install a LakeMaster Map Card or LakeMaster PLUS Map Card, menu options are added to the HB Chart Menu tab. You can display or hide contour lines, highlight shallow water, and highlight a depth range on the map.



**NOTE:** A Humminbird LakeMaster map card must be installed and selected as the map source to enable these features. For details and additional features related to your LakeMaster map card, visit our Web site.

## Adjusting the LakeMaster Display Settings



See More of Contour Lines  
and Depth Colors

## Show/Hide Contour Lines

Display or hide the water contour lines in the Chart View. This feature is also affected by the Water Level Offset setting. See **Select a Map Source: Set up Humminbird LakeMaster**.

1. **Main Menu:** Press the MENU key twice. Select the **HB Chart** tab.
2. Select Contour Lines.
3. Select Hidden or Visible.

## Turn on Depth Colors

Set the depth shading in the Chart View to Off or shaded.

1. **Main Menu:** Press the MENU key twice. Select the **HB Chart** tab.
2. Select Depth Colors.
3. Press the RIGHT or LEFT Cursor keys to adjust the setting.

## Highlight a Depth Range

Depth Highlight allows you to identify a depth in the Chart View. You can also adjust the range on each side of the depth using Depth Highlight Range. The depth range you set is highlighted in green on the chart.

For example, if you know a certain fish is holding at 18 to 20 feet, you can set the Depth Highlight to 19 feet and the Depth Highlight Range to +/- 1 foot. The view will show a green band from 18 to 20 feet.

1. **Main Menu:** Press the MENU key twice. Select the **HB Chart** tab.
2. Select Depth Highlight.
3. Press the RIGHT or LEFT Cursor keys to select a depth.
4. To highlight the range on both sides of the selected depth, press the DOWN Cursor key. Select Depth Highlight Range.
5. Press the RIGHT or LEFT Cursor keys to select a range.

## Highlight a Shallow Water Range


When the depth is equal to or less than the amount you set, it will be highlighted in red on the Chart View.

For example, if your boat has a draft of 3 feet, set the Shallow Water Highlight to 3 feet, and a red band from 0 to 3 feet will be shown on the map.

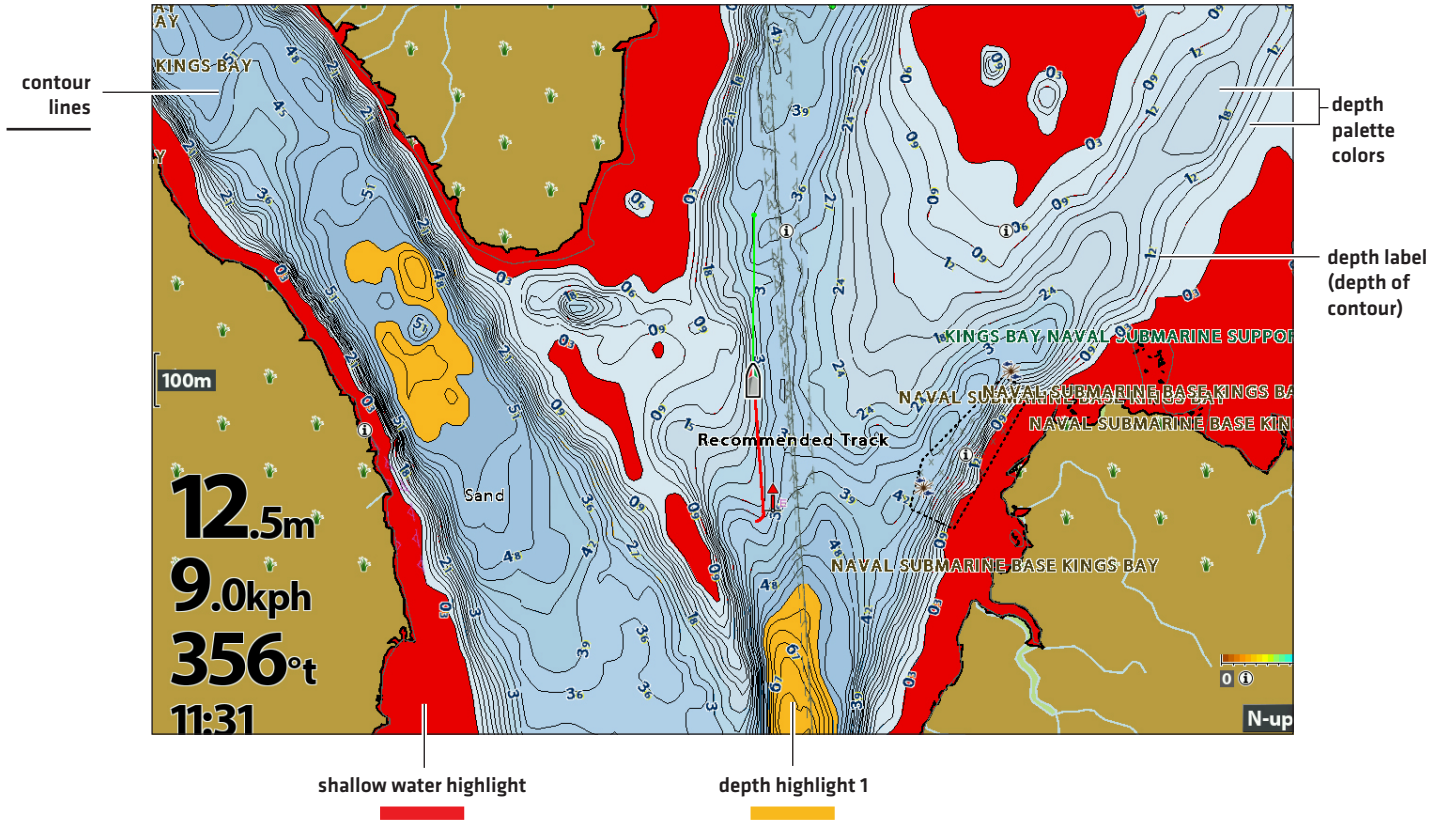
1. **Main Menu:** Press the MENU key twice. Select the **HB Chart** tab.
2. Select Shallow Water Highlight.
3. Press the RIGHT or LEFT Cursor keys to select a depth.

# DISPLAY HUMMINBIRD COASTMASTER CONTOUR LINES AND DEPTH RANGES

When you install a CoastMaster Chart Card, menu options are added to your control head. You can display or hide contour lines, highlight shallow water, and highlight a depth range on the map.

 **NOTE:** A Humminbird CoastMaster map card must be installed and selected as the map source to enable these features. For details and additional features related to your CoastMaster map card.

## Adjusting the CoastMaster Display Settings



See More of Contour Lines  
and Depth Colors

## Show/Hide Contour Lines

Display or hide the water contour lines in the Chart View. This feature is also affected by the Water Level Offset setting. See *Prepare the Control Head for Mapping: Adjust the Water Level Offset*.

1. **Main Menu:** Press the MENU key twice. Select the **HB Chart** tab.
2. Select Depth/Contours.
3. Select Contour Lines.
4. Press the CHECK/INFO key or the RIGHT Cursor key to show or hide contour lines. [check mark = visible, blank = hidden]

## Turn on Depth Colors

Set the depth shading in the Chart View to Off or shaded.

1. **Main Menu:** Press the MENU key twice. Select the **HB Chart** tab.
2. Select Depth/Contours.
3. Select Depth Palettes.
3. Press the CHECK/INFO key or the RIGHT Cursor key to show or hide depth colors [check mark = visible, blank = hidden]

## Highlight a Depth Range

Depth Highlights allow you to select up to four depth ranges to be highlighted on the chart.

1. **Main Menu:** Press the MENU key twice. Select the **HB Chart** tab.
2. Select Depth Highlights.
3. Press the RIGHT or LEFT Cursor keys to display or hide depth highlights.
4. With depth highlights turned on, set your desired depth range by selecting Highlight 1 Min or Highlight 1 Max. Press the RIGHT or LEFT Cursor key to adjust the setting.
5. To turn on an additional highlight, select Highlight 2.
6. Press the CHECK/INFO key or the RIGHT Cursor key to display the highlight. [check mark = visible, blank = hidden]
7. Repeat Step 2 with Highlight 2 Min and Highlight 2 Max to adjust the depth range.
8. Repeat Steps 5-7 for each additional depth highlight [up to four].

## Highlight a Shallow Water Range

The Shallow Water Highlight identifies shallow waters when the depth is equal to or less than the level you set. Depth Highlights must be turned on to enable this feature.

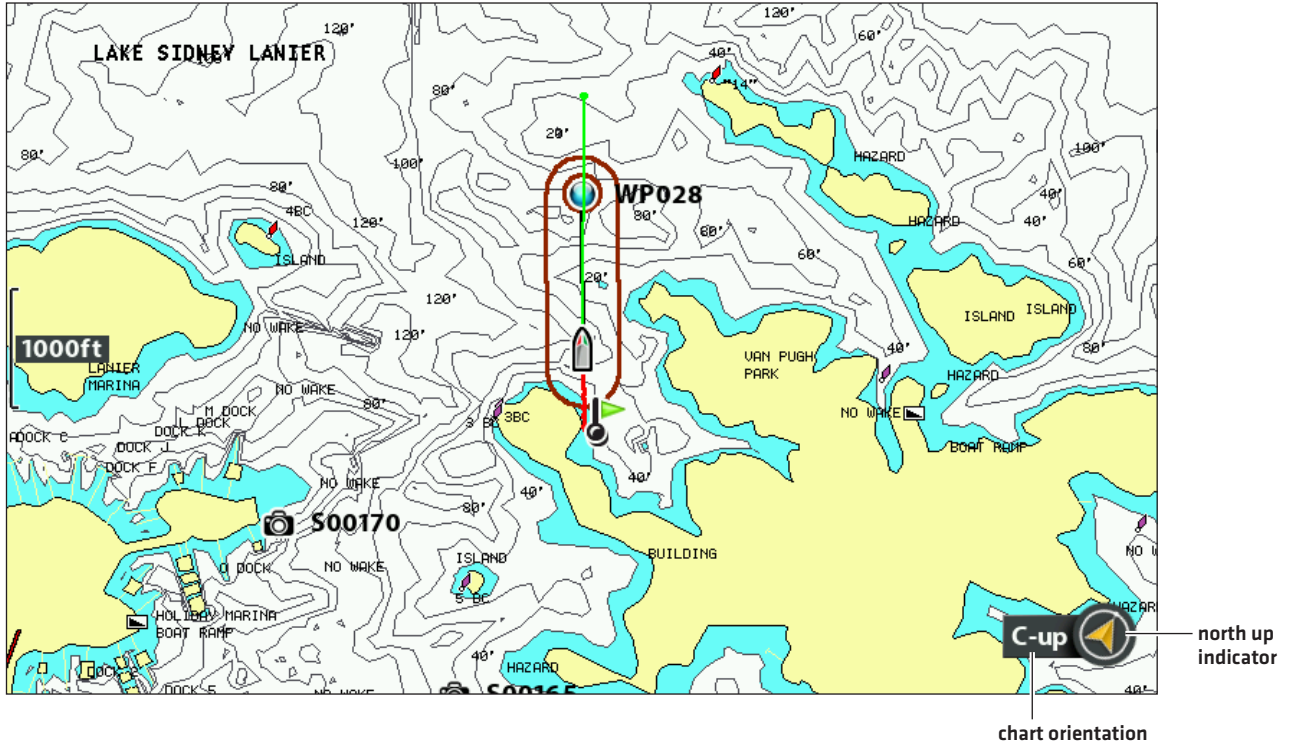
1. **Main Menu:** Press the MENU key twice. Select the **HB Chart** tab.
2. Select Depth Highlights.
3. Select the first Shallow Water Highlight menu option.
4. Press the CHECK/INFO key or the RIGHT Cursor key to show or hide shallow water highlights. [check mark = visible, blank = hidden]
5. To adjust the highlighted depth level, select the second Shallow Water Highlight menu option.
6. Press the RIGHT or LEFT Cursor keys to adjust the setting.

# CHANGE THE CHART ORIENTATION AND MOTION MODE

The Chart View pans automatically so the boat is always centered on the view. The settings in this section allow you to change the chart orientation, zoom the view automatically, set the north reference, and see more or less of the view based on the speed or range setting.

## Set the Chart Orientation

Chart Orientation set to Course Up



### Set the Chart Orientation

1. **Main Menu:** Press the MENU key twice. Select the **Chart** tab.
2. Select Chart Orientation.
3. Select an orientation to apply to the chart.

<p><b>North-Up</b></p>	<p>The chart is oriented with North up on the display, and the boat rotates according to its heading or COG [Course Over Ground].</p>
<p><b>Head-Up [compass or GPS required]</b></p>	<p>The boat's current heading points up, and the chart rotates around the boat icon so that it always points up on the view. The heading is provided by the connected compass/heading sensor. If a compass is not connected, the boat will be oriented according to COG [Course Over Ground].</p>
<p><b>Course-up</b></p>	<p>During navigation, the intended course or route leg is shown at the top of the view. Objects ahead of the boat are drawn above the boat. When the boat is not navigating, the current heading is displayed.</p>

**NOTE:** The North Up Indicator will change as the orientation and data source change. To display the North Up Indicator, see **Customize the Chart View**.

## Set the Bearing North Reference

North Reference allows you to have the bearing displayed as True North or Magnetic North.

1. **Main Menu:** Press the MENU key twice. Select the **Chart** tab.
2. Select North Reference.
3. Select True North or Magnetic North.

## Turn on/off Auto Zoom

Turn on Auto Zoom to zoom the Chart View automatically based on the speed of the boat. As the boat's speed increases, the chart range will increase.



**NOTE:** The settings in this section do not apply to the Bird's Eye View.

1. **Main Menu (Custom User Mode):** Press the MENU key twice. Select the **Chart** tab.
2. Select Auto Zoom.
3. Select On or Off.

**Zoom In/Out:** If Auto Zoom is turned on, you can press the +/- ZOOM keys to see more or less of the view, and Auto Zoom will resume after 20 seconds. To use only the +/- ZOOM keys to adjust the chart range, turn off Auto Zoom.

## Turn on/off Auto Range

Turn on Auto Range to set the chart scale to the lowest range so that only the boat icon and the next waypoint in the route are shown. If Auto Range is turned on, Auto Zoom will be turned off.



**NOTE:** The settings in this section do not apply to the Bird's Eye View.

1. **Main Menu (Custom User Mode):** Press the MENU key twice. Select the **Chart** tab.
2. Select Auto Range.
3. Select On or Off.

**Zoom In/Out:** If Auto Range is turned on, you can press the +/- ZOOM keys to see more or less of the view, and Auto Range will pause. To resume using Auto Range, press and hold the +/- ZOOM keys.

## Turn on Vessel Offset

Vessel Offset allows you to see more of the Chart View based on the speed of the boat. Vessel Offset works with Offset Speed. When the boat is moving below the Offset Speed setting, the boat icon will be displayed in the center of the view. When the boat is moving at or above the Offset Speed setting, the boat icon will move to the edge of the view so more of the Chart View is shown.

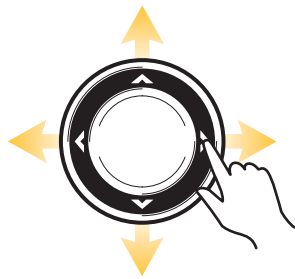
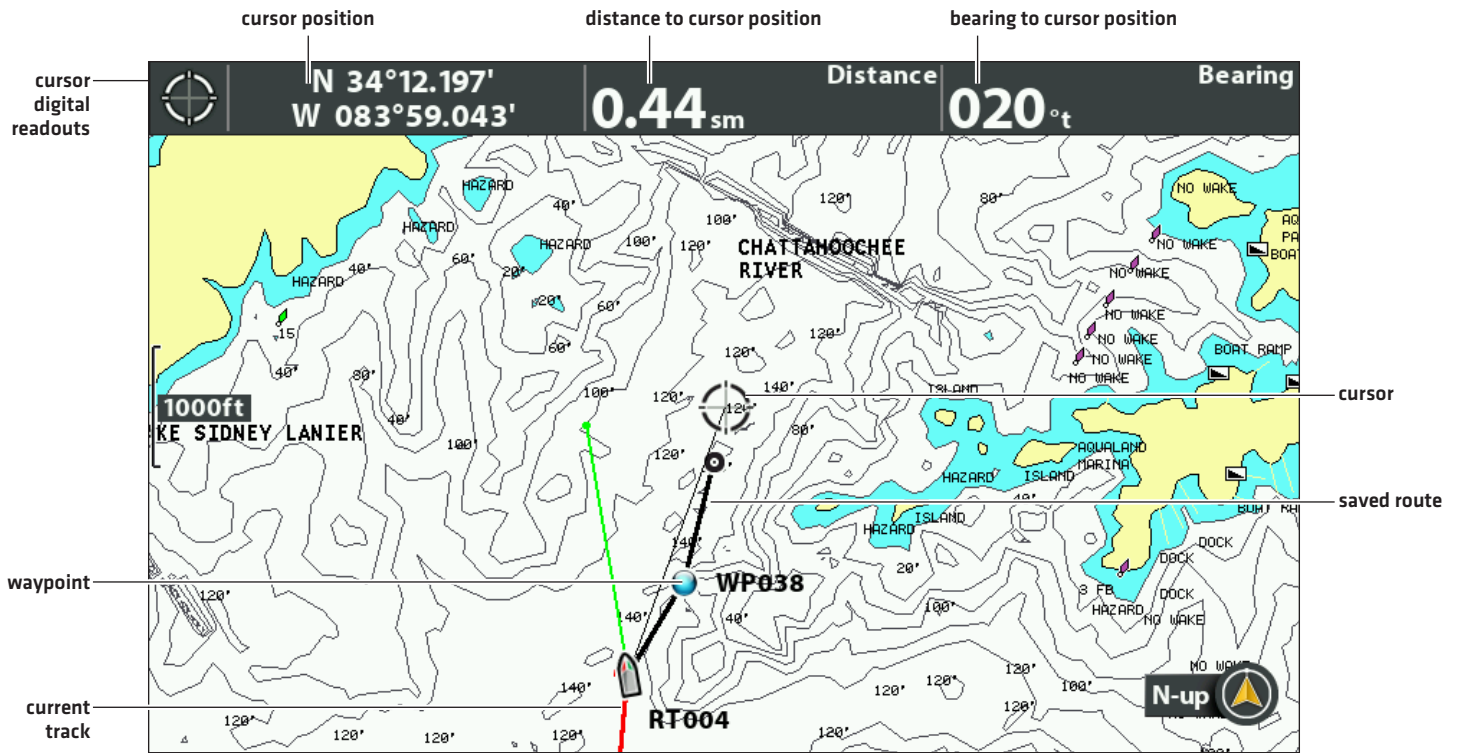
1. **Main Menu (Custom User Mode):** Press the MENU key twice. Select the **Chart** tab.
2. Select Vessel Offset.
3. Select On.
4. Select Offset Speed.
5. Press the RIGHT or LEFT Cursor keys to adjust the setting.

# NAVIGATION OVERVIEW

Your Humminbird control head allows you to mark waypoints, create a route, and start navigating. Waypoints, routes, and tracks can be managed on-screen so you can save your favorites, edit names, and easily return to your favorite destinations.

There are many ways to start navigation or edit navigation data with your Humminbird control head. The instructions in this section review navigation features on the chart views. To use navigation features from the Waypoint Management dialog box, see *Manage your Navigation Data*.

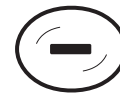
## Moving the Cursor and Zooming in Chart View



Move the Cursor



ZOOM In



ZOOM Out



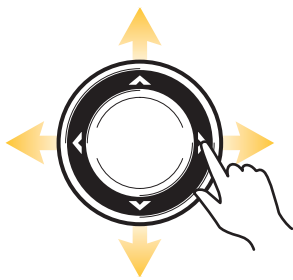
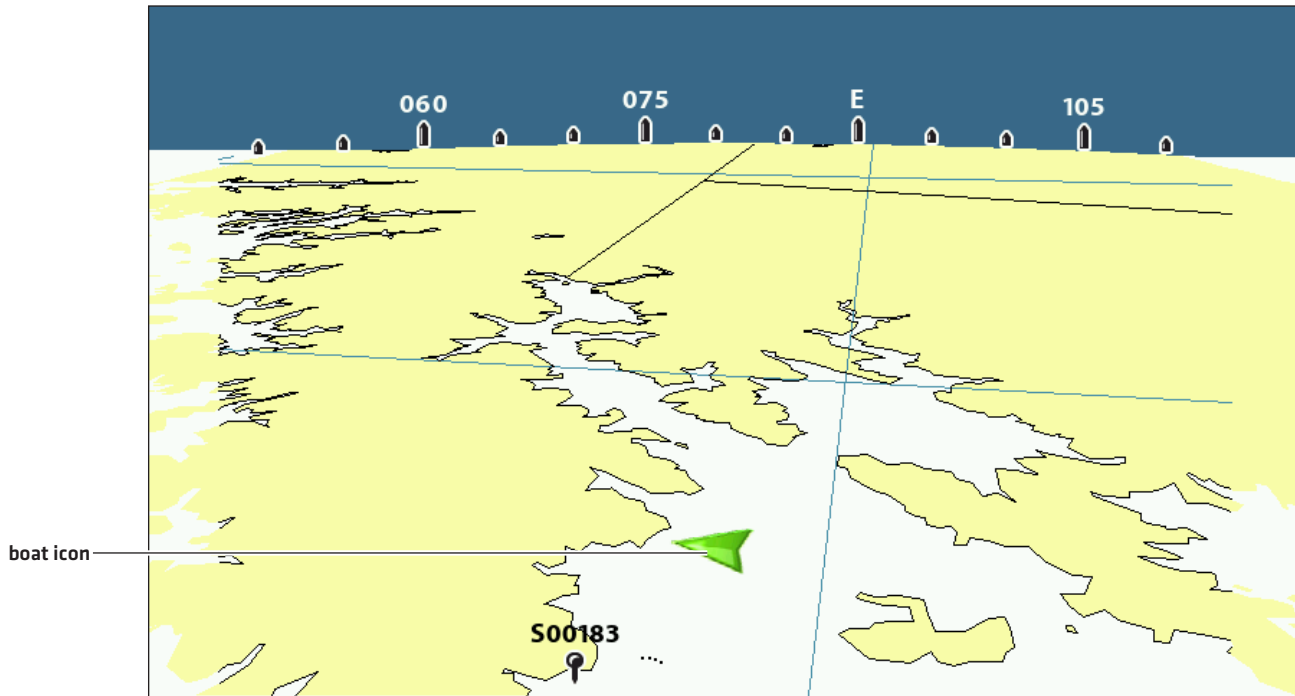
When the boat is stationary, it is drawn as a circle.



When the boat is in motion, it changes to a boat shape, pointed in the direction of motion.



### Shifting the Eye Point and Zooming in Bird's Eye View



Move the Eye Point



ZOOM In



ZOOM Out



Exit

# NAVIGATION ALARMS OVERVIEW

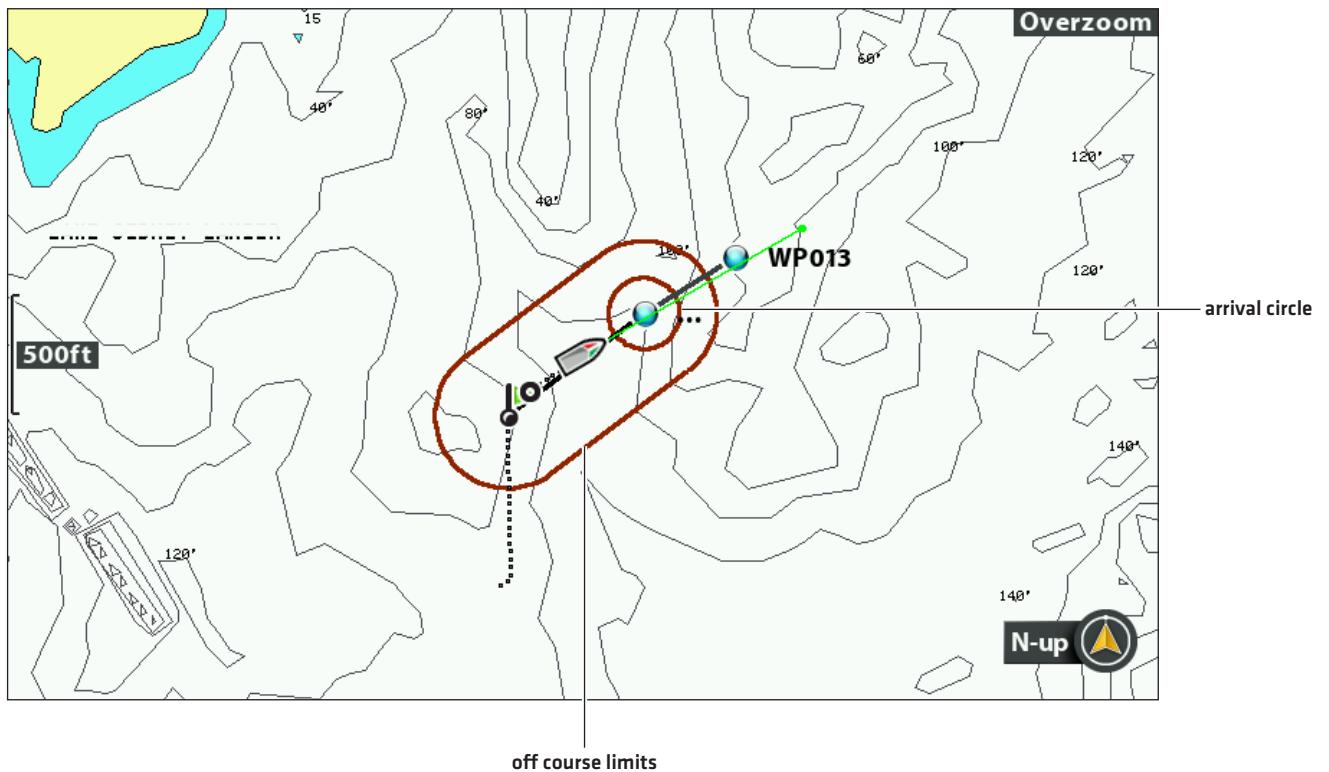
When an alarm is turned on, an alert will sound or display on the control head to indicate the threshold has been exceeded. When you set the Off Course Alarm, Arrival Alarm, and Drift Alarm, the limits are shown on the Chart View.

## Turn on Alarms and Adjust Settings

1. **Main Menu:** Press the MENU key twice. Select the **Alarms** tab.
2. Select an alarm menu. Press the RIGHT or LEFT Cursor keys to adjust the threshold.

<b>Off Course Alarm</b>	Sets how far the boat can move off course during navigation before an alarm will be triggered. GPS required.
<b>Arrival Alarm</b>	Sets how close the boat must be to the destination waypoint before the alarm will be triggered. GPS required.
<b>Drift Alarm</b>	Sets how far the boat can move from its anchored position outside the drift alarm perimeter before an alarm will be triggered. GPS required.

**Off Course Alarm and Arrival Circle**



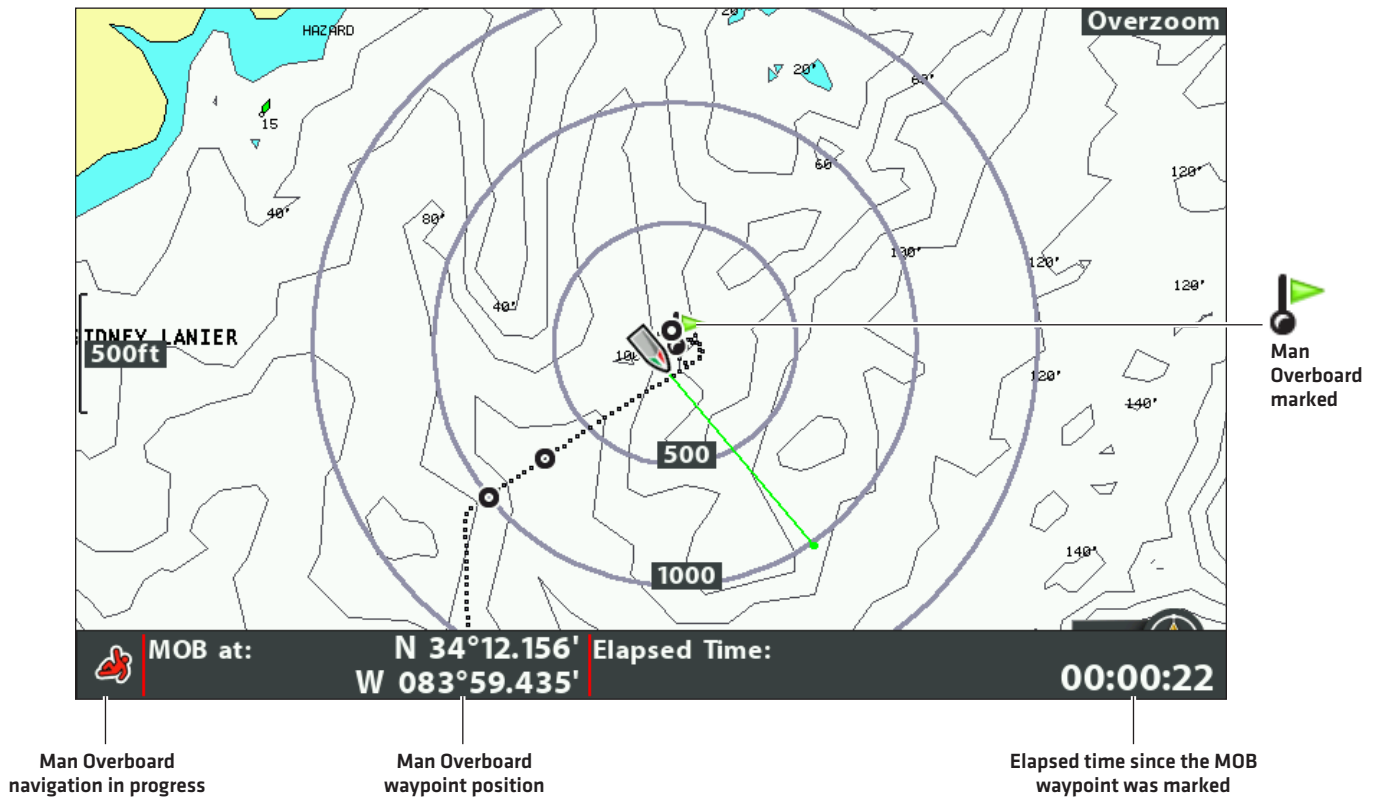
# MAN OVERBOARD (MOB) NAVIGATION

As soon as you know that you have a man overboard [MOB], activate Man Overboard navigation to maximize the chances for a successful rescue. Man Overboard navigation marks the approximate point where the person went overboard and starts continuous navigation toward the Man Overboard waypoint.

## Activate Man Overboard Navigation

1. Press and hold the GOTO/MOB key until Man Overboard Navigation is activated.

### Activating Man Overboard Navigation



Press and hold to start  
MOB navigation

**When Man Overboard is activated**, any current navigation will be cancelled and the current route will be discarded without notification. Man Overboard navigation will begin immediately, and you will see the following on the screen:

**Chart View:** The view will switch to Chart View automatically.

**Man Overboard Waypoint:** A waypoint is created at the boat's current position, regardless of whether the chart cursor is active or not.

**Continuous Navigation:** The control head will start continuous navigation toward the Man Overboard waypoint.

**Auto Zoom:** The screen magnifies to show the Man Overboard waypoint and the boat on the screen.

## Cancel Man Overboard Navigation

1. Press the MENU key.
2. Select Cancel MOB Navigation.

# WAYPOINTS

Waypoints are saved latitude/longitude positions. They mark a position of interest such as your favorite fishing area, structure, or marker buoy. The control head saves the position and allows you to edit the waypoint name, icon, and more [see **Manage your Navigation Data**]. You can save 2,750 waypoints to the control head.

## Customize Waypoint Display Settings

You can use the waypoint settings provided by your control head, or you can customize the waypoints shown on the view. You can also edit waypoints from the Chart View or from the Waypoint Management dialog box [see **Manage your Navigation Data**].

### Change New Waypoint Settings

You can customize waypoint settings for all new waypoints. To edit waypoints after they've been marked, see **Edit a Waypoint in the Chart View** or **Manage your Navigation Data**.

1. **Main Menu:** Press the MENU key twice. Select the **Nav** tab.
2. Select Waypoint Settings. Press the RIGHT Cursor key.
3. Use the Cursor Control key to set the following:

<b>Icon Category</b>	Select a category to assign to new waypoints [All, Geometry, Alerts, Supplies, Navigation, etc.]
<b>Default Waypoint Icon</b>	Select an icon for all new waypoints. To see the most icon options, set the Icon Category to All.
<b>New Waypoint Icon</b>	Select <b>Default</b> , and the system will apply your settings to new waypoints. If you choose <b>Select</b> , each time you mark a waypoint [see <b>Mark Waypoints</b> ], you can change the waypoint icon and category. See <b>Mark and Edit Waypoints [on-the-go]</b> in this section for details.

4. **Save:** Select Save. Press the RIGHT Cursor key.

### Show/Hide Casting Rings

Use Casting Rings to display a circle at a set distance around each waypoint in the Chart View. Casting rings are not applied to decluttered waypoints [see **Declutter Waypoints**].


1. **Main Menu:** Press the MENU key twice. Select the **Nav** tab.
2. Select Casting Rings.
3. Use the RIGHT or LEFT Cursor keys to set how far the casting rings will be displayed from the waypoints.

**Hide:** Select Off to hide the casting rings.

## Show/Hide Waypoint Proximity Flags

Waypoint flags show the distance from the boat [or active cursor] to each waypoint. If set to visible, the waypoint flags for the ten closest waypoints to the boat or cursor will be shown on the Chart View.

1. **Main Menu [Custom User Mode]:** Press the MENU key twice. Select the **Nav** tab.
2. Select Waypoint Proximity Flags.
3. Select Hidden or Visible.

 **NOTE:** Waypoint Proximity Flags are also influenced by the zoom level and boat speed. The flags are displayed if the chart range is less than .5 sm and the boat is traveling less than 15 mph.

## Declutter Waypoints

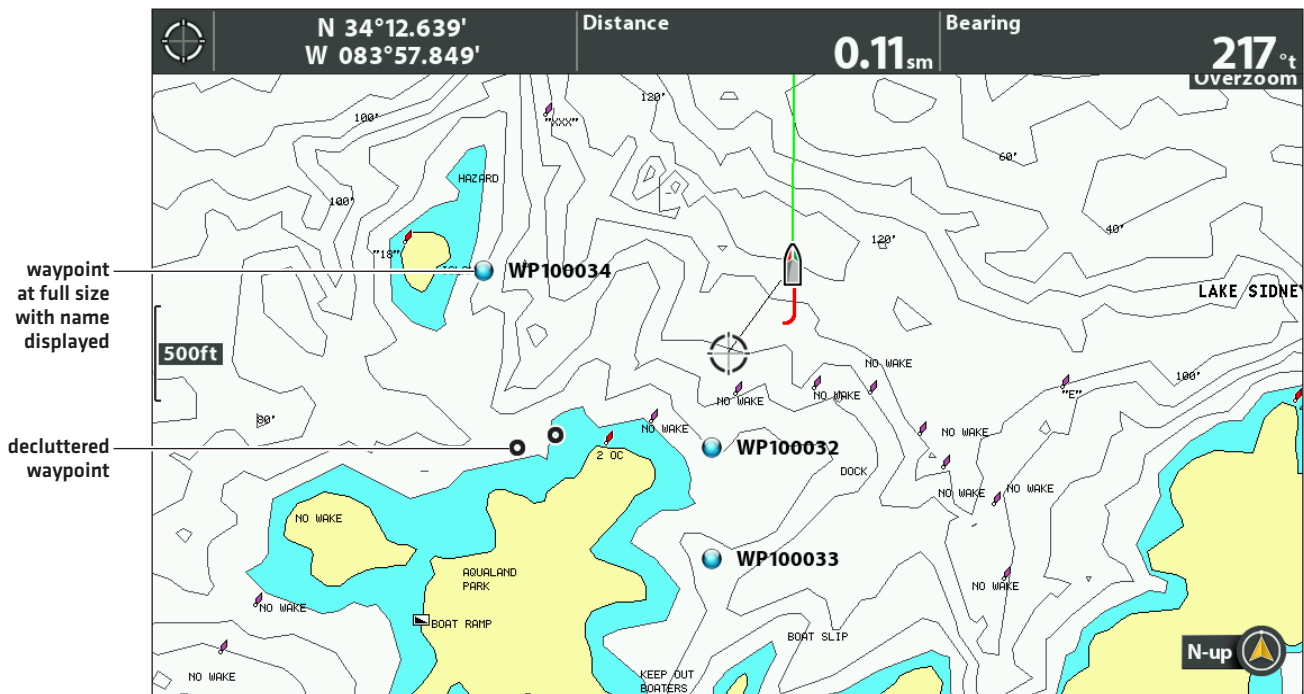
Use Waypoint Decluttering to control how the waypoint icon and name are displayed.

1. **Main Menu [Custom User Mode]:** Press the MENU key twice. Select the **Nav** tab.
2. Select Waypoint Decluttering.
3. Select On or Off.

On	If waypoints are displayed close together, the names will be shortened, and the icons will be displayed as small black icons. To see a decluttered waypoint at full size, select it with the cursor, or press the +ZOOM key repeatedly.
Off	Waypoint names and icons will be displayed at regular size.

 **NOTE:** To increase the text size, see **Customize the Chart View: Increase the Text Size**.

### Waypoints and Decluttered Waypoints



## Mark Waypoints

Waypoints can be marked at the boat position or cursor position. To edit the waypoint, see *Edit a Waypoint in the Chart View* or *Manage your Navigation Data*.

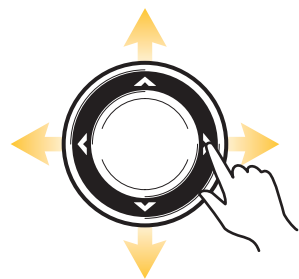
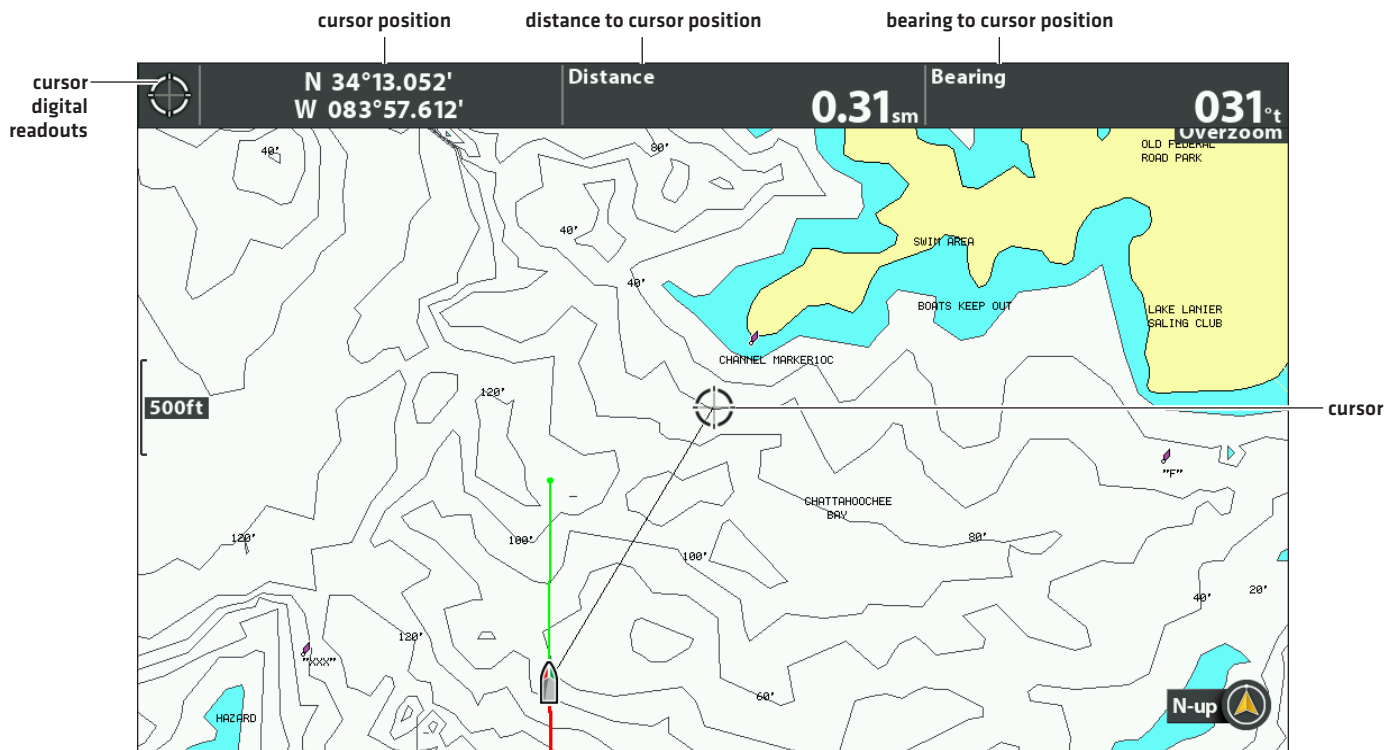
### Mark a Waypoint at the Boat Position

1. Press the MARK key.

### Mark a Waypoint at the Cursor Position

1. Use the Cursor Control key to move the cursor to a position on the chart.
2. Press the MARK key twice.

#### Marking a Waypoint



Move the Cursor



Press Twice to Mark a Waypoint

## Select a Waypoint in the Chart View

You can select a saved waypoint using the menu system or using the cursor on the Chart View.

### Select a Saved Waypoint on the Chart View

1. Use the Cursor Control key to move the cursor to a waypoint on the Chart View.

**Edit:** Press the MENU key. Select the waypoint from the menu. Press the RIGHT Cursor key. Select Edit.

**More Info:** Press the CHECK/INFO key.

**Start Navigation:** Press the GOTO key twice.

2. **Exit Cursor:** Press the EXIT key.

### Select the Last Saved Waypoint

1. Press the MENU key.
2. Select the waypoint name from the X-Press Menu.
3. Press the RIGHT Cursor key.
4. Select a menu from the waypoint menu.

### Search and Select a Saved Waypoint

Use these instructions to search quickly for a waypoint, which is helpful if you cannot locate it on the Chart View.

1. **Chart X-Press Menu:** With a Chart View displayed on-screen, press the MENU key once.
2. Select Cursor to Waypoint. Press the RIGHT Cursor key.
3. Use the Cursor Control key to sort the list.
4. Select the waypoint name from the menu. Press the RIGHT Cursor key.
5. Press the EXIT key once.
6. The cursor will select the waypoint on the Chart View.

**Edit:** Press the MENU key. Select the waypoint from the menu. Press the RIGHT Cursor key. Select Edit.

**More Info:** Press the CHECK/INFO key.

**Start Navigation:** Press the GOTO key twice.



## Edit a Waypoint

You can edit a waypoint as you mark it or after it is saved. The instructions in this section show you how to edit a waypoint in the Chart View. To edit a waypoint or a group of waypoints from the Waypoint Management dialog box, see *Manage your Navigation Data*.

### Mark and Edit Waypoints (on-the-go)

Use the instructions in this section to edit a waypoint as soon as you mark it.

1. **Setup:** See *Change New Waypoint Settings*. Set the New Waypoint Icon menu to **Select**.
2. Press the MARK key.

OR

Use the Cursor Control key to move the cursor to a position. Press the MARK key twice.

3. **Edit:** When you mark a waypoint, the Waypoint Settings menu will display so you can edit the waypoint.

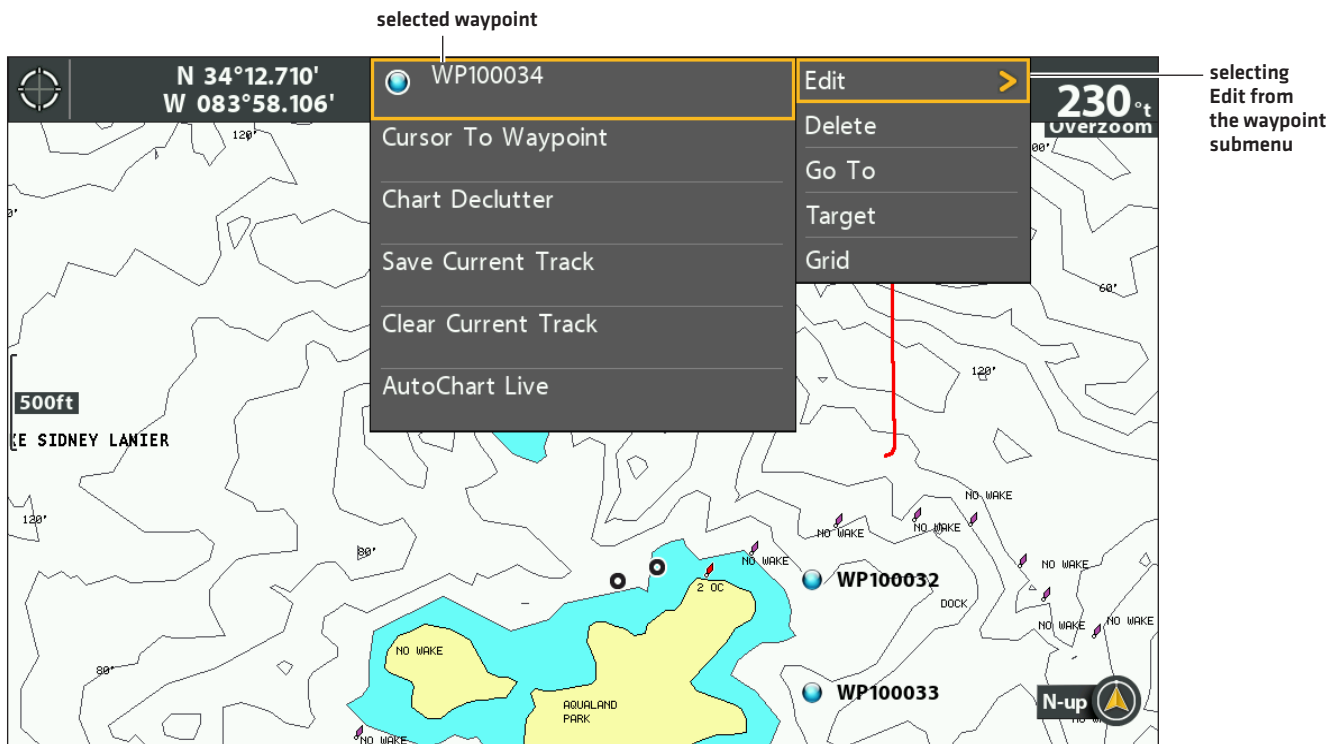
**No Changes:** To proceed without making changes, press the MARK key [again].

### Edit a Waypoint in the Chart View

Use these instructions to edit a waypoint from the Chart View. You can also edit waypoints in the Waypoint Management dialog box [see *Manage your Navigation Data*].

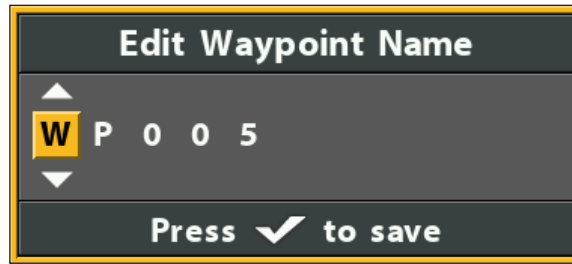
1. Use the Cursor Control key to move the cursor to a waypoint on the Chart View.
2. Press the MENU key.
3. Select the waypoint name from the X-Press Menu. Press the RIGHT Cursor key.
4. Select Edit. Press the RIGHT Cursor key.

#### Editing a Waypoint from the X-Press Menu



5. Use the Edit Waypoint menu to edit the waypoint name, icon, and more [see *Manage your Navigation Data* for more information].

## Changing the Waypoint Name



Move from Space to Space



Select a Letter, Number, or Symbol



Save

6. **Save:** Select Save. Press the RIGHT Cursor key.

7. **Close:** Press the EXIT key.

## Change the Waypoint Position in the Chart View

1. Use the Cursor Control key to move the cursor to a waypoint on the Chart View.
2. Press the MENU key.
3. Select the waypoint name from the X-Press Menu. Press the RIGHT Cursor key.
4. Select Edit. Press the RIGHT Cursor key.
5. Select the latitude position. Press the RIGHT Cursor key.
6. Use the Cursor Control key to enter a new position.
7. **Save:** Press the CHECK/INFO key.
8. Repeat steps 5 through 7 to change the longitude position.
9. **Close:** Press the EXIT key.
10. **Save:** Select Save. Press the RIGHT Cursor key.

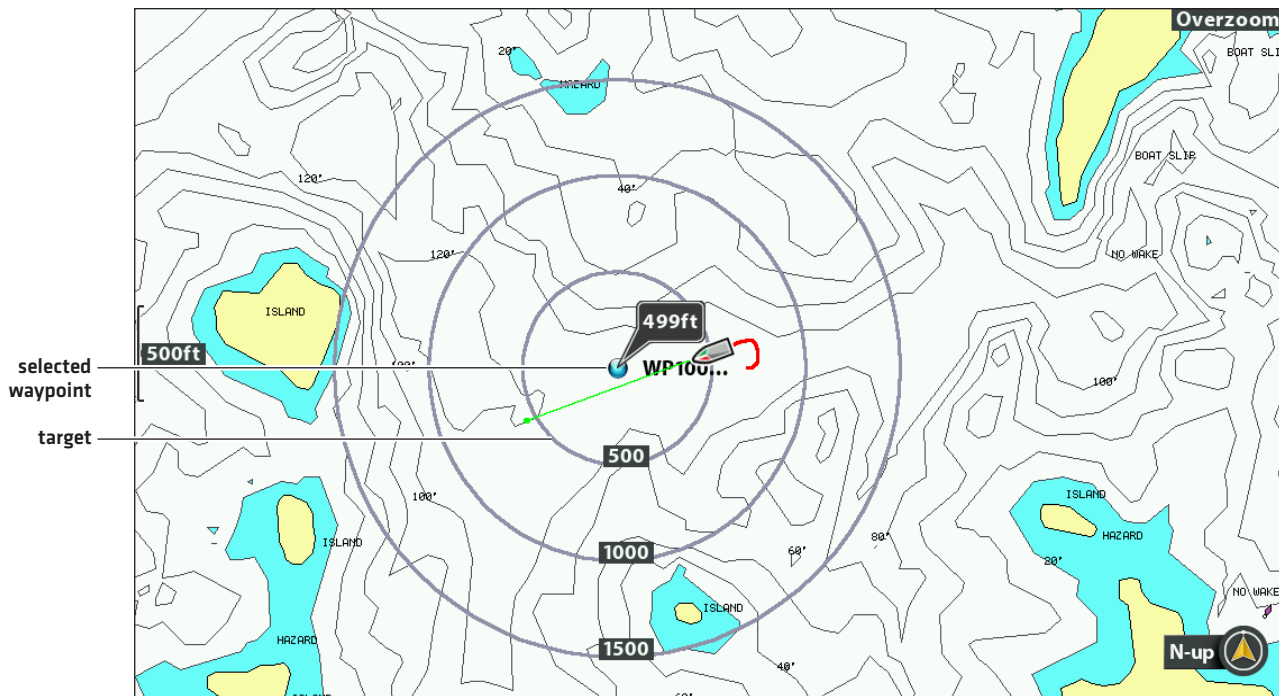
## Show/Hide a Waypoint Target

Use the instructions in this section to display a target around a selected waypoint.

### Display a Target

1. Use the Cursor Control key to move the cursor to a waypoint on the Chart View.
2. Press the MENU key.
3. Select the waypoint name from the X-Press Menu. Press the RIGHT Cursor key.
4. Select Target. Press the RIGHT Cursor key.

## Waypoint with Target Displayed



### Remove a Target

1. **Chart X-Press Menu:** With a Chart View displayed on-screen, press the MENU key once.
2. Select Remove Target. Press the RIGHT Cursor key.

## Show/Hide a Waypoint Trolling Grid

Use the instructions in this section to display a trolling grid on a selected waypoint.

### Display a Trolling Grid

1. Use the Cursor Control key to move the cursor to a waypoint on the Chart View.
2. Press the MENU key.
3. Select the waypoint name from the X-Press menu. Press the RIGHT Cursor key.
4. Select Grid. Press the RIGHT Cursor key.

### Adjust the Trolling Grid Rotation

1. **Main Menu:** Press the MENU key twice. Select the **Nav** tab.
2. Select Trolling Grid Rotation.
3. Press the RIGHT or LEFT Cursor keys to adjust the setting.

### Remove a Trolling Grid

1. **Chart X-Press Menu:** With a Chart View displayed on-screen, press the MENU key once.
2. Select Remove Grid. Press the RIGHT Cursor key.

## Delete a Waypoint in the Chart View

Use the following instructions to select a waypoint and delete it.

1. Use the Cursor Control key to move the cursor to a waypoint on the Chart View.
2. Press the MENU key.
3. Select the waypoint name from the X-Press Menu. Press the RIGHT Cursor key.
4. Select Delete. Press the RIGHT Cursor key.

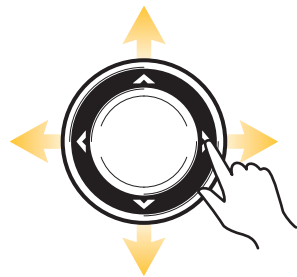
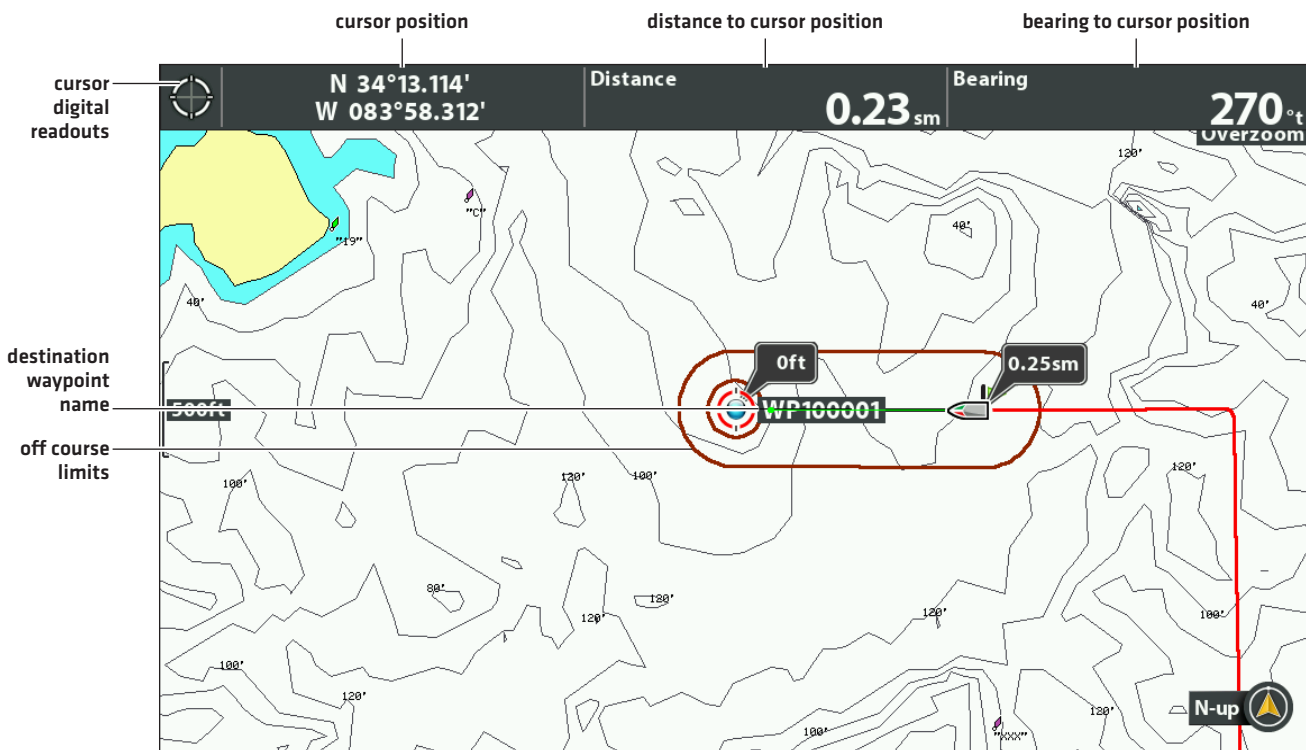
## Navigate to a Waypoint or Position

1. Use the Cursor Control key to move the cursor to a waypoint or position on the chart.
2. Press the GOTO key twice.



**NOTE:** If you are starting navigation to the cursor position, a waypoint will be marked when you press the GOTO key.

### Starting Navigation to the Cursor Position



Move the Cursor



Press Twice to Start Navigation

## Navigate to a Saved Position

If you press the GOTO key, you can choose to start navigation from a list of saved waypoints and routes.

1. Press the GOTO key.
2. Select Nav Data. Press the RIGHT Cursor key.
3. Use the Cursor Control key to select a saved waypoint or route.
4. Press the RIGHT Cursor key to start navigation.

## Navigate Continuously Around a Waypoint

Continuous Navigation Mode allows you to continue to navigate and fish around a selected waypoint, even if you pass over it multiple times.

1. **Main Menu:** Press the MENU key twice. Select the **Nav** tab.
2. Select Continuous Navigation Mode.
3. Select On.
4. Press the EXIT key repeatedly until the menu system is closed.
5. Use the Cursor Control key to move the cursor to a waypoint.
6. Press the GOTO key twice.

# ROUTES

**Routes** link two or more waypoints together to create a path for navigation. A route represents your intended navigation and shows the shortest path from each data point to the next. The distance between each waypoint is a **route leg**. You can save 47 routes [with 50 waypoints each] to the control head.

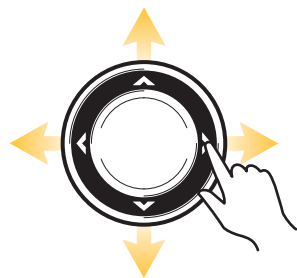
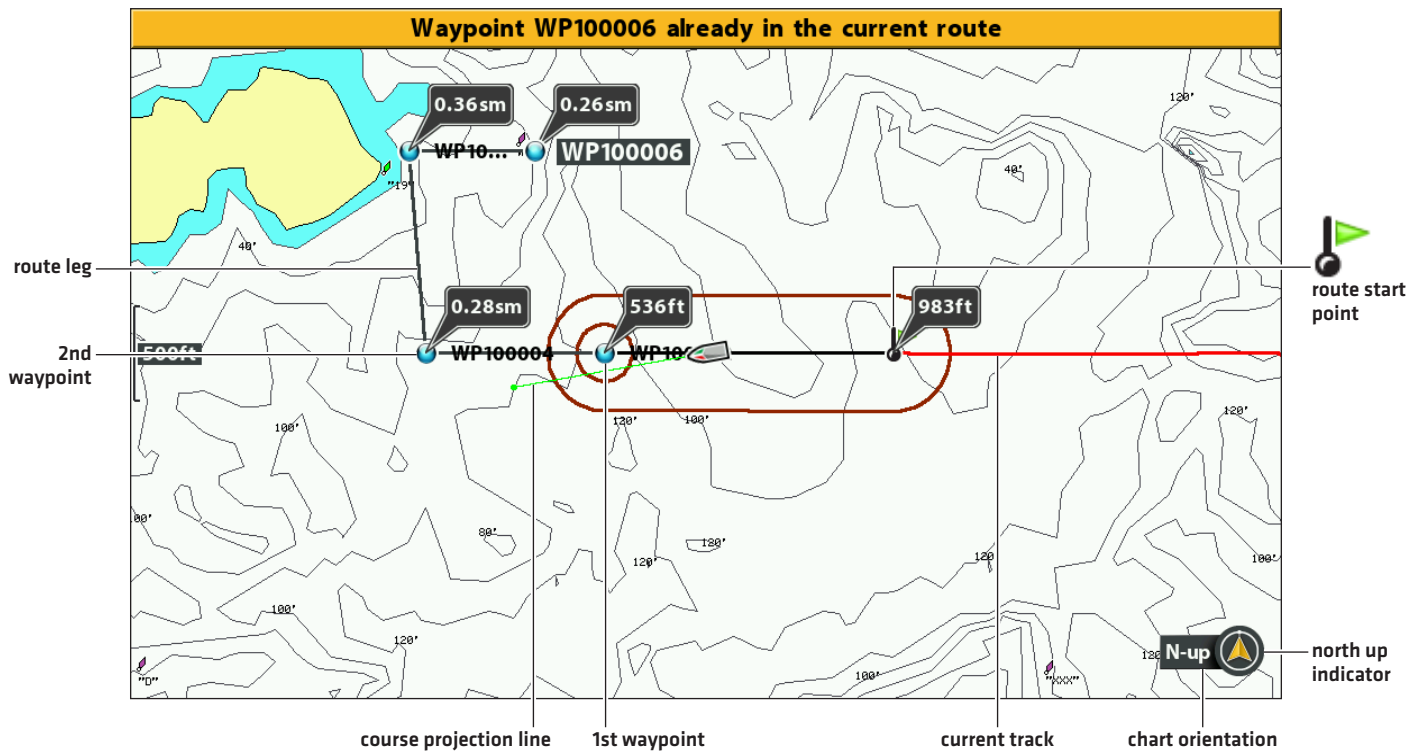
**! WARNING!** You should always be aware of your surroundings and watch for any potential obstacles.

## Create a Route and Start Navigation

Use the instructions in this section to connect waypoints and start navigation immediately. To create a route from the Waypoint Management dialog box, see *Manage your Navigation Data*.

1. Use the Cursor Control key to move the cursor to a waypoint or position on the chart.
2. Press the GOTO key twice.
3. Repeat steps 1 and 2 to add more waypoints to the route.

### Creating and Navigating a Route



Move the Cursor



Press Twice to Start Navigation

## Save the Current Route

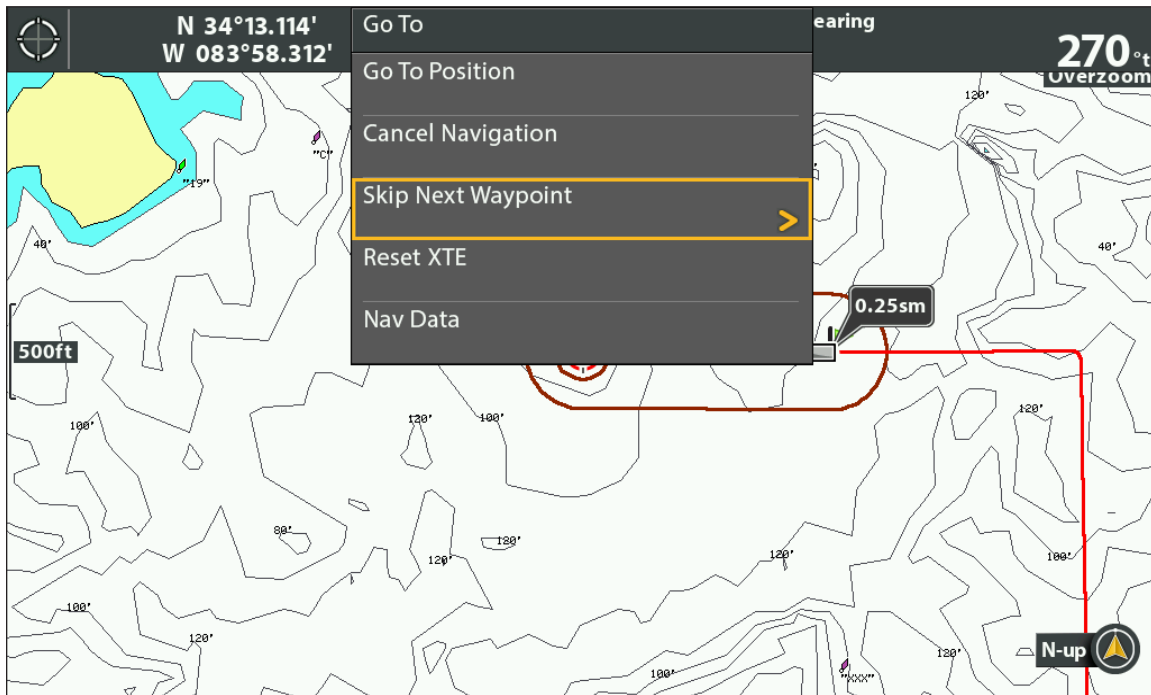
A route must have at least two waypoints to be saved as a route.

1. **Chart X-Press Menu:** With a Chart View displayed on-screen, press the MENU key once.
2. Select Save Current Route. Press the RIGHT Cursor key.
3. Follow the on-screen prompts to save or discard the route.

## Change the Route During Navigation

The X-Press Menu allows you to make changes to the route while you are navigating it.

### Skipping a Waypoint During Navigation



### Skip a Waypoint

1. **Chart X-Press Menu:** With a Chart View or Bird's Eye View displayed on-screen, press the GOTO key once.
2. Select Skip Next Waypoint.
3. Press the RIGHT Cursor key.

### Change the Route Order

The route must be saved before you can change the travel order [see **Save the Current Route**].

1. **Chart X-Press Menu:** With a Chart View or Bird's Eye View displayed on-screen, press the MENU key once.
2. Select the route name. Press the RIGHT Cursor key.
3. Select Travel Forward or Travel Reverse.
4. Press the RIGHT Cursor key.

## Reset XTE (Cross Track Error)

Use Reset XTE to recalculate the cross track error [XTE] from the boat's current position to the next waypoint in the route.

For example, if you've deviated from a route to navigate around an island, select Reset XTE to update the control head's course calculations from the current boat position instead of from the previous waypoint in the route.

1. **Chart X-Press Menu:** With a Chart View or Bird's Eye View displayed on-screen, press the GOTO key once.
2. Select Reset XTE.
3. Press the RIGHT Cursor key.

## Cancel Navigation

1. **Chart X-Press Menu:** With a Chart View displayed on-screen, press the MENU key once.
2. Select Cancel Navigation. Press the RIGHT Cursor key.
3. Follow the on-screen prompts to cancel navigation and save the route.

## Start Navigation on a Saved Route

Use the cursor to select a waypoint in a saved route, and you can start navigation to it. You can also choose the order of navigation.

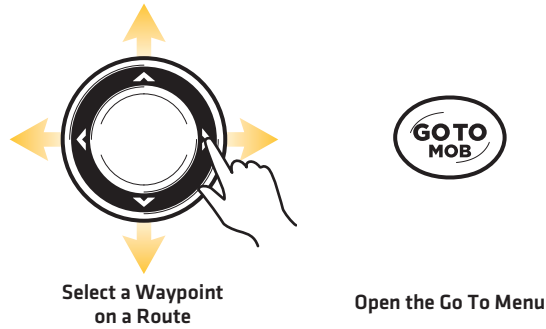
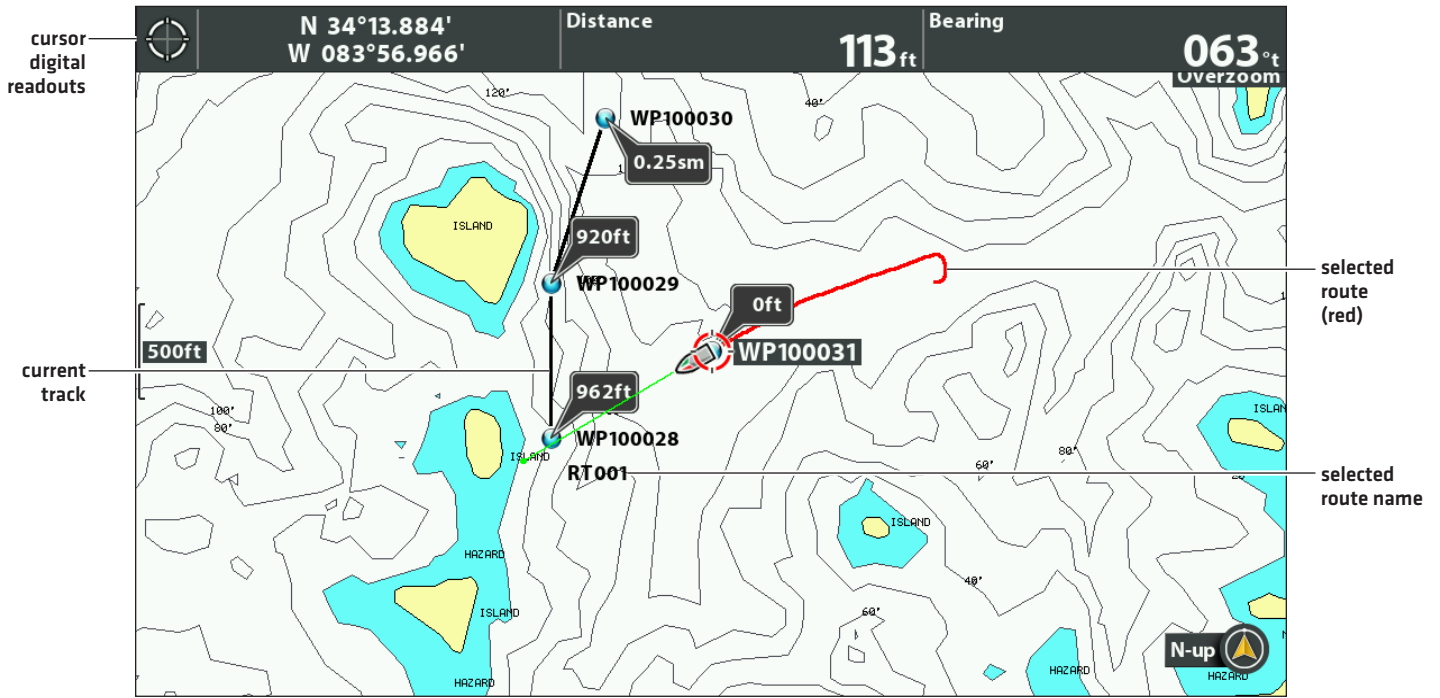
### Start Navigation on a Saved Route

1. Use the Cursor Control key to move the cursor to a waypoint on a route.  
If you select the first waypoint in the route, the route will turn red.
2. Press the GOTO key.
3. Select a travel order.

<b>Go To Point</b>	Start navigation to the selected waypoint only.
<b>Forward from Point</b>	Start navigation to the selected waypoint and continue traveling the route forward from there.
<b>Reverse from Point</b>	Start navigation to the selected waypoint and travel the route in reverse from there.
<b>Travel Forward</b>	Start navigation to the first waypoint in the route and continue traveling the route forward from there.
<b>Travel Reverse</b>	Start navigation to the last waypoint in the route and travel the route in reverse from there.



## Selecting a Saved Route on the Chart View



## Navigate to a Saved Position

If you press the GOTO key, you can choose to start navigation from a list of saved waypoints and routes.

1. Press the GOTO key.
2. Select Nav Data. Press the RIGHT Cursor key.
3. Use the Cursor Control key to select a saved waypoint or route.
4. Press the RIGHT Cursor key to start navigation.

## Edit a Saved Route

You can edit the route name and display it or hide it on the Chart View. To edit routes from the Waypoint Management dialog box, see *Manage your Navigation Data*.

1. Use the Cursor Control key to move the cursor to a waypoint on the route. Press the MENU key.

OR

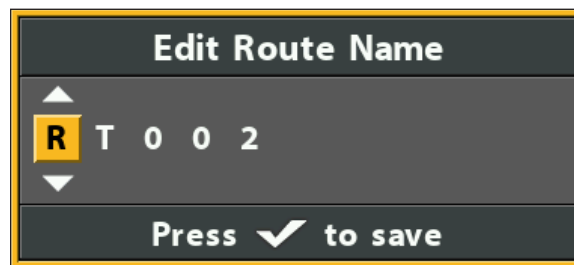
If the route was saved recently, you don't have to select it first. Press the MENU key.

2. Select the route name from the X-Press Menu. Press the RIGHT Cursor key.
3. Select Edit. Press the RIGHT Cursor key.
4. Use the Cursor Control key to change the route name.

**Visibility:** Select Visible or Hidden.

5. **Save:** Select Save. Press the RIGHT Cursor key.

### Changing the Route Name



Move from Space to Space



Select a Letter, Number, or Symbol



Save

## Delete a Saved Route

You can delete a route from the Chart View or the Waypoint Management dialog box. To delete a route from the Waypoint Management dialog box, see *Manage your Navigation Data*.

1. Use the Cursor Control key to move the cursor to a waypoint on the route. Press the MENU key.

OR

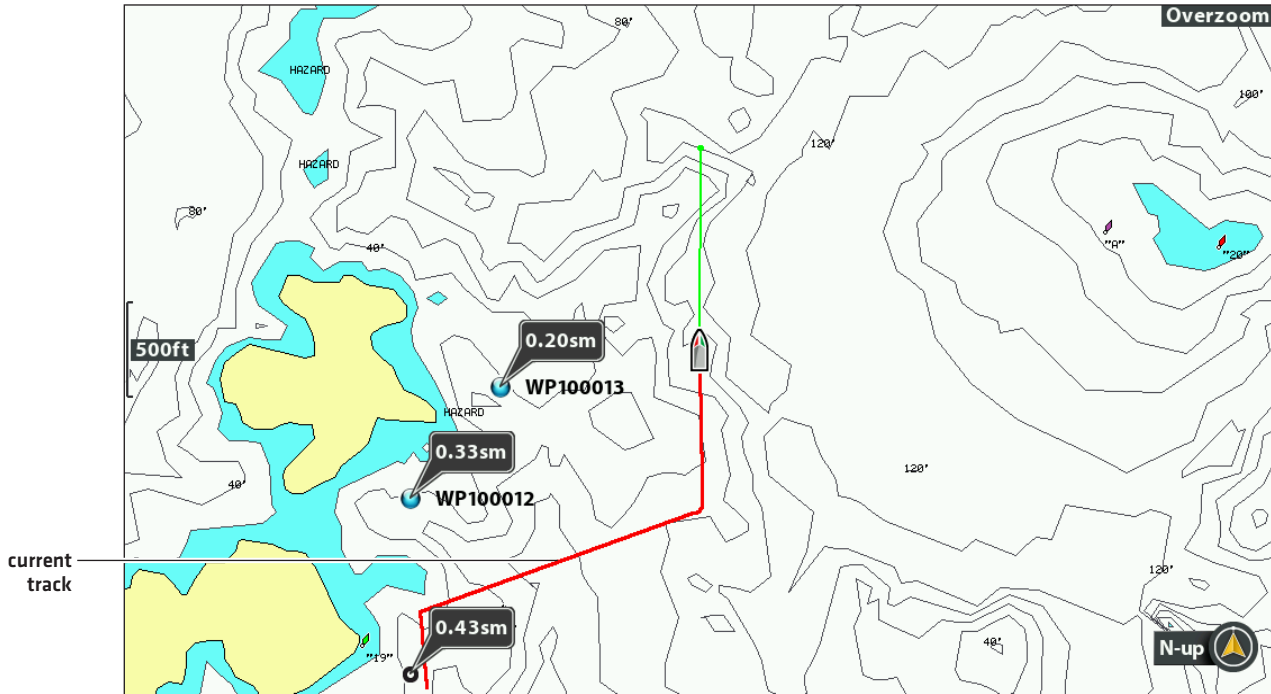
If the route was saved recently, you don't have to select it first. Press the MENU key.

2. Select the route name from the X-Press Menu. Press the RIGHT Cursor key.
3. Select Delete. Press the RIGHT Cursor key.
4. Follow the on-screen prompts to delete the route.

# TRACKS

A track is a collection of track points that contains the boat's detailed position history at set intervals. The Current Track shows the position history since the control head was powered on. You can clear the Current Track or save it at any time. To change the track point interval, edit saved tracks, and create track settings, see *Manage your Navigation Data*. You can save 50 tracks (each with 20,000 track points) to the control head.

Chart View with the Current Track Displayed



## Change New Track Settings

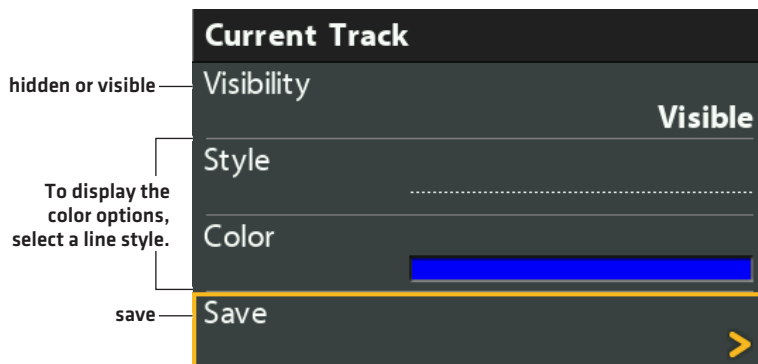
You can use the track settings provided by your control head, or you can customize the tracks shown on the view. You can also edit tracks from the Chart View or from the Waypoint Management dialog box (see *Manage your Navigation Data*).

## Set the Default Track Appearance

Use the instructions in this section to customize settings for all new tracks. To edit tracks after they've been saved, see *Edit the Current Track* and *Manage your Navigation Data*.

1. **Main Menu:** Press the MENU key twice. Select the Nav tab.
2. Select Saved Track Defaults. Press the RIGHT Cursor key.

Changing the Current Track Appearance



3. Use the Cursor Control key to change the following:

<b>Visibility</b>	To show all tracks on the chart, select Visible. To hide tracks, select Hidden. If you choose Hidden, the control head continues to save trackpoints, but the track will not be displayed on the view.
<b>Style</b>	Select a line style [dotted, line, etc.] for all new tracks.
<b>Color</b>	If you select a line style, you can also select the line color.

4. **Save:** Select Save. Press the RIGHT Cursor key.

### Change the Trackpoint Interval and Trackpoint Min Distance

Trackpoint Interval and Track Min [minimum] Distance work together to add a trackpoint to the current track. During slow travel or drift, setting both Trackpoint Interval and Track Min Distance to small values increases the track resolution. Setting the menus to higher values will cause the track to extend back further in time, but it will be less detailed.

1. **Main Menu [Custom User Mode]:** Press the MENU key twice. Select the **Nav** tab.
2. Select Trackpoint Interval.
3. Press the RIGHT or LEFT Cursor keys to adjust the setting.
4. Select Track Min Distance.
5. Press the RIGHT or LEFT Cursor keys to adjust the setting.

### Save the Current Track

Use the following instructions to save the current track and start a new track.

1. **Chart X-Press Menu:** With a Chart View displayed on-screen, press the MENU key once.
2. Select Save Current Track. Press the RIGHT Cursor key.
3. Follow the on-screen prompts to save or discard the track.



**NOTE:** It is important to save the track before powering off the control head.

### Edit the Current Track

Use the following instructions to edit the current track. To edit a saved track, see *Manage your Navigation Data*.

1. **Main Menu:** Press the MENU key twice. Select the **Nav** tab.
2. Select Current Track. Press the RIGHT Cursor key.
3. Select Appearance.
4. Use the Cursor Control key to change the visibility, style, and color.  
See *Change New Track Settings* for details.
5. **Save:** Select Save. Press the RIGHT Cursor key.

## Clear the Current Track

Use the following instructions to clear the current track on the view and start a new track at the present boat position.

1. **Chart X-Press Menu:** With a Chart View displayed on-screen, press the MENU key once.
2. Select Clear Current Track.
3. Press the RIGHT Cursor key.

## Show/Hide the Current Track

The current track is shown on the Chart View automatically. To hide or show the current track, use the following instructions. To show or hide a saved track, see *Manage your Navigation Data*.

1. **Main Menu:** Press the MENU key twice. Select the **Nav** tab.
2. Select Current Track. Press the RIGHT Cursor key.
3. Select Appearance.
4. Select Visibility.
5. Select Hidden or Visible.
6. **Save:** Select Save. Press the RIGHT Cursor key.

## Stop Tracking

Use the instructions in this section to turn off tracking. If you turn off tracking, the unit will not save trackpoints.

1. **Main Menu:** Press the MENU key twice. Select the **Nav** tab.
2. Select Current Track. Press the RIGHT Cursor key.
3. Select Stop Tracking. Press the RIGHT Cursor key.

**To start tracking,** select the **Nav** tab > Current Track > Start Tracking.

# SEARCH

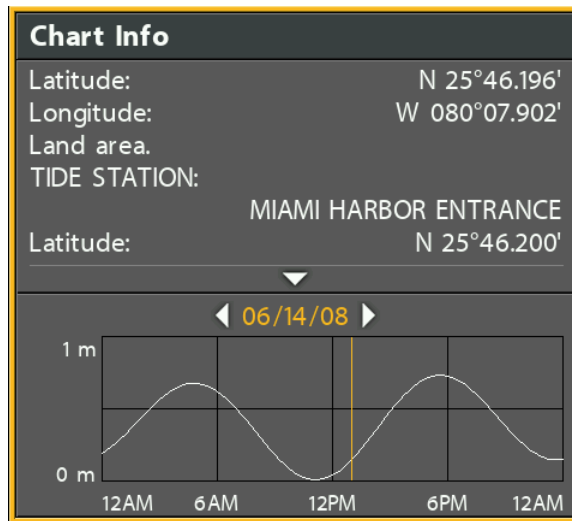
There are many ways to search the area for ports, tide stations, and current stations. You can also search for information based on the cursor position. The search options and the search area distance are determined by the installed map card and selected map source.

## Search by Nearest Port, Tide Station, or Current Station

The control head must have a separate-purchase map card installed to enable the features in this section.

1. Press the CHECK/INFO key.
2. Select Nearest Port, Nearest Tide Station, or Nearest Current Station.
3. Press the RIGHT Cursor key.

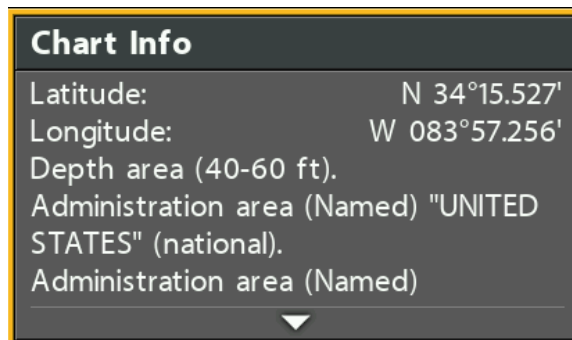
### Chart Info: Tide Station



## Search by Cursor Position

1. Use the Cursor Control key to move the cursor to a waypoint or position on the chart.
2. Press the CHECK/INFO key.

### Chart Info: Cursor Position



## Search for Contour Depth

1. Use the Cursor Control key to move the cursor to a contour on the chart.
2. Press the CHECK/INFO key.

## Search for a Lake

**Use this menu to display a lake other than your current location.** The lake map displayed on the Chart View is based on the GPS latitude/longitude position and the Humminbird LakeMaster map card installed in the control head. GPS reception is required for the correct lake to be displayed.

The **Lake List** menu option allows you to display a different lake from the installed map card. When you select a lake, the cursor will move to the lake so you can see it on the Chart View. Then, you can mark waypoints, press the GOTO key to start navigation toward a waypoint, or press the CHECK/INFO key for more information.

**No GPS Reception:** If you don't have a GPS Fix, you can view the lake in Simulator mode. When you power on the control head, press the MENU key. Select Simulator from the Start-Up Options Menu. You can mark waypoints and routes and save them in Simulator mode.



**NOTE:** A Humminbird LakeMaster map card must be installed to enable this feature.

## Search for a Lake

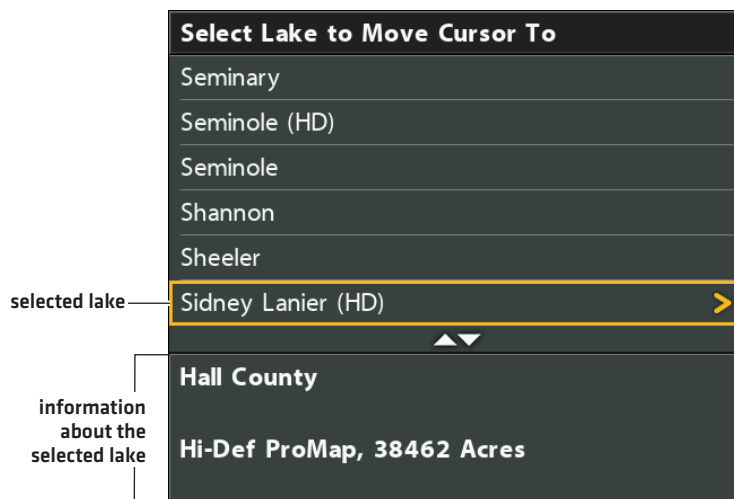
1. **Main Menu:** Press the MENU key twice. Select the **HB Chart** tab.
2. Select Lake List.
3. Press the RIGHT Cursor key.

**Sort By:** Select the Sort By field, and press the RIGHT or LEFT Cursor keys to select a sort option for the list. You can sort alphabetically, identify the high-definition lakes (Hi-Def) on your card, etc.

**Scroll:** Press the UP or DOWN Cursor keys to scroll through the list. As each lake is highlighted, you can view information about the lake in the box displayed on the screen.

**Cursor To:** Select a lake on the list. Press the RIGHT Cursor key.

### Selecting a Lake to Display



# MANAGE YOUR NAVIGATION DATA

---

Your control head allows you to start navigation or edit your navigation data from the Chart View. You can also start navigation or edit navigation data from the Waypoint Management dialog box. The instructions in this section apply to the Waypoint Management dialog box.

## Overview

### Open the Waypoint Management Dialog Box

1. **Main Menu:** Press the MENU key twice. Select the **Nav** tab.
2. Select Waypoints, Routes, Tracks.
3. Press the RIGHT Cursor key.

### Sort

You can sort your saved navigation data alphabetically or by newest/oldest date, distance, or icon.

1. Press the EXIT key.
2. Select Sort By.
3. Press the RIGHT or LEFT Cursor keys to select a sort setting.

### Select a File

Use these instructions to select an individual waypoint, route, track, or group. Then, use the submenu to apply settings or actions to the selected file.

1. Press the DOWN or UP Cursor keys to select a waypoint, route, track, or group.
2. **Open the Submenu:** Press the RIGHT Cursor key.



**Selecting Files in the Waypoint Management Dialog Box (Waypoints, Routes, Tracks)**

**Waypoints, Routes, Tracks**

Sort By Z to A

Options

- WP007 >
- 🐟 WP006
- WP005
- 📍 RT002
- 👉 06/14/08 12:54 PM

Directory: Bass08 is the selected group

**Home < Bass08**

**Default Group: Home**

**Name:** WP007

**Icon:** ●

**Icon Category:** Geometry

**Visibility:** Visible

**Latitude:** N 34°13.001'

**Longitude:** W 084°00.434'

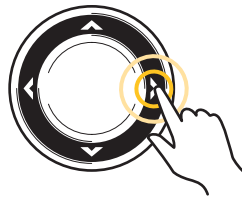
**Created:** 11:30:52 AM 06/14/08

selected file (highlighted in yellow)

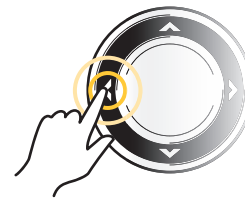
selected file preview



Scroll through the List



Open a Menu



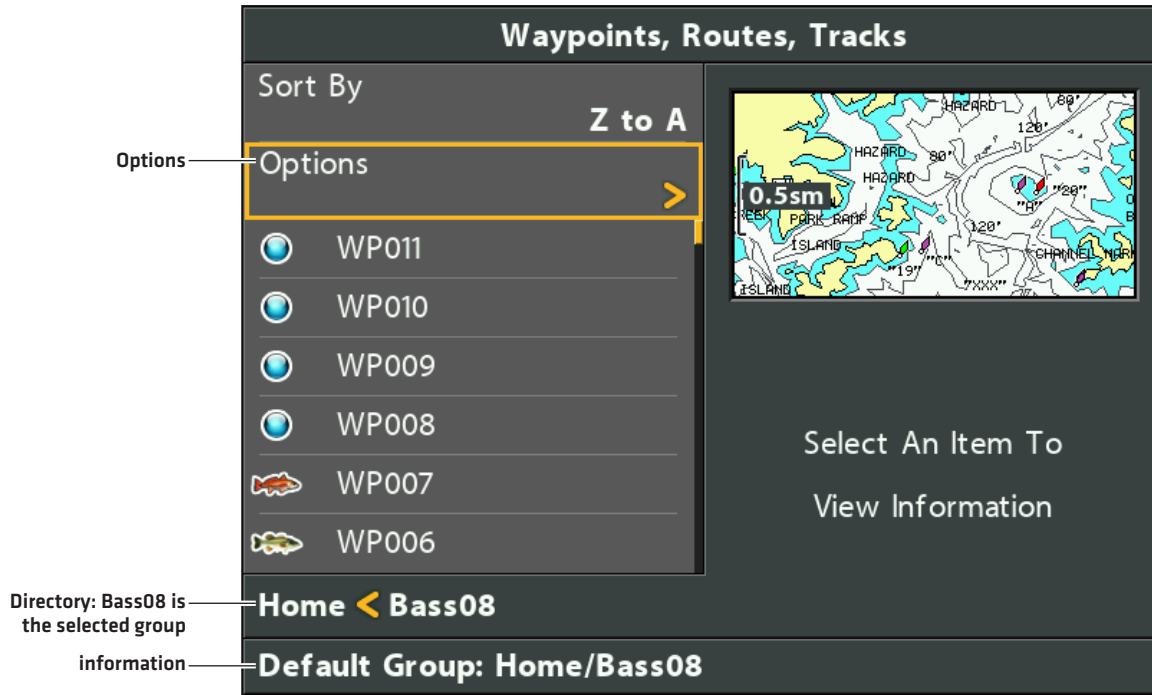
Go Back

## Jump to the Top

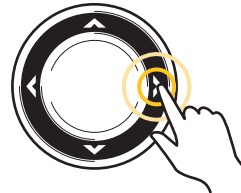
The Options menu, and other important actions, are located at the top of the Waypoint Management dialog box. Use these instructions to quickly select Options or jump to the top.

1. Press the EXIT key.

### Selecting Options (Jump to the Top)



Jump to the Top



Open a Menu

## Manage Waypoints

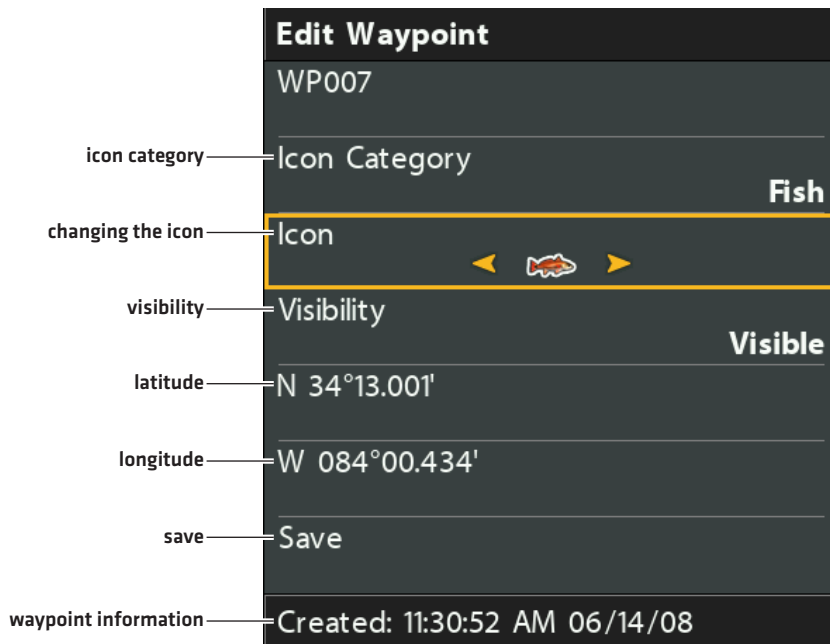
When you press the MARK key and create a new waypoint, an alphanumeric name [beginning with WP] is assigned to the waypoint. ICE HELIX CHIRP models also use alphanumeric names, but they begin with IC. You can use the Waypoint Management dialog box to edit the saved waypoint or create a new waypoint. You can also select a waypoint icon and category for all new waypoints. .

### Open the Waypoint Submenu

1. Select a waypoint from the Waypoint Management dialog box. Press the RIGHT Cursor key.
2. Select one of the following menu options:

<b>Edit</b>	Opens the Edit Waypoint menu. See <b>Edit a Saved Waypoint</b> for details.
<b>Delete</b>	Deletes the waypoint. To remove the waypoint from the group, choose Selected. To delete the waypoint from all groups, choose All Instances. See <b>Delete a Waypoint</b> for details.
<b>Duplicate</b>	Creates a copy of the waypoint and adds it to a new group or route [see <b>Search and Organize</b> ].
<b>Save As</b>	Creates a new waypoint [based on the selected waypoint] and opens a menu so you can change the new waypoint's name. See <b>Search and Organize</b> for details.
<b>Move</b>	Moves the waypoint from the selected group to a different group [see <b>Search and Organize</b> ].
<b>Cursor To</b>	Moves the cursor to the selected waypoint in the Chart View [see <b>Navigation Overview: Waypoints</b> ].
<b>Go To</b>	Starts navigation to the selected waypoint [see <b>Navigation Overview: Waypoints</b> ].
<b>Target</b>	Displays a target on the selected waypoint in the Chart View [see <b>Navigation Overview: Waypoints</b> ].
<b>Grid</b>	Displays a grid on the selected waypoint in the Chart View [see <b>Navigation Overview: Waypoints</b> ].

## Editing a Waypoint



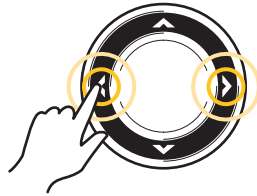
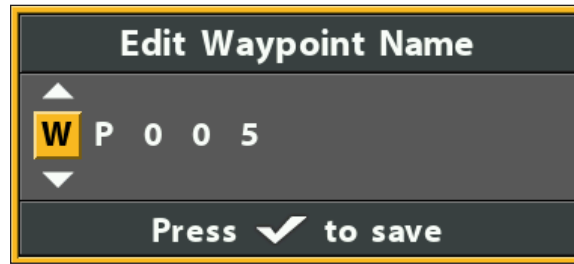
### Edit a Saved Waypoint

1. Select a waypoint. Press the RIGHT Cursor key.
2. Select Edit. Press the RIGHT Cursor key.
3. Use the Cursor Control key to edit the available fields.

<b>Name</b>	Select the file name, and press the RIGHT Cursor key. See the illustration <i>Changing the Waypoint Name</i> .
<b>Icon Category</b>	Select All to view all available icons. [All, Geometry, Alerts, Supplies, Navigation, Recreation, Fish, Environment]
<b>Icon</b>	The available icons are determined by the category selected in Icon Category.
<b>Visibility</b>	To show the waypoint icon on the Chart View, select Visible. To hide it, select Hidden.
<b>Latitude Longitude</b>	To move from space to space, press the RIGHT or LEFT Cursor keys. To change the letter or number, press the UP or DOWN Cursor keys.

4. **Save:** Select Save. Press the RIGHT Cursor key.

## Changing the Waypoint Name



Move from Space to Space



Select a Letter, Number, or Symbol



Save

## Create a New Waypoint

Use the following instructions to create a new waypoint and add your own settings. To mark a waypoint in Chart View, see *Navigation Overview: Waypoints*.

1. **Open a Group or Route:** Select a group or route [where you want to save the new waypoint]. Press the RIGHT Cursor key.  
Home is the highest level group, or the main directory, in the Waypoint Management dialog box.
2. Select Open. Press the RIGHT Cursor key.
3. Select Options > New > New Waypoint.
4. **Create New Waypoint:** Use the Cursor Control key to set the available fields. See *Edit a Saved Waypoint* for details.
5. **Save:** Select Save. Press the RIGHT Cursor key.

## Set the Waypoint Icon Default

Use the following instructions to set the waypoint icon category and the waypoint icon for all new waypoints.



**NOTE:** If the Waypoint Management dialog box is open, press the EXIT key to close the dialog box, and proceed with the following instructions.

1. **Main Menu:** Press the MENU key twice. Select the **Nav** tab.
2. Select Waypoint Settings. Press the RIGHT Cursor key.
3. Use the Cursor Control key to set your new waypoint preferences.

<b>Icon Category</b>	Select All to view all available icons. [All, Geometry, Alerts, Supplies, Navigation, Recreation, Fish, Environment]
<b>Default Waypoint Icon</b>	The available icons are determined by the category selected in Icon Category.
<b>New Waypoint Icon</b>	<b>Default:</b> When you mark a waypoint, the waypoint will be marked using the settings. <b>Select:</b> Each time you mark a waypoint, you will be prompted to change the waypoint icon and category. To accept the current settings, press the MARK key again. See <b>Waypoints: Mark and Edit Waypoints (on-the-go)</b> in the Navigation section.

4. **Save:** Select Save. Press the RIGHT Cursor key.

## Delete a Waypoint

1. Select a waypoint. Press the RIGHT Cursor key.
2. Select Delete. Press the RIGHT Cursor key.
3. To remove the waypoint from the group, choose Selected.  
To delete the waypoint from all groups, choose All Instances.
4. Follow the on-screen prompts to delete the waypoint.

## Manage Routes

You can edit your saved routes, and you can also create new routes from scratch using your saved waypoints. Route names are alphanumeric and begin with RT.

### Open the Route Submenu

1. Select a route from the Waypoint Management dialog box. Press the RIGHT Cursor key.
2. Select one of the following menu options:

Open	Displays the saved waypoints in the route. You can change the waypoint order from this menu [see <b><i>Change the Waypoint Order in a Route</i></b> ].
Travel	Starts navigation on the selected route in forward or reverse [see <b><i>Travel a Saved Route</i></b> ].
Add/Remove	Copies waypoints into the route or deletes waypoints from the route. See <b><i>Add Waypoints to a Route</i></b> and <b><i>Delete a Waypoint from a Route</i></b> .
Edit	Opens the Edit Route menu. See <b><i>Edit a Saved Route</i></b> for details.
Delete	Deletes the route. To delete the route from the selected group, choose Selected. To delete the route from all groups, choose All Instances. See <b><i>Delete a Route</i></b> for details.
Duplicate	Creates a copy of the route and adds it to a new group [see <b><i>Search and Organize</i></b> ].
Save As	Creates a new route [based on the selected route] and opens a dialog box so you can change the new route's name [see <b><i>Search and Organize</i></b> ].
Move	Moves the route from the selected group to a different group [see <b><i>Search and Organize</i></b> ].
Info	Opens the Route Info box and displays the waypoints in the route. To change the waypoints in a route, see <b><i>Add Waypoints to a Route</i></b> and <b><i>Delete a Waypoint from a Route</i></b> .

## Open a Saved Route

1. Select a route. Press the RIGHT Cursor key.
2. Select Open. Press the RIGHT Cursor key.

### Opening a Saved Route

The screenshot shows the 'Waypoints, Routes, Tracks' menu. On the left, a list of waypoints is shown: WP003 (selected), WP004, S00001, and S00002. A bracket indicates the order from first to last. Below the list, the route 'RT002' is selected, with 'Bass08' and 'Home' also visible. The right side of the screen shows a map with a blue dot and a distance of 0.25sm. Below the map, the details for WP003 are displayed: Name: WP003, Icon: a blue circle, Icon Category: Geometry, Visibility: Visible, Latitude: N 34°12.245', Longitude: W 083°59.752', and Created: 11:24:08 AM 06/15/08. At the bottom, the 'Default Group: Home' is shown.

## Review Route Distance Information

Use the instructions in this section to open a saved route and review the distance and bearing from each waypoint to the next.

1. Select a route. Press the RIGHT Cursor key.
2. Select Info. Press the RIGHT Cursor key.

### Reviewing Route Information

The screenshot shows the 'Route Info: RT002' screen. The title is 'Route Info: RT002'. Below the title, the current position is shown. A table lists the waypoints and their distances and bearings:

	distance	bearing
WP003	515ft	090°t
WP004	0.69sm	169°t
S00001	73ft	000°t

Below the table, the route summary is shown: 4 Waypoints, Created: 11:25:31 AM 06/15/08.



## Travel a Saved Route

1. Select a route. Press the RIGHT Cursor key.
2. Select Travel. Press the RIGHT Cursor key.
3. Select Forward or Reverse. Press the RIGHT Cursor key.

Navigation begins immediately. The Waypoint Management dialog box will close so you can see the route on the Chart View.

## Edit a Saved Route

You can customize a route name, add or remove waypoints, and change the travel order for navigation.

To add waypoints to the route, or delete waypoints from the route, see **Add Waypoints to a Route** and **Delete a Waypoint from a Route**.

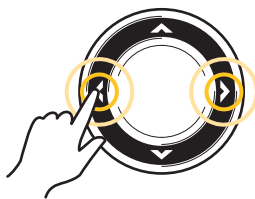
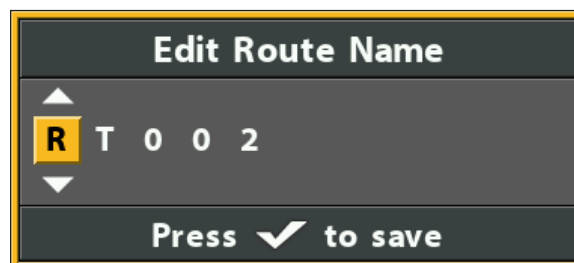
To change the travel order in a route, see **Change the Waypoint Order in a Route**.

1. Select a route. Press the RIGHT Cursor key.
2. Select Edit. Press the RIGHT Cursor key.
3. Use the Cursor Control key to edit the available fields.

<b>Name</b>	Select the file name, and press the RIGHT Cursor key. See the illustration <b>Changing the Route Name</b> .
<b>Visibility</b>	To show the route on the Chart View, select Visible. To hide it, select Hidden.

4. **Save:** Select Save. Press the RIGHT Cursor key.

### Changing the Route Name



Move from Space to Space



Select a Letter, Number, or Symbol



Save

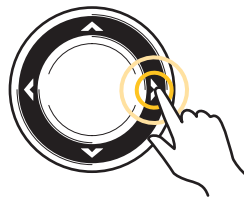
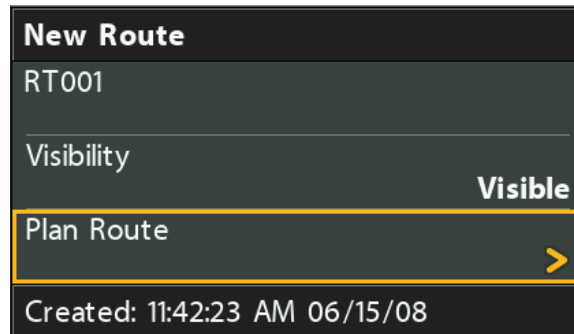
## Create a New Route

1. **Open a Group:** Select a group [where you want to save the new route]. Press the RIGHT Cursor key.  
Home is the highest level group, or the main directory, in the Waypoint Management dialog box.
2. Select Options > New > New Route.
3. **Create New Route:** Use the Cursor Control key to edit the available fields.

<b>Name</b>	Select the item name, and press the RIGHT Cursor key. See the illustration <i>Changing the Route Name</i> .
<b>Visibility</b>	To show the route on the Chart View, select Visible. To hide it, select Hidden.

4. **Plan Route:** Select Plan Route. Press the RIGHT Cursor key.  
The New Route menu closes so you can select waypoints to add to the route.

### Selecting Plan Route



Select

5. **Add Waypoints:** Press the UP or DOWN Cursor keys to scroll through the available waypoints.  
To add a selected waypoint to the route, press the RIGHT Cursor key.  
Repeat as needed. See the illustration *Adding Waypoints to a Route*.
6. **Save:** Press the EXIT key to select Save. Press the RIGHT Cursor key.

## Adding Waypoints to a Route

The screenshot shows a menu titled "Waypoints, Routes, Tracks". On the left, there are several options: "Sort By" (with "Newest" selected), "Save RT001", a list of waypoints (RT001, RT002, 06/14/08 12:54 PM, WP007, WP006, and WP005), and "Home < Bass08". The "WP005" option is highlighted in yellow. On the right, there is a map showing a 0.5sm scale and a detailed view of the selected waypoint "WP005" with its icon, category, visibility, latitude, longitude, and creation time. At the bottom, there is a "Select items and save" button.

sort files — Sort By

next steps — Save RT001

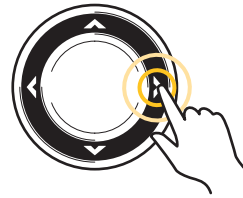
selected waypoint (highlighted in yellow) — WP005

Directory: Bass08 is the selected group — Home < Bass08

instructions — Select items and save



Scroll through the List



Select

## Add Waypoints to a Route

When you add a waypoint to a route, it is a copy. If you make changes to the copy, the changes will be made to all copies.

1. Select a route. Press the RIGHT Cursor key.
2. Select Add/Remove. Press the RIGHT Cursor key.  
The menu will close.
3. Press the UP or DOWN Cursor keys to choose a waypoint. Press the RIGHT Cursor key to add it to the route.
4. **Save:** Press the EXIT key to select Save. Press the RIGHT Cursor key.

## Delete a Waypoint from a Route

1. Select a route. Press the RIGHT Cursor key.
2. Select Open. Press the RIGHT Cursor key.
3. Select a waypoint in the route. Press the RIGHT Cursor key.
4. Select Delete. Press the RIGHT Cursor key.
5. To remove the waypoint from the group, choose Selected.  
To delete the waypoint from all groups, choose All Instances.
6. Follow the on-screen prompts to delete the waypoint.

## Change the Waypoint Order in a Route

1. Select a route. Press the RIGHT Cursor key.
2. Select Open. Press the RIGHT Cursor key.
- 3a. **Select Reverse**, and press the RIGHT Cursor key. This will quickly reverse the order of the route.

OR

- 3b. **Choose a Waypoint in the route**, and press the RIGHT Cursor key.

Select Reorder, and press the RIGHT Cursor key.

To move the waypoint up or down in the route order, press the UP or DOWN Cursor keys.

See the illustration *Changing the Route Order [Moving a Waypoint]*.

4. Press the EXIT key to select Save.

Press the RIGHT Cursor key.

## Delete a Route

1. Select a route. Press the RIGHT Cursor key.
2. Select Delete. Press the RIGHT Cursor key.
3. To remove the route from the group, choose Selected.  
To delete the route from all groups, choose All Instances.

## Changing the Route Order (Moving a Waypoint)

**Waypoints, Routes, Tracks**

Reverse Newest

Options

move a waypoint up or down in the route order

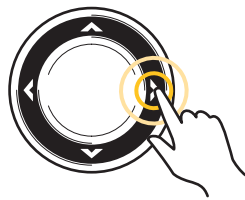
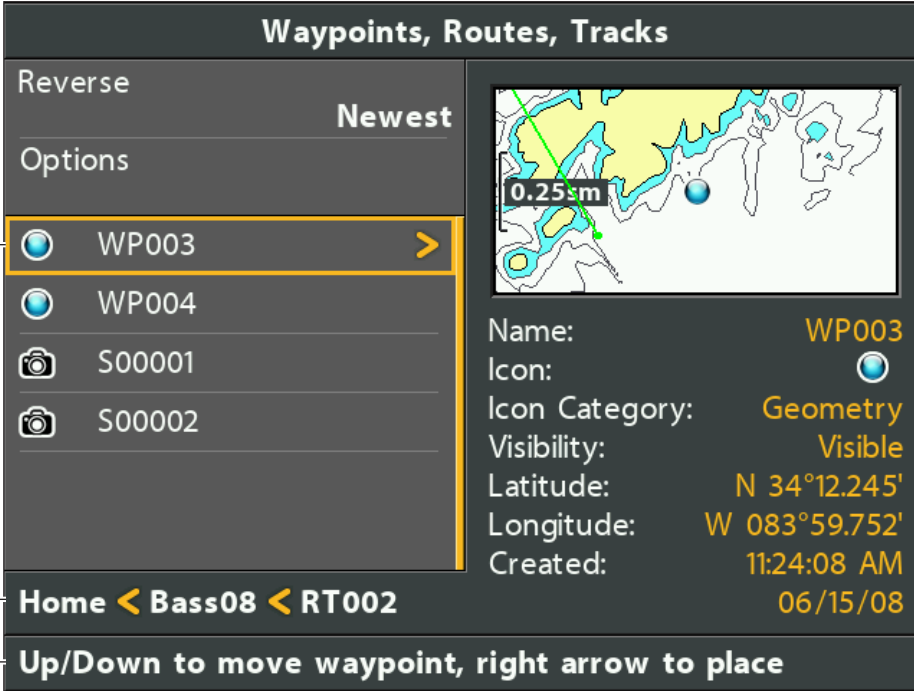
- WP003
- WP004
- S00001
- S00002

Directory: RT002 is the selected route

instructions

Home < Bass08 < RT002

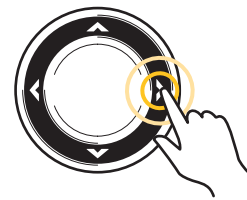
Up/Down to move waypoint, right arrow to place



Select the Waypoint



Move the Waypoint Up or Down



Confirm the New Location

## Manage Tracks

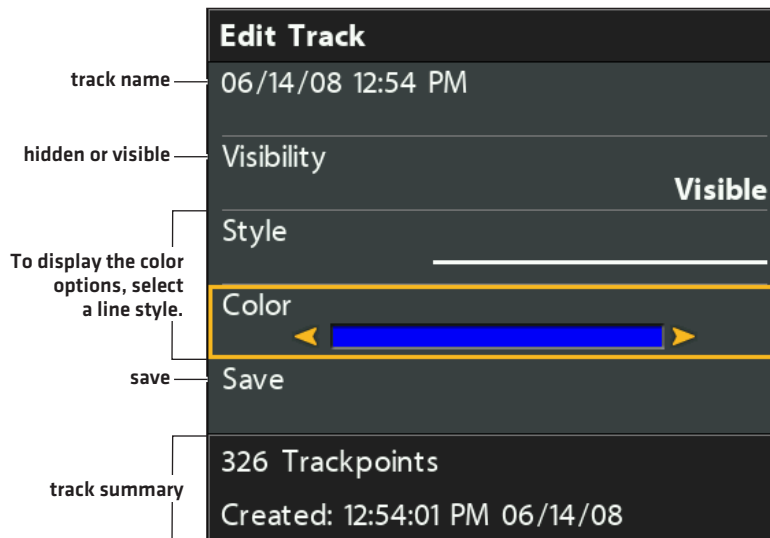
Save and edit your tracks with the Waypoint Management dialog box. Track names are saved with a date and time stamp. The Tracks submenu allows you to edit the track name, appearance, and the track visibility. You can also move tracks from one group to another group.

### Open the Track Submenu

1. Select a track from the Waypoint Management dialog box. Press the RIGHT Cursor key.
2. Select one of the following menu options:

<b>Edit</b>	Opens the Edit Track menu. See <b>Edit a Saved Track</b> for details.
<b>Delete</b>	Deletes the track. To delete the track from the selected group, choose Selected. To delete the track from all groups, choose All Instances. See <b>Delete a Saved Track</b> for details.
<b>Duplicate</b>	Creates a copy of the track and adds it to a new group [see <b>Search and Organize</b> ].
<b>Save As</b>	Creates a new track [based on the selected track] and opens a menu so you can change the new track's name [see <b>Search and Organize</b> ].
<b>Move</b>	Moves the track from the selected group to a different group [see <b>Search and Organize</b> ].

### Editing a Track



## Edit a Saved Track

Use the following instructions to edit a saved track. To edit the current track, see *Navigation Overview: Tracks*.

1. Select a track. Press the RIGHT Cursor key.
2. Select Edit. Press the RIGHT Cursor key.
3. Use the Cursor Control key to edit the available fields.

<b>Name</b>	Select the file name, and press the RIGHT Cursor key. To move from space to space, press the RIGHT or LEFT Cursor keys. To change the letter or number, press the UP or DOWN Cursor keys.
<b>Visibility</b>	To show the icon on the Chart View, select Visible. To hide it, select Hidden.
<b>Style</b>	Select a line style.
<b>Color</b>	Select a color. The Color field is available if you've selected a solid line in the Style field.

4. **Save:** Select Save. Press the RIGHT Cursor key.

## Delete a Saved Track

1. Select a track. Press the RIGHT Cursor key.
2. Select Delete. Press the RIGHT Cursor key.
3. To remove the track from the group, choose Selected.  
To delete the track from all groups, choose All Instances.

## Manage Groups

Use groups to organize your waypoints, routes, and tracks in one set. Some anglers prefer to group their navigation items by trip, fish-type, body of water, or time of day. New group names are alphanumeric and begin with GP, and you can edit the name.



**NOTE:** Groups and sub-groups use storage. The storage limit of your waypoints and routes may vary due to the complexity of your Waypoint Management directory.

### Open the Group Submenu

1. Select a group from the Waypoint Management dialog box. Press the RIGHT Cursor key.
2. Select one of the following menu options:

<b>Open</b>	Displays the saved waypoints, routes, and tracks in the group.
<b>Add/Remove</b>	Copies waypoints, routes, and tracks into the group or deletes files from the group [see <b>Add/Remove Navigation Items</b> ].
<b>Edit</b>	Opens the Edit Group menu. See <b>Edit a Group</b> for details.
<b>Delete</b>	Deletes the group [see <b>Delete a Group</b> ].
<b>Move</b>	Moves the group from one location to another [see <b>Search and Organize</b> ].



## Set a Group as the Default Directory

To save all your **new** waypoints, routes, and tracks to a designated group, use the following steps:

1. Select a group. Press the RIGHT Cursor key.
2. Select Open. Press the RIGHT Cursor key.
3. Select Options > Set as Default.

## Create a New Group

1. **Select a Save Location:** Use the Cursor Control key to choose where you want to save the new group.

Home is the highest level group, or the main directory. You can also add a subgroup to an existing group. The current group is where the new data will be saved.

2. Select Options > New > New Group.
3. Use the Cursor Control key to set the available fields.

4. **Add Items:** Select Add Items, and press the RIGHT Cursor key.

The New Group dialog box will close so you can select items from the Waypoint Management dialog box. You can also leave the group empty and add to it later.

Press the UP or DOWN Cursor keys to choose a waypoint, route, or track, and press the RIGHT Cursor key to add it to the group.

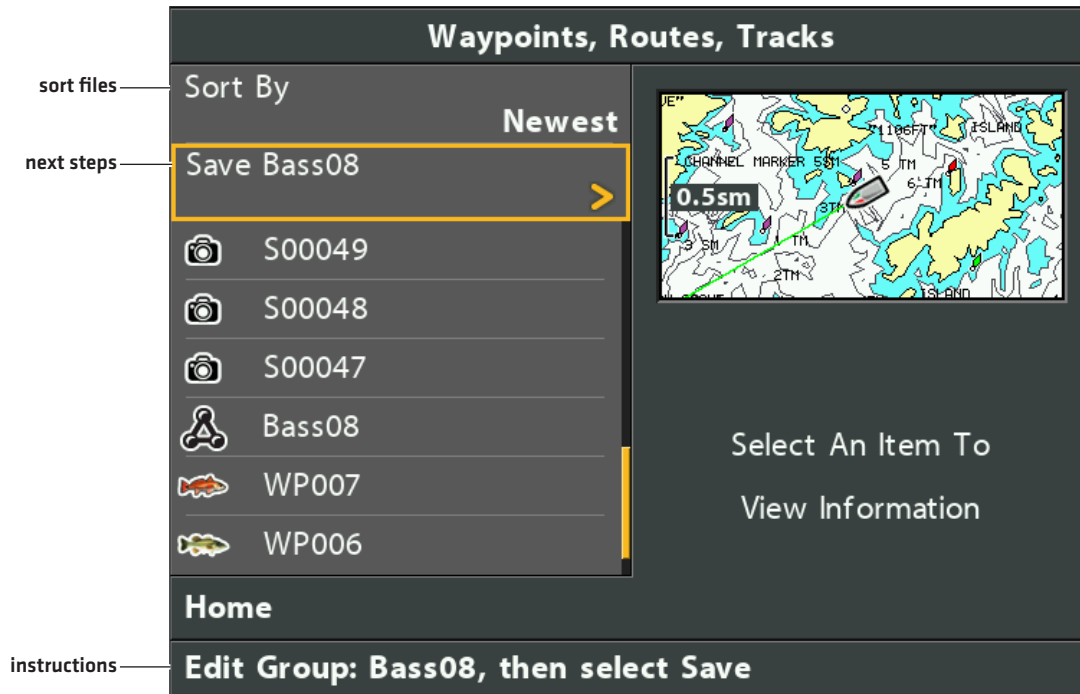
Repeat as needed. See the illustration *Adding Items to a Group*.

5. **Save:** Press the EXIT key to select Save. Press the RIGHT Cursor key.

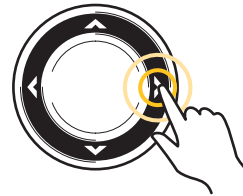


**NOTE:** When you add an item to a group, it is a copy. If you make changes to the copy, the changes will be made to all copies. For example, if you change the waypoint icon for a waypoint that is saved in more than one group, the icon will change in all the groups where the waypoint is saved.

## Adding Items to a Group



Scroll Up or Down



Add

### Add/Remove Navigation Items

1. Select a group. Press the RIGHT Cursor key.
2. Select Add/Remove. Press the RIGHT Cursor key.  
The menu will close.
3. **Add:** Press the UP or DOWN Cursor keys to choose a waypoint, route, or track. Press the RIGHT Cursor key to add it to the group.  
**Remove:** Select an item in the group. Press the RIGHT Cursor key to delete it.
4. Repeat step 3 as needed. You can add or remove items from any other group in the Waypoint Management dialog box.
5. **Save:** Press the EXIT key to select Save. Press the RIGHT Cursor key.



**NOTE:** When you add an item to a group, it is a copy. If you make changes to a copy, the changes will be made to all copies.

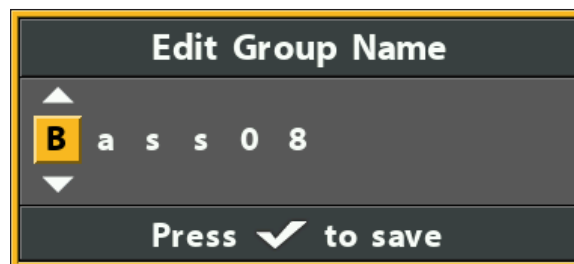
## Edit a Group

1. Select a group. Press the RIGHT Cursor key.
2. Select Edit. Press the RIGHT Cursor key.
3. Use the Cursor Control key to edit the available fields.

<b>Name</b>	Select the file name, and press the RIGHT Cursor key. See the illustration <i>Changing the Group Name</i> .
<b>Visibility</b>	To show the group on the Chart View, select Visible. To hide it, select Hidden.

4. **Save:** Select Save. Press the RIGHT Cursor key.

### Changing the Group Name



Move from Space to Space



Select a Letter, Number, or Symbol



Save

## Delete a Group

1. Select a group. Press the RIGHT Cursor key.
2. Select Delete. Press the RIGHT Cursor key.
3. Follow the on-screen prompts to confirm.

## Search and Organize

The Waypoint Management dialog box allows you to move your waypoints, routes, and tracks into a designated group, make copies, and search for information.

### Search By

Search By allows you to search the items in the Waypoint Management dialog box by Name, Distance, Date, Icon, or Icon Category.

1. Select Options. Press the RIGHT Cursor key.
2. Select Search By.
3. Select a search category. Press the RIGHT Cursor key.
4. Use the Cursor Control key to enter your search criteria in the dialog box.
5. Select Enter. Press the RIGHT Cursor key to start the search.

### Duplicate or Move

Use the following instructions to move or duplicate a waypoint, route, or track. Groups can be moved, but they cannot be duplicated.



**NOTE:** When you make changes to a copied item, the changes are applied to all copies. To make a copy and set the item apart from its copies, use Save As [see **Create a Copy and Save as a New Item**].

1. Select a waypoint, route, track, or group. Press the RIGHT Cursor key.
2. Select Move or Duplicate.

**Duplicate:** To create a copy of the waypoint, route, or track so that it appears in more than one group, select Duplicate.

**Move:** To delete the group, waypoint, route, or track from one group and transfer it to another group, select Move.

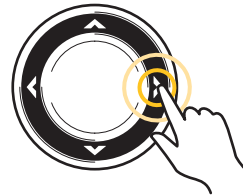
3. Use the Cursor Control key to select the destination group or route [waypoints only].
4. Press the EXIT key to select Paste here. Press the RIGHT Cursor key to confirm the change.

## Selecting Multiple Waypoints

The screenshot shows the 'Waypoints, Routes, Tracks' menu. At the top, there is a 'Sort By' dropdown set to 'Newest' and a 'Paste here' field. Below this is a list of items: RT002 (dated 06/14/08 12:54 PM), WP007, WP006, and WP005. The last three items (WP007, WP006, and WP005) are highlighted in yellow, indicating they are selected. To the right of the list is a map showing a coastal area with several waypoints marked. Below the map, the details for the selected item (WP005) are displayed: Name: WP005, Icon: a blue circle, Icon Category: Geometry, Visibility: Visible, Latitude: N 34°12.392', Longitude: W 084°00.380', and Created: 11:30:31 AM 06/14/08. At the bottom of the menu, there is a 'Home < Bass08' button and a 'Select items to Duplicate' button. Annotations on the left side of the screenshot point to various elements: 'sort files' points to 'Sort By', 'next steps' points to 'Paste here', 'selected waypoints (highlighted in yellow)' points to the yellow highlights on the list, 'Directory: Bass08 is the selected group' points to the 'Home < Bass08' button, and 'instructions' points to the 'Select items to Duplicate' button.



Scroll Up or Down



Select

## Create a Copy and Save as a New Item

Use the instructions in this section to copy a waypoint, route, or track and save it as a separate item. The new item retains the properties from the original, but it will not be affected by changes to the original.

1. Select a waypoint, route, or track. Press the RIGHT Cursor key.
2. Select Save As. Press the RIGHT Cursor key.
3. Use the Cursor Control key to name the new item.
4. **Save:** Select Save. Press the RIGHT Cursor key.

## Import/Export Navigation Data

### Import Navigation Data

Use the following instructions to import waypoints, routes, tracks, and groups into your Humminbird control head. The control head will import Humminbird navigation data from an installed microSD or SD card. See **HELIX Control Head** for compatibility details.



**WARNING!** Do NOT import navigation data from unknown sources into your Humminbird control head without first converting the data to the correct format using HumminbirdPC. Importing corrupted data can cause the unit to malfunction, which can result in lost navigation data.

1. Install a loaded microSD or SD card into the control head.
2. Follow the on-screen prompts to confirm or cancel the import.

### Export ALL Navigation Items

Export your navigation items to an unlocked, installed microSD or SD card (separate purchase required) and then view them in HumminbirdPC.

1. Select Options > Select All and... > Export.
2. Follow the on-screen prompts to confirm or cancel the export.

### Export Selected Navigation Items

You can also select individual navigation items and export them to an unlocked, installed microSD or SD card. See **HELIX Control Head** for compatibility details.

1. From a selected group, select Options > Select Multiple and... > Export.
2. **Select Items:** Press the UP or DOWN Cursor keys to scroll through the waypoints, routes, and tracks. Press the RIGHT Cursor key to select an item. Repeat as needed.
3. **Confirm Export:** Press the EXIT key to select Export Selected.

Press the RIGHT Cursor key. Follow the on-screen prompts to confirm or cancel the export.

## Delete all Navigation Data and Reset

Use Format Nav Directories to delete ALL navigation data (waypoints, routes, tracks, and groups) and reset the navigation data directory in the Waypoint Management dialog box. You may need to reset the navigation directory if you've imported corrupted navigation data from an unknown source, which can cause the unit to malfunction.



**CAUTION!** Use this menu with caution! Contact Humminbird Technical Support before using this menu option.



**NOTE:** It is important to back up your control head's data files periodically. Data files should also be saved to your PC before restoring the unit's defaults or updating the software. See **Manage your Navigation Data: Import/Export Navigation Data**.

1. **Main Menu:** Press the MENU key twice. Select the **Setup** tab.
2. Select Format Nav Directories.
3. Press the RIGHT Cursor key.
4. Follow the on-screen prompts to confirm the deletion.

## AUTOCHART LIVE OVERVIEW

---

AutoChart Live uses data from an installed GPS receiver and 2D transducer (down beam, DualBeamPLUS) to create detailed depth maps of your favorite waters.

**Map Source:** Humminbird CoastMaster, Humminbird LakeMaster, or Navionics

**Storage:** AutoChart Live saves 8 hours of mapping data on your control head. After 8 hours of data has been collected, you can erase the data and continue mapping, or you can purchase a ZeroLine Map Card for unlimited mapping.

**ZeroLine Map Card:** To purchase a ZeroLine Map Card and download the accessory guide, visit our Web site

## PLAN YOUR MAP

---

Before getting started, consider the areas where you want to create a map. Review the following tips to plan your map:

### General Tips

- Start with your favorite fishing hot spots. It is not recommended to record survey data of an entire lake, as it will require a lot of time to map and might include areas you don't want.
- Take a different route to and from each fishing spot every trip. You may discover new and interesting areas to map.
- Start a new track or recording when you start for the day. Record new data every trip to create new maps or improve existing maps.
- Navigate the boat at a consistent speed when recording data.
- See the illustration below for instruction on how to navigate your boat while recording survey data.

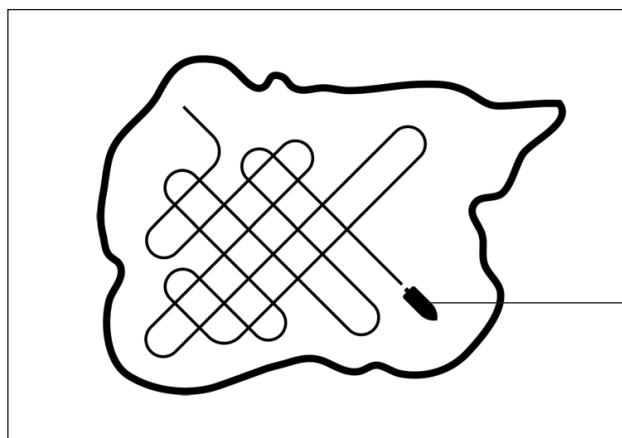
### Mapping a Specific Area or Object in Detail

- Navigate the boat across the area rather than alongside.
- Turn the boat where the area and/or object is out of range of the transducer beam(s).
- Try to reduce the measurement time, so as to reduce the error due to possible GPS variations.

### Mapping an Entire Lake

- Follow a plan.
- Follow the maximum gradient of the sea floor (up or down).
- Keep a steady speed. For optimal performance, 0 to 8 mph is recommended.
- Turn the boat where the bottom is flat if possible.

**Navigating the Boat to Record Survey Data**



Navigate your boat in a zig-zag pattern, first in one direction and then in the other.

# 1. PREPARE THE CONTROL HEAD FOR MAPPING

---

When you start your mapping for the day, it is important to note if the water level is higher or lower than usual. It is also important to use your 2D transducer beams exclusively.

## Set the Map Source

AutoChart Live can be used when a Humminbird CoastMaster, Humminbird LakeMaster or Navionics map card is installed and selected as the map source. When you install a chart or map card, the map source is changed automatically to match the microSD or SD card map source. You can also change the map source manually. If your control head has two cards installed, you can choose which map source you want to use [HELIX 8, 9, 10, 12, 15 only].

1. **Main Menu:** Press the MENU key twice. Select the **Chart** tab.
2. Select Map Source.
3. Select the installed Humminbird CoastMaster, Humminbird LakeMaster or Navionics map card location or a built-in map.

## Confirm the 2D Transducer and Turn off Additional Transducers

To record your custom map, you must have a reliable and accurate digital depth from a pinging 2D transducer. You can use your Humminbird DualBeam PLUS transducer [83/200 kHz], Side Imaging transducer with 2D [down beam] capabilities, or a CHIRP transducer with 2D [down beam] capabilities.

**When you are recording your map, you should have only one 2D transducer pinging on your boat.** If you have other 2D transducers pinging on remote control heads, you should turn them off. Down Imaging and Side Imaging beams can operate at the same time. You do not need to turn them off.

1. **Main Menu:** Press the MENU key twice. Select the **Sonar** tab.
2. Select Connected Transducer.
3. Confirm the transducer connected to the control head is selected.
4. If there are additional control heads on your boat with a 2D transducer, confirm that they are not pinging while you are mapping. There should be only one 2D transducer pinging on your boat during the recording process.



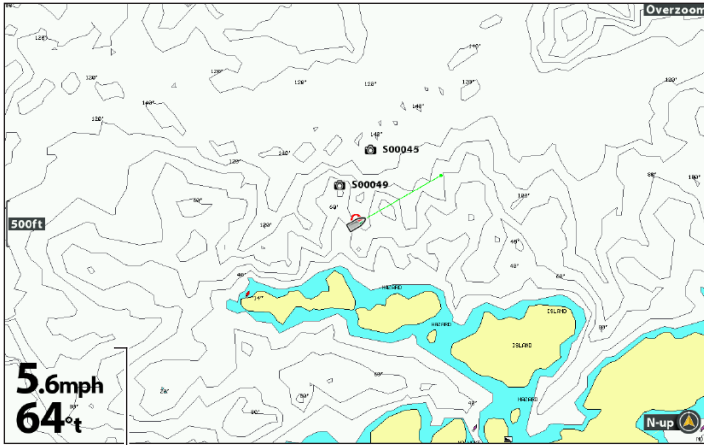
## Confirm Digital Depth and GPS Fix

1. Display a Chart View on-screen.
2. **Confirm Digital Depth:** Confirm the depth digital readout is displayed.  
It may take a moment for depth to be displayed.
3. **Confirm GPS Fix:** Confirm the speed digital readout is displayed.



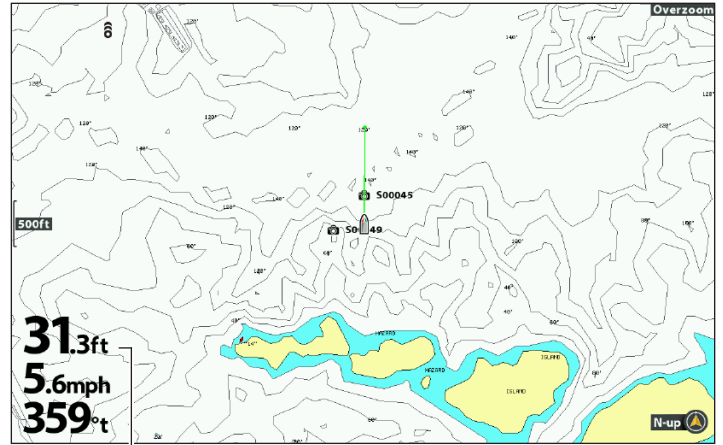
**NOTE:** Digital readouts can be displayed as an overlay, or they can be displayed in data boxes [see **Views: Display Digital Readouts**].

### Confirming the Digital Depth Source



digital depth missing

### Confirming the Digital Depth Source



digital depth detected

## Adjust the Water Level Offset

When you start your mapping for the day, it is important to note if the water level is higher or lower than usual. For example, if you are mapping on a lake and know the lake is down 3 feet, set the Water Level Offset to -3.

1. **Main Menu:** Press the MENU key twice. Select the **HB Chart** tab.
2. Select Water Level Offset.
3. Use the RIGHT or LEFT Cursor keys to adjust the setting.

If the water level is higher than normal, set a positive amount.

If the water level is lower than normal, set a negative amount.

If the water level has not changed [normal], turn off Water Level Offset.

## Display the Current Track (optional)

It is helpful to display the current track so you can see where the boat has already traveled while you're recording the map.

1. **Main Menu:** Press the MENU key twice. Select the **Nav** tab.
2. Select Current Track. Press the RIGHT Cursor key.
3. Select Appearance. Press the RIGHT Cursor key.
4. Select Visibility. Press the RIGHT or LEFT Cursor key to select Visible.
5. **Save:** Select Save. Press the RIGHT Cursor key.

## Start a Sonar Recording for AutoChart PC (optional)

If you are planning to use AutoChart PC, start a sonar recording before you start recording your custom map.

1. Install a microSD or SD card into the control head card slot.  
See **HELIX Control Head** for compatibility details.
2. Press and hold the VIEW key.
3. Select System > Snapshot and Recording View.
4. Press the MENU key.
5. Select Start Recording. Press the RIGHT Cursor key.

**File Name:** A waypoint will also be created at the boat location, and the recording shares the same file name as the waypoint [.SON].

**Use Different Views:** To use different views on the control head and continue recording, press the EXIT key.

**Not Available:** Taking screen snapshots and playback mode are not available during recording.



**NOTE:** For more information, see **Manage Screen Snapshots and Recordings**.

## 2. RECORD YOUR CUSTOM MAP

1. **Preparation:** Before you start mapping for the day, confirm that the control head is set up as shown in the section *Prepare the Control Head for Mapping*.
2. **Chart X-Press Menu:** With a Chart View displayed on-screen, press the MENU key once.
3. Select AutoChart. Press the RIGHT Cursor key.
4. Select Record.
5. Select On.

**Display:** Select AutoChart. Select Visible [LakeMaster] or press the CHECK key or the RIGHT Cursor key to add a check mark [CoastMaster].

**Zoom In:** Press the +ZOOM key to see the depth data on the Chart View.

6. Navigate your boat in a zig-zag pattern, first in one direction and then in the other. For optimal performance, maintain a consistent speed between 0 and 8 mph. See *Plan your Map* for details.

### Starting an AutoChart Live Recording



### 3. STOP RECORDING

Use the instructions in this section to stop recording. Your map is automatically saved to the control head [internal] or to the ZeroLine Map Card if it is installed.

1. **Chart X-Press Menu:** With a Chart View displayed on-screen, press the MENU key once.
2. Select AutoChart. Press the RIGHT Cursor key.
3. Select Record.
4. Select Off.

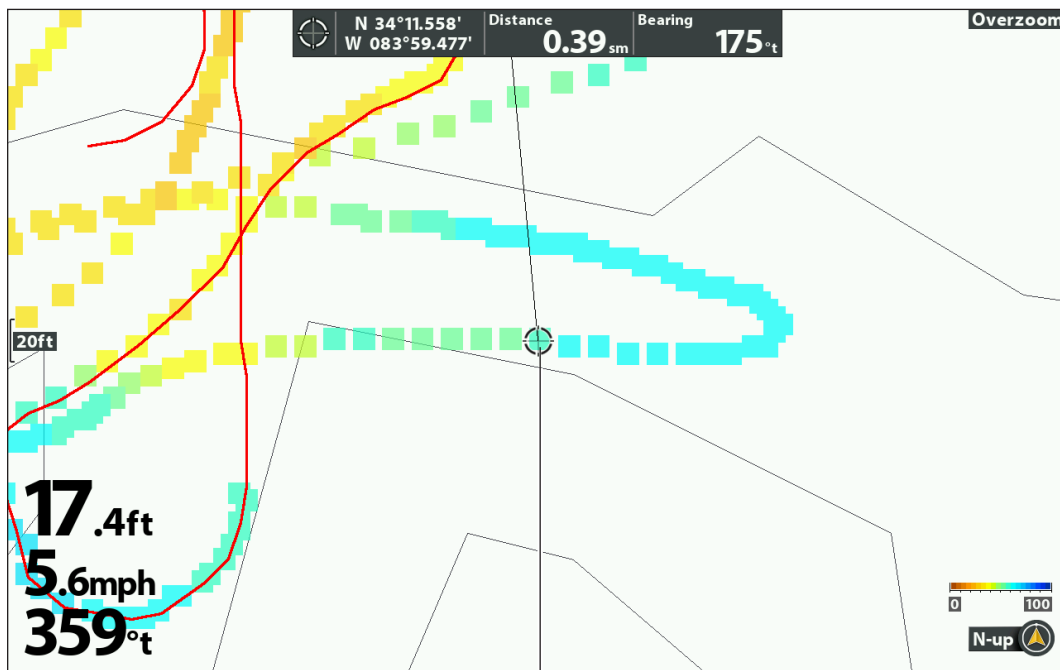
If you do not have a ZeroLine Map Card installed, and the control head storage [8 hours] is reached, the control head will provide a dialog box to Confirm or Clear Data. To save your map and turn off recording, select Confirm. To erase your map and start over, select Clear Data.

### CORRECT DATA

If you see an irregularity in the data [such as lost depth], it can be deleted. Recording must be turned off while you correct the data.

1. **Chart X-Press Menu:** With a Chart View displayed on-screen, press the MENU key once.
2. Select AutoChart. Press the RIGHT Cursor key.
3. Select Show Raw Data. Press the RIGHT Cursor key.
4. Press the +ZOOM key to see individual data points.
5. Exit the AutoChart Menu by pressing the EXIT key three times and then move the cursor over a data point.
6. From the AutoChart menu, select Delete. Press the RIGHT Cursor key.

Selecting a Data Point




cursor selecting a data point

## USING AUTOCHART LIVE IN ICE FISHING MODE

---

AutoChart Live is available on ICE HELIX control heads and All-Season control heads operating in Ice Fishing Mode (GPS units only). AutoChart Live maps created while in Ice Fishing Mode are single snapshots rather than recordings of large areas.

 **NOTE:** Ice Fishing Mode must be turned on to enable this feature [see *Ice Fishing Overview: Turn on Ice Fishing Mode*].

### Capture Your Custom Map

1. **Preparation:** Before you capture your map, confirm that the control head is set up as shown in the section *Prepare the Control Head for Mapping*.
2. With a Chart View displayed on-screen, press the MARK key.
3. Select AutoChart.
4. Press the RIGHT Cursor key.

Your map is automatically saved to the control head [internal] or to the ZeroLine Map Card if it is installed.

## OPEN THE AUTOCHART MENU

You will use the AutoChart menu for all settings. Some of the menu options in this section may be displayed in other parts of the menu system so that you can access them quickly. No matter where you make the change, the control head will update the setting across the system.

1. **Chart X-Press Menu:** With a Chart View displayed on-screen, press the MENU key once.
2. Select AutoChart. Press the RIGHT Cursor key.

## DISPLAY THE AUTOCHART LIVE MAP

You can make changes to the AutoChart Live map during recording or after you've saved your map. You can also view bottom hardness or vegetation data, and you can customize how the data is displayed.

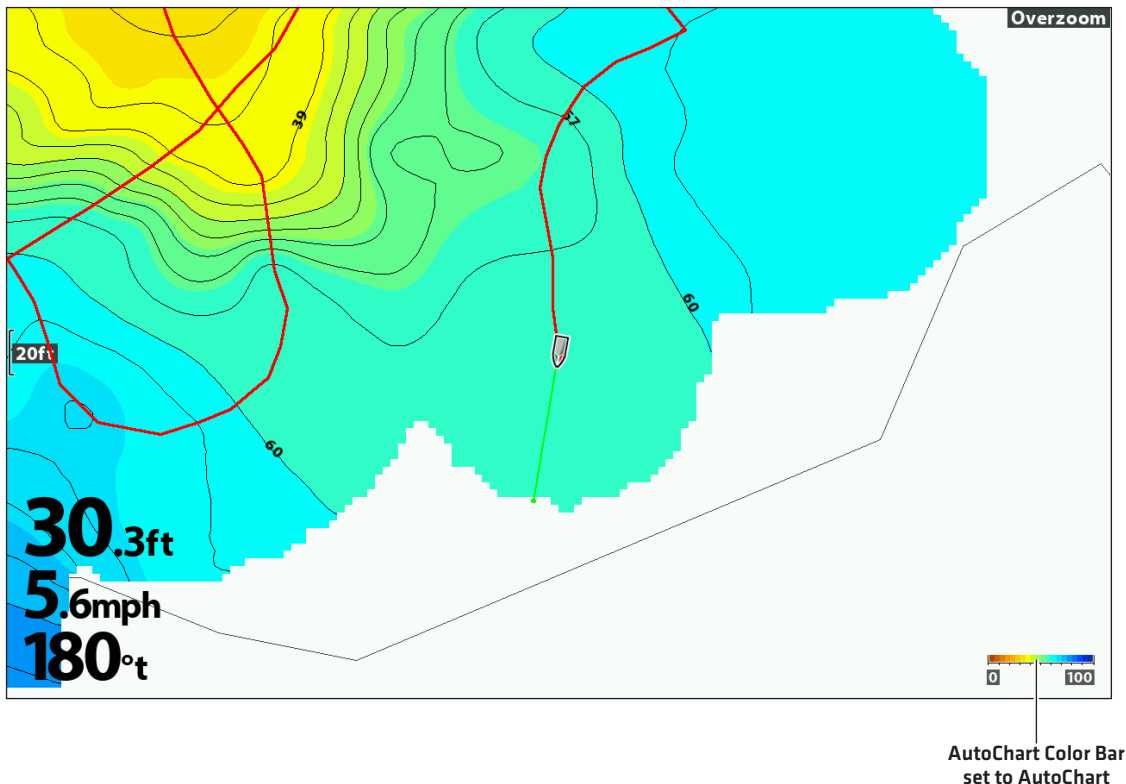
### Show/Hide the AutoChart Live Map

The custom map can be displayed or hidden while you are recording or after the map is saved. You can also adjust the transparency.

#### Show the AutoChart Live Map

1. From the AutoChart menu, select AutoChart.
2. Select Visible [LakeMaster] or press the CHECK/INFO key or the RIGHT Cursor key to add a check mark [CoastMaster].

**Chart View with AutoChart Live Map Displayed**



#### Hide the AutoChart Live Map

1. From the AutoChart menu, select AutoChart.
2. Select Hidden [LakeMaster] or press the CHECK/INFO key or the RIGHT Cursor key to remove the check mark [CoastMaster].

## Adjust the Transparency

1. From the AutoChart menu, select AutoChart Transparency.
2. Press the RIGHT or LEFT Cursor keys to adjust the setting.

## Display the AutoChart Color Bar

The AutoChart Color Bar allows you to display the palette icon for AutoChart or Bottom Type. See the illustrations *Chart View with AutoChart Live Map Displayed* and *Chart/Chart Combo View*.

You can use this icon to see the selected palette and, from left to right, the AutoChart Live depth range [low to high], Bottom Hardness range [soft to hard], or Vegetation range [soft to hard].

## Show/Hide the AutoChart Color Bar

1. From the AutoChart menu, select AutoChart Color Bar.
2. Select a display bar.

## Display AutoChart Live and Bottom Layer in Chart/Chart Combo View

You can also use the Chart/Chart Combo View to display AutoChart Live and Bottom Layer data at the same time. Use the X-Press Menu to make adjustments to each pane. See *Views: Combo Views* for more information.

## Display the Chart/Chart Combo View

1. Press and hold the VIEW key.
2. Select Chart > Chart/Chart Combo View.

### Chart/Chart Combo View (Map Source: Humminbird LakeMaster)

indicates the selected pane (Active Pane)

The diagram illustrates the Chart/Chart Combo View with two map panes. The left pane shows a bathymetric map with depth contours and a color bar. The right pane shows a vegetation map with a color bar. An arrow points to the top of the right pane, indicating it is the active pane. Two AutoChart menus are shown: one on the left for the left pane and one on the right for the right pane. The left menu has 'AutoChart Color Bar' selected, and the right menu has 'Bottom Type' selected.

AutoChart Menu	AutoChart Menu
AutoChart	AutoChart
Record	AutoChart Options
AutoChart	Show Raw Data
AutoChart Transparency	Bottom Layer
AutoChart Options	Bottom Type
Show Raw Data	Vegetation
Bottom Layer	Vegetation Transparency
AutoChart Color Bar	Vegetation Options
AutoChart	AutoChart Color Bar
	Bottom Type

AutoChart Live Map Visible

AutoChart Live Visible with Vegetation Bottom Layer Displayed

# CUSTOMIZE THE AUTOCHART LIVE MAP DISPLAY SETTINGS

Use the AutoChart Options menu to adjust the depth range, contour interval, and map position. You can also change the color palette and shading.

## Open the AutoChart Options Menu

You will use the AutoChart Options menu for all display settings.

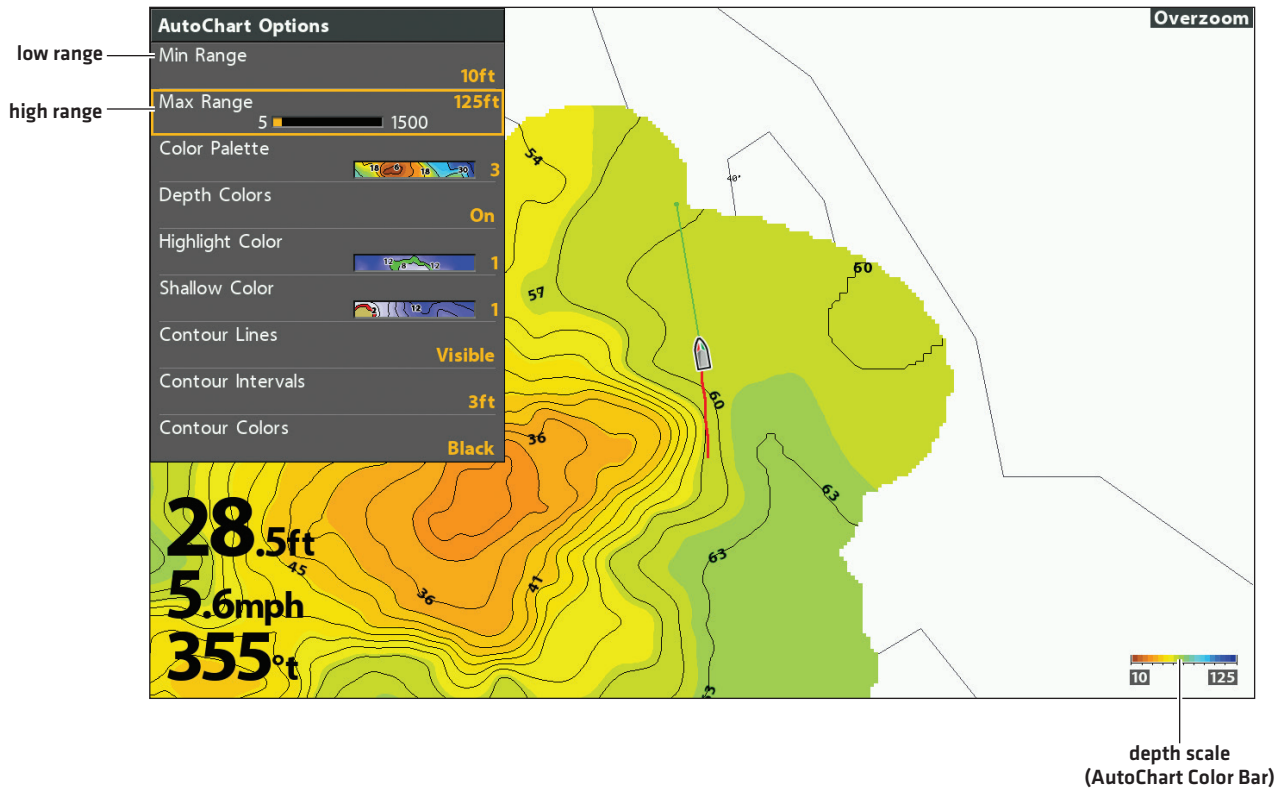
1. **Chart X-Press Menu:** With a Chart View displayed on-screen, press the MENU key once.
2. Select AutoChart. Press the RIGHT Cursor key.
3. Select AutoChart Options. Press the RIGHT Cursor key.

## Adjust the Depth Range

You can adjust the range of data shown on the chart by changing the minimum range and maximum range on the display. The range you select affects how the depth colors are displayed. For related color or shading options, see **Change the Display Colors**.

1. From the AutoChart Options menu, select Min Range.
2. Press the RIGHT or LEFT Cursor keys to adjust the setting.
3. Select Max Range.
4. Press the RIGHT or LEFT Cursor keys to adjust the setting.

Adjusting the AutoChart Live Map Depth Range



**NOTE:** Use the AutoChart Color Bar icon see the selected palette and, from left to right, the AutoChart depth range [low to high], Bottom Hardness range [soft to hard], or Vegetation range [soft to hard].



## Change the Display Colors

Use the following instructions to change the color palette used to display the AutoChart Live map.

### Changing the AutoChart Live Map Display Colors (Map Source: Humminbird LakeMaster)

The image displays the AutoChart Options menu on the left and a bathymetric map on the right. The menu includes the following settings:

- AutoChart Options
- Min Range: 0ft
- Max Range: 100ft
- Color Palette: (selected)
- Depth Colors: On
- Highlight Color: 2
- Shallow Color: 1
- Contour Lines: Visible
- Contour Intervals: 3ft
- Contour Colors: Black

The map shows depth contours with a red circle highlighting a specific area. A depth scale (AutoChart Color Bar) is shown at the bottom right, ranging from 0 to 100.



**NOTE:** Use the AutoChart Color Bar icon see the selected palette and, from left to right, the AutoChart depth range [low to high], Bottom Hardness range [soft to hard], or Vegetation range [soft to hard].

## Show/Hide Depth Colors

Use the following instructions to show or hide the depth colors. If you hide the depth colors, the contours will be shown on the display.

1. From the AutoChart Options menu, select Depth Colors.
2. **LakeMaster Users:** Select a On [visible] or Off [hidden].

**CoastMaster Users:** Press the CHECK/INFO key or the RIGHT Cursor key. [check mark = visible, blank = hidden]

## Change the Color Palette

The Color Palette menu changes the colors used to display the AutoChart Live map. The color range is shown in the AutoChart Color Bar and is affected by the Min Range and Max Range settings. See **Adjust the Depth Range** for more information.

1. From the AutoChart Options menu, select Color Palette.
2. Select a palette.

## Change the Highlight Color

If you've set a Depth Highlight in the HB Chart tab, and it is not easy to see with the AutoChart Live color palette you've selected, you can change the Highlight Color. See **Display Humminbird LakeMaster Contour Lines and Depth Ranges** or **Display Humminbird CoastMaster Contour Lines and Depth Ranges** for more information.

1. From the AutoChart Options menu, select Highlight Color.
2. Select a color.

## Change the Shallow Color

If you've set the Shallow Water Highlight in the HB Chart tab, and it is not easy to see with the AutoChart Live color palette you've selected, you can change the Shallow Color. See **Display Humminbird LakeMaster Contour Lines and Depth Ranges Display** or **Humminbird CoastMaster Contour Lines and Depth Ranges** for more information.

1. From the AutoChart Options menu, select Shallow Color.
2. Select a color.

## Display Contour Lines and Adjust the Contour Interval

You can display or hide the contour lines on the map, and you can adjust the distance between each contour line. Contour Interval is also affected by the Water Level Offset setting.

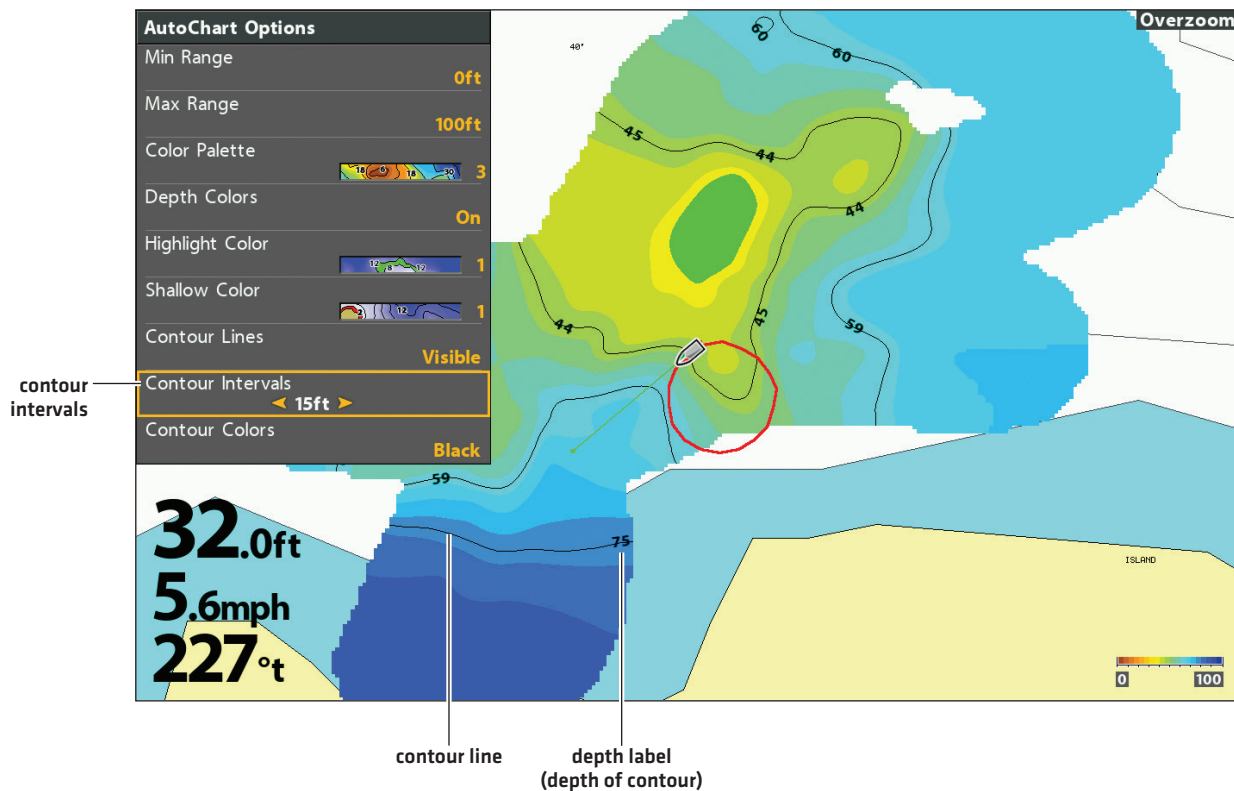
### Display the Contour Lines and Adjust the Contour Interval

1. From the AutoChart Options menu, select Contour Lines.
2. Select Visible [LakeMaster] or press the CHECK/INFO key or the RIGHT Cursor key to add a check mark [CoastMaster].
3. Select Contour Intervals.
4. Press the RIGHT or LEFT Cursor keys to adjust the setting.

### Change the Contour Lines Color

1. From the AutoChart Options menu, select Contour Colors.
2. Select a color.

Changing the AutoChart Live Map Display Colors (Map Source: Humminbird LakeMaster)

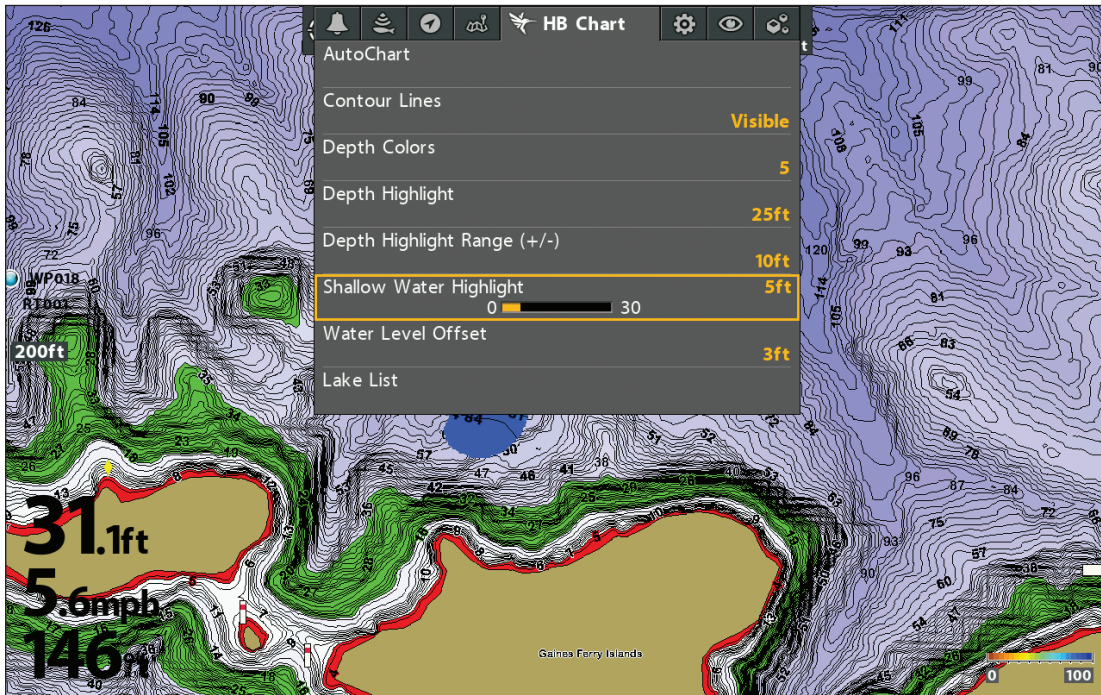


## Add Settings with Chart Options

You can also add adjustments to your custom map using the HB Chart menu. For example, if Humminbird is set as the map source, you can add Depth Colors, Shallow Water, etc. to your AutoChart Live map. See [Display Humminbird LakeMaster Contour Lines and Depth Ranges](#) or [Display Humminbird LakeMaster Contour Lines and Depth Ranges](#).

If Navionics is set as the map source, you can display Contours and Shading on your AutoChart Live map. See [Customize the Chart View](#) for more information.

### Adding Shallow Water Settings to the Map (Map Source: Humminbird LakeMaster)



## Change the Water Level Offset

When you start your mapping for the day, it is important to note if the water level is higher or lower than usual. See [Prepare the Control Head for Mapping](#) for more information.

1. **Main Menu:** Press the MENU key twice. Select the **HB Chart** tab.
2. Select Water Level Offset.
3. Use the RIGHT or LEFT Cursor keys to adjust the setting.

**If the water level is higher than normal,** set a positive amount.

**If the water level is lower than normal,** set a negative amount.

**If the water level has not changed [normal],** turn off Water Level Offset.

# CUSTOMIZE THE BOTTOM HARDNESS DISPLAY SETTINGS

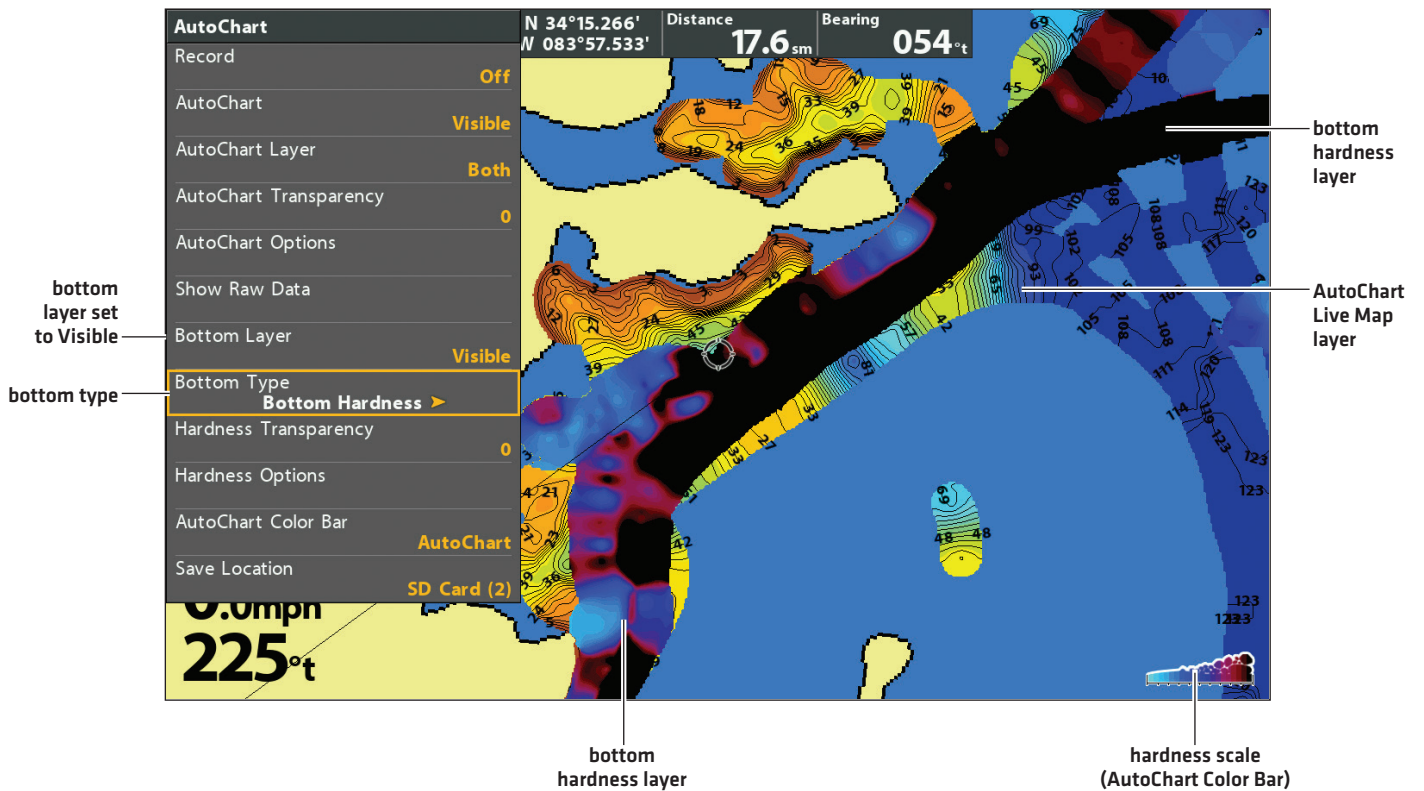
The Bottom Layer is displayed on top of the AutoChart Live map and can be displayed as bottom hardness or vegetation. Bottom Hardness shows strong sonar returns resulting from compacted sediment, rocks, fallen trees, etc.

## Show/Hide Bottom Hardness

### Show Bottom Hardness

1. From the AutoChart menu, select Bottom Layer.
2. Select Visible [LakeMaster] or press the CHECK/INFO key or the RIGHT Cursor key to add a check mark [CoastMaster].
3. Select Bottom Type.
4. Select Bottom Hardness.

Displaying the Bottom Hardness Layer (Map Source: Humminbird LakeMaster)



### Hide Bottom Hardness

1. From the AutoChart menu, select Bottom Layer.
2. Select Hidden [LakeMaster] or press the CHECK/INFO key or the RIGHT Cursor key to remove the check mark [CoastMaster].

## Adjust the Gain Offset

Use Gain Offset to tune the bottom hardness display. For example, if you're fishing a lake where most of the lake has a hard bottom, reduce the gain so only the hardest bottom is displayed.

1. From the AutoChart menu, select Hardness Options.  
Press the RIGHT Cursor key.
2. Select Gain Offset.
3. Press the RIGHT or LEFT Cursor keys to adjust the setting.

## Adjust the Bottom Hardness Transparency

The bottom layer is displayed on top of the AutoChart Live map, and you can adjust the transparency to see different layers on the view.

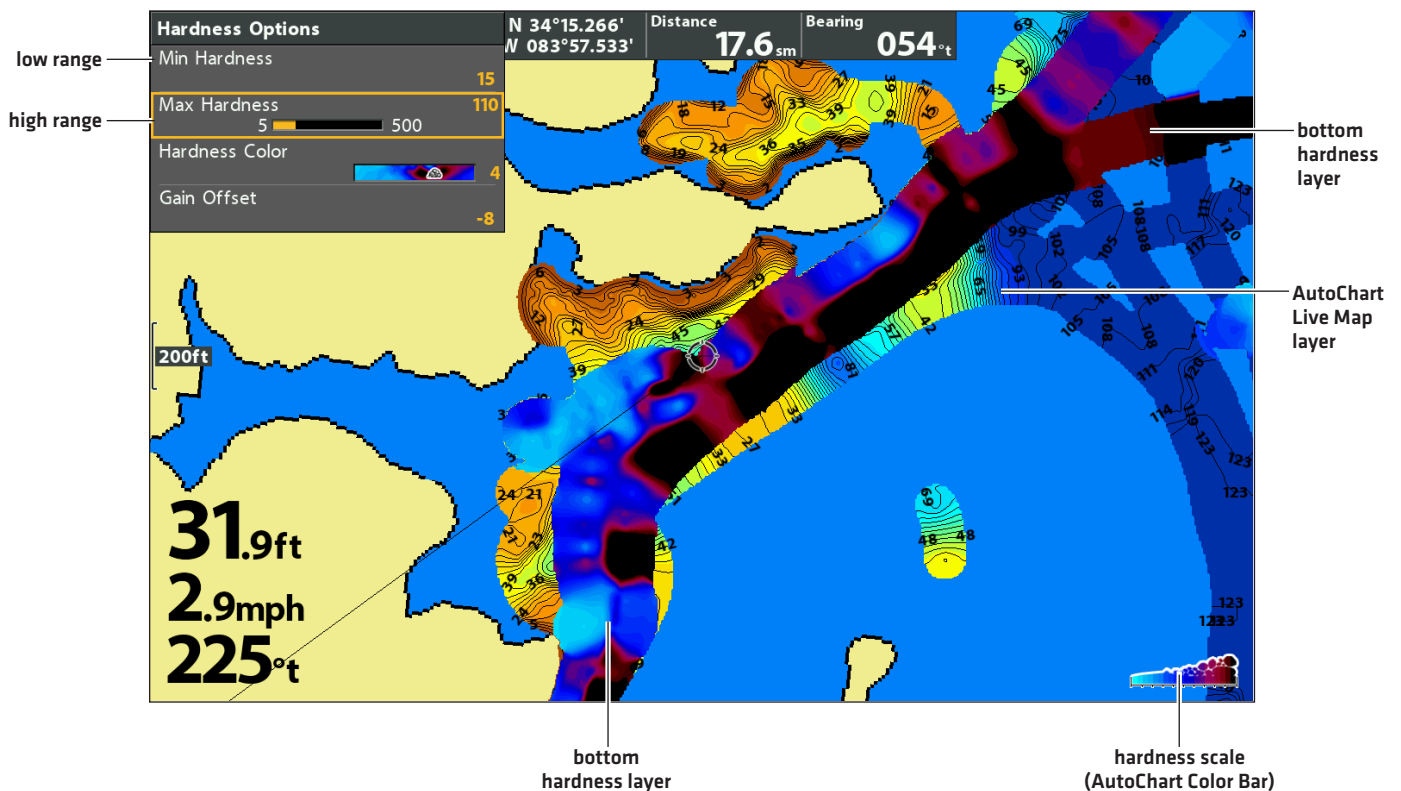
1. From the AutoChart menu, select Hardness Transparency.
2. Press the RIGHT or LEFT Cursor keys to adjust the setting.

## Adjust the Hardness Range

You can adjust the range of bottom hardness shown on the chart by changing the minimum range and maximum range on the display. The range you select affects how the bottom hardness colors are displayed. The range is displayed in the AutoChart Color Bar with Bottom Hardness selected.

1. From the AutoChart menu, select Hardness Options.  
Press the RIGHT Cursor key.
2. Select Min Hardness.
3. Press the RIGHT or LEFT Cursor keys to adjust the setting.
4. Select Max Hardness.
5. Press the RIGHT or LEFT Cursor keys to adjust the setting.

Adjusting the Bottom Hardness Range (Map Source: Humminbird LakeMaster)

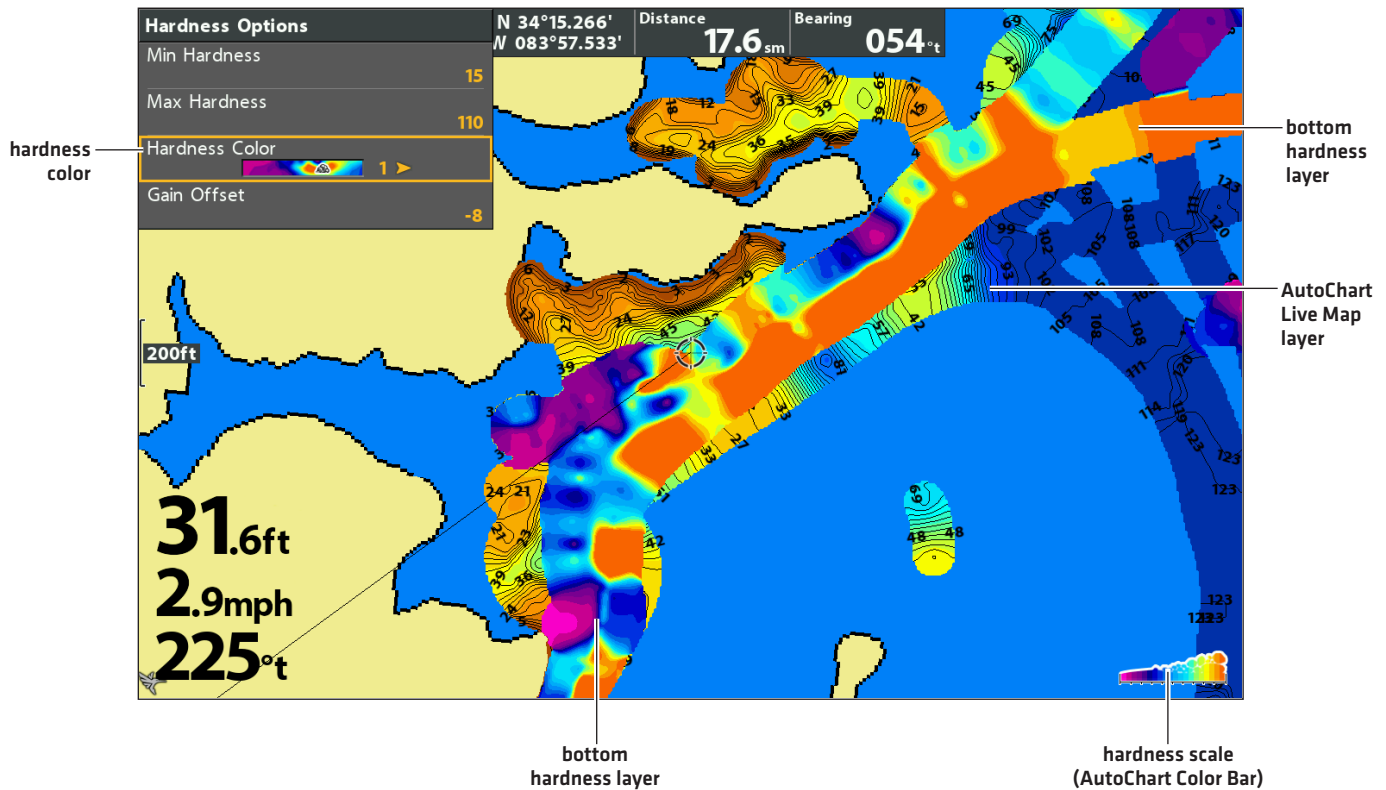


**NOTE:** Use the AutoChart Color Bar icon see the selected palette and, from left to right, the AutoChart Live depth range [low to high], Bottom Hardness range [soft to hard], or Vegetation range [soft to hard].

## Change the Bottom Hardness Colors

Use the following instructions to change the color palette used to display Bottom Hardness.

### Changing the Bottom Hardness Colors (Map Source: Humminbird LakeMaster)



**NOTE:** Use the AutoChart Color Bar icon see the selected palette and, from left to right, the AutoChart Live depth range (low to high), Bottom Hardness range (soft to hard), or Vegetation range (soft to hard).

## Change the Hardness Colors

The Hardness Color menu changes the colors used to display bottom hardness on the view. The color range is shown in the AutoChart Color bar and is affected by the Min Hardness and Max Hardness settings. See *Adjust the Hardness Range* for more information.

1. From the AutoChart menu, select Hardness Options.  
Press the RIGHT Cursor key.
2. Select Hardness Color.
3. Select a palette.



# CUSTOMIZE THE VEGETATION DISPLAY SETTINGS

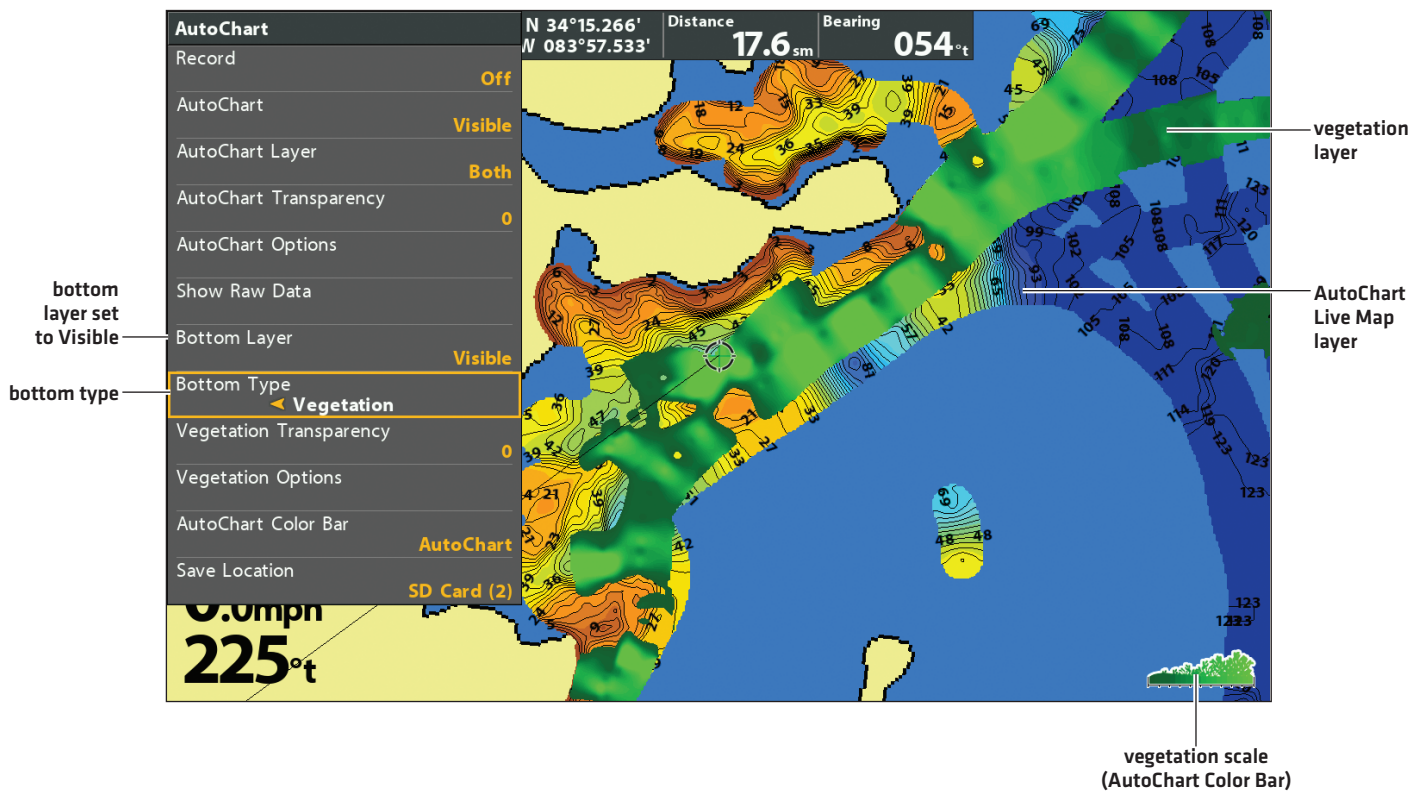
The Bottom Layer is displayed on top of the AutoChart Live map and can be displayed as bottom hardness or vegetation. Vegetation shows the sonar returns interpreted as vegetation on the Chart View.

## Show/Hide Vegetation

### Show Vegetation

1. From the AutoChart menu, select Bottom Layer.
2. Select Visible [LakeMaster] or press the CHECK/INFO key or the RIGHT Cursor key to add a check mark [CoastMaster].
3. Select Bottom Type.
4. Select Vegetation.

Displaying the Vegetation Layer (Map Source: Humminbird LakeMaster)



### Hide Vegetation

1. From the AutoChart Live menu, select Bottom Layer.
2. Select Hidden [LakeMaster] or press the CHECK/INFO key or the RIGHT Cursor key to remove the check mark [CoastMaster].

## Adjust the Gain Offset

Use Gain Offset to tune the vegetation display. Vegetation will vary with the lake, season, or environment you are fishing, and you should adjust the Gain Offset as needed.

1. From the AutoChart menu, select Vegetation Options.  
Press the RIGHT Cursor key.
2. Select Gain Offset.
3. Press the RIGHT or LEFT Cursor keys to adjust the setting.

## Adjust the Vegetation Transparency

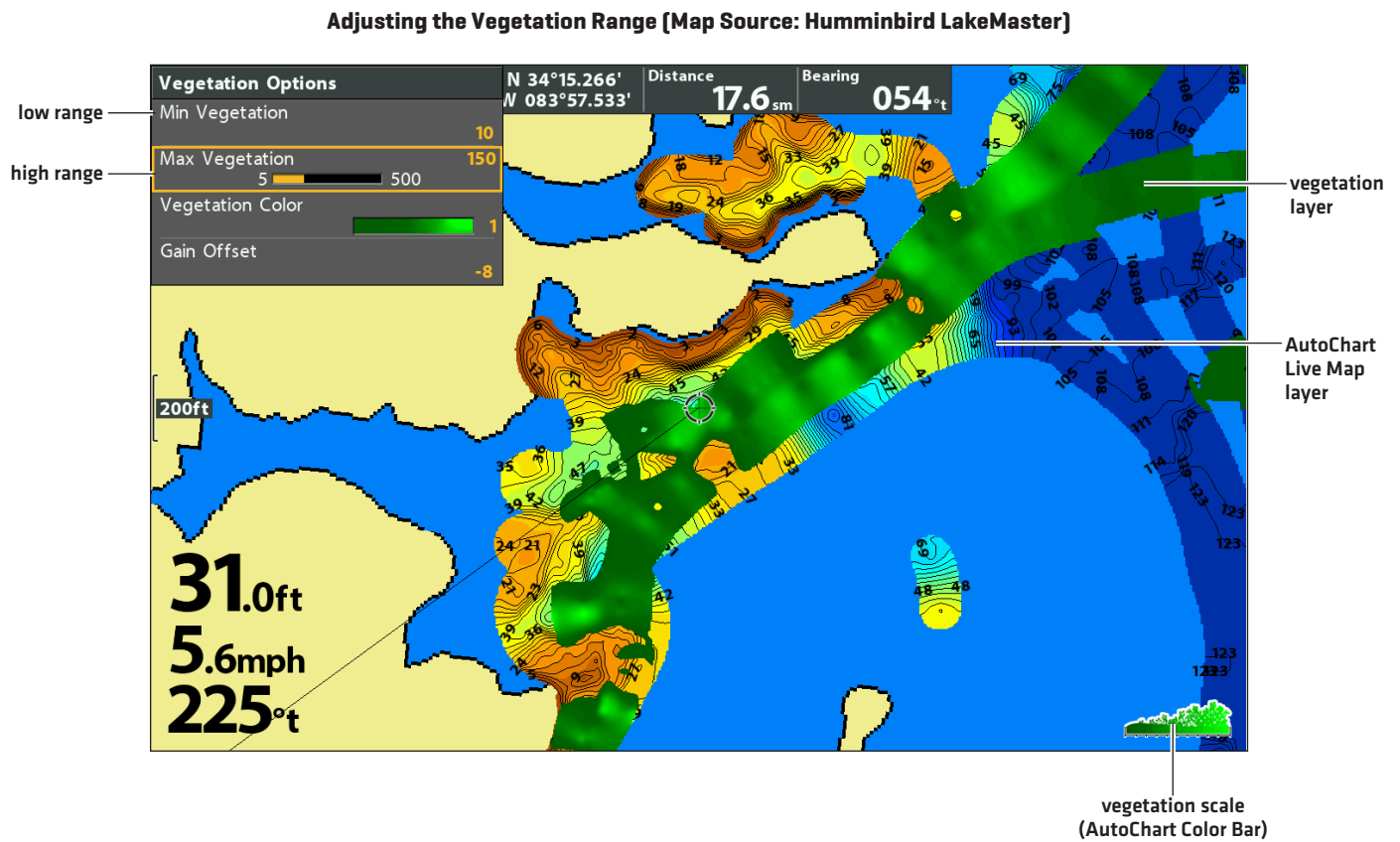
The bottom layer is displayed on top of the AutoChart Live map, and you can adjust the transparency to see different layers on the view.

1. From the AutoChart menu, select Vegetation Transparency.
2. Press the RIGHT or LEFT Cursor keys to adjust the setting.

## Adjust the Vegetation Range

You can adjust the range of vegetation shown on the chart by changing the minimum range and maximum range on the display. The range you select affects how the vegetation colors are displayed.

1. From the AutoChart menu, select Vegetation Options.  
Press the RIGHT Cursor key.
2. Select Min Vegetation.
3. Press the RIGHT or LEFT Cursor keys to adjust the setting.
4. Select Max Vegetation.
5. Press the RIGHT or LEFT Cursor keys to adjust the setting.

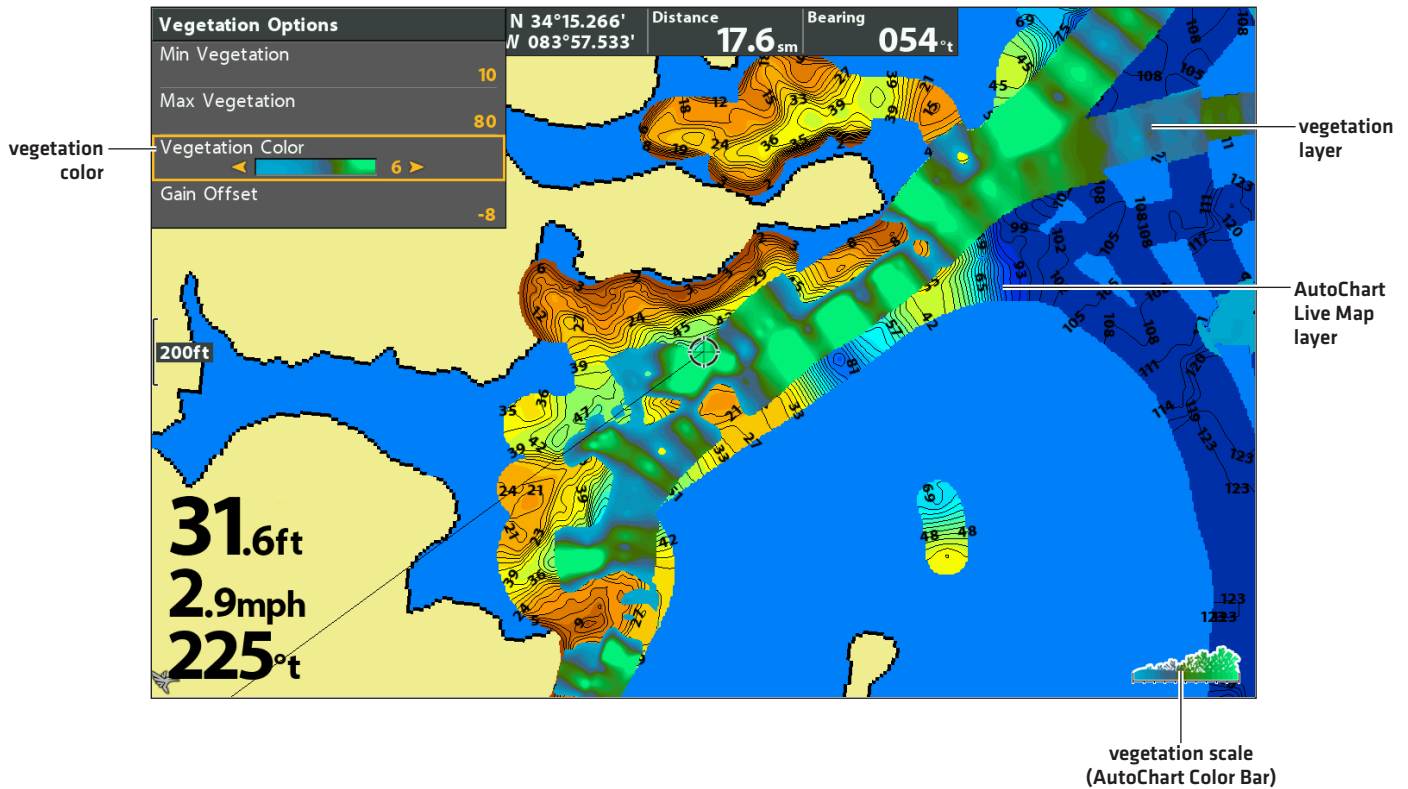


 **NOTE:** Use the AutoChart Color Bar icon see the selected palette and, from left to right, the AutoChart Live depth range [low to high], Bottom Hardness range [soft to hard], or Vegetation range [soft to hard].

## Change the Vegetation Colors

Use the following instructions to change the color palette used to display vegetation.

### Changing the Vegetation Colors (Map Source: Humminbird LakeMaster)



**NOTE:** Use the AutoChart Color Bar icon see the selected palette and, from left to right, the AutoChart Live depth range [low to high], Bottom Hardness range [soft to hard], or Vegetation range [soft to hard].

## Change the Vegetation Colors

The Vegetation Color menu changes the colors used to display vegetation on the view. The color range is shown in the AutoChart Color bar and is affected by the Min Vegetation and Max Vegetation settings. See [Adjust the Vegetation Range](#) for more information.

1. From the AutoChart menu, select Vegetation Options.  
Press the RIGHT Cursor key.
2. Select Vegetation Color.
3. Select a palette.

Use the instructions in this section if a NMEA 2000 network is connected to the control head.

When equipment is connected to the control head, the equipment and its data will be detected automatically. You can also manually select equipment and set the data offset. The available menus are determined by the attached equipment.



**NOTE:** Humminbird recommends that the NMEA 2000 network be installed by a certified NMEA 2000 technician. See [NMEA.org](http://NMEA.org) for details.

## Preparation

The NMEA 2000 network connects to the NMEA 2000 port on one control head. If you have a multi-control head network (separate purchase required), select the control head that is connected to the NMEA 2000 network backbone to proceed with the following instructions.

## Turn On the NMEA 2000 Network

1. **Main Menu (Custom User Mode):** Press the MENU key twice. Select the **Data Sources** tab.
2. Select NMEA 2000 Network.
3. Press the RIGHT or LEFT Cursor keys to turn the NMEA 2000 Network on or off.

## Select NMEA 2000 Data Sources

When equipment is connected to the control head, the equipment and its data will be detected automatically. Use the instructions in this section to manually select devices to use on the NMEA 2000 network.

1. **Main Menu:** Press the MENU key twice. Select the **Data Sources** tab.
2. Select the Data Sources menu option. Press the RIGHT Cursor key to open the **NMEA2K Sources** menu.
3. Press the DOWN or UP Cursor key to select a source group.
4. Press the RIGHT Cursor key to open the submenu for that source.
5. Press the DOWN or UP Cursor key to select a data source. Press the RIGHT Cursor key or CHECK/INFO key to select the data source.
6. Press the EXIT key to return to the **NMEA2K Sources** menu.
7. Repeat steps 3 – 6 to select another data source.

## Set Data Offsets

Use the Data Offsets menu to adjust digital readouts by the amount you set.

1. **Main Menu:** Press the MENU key twice. Select the **Data Sources** tab.
2. Select Data Offsets. Press the RIGHT Cursor key to open the **Data Offsets** menu.
3. Select a data option. [Depth Adjustment, Heading Adjustment, NMEA 2K Heading Adjustment, Temp[Water] Adjustment, STW Adjustment]
4. Press the RIGHT or LEFT Cursor keys to adjust the setting.

## NMEA 2000 Messages (PGN)

The following NMEA 2000 input/output messages are available when NMEA 2000 is turned on and the related NMEA 2000 equipment is detected and selected as a source.

Messages (PGN)	Description	Input	Output
059392	ISO Acknowledgement	•	•
059904	ISO Request	•	•
060928	ISO Address Claim	•	•
126208	NMEA - Command/Request/Acknowledge Function	•	•
126464	Receive/Transmit PGN List Group Function	•	•
126992	System Time	•	
126996	Product Information	•	•
127245	Rudder	•	
127250	Vessel Heading	•	
127251	Rate of Turn	•	
127488	Engine Parameters, Rapid Update	•	
127489	Engine Parameters - Dynamic	•	
127497	Trip Parameters, Engine	•	
127505	Fluid Level	•	
128267	Water Depth	•	
129026	COG & SOG, Rapid Update	•	
129029	GNSS Position Data	•	
129033	Time & Date	•	
129283	Cross Track Error	•	
129284	Navigation Data	•	
129285	Navigation - Route/WP Information	•	
129539	GNSS DOPs	•	
129540	GNSS Sats in View	•	
130052	Loran C TD Data	•	
130306	Wind Data	•	
130310	Environmental Parameters	•	
130311	Environmental Parameters	•	
130312	Temperature	•	
130313	Humidity	•	
130314	Actual Pressure	•	
130576	Small Craft Status	•	

## NMEA 2000 AIS Messages (PGN)

The following NMEA 2000 input/output messages are available when NMEA 2000 is turned on and an AIS is detected and selected as a source on the NMEA 2000 network.

Messages (PGN)	Description	Input	Output
129038	Class A Position Report	•	
129039	Class B Position Report	•	
129809	AIS Class B Static Data, Part A	•	
129810	AIS Class B Static Data, Part B	•	

## Change the Engine Source Assignments

The instructions in this section are optional and allow you to change which engine is assigned as the Engine 1 or Engine 2 source in the control head.

1. **Main Menu:** Press the MENU key twice. Select the **Data Sources** tab.
2. Select the **Data Sources** menu option. Press the RIGHT Cursor key to open the **NMEA2K Sources** menu.
3. Select Engine 1 or Engine 2.
4. Press the Right Cursor key.
5. Select an Engine from the list and press the CHECK/INFO key or the RIGHT Cursor key.

## Set the Fuel Tank Capacity

If there is a fuel flow rate sensor installed, but not a NMEA 2000 fuel tank sensor, use the instructions in this section to set up fuel tank data manually.

1. **Main Menu [Custom User Mode]:** Press the MENU key twice. Select the **Data Sources** tab.
2. Select Fuel Tank Override.
3. Use the RIGHT or LEFT Cursor keys to adjust the fuel tank capacity.

## Refill the Fuel Tank

1. **Main Menu [Custom User Mode]:** Press the MENU key twice. Select the **Data Sources** tab.
2. To fill the tank to the top, select Reset Total Fuel and press the RIGHT Cursor key.

## Change Device or System Instance

The settings in this section are optional. You can use the default settings for Device Instance and System Instance or you can customize them with your preferences. Use the Device Instance and System Instance settings to identify devices or groups of devices outputting NMEA 2000 data on a network. Each device or group of devices outputting data on a single network must be identified by a unique instance number.

For example, if your NMEA 2000 network includes two control heads outputting GPS data, set one control head to instance 1 and the other to instance 2. The receiving device on the network can be set to receive GPS data from instance 1 or instance 2.

1. **Main Menu [Custom User Mode]:** Press the MENU key twice. Select the **Data Sources** tab.
2. **To identify a single device,** select Device Instance.  
**To identify a group of devices,** select System Instance.
3. Use the RIGHT or LEFT Cursor keys to select a unique number.

## Set Alarms

Alarms are based on the limits you set for a device such as battery voltage, depth, water temperature, and more. Connecting to a NMEA 2000 network adds the following NMEA 2000 Alarms to the Alarms tab:

- NMEA2K Depth
- NMEA2K Environment
- NMEA2K Engine


Each group expands into a submenu, which lists the alarms that fall under that group.

Menu	Alarm Name	Range
NMEA2K Depth	NMEA2K Shallow Water	Off, 1 – 100 feet, 0.5 – 30.0 meters* or 0.1 – 50 fathoms; Default = Off
	NMEA2K Deep Water	Off, 1 – 100 feet, 0.5 – 30.0 meters* or 0.1 – 50 fathoms; Default = Off
NMEA2K Environment	NMEA2K Temperature [Air]	Off, - 40°F – +140° F or - 40°C – + 60° C*; Default = Off
	NMEA2K Temperature [Water]	Off, 33°F – 120°F or 1°C – 50°C*; Default = Off
NMEA2K Engine	Total Fuel	Off, 1% – 100%; Default = Off
	Check Engine	Off, On; Default = Off
	Engine Over Temperature	Off, On; Default = Off
	Engine Low Oil Pressure	Off, On; Default = Off
	Engine Low Oil Level	Off, On; Default = Off
	Engine Low Fuel Pressure	Off, On; Default = Off
	Engine Low System Voltage	Off, On; Default = Off
	Engine Low Coolant Level	Off, On; Default = Off
	Engine Water Flow	Off, On; Default = Off
	Engine Charge Indicator	Off, On; Default = Off

\*International models only.

### Set NMEA2K Alarms


1. **Main Menu [Custom User Mode]:** Press the MENU key twice. Select the **Alarms** tab.
2. Select a NMEA2K alarm group. [NMEA2K Depth, NMEA2k Environment, NMEA2K Engine]
3. Press the RIGHT Cursor key to open the submenu.
4. Press the DOWN or UP Cursor key to select an alarm.
5. Press the RIGHT or LEFT Cursor key to adjust the setting.
6. **Close:** Press the EXIT key to return to the Alarms menu.

 **NOTE:** When an alarm is triggered, you can silence it by pressing any key. The alarm will be silenced and will not be triggered again until a new instance of the alarm condition is triggered.



# UNDERSTAND THE NMEA 2000 INSTRUMENT VIEW

The NMEA 2000 Instrument View presents a full screen view of gauges and data boxes. It automatically displays a default data set, or you can select the data readouts for the gauges and data boxes. You can also choose to hide the data boxes.

 **NOTE:** The view must be displayed on the screen in order to change the digital readouts.

## Select Readouts for the NMEA 2000 Instrument View

To customize data items displayed within the NMEA 2000 Instrument View, see the instructions below.

### Customize Data Box Readouts

You can select the data that will be displayed in each box. Use the Edit Data Boxes menu to set your standard digital readouts. Use the Edit Navigation Data Boxes menu to set the digital readouts that will be displayed during navigation.

1. **NMEA 2000 X-Press Menu:** With the NMEA 2000 Instrument View displayed on screen, press the MENU key once.
2. Select Edit Data Boxes or Edit Navigation Data boxes. Press the RIGHT Cursor key.
3. Select a Data Box [Data Box 1, 2, 3, etc.].
4. Select a digital readout.

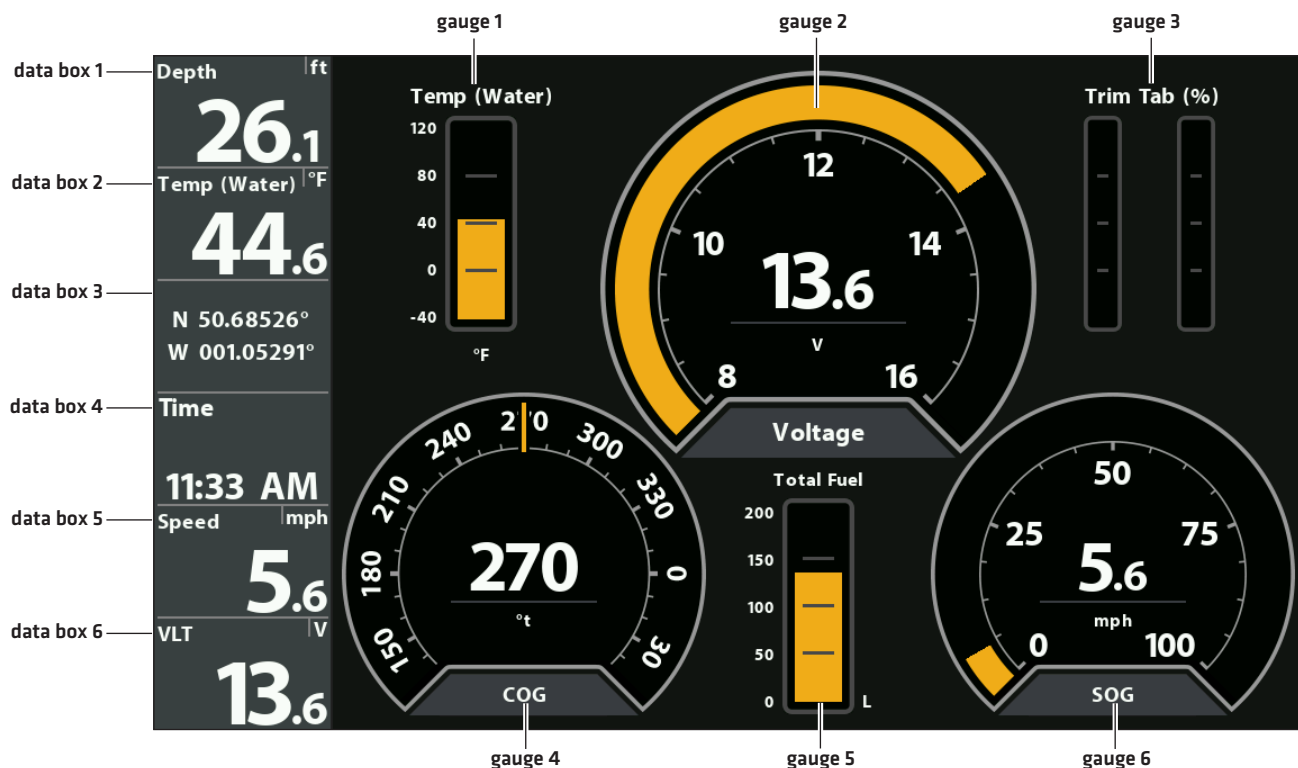
**Hide:** To hide the data boxes, select Data Box. Use the LEFT Cursor key to select Off.

### Customize Gauge Readouts

You can select the data that will be displayed by each gauge.

1. **NMEA 2000 X-Press Menu:** With the NMEA 2000 Instrument View displayed on screen, press the MENU key once.
2. Select Edit Gauges. Press the RIGHT Cursor key.
3. Select a Gauge [Gauge 1, 2, 3, etc.].
4. Select a digital readout.

NMEA 2000 View (HELIX 10)



# MANAGE YOUR CONTROL HEAD

## Check System Status

Use the System Status View to review control head information such as the software version and serial number.

1. Press and hold the VIEW key.
2. Select System. Press the RIGHT Cursor key.
3. Select System Status. Press the RIGHT Cursor key.

### System Status View [HELIX 10 CHIRP MEGA SI+ GPS G4N]

Depth	ft	System Status	
35.4		Self Test	Passed
Temp (Water)	°C	Serial Number	19111522000025
14.3		Model	HELIX 10x CHIRP MEGA SI+ GPS G4N
N 50.68646°		Software Version	2.224
W 001.05296°		Humminbird Basemap	1.031
Time		Voltage	13.7 V
2:04 PM		Total Time	19 hrs
Speed	mph	IP Address	192.168.1.108
5.6		MAC Address	00:1a:29:00:00:25
VLT	V		
13.7			

## Select an Installed GPS Receiver

The GPS Receiver Override menu is available when more than one GPS receiver is installed and detected by the control head. If GPS Receiver Override is set to Auto, the control head will select a GPS receiver automatically. To manually select a GPS receiver, follow the instructions in this section.



**NOTE:** If the control head is connected to an Ethernet network, this menu is not available. In this situation, use the Network Source Setup dialog box to select a GPS source.

1. **Main Menu [Custom User Mode]:** Press the MENU key twice. Select the **Nav** tab.
2. Select GPS Receiver Override.
3. Select a GPS installation location.

## Set the GPS Output Frequency

GPS Output controls the frequency at which data from the GPS Receiver is sent to the control head. Select 10 Hz to receive the most GPS updates on the display.

### HELIX G3/G3N and older

1. **Main Menu [Custom User Mode]:** Press the MENU key twice. Select the **Setup** tab.
2. Select GPS Output.
3. Press the RIGHT or LEFT Cursor keys to select a setting.

### HELIX G4N

1. **Main Menu [Custom User Mode]:** Press the MENU key twice. Select the **Data Sources** tab.
2. Select GPS Settings and press the RIGHT Cursor key to open the GPS Settings menu.
3. Select GPS Output.
4. Press the RIGHT or LEFT Cursor keys to select a setting.

## Turn on/off GPS GLONASS

Use the following instructions to use GLONASS.

### HELIX G3/G3N and older

1. **Main Menu [Custom User Mode]:** Press the MENU key twice. Select the **Setup** tab.
2. Select GPS GLONASS.
3. Select On or Off.

### HELIX G4N

1. **Main Menu [Custom User Mode]:** Press the MENU key twice. Select the **Data Sources** tab.
2. Select GPS Settings and press the RIGHT Cursor key to open the GPS Settings menu.
3. Select GPS GLONASS.
4. Select On or Off.

## Turn on/off NMEA 0183 Output

NMEA Output should be turned on if you connect the NMEA Output wires of an accessory GPS receiver [external] or heading sensor cable to another NMEA-compatible device, such as an autopilot.

### HELIX G3/G3N and older

1. **Main Menu [Custom User Mode]:** Press the MENU key twice. Select the Setup tab.
2. Select NMEA 0183 Output.
3. Select On or Off.

### HELIX G4N

1. **Main Menu [Custom User Mode]:** Press the MENU key twice. Select the **Data Sources** tab.
2. Select NMEA 0183 Output.
3. Select On or Off.

If NMEA 0183 Output is turned on, the following sentences are output:

Message	Description
APB	Heading/Track Controller [Autopilot] Sentence "B" [navigation only]
BWR	Bearing & Distance to Waypoint - Rhumb Line [navigation only]
DPT	Depth
GGA	Global Positioning System Fix Data
GLL	Geographical Position - Latitude/Longitude
MTW	Water Temperature
RMB	Recommended Minimum Navigation Info [navigation only]
RMC	Recommended Minimum Specification GNSS Data
VTG	Track Made Good & Ground Speed
ZDA	Time & Date

## Configure the NMEA Talker ID

Use the following instructions to change the NMEA 0183 Talker ID to match the NMEA 0183 installed accessory.

### HELIX G3/G3N and older

1. **Main Menu [Custom User Mode]:** Press the MENU key twice. Select the Setup tab.
2. Select Configure NMEA Talker ID.
3. Select IN-Integrated Navigation [Default] or GP-Global Positioning System.

### HELIX G4N

1. **Main Menu [Custom User Mode]:** Press the MENU key twice. Select the **Data Sources** tab.
2. Select Configure NMEA Talker ID.
3. Select IN-Integrated Navigation [Default] or GP-Global Positioning System.

## Start the Timer

1. **Main Menu:** Press the MENU key twice. Select the **Alarms** tab.
2. Select Timer Setup. Press the RIGHT Cursor key.
3. Use the Cursor Control key to set the hours, minutes, and seconds.
4. To start the Timer immediately, select Start. Press the RIGHT Cursor key.

To save your settings and start the Timer at a later time, select Save. Press the RIGHT Cursor key.



**NOTE:** The Timer can be displayed as a digital readout. See **Views: Display Digital Readouts**.

## Change the Display Language

The available languages are determined by your Humminbird model.



**WARNING!** Do NOT enable Asian Mode if you do not require Asian languages. Before you select Asian Mode, contact Technical Support for important information.

1. **Main Menu:** Press the MENU key twice. Select the **Setup** tab.
2. Select Language.
3. Press the RIGHT or LEFT Cursor keys to select a language.

## Change Digital Readout Formats

Use the following instructions to customize the format for the digital readouts displayed on the control head. See *Views: Display Digital Readouts* for more information.

### Change the Digits Format

If you have Digital Readouts set to Boxes, you can change how the numbers are displayed.

#### HELIX G3/G3N and older

1. **Main Menu [Custom User Mode]:** Press the MENU key twice. Select the Setup tab.
2. Select Digits Format.
3. Press the RIGHT or LEFT Cursor keys to select a format.

#### HELIX G4N

1. **Main Menu [Custom User Mode]:** Press the MENU key twice. Select the **Data Sources** tab.
2. Select Digits Format.
3. Press the RIGHT or LEFT Cursor keys to select a format.

### Change Units of Measurement

#### HELIX G3/G3N and older

1. **Main Menu:** Press the MENU key twice. Select the Setup tab.
2. Select Units - Depth, Units - Distance, etc., and adjust each unit setting as needed.
3. **Close:** Press the EXIT key.



**NOTE:** The Units - Temp menu is only available in an international model.

#### HELIX G4N

1. **Main Menu:** Press the MENU key twice. Select the **Data Sources** tab.
2. Select Units and press the RIGHT Cursor key to open the Units menu.
3. Select each unit as needed and use the RIGHT or LEFT Cursor keys to adjust the setting.
4. **Close:** Press the EXIT key.

## Apply an Offset to a Digital Readout

Use the following instructions to adjust the digital readout by the offset amount entered. Depending on the attached sensors, you can adjust the Depth Adjustment, Temp[Water] Adjustment, Heading Adjustment, NMEA 2k Heading Adjustment, and STW (Speed Through Water) Adjustment from this menu.

For example, select Depth Offset to adjust the digital depth readout by the amount entered. To read the depth from the waterline, enter a positive vertical measurement. To read the depth from the keel, enter a negative amount.

### HELIX G3/G3N and older

1. **Main Menu [Custom User Mode]:** Press the MENU key twice. Select the **Setup** tab.
2. Select each offset menu option as needed. Use the RIGHT or LEFT Cursor keys to adjust the setting.

### HELIX G4N

1. **Main Menu [Custom User Mode]:** Press the MENU key twice. Select the **Data Sources** tab.
2. Select Data Offsets and press the RIGHT Cursor key to open the Data Offsets menu.
3. Select each offset as needed and use the RIGHT or LEFT Cursor keys to adjust the setting.

## Change the Latitude/Longitude Format

### HELIX G3/G3N and older

1. **Main Menu [Custom User Mode]:** Press the MENU key twice. Select the **Setup** tab.
2. Select Position Format.
3. Press the RIGHT or LEFT Cursor keys to select a format.

### HELIX G4N

1. **Main Menu [Custom User Mode]:** Press the MENU key twice. Select the **Data Sources** tab.
2. Select GPS Settings and press the RIGHT Cursor key to open the GPS Settings Menu.
3. Select Position Format.
4. Press the RIGHT or LEFT Cursor keys to select a format.

## Change the Time and Date Format

1. **Main Menu [Custom User Mode]:** Press the MENU key twice. Select the **Setup** tab.
2. Select one of the following menus. Press the RIGHT or LEFT Cursor keys to select a format.

<b>Local Time Zone</b>	Select your time zone.
<b>Daylight Saving Time</b>	To add one hour to the time displayed in the local time zone, select On.
<b>Time Format</b>	Select a time format. International models only.
<b>Date Format</b>	Select a date format. International models only.

## Turn off Demonstration Mode

The control head will start demonstration mode if a start up mode is not selected when the unit is first turned on (see **Getting Started**). If the screen is displaying tips, menus, and views automatically, it is in Demonstration mode. Use the following instructions to turn off Demonstration mode.



**NOTE:** Menu settings cannot be saved in Demonstration mode.

1. **Main Menu:** Press the MENU key twice. Select the **Setup** tab.
2. Select Demonstration.
3. Select Off.

## Adjust the Backlight

1. Press the POWER key.
2. Select Light.
3. Adjust the Backlight setting from Dim to 10 [brightest].

## Start Standby Mode

To conserve power while the control head is not in-use, start Standby mode.

1. Press the POWER key.
2. Select Standby.
3. Press the RIGHT Cursor key.
4. **Turn off:** Press the POWER key.

## Restore System Defaults

Use the following instructions to reset ALL menu settings to the factory defaults.



**CAUTION!** Use this menu with caution!

1. **Main Menu:** Press the MENU key twice. Select the **Setup** tab.
2. Select Restore Defaults.
3. Press the RIGHT Cursor key.
4. Follow the on-screen prompts to confirm the reset.

# MAINTENANCE

Your control head is designed to provide years of trouble-free use with very little maintenance. Use the following procedures to ensure your Humminbird continues to deliver top performance.

## Control Head Maintenance

It is important to consider the following precautions when using your Humminbird control head:

- Chemicals, such as those found in bug spray and sunscreen, may cause permanent damage to the control head screen. Such damage is not covered by the warranty.
- NEVER leave the control head in a closed car or trunk. The high temperatures generated in hot weather can damage the electronics.
- When the control head is not in use, cover the unit with the control head cover.
- Repairs should be performed only by an authorized technician.

Use the following information to keep the control head and screen clean.

- **Screen:** To clean the control head screen, use a mild soap [such as a non-abrasive liquid hand soap] and warm water. Wipe the screen dry with a soft cloth. Be careful to avoid scratching the screen. If water spots remain, use a solution of water and vinegar.



**WARNING!** Do not use a chemical glass cleaner on the screen. Chemicals in the solution may cause cracking in the lens of the unit.



**NOTE:** Do not wipe the screen while dirt or grease is on the screen.

- **Control Head:** If the control head comes into contact with salt spray, wipe the affected surfaces with a cloth dampened with fresh water.

## Transducer Maintenance

Use the following information to maintain the transducer operation.

- If your boat remains in the water for long periods of time, algae and other marine growth can reduce the effectiveness of the transducer. Periodically clean the face of the transducer with a mild, marine-safe and plastic-safe soap or solution.



**NOTE:** To clean the transducer, you may need to pivot the transducer up in the bracket.

- If your boat remains out of the water for a long period of time, it may take some time to wet the transducer when it is returned to the water. Small air bubbles can climb to the surface of the transducer and interfere with proper operation. These bubbles dissipate with time, or you can wipe the face of the transducer with your fingers after the transducer is in the water.



# TROUBLESHOOTING

---

Before contacting Humminbird Technical Support, please read the following section. Taking the time to review these troubleshooting guidelines may allow you to solve a performance problem yourself, and therefore avoid sending your unit back for repair.

## Control Head Doesn't Power Up

If your control head doesn't power up, use the installation guide to confirm the following:

- the power cable is properly connected to the control head
- the power cable is wired correctly, with red to positive battery terminal and black to negative terminal or ground
- the fuse is operational
- the battery voltage of the power connector is at least 12.2 Volts

Correct any known problems, including removing corrosion from the battery terminals or wiring, or replacing the battery if necessary.

## Control Head Doesn't Detect the Connected Transducer

A connected and functioning transducer will automatically be detected by the control head. The control head will default to the transducer that was included with your unit and automatically select sonar settings based on the transducer's capabilities. If, when you power up the control head, it does not automatically select sonar settings or display sonar data, even though a transducer is already connected, this means that the control head is not detecting the transducer. Perform the following troubleshooting tasks:

- Using the transducer installation guide, check to make sure that the transducer cable is securely connected to the control head. Reconnect if necessary, and power up the unit again to see if this fixes the problem.
- Replace the non-functioning transducer with a known good transducer if available and power up the control head again.
- Check the transducer cable. Replace the transducer if the cable is damaged or corroded.

## Control Head Doesn't Detect a Connected Accessory

A connected and functioning accessory will automatically be detected by the control head. If you connected an accessory to the control head and the accessory is not detected by the control head, try the following:

- Check to make sure that the accessory cable is securely connected to the control head. Reconnect the cable, if necessary.
- Confirm the accessory is connected to a stable and reliable power source.
- **Entire System Restart:** Power off all control heads and connected equipment. Wait 10 seconds, and then power on all equipment.

## Display Problems

There are several main conditions or sources of possible interference that may cause problems with the quality of the information displayed on the control head. Look in the following table for some symptoms of display problems and possible solutions:

Display Problems	Possible Solutions
The control head loses power at high speeds.	If the power output of your boat's engine is unregulated, the control head may be protecting itself using its over-voltage protection feature. Make sure the input voltage does not exceed 20 Volts.
When the boat moves at higher speeds, the bottom disappears or suddenly weakens, or the display contains gaps.	The transducer position may need to be adjusted. A mix of air and water flowing around the transducer [cavitation] may be interfering with the interpretation of sonar data. See the transducer installation guide for instructions to adjust the transducer position.  Electrical noise from the boat's engine may be interfering with sonar reception. See <b><i>Finding the Cause of Noise</i></b> for more information.
There are no fish detected, even when you know they are in the water under the boat, or sonar readings seem weak or faulty.	Sonar readings may be affected if the transducer is not positioned correctly (such as mounted at an angle, not straight down), or there is some kind of mechanical interference, either because it is mounted inside a hull that is too thick for proper sonar transmission, the bond between the transducer and the hull is not airtight, or because the transducer is dirty. See the transducer installation guide to adjust the transducer position, and make sure the transducer is clean.  Low battery voltage may be affecting the power of signal transmission.  Electrical noise from the boat's engine may be interfering with sonar reception. See <b><i>Finding the Cause of Noise</i></b> for more information.

## Finding the Cause of Noise

Electrical noise usually affects the display with many black dots at high speeds, and high sensitivity readings. See the table below for possible sources that can cause noise or interference.

Possible Source of Noise	Isolation
Other electronic devices	Turn off any nearby electronic devices to see if the problem goes away, then turn them on one at a time to see if the noise re-appears.
The boat's engine	To determine whether the boat's engine is the source of the noise, increase the RPMs while the boat is in neutral and stationary to see if the noise increases proportionately. If the noise appears when you rev the engine, the problem could be the spark plugs, alternator, or tachometer wiring. Replace the spark plugs with resistor plugs, install an alternator filter, or route the control head power and transducer cables away from the engine wiring.
Cavitation from the boat's propeller	Turbulence created by the propeller can cause noise. Confirm the transducer has been properly installed according to its specific mounting requirements (see the transducer installation guide for details). Also, make sure that the water flows smoothly over the face of the transducer at all times.

# SPECIFICATIONS

## HELIX 5 SONAR G2

### Control Head

Display Size (diagonal) .....	5 inches (127 mm)
Pixel Matrix .....	WVGA 480V x 800H
Display Type .....	TFT Color
Backlight .....	LED
Communication .....	NMEA 0183
Power Input .....	10 to 20 VDC
Current Draw .....	650 mA
IPX Rating .....	IPX7 Waterproof/Submersible @ 1 m for 30 minutes

### DualBeam PLUS Transducer

#### XNT 9 20 T [includes built-in temperature probe]

Operating Frequency .....	200 kHz, 83 kHz
Depth Capability .....	1500 ft (457 m)
Area of Coverage .....	60°@-10 dB in 83 kHz, 20°@-10 dB in 200 kHz
Power Output [MAX] .....	500 Watts [RMS], 4000 Watts [Peak to Peak]



**NOTE:** Humminbird verifies maximum stated depth in saltwater conditions, but actual depth performance may vary due to transducer installation, water type, thermal layers, bottom composition, and slope.



**NOTE:** Product specifications and features are subject to change without notice.

## Control Head

Display Size (diagonal) .....	5 inches (127 mm)
Pixel Matrix .....	WVGA 480V x 800H
Display Type .....	TFT Color
Backlight .....	LED
Communication .....	NMEA 0183
Power Input .....	10 to 20 VDC
Current Draw .....	600 mA
IPX Rating .....	IPX7 Waterproof/Submersible @ 1 m for 30 minutes

## Dual Spectrum ICE Transducer

### XI 9 1521

Operating Frequency .....	250 kHz, 130 kHz
Depth Capability .....	400 ft (122 m)
Area of Coverage .....	15°-21°@-3 dB in 130-250 kHz
Power Output [MAX] .....	500 Watts [RMS], 4000 Watts [Peak to Peak]



**NOTE:** Humminbird verifies maximum stated depth in saltwater conditions, but actual depth performance may vary due to transducer installation, water type, thermal layers, bottom composition, and slope.



**NOTE:** Product specifications and features are subject to change without notice.

## Control Head

Display Size (diagonal) .....	5 inches (127 mm)
Pixel Matrix .....	WVGA 480V x 800H
Display Type .....	TFT Color
Backlight .....	LED
Communication .....	NMEA 0183
Power Input .....	10 to 20 VDC
Current Draw .....	600 mA
IPX Rating .....	IPX7 Waterproof/Submersible @ 1 m for 30 minutes

## CHIRP DualBeam PLUS Transducer

### XNT 9 20 T [includes built-in temperature probe]

Operating Frequency .....	200 kHz, 83 kHz
Depth Capability .....	1500 ft (457 m)
Area of Coverage .....	60°@-10 dB in 83 kHz, 20°@-10 dB in 200 kHz
Power Output [MAX] .....	500 Watts [RMS], 4000 Watts [Peak to Peak]



**NOTE:** Humminbird verifies maximum stated depth in saltwater conditions, but actual depth performance may vary due to transducer installation, water type, thermal layers, bottom composition, and slope.



**NOTE:** Product specifications and features are subject to change without notice.

## Control Head

Display Size (diagonal) .....	5 inches [127 mm]
Pixel Matrix .....	WVGA 480V x 800H
Display Type .....	TFT Color
Backlight .....	LED
Communication .....	NMEA 0183
Power Input .....	10 to 20 VDC
Current Draw .....	600 mA
IPX Rating .....	IPX7 Waterproof/Submersible @ 1 m for 30 minutes

## Dual Spectrum ICE Transducer

### XI 9 1521

Operating Frequency .....	250 kHz, 130 kHz
Depth Capability .....	400 ft [122 m]
Area of Coverage .....	15°-21°@-3 dB in 130-250 kHz
Power Output [MAX] .....	500 Watts [RMS], 4000 Watts [Peak to Peak]

## CHIRP DualBeam PLUS Transducer

### XNT 9 20 T [included with All-Season model only; includes built-in temperature probe]

Operating Frequency .....	200 kHz, 83 kHz
Depth Capability .....	1500 ft [457 m]
Area of Coverage .....	60°@-10 dB in 83 kHz, 20°@-10 dB in 200 kHz
Power Output [MAX] .....	500 Watts [RMS], 4000 Watts [Peak to Peak]



**NOTE:** Humminbird verifies maximum stated depth in saltwater conditions, but actual depth performance may vary due to transducer installation, water type, thermal layers, bottom composition, and slope.



**NOTE:** Product specifications and features are subject to change without notice.

**Control Head**

Display Size (diagonal) .....	5 inches [127 mm]
Pixel Matrix .....	WVGA 480V x 800H
Display Type .....	TFT Color
Backlight .....	LED
Communication .....	NMEA 0183
Power Input .....	10 to 20 VDC
Current Draw .....	650 mA
IPX Rating .....	IPX7 Waterproof/Submersible @ 1 m for 30 minutes

**Down Imaging Transducer**

**XNT 9 DI T** [includes built-in temperature probe]

**Down Imaging**

Operating Frequency .....	455 kHz, 800 kHz
Depth Capability .....	350 ft [107 m]
Area of Coverage .....	75° @ -10 dB in 455 kHz, 45° @ -10 dB in 800 kHz
Power Output [MAX] .....	500 Watts [RMS], 4000 Watts [Peak to Peak]

**DualBeam PLUS**

Operating Frequency .....	200 kHz, 455 kHz
Depth Capability .....	600 ft [183 m]
Area of Coverage .....	28° @ -10 dB in 200 kHz, 16° @ -10 dB in 455 kHz
Power Output [MAX] .....	500 Watts [RMS], 4000 Watts [Peak to Peak]



**NOTE:** Humminbird verifies maximum stated depth in saltwater conditions, but actual depth performance may vary due to transducer installation, water type, thermal layers, bottom composition, and slope.



**NOTE:** Product specifications and features are subject to change without notice.

## Control Head

Display Size (diagonal) .....	5 inches [127 mm]
Pixel Matrix .....	WVGA 480V x 800H
Display Type .....	TFT Color
Backlight .....	LED
Communication .....	NMEA 0183
Power Input .....	10 to 20 VDC
Current Draw .....	600 mA
IPX Rating .....	IPX7 Waterproof/Submersible @ 1 m for 30 minutes

## CHIRP Down Imaging Transducer

XNT 9 DI T [includes built-in temperature probe]

### Down Imaging

Operating Frequency .....	455 kHz, 800 kHz
Depth Capability .....	350 ft [107 m]
Area of Coverage .....	75° @ -10 dB in 455 kHz, 45° @ -10 dB in 800 kHz
Power Output [MAX] .....	500 Watts [RMS], 4000 Watts [Peak to Peak]

### DualBeam PLUS

Operating Frequency .....	200 kHz, 455 kHz
Depth Capability .....	600 ft [183 m]
Area of Coverage .....	28° @ -10 dB in 200 kHz, 16° @ -10 dB in 455 kHz
Power Output [MAX] .....	500 Watts [RMS], 4000 Watts [Peak to Peak]



**NOTE:** Humminbird verifies maximum stated depth in saltwater conditions, but actual depth performance may vary due to transducer installation, water type, thermal layers, bottom composition, and slope.



**NOTE:** Product specifications and features are subject to change without notice.



**Control Head**

Display Size (diagonal) .....	5 inches [127 mm]
Pixel Matrix .....	WVGA 480V x 800H
Display Type .....	TFT Color
Backlight .....	LED
Communication .....	NMEA 0183
Power Input .....	10 to 20 VDC
Current Draw .....	600 mA
IPX Rating .....	IPX7 Waterproof/Submersible @ 1 m for 30 minutes

**CHIRP Side Imaging Transducer**

XNT 9 SI 180 T [includes built-in temperature probe]

**Side Imaging**

Operating Frequency .....	455 kHz
Side Imaging Range Capability .....	200 ft [61 m] Side to Side
Area of Coverage .....	[2] 86° @ -10 dB in 455 kHz [180° Total Coverage]
Power Output [MAX] .....	500 Watts [RMS], 4000 Watts [Peak to Peak]

**DualBeam PLUS**

Operating Frequency .....	200 kHz, 83 kHz
Depth Capability .....	1500 ft [457 m]
Area of Coverage .....	60° @ -10 dB in 83 kHz, 20° @ -10 dB in 200 kHz
Power Output [MAX] .....	500 Watts [RMS], 4000 Watts [Peak to Peak]



**NOTE:** Humminbird verifies maximum stated depth in saltwater conditions, but actual depth performance may vary due to transducer installation, water type, thermal layers, bottom composition, and slope.



**NOTE:** Product specifications and features are subject to change without notice.

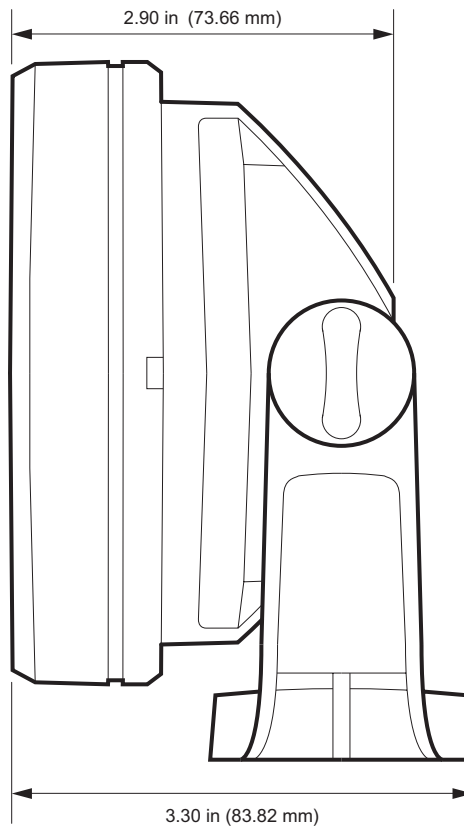
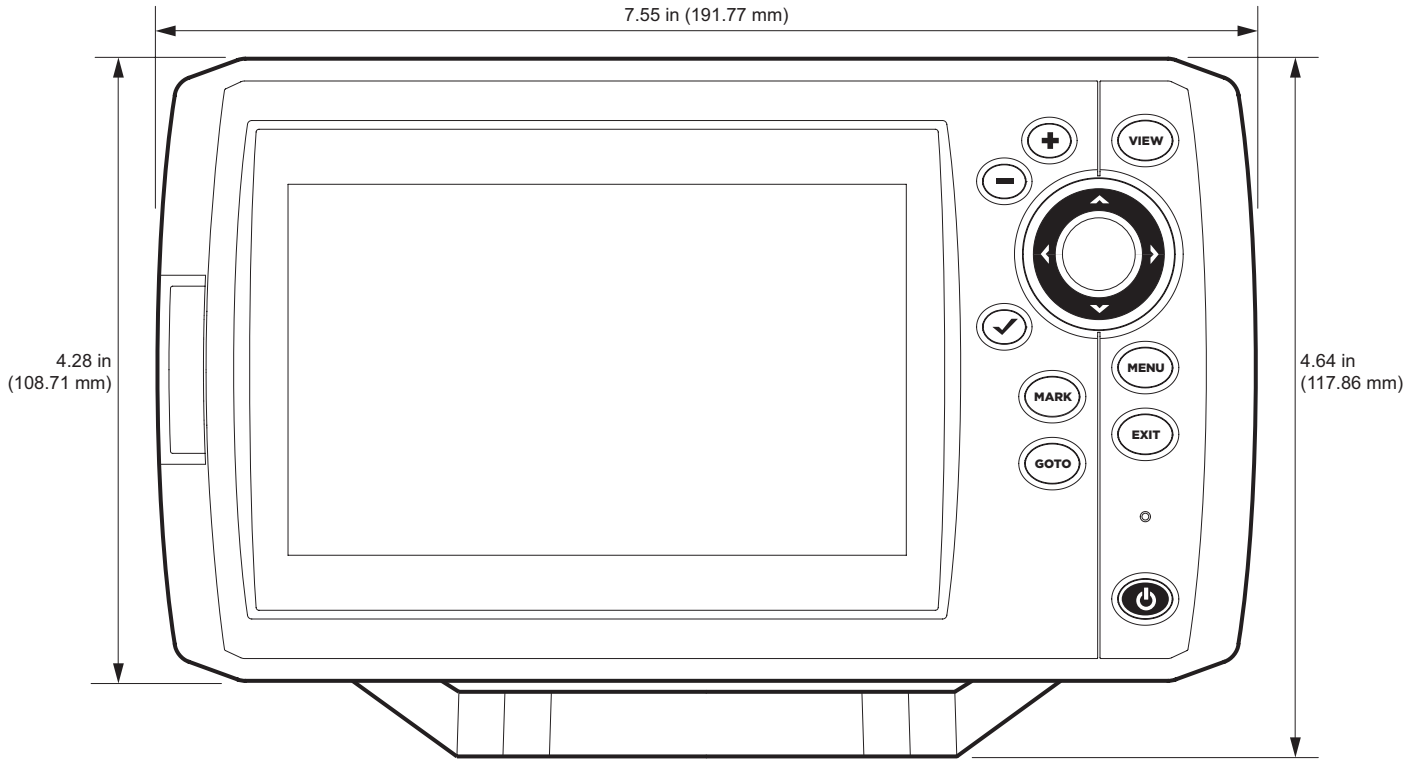
**Control Head**

Display Size (diagonal) .....	5 inches (127 mm)
Pixel Matrix .....	WVGA 480V x 800H
Display Type .....	TFT Color
Backlight .....	LED
Communication .....	NMEA 0183
Power Input .....	10 to 20 VDC
Current Draw .....	600 mA
IPX Rating .....	IPX7 Waterproof/Submersible @ 1 m for 30 minutes

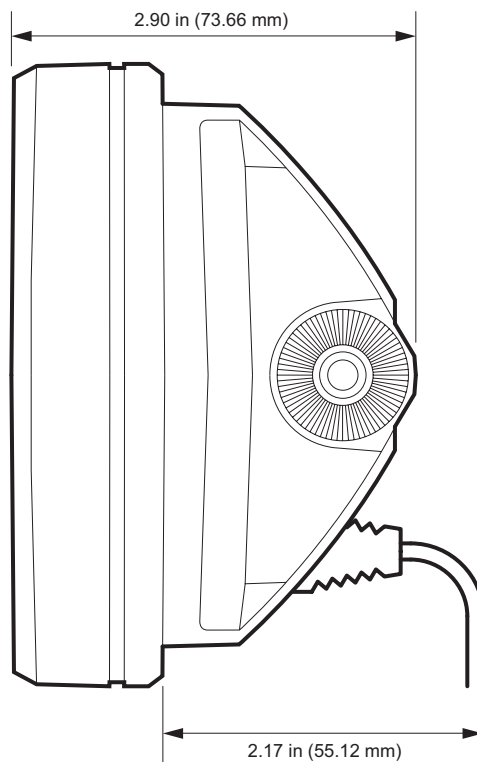
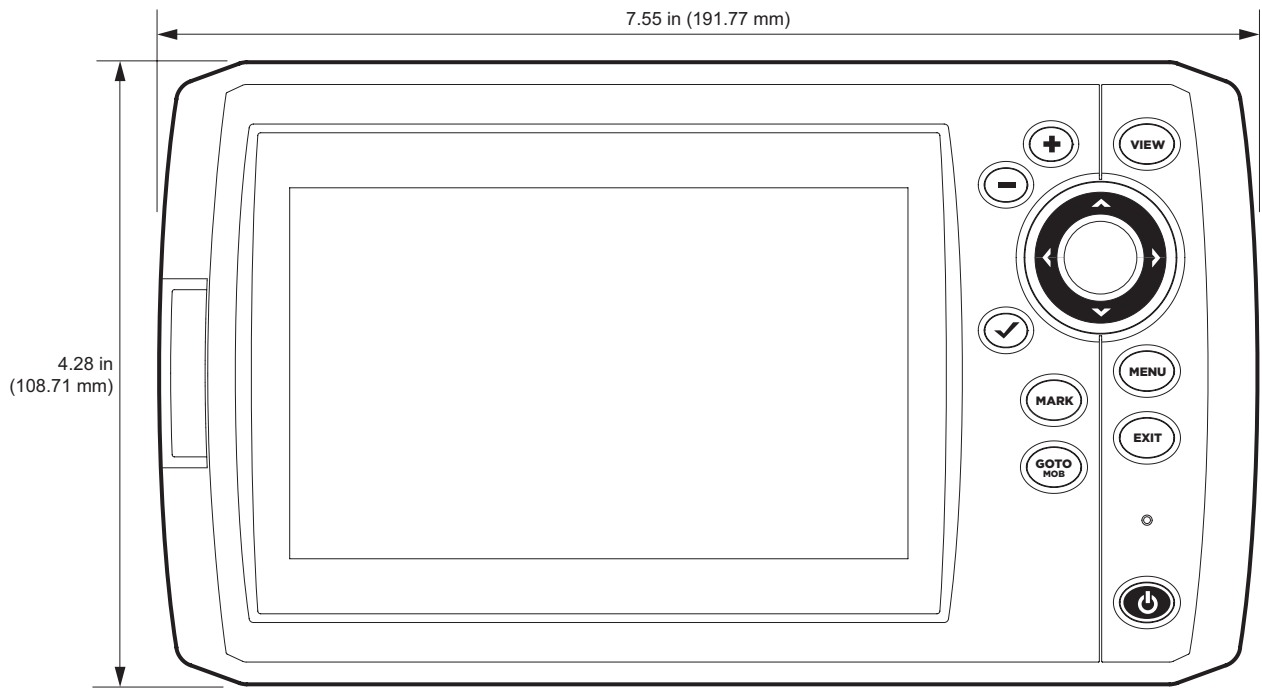


**NOTE:** Product specifications and features are subject to change without notice.

**HELIX 5 Gimbal Mount**



### HELIX 5 In-Dash Mount



## Control Head

Display Size (diagonal) .....	7 inches (178 mm)
Pixel Matrix .....	WVGA 480V x 800H
Display Type .....	TFT Color
Backlight .....	LED
Communication .....	NMEA 0183
Power Input .....	10 to 20 VDC
Current Draw .....	800 mA
IPX Rating .....	IPX7 Waterproof/Submersible @ 1 m for 30 minutes

## DualBeam PLUS Transducer

### XNT 9 20 T [includes built-in temperature probe]

Operating Frequency .....	200 kHz, 83 kHz
Depth Capability .....	1500 ft (457 m)
Area of Coverage .....	60°@-10 dB in 83 kHz, 20°@-10 dB in 200 kHz
Power Output [MAX] .....	500 Watts [RMS], 4000 Watts [Peak to Peak]



**NOTE:** Humminbird verifies maximum stated depth in saltwater conditions, but actual depth performance may vary due to transducer installation, water type, thermal layers, bottom composition, and slope.



**NOTE:** Product specifications and features are subject to change without notice.

## Control Head

Display Size (diagonal) .....	7 inches (178 mm)
Pixel Matrix .....	WVGA 480V x 800H
Display Type .....	TFT Color
Backlight .....	LED
Communication .....	NMEA 0183
Power Input .....	10 to 20 VDC
Current Draw .....	850 mA
IPX Rating .....	IPX7 Waterproof/Submersible @ 1 m for 30 minutes

## CHIRP DualBeam PLUS Transducer

### XNT 9 20 T [includes built-in temperature probe]

Operating Frequency .....	200 kHz, 83 kHz
Depth Capability .....	1500 ft (457 m)
Area of Coverage .....	60°@-10 dB in 83 kHz, 20°@-10 dB in 200 kHz
Power Output [MAX] .....	500 Watts [RMS], 4000 Watts [Peak to Peak]



**NOTE:** Humminbird verifies maximum stated depth in saltwater conditions, but actual depth performance may vary due to transducer installation, water type, thermal layers, bottom composition, and slope.



**NOTE:** Product specifications and features are subject to change without notice.

## Control Head

Display Size (diagonal) .....	7 inches (178 mm)
Pixel Matrix .....	WVGA 480V x 800H
Display Type .....	TFT Color
Backlight .....	LED
Communication .....	NMEA 0183, Ethernet
Power Input .....	10 to 20 VDC
Current Draw .....	900 mA
IPX Rating .....	IPX7 Waterproof/Submersible @ 1 m for 30 minutes
Bluetooth Frequency Range .....	2402 to 2480 MHz
Bluetooth Output Power .....	10 dBm Typical

## CHIRP DualBeam PLUS Transducer

XNT 9 20 T [includes built-in temperature probe]

Operating Frequency .....	200 kHz, 83 kHz
Depth Capability .....	1500 ft (457 m)
Area of Coverage .....	60°@-10 dB in 83 kHz, 20°@-10 dB in 200 kHz
Power Output [MAX] .....	500 Watts [RMS], 4000 Watts [Peak to Peak]



**NOTE:** Humminbird verifies maximum stated depth in saltwater conditions, but actual depth performance may vary due to transducer installation, water type, thermal layers, bottom composition, and slope.



**NOTE:** Product specifications and features are subject to change without notice.

**Control Head**

Display Size (diagonal) .....	7 inches [178 mm]
Pixel Matrix .....	WVGA 480V x 800H
Display Type .....	TFT Color
Backlight .....	LED
Communication .....	NMEA 0183
Power Input .....	10 to 20 VDC
Current Draw .....	850 mA
IPX Rating .....	IPX7 Waterproof/Submersible @ 1 m for 30 minutes

**CHIRP Down Imaging Transducer**

**XNT 9 DI T** [includes built-in temperature probe]

**Down Imaging**

Operating Frequency .....	455 kHz, 800 kHz
Depth Capability .....	350 ft [107 m]
Area of Coverage .....	75° @ -10 dB in 455 kHz, 45° @ -10 dB in 800 kHz
Power Output [MAX] .....	500 Watts [RMS], 4000 Watts [Peak to Peak]

**DualBeam PLUS**

Operating Frequency .....	200 kHz, 455 kHz
Depth Capability .....	600 ft [183 m]
Area of Coverage .....	28° @ -10 dB in 200 kHz, 16° @ -10 dB in 455 kHz
Power Output [MAX] .....	500 Watts [RMS], 4000 Watts [Peak to Peak]



**NOTE:** Humminbird verifies maximum stated depth in saltwater conditions, but actual depth performance may vary due to transducer installation, water type, thermal layers, bottom composition, and slope.



**NOTE:** Product specifications and features are subject to change without notice.



## Control Head

Display Size (diagonal) .....	7 inches [178 mm]
Pixel Matrix .....	WVGA 480V x 800H
Display Type .....	TFT Color
Backlight .....	LED
Communication .....	NMEA 0183, Ethernet
Power Input .....	10 to 20 VDC
Current Draw .....	900 mA
IPX Rating .....	IPX7 Waterproof/Submersible @ 1 m for 30 minutes
Bluetooth Frequency Range .....	2402 to 2480 MHz
Bluetooth Output Power .....	10 dBm Typical

## CHIRP Down Imaging Transducer

XNT 9 DI T [includes built-in temperature probe]

### Down Imaging

Operating Frequency .....	455 kHz, 800 kHz
Depth Capability .....	350 ft [107 m]
Area of Coverage .....	75° @ -10 dB in 455 kHz, 45° @ -10 dB in 800 kHz
Power Output [MAX] .....	500 Watts [RMS], 4000 Watts [Peak to Peak]

### DualBeam PLUS

Operating Frequency .....	200 kHz, 455 kHz
Depth Capability .....	600 ft [183 m]
Area of Coverage .....	28° @ -10 dB in 200 kHz, 16° @ -10 dB in 455 kHz
Power Output [MAX] .....	500 Watts [RMS], 4000 Watts [Peak to Peak]



**NOTE:** Humminbird verifies maximum stated depth in saltwater conditions, but actual depth performance may vary due to transducer installation, water type, thermal layers, bottom composition, and slope.



**NOTE:** Product specifications and features are subject to change without notice.

## Control Head

Display Size (diagonal) .....	7 inches [178 mm]
Pixel Matrix .....	WVGA 480V x 800H
Display Type .....	TFT Color
Backlight .....	LED
Communication .....	NMEA 0183
Power Input .....	10 to 20 VDC
Current Draw .....	850 mA
IPX Rating .....	IPX7 Waterproof/Submersible @ 1 m for 30 minutes

## CHIRP Side Imaging Transducer

XNT 9 SI 180 T [includes built-in temperature probe]

### Side Imaging

Operating Frequency .....	455 kHz
Side Imaging Range Capability .....	200 ft [61 m] Side to Side
Area of Coverage .....	[2] 86° @ -10 dB in 455 kHz [180° Total Coverage]
Power Output [MAX] .....	500 Watts [RMS], 4000 Watts [Peak to Peak]

### DualBeam PLUS

Operating Frequency .....	200 kHz, 83 kHz
Depth Capability .....	1500 ft [457 m]
Area of Coverage .....	60° @ -10 dB in 83 kHz, 20° @ -10 dB in 200 kHz
Power Output [MAX] .....	500 Watts [RMS], 4000 Watts [Peak to Peak]



**NOTE:** Humminbird verifies maximum stated depth in saltwater conditions, but actual depth performance may vary due to transducer installation, water type, thermal layers, bottom composition, and slope.



**NOTE:** Product specifications and features are subject to change without notice.

**Control Head**

Display Size (diagonal) .....	7 inches (178 mm)
Pixel Matrix .....	WVGA 480V x 800H
Display Type .....	TFT Color
Backlight .....	LED
Communication .....	NMEA 0183, Ethernet
Power Input .....	10 to 20 VDC
Current Draw .....	900 mA
IPX Rating .....	IPX7 Waterproof/Submersible @ 1 m for 30 minutes
Bluetooth Frequency Range .....	2402 to 2480 MHz
Bluetooth Output Power .....	10 dBm Typical

**CHIRP Side Imaging Transducer**

XNT 9 SI 180 T (includes built-in temperature probe)

**Side Imaging**

Operating Frequency .....	455 kHz
Side Imaging Range Capability .....	200 ft (61 m) Side to Side
Area of Coverage .....	{2} 86° @ -10 dB in 455 kHz (180° Total Coverage)
Power Output [MAX] .....	500 Watts [RMS], 4000 Watts [Peak to Peak]

**DualBeam PLUS**

Operating Frequency .....	200 kHz, 83 kHz
Depth Capability .....	1500 ft (457 m)
Area of Coverage .....	60° @ -10 dB in 83 kHz, 20° @ -10 dB in 200 kHz
Power Output [MAX] .....	500 Watts [RMS], 4000 Watts [Peak to Peak]



**NOTE:** Humminbird verifies maximum stated depth in saltwater conditions, but actual depth performance may vary due to transducer installation, water type, thermal layers, bottom composition, and slope.



**NOTE:** Product specifications and features are subject to change without notice.

**Control Head**

Display Size (diagonal) .....	7 inches (178 mm)
Pixel Matrix .....	WVGA 480V x 800H
Display Type .....	TFT Color
Backlight .....	LED
Communication .....	NMEA 0183
Power Input .....	10 to 20 VDC
Current Draw .....	800 mA
IPX Rating .....	IPX7 Waterproof/Submersible @ 1 m for 30 minutes



**NOTE:** Product specifications and features are subject to change without notice.

## Control Head

Display Size (diagonal) .....	7 inches (178 mm)
Pixel Matrix .....	WVGA 480V x 800H
Display Type .....	TFT Color
Backlight .....	LED
Communication .....	NMEA 0183
Power Input .....	10 to 20 VDC
Current Draw .....	850 mA
IPX Rating .....	IPX7 Waterproof/Submersible @ 1 m for 30 minutes

## Dual Spectrum 2D CHIRP Transducer

### XNT 9 HW T [includes built-in temperature probe]

Default Operating Frequency .....	150 kHz - 220 kHz
Depth Capability .....	1000 ft (305 m)
Area of Coverage .....	<b>Full:</b> 42°@-10 dB in 150-220 kHz <b>Wide:</b> 42°@-10 dB in 140-200 kHz <b>Narrow:</b> 25°@-10 dB in 180-240 kHz
Power Output [MAX] .....	500 Watts [RMS], 4000 Watts [Peak to Peak]



**NOTE:** Humminbird verifies maximum stated depth in saltwater conditions, but actual depth performance may vary due to transducer installation, water type, thermal layers, bottom composition, and slope.



**NOTE:** Product specifications and features are subject to change without notice.

## Control Head

Display Size (diagonal) .....	7 inches (178 mm)
Pixel Matrix .....	WVGA 480V x 800H
Display Type .....	TFT Color
Backlight .....	LED
Communication .....	NMEA 0183
Power Input .....	10 to 20 VDC
Current Draw .....	850 mA
IPX Rating .....	IPX7 Waterproof/Submersible @ 1 m for 30 minutes

## Dual Spectrum ICE Transducer

### XI 9 1521

Operating Frequency .....	250 kHz, 130 kHz
Depth Capability .....	400 ft (122 m)
Area of Coverage .....	15°-21°@-3 dB in 130-250 kHz
Power Output [MAX] .....	500 Watts [RMS], 4000 Watts [Peak to Peak]



**NOTE:** Humminbird verifies maximum stated depth in saltwater conditions, but actual depth performance may vary due to transducer installation, water type, thermal layers, bottom composition, and slope.



**NOTE:** Product specifications and features are subject to change without notice.

## Control Head

Display Size (diagonal) .....	7 inches [178 mm]
Pixel Matrix .....	WVGA 480V x 800H
Display Type .....	TFT Color
Backlight .....	LED
Communication .....	NMEA 0183
Power Input .....	10 to 20 VDC
Current Draw .....	850 mA
IPX Rating .....	IPX7 Waterproof/Submersible @ 1 m for 30 minutes

## CHIRP MEGA Down Imaging Transducer


XNT 9 HW MDI 75 T [includes built-in temperature probe]

### Down Imaging

Operating Frequency .....	455 kHz, MEGA
Depth Capability .....	<b>455 kHz:</b> 350 ft [107 m] <b>MEGA:</b> 125 ft [38 m]
Area of Coverage .....	<b>455 kHz:</b> 75° @ -10 dB in 455 kHz <b>MEGA:</b> 75° @ -10 dB in MEGA kHz
Power Output [MAX] .....	500 Watts [RMS], 4000 Watts [Peak to Peak]

### Dual Spectrum

Default Operating Frequency .....	150 kHz - 220 kHz
Depth Capability .....	1000 ft [305 m]
Area of Coverage .....	<b>Full:</b> 42° @ -10 dB in 150-220 kHz <b>Wide:</b> 42° @ -10 dB in 140-200 kHz <b>Narrow:</b> 25° @ -10 dB in 180-240 kHz
Power Output [MAX] .....	500 Watts [RMS], 4000 Watts [Peak to Peak]

 **NOTE:** Humminbird verifies maximum stated depth in saltwater conditions, but actual depth performance may vary due to transducer installation, water type, thermal layers, bottom composition, and slope.

 **NOTE:** Product specifications and features are subject to change without notice.

## Control Head

Display Size (diagonal)	7 inches [178 mm]
Pixel Matrix	WVGA 480V x 800H
Display Type	TFT Color
Backlight	LED
Communication	NMEA 0183
Power Input	10 to 20 VDC
Current Draw	850 mA
IPX Rating	IPX7 Waterproof/Submersible @ 1 m for 30 minutes

## CHIRP MEGA Side Imaging Transducer

XNT 9 HW MSI 150 T [includes built-in temperature probe]

### Side Imaging

Operating Frequency	455 kHz, MEGA
Depth Capability	<b>455 kHz:</b> 480 ft [146 m] <b>MEGA:</b> 250 ft [76 m]
Area of Coverage	<b>455 kHz:</b> 75° @ -10 dB in 455 kHz <b>MEGA:</b> 75° @ -10 dB in MEGA kHz
Power Output [MAX]	500 Watts [RMS], 4000 Watts [Peak to Peak]

### Down Imaging

Operating Frequency	455 kHz, MEGA
Depth Capability	<b>455 kHz:</b> 125 ft [38 m] <b>MEGA:</b> 75 ft [23 m]
Area of Coverage	<b>455 kHz:</b> 75° @ -10 dB in 455 kHz <b>MEGA:</b> 75° @ -10 dB in MEGA kHz
Power Output [MAX]	500 Watts [RMS], 4000 Watts [Peak to Peak]

### Dual Spectrum

Default Operating Frequency	150 kHz - 220 kHz
Depth Capability	1000 ft [305 m]
Area of Coverage	<b>Full:</b> 42° @ -10 dB in 150-220 kHz <b>Wide:</b> 42° @ -10 dB in 140-200 kHz <b>Narrow:</b> 25° @ -10 dB in 180-240 kHz
Power Output [MAX]	500 Watts [RMS], 4000 Watts [Peak to Peak]



**NOTE:** Humminbird verifies maximum stated depth in saltwater conditions, but actual depth performance may vary due to transducer installation, water type, thermal layers, bottom composition, and slope.



**NOTE:** Product specifications and features are subject to change without notice.



## Control Head

Display Size (diagonal)	7 inches (178 mm)
Pixel Matrix	WVGA 480V x 800H
Display Type	TFT Color
Backlight	LED
Communication	NMEA 0183, Ethernet
Power Input	10 to 20 VDC
Current Draw	900 mA
IPX Rating	IPX7 Waterproof/Submersible @ 1 m for 30 minutes
Bluetooth Frequency Range	2402 to 2480 MHz
Bluetooth Output Power	10 dBm Typical

## Dual Spectrum 2D CHIRP Transducer

XNT 9 HW T [includes built-in temperature probe]

Default Operating Frequency	150 kHz - 220 kHz
Depth Capability	1000 ft (305 m)
Area of Coverage	<b>Full:</b> 42°@-10 dB in 150-220 kHz <b>Wide:</b> 42°@-10 dB in 140-200 kHz <b>Narrow:</b> 25°@-10 dB in 180-240 kHz
Power Output (MAX)	500 Watts (RMS), 4000 Watts (Peak to Peak)



**NOTE:** Humminbird verifies maximum stated depth in saltwater conditions, but actual depth performance may vary due to transducer installation, water type, thermal layers, bottom composition, and slope.



**NOTE:** Product specifications and features are subject to change without notice.

## Control Head

Display Size (diagonal)	7 inches (178 mm)
Pixel Matrix	WVGA 480V x 800H
Display Type	TFT Color
Backlight	LED
Communication	NMEA 0183, Ethernet
Power Input	10 to 20 VDC
Current Draw	900 mA
IPX Rating	IPX7 Waterproof/Submersible @ 1 m for 30 minutes
Bluetooth Frequency Range	2402 to 2480 MHz
Bluetooth Output Power	10 dBm Typical

## Dual Spectrum ICE Transducer

### XI 9 1521

Operating Frequency	250 kHz, 130 kHz
Depth Capability	400 ft (122 m)
Area of Coverage	15°-21°@-3 dB in 130-250 kHz
Power Output [MAX]	500 Watts [RMS], 4000 Watts [Peak to Peak]

## Dual Spectrum 2D CHIRP Transducer

### XNT 9 HW T [includes built-in temperature probe]

Default Operating Frequency	150 kHz - 220 kHz
Depth Capability	1000 ft (305 m)
Area of Coverage	<b>Full:</b> 42°@-10 dB in 150-220 kHz <b>Wide:</b> 42°@-10 dB in 140-200 kHz <b>Narrow:</b> 25°@-10 dB in 180-240 kHz
Power Output [MAX]	500 Watts [RMS], 4000 Watts [Peak to Peak]



**NOTE:** Humminbird verifies maximum stated depth in saltwater conditions, but actual depth performance may vary due to transducer installation, water type, thermal layers, bottom composition, and slope.



**NOTE:** Product specifications and features are subject to change without notice.

**Control Head**

Display Size (diagonal) .....	7 inches [178 mm]
Pixel Matrix .....	WVGA 480V x 800H
Display Type .....	TFT Color
Backlight .....	LED
Communication .....	NMEA 0183, Ethernet
Power Input .....	10 to 20 VDC
Current Draw .....	900 mA
IPX Rating .....	IPX7 Waterproof/Submersible @ 1 m for 30 minutes
Bluetooth Frequency Range .....	2402 to 2480 MHz
Bluetooth Output Power .....	10 dBm Typical

**CHIRP MEGA Down Imaging Transducer**


XNT 9 HW MDI 75 T [includes built-in temperature probe]

**Down Imaging**

Operating Frequency .....	455 kHz, MEGA
Depth Capability .....	<b>455 kHz:</b> 350 ft [107 m] <b>MEGA:</b> 125 ft [38 m]
Area of Coverage .....	<b>455 kHz:</b> 75° @ -10 dB in 455 kHz <b>MEGA:</b> 75° @ -10 dB in MEGA kHz
Power Output [MAX] .....	500 Watts [RMS], 4000 Watts [Peak to Peak]

**Dual Spectrum**

Default Operating Frequency .....	150 kHz - 220 kHz
Depth Capability .....	1000 ft [305 m]
Area of Coverage .....	<b>Full:</b> 42°@-10 dB in 150-220 kHz <b>Wide:</b> 42°@-10 dB in 140-200 kHz <b>Narrow:</b> 25°@-10 dB in 180-240 kHz
Power Output [MAX] .....	500 Watts [RMS], 4000 Watts [Peak to Peak]

 **NOTE:** Humminbird verifies maximum stated depth in saltwater conditions, but actual depth performance may vary due to transducer installation, water type, thermal layers, bottom composition, and slope.

 **NOTE:** Product specifications and features are subject to change without notice.

**Control Head**

Display Size (diagonal) .....	7 inches [178 mm]
Pixel Matrix .....	WVGA 480V x 800H
Display Type .....	TFT Color
Backlight .....	LED
Communication .....	NMEA 0183, Ethernet
Power Input .....	10 to 20 VDC
Current Draw .....	900 mA
IPX Rating .....	IPX7 Waterproof/Submersible @ 1 m for 30 minutes
Bluetooth Frequency Range .....	2402 to 2480 MHz
Bluetooth Output Power .....	10 dBm Typical

**CHIRP MEGA Side Imaging Transducer**

**XNT 9 HW MSI 150 T** [includes built-in temperature probe]

**Side Imaging**

Operating Frequency .....	455 kHz, MEGA
Depth Capability .....	<b>455 kHz:</b> 480 ft [146 m] <b>MEGA:</b> 250 ft [76 m]
Area of Coverage .....	<b>455 kHz:</b> 75° @ -10 dB in 455 kHz <b>MEGA:</b> 75° @ -10 dB in MEGA kHz
Power Output [MAX] .....	500 Watts [RMS], 4000 Watts [Peak to Peak]

**Down Imaging**

Operating Frequency .....	455 kHz, MEGA
Depth Capability .....	<b>455 kHz:</b> 125 ft [38 m] <b>MEGA:</b> 75 ft [23 m]
Area of Coverage .....	<b>455 kHz:</b> 75° @ -10 dB in 455 kHz <b>MEGA:</b> 75° @ -10 dB in MEGA kHz
Power Output [MAX] .....	500 Watts [RMS], 4000 Watts [Peak to Peak]

## Dual Spectrum

Default Operating Frequency .....	150 kHz - 220 kHz
Depth Capability .....	1000 ft (305 m)
Area of Coverage .....	<b>Full:</b> 42°@-10 dB in 150-220 kHz <b>Wide:</b> 42°@-10 dB in 140-200 kHz <b>Narrow:</b> 25°@-10 dB in 180-240 kHz
Power Output [MAX].....	500 Watts [RMS], 4000 Watts [Peak to Peak]



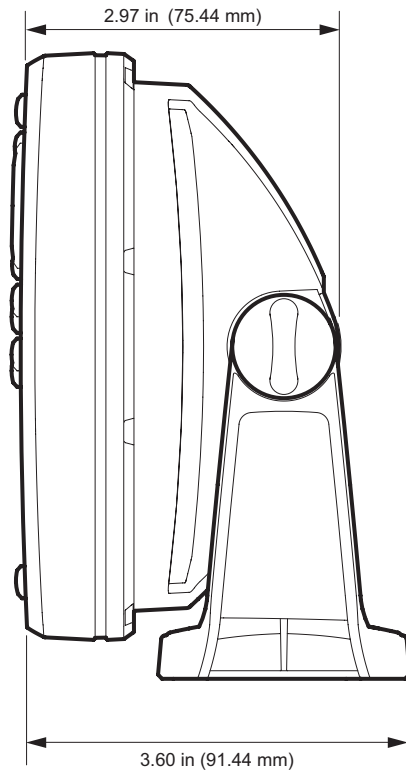
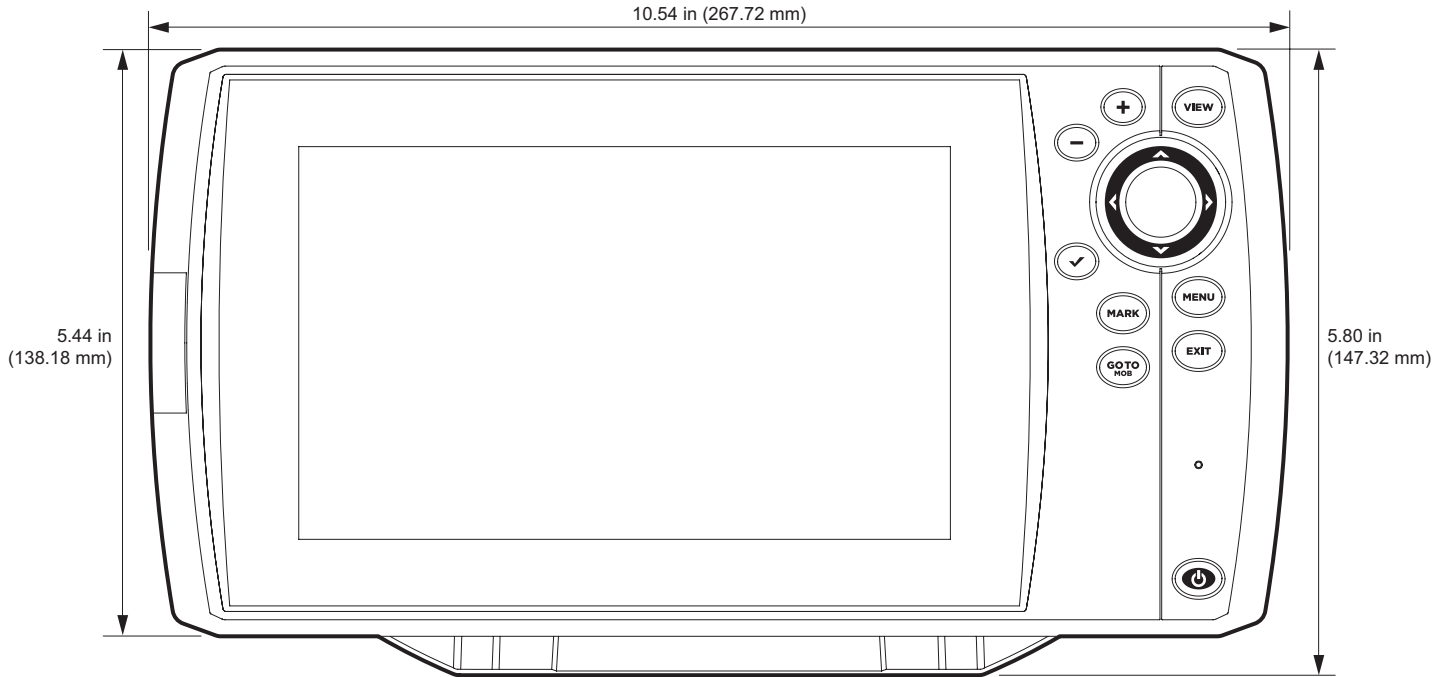
**NOTE:** Humminbird verifies maximum stated depth in saltwater conditions, but actual depth performance may vary due to transducer installation, water type, thermal layers, bottom composition, and slope.



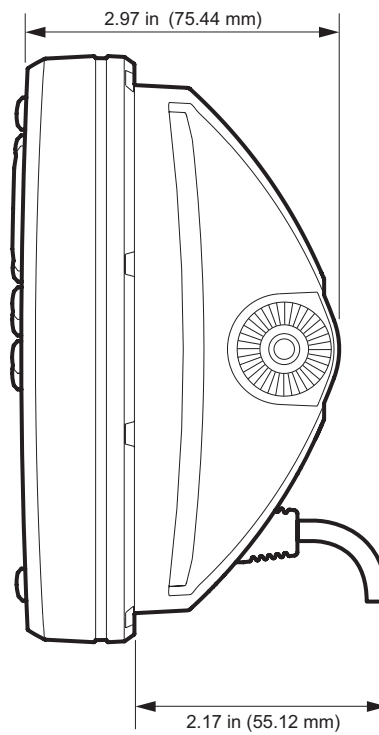
**NOTE:** Product specifications and features are subject to change without notice.

# HELIX 7 Control Head Measurements

## HELIX 7 Gimbal Mount



### HELIX 7 In-Dash Mount



## Control Head

Display Size (diagonal)	8 inches (203 mm)
Pixel Matrix	WVGA 600V x 1024H
Display Type	TFT Color
Backlight	LED
Communication	NMEA 0183, Ethernet
Power Input	10 to 20 VDC
Current Draw	1.8 A
IPX Rating	IPX7 Waterproof/Submersible @ 1 m for 30 minutes
Bluetooth Frequency Range	2402 to 2480 MHz
Bluetooth Output Power	10 dBm Typical

## Dual Spectrum 2D CHIRP Transducer

### XNT 9 HW T [includes built-in temperature probe]

Default Operating Frequency	150 kHz - 220 kHz
Depth Capability	1000 ft (305 m)
Area of Coverage	<b>Full:</b> 42°@-10 dB in 150-220 kHz <b>Wide:</b> 42°@-10 dB in 140-200 kHz <b>Narrow:</b> 25°@-10 dB in 180-240 kHz
Power Output (MAX)	500 Watts (RMS), 4000 Watts (Peak to Peak)



**NOTE:** Humminbird verifies maximum stated depth in saltwater conditions, but actual depth performance may vary due to transducer installation, water type, thermal layers, bottom composition, and slope.



**NOTE:** Product specifications and features are subject to change without notice.



## Control Head

Display Size (diagonal)	8 inches (203 mm)
Pixel Matrix	WVGA 600V x 1024H
Display Type	TFT Color
Backlight	LED
Communication	NMEA 0183, Ethernet
Power Input	10 to 20 VDC
Current Draw	1.8 A
IPX Rating	IPX7 Waterproof/Submersible @ 1 m for 30 minutes
Bluetooth Frequency Range	2402 to 2480 MHz
Bluetooth Output Power	10 dBm Typical

## CHIRP MEGA Down Imaging Transducer

XNT 9 HW MDI 75 T (includes built-in temperature probe)

### Down Imaging

Operating Frequency	455 kHz, MEGA
Depth Capability	<b>455 kHz:</b> 350 ft (107 m) <b>MEGA:</b> 125 ft (38 m)
Area of Coverage	<b>455 kHz:</b> 75° @ -10 dB in 455 kHz <b>MEGA:</b> 75° @ -10 dB in MEGA kHz
Power Output [MAX]	500 Watts [RMS], 4000 Watts [Peak to Peak]

### Dual Spectrum

Default Operating Frequency	150 kHz - 220 kHz
Depth Capability	1000 ft (305 m)
Area of Coverage	<b>Full:</b> 42°@-10 dB in 150-220 kHz <b>Wide:</b> 42°@-10 dB in 140-200 kHz <b>Narrow:</b> 25°@-10 dB in 180-240 kHz
Power Output [MAX]	500 Watts [RMS], 4000 Watts [Peak to Peak]



**NOTE:** Humminbird verifies maximum stated depth in saltwater conditions, but actual depth performance may vary due to transducer installation, water type, thermal layers, bottom composition, and slope.



**NOTE:** Product specifications and features are subject to change without notice.

**Control Head**

Display Size (diagonal)	8 inches [203 mm]
Pixel Matrix	WVGA 600V x 1024H
Display Type	TFT Color
Backlight	LED
Communication	NMEA 0183, Ethernet
Power Input	10 to 20 VDC
Current Draw	1.8 A
IPX Rating	IPX7 Waterproof/Submersible @ 1 m for 30 minutes
Bluetooth Frequency Range	2402 to 2480 MHz
Bluetooth Output Power	10 dBm Typical

**CHIRP MEGA Side Imaging+ Transducer**

**XM 9 HW MSIT** [includes built-in temperature probe]

**Side Imaging**

Operating Frequency	455 kHz, 800 kHz, MEGA
Depth Capability	<b>455 kHz:</b> 800 ft [244 m] <b>800 kHz:</b> 250 ft [76 m] <b>MEGA:</b> 400 ft [122 m]
Area of Coverage	<b>455 kHz:</b> 86° @ -10 dB in 455 kHz <b>800 kHz:</b> 86° @ -10 dB in 800 kHz <b>MEGA:</b> 86° @ -10 dB in MEGA kHz
Power Output [MAX]	500 Watts [RMS], 4000 Watts [Peak to Peak]

**Down Imaging**

Operating Frequency	455 kHz, 800 kHz, MEGA
Depth Capability	<b>455 kHz:</b> 400 ft [122 m] <b>800 kHz:</b> 125 ft [38 m] <b>MEGA:</b> 200 ft [61 m]
Area of Coverage	<b>455 kHz:</b> 75° @ -10 dB in 455 kHz <b>800 kHz:</b> 45° @ -10 dB in 800 kHz <b>MEGA:</b> 75° @ -10 dB in MEGA kHz
Power Output [MAX]	500 Watts [RMS], 4000 Watts [Peak to Peak]

## Dual Spectrum

Default Operating Frequency .....	150 kHz - 220 kHz
Depth Capability .....	1000 ft (305 m)
Area of Coverage .....	<b>Full:</b> 42°@-10 dB in 150-220 kHz <b>Wide:</b> 42°@-10 dB in 140-200 kHz <b>Narrow:</b> 25°@-10 dB in 180-240 kHz
Power Output [MAX].....	500 Watts [RMS], 4000 Watts [Peak to Peak]



**NOTE:** Humminbird verifies maximum stated depth in saltwater conditions, but actual depth performance may vary due to transducer installation, water type, thermal layers, bottom composition, and slope.



**NOTE:** Product specifications and features are subject to change without notice.

## Control Head

Display Size (diagonal)	8 inches (203 mm)
Pixel Matrix	WSVGA 600V x 1024H
Display Type	TFT Color
Backlight	LED
Communication	Bluetooth, NMEA 0183, NMEA 2000, Ethernet, Wireless
Power Input	10 to 20 VDC
Current Draw	1.8 A
IPX Rating	IPX7 Waterproof/Submersible @ 1 m for 30 minutes
Bluetooth Frequency Range	2402 to 2480 MHz
Bluetooth Output Power	10 dBm Typical

## Dual Spectrum 2D CHIRP Transducer

### XNT 9 HW T [includes built-in temperature probe]

Default Operating Frequency	150 kHz - 220 kHz
Depth Capability	1200 ft (366 m)
Area of Coverage	<b>Full:</b> 42°@-10 dB in 150-220 kHz <b>Wide:</b> 42°@-10 dB in 140-200 kHz <b>Narrow:</b> 25°@-10 dB in 180-240 kHz
Power Output (MAX)	500 Watts (RMS), 4000 Watts (Peak to Peak)



**NOTE:** Humminbird verifies maximum stated depth in saltwater conditions, but actual depth performance may vary due to transducer installation, water type, thermal layers, bottom composition, and slope.



**NOTE:** Product specifications and features are subject to change without notice.

**Control Head**

Display Size (diagonal) .....	8 inches [203 mm]
Pixel Matrix .....	WSVGA 600V x 1024H
Display Type .....	TFT Color
Backlight .....	LED
Communication .....	Bluetooth, NMEA 0183, NMEA 2000, Ethernet, Wireless
Power Input .....	10 to 20 VDC
Current Draw .....	1.8 A
IPX Rating .....	IPX7 Waterproof/Submersible @ 1 m for 30 minutes
Bluetooth Frequency Range .....	2402 to 2480 MHz
Bluetooth Output Power .....	10 dBm Typical

**CHIRP MEGA Down Imaging Transducer**

**XNT 9 HW MDI 75 T** [includes built-in temperature probe]

**Down Imaging**

Operating Frequency .....	455 kHz, MEGA
Depth Capability .....	<b>455 kHz:</b> 350 ft [107 m] <b>MEGA:</b> 125 ft [38 m]
Area of Coverage .....	<b>455 kHz:</b> 75° @ -10 dB in 455 kHz <b>MEGA:</b> 75° @ -10 dB in MEGA kHz
Power Output [MAX] .....	500 Watts [RMS], 4000 Watts [Peak to Peak]

**Dual Spectrum**

Default Operating Frequency .....	150 kHz - 220 kHz
Depth Capability .....	1200 ft [366 m]
Area of Coverage .....	<b>Full:</b> 42°@-10 dB in 150-220 kHz <b>Wide:</b> 42°@-10 dB in 140-200 kHz <b>Narrow:</b> 25°@-10 dB in 180-240 kHz
Power Output [MAX] .....	500 Watts [RMS], 4000 Watts [Peak to Peak]



**NOTE:** Humminbird verifies maximum stated depth in saltwater conditions, but actual depth performance may vary due to transducer installation, water type, thermal layers, bottom composition, and slope.



**NOTE:** Product specifications and features are subject to change without notice.

## Control Head

Display Size (diagonal)	8 inches [203 mm]
Pixel Matrix	WSVGA 600V x 1024H
Display Type	TFT Color
Backlight	LED
Communication	Bluetooth, NMEA 0183, NMEA 2000, Ethernet, Wireless
Power Input	10 to 20 VDC
Current Draw	1.8 A
IPX Rating	IPX7 Waterproof/Submersible @ 1 m for 30 minutes
Bluetooth Frequency Range	2402 to 2480 MHz
Bluetooth Output Power	10 dBm Typical

## CHIRP MEGA Side Imaging+ Transducer

**XM 9 HW MSIT** [includes built-in temperature probe]

### Side Imaging

Operating Frequency	455 kHz, 800 kHz, MEGA
Depth Capability	<b>455 kHz:</b> 800 ft [244 m] <b>800 kHz:</b> 250 ft [76 m] <b>MEGA:</b> 400 ft [122 m]
Area of Coverage	<b>455 kHz:</b> 86° @ -10 dB in 455 kHz <b>800 kHz:</b> 86° @ -10 dB in 800 kHz <b>MEGA:</b> 86° @ -10 dB in MEGA kHz
Power Output [MAX]	500 Watts [RMS], 4000 Watts [Peak to Peak]

### Down Imaging

Operating Frequency	455 kHz, 800 kHz, MEGA
Depth Capability	<b>455 kHz:</b> 400 ft [122 m] <b>800 kHz:</b> 125 ft [38 m] <b>MEGA:</b> 200 ft [61 m]
Area of Coverage	<b>455 kHz:</b> 75° @ -10 dB in 455 kHz <b>800 kHz:</b> 45° @ -10 dB in 800 kHz <b>MEGA:</b> 75° @ -10 dB in MEGA kHz
Power Output [MAX]	500 Watts [RMS], 4000 Watts [Peak to Peak]

## Dual Spectrum

Default Operating Frequency .....	150 kHz - 220 kHz
Depth Capability .....	1200 ft (366 m)
Area of Coverage .....	<b>Full:</b> 42°@-10 dB in 150-220 kHz <b>Wide:</b> 42°@-10 dB in 140-200 kHz <b>Narrow:</b> 25°@-10 dB in 180-240 kHz
Power Output [MAX].....	500 Watts [RMS], 4000 Watts [Peak to Peak]



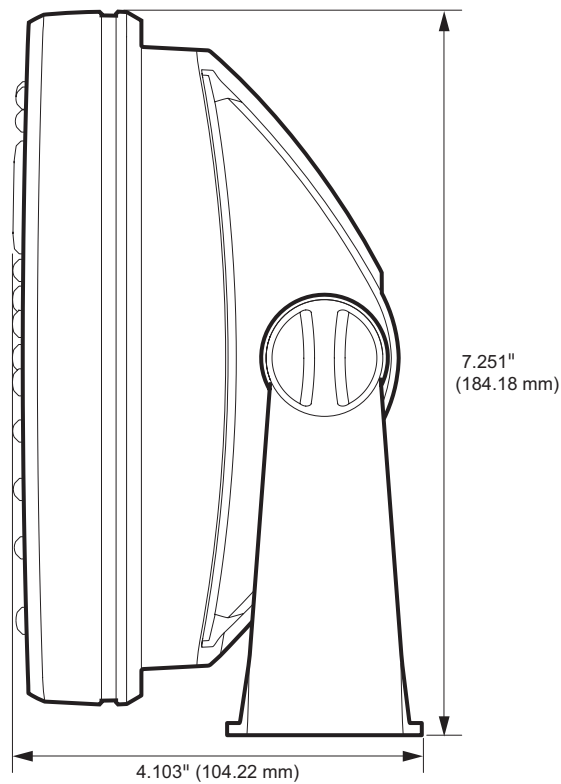
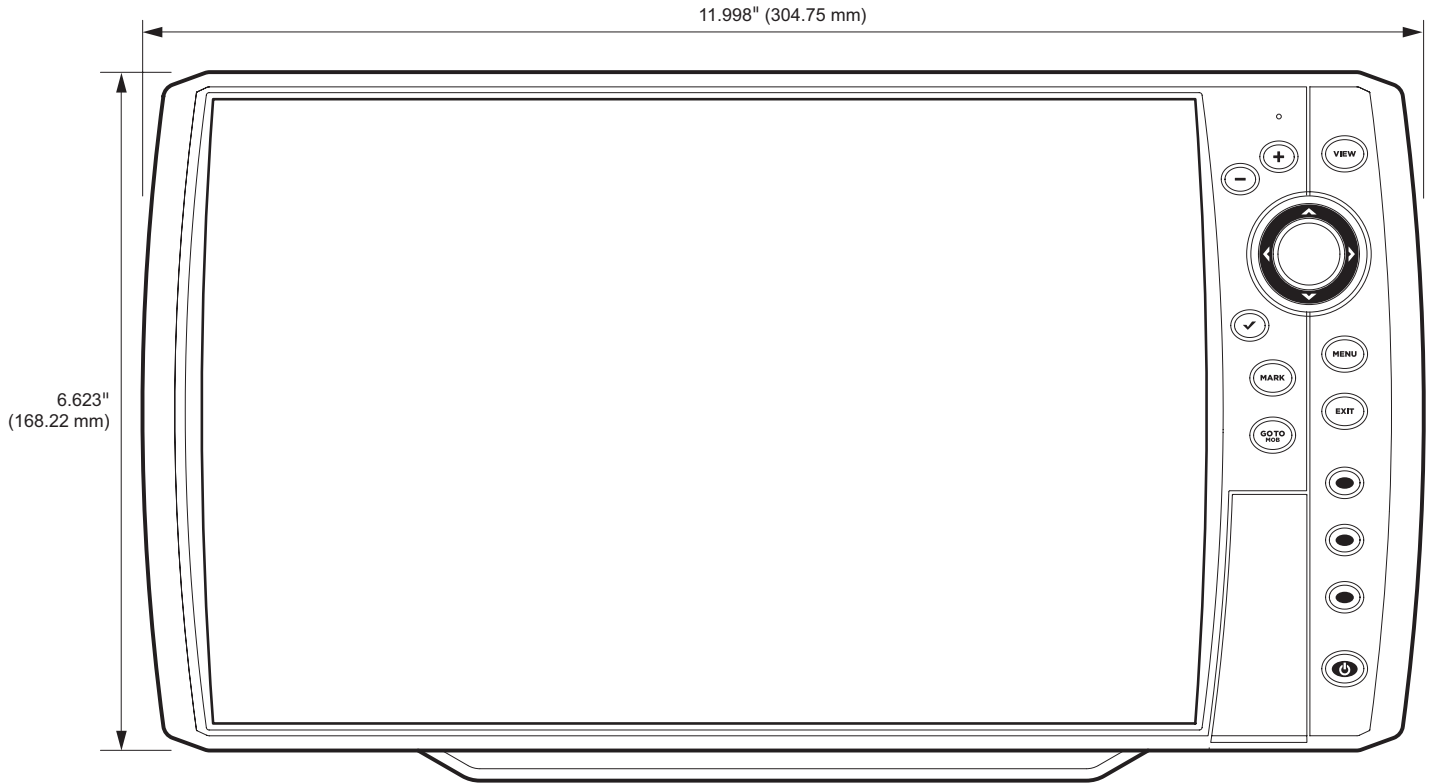
**NOTE:** Humminbird verifies maximum stated depth in saltwater conditions, but actual depth performance may vary due to transducer installation, water type, thermal layers, bottom composition, and slope.



**NOTE:** Product specifications and features are subject to change without notice.

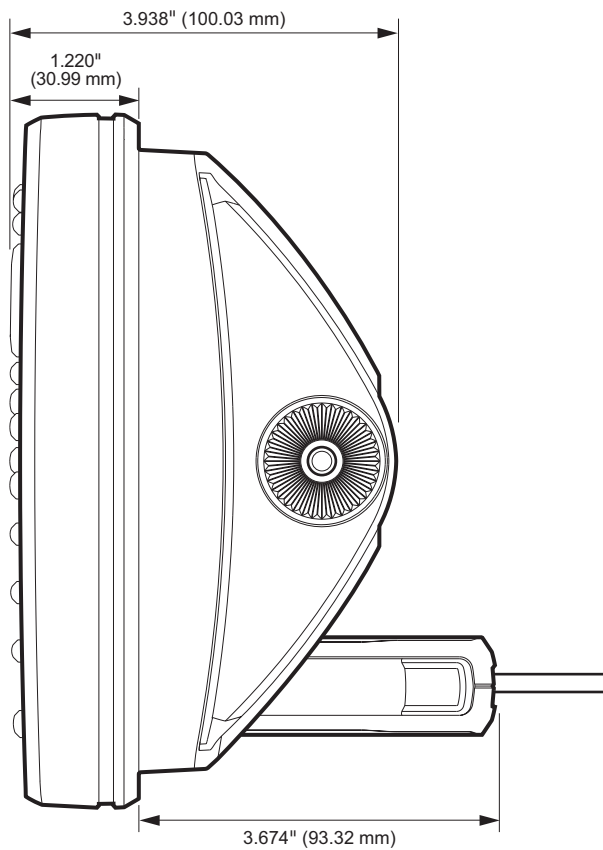
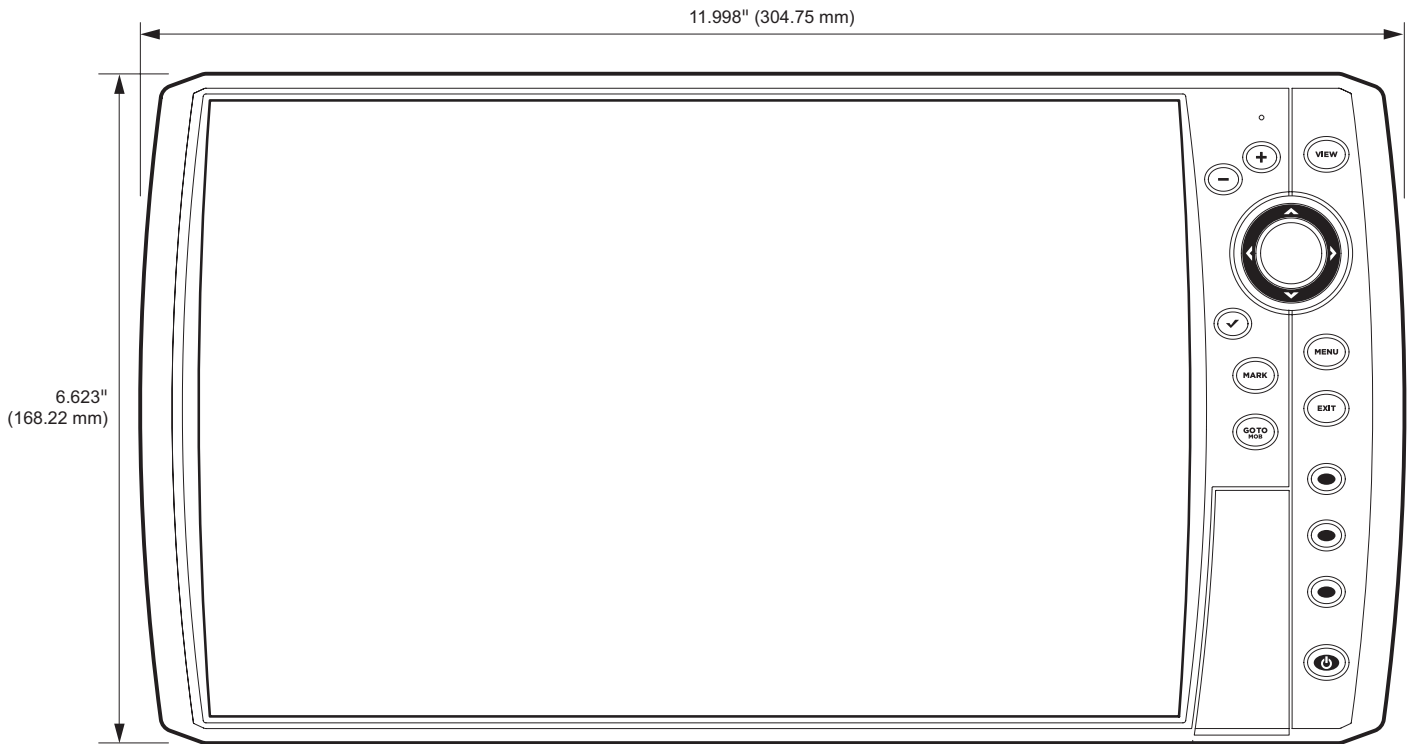
# HELIX 8 Control Head Measurements

## HELIX 8 Gimbal Mount





### HELIX 8 In-Dash Mount



## Control Head

Display Size (diagonal)	9 inches [228.6 mm]
Pixel Matrix	WVGA 480V x 800H
Display Type	TFT Color
Backlight	LED
Communication	NMEA 0183, Ethernet
Power Input	10 to 20 VDC
Current Draw	1.3 A
IPX Rating	IPX7 Waterproof/Submersible @ 1 m for 30 minutes
Bluetooth Frequency Range	2402 to 2480 MHz
Bluetooth Output Power	10 dBm Typical

## CHIRP DualBeam PLUS Transducer

### XNT 9 20 T [includes built-in temperature probe]

Operating Frequency	200 kHz, 83 kHz
Depth Capability	1500 ft [457 m]
Area of Coverage	60°@-10 dB in 83 kHz, 20°@-10 dB in 200 kHz
Power Output [MAX]	500 Watts [RMS], 4000 Watts [Peak to Peak]



**NOTE:** Humminbird verifies maximum stated depth in saltwater conditions, but actual depth performance may vary due to transducer installation, water type, thermal layers, bottom composition, and slope.



**NOTE:** Product specifications and features are subject to change without notice.

## Control Head

Display Size (diagonal) .....	9 inches [228.6 mm]
Pixel Matrix .....	WVGA 480V x 800H
Display Type .....	TFT Color
Backlight .....	LED
Communication .....	NMEA 0183, Ethernet
Power Input .....	10 to 20 VDC
Current Draw .....	2.5 A
IPX Rating .....	IPX7 Waterproof/Submersible @ 1 m for 30 minutes
Bluetooth Frequency Range .....	2402 to 2480 MHz
Bluetooth Output Power .....	10 dBm Typical

## CHIRP Down Imaging Transducer

XNT 9 DI T [includes built-in temperature probe]

### Down Imaging

Operating Frequency .....	455 kHz, 800 kHz
Depth Capability .....	350 ft [107 m]
Area of Coverage .....	75° @ -10 dB in 455 kHz, 45° @ -10 dB in 800 kHz
Power Output [MAX] .....	500 Watts [RMS], 4000 Watts [Peak to Peak]

### DualBeam PLUS

Operating Frequency .....	200 kHz, 455 kHz
Depth Capability .....	600 ft [183 m]
Area of Coverage .....	28° @ -10 dB in 200 kHz, 16° @ -10 dB in 455 kHz
Power Output [MAX] .....	500 Watts [RMS], 4000 Watts [Peak to Peak]



**NOTE:** Humminbird verifies maximum stated depth in saltwater conditions, but actual depth performance may vary due to transducer installation, water type, thermal layers, bottom composition, and slope.



**NOTE:** Product specifications and features are subject to change without notice.

## Control Head

Display Size (diagonal) .....	9 inches [228.6 mm]
Pixel Matrix .....	WVGA 480V x 800H
Display Type .....	TFT Color
Backlight .....	LED
Communication .....	NMEA 0183, Ethernet
Power Input .....	10 to 20 VDC
Current Draw .....	1.3 A
IPX Rating .....	IPX7 Waterproof/Submersible @ 1 m for 30 minutes
Bluetooth Frequency Range .....	2402 to 2480 MHz
Bluetooth Output Power .....	10 dBm Typical

## CHIRP MEGA Down Imaging Transducer

**XM 9 MDI T** [includes built-in temperature probe]

### Down Imaging

Operating Frequency .....	455 kHz, 800 kHz, MEGA
Depth Capability .....	<b>455 kHz:</b> 400 ft [122 m] <b>800 kHz:</b> 125 ft [38 m] <b>MEGA:</b> 125 ft [38 m]
Area of Coverage .....	75° @ -10 dB in 455 kHz 45° @ -10 dB in 800 kHz <b>MEGA:</b> 75° @ -10 dB in MEGA kHz
Power Output [MAX] .....	500 Watts [RMS], 4000 Watts [Peak to Peak]

### Dual Spectrum

Default Operating Frequency .....	150 kHz - 220 kHz
Depth Capability .....	1000 ft [305 m]
Area of Coverage .....	<b>Full:</b> 42°@-10 dB in 150-220 kHz <b>Wide:</b> 42°@-10 dB in 140-200 kHz <b>Narrow:</b> 25°@-10 dB in 180-240 kHz
Power Output [MAX] .....	500 Watts [RMS], 4000 Watts [Peak to Peak]



**NOTE:** Humminbird verifies maximum stated depth in saltwater conditions, but actual depth performance may vary due to transducer installation, water type, thermal layers, bottom composition, and slope.



**NOTE:** Product specifications and features are subject to change without notice.

## Control Head

Display Size (diagonal)	9 inches [228.6 mm]
Pixel Matrix	WVGA 480V x 800H
Display Type	TFT Color
Backlight	LED
Communication	NMEA 0183, Ethernet
Power Input	10 to 20 VDC
Current Draw	2.5 A
IPX Rating	IPX7 Waterproof/Submersible @ 1 m for 30 minutes
Bluetooth Frequency Range	2402 to 2480 MHz
Bluetooth Output Power	10 dBm Typical

## CHIRP MEGA Side Imaging Transducer

**XM 9 20 MSI T** [includes built-in temperature probe]

### Side Imaging

Operating Frequency	455 kHz, 800 kHz, MEGA
Range Capability	<b>455 kHz:</b> 800 ft [244 m] Side to Side <b>800 kHz:</b> 250 ft [76 m] Side to Side <b>MEGA:</b> 250 ft [76 m] Side to Side
Area of Coverage	[2] 86° @ -10 dB in 455 kHz [180° Total Coverage] [2] 55° @ -10 dB in 800 kHz [130° Total Coverage] <b>MEGA:</b> [2] 86° @ -10 dB in MEGA kHz [180° Total Coverage]
Power Output [MAX]	500 Watts [RMS], 4000 Watts [Peak to Peak]

### Down Imaging

Operating Frequency	455 kHz, 800 kHz, MEGA
Depth Capability	<b>455 kHz:</b> 400 ft [122 m] <b>800 kHz:</b> 125 ft [38 m] <b>MEGA:</b> 125 ft [38 m]
Area of Coverage	75° @ -10 dB in 455 kHz 45° @ -10 dB in 800 kHz <b>MEGA:</b> 75° @ -10 dB in MEGA kHz
Power Output [MAX]	500 Watts [RMS], 4000 Watts [Peak to Peak]

## DualBeam PLUS

Operating Frequency .....	200 kHz, 83 kHz
Depth Capability .....	1500 ft (457 m)
Area of Coverage .....	60° @ -10 dB in 83 kHz, 20° @ -10 dB in 200 kHz
Power Output [MAX] .....	500 Watts [RMS], 4000 Watts [Peak to Peak]



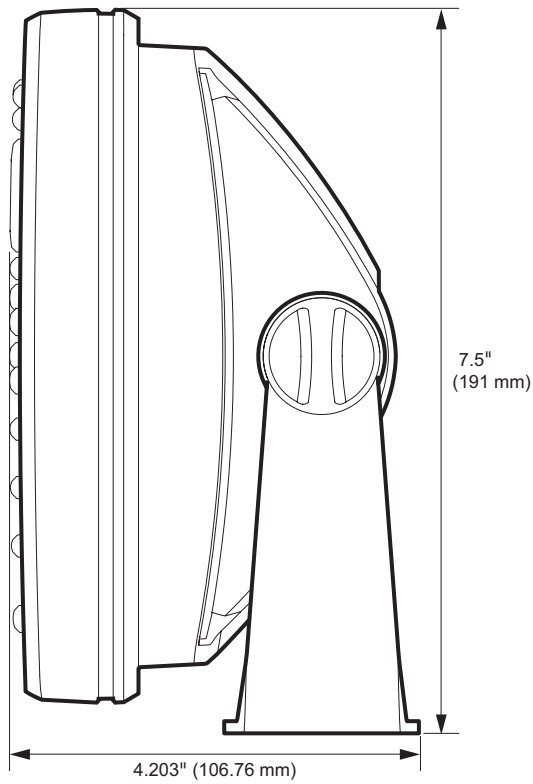
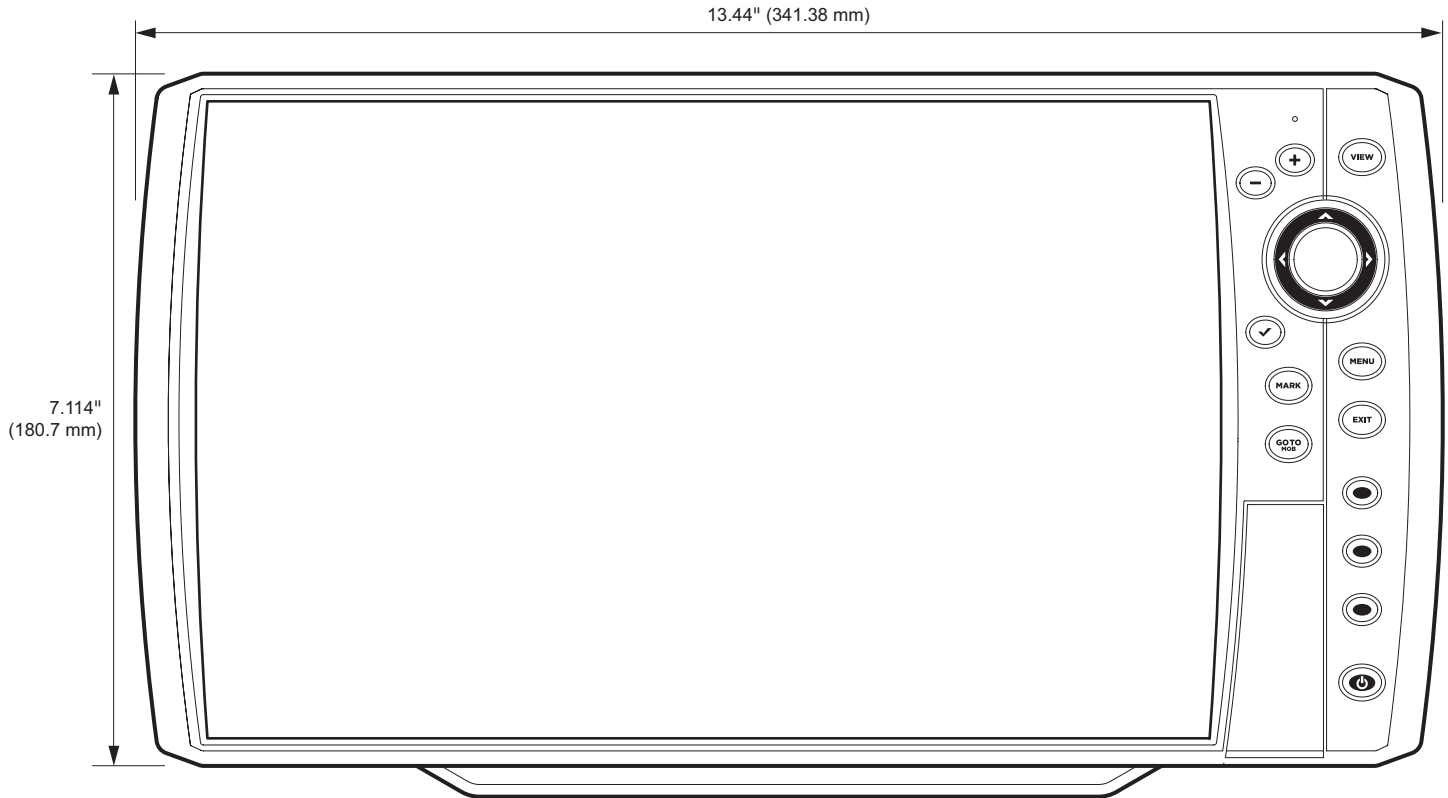
**NOTE:** Humminbird verifies maximum stated depth in saltwater conditions, but actual depth performance may vary due to transducer installation, water type, thermal layers, bottom composition, and slope.



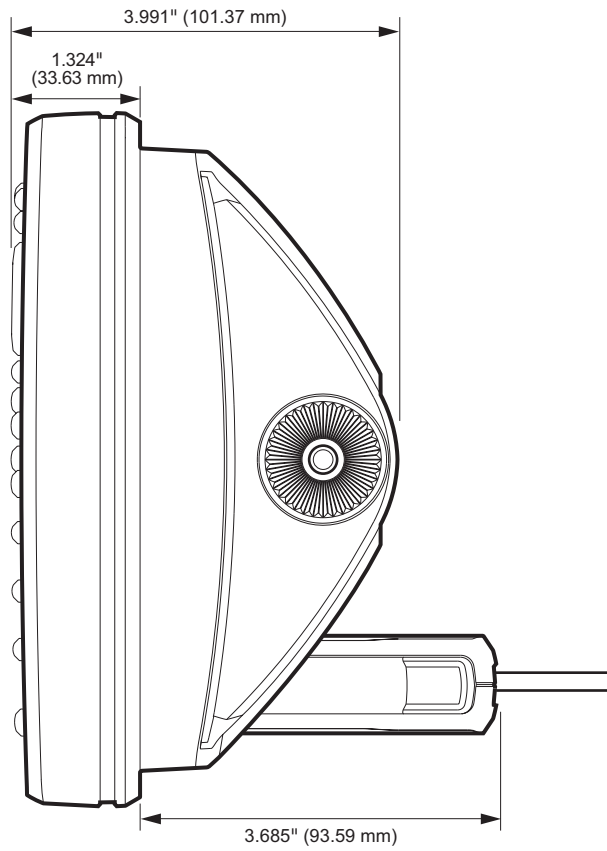
**NOTE:** Product specifications and features are subject to change without notice.

# HELIX 9 G2N Control Head Measurements

## HELIX 9 G2N Gimbal Mount



# HELIX 9 G2N In-Dash Mount





## Control Head

Display Size (diagonal) .....	9 inches [228.6 mm]
Pixel Matrix .....	WVGA 600V x 1024H
Display Type .....	TFT Color
Backlight .....	LED
Communication .....	NMEA 0183, Ethernet
Power Input .....	10 to 20 VDC
Current Draw .....	1.9 A
IPX Rating .....	IPX7 Waterproof/Submersible @ 1 m for 30 minutes
Bluetooth Frequency Range .....	2402 to 2480 MHz
Bluetooth Output Power .....	10 dBm Typical

## Dual Spectrum 2D CHIRP Transducer

### XNT 9 HW T [includes built-in temperature probe]

Default Operating Frequency .....	150 kHz - 220 kHz
Depth Capability .....	1000 ft [305 m]
Area of Coverage .....	<b>Full:</b> 42°@-10 dB in 150-220 kHz <b>Wide:</b> 42°@-10 dB in 140-200 kHz <b>Narrow:</b> 25°@-10 dB in 180-240 kHz
Power Output [MAX] .....	500 Watts [RMS], 4000 Watts [Peak to Peak]



**NOTE:** Humminbird verifies maximum stated depth in saltwater conditions, but actual depth performance may vary due to transducer installation, water type, thermal layers, bottom composition, and slope.



**NOTE:** Product specifications and features are subject to change without notice.

**Control Head**

Display Size (diagonal) .....	9 inches [228.6 mm]
Pixel Matrix .....	WVGA 600V x 1024H
Display Type .....	TFT Color
Backlight .....	LED
Communication .....	NMEA 0183, Ethernet
Power Input .....	10 to 20 VDC
Current Draw .....	1.9 A
IPX Rating .....	IPX7 Waterproof/Submersible @ 1 m for 30 minutes
Bluetooth Frequency Range .....	2402 to 2480 MHz
Bluetooth Output Power .....	10 dBm Typical

**CHIRP MEGA Down Imaging+ Transducer**


**XM 9 HW MDI T** [includes built-in temperature probe]

**Down Imaging**

Operating Frequency .....	455 kHz, 800 kHz, MEGA
Depth Capability .....	<b>455 kHz:</b> 400 ft [122 m] <b>800 kHz:</b> 125 ft [38m] <b>MEGA:</b> 200 ft [61 m]
Area of Coverage .....	<b>455 kHz:</b> 75° @ -10 dB in 455 kHz <b>800 kHz:</b> 45° @ -10 dB in 800 kHz <b>MEGA:</b> 75° @ -10 dB in MEGA kHz
Power Output [MAX] .....	500 Watts [RMS], 4000 Watts [Peak to Peak]

**Dual Spectrum**

Default Operating Frequency .....	150 kHz - 220 kHz
Depth Capability .....	1000 ft [305 m]
Area of Coverage .....	<b>Full:</b> 42°@-10 dB in 150-220 kHz <b>Wide:</b> 42°@-10 dB in 140-200 kHz <b>Narrow:</b> 25°@-10 dB in 180-240 kHz
Power Output [MAX] .....	500 Watts [RMS], 4000 Watts [Peak to Peak]

 **NOTE:** Humminbird verifies maximum stated depth in saltwater conditions, but actual depth performance may vary due to transducer installation, water type, thermal layers, bottom composition, and slope.

 **NOTE:** Product specifications and features are subject to change without notice.

**Control Head**

Display Size (diagonal) .....	9 inches [228.6 mm]
Pixel Matrix .....	WVGA 600V x 1024H
Display Type .....	TFT Color
Backlight .....	LED
Communication .....	NMEA 0183, Ethernet
Power Input .....	10 to 20 VDC
Current Draw .....	1.9 A
IPX Rating .....	IPX7 Waterproof/Submersible @ 1 m for 30 minutes
Bluetooth Frequency Range .....	2402 to 2480 MHz
Bluetooth Output Power .....	10 dBm Typical

**CHIRP MEGA Side Imaging+ Transducer**

**XM 9 HW MSIT** [includes built-in temperature probe]

**Side Imaging**

Operating Frequency .....	455 kHz, 800 kHz, MEGA
Depth Capability .....	<b>455 kHz:</b> 800 ft [244 m] <b>800 kHz:</b> 250 ft [76 m] <b>MEGA:</b> 400 ft [122 m]
Area of Coverage .....	<b>455 kHz:</b> 86° @ -10 dB in 455 kHz <b>800 kHz:</b> 86° @ -10 dB in 800 kHz <b>MEGA:</b> 86° @ -10 dB in MEGA kHz
Power Output [MAX] .....	500 Watts [RMS], 4000 Watts [Peak to Peak]

**Down Imaging**

Operating Frequency .....	455 kHz, 800 kHz, MEGA
Depth Capability .....	<b>455 kHz:</b> 400 ft [122 m] <b>800 kHz:</b> 125 ft [38 m] <b>MEGA:</b> 200 ft [61 m]
Area of Coverage .....	<b>455 kHz:</b> 75° @ -10 dB in 455 kHz <b>800 kHz:</b> 45° @ -10 dB in 800 kHz <b>MEGA:</b> 75° @ -10 dB in MEGA kHz
Power Output [MAX] .....	500 Watts [RMS], 4000 Watts [Peak to Peak]

## Dual Spectrum

Default Operating Frequency .....	150 kHz - 220 kHz
Depth Capability .....	1000 ft (305 m)
Area of Coverage .....	<b>Full:</b> 42°@-10 dB in 150-220 kHz <b>Wide:</b> 42°@-10 dB in 140-200 kHz <b>Narrow:</b> 25°@-10 dB in 180-240 kHz
Power Output [MAX] .....	500 Watts [RMS], 4000 Watts [Peak to Peak]



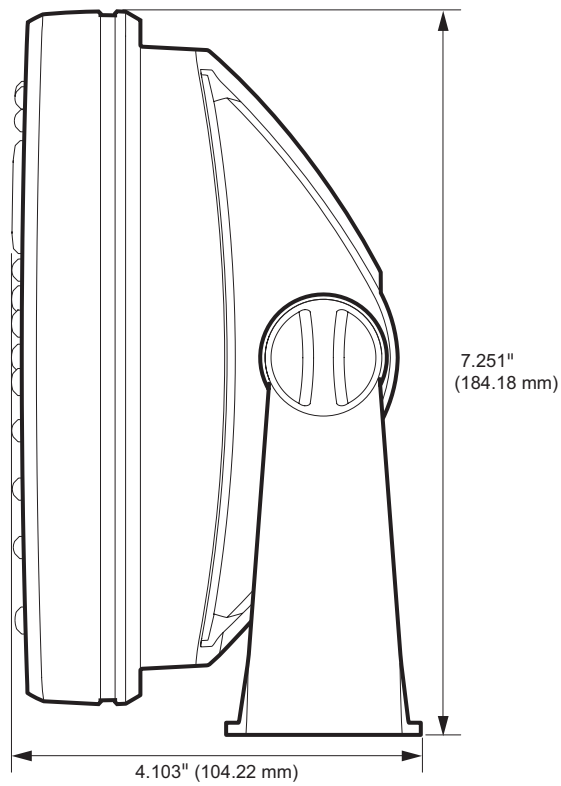
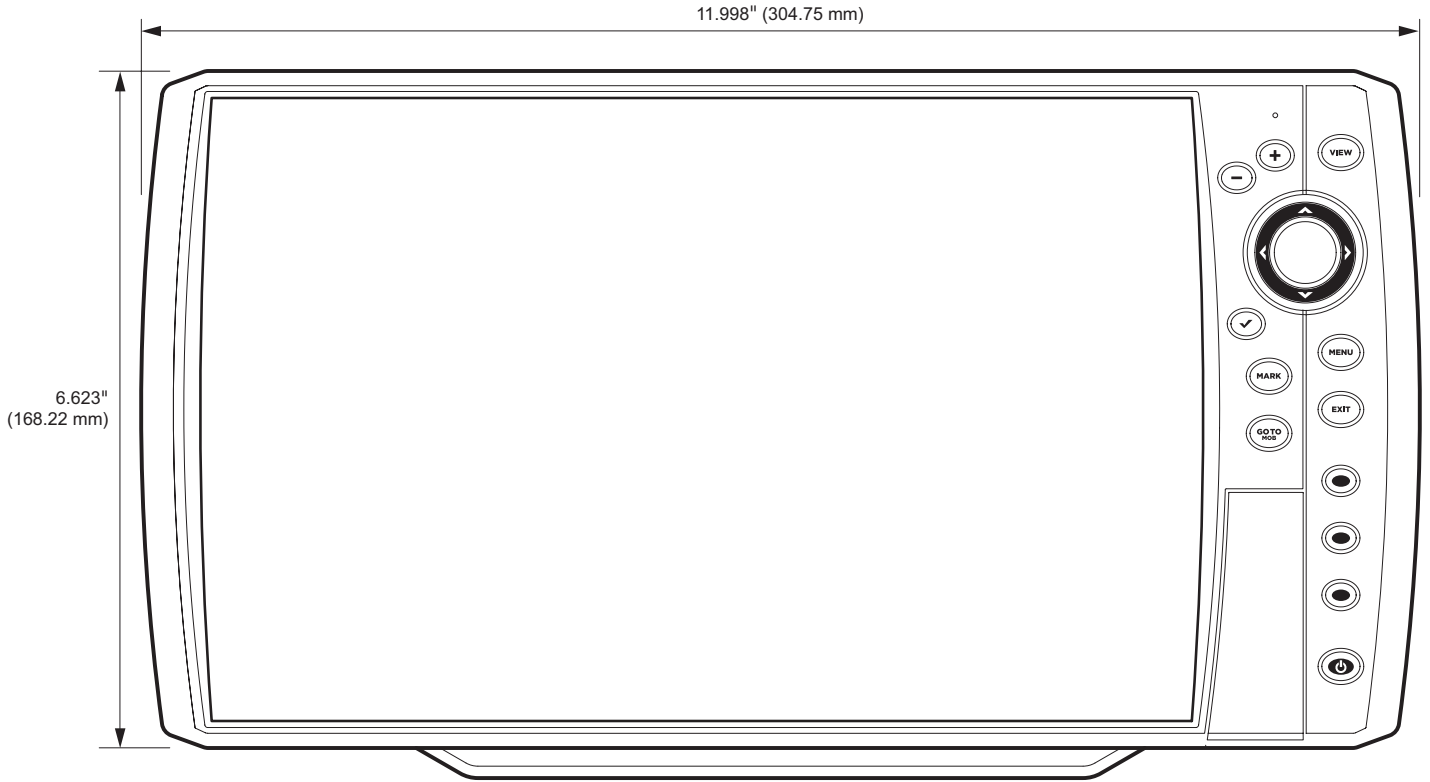
**NOTE:** Humminbird verifies maximum stated depth in saltwater conditions, but actual depth performance may vary due to transducer installation, water type, thermal layers, bottom composition, and slope.



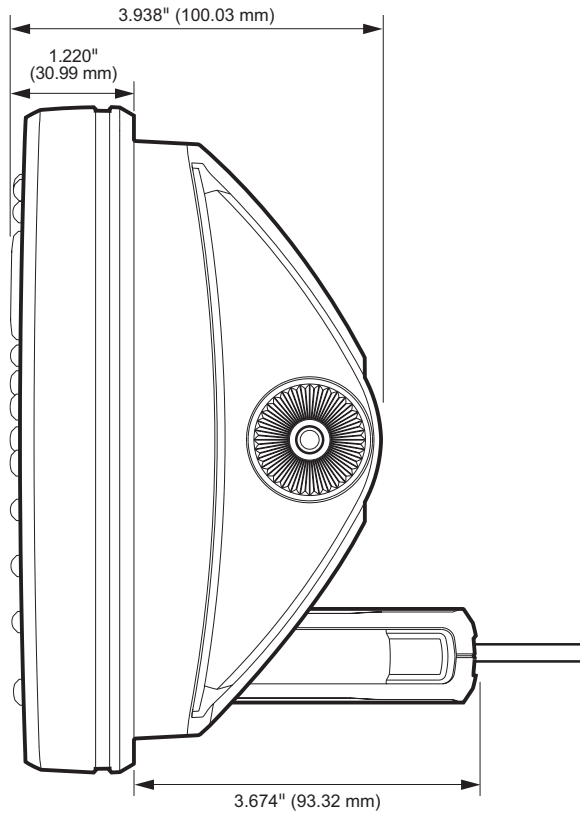
**NOTE:** Product specifications and features are subject to change without notice.

# HELIX 9 G3N Control Head Measurements

## HELIX 9 G3N Gimbal Mount



### HELIX 9 G3N In-Dash Mount



## Control Head

Display Size (diagonal) .....	9 inches [228.6 mm]
Pixel Matrix .....	WSVGA 600V x 1024H
Display Type .....	TFT Color
Backlight .....	LED
Communication .....	Bluetooth, NMEA 0183, NMEA 2000, Ethernet, Wireless
Power Input .....	10 to 20 VDC
Current Draw .....	1.9 A
IPX Rating .....	IPX7 Waterproof/Submersible @ 1 m for 30 minutes
Bluetooth Frequency Range .....	2402 to 2480 MHz
Bluetooth Output Power .....	10 dBm Typical

## Dual Spectrum 2D CHIRP Transducer

### XNT 9 HW T [includes built-in temperature probe]

Default Operating Frequency .....	150 kHz - 220 kHz
Depth Capability .....	1200 ft [366 m]
Area of Coverage .....	<b>Full:</b> 42°@-10 dB in 150-220 kHz <b>Wide:</b> 42°@-10 dB in 140-200 kHz <b>Narrow:</b> 25°@-10 dB in 180-240 kHz
Power Output [MAX] .....	500 Watts [RMS], 4000 Watts [Peak to Peak]



**NOTE:** Humminbird verifies maximum stated depth in saltwater conditions, but actual depth performance may vary due to transducer installation, water type, thermal layers, bottom composition, and slope.



**NOTE:** Product specifications and features are subject to change without notice.

## Control Head

Display Size (diagonal) .....	9 inches [228.6 mm]
Pixel Matrix .....	WSVGA 600V x 1024H
Display Type .....	TFT Color
Backlight .....	LED
Communication .....	Bluetooth, NMEA 0183, NMEA 2000, Ethernet, Wireless
Power Input .....	10 to 20 VDC
Current Draw .....	1.9 A
IPX Rating .....	IPX7 Waterproof/Submersible @ 1 m for 30 minutes
Bluetooth Frequency Range .....	2402 to 2480 MHz
Bluetooth Output Power .....	10 dBm Typical

## CHIRP MEGA Down Imaging+ Transducer

**XM 9 HW MDI T** [includes built-in temperature probe]

### Down Imaging

Operating Frequency .....	455 kHz, 800 kHz, MEGA
Depth Capability .....	<b>455 kHz:</b> 400 ft [122 m] <b>800 kHz:</b> 125 ft [38m] <b>MEGA:</b> 200 ft [61 m]
Area of Coverage .....	<b>455 kHz:</b> 75° @ -10 dB in 455 kHz <b>800 kHz:</b> 45° @ -10 dB in 800 kHz <b>MEGA:</b> 75° @ -10 dB in MEGA kHz
Power Output [MAX] .....	500 Watts [RMS], 4000 Watts [Peak to Peak]

### Dual Spectrum

Default Operating Frequency .....	150 kHz - 220 kHz
Depth Capability .....	1200 ft [366 m]
Area of Coverage .....	<b>Full:</b> 42°@-10 dB in 150-220 kHz <b>Wide:</b> 42°@-10 dB in 140-200 kHz <b>Narrow:</b> 25°@-10 dB in 180-240 kHz
Power Output [MAX] .....	500 Watts [RMS], 4000 Watts [Peak to Peak]



**NOTE:** Humminbird verifies maximum stated depth in saltwater conditions, but actual depth performance may vary due to transducer installation, water type, thermal layers, bottom composition, and slope.



**NOTE:** Product specifications and features are subject to change without notice.



**Control Head**

Display Size (diagonal) .....	9 inches [228.6 mm]
Pixel Matrix .....	WSVGA 600V x 1024H
Display Type .....	TFT Color
Backlight .....	LED
Communication .....	Bluetooth, NMEA 0183, NMEA 2000, Ethernet, Wireless
Power Input .....	10 to 20 VDC
Current Draw .....	1.9 A
IPX Rating .....	IPX7 Waterproof/Submersible @ 1 m for 30 minutes
Bluetooth Frequency Range .....	2402 to 2480 MHz
Bluetooth Output Power .....	10 dBm Typical

**CHIRP MEGA Side Imaging+ Transducer**

**XM 9 HW MSIT** [includes built-in temperature probe]

**Side Imaging**

Operating Frequency .....	455 kHz, 800 kHz, MEGA
Depth Capability .....	<b>455 kHz:</b> 800 ft [244 m] <b>800 kHz:</b> 250 ft [76 m] <b>MEGA:</b> 400 ft [122 m]
Area of Coverage .....	<b>455 kHz:</b> 86° @ -10 dB in 455 kHz <b>800 kHz:</b> 86° @ -10 dB in 800 kHz <b>MEGA:</b> 86° @ -10 dB in MEGA kHz
Power Output [MAX] .....	500 Watts [RMS], 4000 Watts [Peak to Peak]

**Down Imaging**

Operating Frequency .....	455 kHz, 800 kHz, MEGA
Depth Capability .....	<b>455 kHz:</b> 400 ft [122 m] <b>800 kHz:</b> 125 ft [38 m] <b>MEGA:</b> 200 ft [61 m]
Area of Coverage .....	<b>455 kHz:</b> 75° @ -10 dB in 455 kHz <b>800 kHz:</b> 45° @ -10 dB in 800 kHz <b>MEGA:</b> 75° @ -10 dB in MEGA kHz
Power Output [MAX] .....	500 Watts [RMS], 4000 Watts [Peak to Peak]

## Dual Spectrum

Default Operating Frequency .....	150 kHz - 220 kHz
Depth Capability .....	1200 ft (366 m)
Area of Coverage .....	<b>Full:</b> 42°@-10 dB in 150-220 kHz <b>Wide:</b> 42°@-10 dB in 140-200 kHz <b>Narrow:</b> 25°@-10 dB in 180-240 kHz
Power Output [MAX].....	500 Watts [RMS], 4000 Watts [Peak to Peak]



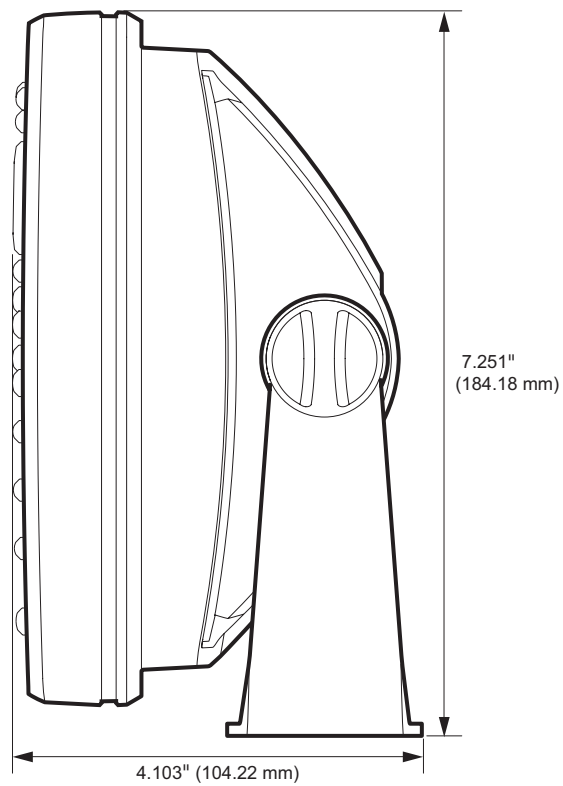
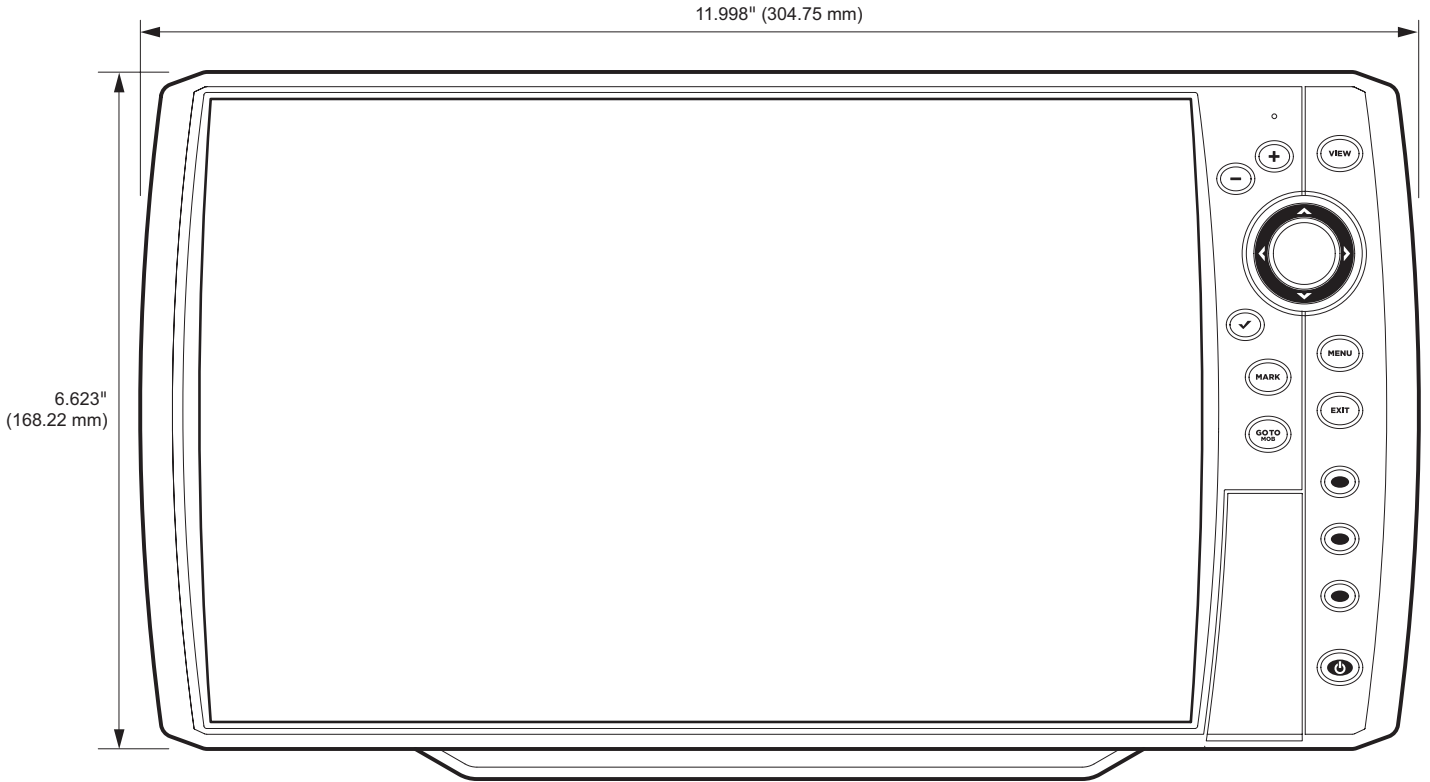
**NOTE:** Humminbird verifies maximum stated depth in saltwater conditions, but actual depth performance may vary due to transducer installation, water type, thermal layers, bottom composition, and slope.



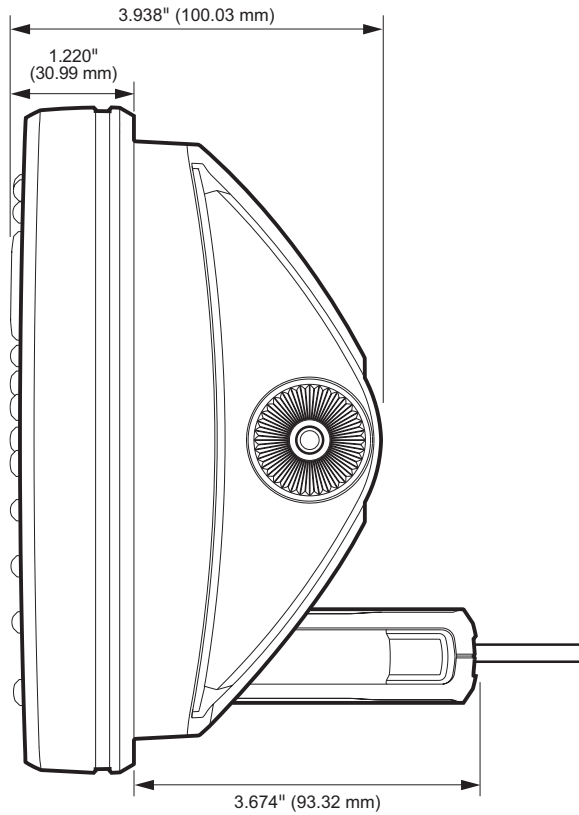
**NOTE:** Product specifications and features are subject to change without notice.

# HELIX 9 G4N Control Head Measurements

## HELIX 9 G4N Gimbal Mount



### HELIX 9 G4N In-Dash Mount



## Control Head

Display Size (diagonal) .....	10.1 inches (256.5 mm)
Pixel Matrix .....	WSVGA 600V x 1024H
Display Type .....	TFT Color
Backlight .....	LED
Communication .....	NMEA 0183, Ethernet
Power Input .....	10 to 20 VDC
Current Draw .....	1.5 A
IPX Rating .....	IPX7 Waterproof/Submersible @ 1 m for 30 minutes
Bluetooth Frequency Range .....	2402 to 2480 MHz
Bluetooth Output Power .....	10 dBm Typical

## CHIRP DualBeam PLUS Transducer

XNT 9 20 T [includes built-in temperature probe]

Operating Frequency .....	200 kHz, 83 kHz
Depth Capability .....	1500 ft (457 m)
Area of Coverage .....	60°@-10 dB in 83 kHz, 20°@-10 dB in 200 kHz
Power Output [MAX] .....	500 Watts [RMS], 4000 Watts [Peak to Peak]



**NOTE:** Humminbird verifies maximum stated depth in saltwater conditions, but actual depth performance may vary due to transducer installation, water type, thermal layers, bottom composition, and slope.



**NOTE:** Product specifications and features are subject to change without notice.

## Control Head

Display Size (diagonal) .....	10.1 inches (256.5 mm)
Pixel Matrix .....	WSVGA 600V x 1024H
Display Type .....	TFT Color
Backlight .....	LED
Communication .....	NMEA 0183, Ethernet
Power Input .....	10 to 20 VDC
Current Draw .....	2.7 A
IPX Rating .....	IPX7 Waterproof/Submersible @ 1 m for 30 minutes
Bluetooth Frequency Range .....	2402 to 2480 MHz
Bluetooth Output Power .....	10 dBm Typical

## CHIRP Down Imaging Transducer

XNT 9 DI T (includes built-in temperature probe)

### Down Imaging

Operating Frequency .....	455 kHz, 800 kHz
Depth Capability .....	350 ft (107 m)
Area of Coverage .....	75° @ -10 dB in 455 kHz, 45° @ -10 dB in 800 kHz
Power Output [MAX] .....	500 Watts [RMS], 4000 Watts [Peak to Peak]

### DualBeam PLUS

Operating Frequency .....	200 kHz, 455 kHz
Depth Capability .....	600 ft (183 m)
Area of Coverage .....	28° @ -10 dB in 200 kHz, 16° @ -10 dB in 455 kHz
Power Output [MAX] .....	500 Watts [RMS], 4000 Watts [Peak to Peak]



**NOTE:** Humminbird verifies maximum stated depth in saltwater conditions, but actual depth performance may vary due to transducer installation, water type, thermal layers, bottom composition, and slope.



**NOTE:** Product specifications and features are subject to change without notice.

**Control Head**

Display Size (diagonal) .....	10.1 inches [256.5 mm]
Pixel Matrix .....	WSVGA 600V x 1024H
Display Type .....	TFT Color
Backlight .....	LED
Communication .....	NMEA 0183, Ethernet
Power Input .....	10 to 20 VDC
Current Draw .....	2.7 A
IPX Rating .....	IPX7 Waterproof/Submersible @ 1 m for 30 minutes
Bluetooth Frequency Range .....	2402 to 2480 MHz
Bluetooth Output Power .....	10 dBm Typical

**CHIRP MEGA Down Imaging Transducer**

**XM 9 MDI T** [includes built-in temperature probe]

**Down Imaging**

Operating Frequency .....	455 kHz, 800 kHz, MEGA
Depth Capability .....	<b>455 kHz:</b> 400 ft [122 m] <b>800 kHz:</b> 125 ft [38 m] <b>MEGA:</b> 125 ft [38 m]
Area of Coverage .....	75° @ -10 dB in 455 kHz 45° @ -10 dB in 800 kHz <b>MEGA:</b> 75° @ -10 dB in MEGA kHz
Power Output [MAX] .....	500 Watts [RMS], 4000 Watts [Peak to Peak]

**Dual Spectrum**

Default Operating Frequency .....	150 kHz - 220 kHz
Depth Capability .....	1000 ft [305 m]
Area of Coverage .....	<b>Full:</b> 42°@-10 dB in 150-220 kHz <b>Wide:</b> 42°@-10 dB in 140-200 kHz <b>Narrow:</b> 25°@-10 dB in 180-240 kHz
Power Output [MAX] .....	500 Watts [RMS], 4000 Watts [Peak to Peak]



**NOTE:** Humminbird verifies maximum stated depth in saltwater conditions, but actual depth performance may vary due to transducer installation, water type, thermal layers, bottom composition, and slope.



**NOTE:** Product specifications and features are subject to change without notice.

**Control Head**

Display Size (diagonal) .....	10.1 inches [256.5 mm]
Pixel Matrix .....	WSVGA 600V x 1024H
Display Type .....	TFT Color
Backlight .....	LED
Communication .....	NMEA 0183, Ethernet
Power Input .....	10 to 20 VDC
Current Draw .....	2.7 A
IPX Rating .....	IPX7 Waterproof/Submersible @ 1 m for 30 minutes
Bluetooth Frequency Range .....	2402 to 2480 MHz
Bluetooth Output Power .....	10 dBm Typical

**CHIRP MEGA Side Imaging Transducer**

**XM 9 20 MSI T** [includes built-in temperature probe]

**Side Imaging**

Operating Frequency .....	455 kHz, 800 kHz, MEGA
Range Capability .....	<b>455 kHz:</b> 800 ft [244 m] Side to Side <b>800 kHz:</b> 250 ft [76 m] Side to Side <b>MEGA:</b> 250 ft [76 m] Side to Side
Area of Coverage .....	[2] 86° @ -10 dB in 455 kHz [180° Total Coverage] [2] 55° @ -10 dB in 800 kHz [130° Total Coverage] <b>MEGA:</b> [2] 86° @ -10 dB in MEGA kHz [180° Total Coverage]
Power Output [MAX] .....	500 Watts [RMS], 4000 Watts [Peak to Peak]

**Down Imaging**

Operating Frequency .....	455 kHz, 800 kHz, MEGA
Depth Capability .....	<b>455 kHz:</b> 400 ft [122 m] <b>800 kHz:</b> 125 ft [38 m] <b>MEGA:</b> 125 ft [38 m]
Area of Coverage .....	75° @ -10 dB in 455 kHz 45° @ -10 dB in 800 kHz <b>MEGA:</b> 75° @ -10 dB in MEGA kHz
Power Output [MAX] .....	500 Watts [RMS], 4000 Watts [Peak to Peak]



## DualBeam PLUS

Operating Frequency .....	200 kHz, 83 kHz
Depth Capability .....	1500 ft (457 m)
Area of Coverage .....	60° @ -10 dB in 83 kHz, 20° @ -10 dB in 200 kHz
Power Output [MAX].....	500 Watts [RMS], 4000 Watts [Peak to Peak]



**NOTE:** Humminbird verifies maximum stated depth in saltwater conditions, but actual depth performance may vary due to transducer installation, water type, thermal layers, bottom composition, and slope.



**NOTE:** Product specifications and features are subject to change without notice.

## Control Head

Display Size (diagonal)	10.1 inches (256.5 mm)
Pixel Matrix	WSVGA 600V x 1024H
Display Type	TFT Color
Backlight	LED
Communication	NMEA 0183, Ethernet
Power Input	10 to 20 VDC
Current Draw	2.4 A
IPX Rating	IPX7 Waterproof/Submersible @ 1 m for 30 minutes
Bluetooth Frequency Range	2402 to 2480 MHz
Bluetooth Output Power	10 dBm Typical

## Dual Spectrum 2D CHIRP Transducer

### XNT 9 HW T [includes built-in temperature probe]

Default Operating Frequency	150 kHz - 220 kHz
Depth Capability	1000 ft (305 m)
Area of Coverage	<b>Full:</b> 42°@-10 dB in 150-220 kHz <b>Wide:</b> 42°@-10 dB in 140-200 kHz <b>Narrow:</b> 25°@-10 dB in 180-240 kHz
Power Output (MAX)	500 Watts (RMS), 4000 Watts (Peak to Peak)



**NOTE:** Humminbird verifies maximum stated depth in saltwater conditions, but actual depth performance may vary due to transducer installation, water type, thermal layers, bottom composition, and slope.



**NOTE:** Product specifications and features are subject to change without notice.

## Control Head

Display Size (diagonal)	10.1 inches (256.5 mm)
Pixel Matrix	WSVGA 600V x 1024H
Display Type	TFT Color
Backlight	LED
Communication	NMEA 0183, Ethernet
Power Input	10 to 20 VDC
Current Draw	2.4 A
IPX Rating	IPX7 Waterproof/Submersible @ 1 m for 30 minutes
Bluetooth Frequency Range	2402 to 2480 MHz
Bluetooth Output Power	10 dBm Typical

## CHIRP MEGA Down Imaging+ Transducer

**XM 9 HW MDI T** [includes built-in temperature probe]

### Down Imaging

Operating Frequency	455 kHz, 800 kHz, MEGA
Depth Capability	<b>455 kHz:</b> 400 ft (122 m) <b>800 kHz:</b> 125 ft (38m) <b>MEGA:</b> 200 ft (61 m)
Area of Coverage	<b>455 kHz:</b> 75° @ -10 dB in 455 kHz <b>800 kHz:</b> 45° @ -10 dB in 800 kHz <b>MEGA:</b> 75° @ -10 dB in MEGA kHz
Power Output [MAX]	500 Watts [RMS], 4000 Watts [Peak to Peak]

### Dual Spectrum

Default Operating Frequency	150 kHz - 220 kHz
Depth Capability	1000 ft (305 m)
Area of Coverage	<b>Full:</b> 42°@-10 dB in 150-220 kHz <b>Wide:</b> 42°@-10 dB in 140-200 kHz <b>Narrow:</b> 25°@-10 dB in 180-240 kHz
Power Output [MAX]	500 Watts [RMS], 4000 Watts [Peak to Peak]



**NOTE:** Humminbird verifies maximum stated depth in saltwater conditions, but actual depth performance may vary due to transducer installation, water type, thermal layers, bottom composition, and slope.



**NOTE:** Product specifications and features are subject to change without notice.

**Control Head**

Display Size (diagonal) .....	10.1 inches [256.5 mm]
Pixel Matrix .....	WSVGA 600V x 1024H
Display Type .....	TFT Color
Backlight .....	LED
Communication .....	NMEA 0183, Ethernet
Power Input .....	10 to 20 VDC
Current Draw .....	2.4 A
IPX Rating .....	IPX7 Waterproof/Submersible @ 1 m for 30 minutes
Bluetooth Frequency Range .....	2402 to 2480 MHz
Bluetooth Output Power .....	10 dBm Typical

**CHIRP MEGA Side Imaging+ Transducer**

**XM 9 HW MSIT** [includes built-in temperature probe]

**Side Imaging**

Operating Frequency .....	455 kHz, 800 kHz, MEGA
Depth Capability .....	<b>455 kHz:</b> 800 ft [244 m] <b>800 kHz:</b> 250 ft [76 m] <b>MEGA:</b> 400 ft [122 m]
Area of Coverage .....	<b>455 kHz:</b> 86° @ -10 dB in 455 kHz <b>800 kHz:</b> 86° @ -10 dB in 800 kHz <b>MEGA:</b> 86° @ -10 dB in MEGA kHz
Power Output [MAX] .....	500 Watts [RMS], 4000 Watts [Peak to Peak]

**Down Imaging**

Operating Frequency .....	455 kHz, 800 kHz, MEGA
Depth Capability .....	<b>455 kHz:</b> 400 ft [122 m] <b>800 kHz:</b> 125 ft [38 m] <b>MEGA:</b> 200 ft [61 m]
Area of Coverage .....	<b>455 kHz:</b> 75° @ -10 dB in 455 kHz <b>800 kHz:</b> 45° @ -10 dB in 800 kHz <b>MEGA:</b> 75° @ -10 dB in MEGA kHz
Power Output [MAX] .....	500 Watts [RMS], 4000 Watts [Peak to Peak]

## Dual Spectrum

Default Operating Frequency .....	150 kHz - 220 kHz
Depth Capability .....	1000 ft (305 m)
Area of Coverage .....	<b>Full:</b> 42°@-10 dB in 150-220 kHz <b>Wide:</b> 42°@-10 dB in 140-200 kHz <b>Narrow:</b> 25°@-10 dB in 180-240 kHz
Power Output [MAX].....	500 Watts [RMS], 4000 Watts [Peak to Peak]



**NOTE:** Humminbird verifies maximum stated depth in saltwater conditions, but actual depth performance may vary due to transducer installation, water type, thermal layers, bottom composition, and slope.



**NOTE:** Product specifications and features are subject to change without notice.

## Control Head

Display Size (diagonal)	10.1 inches (256.5 mm)
Pixel Matrix	WSVGA 600V x 1024H
Display Type	TFT Color
Backlight	LED
Communication	Bluetooth, NMEA 0183, NMEA 2000, Ethernet, Wireless
Power Input	10 to 20 VDC
Current Draw	2.7 A
IPX Rating	IPX7 Waterproof/Submersible @ 1 m for 30 minutes
Bluetooth Frequency Range	2402 to 2480 MHz
Bluetooth Output Power	10 dBm Typical

## Dual Spectrum 2D CHIRP Transducer

### XNT 9 HW T [includes built-in temperature probe]

Default Operating Frequency	150 kHz - 220 kHz
Depth Capability	1200 ft (366 m)
Area of Coverage	<b>Full:</b> 42°@-10 dB in 150-220 kHz <b>Wide:</b> 42°@-10 dB in 140-200 kHz <b>Narrow:</b> 25°@-10 dB in 180-240 kHz
Power Output [MAX]	500 Watts [RMS], 4000 Watts [Peak to Peak]



**NOTE:** Humminbird verifies maximum stated depth in saltwater conditions, but actual depth performance may vary due to transducer installation, water type, thermal layers, bottom composition, and slope.



**NOTE:** Product specifications and features are subject to change without notice.

## Control Head

Display Size (diagonal)	10.1 inches (256.5 mm)
Pixel Matrix	WSVGA 600V x 1024H
Display Type	TFT Color
Backlight	LED
Communication	Bluetooth, NMEA 0183, NMEA 2000, Ethernet, Wireless
Power Input	10 to 20 VDC
Current Draw	2.7 A
IPX Rating	IPX7 Waterproof/Submersible @ 1 m for 30 minutes
Bluetooth Frequency Range	2402 to 2480 MHz
Bluetooth Output Power	10 dBm Typical

## CHIRP MEGA Down Imaging+ Transducer

**XM 9 HW MDI T** [includes built-in temperature probe]

### Down Imaging

Operating Frequency	455 kHz, 800 kHz, MEGA
Depth Capability	<b>455 kHz:</b> 400 ft (122 m) <b>800 kHz:</b> 125 ft (38m) <b>MEGA:</b> 200 ft (61 m)
Area of Coverage	<b>455 kHz:</b> 75° @ -10 dB in 455 kHz <b>800 kHz:</b> 45° @ -10 dB in 800 kHz <b>MEGA:</b> 75° @ -10 dB in MEGA kHz
Power Output [MAX]	500 Watts [RMS], 4000 Watts [Peak to Peak]

### Dual Spectrum

Default Operating Frequency	150 kHz - 220 kHz
Depth Capability	1200 ft (366 m)
Area of Coverage	<b>Full:</b> 42°@-10 dB in 150-220 kHz <b>Wide:</b> 42°@-10 dB in 140-200 kHz <b>Narrow:</b> 25°@-10 dB in 180-240 kHz
Power Output [MAX]	500 Watts [RMS], 4000 Watts [Peak to Peak]



**NOTE:** Humminbird verifies maximum stated depth in saltwater conditions, but actual depth performance may vary due to transducer installation, water type, thermal layers, bottom composition, and slope.



**NOTE:** Product specifications and features are subject to change without notice.

**Control Head**

Display Size (diagonal) .....	10.1 inches [256.5 mm]
Pixel Matrix .....	WSVGA 600V x 1024H
Display Type .....	TFT Color
Backlight .....	LED
Communication .....	Bluetooth, NMEA 0183, NMEA 2000, Ethernet, Wireless
Power Input .....	10 to 20 VDC
Current Draw .....	2.7 A
IPX Rating .....	IPX7 Waterproof/Submersible @ 1 m for 30 minutes
Bluetooth Frequency Range .....	2402 to 2480 MHz
Bluetooth Output Power .....	10 dBm Typical

**CHIRP MEGA Side Imaging+ Transducer**

**XM 9 HW MSIT** [includes built-in temperature probe]

**Side Imaging**

Operating Frequency .....	455 kHz, 800 kHz, MEGA
Depth Capability .....	<b>455 kHz:</b> 800 ft [244 m] <b>800 kHz:</b> 250 ft [76 m] <b>MEGA:</b> 400 ft [122 m]
Area of Coverage .....	<b>455 kHz:</b> 86° @ -10 dB in 455 kHz <b>800 kHz:</b> 86° @ -10 dB in 800 kHz <b>MEGA:</b> 86° @ -10 dB in MEGA kHz
Power Output [MAX] .....	500 Watts [RMS], 4000 Watts [Peak to Peak]

**Down Imaging**

Operating Frequency .....	455 kHz, 800 kHz, MEGA
Depth Capability .....	<b>455 kHz:</b> 400 ft [122 m] <b>800 kHz:</b> 125 ft [38 m] <b>MEGA:</b> 200 ft [61 m]
Area of Coverage .....	<b>455 kHz:</b> 75° @ -10 dB in 455 kHz <b>800 kHz:</b> 45° @ -10 dB in 800 kHz <b>MEGA:</b> 75° @ -10 dB in MEGA kHz
Power Output [MAX] .....	500 Watts [RMS], 4000 Watts [Peak to Peak]



## Dual Spectrum

Default Operating Frequency .....	150 kHz - 220 kHz
Depth Capability .....	1200 ft (366 m)
Area of Coverage .....	<b>Full:</b> 42°@-10 dB in 150-220 kHz <b>Wide:</b> 42°@-10 dB in 140-200 kHz <b>Narrow:</b> 25°@-10 dB in 180-240 kHz
Power Output [MAX].....	500 Watts [RMS], 4000 Watts [Peak to Peak]

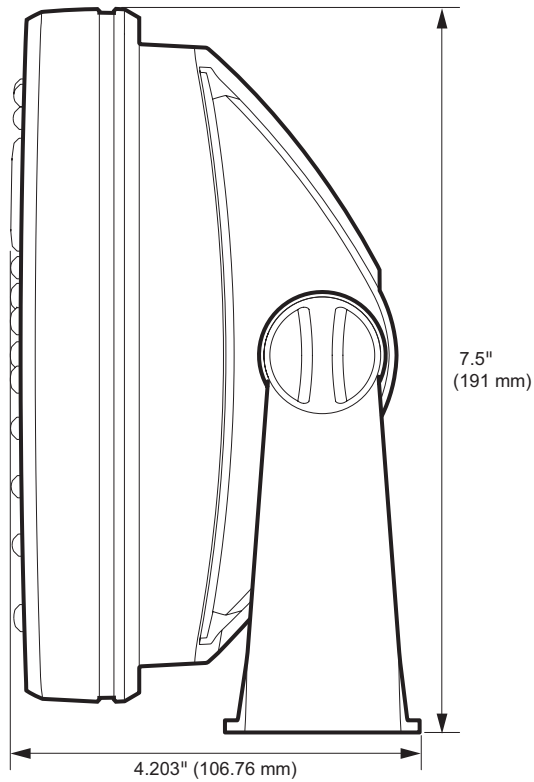
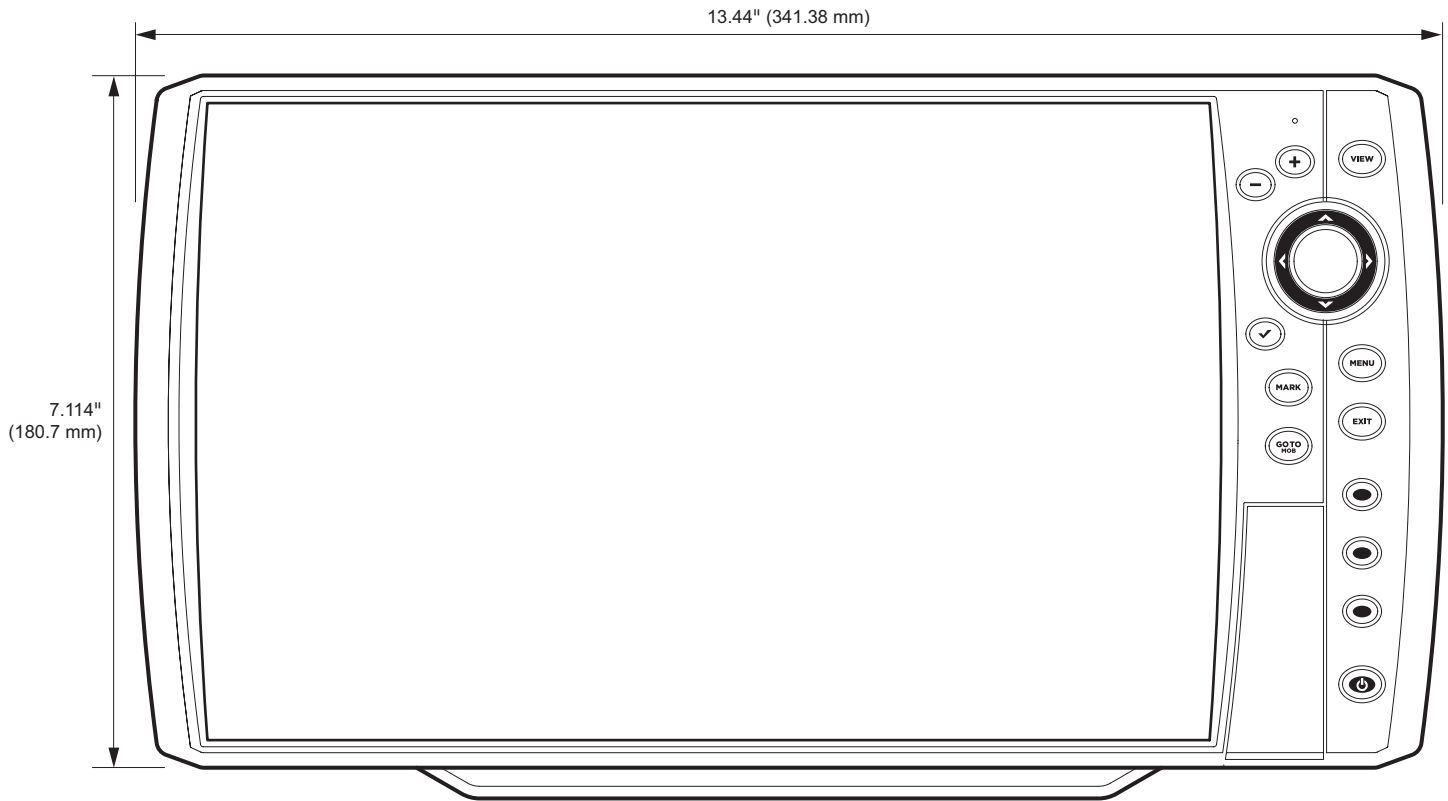


**NOTE:** Humminbird verifies maximum stated depth in saltwater conditions, but actual depth performance may vary due to transducer installation, water type, thermal layers, bottom composition, and slope.



**NOTE:** Product specifications and features are subject to change without notice.

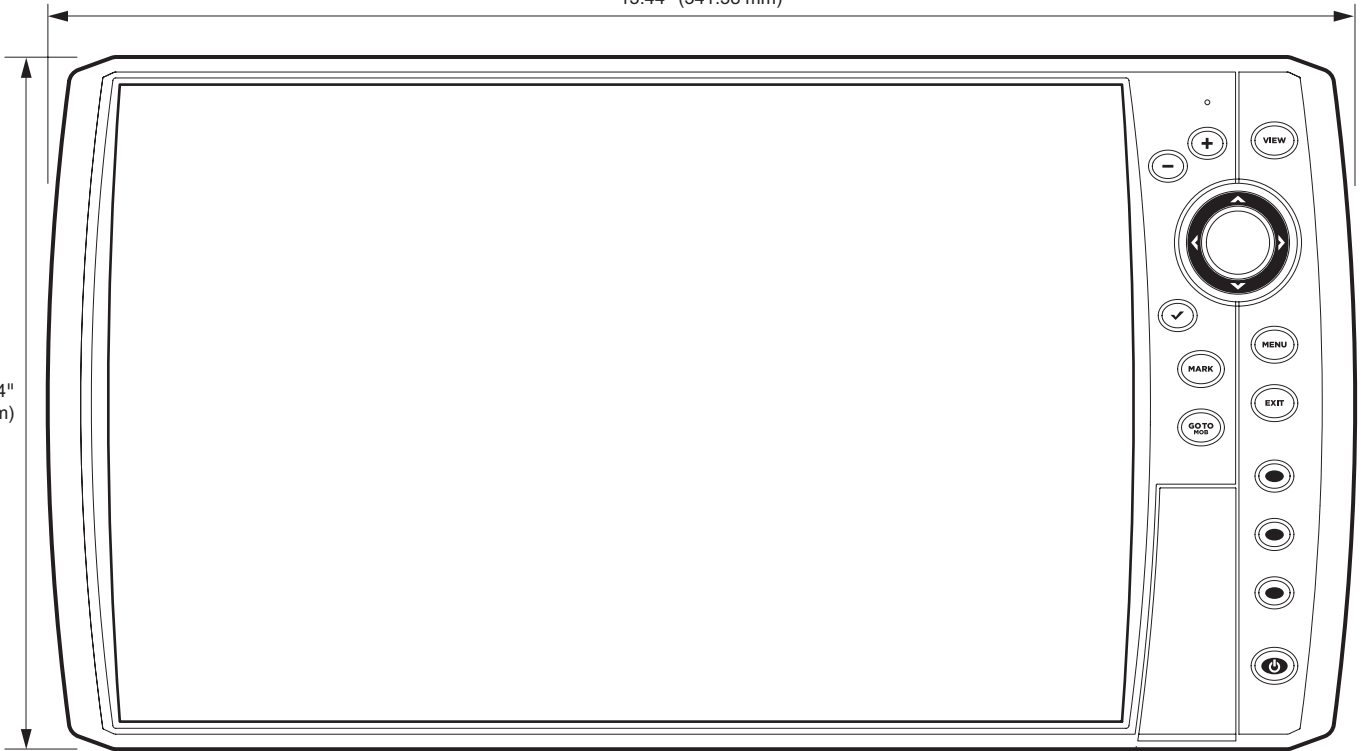
**HELIX 10 Gimbal Mount**



# HELIX 10 In-Dash Mount

13.44" (341.38 mm)

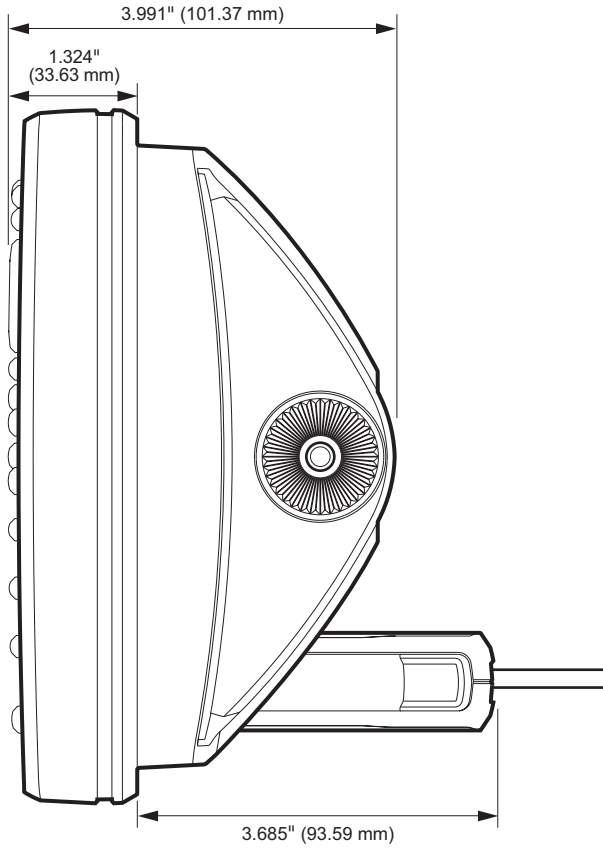
7.114"  
(180.7 mm)



3.991" (101.37 mm)

1.324"  
(33.63 mm)

3.685" (93.59 mm)



## Control Head

Display Size (diagonal)	12.1 inches (307.3 mm)
Pixel Matrix	WXGA 800V x 1280H
Display Type	TFT Color
Backlight	LED
Communication	NMEA 0183, Ethernet
Power Input	10 to 20 VDC
Current Draw	2.2 A
IPX Rating	IPX7 Waterproof/Submersible @ 1 m for 30 minutes
Bluetooth Frequency Range	2402 to 2480 MHz
Bluetooth Output Power	10 dBm Typical

## CHIRP DualBeam PLUS Transducer

### XNT 9 20 T [includes built-in temperature probe]

Operating Frequency	83 kHz, 200 kHz
Depth Capability	1500 ft (457 m)
Area of Coverage	60°@-10 dB in 83 kHz, 20°@-10 dB in 200 kHz
Power Output (MAX)	500 Watts (RMS), 4000 Watts (Peak to Peak)



**NOTE:** Humminbird verifies maximum stated depth in saltwater conditions, but actual depth performance may vary due to transducer installation, water type, thermal layers, bottom composition, and slope.



**NOTE:** Product specifications and features are subject to change without notice.

## Control Head

Display Size (diagonal) .....	12.1 inches (307.3 mm)
Pixel Matrix .....	WXGA 800V x 1280H
Display Type .....	TFT Color
Backlight .....	LED
Communication .....	NMEA 0183, Ethernet
Power Input .....	10 to 20 VDC
Current Draw .....	3.0 A
IPX Rating .....	IPX7 Waterproof/Submersible @ 1 m for 30 minutes
Bluetooth Frequency Range .....	2402 to 2480 MHz
Bluetooth Output Power .....	10 dBm Typical

## CHIRP Down Imaging Transducer


XNT 9 DI T (includes built-in temperature probe)

### Down Imaging

Operating Frequency .....	455 kHz, 800 kHz
Depth Capability .....	350 ft (107 m)
Area of Coverage .....	75° @ -10 dB in 455 kHz, 45° @ -10 dB in 800 kHz
Power Output [MAX] .....	500 Watts [RMS], 4000 Watts [Peak to Peak]

### DualBeam PLUS

Operating Frequency .....	200 kHz, 455 kHz
Depth Capability .....	600 ft (183 m)
Area of Coverage .....	28° @ -10 dB in 200 kHz, 16° @ -10 dB in 455 kHz
Power Output [MAX] .....	500 Watts [RMS], 4000 Watts [Peak to Peak]

 **NOTE:** Humminbird verifies maximum stated depth in saltwater conditions, but actual depth performance may vary due to transducer installation, water type, thermal layers, bottom composition, and slope.

 **NOTE:** Product specifications and features are subject to change without notice.

## Control Head

Display Size (diagonal)	12.1 inches (307.3 mm)
Pixel Matrix	WXGA 800V x 1280H
Display Type	TFT Color
Backlight	LED
Communication	NMEA 0183, Ethernet
Power Input	10 to 20 VDC
Current Draw	3.0 A
IPX Rating	IPX7 Waterproof/Submersible @ 1 m for 30 minutes
Bluetooth Frequency Range	2402 to 2480 MHz
Bluetooth Output Power	10 dBm Typical

## CHIRP MEGA Down Imaging Transducer

**XM 9 MDI T** (includes built-in temperature probe)

### Down Imaging

Operating Frequency	455 kHz, 800 kHz, MEGA
Depth Capability	<b>455 kHz:</b> 400 ft (122 m) <b>800 kHz:</b> 125 ft (38 m) <b>MEGA:</b> 125 ft (38 m)
Area of Coverage	75° @ -10 dB in 455 kHz 45° @ -10 dB in 800 kHz <b>MEGA:</b> 75° @ -10 dB in MEGA kHz
Power Output [MAX]	500 Watts [RMS], 4000 Watts [Peak to Peak]

### Dual Spectrum

Default Operating Frequency	150 kHz - 220 kHz
Depth Capability	1000 ft (305 m)
Area of Coverage	<b>Full:</b> 42°@-10 dB in 150-220 kHz <b>Wide:</b> 42°@-10 dB in 140-200 kHz <b>Narrow:</b> 25°@-10 dB in 180-240 kHz
Power Output [MAX]	500 Watts [RMS], 4000 Watts [Peak to Peak]



**NOTE:** Humminbird verifies maximum stated depth in saltwater conditions, but actual depth performance may vary due to transducer installation, water type, thermal layers, bottom composition, and slope.



**NOTE:** Product specifications and features are subject to change without notice.

**Control Head**

Display Size (diagonal) .....	12.1 inches [307.3 mm]
Pixel Matrix .....	WXGA 800V x 1280H
Display Type .....	TFT Color
Backlight .....	LED
Communication .....	NMEA 0183, Ethernet
Power Input .....	10 to 20 VDC
Current Draw .....	3.0 A
IPX Rating .....	IPX7 Waterproof/Submersible @ 1 m for 30 minutes
Bluetooth Frequency Range .....	2402 to 2480 MHz
Bluetooth Output Power .....	10 dBm Typical

**CHIRP MEGA Side Imaging Transducer**

**XM 9 20 MSI T** [includes built-in temperature probe]

**Side Imaging**

Operating Frequency .....	455 kHz, 800 kHz, MEGA
Range Capability .....	<b>455 kHz:</b> 800 ft [244 m] Side to Side <b>800 kHz:</b> 250 ft [76 m] Side to Side <b>MEGA:</b> 250 ft [76 m] Side to Side
Area of Coverage .....	[2] 86° @ -10 dB in 455 kHz [180° Total Coverage] [2] 55° @ -10 dB in 800 kHz [130° Total Coverage] <b>MEGA:</b> [2] 86° @ -10 dB in MEGA kHz [180° Total Coverage]
Power Output [MAX] .....	500 Watts [RMS], 4000 Watts [Peak to Peak]

**Down Imaging**

Operating Frequency .....	455 kHz, 800 kHz, MEGA
Depth Capability .....	<b>455 kHz:</b> 400 ft [122 m] <b>800 kHz:</b> 125 ft [38 m] <b>MEGA:</b> 125 ft [38 m]
Area of Coverage .....	75° @ -10 dB in 455 kHz 45° @ -10 dB in 800 kHz <b>MEGA:</b> 75° @ -10 dB in MEGA kHz
Power Output [MAX] .....	500 Watts [RMS], 4000 Watts [Peak to Peak]

## DualBeam PLUS

Operating Frequency .....	200 kHz, 83 kHz
Depth Capability .....	1500 ft (457 m)
Area of Coverage .....	60° @ -10 dB in 83 kHz, 20° @ -10 dB in 200 kHz
Power Output [MAX] .....	500 Watts [RMS], 4000 Watts [Peak to Peak]



**NOTE:** Humminbird verifies maximum stated depth in saltwater conditions, but actual depth performance may vary due to transducer installation, water type, thermal layers, bottom composition, and slope.



**NOTE:** Product specifications and features are subject to change without notice.



## Control Head

Display Size (diagonal) .....	12.1 inches (307.3 mm)
Pixel Matrix .....	WXGA 800V x 1280H
Display Type .....	TFT Color
Backlight .....	LED
Communication .....	NMEA 0183, Ethernet
Power Input .....	10 to 20 VDC
Current Draw .....	3.3 A
IPX Rating .....	IPX7 Waterproof/Submersible @ 1 m for 30 minutes
Bluetooth Frequency Range .....	2402 to 2480 MHz
Bluetooth Output Power .....	10 dBm Typical

## Dual Spectrum 2D CHIRP Transducer

### XNT 9 HW T [includes built-in temperature probe]

Default Operating Frequency .....	150 kHz - 220 kHz
Depth Capability .....	1000 ft (305 m)
Area of Coverage .....	<b>Full:</b> 42°@-10 dB in 150-220 kHz <b>Wide:</b> 42°@-10 dB in 140-200 kHz <b>Narrow:</b> 25°@-10 dB in 180-240 kHz
Power Output [MAX] .....	500 Watts [RMS], 4000 Watts [Peak to Peak]



**NOTE:** Humminbird verifies maximum stated depth in saltwater conditions, but actual depth performance may vary due to transducer installation, water type, thermal layers, bottom composition, and slope.



**NOTE:** Product specifications and features are subject to change without notice.

## Control Head

Display Size (diagonal)	12.1 inches (307.3 mm)
Pixel Matrix	WXGA 800V x 1280H
Display Type	TFT Color
Backlight	LED
Communication	NMEA 0183, Ethernet
Power Input	10 to 20 VDC
Current Draw	3.3 A
IPX Rating	IPX7 Waterproof/Submersible @ 1 m for 30 minutes
Bluetooth Frequency Range	2402 to 2480 MHz
Bluetooth Output Power	10 dBm Typical

## CHIRP MEGA Down Imaging+ Transducer

XM 9 HW MDI T [includes built-in temperature probe]

### Down Imaging

Operating Frequency	455 kHz, 800 kHz, MEGA
Depth Capability	<b>455 kHz:</b> 400 ft (122 m) <b>800 kHz:</b> 125 ft (38m) <b>MEGA:</b> 200 ft (61 m)
Area of Coverage	<b>455 kHz:</b> 75° @ -10 dB in 455 kHz <b>800 kHz:</b> 45° @ -10 dB in 800 kHz <b>MEGA:</b> 75° @ -10 dB in MEGA kHz
Power Output [MAX]	500 Watts [RMS], 4000 Watts [Peak to Peak]

### Dual Spectrum

Default Operating Frequency	150 kHz - 220 kHz
Depth Capability	1000 ft (305 m)
Area of Coverage	<b>Full:</b> 42°@-10 dB in 150-220 kHz <b>Wide:</b> 42°@-10 dB in 140-200 kHz <b>Narrow:</b> 25°@-10 dB in 180-240 kHz
Power Output [MAX]	500 Watts [RMS], 4000 Watts [Peak to Peak]



**NOTE:** Humminbird verifies maximum stated depth in saltwater conditions, but actual depth performance may vary due to transducer installation, water type, thermal layers, bottom composition, and slope.



**NOTE:** Product specifications and features are subject to change without notice.

**Control Head**

Display Size (diagonal) .....	12.1 inches [307.3 mm]
Pixel Matrix .....	WXGA 800V x 1280H
Display Type .....	TFT Color
Backlight .....	LED
Communication .....	NMEA 0183, Ethernet
Power Input .....	10 to 20 VDC
Current Draw .....	3.3 A
IPX Rating .....	IPX7 Waterproof/Submersible @ 1 m for 30 minutes
Bluetooth Frequency Range .....	2402 to 2480 MHz
Bluetooth Output Power .....	10 dBm Typical

**CHIRP MEGA Side Imaging+ Transducer**

**XM 9 HW MSIT** [includes built-in temperature probe]

**Side Imaging**

Operating Frequency .....	455 kHz, 800 kHz, MEGA
Depth Capability .....	<b>455 kHz:</b> 800 ft [244 m] <b>800 kHz:</b> 250 ft [76 m] <b>MEGA:</b> 400 ft [122 m]
Area of Coverage .....	<b>455 kHz:</b> 86° @ -10 dB in 455 kHz <b>800 kHz:</b> 86° @ -10 dB in 800 kHz <b>MEGA:</b> 86° @ -10 dB in MEGA kHz
Power Output [MAX] .....	500 Watts [RMS], 4000 Watts [Peak to Peak]

**Down Imaging**

Operating Frequency .....	455 kHz, 800 kHz, MEGA
Depth Capability .....	<b>455 kHz:</b> 400 ft [122 m] <b>800 kHz:</b> 125 ft [38 m] <b>MEGA:</b> 200 ft [61 m]
Area of Coverage .....	<b>455 kHz:</b> 75° @ -10 dB in 455 kHz <b>800 kHz:</b> 45° @ -10 dB in 800 kHz <b>MEGA:</b> 75° @ -10 dB in MEGA kHz
Power Output [MAX] .....	500 Watts [RMS], 4000 Watts [Peak to Peak]

## Dual Spectrum

Default Operating Frequency .....	150 kHz - 220 kHz
Depth Capability .....	1000 ft (305 m)
Area of Coverage .....	<b>Full:</b> 42°@-10 dB in 150-220 kHz <b>Wide:</b> 42°@-10 dB in 140-200 kHz <b>Narrow:</b> 25°@-10 dB in 180-240 kHz
Power Output [MAX] .....	500 Watts [RMS], 4000 Watts [Peak to Peak]



**NOTE:** Humminbird verifies maximum stated depth in saltwater conditions, but actual depth performance may vary due to transducer installation, water type, thermal layers, bottom composition, and slope.



**NOTE:** Product specifications and features are subject to change without notice.

## Control Head

Display Size (diagonal) .....	12.1 inches (307.3 mm)
Pixel Matrix .....	WXGA 800V x 1280H
Display Type .....	TFT Color
Backlight .....	LED
Communication .....	Bluetooth, NMEA 0183, NMEA 2000, Ethernet, Wireless
Power Input .....	10 to 20 VDC
Current Draw .....	3.0 A
IPX Rating .....	IPX7 Waterproof/Submersible @ 1 m for 30 minutes
Bluetooth Frequency Range .....	2402 to 2480 MHz
Bluetooth Output Power .....	10 dBm Typical

## Dual Spectrum 2D CHIRP Transducer

### XNT 9 HW T [includes built-in temperature probe]

Default Operating Frequency .....	150 kHz - 220 kHz
Depth Capability .....	1200 ft (366 m)
Area of Coverage .....	<b>Full:</b> 42°@-10 dB in 150-220 kHz <b>Wide:</b> 42°@-10 dB in 140-200 kHz <b>Narrow:</b> 25°@-10 dB in 180-240 kHz
Power Output [MAX] .....	500 Watts [RMS], 4000 Watts [Peak to Peak]



**NOTE:** Humminbird verifies maximum stated depth in saltwater conditions, but actual depth performance may vary due to transducer installation, water type, thermal layers, bottom composition, and slope.



**NOTE:** Product specifications and features are subject to change without notice.

## Control Head

Display Size (diagonal)	12.1 inches (307.3 mm)
Pixel Matrix	WXGA 800V x 1280H
Display Type	TFT Color
Backlight	LED
Communication	Bluetooth, NMEA 0183, NMEA 2000, Ethernet, Wireless
Power Input	10 to 20 VDC
Current Draw	3.0 A
IPX Rating	IPX7 Waterproof/Submersible @ 1 m for 30 minutes
Bluetooth Frequency Range	2402 to 2480 MHz
Bluetooth Output Power	10 dBm Typical

## CHIRP MEGA Down Imaging+ Transducer

XM 9 HW MDI T [includes built-in temperature probe]

### Down Imaging

Operating Frequency	455 kHz, 800 kHz, MEGA
Depth Capability	<b>455 kHz:</b> 400 ft (122 m) <b>800 kHz:</b> 125 ft (38m) <b>MEGA:</b> 200 ft (61 m)
Area of Coverage	<b>455 kHz:</b> 75° @ -10 dB in 455 kHz <b>800 kHz:</b> 45° @ -10 dB in 800 kHz <b>MEGA:</b> 75° @ -10 dB in MEGA kHz
Power Output [MAX]	500 Watts [RMS], 4000 Watts [Peak to Peak]

### Dual Spectrum

Default Operating Frequency	150 kHz - 220 kHz
Depth Capability	1200 ft (366 m)
Area of Coverage	<b>Full:</b> 42°@-10 dB in 150-220 kHz <b>Wide:</b> 42°@-10 dB in 140-200 kHz <b>Narrow:</b> 25°@-10 dB in 180-240 kHz
Power Output [MAX]	500 Watts [RMS], 4000 Watts [Peak to Peak]



**NOTE:** Humminbird verifies maximum stated depth in saltwater conditions, but actual depth performance may vary due to transducer installation, water type, thermal layers, bottom composition, and slope.



**NOTE:** Product specifications and features are subject to change without notice.

**Control Head**

Display Size (diagonal) .....	12.1 inches [307.3 mm]
Pixel Matrix .....	WXGA 800V x 1280H
Display Type .....	TFT Color
Backlight .....	LED
Communication .....	Bluetooth, NMEA 0183, NMEA 2000, Ethernet, Wireless
Power Input .....	10 to 20 VDC
Current Draw .....	3.0 A
IPX Rating .....	IPX7 Waterproof/Submersible @ 1 m for 30 minutes
Bluetooth Frequency Range .....	2402 to 2480 MHz
Bluetooth Output Power .....	10 dBm Typical

**CHIRP MEGA Side Imaging+ Transducer**

**XM 9 HW MSIT** [includes built-in temperature probe]

**Side Imaging**

Operating Frequency .....	455 kHz, 800 kHz, MEGA
Depth Capability .....	<b>455 kHz:</b> 800 ft [244 m] <b>800 kHz:</b> 250 ft [76 m] <b>MEGA:</b> 400 ft [122 m]
Area of Coverage .....	<b>455 kHz:</b> 86° @ -10 dB in 455 kHz <b>800 kHz:</b> 86° @ -10 dB in 800 kHz <b>MEGA:</b> 86° @ -10 dB in MEGA kHz
Power Output [MAX] .....	500 Watts [RMS], 4000 Watts [Peak to Peak]

**Down Imaging**

Operating Frequency .....	455 kHz, 800 kHz, MEGA
Depth Capability .....	<b>455 kHz:</b> 400 ft [122 m] <b>800 kHz:</b> 125 ft [38 m] <b>MEGA:</b> 200 ft [61 m]
Area of Coverage .....	<b>455 kHz:</b> 75° @ -10 dB in 455 kHz <b>800 kHz:</b> 45° @ -10 dB in 800 kHz <b>MEGA:</b> 75° @ -10 dB in MEGA kHz
Power Output [MAX] .....	500 Watts [RMS], 4000 Watts [Peak to Peak]

## Dual Spectrum

Default Operating Frequency .....	150 kHz - 220 kHz
Depth Capability .....	1200 ft (366 m)
Area of Coverage .....	<b>Full:</b> 42°@-10 dB in 150-220 kHz <b>Wide:</b> 42°@-10 dB in 140-200 kHz <b>Narrow:</b> 25°@-10 dB in 180-240 kHz
Power Output [MAX].....	500 Watts [RMS], 4000 Watts [Peak to Peak]



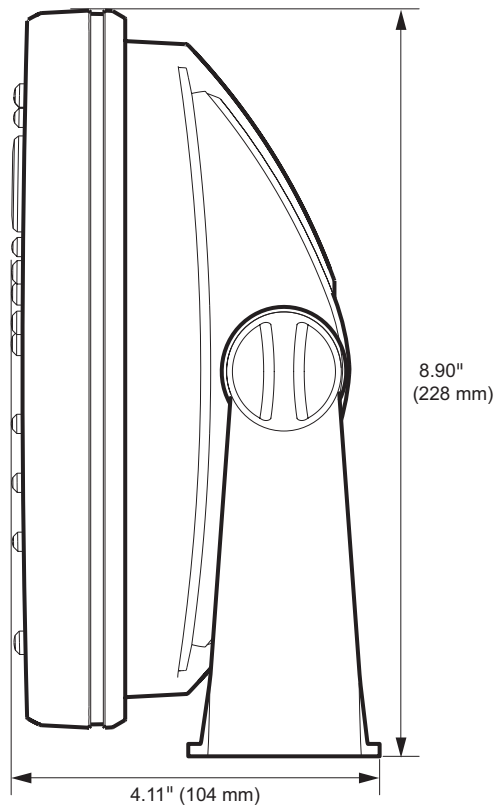
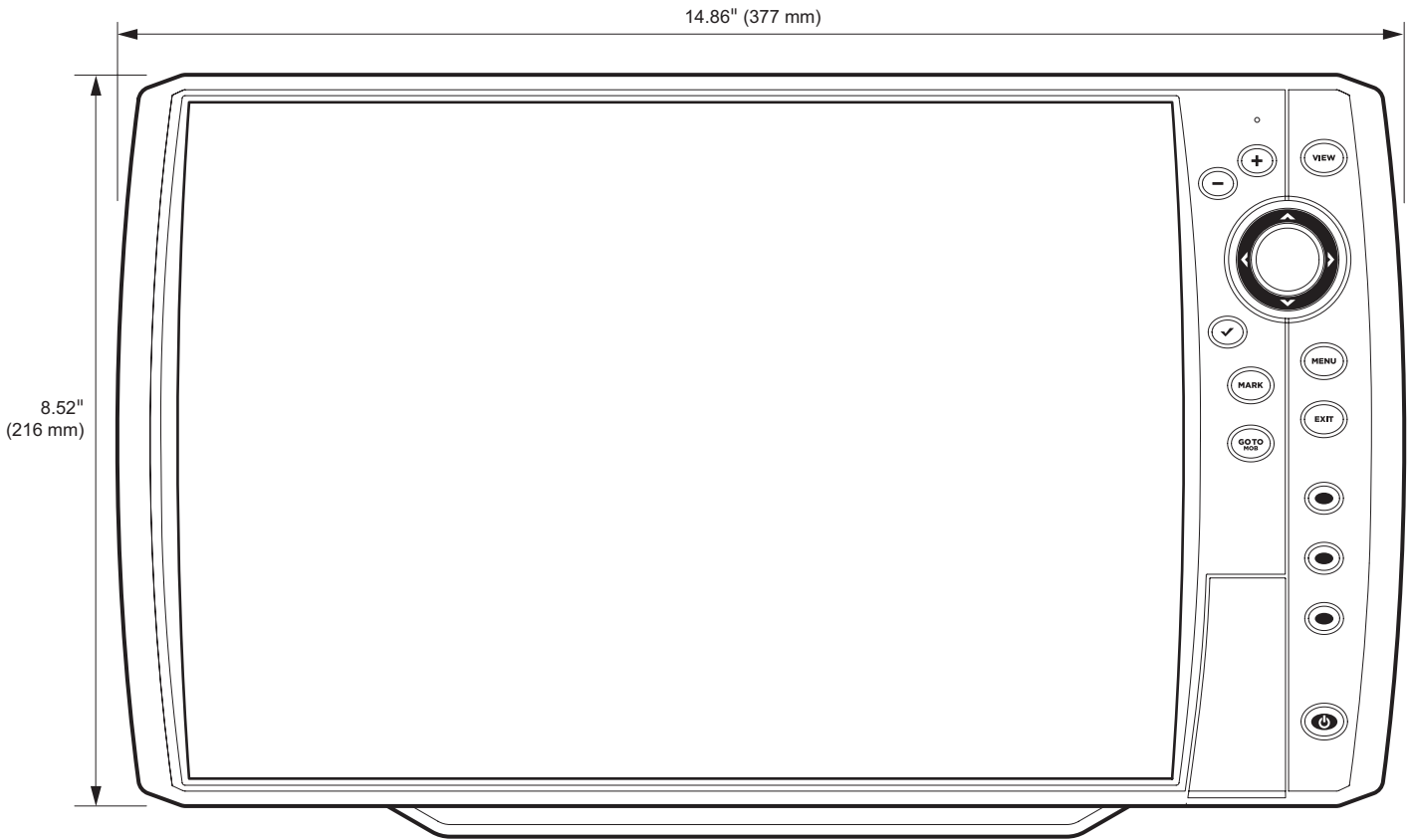
**NOTE:** Humminbird verifies maximum stated depth in saltwater conditions, but actual depth performance may vary due to transducer installation, water type, thermal layers, bottom composition, and slope.



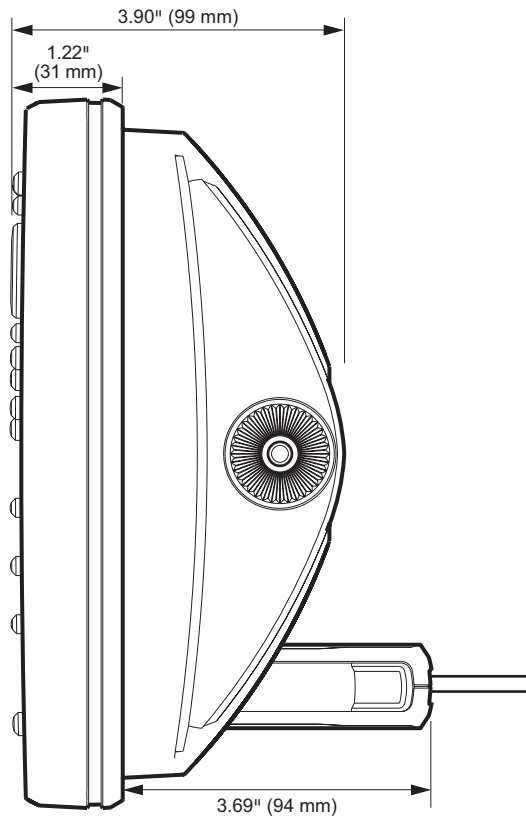
**NOTE:** Product specifications and features are subject to change without notice.



**HELIX 12 Gimbal Mount**



# HELIX 12 In-Dash Mount



## Control Head

Display Size (diagonal)	15.4 inches (391.2 mm)
Pixel Matrix	WXGA 800V x 1280H
Display Type	TFT Color
Backlight	LED
Communication	Bluetooth, NMEA 0183, NMEA 2000, Ethernet, Wireless
Power Input	10 to 20 VDC
Current Draw	3.5 A
IPX Rating	IPX7 Waterproof/Submersible @ 1 m for 30 minutes
Bluetooth Frequency Range	2402 to 2480 MHz
Bluetooth Output Power	10 dBm Typical

## CHIRP MEGA Down Imaging+ Transducer

XM 9 HW MDI T [includes built-in temperature probe]

### Down Imaging

Operating Frequency	455 kHz, 800 kHz, MEGA
Depth Capability	<b>455 kHz:</b> 400 ft (122 m) <b>800 kHz:</b> 125 ft (38m) <b>MEGA:</b> 200 ft (61 m)
Area of Coverage	<b>455 kHz:</b> 75° @ -10 dB in 455 kHz <b>800 kHz:</b> 45° @ -10 dB in 800 kHz <b>MEGA:</b> 75° @ -10 dB in MEGA kHz
Power Output [MAX]	500 Watts [RMS], 4000 Watts [Peak to Peak]

### Dual Spectrum

Default Operating Frequency	150 kHz - 220 kHz
Depth Capability	1200 ft (366 m)
Area of Coverage	<b>Full:</b> 42°@-10 dB in 150-220 kHz <b>Wide:</b> 42°@-10 dB in 140-200 kHz <b>Narrow:</b> 25°@-10 dB in 180-240 kHz
Power Output [MAX]	500 Watts [RMS], 4000 Watts [Peak to Peak]



**NOTE:** Humminbird verifies maximum stated depth in saltwater conditions, but actual depth performance may vary due to transducer installation, water type, thermal layers, bottom composition, and slope.



**NOTE:** Product specifications and features are subject to change without notice.

**Control Head**

Display Size (diagonal)	15.4 inches [391.2 mm]
Pixel Matrix	WXGA 800V x 1280H
Display Type	TFT Color
Backlight	LED
Communication	Blueooth, NMEA 0183, NMEA 2000, Ethernet, Wireless
Power Input	10 to 20 VDC
Current Draw	3.5 A
IPX Rating	IPX7 Waterproof/Submersible @ 1 m for 30 minutes
Bluetooth Frequency Range	2402 to 2480 MHz
Bluetooth Output Power	10 dBm Typical

**CHIRP MEGA Side Imaging+ Transducer**

**XM 9 HW MSIT** [includes built-in temperature probe]

**Side Imaging**

Operating Frequency	455 kHz, 800 kHz, MEGA
Depth Capability	<b>455 kHz:</b> 800 ft [244 m] <b>800 kHz:</b> 250 ft [76 m] <b>MEGA:</b> 400 ft [122 m]
Area of Coverage	<b>455 kHz:</b> 86° @ -10 dB in 455 kHz <b>800 kHz:</b> 86° @ -10 dB in 800 kHz <b>MEGA:</b> 86° @ -10 dB in MEGA kHz
Power Output [MAX]	500 Watts [RMS], 4000 Watts [Peak to Peak]

**Down Imaging**

Operating Frequency	455 kHz, 800 kHz, MEGA
Depth Capability	<b>455 kHz:</b> 400 ft [122 m] <b>800 kHz:</b> 125 ft [38 m] <b>MEGA:</b> 200 ft [61 m]
Area of Coverage	<b>455 kHz:</b> 75° @ -10 dB in 455 kHz <b>800 kHz:</b> 45° @ -10 dB in 800 kHz <b>MEGA:</b> 75° @ -10 dB in MEGA kHz
Power Output [MAX]	500 Watts [RMS], 4000 Watts [Peak to Peak]

## Dual Spectrum

Default Operating Frequency .....	150 kHz - 220 kHz
Depth Capability .....	1200 ft (366 m)
Area of Coverage .....	<b>Full:</b> 42°@-10 dB in 150-220 kHz <b>Wide:</b> 42°@-10 dB in 140-200 kHz <b>Narrow:</b> 25°@-10 dB in 180-240 kHz
Power Output [MAX].....	500 Watts [RMS], 4000 Watts [Peak to Peak]

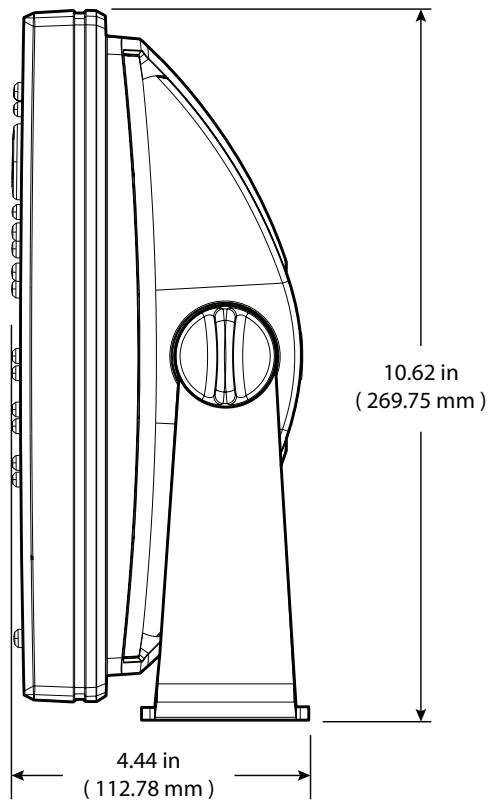
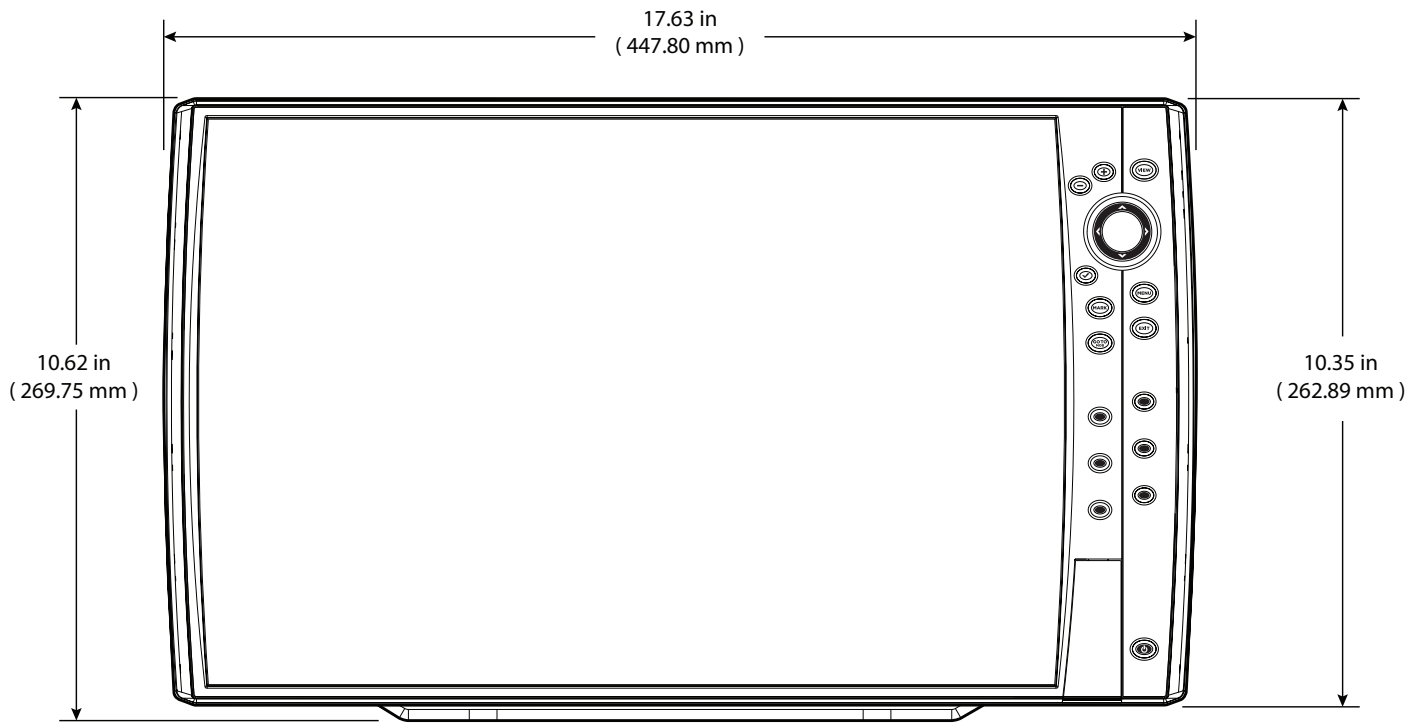


**NOTE:** Humminbird verifies maximum stated depth in saltwater conditions, but actual depth performance may vary due to transducer installation, water type, thermal layers, bottom composition, and slope.

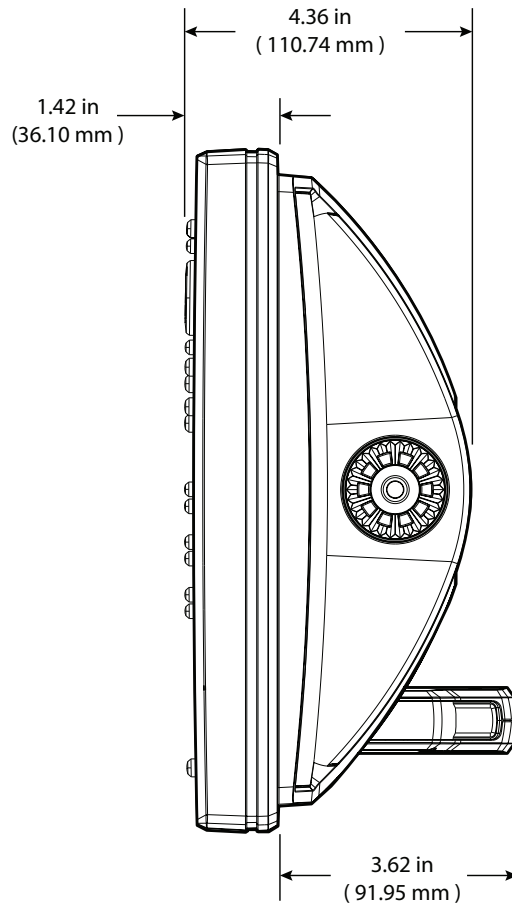
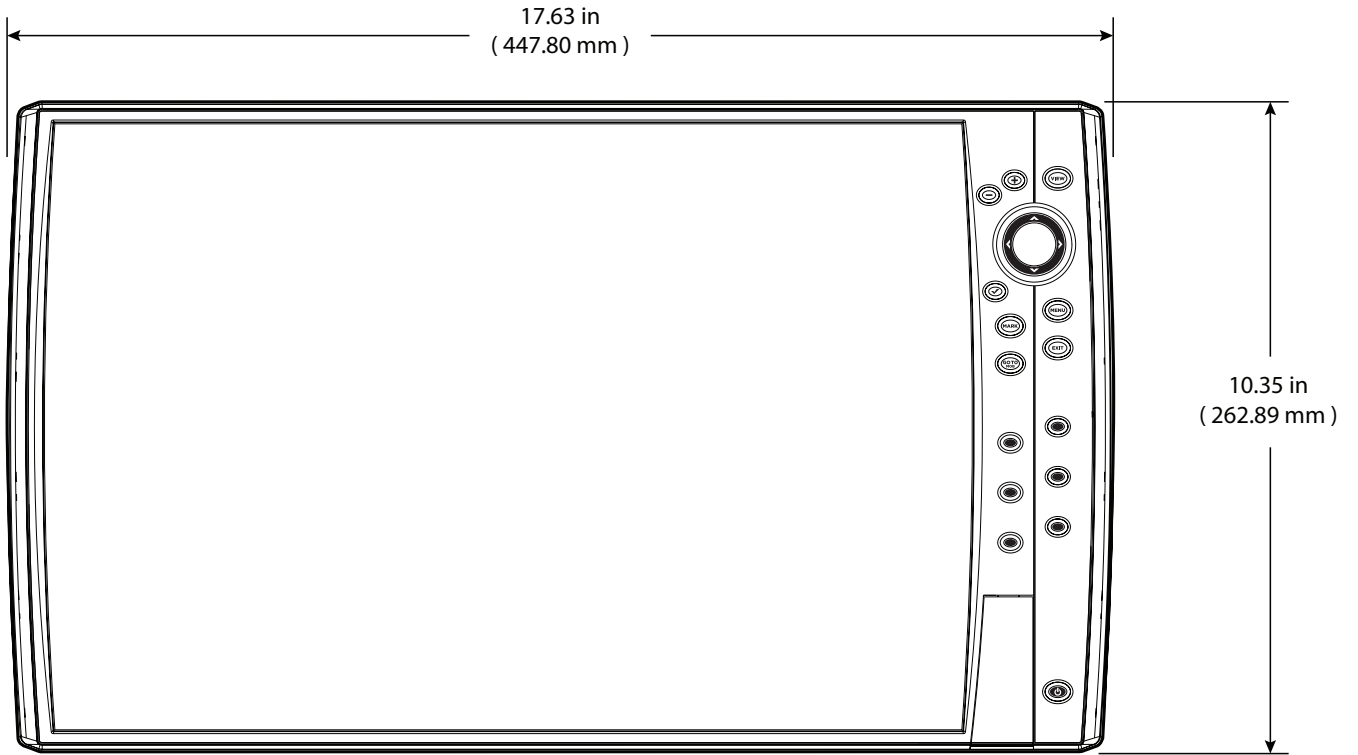


**NOTE:** Product specifications and features are subject to change without notice.

**HELIX 15 Gimbal Mount**



### HELIX 15 In-Dash Mount



Learn more about marine GPS navigation we have.