

# MEGA 360 UNIVERSAL INSTALLATION GUIDE

532750-2EN\_A



 **HUMMINBIRD®**

## Accessory Manual

## Thank You!

---

Thank you for choosing Humminbird®, the #1 name in marine electronics. Humminbird has built its reputation by designing and manufacturing top-quality, thoroughly reliable marine equipment. Your Humminbird accessory is designed for trouble-free use in even the harshest marine environment. In the unlikely event that your Humminbird does require repairs, we offer an exclusive Service Policy. For complete details, see the separate warranty card included with your unit. We encourage you to read this manual carefully in order to get the full benefit from all the features and applications of your Humminbird product.

 **WARNING!** This device should not be used as a navigational aid to prevent collision, grounding, boat damage, or personal injury. When the boat is moving, water depth may change too quickly to allow time for you to react. Always operate the boat at very slow speeds if you suspect shallow water or submerged objects.

 **WARNING!** The electronic chart in your Humminbird unit is an aid to navigation designed to facilitate the use of authorized government charts, not to replace them. Only official government charts and notices to mariners contain all of the current information needed for the safety of navigation, and the captain is responsible for their prudent use.

 **WARNING!** Humminbird is not responsible for the loss of data files (waypoints, routes, tracks, groups, recordings, etc.) that may occur due to direct or indirect damage to the unit's hardware or software. It is important to back up your control head's data files periodically. See your control head operations manual for details.

 **WARNING!** Disassembly and repair of this electronic unit should only be performed by authorized service personnel. Any modification of the serial number or attempt to repair the original equipment or accessories by unauthorized individuals will void the warranty.

 **NOTE:** The illustrations in this manual may not look the same as your product, but your unit will function in a similar way.

 **NOTE:** To purchase accessories for your control head



**NOTE:** The procedures and features described in this manual are subject to change without notice. This manual was written in English and may have been translated to another language. Humminbird is not responsible for incorrect translations or discrepancies between documents.



**NOTE:** Product specifications and features are subject to change without notice.



**NOTE:** Humminbird verifies maximum stated depth in saltwater conditions, however actual depth performance may vary due to transducer installation, water type, thermal layers, bottom composition, and slope.

**ATTENTION INTERNATIONAL CUSTOMERS:** Products sold in the U.S. are not intended for use in the international market. Humminbird international units provide international features and are designed to meet country and regional regulations. Languages, maps, time zones, units of measurement, and warranty are examples of features that are customized for Humminbird international units purchased through our authorized international distributors.

360 Imaging®, HELIX®, Humminbird®, MEGA 360 Imaging™, SOLIX®, and X-Press™ Menu are trademarked by or registered trademarks of Johnson Outdoors Marine Electronics, Inc.

© 2020 Johnson Outdoors Marine Electronics, Inc. All rights reserved.

# Table of Contents

---

<b>Introduction</b>	<b>1</b>
Compatibility.....	1
Supplies .....	3
<b>Update Software</b>	<b>4</b>
Software Requirements.....	4
Check the Current Software Version.....	4
Update Control Head Software with an SD Card .....	5
Update Accessory Software with an SD Card .....	6
Update Software with FishSmart.....	7
<b>Install the Universal Boat Mount (select models)</b>	<b>8</b>
1. Prepare for Installation.....	8
2. Install the Universal Boat Mount .....	9
3. Install the MEGA 360 Imaging Pod .....	11
4. Adjust the Pod Height and Install the Depth Collar .....	11
<b>Install the MEGA 360 ICE Adapter Base (optional accessory)</b>	<b>13</b>
<b>Route the Cables and Connect Power</b>	<b>14</b>
<b>Set Up the Control Head</b>	<b>17</b>
1. Confirm Connections .....	17
2. Set Up the Transducer .....	19
3. Test MEGA 360 Imaging on the Control Head.....	20
4. Add Offset Features to the MEGA 360 Imaging Display (optional).....	22
5. Set up the Network.....	23
<b>Power Off</b>	<b>24</b>
<b>Maintenance</b>	<b>25</b>
MEGA 360 Imaging Maintenance.....	25

---

## **Table of Contents**

---

Control Head Maintenance .....	25
Transducer Maintenance.....	26
<b>Troubleshooting</b>	<b>27</b>
Fishing System Doesn't Power Up .....	27
Fishing System Defaults to Simulator with a Transducer Attached .....	28
Finding the Cause of Noise .....	29
<b>Specifications</b>	<b>30</b>
<b>Contact Humminbird</b>	<b>32</b>

---



## Introduction

---

The MEGA 360 Imaging Universal has a 50" shaft length and can mount to almost any boat with the included GeigerTec aluminum bracket (select models) or a mounting bracket of your choice. This manual will guide you through the following installation requirements for the MEGA 360 Imaging transducer:

- Installing the MEGA 360 Universal Boat Mount (select models)
- Installing the MEGA 360 ICE Adapter Mount (separate purchase)
- Connecting to the Control Head and Power
- Testing the Installation
- Powering Off

Before proceeding with this installation, the Humminbird control head should be installed.

## Compatibility

---

**Control Heads:** MEGA 360 Imaging Universal is compatible with the following Humminbird control heads:

- SOLIX Series G2 models
- HELIX MEGA Imaging+ G3N models



**NOTE:** You must have a GPS heading sensor (compass) installed in order to use the MEGA 360 Imaging navigation features.



**NOTE:** MEGA 360 Imaging can be shared with all SOLIX, HELIX G3N, and HELIX G2N models over Ethernet.

**Transducers:** The MEGA 360 Imaging transducer is compatible with the following transducers:

- HW Dual Spectrum
- HW MEGA DI+
- HW MEGA DI+/MEGA SI+
- Built-in MEGA Imaging transducer on a Minn Kota trolling motor

**Cables:** Your MEGA 360 Imaging transducer comes with the cables required to connect directly to your Humminbird fish finder. This includes a 10' MEGA 360 power cable, a 10' SOLIX transducer cable, and a 10' HELIX transducer adapter cable.

However, depending on your Humminbird model and system configuration, you may choose to purchase a transducer splitter cable (y-cable) to connect the MEGA 360 to another compatible transducer, as shown below.

MEGA 360 compatible transducer splitter cables (y-cables)	MEGA 360 compatible transducers
<b>MEGA 360 7-pin Transducer Y-cable:</b> 9 M360 2DDI Y (720107-1)	HELIX Dual Spectrum (Type 9 / 7-pin) HELIX MDI+ (Type 9 / 7-pin) HELIX MDI+/MSI+ (Type 9 / 7-pin)
<b>MEGA 360 14-pin Transducer Y-cable:</b> 14 M360 2DDI Y (720108-1)	SOLIX Dual Spectrum SOLIX MDI+ SOLIX MDI+/MSI+ Built-in MEGA Imaging*
*If this cable is being used with a HELIX G3N with MEGA Side or Down Imaging+ and a Built-in MEGA imaging transducer, then the 720109-1 AD HELIX M360 adapter (included with the MEGA 360) must be attached between this y-cable and the HELIX unit.	

 **NOTE:** If a MEGA SI+ transducer is connected with one of these y-cables, the Humminbird unit will not be able to get SI data from the MEGA SI+ transducer – only HW and MEGA DI+ will be available. However, the user can get MEGA SI data from the MEGA 360 transducer.



**Accessories:** Additional recommended accessories include a Heading Sensor GPS Puck, a Heading Sensor GPS Adapter (SOLIX only), and transducer extension cables.

## Supplies

---

In addition to the hardware included with your accessory, you will need the following supplies:

- Cable ties for cable routing
- 1 Amp fuse
- Level
- Pencil
- Marine-grade silicone sealant (optional)
- Anti-seize tube

If you purchased a model with a GeigerTec mounting bracket included, the following supplies are recommended:

- Powered hand drill
- 1/4" drill bit
- Hex key
- Hex socket wrench or nut driver
- (6) stainless steel 1/4" - 20 bolts with a flat or oval head (select a length appropriate for your deck thickness)
- (6) stainless steel 1/4" fender washers (recommended)
- (6) stainless steel 1/4" - 20 nylon insert hex nuts

**Switch (optional):** If you do not have a main switch or fuse panel available on your boat to connect power, you will need to purchase a battery switch. See *Install the Trolling Motor Bracket, Section 3: Route the Cables and Connect Power* for more information.

## Update Software

---

Your control head model may need a software update to work with the MEGA 360 Imaging transducer. We recommend that you read the following section completely before starting any software updates.

### Software Requirements

---

- SOLIX G2 Series: 3.640 or higher
- HELIX G3N Series: 2.180 or higher

### Check the Current Software Version

---

It is helpful to review the software version number that is currently installed on the control head and each accessory.

#### SOLIX Series

1. Press the HOME key.
2. Select Settings.
3. Select Network > Network Info.
4. The Network Info dialog box shows a section for each device connected to the network. Scroll to each section to note the software version number listed.

#### HELIX Series

1. Press and hold the VIEW key.
2. Select System > System Status.
3. Confirm the Software Version listed.

## Update Control Head Software with an SD Card

---

You will need an SD or microSD card (depending on your control head model).



**WARNING!** Humminbird is not responsible for the loss of data files (waypoints, routes, tracks, groups, snapshots, recordings, etc.) that may occur due to direct or indirect damage to the unit's hardware or software. It is important to back up your control head data files periodically. See your control head operations manual for more information.

1. Before the control head software is updated or restored to system defaults, export your navigation data and copy your screen snapshots to an SD or microSD card. See your control head operations manual for instructions.
2. Install a formatted SD or microSD card into the computer card slot.
3. Go to click Support > Software Updates.
4. Click on your control head model. The available software updates are listed as downloads under each product. Confirm the file name is for your control head model.
  - Read the notices and instructions, and select Download.
  - Follow the on-screen prompts to save the software file to the SD or microSD card.
5. Repeat step 4 to download the software updates posted to each product.
6. Insert the SD or microSD card (with the software file) into the control head card slot.
7. Power on your Humminbird control head. Start **Normal** mode.
8. Follow the on-screen prompts to update the control head software.
9. When the software update is complete, remove the SD or microSD card from the control head card slot.
10. **Restart:** If you don't have any other software updates to install, power off the control head, and restart it.

## Update Accessory Software with an SD Card

---

You will need an SD or microSD card (depending on your control head model).

1. Install a formatted SD or microSD card into the computer card slot.
2. Go to and click Support > Software Updates.
3. Scroll down to Accessories and Mapping. The available software updates are listed as downloads under each accessory product. Confirm your control head model is listed in the software description.
  - Read the notices and instructions, and select Download.
  - Follow the on-screen prompts to save the software file to the SD or microSD card.
4. Insert the SD or microSD card (with the software file) into the control head card slot.
5. Power on your Humminbird control head. Start **Normal** mode.
6. **SOLIX:** Select the Files tool. From the Software Update tab, scroll to MEGA 360 on the Accessories list. Confirm that the most current software version is selected from the list, and select Install Now.  
**HELIX:** The software will be automatically detected. It may take up to two minutes for the software to be detected on the network, and the control head will display a dialog box to indicate that the update is in progress.
7. When the software update is complete, remove the SD or microSD card from the control head card slot.
8. **Restart:** If you don't have any other software updates to install, power off the control head, and restart it.

## Update Software with FishSmart

---

You can use the FishSmart App to download and push software updates directly to your Humminbird control head or accessory.



**NOTE:** Your control head must already be running software release 1.610 or higher for HELIX Series or 3.110 or higher for SOLIX Series to support this feature.



**NOTE:** You must first download the FishSmart App and pair your mobile device to your control head. See the *FishSmart User Manual* for more information.

1. Open the FishSmart App on your mobile device.
2. **Apple iOS:** Tap the System menu icon.  
**Google Android:** Tap the FishSmart main menu. Select system.
3. Tap Update next to the selected unit. The download progress is displayed on the screen.
4. Tap Transfer next to the selected unit once the download is complete.
5. Confirm the estimated transfer time.
6. Tap the checkbox to select where to upload the software update (internal storage, card slot 1, or card slot 2).



**NOTE:** For SOLIX Series control heads, you cannot download software updates to an SD or microSD card with LakeMaster charts saved to it.

7. Tap Transfer. The upload progress is displayed on the System menu in FishSmart and in the System Status view on the control head.
8. Follow the on-screen prompts on the control head to complete the software installation.

## **Install the Universal Boat Mount (select models)**

---

Use the following instructions to install the MEGA 360 Imaging transducer on your boat with the included GeigerTec mount (select models). If you are using a different universal mount, follow the instructions included with the mount. It is important to read the instructions completely and understand the mounting guidelines before you start the installation.

### **1. Prepare for Installation**

---

1. Determine where to mount the MEGA 360 Universal bracket.
  - Use a level to locate a suitable, flat area on the decking or gunwale. Confirm that the boat is level on the trailer, both from port to starboard and from bow to stern, by placing your level on the deck of the boat, first in one direction, then in the other.
2. Test run the transducer cable from the chosen mounting location on the boat to the control head. Test run the power cable from the chosen mounting location to the main switch or fuse panel. Determine whether you will need to purchase extension cables.

#### **It is important to consider the following:**

- The MEGA 360 Imaging transducer pod is powered separately from the control head. It must be connected to a switch where it can be powered on when the boat is underway and powered off when it is docked.
  - The cables should be routed through an established routing system on the boat, in an area with minimal interference, without sharp edges, obstacles, or obstructions that may damage the cables.
  - The cables will move as the mount adjusts for the MEGA 360 pod deployment and stowing, so it is important to allow enough length for movement.
3. When the transducer pod is deployed, it has the following installation requirements:
    - The transducer pod should not have anything obstructing the 'view' of the rotating beams. If possible, move anything to the sides and below the pod that might obstruct the sight line of the rotating beams.
    - The pod should be submerged below the keel and/or skeg.

## Unobstructed View

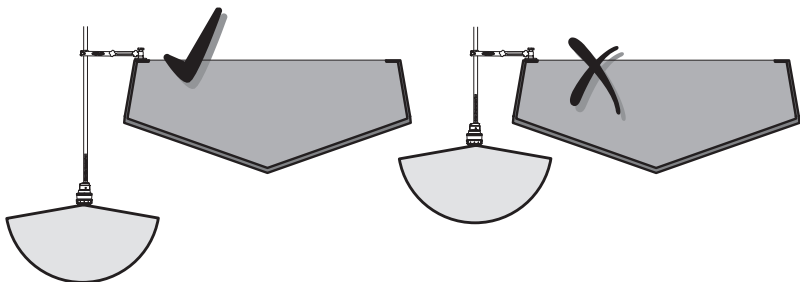

## 2. Install the Universal Boat Mount

Once you have determined the mounting location, use the following instructions to install the GeigerTec mount (included with select models):

1. Clean and dry the mounting surface.
2. Position the mounting plate in your selected location. Mark the six mounting bolt locations with a pencil.
3. Set the universal bracket aside, and use a 1/4" (6.35 mm) drill bit to drill the six marked holes.



**NOTE:** On fiberglass hulls, it is best to use progressively larger drill bits to reduce the chance of chipping or flaking the outer coating.



**NOTE:** If the mounting surface is thin or made of lightweight material, you may need to add reinforcing material below the mounting surface in order to support the universal bracket.

4. Place the universal bracket on the mounting surface and align the bolt holes with the drilled mounting holes. Apply anti-seize to the six 1/4"-20 bolts (not included) and insert them through the bolt holes and into the drilled mounting holes.



**NOTE:** Apply marine-grade silicone caulk or sealant (separate purchase required) to both bolts and drilled holes as needed to protect your boat from water damage.

5. From under the deck or gunwale, install the 1/4" fender washer and the 1/4"-20 nylon insert hex nut (not included) onto each screw. **Hand-tighten only!** Use an adjustable socket or wrench to hand-tighten the nuts until they contact the washers. Then tighten the nuts an additional 2 full revolutions. **Hand-tighten only!**

### Installing the Bolts

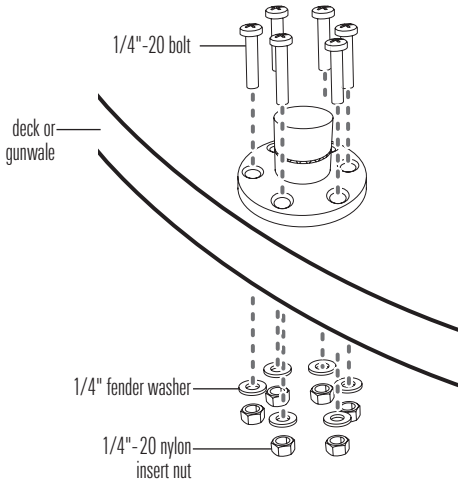



### 3. Install the MEGA 360 Imaging Pod

---

1. Route the cables and pod shaft up through the universal boat mount.



**NOTE:** It will be a tight fit over the rubber plug at the top of the shaft.

2. Tighten the knob so the pod shaft is fully secure and won't drop when it is deployed. **Hand-tighten only!**

### 4. Adjust the Pod Height and Install the Depth Collar

---

1. Loosen the bracket arms and rotate the bracket so that the MEGA 360 pod is positioned over the water.

#### Adjusting the Bracket

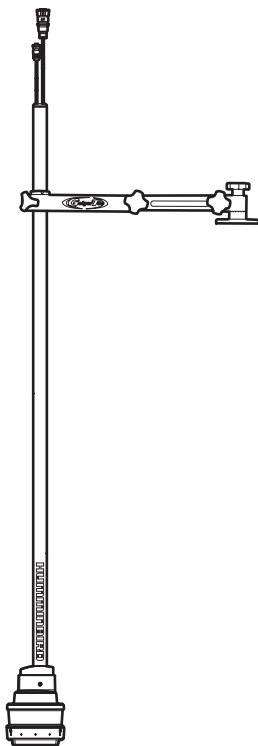

2. Adjust the pod shaft to the desired height. The MEGA 360 Imaging pod must be set below the keel and skeg, so that nothing is obstructing the 'view' of the rotating beams.
3. After you have established the pod height, slide the depth set collar through the cables and down the shaft. The depth set collar must be positioned at least 4" from the top of the shaft.
4. Use hex key to tighten the depth set collar. **Hand-tighten only!**
5. Turn the pod shaft until the rounded end of the transducer points in the direction of travel. The centerline of the transducer should be parallel with the centerline of the boat. See the illustration *Aligning the Transducer*.

### Aligning the Transducer

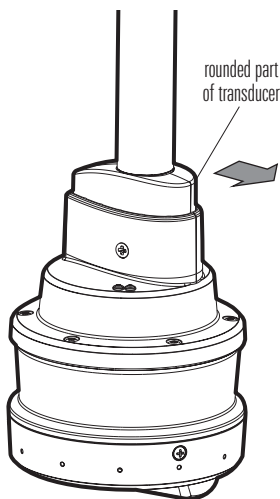

6. When the transducer position is finalized, hand-tighten the knobs equally and completely so the pod shaft is fully secure and won't drop or rotate during operation. **Hand-tighten only!**

## Install the MEGA 360 ICE Adapter Base (optional accessory)

The MEGA 360 ICE Adapter kit (sold separately) provides a mounting capability to use your MEGA 360 Imaging transducer on the ice. The adapter kit includes a handle for the MEGA 360, an ice adapter base, and an adjustable depth collar. Use the following instructions to ice mount the MEGA 360 Imaging transducer.

1. Slide the ice adapter base over the cables and pod shaft.
2. Slide the depth collar over the cables and pod shaft.
3. Tighten the depth collar to the desired height.



**NOTE:** The MEGA 360 pod must be submerged below the ice.

4. Slide the handle clamp over the cables and pod shaft.
5. Place the screw through the counterbore hole in the handle clamp and screw on the handle. Hand-tighten only.

**TIP:** Orient the handle so that it is parallel with the front of the transducer.



**CAUTION!** Handle the MEGA 360 pod with care. Store the MEGA 360 Imaging transducer in a safe place to prevent unnecessary impact.



**NOTE:** Compatible with HELIX 8, 9, and 10 G3N models.



**NOTE:** The MEGA 360 Imaging transducer must be used in Open Water mode. If you are switching between an ICE transducer and the MEGA 360 on a HELIX G3N, you will have to turn on Ice fishing mode to use the ICE transducer and turn off Ice fishing mode to use the MEGA 360 Imaging transducer.

### MEGA 360 ICE Adapter Kit

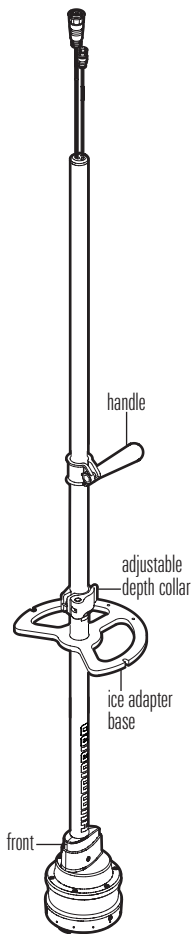

## Route the Cables and Connect Power

---

 **WARNING!** The power source must be turned off before you proceed with this installation.

1. Connect the power cable to the power cable connector on the pod shaft, and connect the transducer cable to the transducer cable connector on the pod shaft.

The connectors are keyed to prevent reversed installation, so be careful not to force the connectors. Hand-tighten the screw nuts on each connector.



**NOTE:** If you are connecting the MEGA 360 Imaging transducer and another compatible transducer to the same control head, you will need to purchase a transducer splitter cable (y-cable). See *Compatibility* for the list of cables, and visit our Web site

2. Route the cables to the chosen connection locations in *Section 1: Prepare for Installation*. Leave sufficient slack in the cables to allow for full movement of the MEGA 360 Imaging transducer, in both the deployed and stowed positions.



**CAUTION!** Do NOT mount the cables where the connectors could be submerged in water or flooded. If cables are installed in a splash-prone area, it may be helpful to apply dielectric grease to the inside of the connectors to prevent corrosion. Dielectric grease can be purchased separately from a general hardware or automotive store.



**NOTE:** The cables should be routed through an established routing system on the boat, in an area with minimal interference. Inspect the selected route carefully to ensure that there are no sharp edges, obstacles, or obstructions that may damage the cables.

3. **SOLIX:** Insert the other end of the transducer cable to the sonar port on the control head. Hand-tighten the screw nut.

### SOLIX Sonar-Temp Port

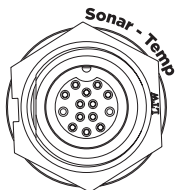

**HELIX:** Insert the transducer adapter cable to the transducer port on the HELIX control head.

### HELIX 8, 9, 10, 12 Cable Tray

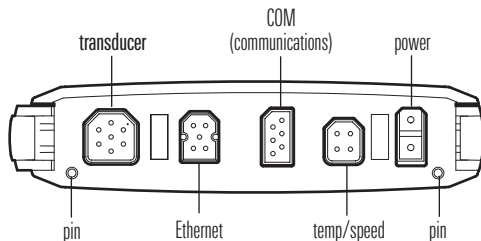

4. **Power:** Route the power cable to the main switch or fuse panel (usually located near the console). If you must connect to a battery, connect to a battery switch (not included).



**WARNING!** The MEGA 360 Imaging transducer should be connected to a main switch, fuse panel, or battery switch. Humminbird does not recommend connecting to a battery without a fuse and a switch.



**CAUTION!** Some boats have 24 or 36 Volt electric systems, but the MEGA 360 Imaging transducer **MUST** be connected to a 12 VDC power supply.



**NOTE:** A 10' (3 m) power cable is included to supply power to the MEGA 360 Imaging transducer. You may shorten or lengthen the cable using 18 gauge multi-stranded copper wire.



**NOTE:** Humminbird is not responsible for over-voltage or over-current failures. The MEGA 360 Imaging transducer must have adequate protection through the proper selection and installation of a 1 Amp fuse.

- 5a. **Main Switch/Fuse Panel:** If a fuse terminal is available, use crimp-on type electrical connectors (not included) that match the terminal on the fuse panel. Attach the black wire to ground (-), and the red wire to positive (+) 12 VDC power, and the drain/shield wire to the boat's chassis ground terminal. Install a 1 Amp fuse (not included) for protection of the unit.

### Connecting to the Fuse Panel

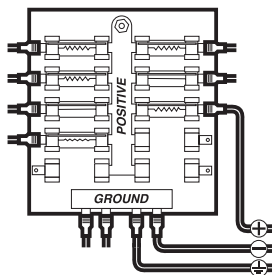

**OR**

- 5b. **Battery Switch:** Install the battery switch (not included) using the instructions provided with it. You will also need to obtain and install an inline fuse holder and a 1 Amp fuse (not included) for the protection of the unit. Attach the black wire to ground (-), the red wire to positive (+) 12 VDC power, and the drain/shield wire to the boat's chassis ground terminal.



**WARNING!** If you are unable to obtain a battery switch and are forced to connect the power cable directly to the battery, be aware that this will drain the battery. Humminbird does not recommend connecting to a battery without the appropriate fuse and a switch.

6. Secure the cables with cable ties along the route as needed for a clean assembly.

## Set Up the Control Head

When the control head detects the MEGA 360 Imaging transducer, it will select it automatically as the 360 sonar source. The related views and menus will be added to the system.





Use the following instructions to power on the control head and confirm the MEGA 360 Imaging transducer is detected by the unit.

 **CAUTION!** It is important to finish all installation connections before powering on the control head.

### 1. Confirm Connections

#### SOLIX Series

1. Turn on the power source from the main switch.
2. On the control head, press and hold the POWER key. **If you are powering on a control head in a multiple-control head Ethernet network**, power on the control head that is connected to the MEGA 360 Imaging transducer first.
3. Select Normal mode.
4. Review the status bar in the top, right corner of the screen to confirm the sensor status for the MEGA 360 Imaging transducer is connected.

MEGA 360 Status Icon	Icon Description
	<b>Connected/In Water/Pinging:</b> The MEGA 360 is connected, in the water, and pinging.
	<b>Connected/In Water/Not Pinging:</b> The MEGA 360 is connected and in the water, but it is not pinging.
	<b>Connected/Out of Water:</b> The MEGA 360 is connected, but the wet indicator is out of the water.
	<b>Connection Lost:</b> The connection to the MEGA 360 was lost.



**NOTE:** For additional system status, select Home > Settings > Network > System Info.

## MEGA 360 Imaging Transducer Connected (SOLIX)

The screenshot shows the 'Settings' menu with 'Network' selected. The 'System Info' screen displays the following details:

Field	Value	Field	Value
Model:	SOLIX 12 M5i+ G2	Serial Number:	190716030180
Unit Name:	190716030180	IP Address:	10.111.238.31
Software Version:	3.5200/30/19 17.2)	MAC Address:	2C:68:7D:E1:43:54
Network Name:	NET.190716030180		
Internal GPS:		Fix:	Fix
NMEA 0183 (1):		GPS Hdg/Pitch and Roll:	GPS Hdg/Pitch and Roll
NMEA 0183 (2):			
NMEA 2000:		Not Connected:	Not Connected
Transducer:		2D/DI/SL/MEGA 360:	2D/DI/SL/MEGA 360
MEGA 360:		V1.020; S/N: 19082901 - 1010:	V1.020; S/N: 19082901 - 1010
Sonar Temp:		Connected:	Connected
Speed (Paddle-Wheel):		Not Connected:	Not Connected
Aux Temp:		Not Connected:	Not Connected
Master Unit:		---	---

Annotations in the image:

- MEGA 360 icon on the status bar
- MEGA 360 Imaging listed as transducer

## HELIX Series

1. Turn on the power source from the main switch.
2. On the control head, press the POWER key. **If you are powering on a control head in a multiple-control head Ethernet network**, power on the control head that is connected to the MEGA 360 Imaging transducer first.
3. When the Title screen is displayed, press the MENU key.
4. Select Normal. Press the RIGHT Cursor key.
5. Press and hold the VIEW key. Select System > Accessory Test. Confirm that **MEGA 360 Imaging** is listed as Connected.



**NOTE:** If the Accessory Test is not displayed in the View Rotation, press the MENU key twice to open the Main Menu. Select the Views tab > Accessory Test. Change the setting to Visible.



## HELIX Accessory Test

		Accessory Test	
Temp.1 °F	72.2	360 Imaging	UNCONNECTED
		BT Talon	UNCONNECTED
N 34°06.248'		GPS	CONNECTED
	W 084°12.385'	i-Pilot	UNCONNECTED
Time	7:01	MEGA 360 Imaging v1.040 S/N: 19082901-0072	CONNECTED
		NMEA2K Gateway	UNCONNECTED
Speed mph	0.2	Radar	UNCONNECTED
		Remote	UNCONNECTED
VLT IV	13.4	Speed	UNCONNECTED
		Temperature	CONNECTED

MEGA 360 Imaging listed as Connected

## 2. Set Up the Transducer

### SOLIX Series

Your SOLIX control head will automatically detect the connected transducers. To review the selected sonar sources, open the Settings tool, and select CHIRP Sonar > Sonar Source.

### HELIX Series

Use the following instructions to select the connected transducer for your control head. These steps are only required the first time you set up your HELIX control head with a new transducer.

1. **Main Menu:** Press the Menu key twice.
2. Select the Sonar tab > Connected Transducer.
3. Press the RIGHT or LEFT Cursor keys to scroll through the compatible transducers. Select the transducer that is attached to the control head.

## Selecting the Connected Transducer (HELIX)

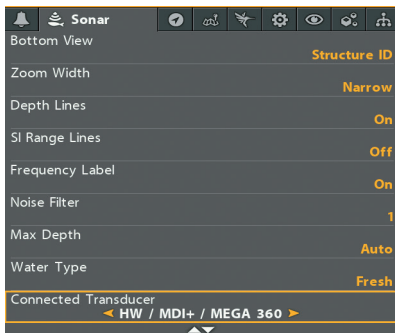

### 3. Test MEGA 360 Imaging on the Control Head

It is important to confirm that the MEGA 360 Imaging transducer is providing sonar returns to the display. The instructions in this section should be performed at trolling speeds in calm, open water, in a large area that is far from shallow water, boats, or other obstacles.

 **WARNING!** The pod should NOT be in the water during high speed travel. The pod should only be deployed when the boat is traveling at trolling speeds.

#### SOLIX Series

1. Tap the View widget icon in the side bar.



**NOTE:** Once the MEGA 360 has been detected the first time, the 360 Imaging view will display on the Favorite Views widget.

2. Tap 360 Imaging.
3. The sonar returns from the MEGA 360 scan will begin to display on the MEGA 360 View. Review the display for the following information and see the illustration *Reviewing the 360 View*.
  - **Bottom:** Confirm that the bottom is visible on-screen.
  - **Blocked Beams:** If the beams hit a hard surface, it will appear as bright white on the display. If the beams are blocked by any objects, move the objects if possible. You can also adjust the 360 Range on the X-Press Menu to see more or less detail on the display. In some cases, the trolling motor will appear on the display as a shadow.

4. **Stop Pinging:** When you are finished reviewing the operation, tap Ping Off from the 360 status bar.

## HELIX Series

1. Press and hold the VIEW key.
2. Select Sonar > 360 View.
3. The sonar returns from the MEGA 360 scan will begin to display on the MEGA 360 View. Review the display for the following information and see the illustration *Reviewing the 360 View*.
  - **Bottom:** Confirm that the bottom is visible on-screen.
  - **Blocked Beams:** If the beams hit a hard surface, it will appear as bright white on the display. If the beams are blocked by any objects, move the objects if possible. You can also adjust the 360 Range on the X-Press Menu to see more or less detail on the display. In some cases, the trolling motor will appear on the display as a shadow.
4. **Stop Pinging:** When you are finished reviewing the operation, press the MENU key once. Select 360 Pinging, and press the LEFT Cursor key.

### Reviewing the 360 View

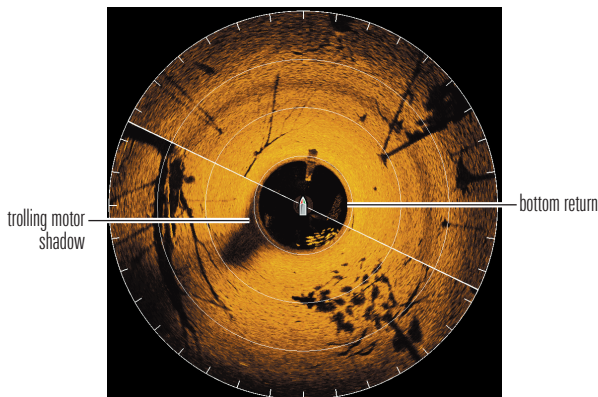

## 4. Add Offset Features to the MEGA 360 Imaging Display (optional)

The menu settings in this section are helpful for interpreting the position of objects on the 360 View. This feature is only available with a connected heading sensor (compass).

### Adjust the 360 Heading Offset

If the positions of objects on the MEGA 360 Imaging display are slightly different than what you observe in the environment around you, use 360 Heading Offset to correct the alignment of the MEGA 360 Imaging display.

For example, if there is an object in the water that is displayed on the left side of the MEGA 360 View, but you can see that it is straight ahead, you can use this setting to rotate the display.

 **NOTE:** This menu option should be adjusted while the MEGA 360 Imaging transducer is pinging.

### SOLIX Series

1. With a MEGA 360 View displayed on-screen, tap Sonar (360) in the status bar or press the MENU key once.
2. Select Sonar Options > Preferences > 360 Orientation.
3. Press and hold the slider under Adjustment to change the angle (red line).

### MEGA 360 Imaging Heading Offset (SOLIX)

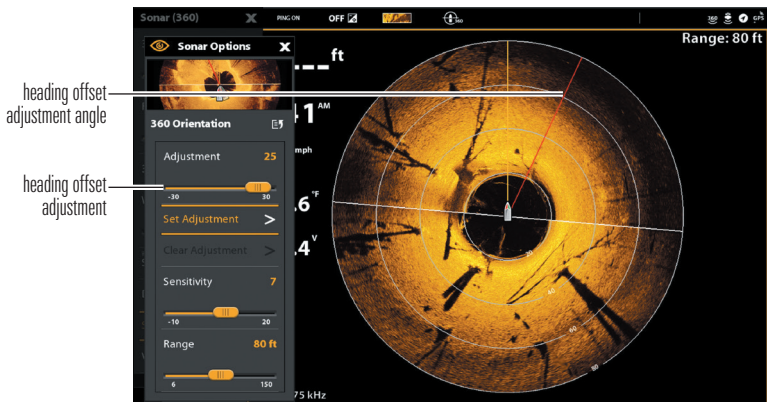

## HELIX Series

1. **Main Menu:** Press the MENU key twice.
2. Select the Accessories tab > MEGA 360 Settings > 360 Heading Offset.
3. Press the RIGHT or LEFT Cursor keys to change the angle (gray line), and press the CHECK/INFO key to confirm your setting. The zero point on the display is represented by a green line.

### MEGA 360 Imaging Heading Offset (HELIX)

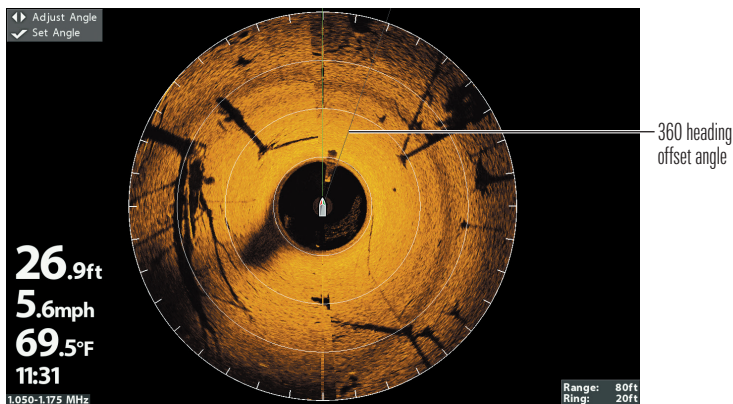

## 5. Set up the Network

After you have confirmed all connections, the MEGA 360 Imaging transducer is ready to use on the water. Proceed to your *MEGA 360 Operations Manual* to set up the depth source, temperature source, and additional sonar sources.

## Power Off

---

**⚠ WARNING!** When the boat is stored or at dock, the MEGA 360 Imaging transducer must be turned off to prevent draining the battery.

### Power Off the Control Head

1. **SOLIX Series:** During operation, tap the top, right corner of the status bar or press the POWER key, and select Power Off.  
**HELIX Series:** Press and hold the POWER key.

**⚠ CAUTION!** Turning off the control head will NOT power off the MEGA 360 Imaging transducer.

2. Turn off power on the main switch, breaker, or battery switch.  
Powering off the MEGA 360 Imaging transducer will be determined by the installation and power connection on your boat.

### Travel with the Pod Installed

The pod must not hit the deck, base, or any objects. This is critical during transport.

**For models with the GeigerTec mount:** Loosen the bracket arms and rotate the bracket so that the MEGA 360 pod is safely stowed along the deck or gunwale. Check the stability of the universal bracket after initial use and periodically thereafter to ensure that the knobs are tight.

#### Possible Stowage Configuration

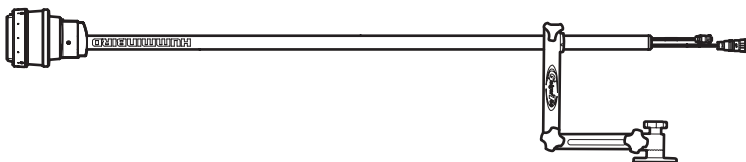

## Maintenance

---

Your Humminbird fishfinder is designed to provide years of trouble free operation with very little maintenance. Use the following procedures to ensure your Humminbird continues to deliver top performance.

### MEGA 360 Imaging Maintenance

---

Use the following information to maintain the installation of the MEGA 360 Imaging Transducer.

- Check the stability of the universal mount after initial use and periodically thereafter to ensure that the installation remains stable.
- If your boat will be in long-term storage, remove the MEGA 360 Imaging pod shaft from the bracket and store it in  $-40^{\circ}\text{F}$  to  $158^{\circ}\text{F}$  ( $-40^{\circ}\text{C}$  to  $70^{\circ}\text{C}$ ), dry conditions.

If the MEGA 360 pod becomes clogged with debris, you may remove the guard ring to clean around the pod.

1. Remove the 3 screws on the guard ring.
2. Pull the guard ring straight off the pod. The guard ring is keyed to fit over the screw holes, so do not twist it off.
3. Gently clean the MEGA 360 pod of debris. You can use mild soap and warm water.
4. Replace the guard ring and screws. **Hand-tighten only.**

### Control Head Maintenance

---

It is important to consider the following precautions when using your Humminbird control head:

- **Chemicals**, such as those found in bug spray and sunscreen, may cause permanent damage to the control head screen. Such damage is not covered by the warranty.
- **NEVER leave the control head in a closed car or trunk.** The high temperatures generated in hot weather can damage the electronics.

Use the following information to keep the control head and screen clean.

- **Screen:** To clean the control head screen, use a mild soap (such as a nonabrasive liquid hand soap) and warm water. Wipe the screen dry with a soft cloth. Be careful to avoid scratching the screen. If water spots remain, use a solution of water and vinegar.



**WARNING!** Do not use a chemical glass cleaner on the screen. Chemicals in the solution may cause cracking in the lens of the unit.



**NOTE:** Do not wipe the screen while dirt or grease is on the screen.

- **Control Head:** If the control head comes into contact with salt spray, wipe the affected surfaces with a cloth dampened with fresh water.

## Transducer Maintenance

---

Use the following information to maintain the transducer operation.

- If your boat remains in the water for long periods of time, algae and other marine growth can reduce the effectiveness of the transducer. Periodically clean the face of the transducer with a cloth dampened with fresh water.
- If your boat remains out of the water for a long period of time, it may take some time to wet the transducer when it is returned to the water. Small air bubbles can climb to the surface of the transducer and interfere with proper operation. These bubbles dissipate with time, or you can wipe the face of the transducer with your fingers after the transducer is in the water.



## Troubleshooting

---

Before contacting the Humminbird Technical Support, please read the following section. Taking the time to review these troubleshooting guidelines may allow you to solve a performance problem yourself, and therefore avoid sending your unit back for repair.

### Fishing System Doesn't Power Up

---

If your Fishing System doesn't power up, use the installation guide that is included with your Fishing System to confirm specific details, making sure that:

- the power cable is properly connected to the Fishing System control head,
- the power cable is wired correctly, with red to positive battery terminal and black to negative terminal or ground, and the drain/shield wire to the boat's chassis ground terminal,
- the fuse is operational, and
- the battery voltage of the power connector is at least 12 Volts.

Correct any known problems, including removing corrosion from the battery terminals or wiring, or actually replacing the battery if necessary.

## Fishing System Defaults to Simulator with a Transducer Attached

---

In addition to the MEGA 360 Imaging accessory transducer, you will have a standard Humminbird transducer connected to the control head. A connected and functioning transducer with built-in temperature will cause the newly-started Fishing System to go into Normal operating mode automatically. If, when you power up the Fishing System, it goes into Simulator mode automatically, even though a transducer is already connected, this means that the control head is not detecting the transducer. Perform the following troubleshooting tasks:

- Check the connections of all transducers that are connected to the control head or Ethernet network. See the transducer installation guide that was included with your Fishing System for connection information.
- Review this MEGA 360 Imaging installation guide to confirm that the transducer cable is connected correctly to the Fishing System. Reconnect if necessary, and power on the Fishing System again to see if this fixes the problem.
- Replace the non-functioning transducer with a known good transducer if available and power up the control head again.
- Check the transducer cable. Replace the transducer if the cable is damaged or corroded.

## Finding the Cause of Noise

---

Electrical noise usually affects the display with streaks or repetitive patterns on the view. One or more of the following sources can cause noise or interference:

Possible Source of Noise	Isolation
Other electronic devices	Turn off any nearby electronic devices to see if the problem goes away, then turn them on one at a time to see if the noise re-appears.
Other sonar devices	Turn off any nearby sonar devices to see if the problem goes away, then turn them on one at a time to see if the noise re-appears.
The boat's engine	To determine whether the boat's engine is the source of the noise, increase the RPMs while the boat is in neutral and stationary to see if the noise increases proportionately; if noise appears when you rev the engine, the problem could be the spark plugs, alternator, or tachometer wiring. Replace the spark plugs with resistor plugs, install an alternator filter, or route the control head power and transducer cables away from the engine wiring.

## Specifications

---

Operating Frequency.....	455 kHz / MEGA
Area of Coverage .....	455 kHz / MEGA: (2) 90° @ -10 dB
Power Output.....	500 Watts (RMS), 4000 Watts (Peak to Peak)
Power Requirement .....	10 to 18 VDC
Current Draw .....	0.5 A maximum
Operating Temperature.....	-4°F to 158°F (-20°C to 70°C)
Storage Temperature .....	-40°F to 158°F (-40°C to 70°C)



**NOTE:** Humminbird verifies maximum stated depth in saltwater conditions, but actual depth performance may vary due to transducer installation, water type, thermal layers, bottom composition and slope.



**NOTE:** Product specifications and features are subject to change without notice.

**ROHS STATEMENT:** Product designed and intended as a fixed installation or part of a system in a vessel may be considered beyond the scope of Directive 2002/95/EC of the European Parliament and of the Council of 27 January 2003 on the restriction of the use of certain hazardous substances in electrical and electronic equipment.

**ENVIRONMENTAL COMPLIANCE STATEMENT:** It is the intention of Johnson Outdoors Marine Electronics, Inc. to be a responsible corporate citizen, operating in compliance with known and applicable environmental regulations, and a good neighbor in the communities where we make or sell our products.

**WEEE DIRECTIVE:** EU Directive 2002/96/EC "Waste of Electrical and Electronic Equipment Directive (WEEE)" impacts most distributors, sellers, and manufacturers of consumer electronics in the European Union. The WEEE Directive requires the producer of consumer electronics to take responsibility for the management of waste from their products to achieve environmentally responsible disposal during the product life cycle.

WEEE compliance may not be required in your location for electrical & electronic equipment (EEE), nor may it be required for EEE designed and intended as fixed or temporary installation in transportation vehicles such as automobiles, aircraft, and boats. In some European Union member states, these vehicles are considered outside of the scope of the Directive, and EEE for those applications can be considered excluded from the WEEE Directive requirement.



This symbol (WEEE wheelie bin) on product indicates the product must not be disposed of with other household refuse. It must be disposed of and collected for recycling and recovery of waste EEE. Johnson Outdoors Marine Electronics, Inc. will mark all EEE products in accordance with the WEEE Directive. It is our goal to comply in the collection, treatment, recovery, and environmentally sound disposal of those products; however, these requirements do vary within European Union member states. For more information about where you should dispose of your waste equipment for recycling and recovery and/or your European Union member state requirements, please contact your dealer or distributor from which your product was purchased.