



## INSTRUCTION MANUAL

VHF MARINE TRANSCEIVERS

**IC-M330**  
**IC-M330E**  
**IC-M330G**  
**IC-M330GE**



Icom Inc.

Thank you for choosing this Icom product.

This product is designed and built with Icom's state of the art technology and craftsmanship. With proper care, this product should provide you with years of trouble-free operation.

---

## IMPORTANT

---

**READ ALL INSTRUCTIONS** carefully and completely before using the transceiver.

**SAVE THIS INSTRUCTION MANUAL** — This instruction manual contains important operating instructions for the IC-M330, IC-M330E, IC-M330G, IC-M330GE.

This instruction manual includes some functions which are usable only when they are preset by your dealer. Ask your dealer for details.

Icom is not responsible for the destruction, damage to, or performance of any Icom or non-Icom equipment, if the malfunction is because of:

- Force majeure, including, but not limited to, fires, earthquakes, storms, floods, lightning, other natural disasters, disturbances, riots, war, or radioactive contamination.
- The use of Icom transceivers with any equipment that is not manufactured or approved by Icom.

---

## FEATURES

---

● **Easy user interface**

The transceiver is equipped with a screen for easy readability and easy-to-use user interface.

● **Dualwatch and Tri-watch functions**

Convenient functions that enable you to monitor the Distress channel (Ch 16) while receiving on another channel of your choice (Dualwatch), or while receiving on another channel of your choice, and the Call channel (Tri-watch).

\* May not be usable, depending on the transceiver version.

● **DSC function**

The transceiver has the DSC functions for distress alert transmission and reception, as well as the general DSC calls such as Individual calls, All ships calls, Group calls, and so on.

---

## EXPLICIT DEFINITIONS

---

WORD	DEFINITION
<b>⚠ WARNING!</b>	Personal injury, fire hazard or electric shock may occur.
<b>CAUTION</b>	Equipment damage may occur.
<b>NOTE</b>	If disregarded, inconvenience only. No risk of personal injury, fire or electric shock.

---

# IN CASE OF EMERGENCY

---

If your vessel requires assistance, contact other vessels and the Coast Guard by sending a distress call on Channel 16.

## **USING CHANNEL 16 DISTRESS CALL PROCEDURE**

1. "MAYDAY MAYDAY MAYDAY."
2. "THIS IS ....." (name of vessel).
3. Say your call sign or other indication of the vessel (AND your 9 digit DSC ID, if you have one).
4. "LOCATED AT ....." (your position).
5. State the nature of the distress and assistance required.
6. Give any other information which might facilitate the rescue.

Or, transmit your Distress call using Digital Selective Calling (DSC) on Channel 70.

## **USING DIGITAL SELECTIVE CALLING (Ch 70) DISTRESS CALL PROCEDURE**

1. While lifting up the key cover, hold down [DISTRESS] for 3 seconds until you hear 3 short beeps and then one long beep.
2. Wait for an acknowledgment on Channel 70 from a coast station.
  - After the acknowledgement is received, Channel 16 is automatically selected.
3. Hold down [PTT], then transmit the appropriate information as listed to the left.

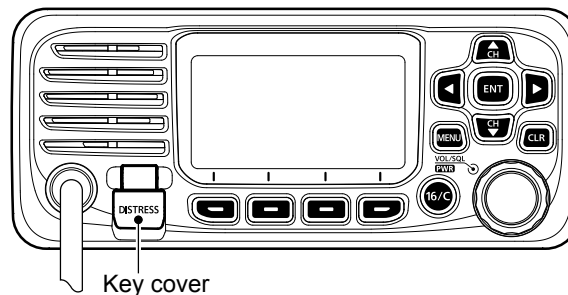

---

## RADIO OPERATION WARNING

---



Icom requires the radio operator to meet the FCC Requirements for Radio Frequency Exposure. An omnidirectional antenna with gain not greater than 9 dBi must be mounted a minimum of 5 meters (measured from the lowest point of the antenna) vertically above the main deck and all possible personnel. This is the minimum safe separation distance estimated to meet all RF exposure compliance requirements. This 5 meter distance is based on the FCC Safe Maximum Permissible Exposure (MPE) distance of 3 meters added to the height of an adult (2 meters) and is appropriate for all vessels.

For watercraft without suitable structures, the antenna must be mounted so as to maintain a minimum of 1 meter vertically between the antenna, (measured from the lowest point of the antenna), to the heads of all persons AND all persons must stay outside of the 3 meter MPE radius.

Do not transmit with radio and antenna when persons are within the MPE radius of the antenna, unless such persons (such as driver or radio operator) are shielded from antenna field by a grounded metallic barrier. The MPE Radius is the minimum distance from the antenna axis that person should maintain in order to avoid RF exposure higher than the allowable MPE level set by FCC.

**FAILURE TO OBSERVE THESE LIMITS MAY ALLOW THOSE WITHIN THE MPE RADIUS TO EXPERIENCE RF RADIATION ABSORPTION WHICH EXCEEDS THE FCC MAXIMUM PERMISSIBLE EXPOSURE (MPE) LIMIT. IT IS THE RESPONSIBILITY OF THE RADIO OPERATOR TO ENSURE THAT THE MAXIMUM PERMISSIBLE EXPOSURE LIMITS ARE OBSERVED AT ALL TIMES DURING RADIO TRANSMISSION. THE RADIO OPERATOR IS TO ENSURE THAT NO BYSTANDERS COME WITHIN THE RADIUS OF THE MAXIMUM PERMISSIBLE EXPOSURE LIMITS.**

**Determining MPE Radius  
THE MAXIMUM PERMISSIBLE EXPOSURE (MPE) RADIUS HAS BEEN ESTIMATED TO BE A RADIUS OF ABOUT 3M PER OET BULLETIN 65 OF THE FCC. THIS ESTIMATE IS MADE ASSUMING THE MAXIMUM POWER OF THE RADIO AND ANTENNAS WITH A MAXIMUM GAIN OF 9dBi ARE USED FOR A SHIP MOUNTED SYSTEM.**



---

## FCC INFORMATION

---

This equipment has been tested and found to comply with the limits for a Class A digital device, pursuant to part 15 of the FCC Rules. These limits are designed to provide reasonable protection against harmful interference when the equipment is operated in a commercial environment. This equipment generates, uses, and can radiate radio frequency energy and, if not installed and used in accordance with the instruction manual, may cause harmful interference to radio communications.

Operation of this equipment in a residential area is likely to cause harmful interference in which case the user will be required to correct the interference at his own expense.

**CAUTION:** Changes or modifications to this transceiver, not expressly approved by Icom Inc., could void your authority to operate this transceiver under FCC regulations.

---

## NOTE

---

**A WARNING STICKER is supplied with the USA version transceiver.**

To comply with FCC regulations, this sticker must be affixed in such a location as to be readily seen from the operating controls of the radio as in the diagram below. Make sure the chosen location is clean and dry before applying the sticker.

EXAMPLE:



---

# PRECAUTIONS

---

⚠ **WARNING! NEVER** connect the transceiver directly to an AC outlet. This may cause a fire or an electric shock.

⚠ **WARNING! NEVER** connect the transceiver to a power source of more than 16 V DC such as a 24 V battery. This connection could cause a fire or damage the transceiver.

⚠ **WARNING! NEVER** reverse the DC power cable polarity when connecting to a power source. This could damage the transceiver.

⚠ **WARNING! NEVER** cut the DC power cable between the DC connector on the transceiver's rear panel and the fuse holder. If an incorrect connection is made after cutting, the transceiver may be damaged.

⚠ **WARNING! NEVER** operate the transceiver during a lightning storm. It may result in an electric shock, cause a fire or damage the transceiver. Always disconnect the power source and antenna before a storm.

⚠ **WARNING! NEVER** place the transceiver where normal operation of the vessel may be hindered, or where it could cause bodily injury.

**CAUTION: DO NOT** install the transceiver and/or microphone less than 1 meter from the vessel's magnetic navigation compass.

**CAUTION: DO NOT** place or leave the transceiver in areas with temperatures below  $-20^{\circ}\text{C}$   $\sim$   $+60^{\circ}\text{C}$  ( $-4^{\circ}\text{F}$   $\sim$   $+140^{\circ}\text{F}$ ), or in areas subject to direct sunlight, such as a dashboard.

**CAUTION: DO NOT** use harsh solvents such as Benzine or alcohol to clean the transceiver, as they will damage the transceiver's surfaces. If the transceiver becomes dusty or dirty, wipe it clean with a soft, dry cloth.

**BE CAREFUL!** The transceiver's rear panel will become hot when transmitting continuously for long periods of time.

**NOTE:** Place the transceiver in a secure place to avoid inadvertent use by unauthorized persons.

**BE CAREFUL!** The transceiver meets IPX7 requirements for waterproof protection\*. However, once the transceiver or microphone has been dropped, or the waterproof seal is cracked or damaged, waterproof protection cannot be guaranteed because of possible damage to the case or the waterproof seal.

\* Except for the DC power connector, NMEA In/Out leads and AF Out leads.

---

## RECOMMENDATION

---

**CLEAN THE TRANSCEIVER AND MICROPHONE THOROUGHLY WITH FRESH WATER** after exposure to saltwater, and dry it before operating. Otherwise, the transceiver's keys, switches and controllers may become unusable, due to salt crystallization.

**NOTE:** If the transceiver's waterproof protection appears defective, carefully clean it with a soft, wet (fresh water) cloth, then, dry it before operating.

The transceiver may lose its waterproof protection if the case or connector cover is cracked or broken, or the transceiver has been dropped.

Contact your Icom distributor or your dealer for advice.

---

## INSTALLATION NOTE

---

### **Installation:**

The installation of this equipment should be made in such a manner as to respect the EC recommended electromagnetic field exposure limits. (1999/519/EC)

The maximum RF power available from this device is 25 watts. The antenna should be installed as high as possible for maximum efficiency and the installation height should be at least 1.76 meters above any accessible position. In the case where an antenna cannot be installed at a reasonable height, then the transmitter should neither be continuously operated for long periods if any person is within a distance of 1.76 meters of the antenna, nor operated at all if any person is touching the antenna.

It is recommended that antenna of a maximum gain of 3 dB is used. If higher gain antenna are required then please contact your Icom distributor for revised installation recommendations.

### **Operation:**

The exposure to RF electromagnetic field is only applicable when this device is transmitting. This exposure is naturally reduced due to the nature of alternating periods of receiving and transmitting. Keep your transmissions to the minimum necessary.

---

## KEY ICON DESCRIPTION

---

The keys are described in this manual as followings:

- The keys that have an icon on them are described with the characters “[ ]”.  
Example: [MENU], [CLR]
- The software keys are described with the icon such as **ENT** or **DISTRESS**. The function of the keys are shown at the bottom of the display. Push the key below the desired function.
- You can use the following keys on the Menu screen.

<b>FUNCTION</b>	<b>ACTION</b>
<b>Select</b>	Rotate [DIAL], or push [▼] or [▲].
<b>Enter</b>	Push [ENT], <b>ENT</b> , or [DIAL].
<b>Go to the next tree level</b>	Push [ENT], <b>ENT</b> , [DIAL], or [▶].
<b>Go back to the previous tree level</b>	Push [CLR], <b>BACK</b> , or [◀].
<b>Cancel</b>	Push [CLR].
<b>Exit</b>	Push [MENU] or <b>EXIT</b> .

## ◇ **Priorities**

- Read all rules and regulations pertaining to priorities and keep an up-to-date copy handy. Safety and distress calls take priority over all others.
- You must monitor Channel 16 when you are not operating on another channel.
- False or fraudulent distress calls are prohibited under law.

## ◇ **Privacy**

- Information overheard but not intended for you cannot lawfully be used in any way.
- Indecent or profane language is prohibited.

## ◇ **Radio licenses**

### **(1) SHIP STATION LICENSE**

You must have a current radio station license before using the transceiver. It is unlawful to operate a ship station which is not licensed.

Inquire through your dealer or the appropriate government agency for a Ship-Radiotelephone license application. This government-issued license states the call sign which is your craft's identification for radio purposes.

### **(2) OPERATOR'S LICENSE**

A Restricted Radiotelephone Operator Permit is the license most often held by small vessel radio operators when a radio is not required for safety purposes.

The Restricted Radiotelephone Operator Permit must be posted or kept with the operator. Only a licensed radio operator may operate a transceiver.

However, non-licensed individuals may talk over a transceiver if a licensed operator starts, supervises, ends the call and makes the necessary log entries.

A current copy of the applicable government rules and regulations is only required to be on hand for vessels in which a radio telephone is compulsory. However, even if you are not required to have these on hand it is your responsibility to be thoroughly acquainted with all pertinent rules and regulations.

## ■ Front Panel

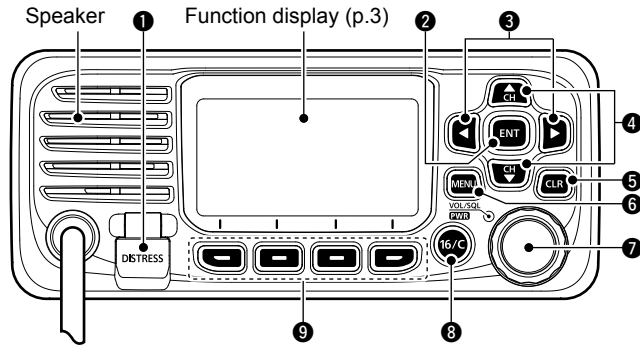

### 1 DISTRESS KEY [DISTRESS]

Hold down for 3 seconds to transmit a Distress call.

### 2 ENTER KEY [ENT]

Push to set the entered data, selected item, and so on.

### 3 LEFT/RIGHT KEYS [◀]/[▶]

- Push to scroll the Software Key functions. (pp. 4 ~ 5)
- Push to select a character or number in the entry mode.

### 4 UP/DOWN KEYS [▲]/[▼]

- Push to select an operating channel, Menu items, Menu settings, and so on. (pp. 4)
- Push to select a character or number in the entry mode. (pp. 7, 8, 14, 18, 20)

### 5 CLEAR KEY [CLR]

Push to cancel the entered data, or to return to the previous screen.

### 6 MENU KEY [MENU]

Push to display or close the Menu screen.

### 7 POWER/VOLUME/SQUELCH SWITCH [PWR/VOL/SQL]

(Also described as [DIAL] in this manual.)

- Hold down for 1 second to turn the transceiver ON or OFF.
- Rotate or push once to display the volume level setting screen, then rotate to adjust the volume level. (p. 11)
- Push twice to display the squelch level setting screen, then rotate to adjust the squelch level. (p. 11)
- On the Menu screen, rotate to select an item. (p. 47)
- In the entry mode, push to select a character or number, or rotate to move the cursor. (p. 7, 14, 18, 20)

### 8 CHANNEL 16/CALL CHANNEL KEY [16/C]

- Push to select Channel 16. (p. 9)
- Hold down for 1 second to select the Call channel. (p. 9)

### 9 SOFTWARE KEYS (pp.4 ~ 5)

Scroll the key functions pushing [◀] or [▶], then push either of the 4 software keys to select the function displayed at the bottom of the display.

## ■ Function Display

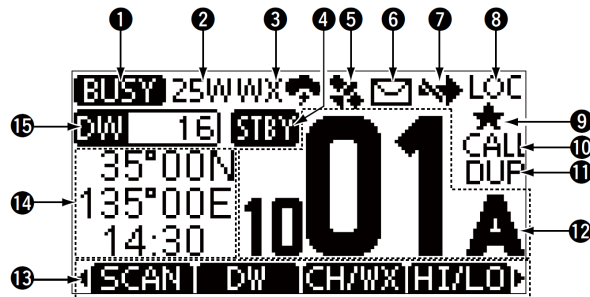

### 1 STATUS INDICATOR (p. 13)

- TX: Displayed while transmitting.
- BUSY: Displayed while receiving, or the squelch is open.

### 2 POWER INDICATOR (p. 5, 6)

- 25W: High power
- 1W: Low power

### 3 CHANNEL GROUP INDICATOR (p. 10)

Displays the selected channel group, INT (International), USA, CAN (Canada), ATIS, WX (Weather channel), or DSC.

- ① The selectable channels differ, depending on the version or presetting.
- ① When the WX-Alert is set to ON, is displayed instead of "WX." (For only the USA version)

### 4 STATUS INDICATOR

- STBY: Standby mode.
- RT: Displayed when the channel is changed while receiving or transmitting a signal.

### 5 GPS ICON

- Displayed when valid GPS position data is received.
- Blinks while no position data is received.

### 6 MAIL ICON (p. 38)

- Displayed when there is an unread DSC message.
- Blinks until one of the called messages is read.

### 7 CHANNEL SWITCH ICON (p. 42)

Displayed when the "CH Auto SW" is set to "Ignore after 10 sec." or "Manual."

### 8 LOCAL INDICATOR

Displayed when the RF Attenuation is ON. (For only the USA and Australian versions)

### 9 FAVORITE CHANNEL (p. 16)

Displayed when a Favorite channel is selected.

### 10 CALL CHANNEL (p. 9)

Displayed when a Call channel is selected.

### 11 DUPLEX CHANNEL

Displayed when a Duplex channel is selected.

### 12 OPERATING CHANNEL NUMBER (pp. 9, 14)

- Displays the selected operating channel number.
- ① "A" or "B" is displayed when a simplex channel is selected.



## 2 PANEL DESCRIPTION

### 13 SOFTWARE KEYS FUNCTION DISPLAY (p. 4 ~ 5)

The functions of each key are displayed.

See “Software keys” on the next page for details.

### 14 POSITION/TIME READOUTS

Readouts the current position and time when valid GPS data is received, or when manually entered.

#### **Received GPS data:**

- “NO POS NO TIME” is displayed if no GPS data has been received, and then a warning message is displayed for 2 minutes after turning ON the transceiver.
- “??” blinks if no GPS data is received for 30 seconds after receiving valid GPS data, and then “??” and a warning message are displayed after 10 minutes.
- A warning message is displayed if no GPS data is received for 4 hours after receiving valid GPS data.

#### **Manually entered GPS data:**

- A manually entered GPS data is valid for 23.5 hours, and then a warning message is displayed.

### 15 SCAN INDICATOR

- “SCAN” or “SCAN 16” is displayed while scanning. (p. 16)
- “DW” or “TW” and the watched channel number is displayed while using the Dualwatch or Tri-watch function. (p. 17)

## ■ Software keys

Various often-used functions are assigned to the software keys for easy access. The functions’ icons are displayed above the software keys, as shown below.

### ◇ Using the software keys

Selecting a software key function

Push [◀] or [▶] to slide through the selectable functions that are assigned to the software keys.

Push the software key under the function’s icon to select the function.

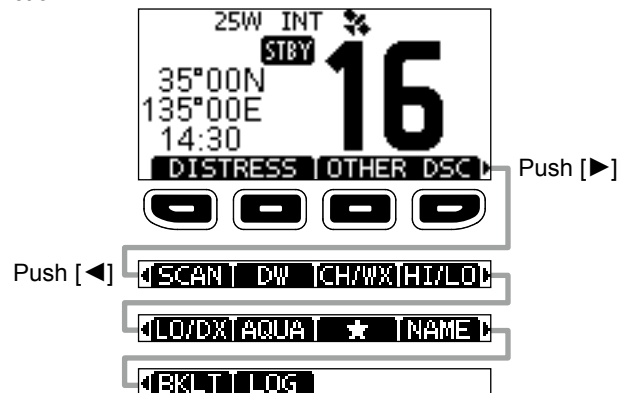

**NOTE:** The displayed icons or their order may differ, depending on the transceiver version or the presetting. When the MMSI code is not set, the software keys for DSC function are not displayed.

◇ **Software key functions**

**Distress Call** **DISTRESS** (p. 22)

Push to display the “Distress” screen to select the nature of distress, then to make a call.

- ① **DTRS** is displayed in the Multiple-task mode. (For only the USA version)

*NEVER MAKE A DISTRESS CALL IF YOUR SHIP OR A PERSON IS NOT IN AN EMERGENCY. A DISTRESS CALL SHOULD BE MADE ONLY WHEN IMMEDIATE HELP IS NEEDED.*

**Other DSC** **OTHER DSC** (p. 24)

Push to compose an Individual call, Group call, All Ships call or a Test call.

- ① **OTH** is displayed in the Multiple-task mode. (For only the USA version)

**Task** **TASK** (For only the USA version) (p. 40)

Displayed only in the Multiple-task mode. Push to display the task list.

**Scan** **SCAN** (p. 15)

Push to start or stop a Normal or Priority scan.

**Dualwatch/Tri-watch** **DW / TW** (p. 17)

Push to start or stop Dualwatch or Tri-watch.

**High/Low** **HI/LO** (p. 6)

Push to set the output power to high or low.

- ① Some channels are set to only low power.

**Channel/Weather channel** **CHWX** (p. 10)

Push to select regular channels or Weather channels.

- ① The Weather channel is for only the USA and Australian versions. **CHAN** is displayed for other versions.
- ① While the Call channel or Channel 16 is displayed, push this key to return to the regular channel mode.

**Low** **LO/DX** (For only the USA and Australian versions.)

Push to turn the Attenuator ON or OFF.

**AquaQuake** **AQUA** (p. 14)

Hold down to turn ON the AquaQuake function to clear water from the speaker grill.

**Favorite channel** **★** (p. 16)

Push to set or release the displayed channel as a Favorite channel.

**Channel Name** **NAME** (p. 14)

Push to edit the name of the displayed channel.

**Backlight** **BKLT** (p. 12)

Push to display the backlight brightness adjustment screen.

- ① While in the adjustment mode, push [**▲**]/[**▼**][**◀**]/[**▶**] or rotate [DIAL] to adjust the brightness of the display and keys' backlight to between 1 and 7, or OFF.

**LOG** **LOG** (p. 38)

Push to display the received call log or distress message log.

## 2 PANEL DESCRIPTION

### ■ Microphone

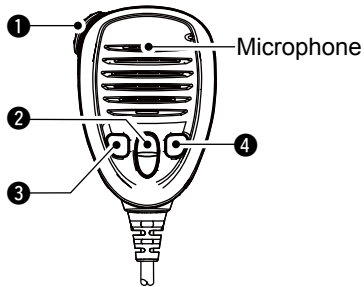

- ❶ **PTT SWITCH [PTT]** (p. 13)  
Hold down to transmit, release to receive.
- ❷ **UP/DOWN KEYS [▲]/[▼]** (p. 9)  
Push to change the channel.
  - ❶ When the “FAV on MIC” item is set to “ON,” you can select Favorite channels, change scanning direction or manually resume a scan. (p. 51)
- ❸ **TRANSMIT POWER KEY [HI/LO]**
  - Push to set the power level to high or low.
    - ❶ Some channels are set to only low power.
  - While holding down this key, turn ON the transceiver to turn the Microphone Lock function ON or OFF. (p. 13)
- ❹ **CHANNEL 16/CALL CHANNEL KEY [16/C]** (p. 9)
  - Push to select Channel 16.
  - Hold down for 1 second to select the Call channel.
    - The “CALL” icon is displayed.

## ■ Entering the MMSI code

The Maritime Mobile Service Identity (MMSI: DSC self ID) code consists of 9 digits. You can only enter the code when turning ON the transceiver for the first time.

**This initial code entry can be done only once. After entering, it can be changed only by your dealer or distributor. If your MMSI code has already been entered, doing the steps below is not necessary.**

1. Hold down [DIAL] to turn ON the transceiver.
  - Three short beeps sound, and “Push [ENT] to Register your MMSI” is displayed.
2. Push [ENT] to start entering the MMSI code.
  - The “MMSI Input” screen is displayed.
  - ① Push [CLR] twice to skip the entry.
    - If you skip the entry, you cannot make a DSC call. To enter the code after skipping, turn OFF the power, and then turn it ON again.
3. Enter the MMSI code.



**TIP:**

- Select a number using [◀] and [▶].
- Push [ENT] to enter the selected number.
- Select “←” or “→,” or rotate [DIAL] to move the cursor.

4. Repeat step 3 to enter all 9 digits.
5. Push the software key below **FIN** to set the entered code.
  - The “Confirmation” screen is displayed.
6. Enter your MMSI code again to confirm.

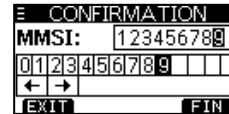

7. Push **FIN** to set the entered code.
  - When your MMSI code is successfully entered, “MMSI Successfully Registered” is briefly displayed, and then enters the operating screen.

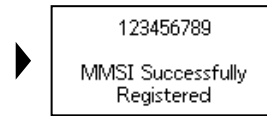
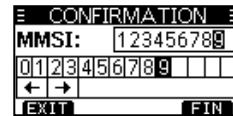

- ① Your MMSI code is also displayed on the operating screen.

**NOTE:** Except for the USA and Australian versions, the ATIS ID is also required to be set. See the next page and set it.

## 3 PREPARATIONS

### ■ Entering the ATIS ID (For Dutch and German versions)

The Automatic Transmitter Identification System (ATIS) ID consists of 10 digits. You can enter the ID in the “ATIS ID Input” item on the Menu screen.

**This ID entering can be done only once. After entering, it can be changed only by your dealer or distributor. If your ATIS ID has already been entered, doing the steps below is not necessary.**

1. Push [MENU].
  - The Menu screen is displayed.
2. Push [▲] or [▼], or rotate [DIAL] to select “ATIS ID Input,” then push [ENT] to start entering.
  - The “ATIS ID Input” screen is displayed.
3. Enter your ATIS ID.

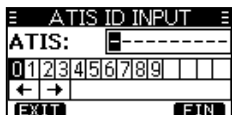

#### TIP:

- Select a number using [◀] and [▶].
- Push [ENT] to enter the selected number.
- Select “←” or “→,” or rotate [DIAL] to move the cursor.

4. Repeat step 3 to enter all 10 digits.
5. Push **FIN** to set the entered ID.
  - The “Confirmation” screen is displayed.
6. Enter your ATIS ID again to confirm.

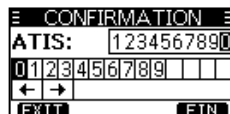

7. Push **FIN** to set the entered ID.
  - When your ATIS ID is successfully entered, the screen displays “ATIS ID Successfully Registered,” and then enters the operating screen.

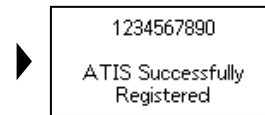
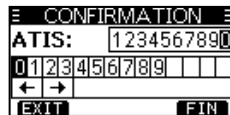

- ① You can check the ATIS ID in “Radio Info” on the Menu screen.

## ■ Selecting a channel

### ◇ Regular Channel

You can select a channel by pushing [▲] or [▼].

### ◇ Channel 16

Channel 16 is the distress and safety channel. It is used to establish the initial contact with a station, and for emergency communications. Channel 16 is monitored during both Dualwatch and Tri-watch. While in the standby mode, you must monitor Channel 16.

- Push [16/C] to select Channel 16.

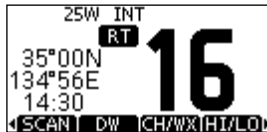

- ① To return to the previously selected channel, push [◀] or [▶] to display **CHAN** or **CH/WX**, then push the software key below **CHAN** or **CH/WX**.

### ◇ Call channel

Each Channel Group has separate leisure-use Call channels. The Call channel is scanned during Tri-watch. The Call channels can be selected and used to store your most often used channels in each Channel Group, for quick recall.

- ① See page 12 for details on setting the Call channel.

- Hold down [16/C] for 1 second to select the Call channel.
- The Call channel number and “CALL” are displayed.

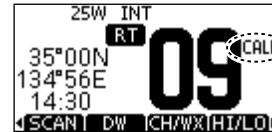

- ① To return to the previously selected channel, push [◀] or [▶] to display **CHAN** or **CH/WX**, then push the software key below **CHAN** or **CH/WX**.

## 4 BASIC OPERATION

### ◇ Selecting a Channel Group

Channel Groups are preset into your transceiver. You can select a Channel Group for USA, International, Canadian, DSC, and ATIS, depending on the transceiver version.

Version	Preset Channel Group				
	USA	INT	CAN	DSC	ATIS
USA	✓	✓	✓		
UK	✓	✓			
European		✓			
Dutch		✓			✓
German		✓		✓	✓
Chinese	✓	✓	✓		
Australian	✓	✓			

1. Push [MENU].
  - The Menu screen is displayed.
2. Push [▲], [▼] or rotate [DIAL] to select “Radio Settings,” then push [ENT].
  - The “RADIO SETTINGS” screen is displayed.
3. Push [▲], [▼] or rotate [DIAL] to select “Channel Group,” then push [ENT].
  - The “CHANNEL GROUP” screen is displayed.
4. Push [▲], [▼] or rotate [DIAL] to select a Channel Group, and then push [ENT].
  - ① Push **EXIT** to exit the Menu screen.
  - ① The selected Channel Group's icon is displayed on the operating screen.

### ◇ Weather channels and Weather Alert

The USA and Australian version transceivers have 10 preset Weather channels. The transceivers are capable\* of monitoring broadcasts from the National Oceanographic and Atmospheric Administration (NOAA). The transceiver automatically detects a Weather alert tone on the selected weather channel, or while scanning.

\*When used within range of the broadcasts.

#### Selecting a Weather channel

1. Push **CHWX**.
  - “WX” is displayed on the operating screen instead of the Channel Group.

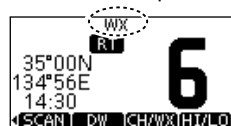

2. Push [▲] or [▼] to select a Weather channel.

### Setting the Weather Alert

① See page 51 for details on the Weather Alert function.

1. Push [MENU].
2. Push [▲], [▼], or rotate [DIAL] to select “Radio Settings,” and then push [ENT].
  - The “RADIO SETTINGS” screen is displayed.
3. Select “WX Alert,” and then push [ENT].
  - The “WX Alert” screen is displayed.



4. Select “On with Scan” or “On.”
  - “” is displayed next to the weather channel icon.



## ■ Adjusting the volume level

- Rotate [DIAL] to adjust the audio volume level.



- ① If no key is pushed for 5 seconds, the screen automatically closes.

## ■ Adjusting the squelch level

Squelch enables the audio to be heard only while receiving a signal that is stronger than the set level. A higher level blocks weak signals, so that you can receive only stronger signals. A lower level enables you to hear weak signals.

1. Push [DIAL] twice.
  - The squelch level adjustment screen is displayed.



2. Rotate [DIAL] to adjust the squelch level.
  - ① If no key is pushed for 5 seconds, the screen automatically closes.



## 4 BASIC OPERATION

### ■ Adjusting the backlight or the display contrast

1. Display the “BACKLIGHT” or “CONTRAST” screen.

[MENU] > Configuration > **Backlight**

[MENU] > Configuration > **Display Contrast**

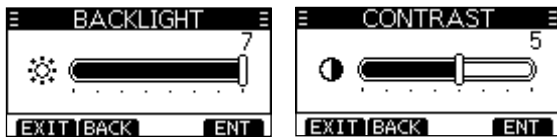

2. Push [▲], [▼], or rotate [DIAL] to adjust, then push [ENT] to set.  
① Push **EXIT** to exit the Menu screen.

### ■ Setting the Call channel

By default, a Call channel is set in each Channel Group. You can set your most often-used channel as your Call channel in each Channel Group for quick recall.

1. Display the “CALL CHANNEL” screen.

[MENU] > Radio Settings > **Call Channel**



2. Push [▲], [▼], or rotate [DIAL] to select the channel.
3. Push [ENT] to set the selected channel as the Call channel.  
① Push **EXIT** to exit the Menu screen.

## ■ Receiving and transmitting

**CAUTION:** Transmitting without an antenna may damage the transceiver.

1. Push [▲] or [▼] to select the channel to call on.
  - The channel number and name are briefly displayed.  
(Only when “CH Close-up” is ON.)
  - ① You cannot transmit on Channel 70.
  - ① **BUSY** is displayed while receiving a signal.
  - ① You can also select the channel with [▲] or [▼] on the microphone. (Only when “FAV on MIC” is OFF.)
2. Hold down [PTT] on the microphone to transmit.
  - **TX** is displayed while transmitting.
3. Release [PTT] to receive.

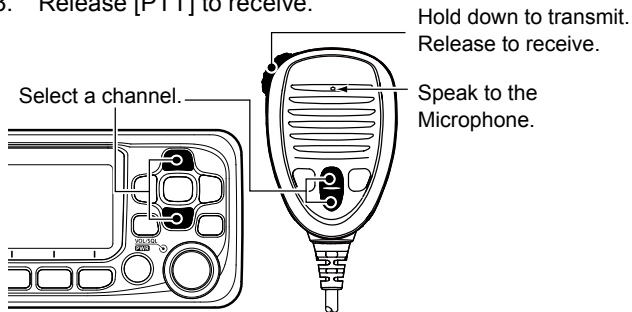

**TIP:** To maximize the readability of your transmitted signal, pause for a second after holding down [PTT] and hold the microphone 5 to 10 cm (2 to 4 inches) from your mouth, and then speak at your normal voice level.

**NOTE:**

- The Time-out Timer function cuts OFF transmission after 5 minutes of continuously transmitting, to prevent prolonged transmission.

## ■ Microphone Lock function

The Lock function electronically locks all keys on the microphone except [PTT] to prevent accidental channel changes or functions access.

1. Hold down [DIAL] for 1 second to turn OFF the transceiver.
2. While holding down [HI/LO] on the microphone, hold down [DIAL] for 1 second to turn the Lock function ON or OFF.

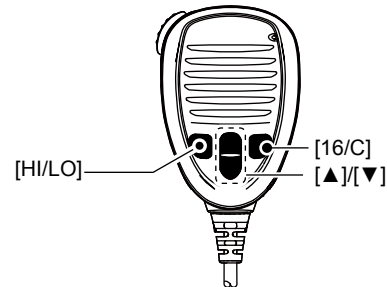

## 4 BASIC OPERATION

### ■ AquaQuake Water Draining function

Water in the speaker grill may muffle the sound coming from the speaker. The AquaQuake Water Draining function removes water from the speaker grill by vibrating the speaker cone.

**CAUTION: DO NOT** use the AquaQuake Water Draining function when an external speaker is connected.

1. Push [◀] or [▶] to display **AQUA**.
2. Hold down **AQUA** to turn ON the function.
  - A low frequency vibration beep sounds to drain the water, regardless of the volume level setting.



- ① This function is activated for a maximum of 10 seconds, even if you continue to hold down **AQUA**.
3. Release the key to turn OFF the function.

### ■ Editing a channel name

You can edit the name of each operating channel and weather channel, using numbers, uppercase letters, symbols, and a space. This enables easy recognition of the channels or stations. All VHF marine channels are set with default names.

1. Push [▲] or [▼] to select the channel to edit.
2. Push [◀] or [▶] to display **NAME**.
  - ① You cannot edit a channel name during Dualwatch, Tri-watch, or a scan.
3. Push **NAME**.
  - The “CHANNEL NAME” screen is displayed.



4. Edit the channel name.

#### TIP:

- Select **!\$?** to enter symbols, and select **123** to enter numbers and letters.
- Select characters or a space using [▲]/[▼]/[◀]/[▶].
- Select “◀” or “▶” to scroll.
- Push [ENT] to enter the selected character.
- Select “←” or “→,” or rotate [DIAL] to move the cursor.
- Push **EXIT** to cancel editing.

5. Push **FIN** to save the edited name and return to the operating screen.

## ■ Scan types

You can find ongoing calls by scanning the Favorite channels.

### Before starting a scan, you need to:

- Set the channels that you want to scan as Favorite channels. (p. 16)
  - ① Only the Favorite channels are scanned.
- Set the scan type to “Priority Scan” or “Normal Scan” on the “Radio Settings” screen. (p. 50)

### Normal Scan

The Normal Scan sequentially searches through all Favorite channels. However, Channel 16 is not checked unless it is set as a Favorite channel.

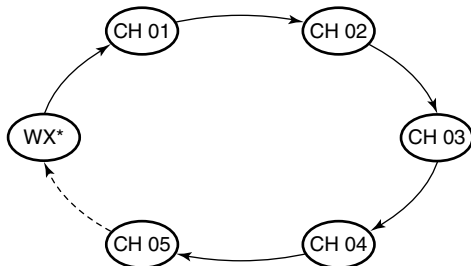

\*For USA and Australian versions. When the Weather Alert function is ON, the previously selected Weather channel is also scanned.

### Priority Scan

The Priority Scan sequentially searches through all Favorite channels, while also monitoring Channel 16.

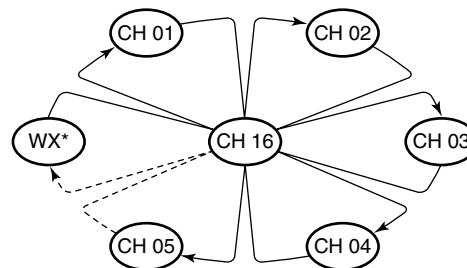

\*For USA and Australian versions. When the Weather Alert function is ON, the previously selected Weather channel is also scanned.

### When a signal is received:

#### On Channel 16

The scan pauses until the signal disappears.

#### On a channel other than Channel 16

The scan becomes Dualwatch until the signal disappears.

## 5 SCAN OPERATION (Except for the Dutch Version)

### ■ Setting Favorite channels

You can quickly recall often-used channels by setting them as Favorite channels. You can set Favorite channels in each Channel Group.

1. Select a Channel Group on the Menu screen. (p. 10)
2. Push [▲] or [▼] to select the channel.
3. Push [◀] or [▶] to display **★**.
4. Push **★**.
  - The selected channel is set as a Favorite channel, and “★” is displayed.
  - ① To cancel the setting, push **★** again.

**TIP:** You can set all channels as Favorite channels, clear all settings, or reset to the default. By default, some channels are preset as Favorite channels. The preset channels differ, depending on the transceiver version.

### ■ Starting a scan

1. Select a Channel Group on the Menu screen. (p. 10)
2. Push [◀] or [▶] to display **SCAN**.
3. Push **SCAN**.
  - The scan starts.
  - “**SCAN**” is displayed during a Normal Scan, and “**SCAN 16**” is displayed during a Priority Scan.
  - “**SCAN**” and “**BUSY**” are displayed when a signal is received.
  - ① When a signal is received, the scan pauses until it disappears, or resumes after 5 seconds, depending on the Scan Timer setting in “Radio Settings.”
  - ① A beep sounds and “16” blinks when a signal is received on Channel 16 during a Priority scan.
4. To stop the scan, push **SCAN**.

**TIP:** To properly receive signals, be sure to adjust the squelch to a suitable level.

**Example:** Starting a Normal Scan.

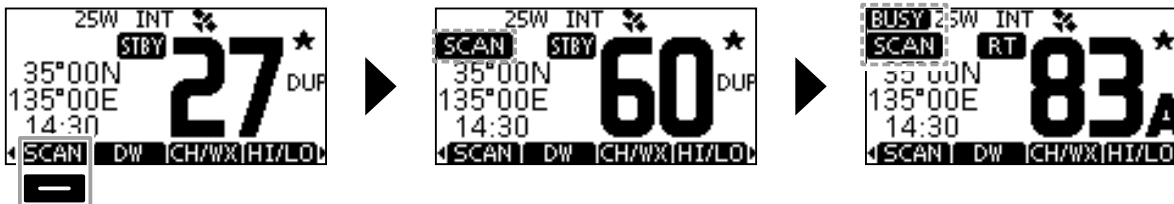

## ■ Description

Dualwatch and Tri-watch are convenient to monitor Channel 16 while you are operating on another channel.

### Dualwatch

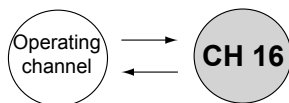

Monitors Channel 16 while receiving on another channel.

### Tri-watch

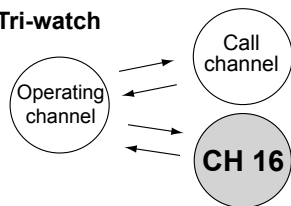

Monitors Channel 16 and the Call channel while receiving on another channel.

### When a signal is received:

#### On Channel 16

Dualwatch/Tri-watch pauses on Channel 16 until the signal disappears.

#### On the Call channel

Tri-watch switches to Dualwatch until the signal on the Call channel disappears.

## ■ Operation

1. Select Dualwatch or Tri-watch on the Menu screen.
2. Push [▲] or [▼] to select a channel.
3. Push [◀] or [▶] to display **DW** (Dualwatch) or **TW** (Tri-watch).
4. Push **DW** or **TW**.
  - Dualwatch or Tri-watch starts.
  - "DW 16" is displayed for Dualwatch, and "TW 16" is displayed for Tri-watch.
  - ① "BUSY" is displayed when a signal is received.
  - ① A beep sounds and "DW 16" or "TW 16" blinks when a signal is received on Channel 16.
5. To cancel Dualwatch or Tri-watch, push **DW** or **TW** again.

**Example:** Operating Dualwatch on INT Channel 27.



## ■ DSC address ID

### ◇ Entering an Individual ID

You can enter a total of 60 Individual IDs, and assign names to them of up to 10 characters.

1. Display the “INDIVIDUAL ID” screen.

[MENU] > DSC Settings > **Individual ID**

- “No ID” is displayed if no ID is entered.
2. Push **ADD**.
    - “The Individual ID” entry screen is displayed.

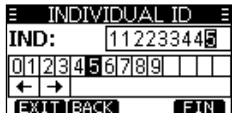

3. Enter an Individual ID.

#### TIP:

- Select a number using [◀] and [▶].
- Push [ENT] to set the selected number.
- Select “←” or “→,” or rotate [DIAL] to move the cursor.

**NOTE:** The first digit is fixed as “0” for a Group ID.  
The first two digits are fixed as “0” for any coast station ID.

4. Push **FIN** to start entering the name.



#### TIP:

- Push **\$?** to use characters, and select **ABC** to use numbers and letters.



- Select characters or space using [▲]/[▼]/[◀]/[▶].
- Select “◀” or “▶” to scroll.
- Push [ENT] to enter the selected character.
- Select “←” or “→,” or rotate [DIAL] to move the cursor.

5. After entering, push **FIN** to save, and return to the previous screen.
  - The entered name is displayed.



### ◇ Entering a Group ID

You can enter a total of 30 Group IDs, and assign names to them of up to 10 characters.

1. Display the “GROUP ID” screen.

[MENU] > DSC Settings > **Group ID**

- “No ID” is displayed if no ID is entered.

2. Push **ADD**.
  - The Group ID’s entry screen is displayed.
3. Enter the Group ID and its name in the same way as described on the previous page.
4. After entering, push **FIN** to save, and return to the previous screen.
  - The entered name is displayed.

**NOTE:** The first digit is fixed as “0” for a Group ID. The first two digits are fixed as “00” for any coast station ID.

### ◇ Deleting an entered ID

(Example: Deleting an Individual ID: ICOM 2)

1. Display the “INDIVIDUAL ID” screen.

[MENU] > DSC Settings > **Individual ID**

2. Push [▲] or [▼] to select “ICOM 2.”

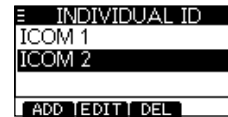

3. Push **DEL**.
  - “Are You Sure?” is displayed.
4. Push **OK** to delete.
  - ① Push **CANCEL** to cancel the deletion.
    - The selected ID is deleted, and then returns to the previous screen.

**TIP:** You can edit an ID and its name by pushing **EDIT** in step 3.



## ■ Entering the position and time

A Distress call should include the vessel's position, date and time. If no GPS data is received, manually enter the position and Universal Time Coordinated (UTC) time.

### NOTE:

- The manual entry is disabled while valid GPS data is received.
- The manually entered position and time is valid only for 23.5 hours, or until turning OFF the transceiver.

1. Display the "POSITION INPUT" screen.

[MENU] > DSC Settings > **Position Input**

2. Enter the latitude.

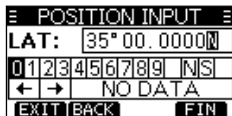

### TIP:

- Select a number or a compass direction using [▲]/[▼]/[◀]/[▶].
- Select "←" or "→," or rotate [DIAL] to move the cursor.
- Push [ENT] or **FIN** to save the selected number.

3. Enter the longitude and the UTC time.

① See the TIP in step 2 to enter.

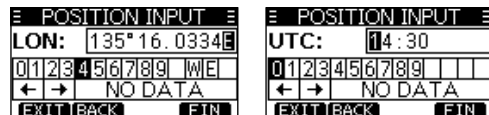

4. Push **FIN** to set the entered position and time.
5. Push **EXIT** to return to the standby screen.



① The entered position and time are displayed on the operating screen.

## ■ Sending DSC calls (Distress)

A Distress call should be sent if, in the opinion of the Captain, the ship or a person is in distress and requires immediate assistance.

**NEVER MAKE A DISTRESS CALL IF YOUR SHIP OR A PERSON IS NOT IN AN EMERGENCY. A DISTRESS CALL SHOULD BE MADE ONLY WHEN IMMEDIATE HELP IS NEEDED.**

### ◇ Simple call

1. Confirm that no Distress call is being received.
2. While lifting up the key cover, hold down [DISTRESS] for 3 seconds until you hear 3 short countdown beeps and a long beep sound.
  - The backlight blinks.

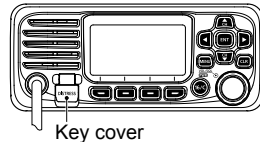

3. After sending, wait for an Acknowledgement call.
  - “Waiting for ACK” is displayed.



- The Distress call is automatically sent every 3.5 to 4.5 minutes, until an Acknowledgement is received, or a Distress Cancel call is sent.

4. When you receive an Acknowledgement, an alarm sounds. Push **ALARM OFF** to turn OFF the alarm.
  - Channel 16 is automatically selected.



5. Hold down [PTT], and then explain your situation.
6. After you have finished your conversation, then push **CANCEL** to return to the operating screen.

#### TIP: A default Distress alert contains:

- Nature of distress: Undesignated distress
- Position information: The latest GPS, or manually input position, that is held for 23.5 hours, or until you turn OFF the transceiver.

## 7 DSC OPERATION

### ◇ Regular call

Select the nature of the Distress call to include in the Regular Distress call.

1. Push **DISTRESS**.
  - The “DISTRESS” screen is displayed.
2. Push [ENT] to enter the Nature selection mode.
3. Push [▲], [▼], or rotate [DIAL] to select the nature of the Distress, then push [ENT]. (Example: Flooding)
  - The setting is saved and returns to the previous screen.

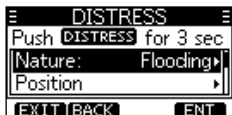

- ① If no valid GPS data is being received, push [▲], [▼], or rotate [DIAL] to select “Position,” then enter the latitude, longitude, and UTC.
  - ② See “Entering the position and time” on page 20 for details.
4. While lifting up the key cover, hold down [DISTRESS] (the red button) for 3 seconds until you hear 3 short countdown beeps and a long beep sound.
  - The backlight blinks.



5. After sending, wait for an Acknowledgement call.
  - “Waiting for ACK” is displayed.
  - ① The Distress call is automatically sent every 3.5 to 4.5 minutes, until an Acknowledgement is received, or a Distress Cancel call is sent. (p. 23)
6. When you receive an Acknowledgement, an alarm sounds. Push **ALARM OFF** to turn OFF the alarm.
  - Channel 16 is automatically selected.

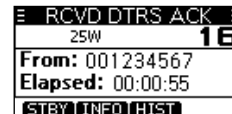

7. Hold down [PTT] to communicate.

**TIP:** You can also send a Regular call by selecting the “Distress” item on the Menu screen.

## ◇ Distress call software key description

### *While waiting for an Acknowledgement:*

- CANCEL:** Cancels the Distress call and enables you to send a Cancel call. (See the right column)
- RESEND:** Enables you to resend the Distress call by holding down [DISTRESS] again.
- PAUSE:** Pauses the countdown to resend the next Distress call.
- INFO:** Displays the information of the Distress call that you have sent.

### *After receiving an Acknowledgement:*

- STBY:** Closes the Distress operation, and returns to the operating screen.
- HIST:** Displays the “DISTRESS HISTORY.”
- INFO:** Displays the information of the received Distress Acknowledgement.

## ◇ Distress Cancel call

If you have accidentally made a Distress call, or made an incorrect Distress call, send a Distress Cancel call to cancel the call as soon as possible while waiting for an Acknowledgement call. Be sure to report the purpose of the cancellation.

- While waiting for an Acknowledgement call, push **CANCEL**.
  - The screen to the right is displayed.
- Push **CONTINUE**.
  - The Distress Cancel call is sent.
  - Channel 16 is automatically selected.
- Hold down [PTT] to report the purpose of the cancellation.
  - You can display the wording of the cancellation by pushing [▼].
- After communicating, push **FINISH**.
  - The screen to the right is displayed.
- Push **STBY** to finish the Distress Cancel call.
  - Returns to the operating screen.

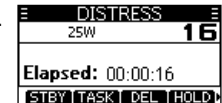
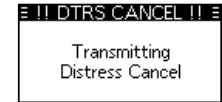

## ■ Sending DSC calls (other)

**NOTE:** To ensure proper DSC operation, be sure to correctly adjust the “CH 70 SQL Level” item on the Menu screen. (p. 43)

### ◇ Sending an Individual call

An Individual call enables you to send a DSC signal to only a specific station. You can communicate after receiving the Acknowledgement “Able to comply.”

1. Push **OTHER DSC**.
  - The “OTHER DSC” screen is displayed.
  - ① You can also display the “OTHER DSC” screen by selecting the “Other DSC” item on the Menu screen.
2. Select “Type,” and then push [ENT].
3. Select “Individual Call,” and then push [ENT].
  - Returns to the “OTHER DSC” screen.
4. Select “Address,” and then push [ENT].
5. Select the station to send an Individual call to, and the push [ENT].
  - Returns to the “OTHER DSC” screen.
  - ① You can also select “Manual Input” to manually enter the target station.
6. Select “Channel,” and then push [ENT].

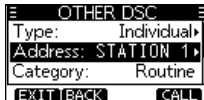

7. Select a channel to assign, and then push [ENT].
  - ① The assigned channels are preset by default.
8. Push **CALL** to send the Individual call.
  - “Transmitting Individual Call” is displayed, and then “Waiting for ACK” is displayed.
  - ① If Channel 70 is busy, the transceiver stands by until the channel becomes clear.

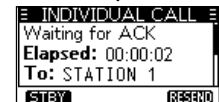
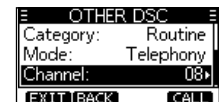

9. When you receive an Acknowledgement “Able to comply”:
  - An alarm sounds.
  - The screen to the right is displayed.
10. Push **ALARM OFF** to turn OFF the alarm.
  - The channel assigned in step 7 is automatically selected.
  - ① If the called station cannot use the channel that you assigned, a different channel is selected by the station.
11. Hold down [PTT] to communicate.

**Acknowledgement “Unable to comply”**

Push **ALARM OFF** to turn OFF the alarm.

- The Acknowledge information is displayed.

① Push **STBY**, and then **OK** to return to the operating screen.

**◇ Sending an Individual Acknowledgement**

When you have received an Individual call (p. 33), send an Acknowledgement to the calling station. When you send an Acknowledgement, select “Able to Comply,” “Propose New CH,” or “Unable to Comply.”

1. While an Individual call is being received, push **ALARM OFF** to turn OFF the alarm.

- The received call's information is displayed.



2. Push **ACPT**.

- The Acknowledgement category screen is displayed.

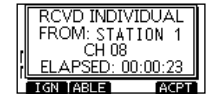

- ① If you want to send an Acknowledgement “Able to comply” right away, push **ABLE**.
- ① If you cannot communicate, and want to return to the operating screen, push **IGN**.

Continued on the next page.

# 7 DSC OPERATION

## ◇ Sending an Individual Acknowledgement (Continued)

3. Push **ABLE**, **UNABLE**, or **NEWCH** to select the Acknowledgement type.



- **ABLE** (*Able to Comply*): Sends an Acknowledgement call without any changes.
- **UNABLE** (*Unable to Comply*): Sends an Acknowledgement call but cannot communicate.
- **NEWCH** (*Propose New CH*): Able to communicate but proposes another channel. Specify the channel by pushing [**▲**] or [**▼**]. (Example: Channel 69)



4. Push **CALL** to send the Acknowledgement call.

### ◇ Sending an All Ships call

All Ships, that have DSC transceiver, use Channel 70 as their listening channel. When you want to announce a message to these ships, if they are within range, use the All Ships Call.

1. Push **OTHER DSC**.
  - The “OTHER DSC” screen is displayed.
  - ① You can also display the “OTHER DSC” screen by selecting the “Other DSC” item on the Menu screen.
2. Select “Type,” and then push [ENT].
  - The “MESSAGE TYPE” screen is displayed.

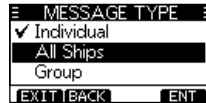

3. Select “All Ships,” and then push [ENT].
  - The All Ships call is selected, and returns to the “OTHER DSC” screen.
4. Select “Category,” and then push [ENT].
  - The “CATEGORY” screen is displayed.
5. Select a category of the call, and then push [ENT].
  - The category is set, and returns to the “OTHER DSC” screen.

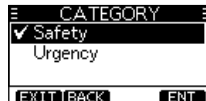

6. Select “Channel,” and then push [ENT].
7. Select the channel to assign, and then push [ENT].
  - ① The assigned channels are preset by default.

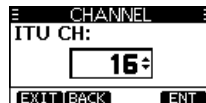

8. Push **CALL** to send the All Ships call.
  - “Transmitting All Ships Call” is displayed, and then the assigned channel is automatically selected.
  - ① If Channel 70 is busy, the transceiver stands by until the channel becomes clear.



9. Hold down [PTT] to communicate.



# 7 DSC OPERATION

## ◆ Sending a Group call

A Group call enables you to send a DSC call to only a specific group.

① You can send a Group call to a pre-entered group address, or manually enter the address before sending. (p. 18)

1. Push **OTHER DSC**.
  - The “OTHER DSC” screen is displayed.
  - ① You can also display the “OTHER DSC” screen by selecting the “Other DSC” item on the Menu screen.
2. Select “Type,” and then push [ENT].
  - The “MESSAGE TYPE” screen is displayed.



3. Select “Group,” and then push [ENT].
  - The Group call is selected, and returns to the “OTHER DSC” screen.
4. Select “Address,” and then push [ENT].
  - The “ADDRESS” screen is displayed.
5. Select the group to send a Group call to, and the push [ENT].
  - ① You can also select “Manual Input” to manually enter the target group.

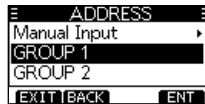

6. Select “Channel,” and then push [ENT].
7. Select the channel to assign, and then push [ENT].
  - ① The assigned channels are preset by default.



8. Push **CALL** to send the Group call.
  - “Transmitting Group Call” is displayed, and then the assigned channel is automatically selected.
  - ① If Channel 70 is busy, the transceiver stands by until the channel becomes clear.



9. Hold down [PTT] to communicate.

### ◇ Sending a Test call

You should avoid testing calls on the exclusive DSC distress channels and safety calling channels. When you cannot avoid testing on a distress or safety channel, you should indicate that these are test calls.

Normally the Test call would require no further communications between the two stations involved.

1. Push **OTHER DSC**.
  - The “Other DSC” screen is displayed.
  - ① You can also display the “Other DSC” screen by selecting the “Other DSC” item on the Menu screen.

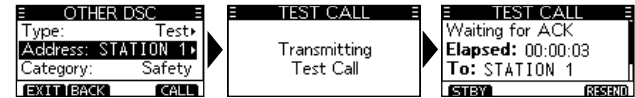

2. Select “Test,” and then push [ENT].
  - The Test call is selected, and returns to the “OTHER DSC” screen.
3. Select “Address,” and then push [ENT].
  - The “ADDRESS” screen is displayed.
4. Select a station to send the Test call to.



- ① You can also select “Manual Input” to manually enter the calling station.

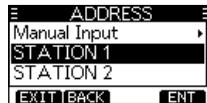

5. Push **CALL** to send the Test call.
  - “Transmitting Test Call” is displayed.
  - ① If Channel 70 is busy, the transceiver stands by until the channel becomes clear.

6. When you receive an Acknowledgement:
  - An alarm sounds.
  - The screen to the right is displayed.
7. Push **ALARM OFF** to turn OFF the alarm.
  - The Acknowledgement information is displayed.



8. Push **STBY**.
  - “Terminate the procedure. Are you sure?” is displayed.
9. Push **OK** to return to the operating screen.

# 7 DSC OPERATION

## ◇ Sending a Test Acknowledgement

By default, when you receive a Test call, the Auto ACK function automatically sends an Acknowledgement to the calling station (p. 42). If the function is set to “Manual,” do the following steps to send an Acknowledgement.

1. After a Test call is being received, push **ALARM OFF** to turn OFF the alarm.
2. Push **ACPT**.
  - The received call's information is displayed.
3. Push **ACK**.
  - The “Test ACK” confirmation screen is displayed.



4. Push **CALL** to send the Acknowledgement.
  - “Transmitting Test ACK” is displayed.



5. Push **STBY**.
  - A confirmation screen is displayed.
6. Push **OK** to return to the operating screen.

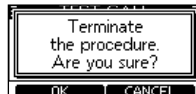

## ◇ Sending a Position Request call/Polling

### Request call (For only the USA version)

You can send a Position Request call or Polling request call to a station, depending on the presetting.  
(Example: Sending a Position Request call)

1. Push **OTHER DSC**.
  - The “OTHER DSC” screen is displayed.
  - ① You can also display the “OTHER DSC” screen by selecting the “Other DSC” item on the Menu screen.
2. Select “Type,” and then push [ENT].
  - The “MESSAGE TYPE” screen is displayed.
3. Select “Position,” and then push [ENT].
  - The message type is selected, and returns to the “OTHER DSC” screen.
  - ① When you send a Polling Request call, select “Polling.”
4. Select “Address,” and then push [ENT].
  - The “ADDRESS” screen is displayed.
5. Select a target to send a Position Request call to, and the push [ENT].
  - ① You can also select “Manual Input” to manually enter the target ID.

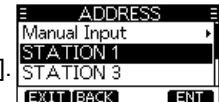

6. Push **CALL** to send the Position Request call.
  - “Transmitting Position Request” is displayed, and then the assigned channel is automatically selected.
  - ① If Channel 70 is busy, the transceiver stands by until the channel becomes clear.



7. When you receive a Position Reply:
  - An alarm sounds.
  - The screen to the right is displayed.
8. Push **ALARM OFF** to turn OFF the alarm.
9. Push **CLOSE**.
  - The received information is displayed.
10. Push **▲** or **▼** to scroll the screen then check the target’s position.
11. Push **STBY**, and then **OK** to return to the operating screen.



### ◇ Sending a Position Reply call

Send a Position Reply call when a Position Request call is received. If the Auto ACK function is set to “Auto,” the Acknowledgement is automatically sent to the calling station. (p. 42)

1. While a Position Request call is being received, push **ALARM OFF** to turn OFF the alarm.
2. Push **ACPT**.
  - The received call’s information is displayed.
3. Push **ABLE** to send an “Able to Comply” Acknowledgement, or push **UNABLE** to send an “Unable to Comply” Acknowledgement.
  - ① If no valid GPS position is received, you can manually enter the position and time in “Position” item on this screen. See “Entering the position and time” on page 20 for details.
4. Push **CALL** to send the Position Reply call.



5. Push **STBY**, and then **OK** to return to the operating screen.

## ■ Receiving DSC calls (Distress)

The transceiver receives Distress calls, Distress Acknowledgement calls, and Distress Cancel calls.

① When you receive a call, an emergency alarm sounds.

**NOTE:** The screens that are displayed when a Distress call or an Acknowledgement call is received slightly differ from one another. The following steps are described using an example of receiving a Distress call.

### *When a Distress call is received:*

- The emergency alarm sounds until you turn it OFF.
- “RCVD DISTRESS” is displayed.

1. Push **ALARM OFF** to turn OFF the alarm.
2. Push the software key below the intended operation.



### **IGN** (Ignore):

- Returns to the operating screen.
- The call is saved in the DSC Log.
- **MAIL** blinks continuously until you display the call message.

### **PAUSE** (Pause):

- ① **PAUSE** is not displayed if the “CH Auto SW” item is set to “Manual.” (p. 42)
- Pauses the countdown until the assigned channel is automatically selected.
- Select **RESUME** to resume the countdown.
- The call is saved in the DSC Log.

### **ACPT** (Accept):

- Accepts the call.
- Channel 16 is automatically selected.
- Monitor Channel 16 as a coast station may require assistance.
- After Channel 16 is selected, you can select your next operation by pushing the software key below the following options.

**EXIT**: Returns to the operating screen.

**HIST**: Displays the “DISTRESS HISTORY” screen.

**INFO**: Displays the information of the received Distress call.

## ■ Receiving DSC calls (other)

The transceiver receives the following types of DSC calls.

- Individual call (p. 33)
- Individual Acknowledgement call (p. 26)
- Group call (p. 34)
- All Ships call (p. 35)
- Position Request call (p. 36)
- Test call (p. 37)
- Test Acknowledgement call (p. 38)

① The receivable call types may differ, depending on the version or presetting.

### ◇ Receiving an Individual call

**When an Individual call is received:**

- The alarm sounds.
- “RCVD INDIVIDUAL” is displayed.

1. Push **ALARM OFF** to turn OFF the alarm.
2. Push the software key below the next operation.

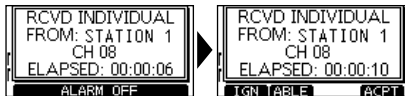

#### **IGN** (Ignore)

- Ignores the call and returns to the operating screen.
- The call is saved in the DSC Log.
- blinks continuously until you display the call message.

#### **ABLE** (Able to comply)

- Sends an Individual Acknowledgement call right away.
- The assigned channel is automatically selected.
- After sending, [RESEND] to resend.
- The call is saved in the DSC Log.

#### **ACPT** (Accept)

- Accepts the call.
- The assigned channel is automatically selected.
- The call is saved in the DSC Log.
- The received call's information is displayed.
- Push the software key to select the Acknowledgement option.



**ABLE** (Able to Comply): Sends an Acknowledgement call without any changes.

**UNABLE** (Unable to Comply): Sends an Acknowledgement but you cannot communicate.

**NEWCH** (Propose New CH): Sends an Acknowledgement call but on another channel. Assign the channel by pushing [▲] or [▼].

**NOTE:** If the Auto ACK function is set to “Auto (Unable)” the Acknowledgement “Unable to Comply” is automatically sent to the calling station when the call is received. (p. 42)

① For the USA version, this function is set to “Auto (Able)” by default.

## 7 DSC OPERATION

### ◇ Receiving a Group call

#### **When a Group call is received:**

- The alarm sounds for 2 minutes.
- “RCVD GROUP CALL” is displayed.

1. Push **ALARM OFF** to turn OFF the alarm.
  - ① The channel that is assigned by the caller is automatically selected after 10 seconds by default.
2. Push the software key below your next operation.

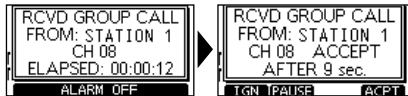

#### **IGN (Ignore):**

- Ignores the call and returns to the operating screen.
- The call is saved in the DSC Log.
- “” blinks continuously until you display the call message.

#### **PAUSE (Pause):**

- ① **PAUSE** is not displayed if the “CH Auto SW” item is set to “Manual.” (p. 42)
- Pauses the countdown until the assigned channel is automatically selected.
- Select **RESUME** to resume the countdown.
- The call is saved in the DSC Log.

#### **ACPT (Accept):**

- Accepts the call.
- The assigned channel is selected.
- The call is saved in the DSC Log.

**STBY:** Closes the Group call, and then returns to the operating screen.

**INFO:** The received call’s information is displayed.

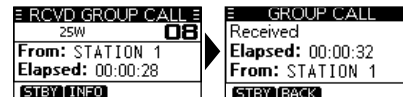

## ◇ Receiving an All Ships call

### When an All Ships call is received:

- The alarm sounds.
- “RCVD ALL SHIPS” is displayed.

1. Push **ALARM OFF** to turn OFF the alarm.
  - ① The traffic channel that is assigned by the caller is automatically selected after 10 seconds by default.
2. Push the software key below your next operation.

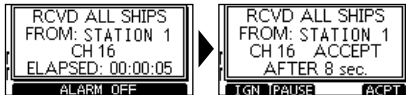

### **IGN** (Ignore)

- Ignores the call and returns to the operating screen.
- The call is saved in the DSC Log.
- “” blinks continuously until you display the call message.

### **PAUSE** (Pause)

- ① **PAUSE** is not displayed if the “CH Auto SW” item is set to “Manual.” (p. 42)
- Pauses the countdown until the assigned channel is automatically selected.
- Select **RESUME** to resume the countdown.
- The call is saved in the DSC Log.

### **ACPT** (Accept)

- Accepts the call.
- The assigned channel is selected.
- The call is saved in the DSC Log.

**STBY:** Closes the All Ships call, and then returns to the operating screen.

**INFO:** The received call’s information is displayed.

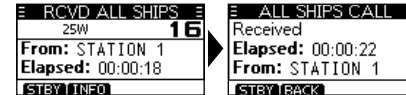



# 7 DSC OPERATION

## ◆ Receiving a Position Request call

(For only the USA version, depending on the presetting)

### When a Position Request call is received:

- The alarm sounds for 2 minutes.
- “RCVD POS Request” is displayed.

1. Push **ALARM OFF** to turn OFF the alarm.
2. Push the software key below the intended operation.



### **IGN** (Ignore)

- Ignores the call and returns to the operating screen.
- The call is saved in the DSC Log.
- “” blinks continuously until you display the call message.

### **ABLE** (Able to Comply)

- Sends the Acknowledgement “Able to Comply.”
- The call is saved in the DSC Log.

### **UNABLE** (Unable to Comply)

- Sends the Acknowledgement “Unable to Comply.”
- Displays the Acknowledgement information, and then returns to the operating screen by pushing **EXIT**.
- The call is saved in the DSC Log.

### **ACPT** (Accept)

- Accepts the call.
- Displays the received call's information.
- The call is saved in the DSC Log.
- Push **ABLE** or **UNABLE**, then push **CALL** to send the Position Reply call. (p. 31)



### NOTE:

- If the Auto ACK function is set to “Auto,” the Position Reply is automatically sent to the calling station. (p. 42)
- However, even if the Auto ACK function is set to “Manual,” after receiving a Distress Acknowledgement, or while in the Distress Cancel call procedure, the Position Reply is automatically sent to the calling station.

## ◇ Receiving a Test call

**TIP:** By default, the Auto ACK function automatically sends an Acknowledgement to the calling station (p. 42). If the function is set to “Manual,” the following screens are displayed.

### When a Test call is received:

- The alarm sounds for 2 minutes.
  - “RCVD TEST CALL” is displayed.
1. Push **ALARM OFF** to turn OFF the alarm.
  2. Push the software key below your next operation.



### **IGN** (Ignore)

- Ignores the call and returns to the operating screen.
- The call is saved in the DSC Log.
- “” blinks continuously until you display the call message.

### **ABLE** (Able to Comply)

- Sends the Acknowledgement “Able to Comply.”
- The call is saved in the DSC Log.

### **ACPT** (Accept)

- Accepts the call.
- Displays the received call’s information.
- The call is saved in the DSC Log.
- Push **ACK**, and then push **CALL** to send a Test Acknowledgement call. (p. 30)
- Push **RESEND** to resend.

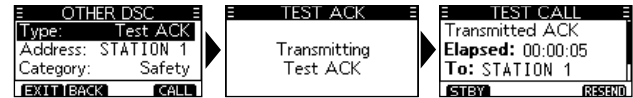

**NOTE:** If the Auto ACK function is set to “Auto,” the Test Acknowledgement call is automatically sent to the calling station when the call is received. (p. 42)

## ◇ Receiving a Test Acknowledgement call

After sending a Test call, the called station will send you a Test Acknowledgement call.

### *When a Test Acknowledgement call is received:*

- The alarm sounds for 2 minutes.
- “RCVD TEST ACK” is displayed.



1. Push **ALARM OFF** to turn OFF the alarm.
2. Push **CLOSE**.
  - The received call's information is displayed.



- The call is saved in the DSC Log.
3. Push **STBY** to return to the operating screen.

## ■ DSC Log

### ◇ Received DSC Log

The transceiver saves up to 30 received Distress call messages and 50 received “Others” call messages in your DSC Log.

On the operating screen, “” is displayed when there is an unread call message. The icon blinks when there is a new received call message.

1. Display the “DSC Log” screen.
  - Menu > **DSC Log**
2. Push **▲** or **▼** to select “Received Call Log,” and then push [ENT].
  - The “RCVD CALL LOG” screen is displayed.
3. Push **▲** or **▼** to select “Distress” or “Others,” and then push [ENT].
  - ① “Distress” displays the received Distress call log, and “Others” displays the received DSC call log.

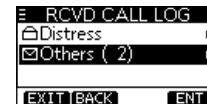

**TIP:** You can also display the “Received” screen by pushing **LOG** on the operating screen.

4. Push [▲] or [▼] to scroll through the log.
5. Push [ENT] to display the received call's information.

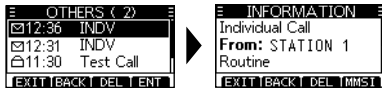

- EXIT**: Returns to the operating screen.
- BACK**: Returns to the previous screen.
- DEL**: Deletes the selected call log.
  - ① The confirmation screen is displayed before deleting.
- MMSI**: Saves the MMSI as an Individual ID.

### ◇ Transmitted DSC Log

The transceiver saves up to 30 DSC transmitted calls in your DSC Log.

1. Display the “DSC Log” screen.

Menu > **DSC Log**

2. Push [▲] or [▼] to select “Transmitted Call Log,” and then push [ENT].
  - The “TX CALL LOG” screen is displayed.
3. Push [▲] or [▼] to scroll through the log.
4. Push [ENT] to display the sent call's information.

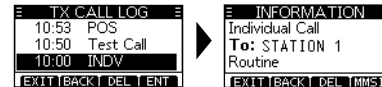

- EXIT**: Returns to the operating screen.
- BACK**: Returns to the previous screen.
- DEL**: Deletes the selected call log.
  - ① Confirmation screen is displayed before deleting.
- MMSI**: Saves the MMSI as an Individual ID or a Group ID.

## ■ Multiple-task mode

(For only the USA version, depending on the presetting.)

If the Multiple-task function is enabled, the transceiver can hold up to 7 tasks. Therefore, you can handle more than 2 DSC tasks simultaneously by switching between the DSC tasks.

To use the Multiple-task mode, select “Multiple” in the “Procedure” on the Menu screen. (p.44)

Menu > DSC Settings > **Procedure**

When the Multiple-task mode is activated, **TASK** is displayed on the operating screen.

**NOTE:** The Task mode has a Time-out Timer (TOT) function. After a certain period of time has passed without any operation on a task, the transceiver automatically exits the Task mode and returns to the operating screen. When a Time-out Timer activates, an alarm sounds and a count down message is displayed for 10 seconds.

### ◇ Holding a DSC task

In the Multiple-task mode, you can hold or activate the DSC task as follows.

**Example: When a Group call is received:**

1. Push **ALARM OFF** to turn OFF the alarm.
  - The received call's information is displayed.
2. Push **HOLD**.
  - The received Group call task is held into the task list and returns to the operating screen.



### ◇ Activating the held DSC task

1. Push **TASK** to display the task list.
  - The task list is displayed.
2. Push [**▲**] or [**▼**] to select the task that you want to activate.
3. Push **ACTIVE** to activate the task.
  - The activated task information is displayed.

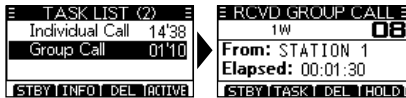

4. Push [PTT] to communicate.
5. After finishing the communication, push **DEL** to delete the task.

### ◇ Task list

When one or more tasks are held, you can display the task list screen by pushing **TASK**.  
The number of tasks is displayed at the top of the screen.

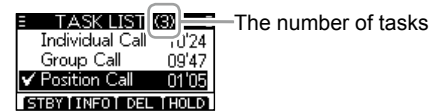

On the “TASK LIST” screen, the following software keys are displayed.

- STBY**: Holds the task and returns to the operating screen.
- INFO**: Displays the task information.
- DEL**: Finishes the selected task.
- HOLD**: Holds the selected task.
- ACTIVE**: Activates the selected task.

## ■ DSC Settings

On the “DSC Settings” screen, you can make settings on the DSC call related items.

### Position Input

---

See “*Entering the position and time*” on page 20 for details.

### Individual ID

---

See “*Entering an Individual ID*” on page 18 for details.

### Group ID

---

See “*Entering a Group ID*” on page 19 for details.

### Auto ACK

---

The Auto ACK function automatically sends an Acknowledgement call when an appropriate Request is received.

- **Individual ACK** (Default: Differs depending on the version or presetting)
  - Auto (Able): Automatically sends “Able to comply.”
  - Auto (Unable): Automatically sends “Unable to comply.”
  - Manual: Manually sends an Acknowledgement call.
  
- **Position ACK** (Default: Auto (Able))
  - Auto (Able): Automatically sends “Able to comply.”
  - Manual: Manually sends an Acknowledgement call.

### Polling ACK (Default: Auto)

- Auto: Automatically sends an Acknowledgement call.
- Manual: Manually sends an Acknowledgement call.

### • Test ACK (Default: Auto)

- Auto: Automatically sends an Acknowledgement call.
- Manual: Manually sends an Acknowledgement call.

### CH Auto SW (Default: Accept)

---

Select whether or not to automatically switch to channel 16 or the specified channel, or select whether to switch or ignore the call.

- Accept: After receiving a DSC call, the transceiver remains on the operating channel for 10 seconds. After that, the transceiver automatically switches to the channel that is specified on the DSC call.
- Ignore: After receiving a DSC call, if you do not push the software key below [ACPT] in 10 seconds, the transceiver ignores the call, and then remains on the current operating channel.
- Manual: After receiving a DSC call, you can select whether or not to accept the received DSC call.

**Data Output** (Default: Off)

When receiving a DSC call from the station that is selected in this setting, the transceiver outputs the DSC data to the NMEA output port.

① You can send Distress calls despite of this setting.

All Stations: From any station.

Stations List: From the stations that are entered Individual ID or Group ID on the Menu screen.

OFF: Does not output any DSC data from the NMEA 0183 Output port.

**Alarm Status**

Set the alarm ON or OFF for each DSC related item.

• **Safety** (Default: On)  
An alarm sounds when a Safety DSC call is received.

• **Routine** (Default: On)  
An alarm sounds when a Routine DSC call is received.

• **Warning** (Default: On)

An alarm sounds when:

- No MMSI code is entered.

- The position data has not been received for 2 minutes after turning ON the transceiver.

- The received position data has not been updated for 10 minutes.

- The received position data has not been updated for 4 hours.

- The manually entered position data has not been updated for 23.5 hours.

• **Self-Terminate** (Default: On)

An alarm sounds when duplicate DSC calls are received.

• **Self-Terminate** (Default: On)

An alarm sounds when duplicate Distress calls are received.

• **Discrete** (Default: On)

An alarm sounds when a lower priority call is received while receiving a high priority call.

**CH 70 SQL Level** (Default: 3)

Adjust the Squelch level for Channel 70 to between 1 and 10, or Open.



---

## 7 DSC OPERATION

### ■ DSC Settings (Continued)

#### **Self-Test**

---

The Self-Test sends DSC signals to the receiving AF circuit to compare the sending and receiving signals at the AF level.

Push [ENT] to start the Self-Test.

① When the sending and receiving DSC signals match, "OK" is displayed.

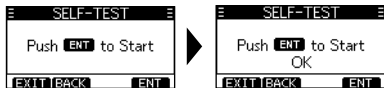

#### **Procedure** (Default: Single)

---

(For only the USA version)

You can select the type of task for the transceiver, depending on the presetting.

Single: Handles only 1 task at the same time.

Multiple: Handles up to 7 tasks at the same time.

## ■ Making an Individual call using an AIS transponder

When the optional MA-500TR CLASS B AIS TRANSPONDER is connected to your transceiver, you can transmit an Individual DSC call to a selected AIS target, without entering the target's MMSI code. In this case, the call type is automatically set to Routine.

See page 53 for connecting instructions.

**NOTE:** To ensure correct operation of the DSC function, make sure you correctly set the CH70 SQL Level. (p.43)

1. Select an AIS target on the plotter, target list or danger list display.
  - You can also go to the next step whenever the detail screen of the AIS target is displayed.
  - Confirm the transceiver is in the normal operating mode. Otherwise, you cannot make an Individual DSC call using the transponder.
2. Push [DSC] to display the Voice channel selection screen, and then push [▲]/[▼] to select a Voice channel.\*
  - Voice channels are already preset into the transponder in the recommended order.
  - \* When a coast station is selected in step 1, a Voice channel will be specified by the coast station, therefore you cannot change the channel. The transponder will display "Voice Channel is specified by the Base station," in this case.

3. Push [DSC] to transmit an Individual DSC call to the AIS target.



- If Channel 70 is busy, the transceiver stands by until the channel becomes clear.
- If the transceiver cannot make the call, the transponder will display "DSC Transmission FAILED."

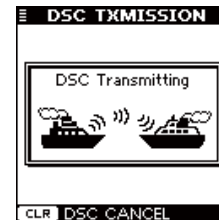

## 7 DSC OPERATION

1. After sending the Individual DSC call, the transponder will display “DSC Transmission COMPLETED.”
  - Push [CLEAR] to return to the screen displayed before you entered the Voice channel selection screen in step 2.
  - The transceiver stands by on Channel 70 until an Acknowledgement is received.

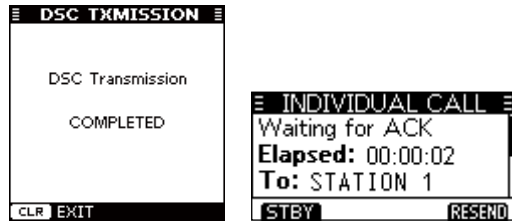

2. When the Acknowledgement is received, alarm sounds.
  - If the Acknowledgement ‘Able to comply’ is received, push **ALARM OFF** to turn OFF the alarm, and then select the Intership channel specified in step 2.
  - A different Intership channel will be selected if the station you called cannot use the channel.
  - To reply, push [PTT] and speak at a normal voice level.
  - If entered, you can check the MMSI code or the name of the AIS target on the display.
  - If the Acknowledgement ‘Unable to comply’ is received, push **ALARM OFF** to turn OFF the alarm, then “INDIVIDUAL CALL FAILED” is displayed.

3. After the communication is finished, push **STBY** to return to the normal operating mode.

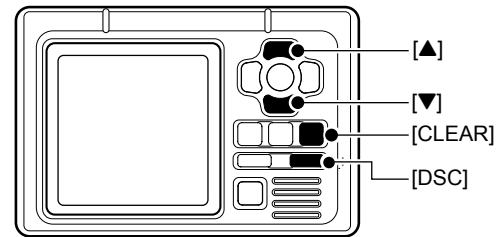

TRANSPONDER

## ■ Using the Menu screen

The Menu screen is used to set items, select options, and so on for the transceiver's functions.

### ◇ Using the Menu screen

**Example:** Setting the key beep to "Off."

1. Push [MENU].
  - The Menu screen is displayed.



2. Push [▲], [▼], or rotate [DIAL] to select "Configuration," and then push [ENT].
  - The "CONFIGURATION" screen is displayed.
  - ① Holding down [▲] or [▼] sequentially scrolls up or down through the Menu screen.

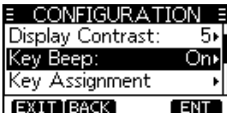

3. Push [▲], [▼], or rotate [DIAL] to select "Key Beep," then push [ENT].
  - The "KEY BEEP" screen is displayed.

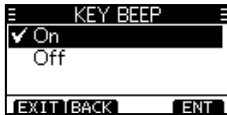

4. Push [▲], [▼], or rotate [DIAL] to select "Off," then push [ENT].
  - ① "Off" is set and the transceiver returns to the previous screen.

**TIP:**  
① To exit the Menu screen, push **EXIT** or [MENU].  
① To return to the previous screen, push **BACK** or [CLR].

## 8 MENU SCREEN

### ◇ Menu screen items

The Menu screen contains the following items.

See the referred pages for each items.

① The displayed menu items may differ, depending on the version or presetting.

#### Distress

Item	Reference	Item	Reference
Nature	p. 21	Position	p. 20

#### Other DSC

Item	Reference	Item	Reference
Type	p. 24	Mode	p. 24
Address	p. 24	Channel	p. 24
Category	p. 24	—	—

GPS (p. 49)

#### Configuration

Item	Reference	Item	Reference
Backlight	p. 12	UTC Offset	p. 49
Display Contrast	p. 12	Inactivity Timer	p. 49
Key Beep	p. 49	GPS	p. 50
Key Assignment	p. 49	—	—

#### DSC Log

Item	Reference	Item	Reference
Received Call Log	p. 38	Transmitted Call Log	p. 39

#### Radio Settings

Item	Reference	Item	Reference
Scan Type	p. 50	WX Alert	p. 51
Scan Timer	p. 50	FAV Settings	p. 51
Dual/Tri-watch	p. 50	FAV On MIC	p. 51
Channel Group	p. 51	CH Display	p. 52
Call Channel	p. 51	CH Close-up	p. 52

#### DSC Settings

Item	Reference	Item	Reference
Position Input	p. 42	Data Output	p. 43
Individual ID	p. 42	Alarm Status	p. 43
Group ID	p. 42	CH 70 SQL Level	p. 43
Auto ACK	p. 42	Self-Test	p. 44
CH Auto SW	p. 42	Procedure	p. 44

Radio Info (p. 52)

## ■ Menu items description

### ◇ GPS

Displays the position information.

### ◇ Configuration

#### Backlight (Default: 7)

You can adjust the backlight brightness between 1 and 7, or OFF.

#### Display Contrast (Default: 5)

You can adjust the display contrast level between 1 (lowest) and 8 (highest).

#### Key Beep (Default: On)

You can select whether or not to sound a beep when a key is pushed.

On: Sounds a beep when a key is pushed.

Off: No beep sounds, for silent operation.

#### Key Assignment

##### • Softkey 1~16

You can change which software key functions to display, and their order. You can assign up to 16 software keys at a time.

- ① The usable software key functions and their order may differ, depending on the transceiver version or presetting.

##### • Set Default

Sets the software key function order as default.

- ① The default setting may differ, depending on the transceiver version or presetting.

#### UTC Offset (Default: 00:00)

Set the offset time between Universal Time Coordinated (UTC) and your local time to between -14:00 and +14:00 (in 1 minute steps).

#### Inactivity Timer

The transceiver automatically returns to the operation screen if you push no key for the set period of time for each mode.

##### • Not DSC (Default: 10 min)

Setting for when a screen that is not related to DSC is displayed.

##### • DSC (Default: 15 min)

Setting for when a screen that is related to DSC is displayed.

##### • Distress (Default: Off)

Setting for when a screen that is related to a Distress call is displayed.

##### • RT (Default: 30 sec)

Setting for when the transceiver is in the Radio Telephone mode.

### GPS

Selects a satellite to be used for GPS (Global Positioning System) to pinpoint the geographic location of your transceiver anywhere in the world.

This setting may not be usable, depending on the transceiver version or presetting.

• **GPS** (Always On)

The GPS (Global Positioning System) is permanently set to ON.

• **GLONASS** (Default: On)

Selects whether or not to use the data from the GLONASS (GLObal'naya NAVigatsionnaya Sputnikovaya Sistema) satellites.

• **SBAS** (Default: Off)

Turns the SBAS (Satellite Based Augmentation System) function ON or OFF.

When turning ON this function, the GPS position accuracy can be improved.

### ◇ Radio Settings

#### Scan Type (Default: —)

Selects the scan type. The default setting differs, depending on the transceiver version.

① See page 15 for details.

**Normal Scan:** Scans all Favorite channels in the selected channel group.

**Priority Scan:** Sequentially scans all Favorite channels, while monitoring Channel 16.

#### Scan Timer (Default: Off)

You can use the Scan Timer to pause, or to resume after 5 seconds, when a signal is detected.

**On:** When a signal is detected on a channel, the scan pauses for 5 seconds, and then resumes. If the signal disappears in less than 5 seconds, the scan immediately resumes.

**Off:** When a signal is detected on a channel, the scan pauses until the signal disappears, and then resumes.

#### Dual/Tri-watch (Default: Dualwatch)

Select Dualwatch or Tri-watch.

**Dualwatch:** Monitors Channel 16 while receiving on another channel.

**Tri-watch:** Monitors Channel 16 and the Call channel while receiving on another channel.

① See page 17 for details.

## Channel Group

Select the suitable channel group for your operating area. Select USA, INT, CAN, DSC, or ATIS depending on the transceiver version.

① See page 10 for details.

## Call Chancel

You can change your Call channel. The default setting differs, depending on the transceiver version.

① See page 12 for details.

## WX Alert (Default: Off)

For the USA and Australian versions, an NOAA broadcast station transmits a Weather Alert tone before any important weather information.

① “WX ” is displayed instead of “WX.”

① “WX ” blinks until you push a key after detecting an alert.

On with Scan: The preset Weather channels are sequentially checked while scanning.

On: The previously selected (last used) Weather channel is checked while scanning.

Off: The Weather Alert tone is not detected.

## FAV Settings

You can set all channels as Favorite channels, clear all settings, or reset to default. By default, some channels are preset. The Favorite channels differ, depending on the transceiver version.

Set All Channels: Sets all channels as Favorite channels.

Clear All Channels: Clears all Favorite channels.

Set Default: Resets Favorite channels to the default.

① See page 16 for details.

## FAV on MIC (Default: Off)

You can select the channel set when you push [▲] or [▼] on the supplied microphone.

On: Scrolls through only the Favorite channels.

Off: Scrolls through all the channels.

① See page 16 for details.



---

## 8 MENU SCREEN

### CH Display

---

You can select the number of digits to display the channel number.

3 Digits: The channel number is displayed in 3 digits such as "01A."

4 Digits: The channel number is displayed in 4 digits such as "1001."

① This setting may not be usable, depending on the transceiver version or presetting.

### CH Close-up

---

You can select whether or not to display the channel name when changing the operating channel.

On: The channel number and the channel name are briefly displayed when changing the channel.

Off: The channel name is not displayed on the screen.

### ◇ Radio Info

Displays your transceiver's MMSI, Software version, and GPS version if built-in.

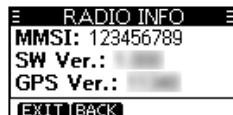

## ■ Connections

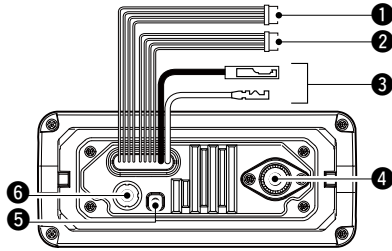

### 1 NMEA IN/OUT LEADS

Green: Listener B (Data-L), GPS In (-)

Yellow: Listener A (Data-H), GPS In (+)

Connect to the NMEA output lines of a GPS receiver for position data.

- NMEA 0183 (ver. 2.0 or later) sentence format RMC, GGA, GNS, or GLL and VTG compatible GPS receiver is required. Ask your dealer about suitable GPS receivers.
- The GPS sentences input from this connector are given priority to over the sentences input from the GPS antenna connector.

Brown: Talker B (Data-L), Data Out (-)

White: Talker A (Data-H), Data Out (+)

Connect to NMEA 0183 input lines of navigation equipment, to receive position data from other ships.

- An NMEA 0183 (ver. 2.0 or later) sentence format DSC or DSE compatible navigation equipment is required.
- The supplied GPS outputs RMC, GSA, and GSV format sentences.

### 2 AF OUT AND DATA LEADS

Blue: External Speaker (+)

Black: External Speaker (-)

Connects to an external speaker.

Orange: Data line

Gray: Data line

Used only for maintenance purpose.

**NOTE** for NMEA In/Out and AF Out leads:

The connectors are attached to keep the leads together. Before connecting to a piece of equipment, cut the leads to remove the connector.

### 3 DC POWER CONNECTOR

Connects to a 13.8 V DC power source.

(+: Red, -: Black)

**CAUTION:** After connecting the DC power cable, NMEA leads or external speaker leads, cover the connector and leads with a vulcanizing tape, as shown below, to prevent water seeping into the connection.

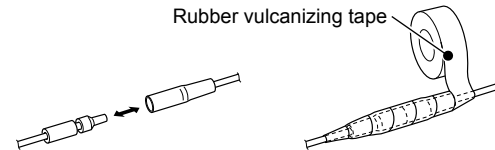

## 9 CONNECTIONS AND MAINTENANCE

### ■ Connections (Continued)

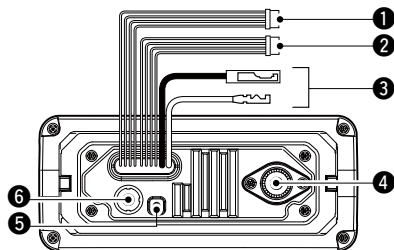

#### 4 ANTENNA CONNECTOR

Connects to a marine VHF antenna with a PL-259 connector.

**CAUTION:** Transmitting without an antenna may damage the transceiver.

#### 5 GROUND TERMINAL

Connects to a vessel ground to prevent electrical shocks and interference from other equipment occurring. Use a PH M3 × 6 screw (user supplied).

#### 6 GPS ANTENNA CONNECTOR

Connects to the supplied GPS antenna. (For only the IC-M330G/IC-M330GE)

**NOTE:** Be sure the GPS antenna is positioned where the GPS antenna has a clear view to receive signal from satellites, and fixed using the supplied double-sided adhesive pad.

### ◇ Connect to the MA-500TR

Connect the transceiver to the high-density D-Sub 15-pin connector of the MA-500TR using the OPC-2014\* cable. After connecting, an Individual DSC call can be made to the AIS target using the transponder without entering the target's MMSI code.

\* The OPC-2014 is supplied with the MA-500TR

- **Listener A (Data-H) lead (Yellow):**  
Connects to lead 3 of the OPC-2014.
- **Listener B (Data-L) lead (Green):**  
Connects to lead 2 of the OPC-2014.
- **Talker A (Data-H) lead (White):**  
Connects to lead 5 of the OPC-2014.
- **Talker B (Data-L) lead (Brown):**  
Connects to lead 4 of the OPC-2014.

## ■ Antenna

A key element in the performance of any communication system is the antenna. Ask your dealer about antennas and the best place to mount them.

## ■ Fuse replacement

One fuse is installed in the supplied DC power cable. If the fuse blows or the transceiver stops functioning, track down the source of the problem, repair it, and replace the damaged fuse with a new one of the proper rating. Fuse rating: 10 A

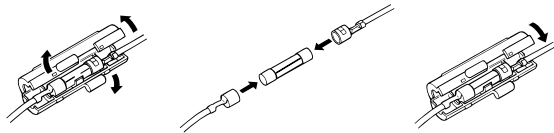

## ■ Cleaning

If the transceiver becomes dusty or dirty, wipe it clean with a soft, dry cloth.



**DO NOT** use harsh solvents such as Benzine or alcohol, as they will damage the transceiver's surfaces.

## ■ Supplied accessories

Mounting bracket

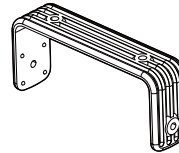

For mounting bracket

Knob bolts



Flat washers (M5)



Screws

(5 × 20 mm)

Spring washers (M5)



Microphone hanger and screws (3 × 16 mm)



DC power cable



GPS antenna and double-sided adhesive pad  
(For only the IC-M330G/IC-M330GE)



### ■ Mounting the transceiver

#### ◇ Using the supplied mounting bracket

You can mount the transceiver on dashboard using the universal mounting bracket supplied with your transceiver.

1. Mount the bracket securely to a surface which is more than 10 mm thick and can support more than 5 kg using the 2 supplied screws (5 × 20 mm).

**NOTE:** When mounting the transceiver on a board, fix the bracket to the board using the user supplied bolts and nuts as shown to the right.

2. Attach the transceiver to the bracket so that the face of the transceiver is at 90° to your line of sight when operating it.  
① Adjust the function display angle to be easy-to-read.

**CAUTION: KEEP** the transceiver and microphone at least 1 meter (3.3 ft) away from the vessel's magnetic navigation compass.

#### *Mounting Example*

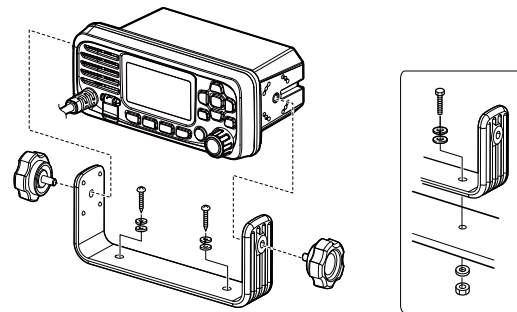

## ■ MBF-5 installation

An optional MBF-5 FLUSH MOUNT KIT is available for mounting the transceiver to a flat surface (less than 20 mm thick), such as an instrument panel.

**KEEP** the transceiver and microphone at least 1 meter away from your vessel's magnetic navigation compass.

1. Using the template on page 63, carefully cut a hole into the instrument panel, or wherever you plan to mount the transceiver. (Torque: 2 N•m)
2. Slide the transceiver through the hole, as shown below.

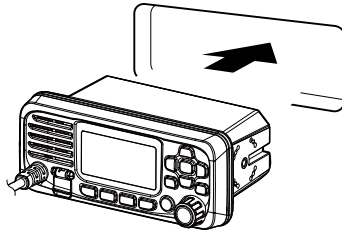

3. Attach the 2 bolts (5 × 8 mm) and spacer supplied with the MBF-5 on both sides of the transceiver.

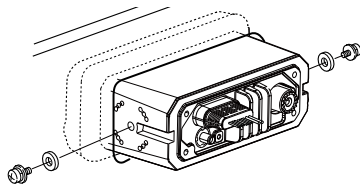

4. Attach the clamps on both sides of the transceiver.
  - ① Make sure that the clamps align parallel to the transceiver body.

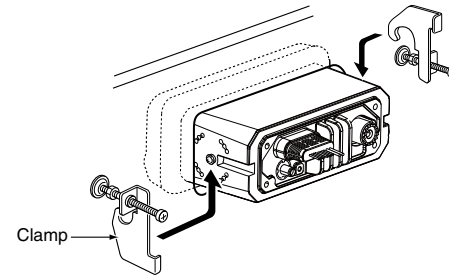

5. Tighten the end bolts on the clamps (rotate clockwise) so that the clamps press firmly against the inside of the instrument control panel.
6. Tighten the locking nuts (rotate counterclockwise) so that the transceiver is securely mounted in position, as shown below. (Torque: 2 N•m)
7. Connect the antenna and power cable, then return the instrument control panel to its original place.

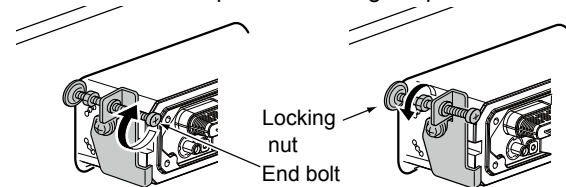

# 10 SPECIFICATIONS AND OPTIONS

## ■ Specifications

### ◇ General

- Frequency coverage:
  - TX IC-M330/IC-M330G 156.025 ~ 161.600 MHz
  - IC-M330E/IC-M330GE 156.000 ~ 162.000 MHz  
(Depending on the version)
  - RX IC-M330/IC-M330G 156.050 ~ 163.275 MHz
  - IC-M330E/IC-M330GE 156.000 ~ 163.425 MHz  
(Depending on the version)
- CH70 156.525 MHz
- Mode:
  - 16K0G3E (FM)
  - 16K0G2B (DSC)
- Channel spacing: 25 kHz
- Operating temperature range: -20°C ~ +60°C,  
-4°F ~ +140°F
- Current drain (at 13.8 V):
  - TX high (25 W) 5 A maximum
  - Maximum audio 1 A maximum
- Power supply requirement: Negative Ground
  - IC-M330/IC-M330G 13.8 V DC (11.7 ~ 15.9 V)
  - IC-M330E/IC-M330GE 13.8 V DC (10.8 ~ 15.6 V)
- Frequency tolerance (IC-M330/IC-M330G): ±5 ppm
- Frequency error (IC-M330E/IC-M330GE): Less than ±0.75 kHz
- Antenna impedance: 50 Ω nominal
- Dimensions (approximately, projections not included):
  - 156.5 (W) × 66.5 (H) × 110.1 (D) mm,
  - 6.2 (W) × 2.6 (H) × 4.3 (D) in
- Weight (approximately): 730 g, 1.6 lb

### ◇ Transmitter

- Output power: 25 W or 1 W
- Modulation system: Variable reactance frequency modulation
- Maximum frequency deviation: ±5 kHz
- Spurious emissions:
  - IC-M330/IC-M330G Less than -70 dBc (High power)
  - Less than -56 dBc (Low power)
  - IC-M330E/IC-M330GE Less than 0.25 μW

### ◇ Receiver

- Receive system: Double conversion superheterodyne
- Sensitivity:
  - FM IC-M330/IC-M330G 0.22 μV (typical) at 12 dB SINAD
  - IC-M330E/IC-M330GE -5 dBμ emf (typical) at 20 dB SINAD
  - DSC (CH70) -5 dBμ emf (typical) (1% BER)
- Squelch sensitivity:
  - IC-M330/IC-M330G Less than 0.32 μV
  - IC-M330E/IC-M330GE Less than -2 dBμ emf
- Intermodulation rejection ratio:
  - FM IC-M330/IC-M330G More than 70 dB
  - IC-M330E/IC-M330GE More than 68 dB
  - DSC (CH70) More than 68 dBμ emf (1% BER)
- Spurious response rejection ratio:
  - FM More than 70 dB
  - DSC (CH70) More than 73 dBμ emf (1% BER)
- Adjacent channel selectivity:
  - FM More than 70 dB
  - DSC (CH70) More than 73 dBμ emf (1% BER)
- Audio output power:
  - Internal More than 2 W
  - External More than 4.5 W

All stated specifications are subject to change without notice or obligation.

◇ **GPS Antenna**

- Frequency : 1575.42 MHz
- Channel: Acquisition, tracking: Maximum 24ch  
Calculation: Maximum 12ch
- Differential satellites: WAAS, EGNOS, MSAS, GAGAN
- GLONASS receiving frequency: 1602 MHz

◇ **Dimensions**

Unit: mm (inch)

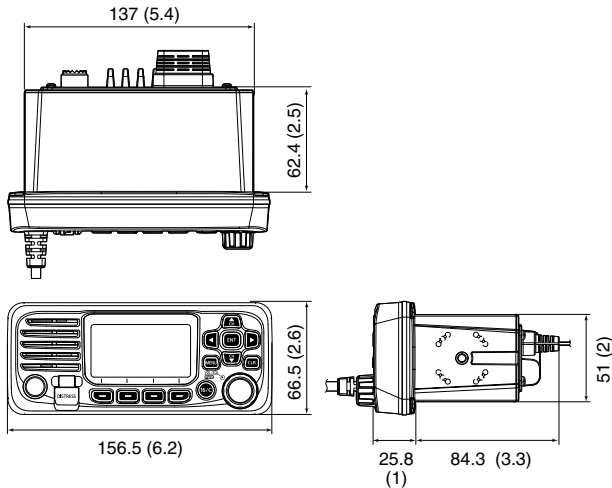

■ **Options**

- **MBF-5** FLUSH MOUNT KIT  
To mount the transceiver to a panel.
- **MA-500TR** CLASS B AIS TRANSPONDER  
To transmit individual DSC calls to a selected AIS targets.



# 11 TROUBLESHOOTING

PROBLEM	POSSIBLE CAUSE	SOLUTION	REFERENCE
The transceiver does not turn ON.	<ul style="list-style-type: none"> <li>• Bad connection to the power supply.</li> <li>• The fuse is blown.</li> </ul>	<ul style="list-style-type: none"> <li>• Check the connection to the transceiver and power supply.</li> <li>• Repair the problem, and then replace the fuse.</li> </ul>	<p>p. 53</p> <p>p. 54</p>
Little or no sound comes from the speaker.	<ul style="list-style-type: none"> <li>• Squelch level is set too high.</li> <li>• Volume level is set too low.</li> </ul>	<ul style="list-style-type: none"> <li>• Set the squelch to the threshold point.</li> <li>• Set the volume to a suitable level.</li> </ul>	<p>p. 11</p> <p>p. 11</p>
You cannot transmit with high power.	<ul style="list-style-type: none"> <li>• Some channels are set for low power or receive only by regulations.</li> <li>• The output power is set to low.</li> </ul>	<ul style="list-style-type: none"> <li>• Change channels.</li> <li>• Push [HI/LO] to select high power.</li> </ul>	<p>pp. 9,10</p> <p>p. 6</p>
Scan does not start.	<ul style="list-style-type: none"> <li>• More than 2 favorite channels are not set.</li> </ul>	<ul style="list-style-type: none"> <li>• Set the Favorite channels.</li> </ul>	<p>p. 16</p>
No beep sounds.	<ul style="list-style-type: none"> <li>• The Key Beep function is OFF.</li> </ul>	<ul style="list-style-type: none"> <li>• Turn ON the Key Beep function.</li> </ul>	<p>p. 47</p>
Individual or Group ID cannot be set.	<ul style="list-style-type: none"> <li>• The entered ID code is incorrect. First digit must be set to between '1' and '9' for an Individual ID. First digit must be set to '0' for a Group ID.</li> </ul>	<ul style="list-style-type: none"> <li>• Enter a correct ID code.</li> </ul>	<p>pp. 18, 19</p>
"??" blinks instead of the position and time.	<ul style="list-style-type: none"> <li>• 23.5 hours have passed since you manually entered the position.</li> <li>• The GPS position is invalid.</li> </ul>	<ul style="list-style-type: none"> <li>• Enter the position and time.</li> </ul>	<p>p. 20</p>
"NO POSITION" and "NO TIME" are displayed instead of the position and time.	<ul style="list-style-type: none"> <li>• The GPS signal is not correctly received.</li> <li>• The position and time have not been manually entered.</li> </ul>	<ul style="list-style-type: none"> <li>• Check the GPS antenna connection and position.</li> <li>• Check the NMEA input connection.</li> <li>• Enter the position and time.</li> </ul>	<p>p. 54</p> <p>p. 53</p> <p>p. 20</p>

# CHANNEL LIST 12

## ◇ For IC-M330/IC-M330G and USA channels for IC-M330E/IC-M330GE UK version

Channel number			Frequency (MHz)	
USA	INT	CAN	Transmit	Receive
	01	01	156.050	160.650
01A	01A		156.050	156.050
	02	02	156.100	160.700
	03	03	156.150	160.750
	04		156.200	160.800
		04A	156.200	156.200
	05		156.250	160.850
05A	05A	05A	156.250	156.250
06	06	06	156.300	156.300
	07		156.350	160.950
07A	07A	07A	156.350	156.350
08	08	08	156.400	156.400
09	09	09	156.450	156.450
10	10	10	156.500	156.500
11	11	11	156.550	156.550
12	12	12	156.600	156.600
13 <sup>*1</sup>	13	13 <sup>*2</sup>	156.650	156.650
14	14	14	156.700	156.700
15 <sup>*3</sup>	15 <sup>*2</sup>	15 <sup>*2</sup>	156.750	156.750
16	16	16	156.800	156.800
17 <sup>*2</sup>	17	17 <sup>*2</sup>	156.850	156.850
	18		156.900	161.500
18A	18A	18A	156.900	156.900
	19		156.950	161.550
19A	19A	19A	156.950	156.950
	19B		Rx only	161.550
20	20	20 <sup>*2</sup>	157.000	161.600
20A	20A		157.000	157.000

Channel number			Frequency (MHz)	
USA	INT	CAN	Transmit	Receive
	20B		Rx only	161.600
	21		157.050	161.650
21A	21A	21A	157.050	157.050
		21B	Rx only	161.650
	22		157.100	161.700
22A	22A	22A	157.100	157.100
	23	23	157.150	161.750
23A	23A		157.150	157.150
		23B	Rx only	161.750
24		24	157.200	161.800
25		25	157.250	161.850
		25B	Rx only	161.850
26		26	157.300	161.900
27	27	27	157.350	161.950
	27A		157.350	157.350
28	28	28	157.400	162.000
	28A		157.400	157.400
		28B	Rx only	162.000
	60	60	156.025	160.625
	61		156.075	160.675
		61A	156.075	156.075
	62		156.125	160.725
		62A	156.125	156.125
	63		156.175	160.775
63A	63A	63A	156.175	156.175
	64	64	156.225	160.825
		64A	156.225	156.225
	65		156.275	160.875

Channel number			Frequency (MHz)	
USA	INT	CAN	Transmit	Receive
65A	65A	65A <sup>*2</sup>	156.275	156.275
	66		156.325	160.925
66A	66A	66A <sup>*2</sup>	156.325	156.325
67 <sup>*1</sup>	67	67	156.375	156.375
68	68	68	156.425	156.425
69	69	69	156.475	156.475
71	71	71	156.575	156.575
72	72	72	156.625	156.625
73	73	73	156.675	156.675
74	74	74	156.725	156.725
	75 <sup>*2</sup>	75 <sup>*2</sup>	156.775	156.775
	76 <sup>*2</sup>	76 <sup>*2</sup>	156.825	156.825
77 <sup>*1</sup>	77	77 <sup>*2</sup>	156.875	156.875
	78		156.925	161.525
78A	78A	78A	156.925	156.925
	78B		Rx only	161.525
	79		156.975	161.575
79A	79A	79A	156.975	156.975
	79B		Rx only	161.575
	80		157.025	161.625
80A	80A	80A	157.025	157.025
	81		157.075	161.675
81A	81A	81A	157.075	157.075
	82		157.125	161.725
82A	82A	82A	157.125	157.125
	83		157.175	161.775
83A	83A	83A	157.175	157.175
		83B	Rx only	161.775

Channel number			Frequency (MHz)	
USA	INT	CAN	Transmit	Receive
84		84	157.225	161.825
85		85	157.275	161.875
86		86	157.325	161.925
87	87	87	157.375	157.375
88	88	88	157.425	157.425

WX channel	Frequency (MHz)	
	Transmit	Receive
1	RX only	162.550
2	RX only	162.400
3	RX only	162.475
4	RX only	162.425
5	RX only	162.450
6	RX only	162.500
7	RX only	162.525
8	RX only	161.650
9	RX only	161.775
10	RX only	163.275

\*1 Momentary high power.

\*2 Low power only.

\*3 Rx only.

**NOTE:** When the “CH Display” setting in the Menu screen is set to “4 Digits,” the channel number is displayed in 4 digits. (For example: “01A” is displayed as “1001.”)

# 12 CHANNEL LIST

## ◇ For IC-M330E/IC-M330GE

### ● International channels

CH	Frequency (MHz)		CH	Frequency (MHz)		CH	Frequency (MHz)		CH	Frequency (MHz)		CH	Frequency (MHz)		CH	Frequency (MHz)	
	Transmit	Receive		Transmit	Receive		Transmit	Receive		Transmit	Receive		Transmit	Receive		Transmit	Receive
01	156.050	160.650	13	156.650	156.650	21	157.050	161.650	61	156.075	160.675	73	156.675	156.675	81	157.075	161.675
02	156.100	160.700	14	156.700	156.700	22	157.100	161.700	62	156.125	160.725	74	156.725	156.725	82	157.125	161.725
03	156.150	160.750	15 <sup>*1</sup>	156.750	156.750	23	157.150	161.750	63	156.175	160.775	75 <sup>*3</sup>	156.775	156.775	83	157.175	161.775
04	156.200	160.800	16	156.800	156.800	24	157.200	161.800	64	156.225	160.825	76 <sup>*3</sup>	156.825	156.825	84	157.225	161.825
05	156.250	160.850	17 <sup>*1</sup>	156.850	156.850	25	157.250	161.850	65	156.275	160.875	77	156.875	156.875	85	157.275	161.875
06	156.300	156.300	18	156.900	161.500	26	157.300	161.900	66	156.325	160.925	78	156.925	161.525	86	157.325	161.925
07	156.350	160.950	19	156.950	161.550	27	157.350	161.950	67	156.375	156.375	1078	156.925	156.925	87	157.375	157.375
08	156.400	156.400	1019	156.950	156.950	28	157.400	162.000	68	156.425	156.425	2078	Rx only	161.525	88	157.425	157.425
09	156.450	156.450	2019	Rx only	161.550	31 <sup>*2</sup>	157.550	157.550	69	156.475	156.475	79	156.975	161.575	P4 <sup>*4</sup>	161.425	161.425
10	156.500	156.500	20	157.000	161.600	1037 <sup>*4</sup>	157.850	157.850	71	156.575	156.575	1079	156.975	156.975			
11	156.550	156.550	1020	157.000	157.000	60	156.025	160.625	72	156.625	156.625	2079	Rx only	161.575			
12	156.600	156.600	2020	Rx only	161.600							80	157.025	161.625			

\*1 Channels 15 and 17 may also be used for on-board communications provided the effective radiated power does not exceed 1 W, and subject to the national regulations of the administration concerned when these channels are used in its territorial waters.

\*2 Low power only, for only the Dutch version.

\*3 The output power of channels 75 and 76 are limited to low power (1 W) only. The use of these channels should be restricted to navigation-related communications only and all precautions should be taken to avoid harmful interference to channel 16, for example by means geographical separation.

\*4 UK Marina Channels: M1=1037 (157.850 MHz), M2=P4 (161.425 MHz) for only the UK and Dutch version.

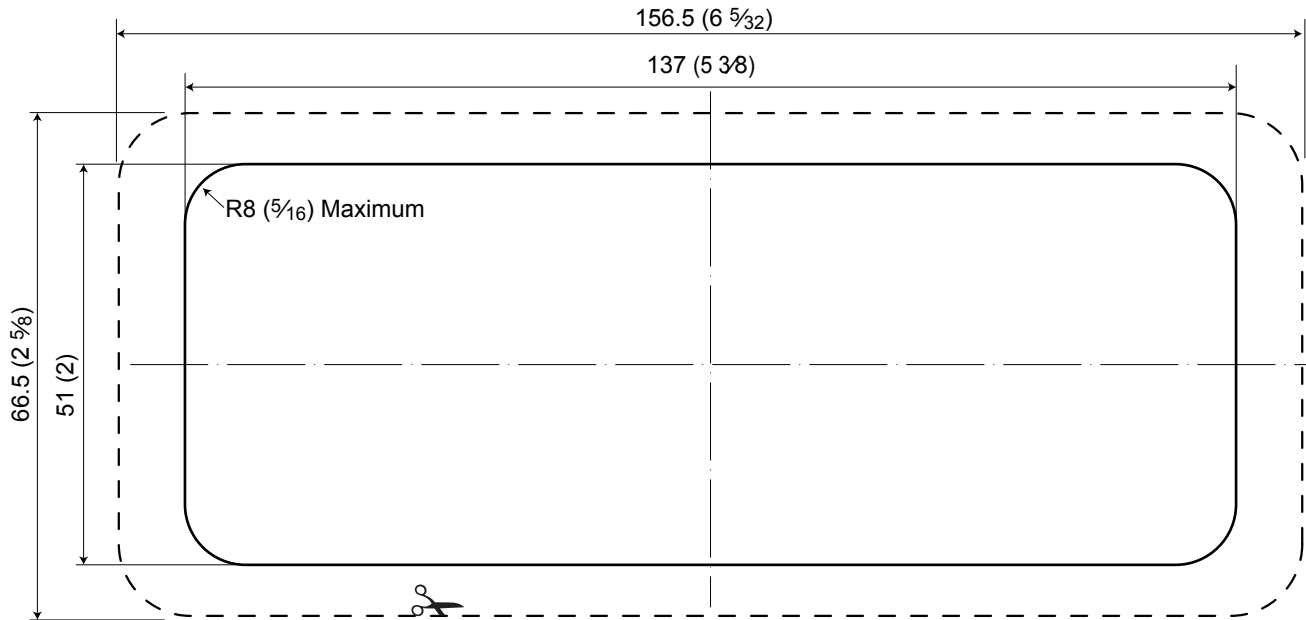

Unit: mm (inch)