



INSTRUCTION MANUAL

VHF MARINE TRANSCEIVER

IC-M73 IC-M73EURO

This device complies with Part 15 of the FCC Rules. Operation is subject to the condition that this device does not cause harmful interference.

Icom Inc.



IC-M73



IC-M73EURO

FOREWORD

Thank you for purchasing this Icom product. The IC-M73/IC-M73EURO VHF MARINE TRANSCEIVER is designed and built with Icom's state of the art technology and craftsmanship. With proper care, this product should provide you with years of trouble-free operation.

IMPORTANT

READ ALL INSTRUCTIONS carefully and completely before using the transceiver.

SAVE THIS INSTRUCTION MANUAL – This instruction manual contains important operating instructions for the IC-M73/IC-M73EURO.

EXPLICIT DEFINITIONS

WORD	DEFINITION
⚠ DANGER!	Personal death, serious injury or an explosion may occur.
⚠ WARNING!	Personal injury, fire hazard or electric shock may occur.
CAUTION	Equipment damage may occur.
NOTE	If disregarded, inconvenience only. No risk of personal injury, fire or electric shock.

FEATURES

🔊 **Submersible construction**

Built tough to withstand the punishing marine environment, the IC-M73/IC-M73EURO's submersible construction meets IPX8 ratings of the International Standard IEC 60529 (2001).

In addition, the speaker grill structure with a water self-draining Aquaquake function is helpful for easily removing rain or seawater.

🔊 **Dualwatch and Tri-watch functions**

Convenient functions that allow you to monitor the distress channel (Ch 16) while receiving one other channel of your choice (Dualwatch), or while receiving one other channel of your choice and the Call channel (Tri-watch*). See page 16 for details.

* May not be available depending on the transceiver version.

🔊 **Voice recorder function**

IC-M73/IC-M73EURO has a voice recorder function* which can automatically, or manually, record the received signal. The automatic (60 seconds) and manual (30 seconds) recordings are recorded separately into memory in the transceiver.

* May not be available depending on the transceiver version.

🔊 **Bass booster function**

The TX/RX bass booster functions* boosts the frequencies to increase the bass level, if desired.

* May not be available depending on the transceiver version.

PRECAUTIONS

⚠ short the terminals of the battery pack.

⚠ Use and charge only specified Icom battery packs with Icom radios or Icom chargers. Only Icom battery packs are tested and approved for use with Icom radios or charged with Icom chargers. Using third-party or counterfeit battery packs or chargers may cause smoke, fire, or cause the battery to burst.

⚠ connect the transceiver to an AC outlet. This may pose a fire hazard or result in an electric shock.

⚠ hold the transceiver so that the antenna is closer than 2.5 cm (1 inch) from exposed parts of the body, especially the face or eyes, while transmitting. The transceiver will perform best if the microphone is 5 to 10 cm (2 to 4 inches) away from the lips and the transceiver is vertical.

connect the transceiver to a power source other than the products specified by Icom. Such a connection will ruin the transceiver.

the flexible antenna and battery pack are securely attached to the transceiver, and that the antenna and battery pack are dry before attachment. Exposing the inside of the transceiver to water will result in serious damage to the transceiver.

The transceiver meets IPX8 requirements for waterproof protection. However, once the transceiver has been dropped, waterproof protection cannot be guaranteed because of possible damage to the transceiver's case or the waterproof seal.

use or place the transceiver in direct sunlight or in areas with temperatures below -20°C (-4°F) or above $+60^{\circ}\text{C}$ ($+140^{\circ}\text{F}$) for the EXP/USA versions, below -15°C ($+5^{\circ}\text{F}$) or above $+55^{\circ}\text{C}$ ($+131^{\circ}\text{F}$) for the CHN/EUR/FRG/HOL/UK versions, and below -10°C ($+14^{\circ}\text{F}$) or above $+55^{\circ}\text{C}$ ($+131^{\circ}\text{F}$) for the AUS versions.

use harsh solvents such as benzine or alcohol when cleaning, as they will damage the transceiver surfaces.

push [PTT] when not actually intending to transmit.

modify the transceiver. The transceiver warranty does not cover any problems caused by unauthorized modification.

operate the transceiver near unshielded electrical blasting caps or in an explosive atmosphere. the transceiver out of the reach of children.

the transceiver at least 0.9 meter (3.0 feet) away from your vessel's magnetic navigation compass.

Icom, Icom Inc. and the Icom logo are registered trademarks of Icom Incorporated (Japan) in Japan, the United States, the United Kingdom, Germany, France, Spain, Russia and/or other countries.

RADIO OPERATOR WARNING



Your Icom radio generates RF electromagnetic energy during transmit mode. This radio is designed for and classified as “General Population Use” in an uncontrolled environment.

This radio has been evaluated for compliance at the distance of 2.5 cm (1 inch) with the FCC and IC RF exposure limits for “General Population Use.” In addition, your Icom radio complies with the following Standards and Guidelines with regard to RF energy and electromagnetic energy levels and evaluation of such levels for exposure to humans:

- FCC OET Bulletin 65 Edition 01-01 Supplement C, Evaluating Compliance with FCC Guidelines for Human Exposure to Radio Frequency Electromagnetic Fields.
- American National Standards Institute (C95.1-1992), IEEE Standard for Safety Levels with Respect to Human Exposure to Radio Frequency Electromagnetic Fields, 3 kHz to 300 GHz.
- American National Standards Institute (C95.3-1992), IEEE Recommended Practice for the Measurement of Potentially Hazardous Electromagnetic Fields— RF and Microwave.
- The following accessories are authorized for use with this product. Use of accessories other than those specified may result in RF exposure levels exceeding the FCC and IC requirements for wireless RF exposure.; Belt Clip (MB-103), Rechargeable Li-ion Battery Pack (BP-245N).



To ensure that your exposure to RF electromagnetic energy is within the FCC and IC allowable limits for general population use, always adhere to the following guidelines:

lines:

- **DO NOT** operate the radio without a proper antenna attached, as this may damage the radio and may also cause you to exceed FCC and IC RF exposure limits. A proper antenna is the antenna supplied with this radio by the manufacturer or antenna specifically authorized by the manufacturer for use with this radio.
- **DO NOT** transmit for more than 50% of total radio use time (“50% duty cycle”). Transmitting more than 50% of the time can cause FCC and IC RF exposure compliance requirements to be exceeded. The radio is transmitting when the “transmit indicator” appears on the LCD. You can cause the radio to transmit by pressing the “PTT” switch.
- **ALWAYS** keep the antenna at least 2.5 cm (1 inch) away from the body when transmitting and only use the Icom belt clip which is listed on page 43 when attaching the radio to your belt, etc., to ensure FCC and IC RF exposure compliance requirements are not exceeded. To provide the recipients of your transmission the best sound quality, hold the antenna at least 5 cm (2 inches) from your mouth, and slightly off to one side.

The information listed above provides the user with the information needed to make him or her aware of RF exposure, and what to do to assure that this radio operates within the FCC and IC RF exposure limits of this radio.

Electromagnetic Interference/Compatibility

During transmissions, your Icom radio generates RF energy that can possibly cause interference with other devices or systems. To avoid such interference, turn off the radio in areas where signs are posted to do so. **DO NOT** operate the transmitter in areas that are sensitive to electromagnetic radiation such as hospitals, aircraft, and blasting sites.

FCC INFORMATION

FOR CLASS A UNINTENTIONAL RADIATORS

This equipment has been tested and found to comply with the limits for a Class A digital device, pursuant to part 15 of the FCC Rules. These limits are designed to provide reasonable protection against harmful interference when the equipment is operated in a commercial environment. This equipment generates, uses, and can radiate radio frequency energy and, if not installed and used in accordance with the instruction manual, may cause harmful interference to radio communications. Operation of this equipment in a residential area is likely to cause harmful interference in which case the user will be required to correct the interference at his own expense.

CAUTION: Changes or modifications to this device, not expressly approved by Icom Inc., could void your authority to operate this device under FCC regulations.

COUNTRY CODE LIST

• ISO 3166-1

	Country	Codes		Country	Codes
1	Austria	AT	18	Liechtenstein	LI
2	Belgium	BE	19	Lithuania	LT
3	Bulgaria	BG	20	Luxembourg	LU
4	Croatia	HR	21	Malta	MT
5	Czech Republic	CZ	22	Netherlands	NL
6	Cyprus	CY	23	Norway	NO
7	Denmark	DK	24	Poland	PL
8	Estonia	EE	25	Portugal	PT
9	Finland	FI	26	Romania	RO
10	France	FR	27	Slovakia	SK
11	Germany	DE	28	Slovenia	SI
12	Greece	GR	29	Spain	ES
13	Hungary	HU	30	Sweden	SE
14	Iceland	IS	31	Switzerland	CH
15	Ireland	IE	32	Turkey	TR
16	Italy	IT	33	United Kingdom	GB
17	Latvia	LV			

IN CASE OF EMERGENCY

If your vessel requires assistance, contact other vessels and the Coast Guard by sending a distress call on Channel 16.

○ **USING CHANNEL 16**

DISTRESS CALL PROCEDURE

1. "MAYDAY MAYDAY MAYDAY."
2. "THIS IS" (name of vessel)
3. Say your call sign or other indication of the vessel.
4. "LOCATED AT" (your position)
5. State the nature of the distress and assistance required.
6. Give any other information which might facilitate the rescue.

RECOMMENDATION

after exposure to saltwater, and dry it before operation. Otherwise, the transceiver's keys, switches and controllers may become inoperable due to salt crystallization.

wash the transceiver in water if there is any reason to suspect the waterproofing may not be effective. For example, in cases where the transceiver/battery pack is cracked or broken, or has been dropped, or when the battery pack is detached from the transceiver.

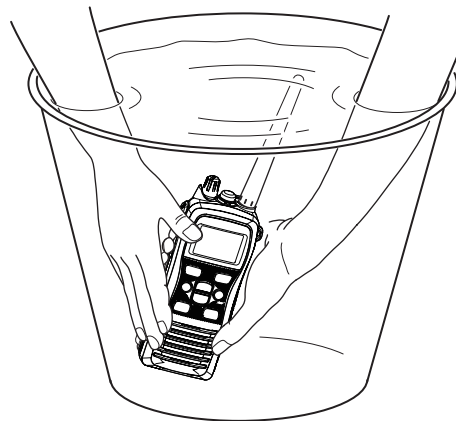

TABLE OF CONTENTS

FOREWORD.....	i
IMPORTANT.....	i
EXPLICIT DEFINITIONS	i
FEATURES	i
PRECAUTIONS.....	ii
RADIO OPERATOR WARNING.....	iii
FCC INFORMATION	v
COUNTRY CODE LIST	v
IN CASE OF EMERGENCY.....	vi
RECOMMENDATION.....	vi
TABLE OF CONTENTS	vii

1 OPERATING RULES	1
2 SUPPLIED ACCESSORIES AND ATTACHMENTS.....	2-3
■ Supplied accessories	2
■ Attachments.....	2
3 PANEL DESCRIPTION	4-7
■ Front, top and side panels	4
■ Function display	6
4 BASIC OPERATION	8-13
■ Channel selection	8
■ Receiving and transmitting	11
■ Call channel programming	12
■ Lock function.....	12
■ Monitor function	12
■ Adjusting the squelch level	13
■ AquaQuake water draining function	13
5 SCAN OPERATION (Except for the Dutch version).....	14-15
■ Scan types	14
■ Setting Favorite channels.....	15
■ Starting a scan.....	15

6 DUALWATCH/TRI-WATCH	16
■ Description.....	16
■ Operation	16
7 FUNCTION MODE OPERATION.....	17-24
■ About the function mode	17
■ Manual recording function (Depending on versions).....	18
■ Automatic recording function (Depending on versions).....	19
■ Play back function (Depending on versions).....	20
■ Channel naming function	21
■ Opening comment entry function	22
■ ATIS code programming (For only the Dutch and German versions).....	23
■ Backlight function.....	24
8 SET MODE.....	25-30
■ SET mode programming	25
■ SET mode items	26
9 BATTERY CHARGING.....	31-34
■ Battery cautions	31
■ Supplied battery charger.....	33
■ Optional battery chargers	34
10 OPTIONAL SWIVEL BELT CLIP	35
■ Attaching.....	35
■ Detaching.....	35
11 OPTIONAL SPEAKER-MICROPHONE	36
■ HM-167 descriptions	36
■ Attaching.....	36
12 TROUBLESHOOTING	37
13 SPECIFICATIONS.....	38-39
14 VHF MARINE CHANNEL LIST.....	40-42
15 OPTIONS	43
INDEX	44-45

◇ Priorities

- Read all rules and regulations pertaining to call priorities, and keep an up-to-date copy handy. Safety and distress calls take priority over all others.
- You must monitor Channel 16 when you are not operating on another channel.
- False or fraudulent distress calls are prohibited under law.

◇ Privacy

- Information overheard, but not intended for you, cannot lawfully be used in any way.
- Indecent or profane language is prohibited.

◇ Radio licenses

(1) SHIP STATION LICENSE

You may require a current radio station license before using the transceiver. It is unlawful to operate a ship station which is not licensed, but required to be.

If required, contact your dealer or the appropriate government agency for a Ship-Radiotelephone license application. This government-issued license states the call sign which is your craft's identification for radio purposes.

(2) OPERATOR'S LICENSE

A Restricted Radiotelephone Operator Permit is the license most often held by small vessel radio operators when a radio is not required for safety purposes.

If required, the Restricted Radiotelephone Operator Permit must be posted or kept with the operator. If required, only a licensed radio operator may operate a transceiver.

However, non-licensed individuals may talk over a transceiver if a licensed operator starts, supervises, ends the call and makes the necessary log entries.

A current copy of the applicable government rules and regulations is only required to be on hand for vessels in which a radio telephone is compulsory. However, even if you are not required to have these on hand it is your responsibility to be thoroughly acquainted with all pertinent rules and regulations.

NOTE: Even though the transceiver is capable of operation on VHF marine channels 3, 21, 23, 61, 64, 81, 82 and 83, according to FCC regulations these simplex channels cannot be lawfully used by the general population in USA waters.

2

SUPPLIED ACCESSORIES AND ATTACHMENTS

■ Supplied accessories

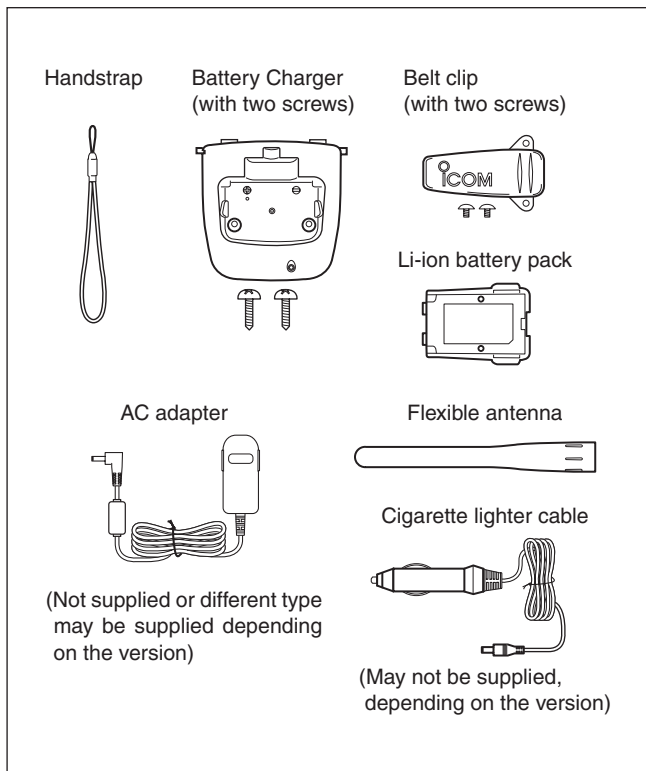

■ Attachments

◇ Flexible antenna

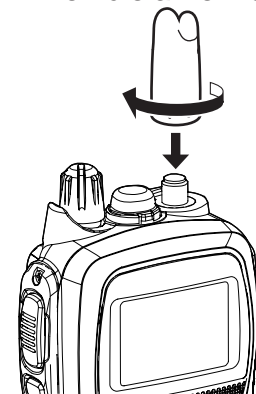

Connect the supplied flexible antenna to the antenna connector.

CAUTION:

- NEVER carry the transceiver by holding the antenna.
- Transmitting without an antenna may damage the transceiver.

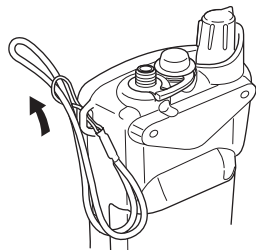

◇ Handstrap

Pass the handstrap through the loop on the top corner of the transceiver, as illustrated to the left. This facilitates carrying the transceiver.

◆ **Battery pack**

① Attach the battery pack into the transceiver.

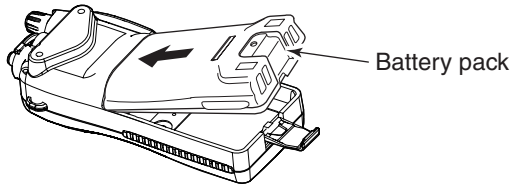

② Lock the battery pack with the latch.

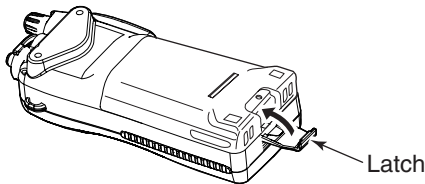

/// **CAUTION:**

/// **NEVER** remove or attach the battery pack when the transceiver is wet or soiled. This may result in water or dust getting into the transceiver and battery pack, and may result in them being damaged.

/// **Be careful!** The latch is tightly locked, so use caution when releasing it. **DO NOT** use your finger nail. Use the edge of a coin or screwdriver tip to carefully release it.

◆ **Belt clip**

Attach the belt clip to the transceiver.

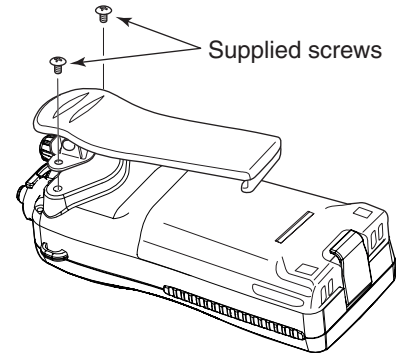

3

PANEL DESCRIPTION

■ Front, top and side panels

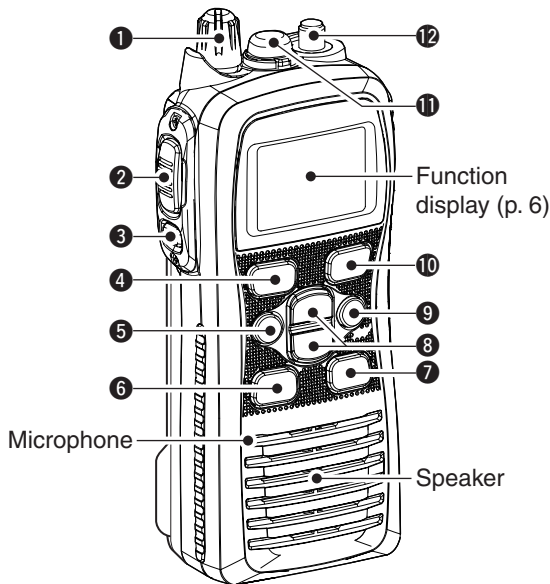

① VOLUME CONTROL [VOL]

Turns ON power and adjusts the audio level.

② PTT SWITCH [PTT]

Hold down to transmit; release to receive.

③ MONITOR KEY [⏏]

- Manually opens the squelch to monitor the channel while held down. (p. 12)
- Push this switch, then adjust the squelch level with [▲]/[▼]. (p. 13)
- While holding down this switch, turn the ON power to enter the SET mode. (p. 25)

④ CHANNEL 16 KEY [16/C]

- Selects Channel 16 when pushed. (p. 8)
- Selects the Call channel when pushed for 1 second. (p. 8)
- Enters the Call channel write mode when the Call channel is selected and this key is held down for 3 seconds. (p. 12)

⑤ FUNCTION KEY [F]

- Enters the Function mode when pushed. (p. 17)
- The AquaQuake function is activated when held down for 1 second. (p. 13)
- While holding down this key, turn ON the power to enter the recording counter mode.

6 SCAN KEY [SCAN•DUAL]

- Starts and stops normal or priority scan when pushed. (pp. 14, 15)
- Enters the Watch mode when held down for 1 second. (p. 16)

7 CHANNEL/WEATHER CHANNEL KEY [CH/WX•U/I/C] (IC-M73), [CH] (IC-73EURO)

- Selects and toggles the regular channels and weather channel* when pushed. (pp. 9, 10)
- Selects the U.S.A., International, Canadian or ATIS channel group* when held down for 1 second. (p. 9)
 - The function display shows which channel group is active.
- Push to return to the display before you selected the channel when the priority channel or the Call channel is selected.

* Selectable contents differ depending on the transceiver version.

/// **NOTE:** [CH/WX•U/I/C] and [CH] are described as [CH/WX•U/I/C] in this instruction manual.

8 CHANNEL UP/DOWN KEYS [▲]/[▼]

- Selects the operating channel. (pp. 8–10)
- Selects the SET mode option of the item. (p. 25)
- Selects the SET mode item when pushed along with [I/▶]. (p. 25)
- Checks Favorite (TAG) channels, or changes the scanning direction during a scan. (p. 15)
- Selects the Function mode item. (p. 17)

9 TRANSMIT POWER/LOCK KEY [H/L•LOCK]

- Selects high, middle or low power when pushed. (p. 11)
- Toggles the lock function ON/OFF when held down for 1 second. (p. 12)

10 FAVORITE (TAG) KEY [FAV•★]

- Push this key to sequentially select the Favorite (TAG) channels, while ignoring untagged channels, in a channel group. (p. 15)
- Hold down for 1 second to set or clear the displayed channel as a Favorite (TAG) channel. (p. 15)
- While holding down this key, turn ON power to clear or set all Favorite (TAG) channels in the selected channel group. (p. 15)

11 SPEAKER-MICROPHONE CONNECTOR [SP MIC]

Connects the optional external speaker-microphone. (p. 36)

/// **NOTE:** Attach the [SP MIC] cap when the optional speaker-microphone is not used.

12 ANTENNA CONNECTOR

Connects the supplied antenna. (p. 2)

3 PANEL DESCRIPTION

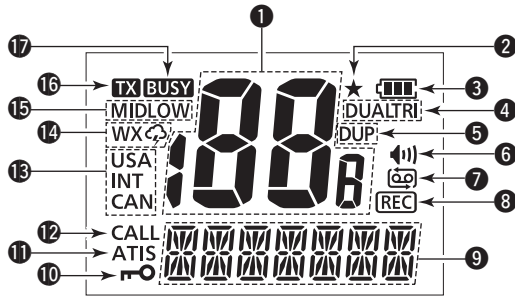

1 • Indicates the selected operating channel number.

• In the SET mode, indicates the selected value.

2 (p. 15) Appears when a Favorite (TAG) channel is selected.

3 Indicates remaining battery power.

Indication				
Battery level	Full	Middle	Low	No battery (Charging required)

blinks when the battery is overcharged (or over voltage).

4 (p. 16) “DUAL” blinks during dualwatch; “TRI” blinks during tri-watch.

5 (p. 9) Appears when a duplex channel is selected.

6 (p. 12) Appears when the monitor function is activated.

7 (p. 19) Appears when the automatic recording is activated. This may not appear depending on the transceiver version.

8 Appears while the receiving audio is recording. (pp. 18, 19)
This may not appear depending on the transceiver version.

9 • Indicates or scrolls the operating channel name, comment or ATIS code*. (pp. 21–23)

*For only the Dutch and German versions.

• In the SET and Function mode, indicates or scrolls the selected item. (pp. 25–30)

• “SCAN 16” is displayed during a Priority scan; “SCAN” appears during a Normal scan. (p. 15)

10 (p. 12) Appears when the lock function is activated.

11 ATIS ICON (pp. 9, 23)

Appears when the channel group, in which ATIS function is activated, is selected or while programming an ATIS code.

- For only the HOL and FRG versions.

12 CALL CHANNEL ICON (p. 8)

Appears when the Call channel is selected.

13 CHANNEL GROUP ICON (p. 9)

“USA” appears when U.S.A.*1; “INT” appears when International; “CAN” appears when the Canadian*2; “ATIS” appears when ATIS*3 channel group is selected.

*1Only USA, UK, EXP, CHN and AUS versions.

*2Only USA, EXP and CHN versions.

*3Only HOL version.

14 WEATHER CHANNEL/WEATHER ALERT ICONS* (p. 10)

- “WX” appears when the Weather channel group is selected.
- “WX ” appears when the Weather alert function is activated.

*Selectable on only the USA, EXP, and AUS versions.

15 TRANSMIT POWER ICONS (p. 11)

- “LOW” appears when low power is selected.
- “MID” appears when mid power is selected.
- No indication appears when high power is selected.

16 TRANSMIT ICON (p. 11)

Appears during transmit.

17 BUSY ICON (pp. 11, 12)

Appears when a signal is received, or the squelch opens.

■ Channel selection

IMPORTANT! Prior to using the transceiver for the first time, fully charge the battery pack. This will help maximize the capability and life of the battery. To avoid damage to the transceiver, turn OFF the radio while charging.

◇ Channel 16

Channel 16 is the distress and safety channel. It is used for establishing initial contact with another station, and for emergency communications. Channel 16 is automatically monitored during both Dualwatch and Tri-watch. While standing by, you must monitor Channel 16.

- ① Push [16/C] to select Channel 16.
- ② Push [CH/WX•U/I/C] to return to the condition before selecting Channel 16, or push [▲]/[▼] to select the operating channel.

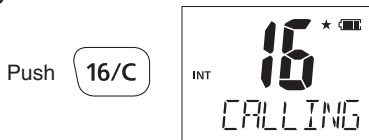

◇ Call channel

Each regular channel group has separate leisure-use call channels. The Call channel is monitored during Tri-watch. The Call channels can be reprogrammed (p. 12) and may be used to store your most often-used channels in each channel group for quick recall.

- ① Hold down [16/C] for 1 second to select the Call channel.
 - “CALL” and the call channel number appear.
 - The Call channel can be re-programmed. See the “Call channel programming” on page 12 for details.
- ② Push [CH/WX•U/I/C] to return to the screen before you selected Call channel, or push [▲]/[▼] to select an operating channel.

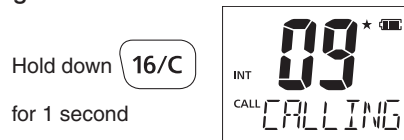

The transceiver has U.S.A.*1, International, Canadian*2 and ATIS*3 channels. You must select the proper channels for the operating area.

*1 Only USA, UK, EXP, CHN and AUS versions.

*2 Only USA, EXP and CHN versions.

*3 Only HOL version.

- ① Push **CH** to select a regular channel.
 - If the weather channel appears, push **CH** again.
- ② Push **▲▼** to select a channel.
 - “DUP” appears for duplex channels.
- ③ To change the channel group, hold down **CH** for 1 second.
 - Repeat until you reach the desired channel group.

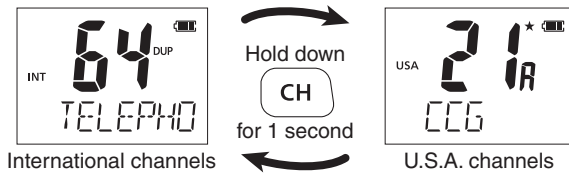

For Dutch version

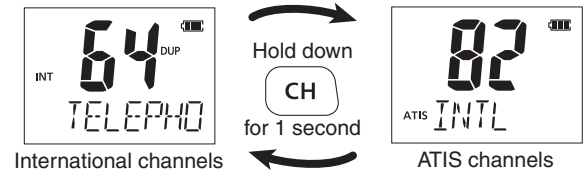

For U.S.A., Export, and China versions

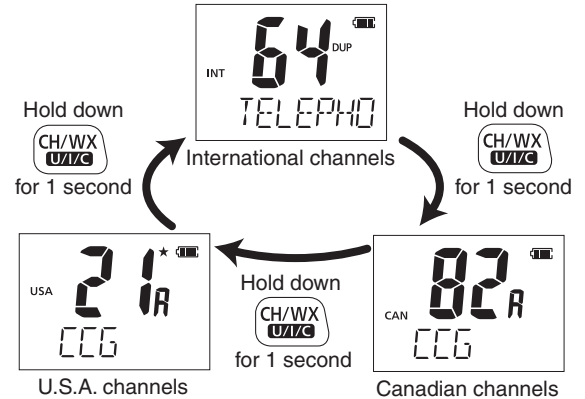

4 BASIC OPERATION

◇ Weather channels

The transceiver has 10 pre-programmed weather channels*. These are used for monitoring broadcasts from NOAA (National Oceanographic and Atmospheric Administration.) The transceiver can automatically detect a weather alert tone on the selected weather channel or while scanning.

See the “SET mode items” on page 26 for details.

* For only the USA, EXP, and AUS versions.

- ① Push **[CH/WX•U/I/C]** to select the weather channel group.
- ② Push **[▲]/[▼]** to select a weather channel.
- ③ Push **[CH/WX•U/I/C]** to return to the screen before you selected the Weather channel group.

CAUTION: Transmitting without an antenna may damage the transceiver.

- ① Rotate **▶** clockwise to turn ON power.
 - An opening comment scrolls across the function display.
 - Push **▶** to skip the opening comment.
- ② Set the volume and squelch level.
 - ➔ Push **▶**, and push **▼** to open the squelch.
 - ➔ Rotate **▶** to set the volume level.
 - ➔ Push **▶**, and push **▲▼** to set the squelch level.
- ③ Push **▲▼** to select the desired channel.
 - Pushing **★** selects only Favorite channels.
 - When receiving a signal, the “” icon appears while audio is heard from the speaker.
 - Further adjustment of **▶** may be necessary at this point.
- ④ Push **▶** to select the output power, if necessary.
 - “LOW” appears when low power is selected; “MID” appears when mid power is selected; no indication is displayed when high power is selected.
 - Choose low or mid power to conserve battery power; choose high power for longer distance communications.
 - Some channels are for only low transmission.
- ⑤ Hold down **▶** to transmit, and speak at your normal voice level.
 - The **TX** appears while transmitting.
 - Channel 70 cannot be used for transmission.
- ⑥ Release **▶** to receive.

To maximize the readability of your transmitted signal, pause a second after pushing **▶**. Hold the microphone 5 to 10 cm (2 to 4 inches) from your mouth, and speak at your normal voice level.

The transceiver has a power save function to conserve the battery power. The power save function automatically activates when no signal is received for 5 seconds.

To prevent accidental prolonged transmission, the transceiver has a time-out timer function*. This timer cuts OFF a transmission after 5 minutes of continuous transmission.

* For only the USA and AUS versions.

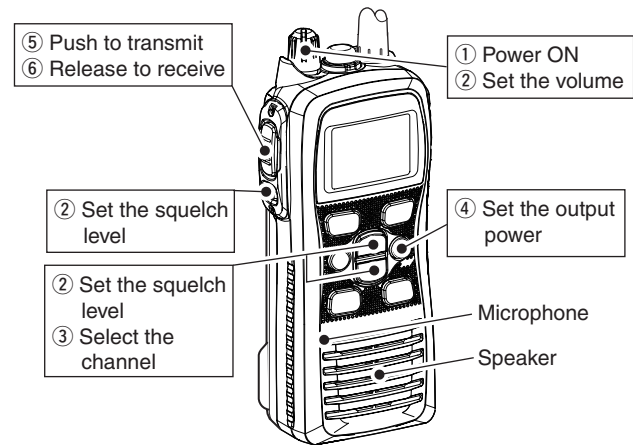



4 BASIC OPERATION

■ The Call channel key is used to select Channel 9* by default. However, you can program your most often-used channel in each channel group for quick recall.

* The channel may differ, depending on the transceiver version.

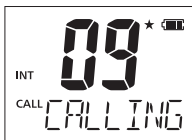
① Hold down  for 1 second several times to select the desired channel group (USA, INT, CAN, ATIS) to be programmed.



② Hold down  for 1 second to select the Call channel.

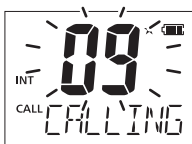

- “CALL” and Call channel number appear.



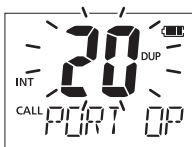

③ Hold down  again for 3 seconds (until a long beep changes to 2 short beeps) to enter the Call channel programming mode.

- The Call channel number to be programmed blinks.



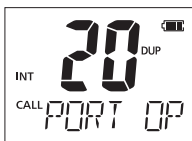

④ Push   to select the desired channel.



⑤ Push  to program the displayed channel as the Call channel.

- The Call channel number stops blinking.

■ This function electronically locks all keys (except for  and ) to prevent accidental channel changes and function access.

➔ Push  for 1 second to turn the lock function ON or OFF.

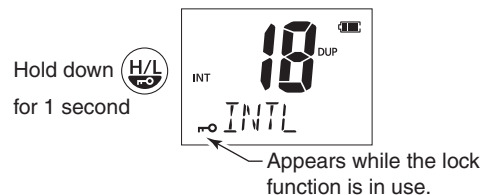

■ The monitor function releases the noise squelch mute to check the volume level. See page 27 for details of the monitor switch action.

➔ Hold down  for 1 second to activate the monitor function.

- “BUSY” and “” appear and audio is heard.

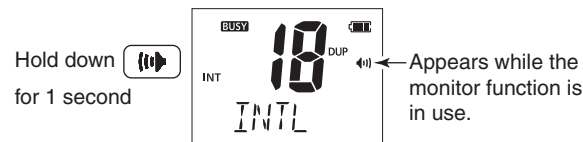

■ Adjusting the squelch level

To adjust the transceiver's squelch level, use the [▲]/[▼] keys, as described below. In order to properly receive signals, as well as for the scan to function effectively operate, the squelch must be adjusted to the proper level.

- ① Push [(F)], then adjust the squelch level with [▲]/[▼].
 - "SQL" and the squelch level are displayed.
 - There are 11 squelch levels to choose from: OP is completely open; 10 is tight squelch; 1 is loose squelch level.
 - When no key is pushed for 5 seconds, the transceiver returns to its normal condition.
- ② Push [(F)] again to return to normal operating mode.

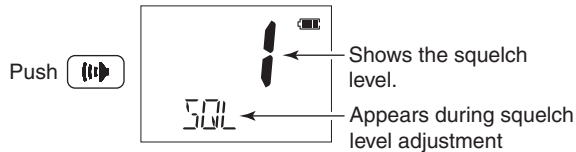

■ AquaQuake water draining function

The AquaQuake water draining function clears water away from the speaker grill. Without this function, water may muffle the sound coming from the speaker. The transceiver emits a vibrating beep when this function is activated.

- While holding down [F], the AquaQuake function is activated to clear water away from the speaker grill.
 - Beep sounds, regardless of the volume level setting.
 - Activates for 10 seconds in maximum to drain water.
 - The transceiver never accepts key operation while the Aqua-Quake function is activated.
 - The AquaQuake function can not be activated when an optional speaker-microphone is connected.

5

SCAN OPERATION (Except for the Dutch version)

■ Scan types

Scanning is an efficient way to quickly locate signals over a wide frequency range. The transceiver has a priority scan setting and normal scan setting.

In addition, the “Weather alert*” and “Auto scan” functions are also selectable for scanning. These functions can be simultaneously activated, depending on the settings in the SET mode. (pp. 26, 27)

* For only the USA, EXP, and AUS versions.

NORMAL SCAN

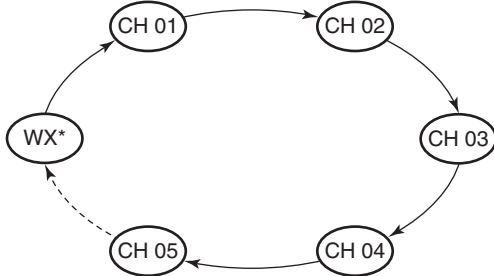

* Previously selected weather channel when weather alert function is ON.

Normal scan, like priority scan, sequentially searches through all Favorite channels. However, unlike priority scan, Channel 16 is not checked unless it is set as a Favorite channel.

Set the Favorite channels (scanned channel) before scanning.

Clear those Favorite channels which are not needed or inconveniently stop scanning, such as digital communications.

/// Choose priority or normal scan in the SET mode. (p. 26)

PRIORITY SCAN

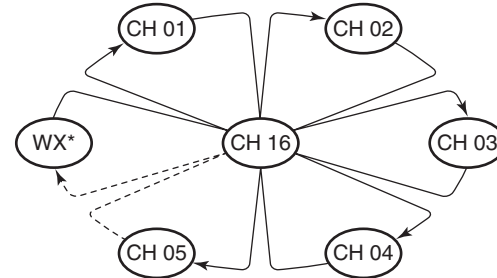

* Previously selected weather channel when weather alert function is ON

Priority scan sequentially searches through all Favorite channels while monitoring Channel 16. When a signal is detected on Channel 16, the scan pauses until the signal disappears; when a signal is detected on a channel other than Channel 16, scan becomes Dualwatch until the signal disappears.

■ Setting Favorite channels

For more efficient scanning, add desired channels as Favorite channels, or clear the Favorite for unwanted channels.

Untagged channels will be skipped during scanning. Favorite channels can be independently assigned to each channel group (USA, INT, CAN, ATIS) independently.

- ① Select the desired channel to set as a Favorite channel.
- ② Hold down [FAV•★] for 1 second to set the displayed channel as a Favorite channel.
 - “★” appears on the function display.
- ③ To cancel the Favorite channel setting, hold down [FAV•★] for 1 second.
 - “★” disappears.

✓ Clearing (or setting) All Favorite Channels in the Selected Channel Group

While holding down [FAV•★], turn ON power to clear all the Favorite channel settings in the channel group.

- Repeat above procedure to set all channels as Favorite channels.

■ Starting a scan

First, set the weather alert function, priority scan function, scan resume timer and auto scan function, using the SET mode. (pp. 26, 27)

- ① Make sure the desired channel group (e.g., USA, CAN, INT, ATIS) is selected. Move between channel groups by repeatedly pushing [CH/WX•U/I/C] for 1 second at a time.
 - When the weather alert function* is in use, select the desired weather channel with [CH/WX•U/I/C] and [▲]/[▼].
 - * For only the USA, EXP, and AUS versions.
- ② Push [SCAN•DUAL] to start a priority or normal scan.
 - “SCAN” blinks in the function display.
 - “16” appears on the comment indicator during a priority scan.
 - When a signal is received, the scan pauses until the signal disappears, or resumes after pausing 5 seconds, depending on the scan resume timer setting. (Channel 16 is still monitored during a priority scan.)
 - Push [▲]/[▼] to check the scanning of Favorite channels, change the scanning direction or resume the scan manually.
- ③ To stop the scan, push [SCAN•DUAL].
 - “SCAN” disappears.

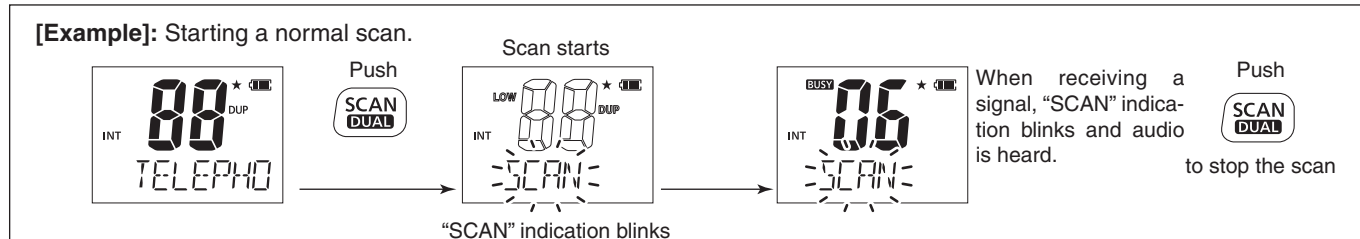

6

DUALWATCH/TRI-WATCH

■ Description

Dualwatch monitors Channel 16 while you are receiving on another channel; Tri-watch* monitors Channel 16 and the call channel while receiving on another channel.

/// *For the Dutch transceiver version
/// Only Dualwatch can be used.

DUALWATCH/TRI-WATCH SIMULATION

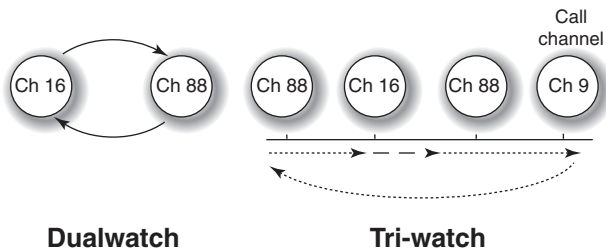

- If a signal is received on Channel 16, Dualwatch/Tri-watch pauses on Channel 16 until the signal disappears.
- If a signal is received on the Call channel during Tri-watch, Tri-watch becomes Dualwatch until the signal disappears.
- To transmit on the selected channel during Dualwatch/Tri-watch, hold down [PTT].

■ Operation

- ① Select a desired operating channel.
- ② Hold down [SCAN•DUAL] for 1 second to start Dualwatch or Tri-watch (depending on the SET mode setting; p. 27).
 - “DUAL” blinks during Dualwatch; “TRI” blinks during Tri-watch.
 - A beep tone sounds when a signal is received on Channel 16.
 - Tri-watch becomes Dualwatch when receiving a signal on the Call channel.
- ③ To cancel Dualwatch/Tri-watch, push [SCAN•DUAL] again.

[Example]: Operating tri-watch on INT channel 07.

Hold down **SCAN DUAL** for 1 second

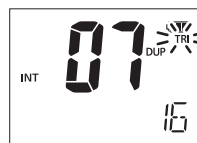

Tri-watch starts.

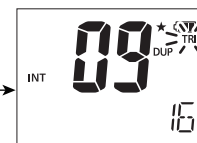

A signal is received on the Call channel.

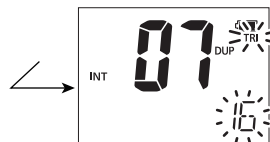

A signal received on Channel 16 always takes priority.

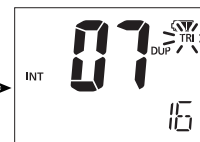

Tri-watch resumes after the signal disappears.

■ About the function mode

There are 7 transceiver functions[‡] in the function mode: Play back function[‡], Manual recording function[‡], Automatic recording function[‡], backlight function, channel naming function, opening comment entry function and the ATIS code programming function[†].

[†]For only the Dutch and German versions.

[‡]Depending on versions.

◇ Entering the function mode

- ① Push [F] to enter the function mode.
 - “PLAY” (Play back function) appears.
 - When no key is pushed for 5 seconds, the transceiver returns to its normal condition.
- ② Push [▲]/[▼] to select the desired item.
- ③ Push [H/L•LOCK] to select or decide the desired option of the item.
 - Some items exit the function mode when pushing [H/L•LOCK].
- ④ To exit the function mode, push [F].

6
7

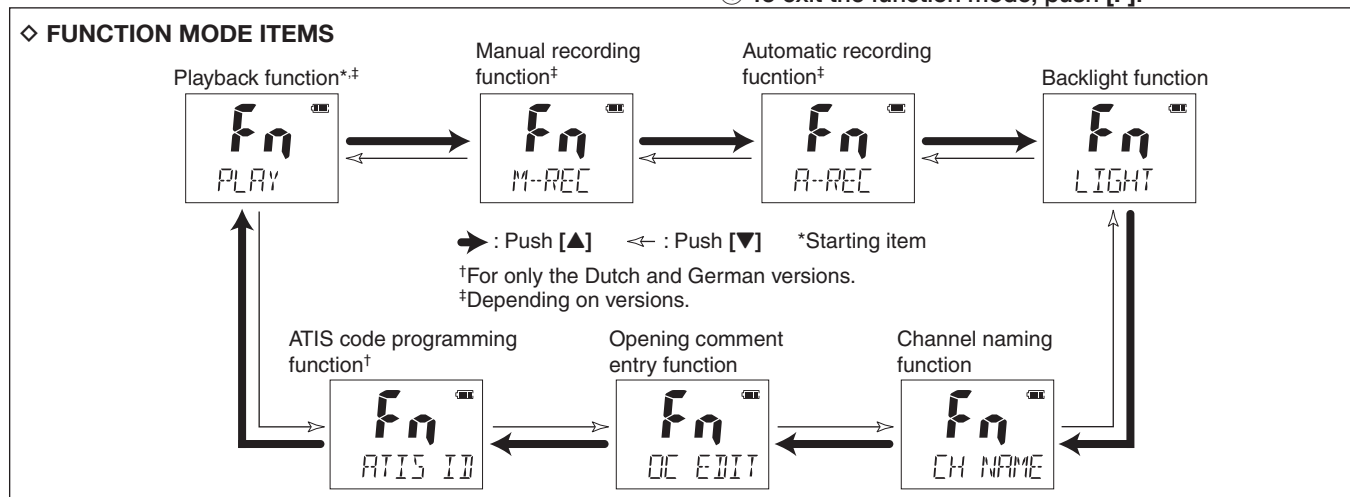

7 FUNCTION MODE OPERATION

Manual recording function (Depending on versions)

You can record the received signal whenever you want by using the manual recording function.

This function can record the received signal for maximum 30 seconds.

- ▨ The transmitted signal cannot be recorded.
- ▨ The previously recorded signal will be overwritten when you record the next audio using this function.

• Example— Manual recording

[Less than 30 seconds]

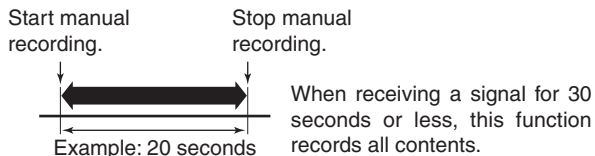

[More than 30 seconds]

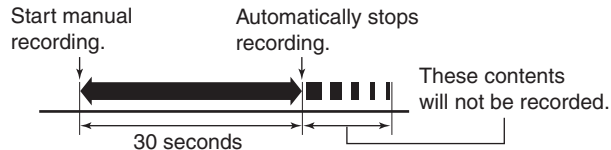

30 seconds after you start the manual recording, the recording will automatically stop.

① 7(2)(6) 5 5(9) 3(6)5(3)4 5(6)3
 (4)7(6)3(5)8(9)6 7(9)3(3)8
 (1)6(3) 5(6)3(6) 0(7)2(6) 0
 5(9) 2(3)9(3)3(5) 5(6)3
 7(1)6(7)1(9) 4(3)3(9)4(3)8(6)5
 (4)7(6)3(5)8(9)6(9)

• “M-REC” appears.

② 7(2)(6) 7(0)(8)(2) 5(9)
 (2)5(1)4(5) 4(3)3(9)4(3)8(6)5(9)

• “REC” appears.

• When the signal disappears, the transceiver continues recording without audio.

③ 7(2)(6) 5 5(9) 2(5)9(0) 5(6)3
 4(3)3(9)4(3)8(6)5(9)

• The recording will automatically stop after 30 seconds.



Manual recording mode appears.



“REC” appears while recording.

■ Automatic recording function (Depending on versions)

When this function is turned ON, the transceiver automatically records the received signal into the memory. The maximum recording time is 60 seconds.

- The transmit signal cannot be recorded.
- If a signal less than 60 seconds is recorded, the next recorded signal is added into the same data.
- The recording threshold level can be set in the set mode. See page 30 for details.

NOTE: Even if you turn OFF the transceiver, this function remains ON.

• Example— Automatic recording

[Less than 60 seconds]

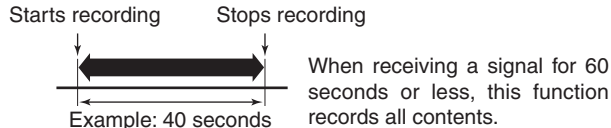

[More than 60 seconds]

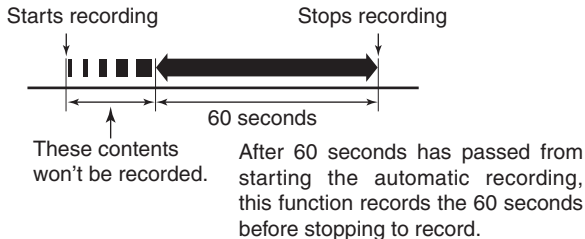

- ① Push **[F]** to enter the function mode, and then push **[▲]/[▼]** to select the automatic recording function.

- “A-REC” appears.



Automatic recording mode appears.

- ② Push **[H/L•LOCK]** to turn the function ON or OFF.

- The automatic recording icon appears when the function is turned ON.
- After pushing **[H/L•LOCK]**, exits the function mode.

Automatic recording icon appears.

- ③ When a signal is received, the transceiver automatically starts recording.

- “REC” appears while recording.
- The recording will automatically stop when the received signal disappears, or the received signal strength becomes weaker than the set threshold level in the set mode (p. 30).



“REC” is appeared while recording.

■ Play back function (Depending on versions)

This transceiver has two voice recorders. One is the manual recording function which can record for 30 seconds. The other is the automatic recording function which can record the last 60 seconds of the receiving signal.

There are three play-back modes as follows.

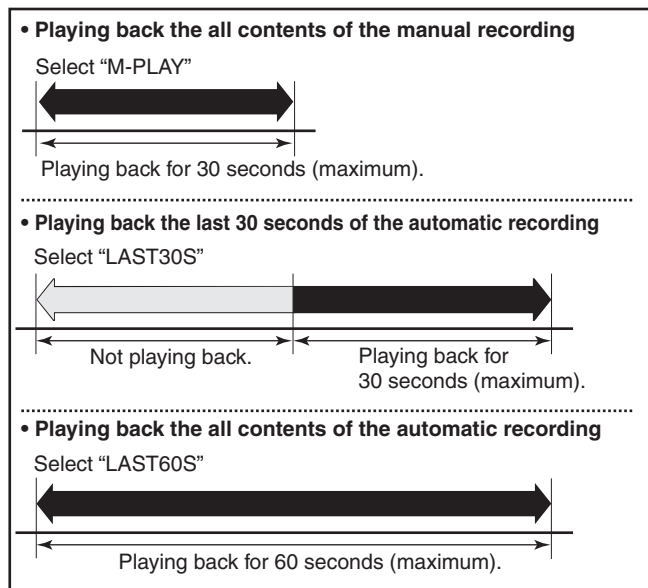

- ① Push [F] to enter the function mode.
 - "PLAY" appears.
- ② Push [H/L•LOCK] to enter the play back selection mode, and then push [▲]/[▼] to select the desired play back mode from "M-PLAY," "LAST30S," or "LAST60S." If there is no recorded signal in the transceiver, "BLANK" appears.

- M-PLAY : Play back the manually recorded signal.
- LAST30S : Play back the last 30 seconds of the automatically recorded signal.
- LAST60S : Play back the automatically recorded signal for 60 seconds.

Blinks while playing.



Playback mode appears.

- ③ Push [H/L•LOCK] to play back the recorded signal.
 - "PL" blinks.
 - To stop the play back, push [H/L•LOCK] again.



"BLANK" appears when the transceiver has no recorded signal.

⚠ DO NOT detach the battery pack while the transceiver is turned ON. Otherwise, the data could be lost or deleted.

Deleting a recorded signal:

While selecting the desired data to delete, hold down [FAV•★] for 3 seconds until 2 short beeps sound.

■ Channel naming function

The IC-M73/IC-M73EURO can assign up to 10-character channel names for each operating channel, including each weather channel. This provides easy recognition of the channel in use, or station names.

When shipped from the factory, the IC-M73/IC-M73EURO is programmed with default names for each VHF marine channel. These defaults can be changed, if desired.

◇ Usable characters

-- (=)	* (*)	+ (+)	-- (-)	, (,)	' (/)	0 (0)	1 (1)	2 (2)	3 (3)
4 (4)	5 (5)	6 (6)	7 (7)	8 (8)	9 (9)	(Space)	A (A)	B (B)	C (C)
D (D)	E (E)	F (F)	G (G)	H (H)	I (I)	J (J)	K (K)	L (L)	M (M)
N (N)	O (O)	P (P)	Q (Q)	R (R)	S (S)	T (T)	U (U)	V (V)	W (W)
X (X)	Y (Y)	Z (Z)	a (a)	b (b)	c (c)	d (d)	e (e)	f (f)	g (g)
h (h)	i (i)	j (j)	k (k)	l (l)	m (m)	n (n)	o (o)	p (p)	q (q)
r (r)	s (s)	t (t)	u (u)	v (v)	w (w)	x (x)	y (y)	z (z)	

◇ Channel name programming

- Push **[▲]/[▼]** to select a channel to program.
 - Hold down **[CH/WX•U/I/C]** for 1 second to select a channel group, if necessary.
- Push **[F]** to enter the function mode, and then push **[▲]/[▼]** to select the channel naming function.
 - “CH NAME” appears.
- Push **[H/L•LOCK]** to edit the channel name.
 - The 1st character of the currently programmed name blinks.
- Push **[▲]/[▼]** to select a character.
- Push **[CH/WX•U/I/C]** to move to the right; then push **[▲]/[▼]** to select a character.
 - Push **[SCAN•DUAL]** to move to the left.
- Continue until the desired characters have been selected, then push **[H/L•LOCK]** to return to normal operation.



Deleting a channel name (All clear):

While selecting the desired channel name in the channel name editing mode, push **[FAV•★]** to delete the selected channel name.

■ Opening comment entry function

The IC-M73/IC-M73EURO can assign up to 16-character opening comments.

You may replace the factory-set opening comment with a comment of your own. The opening comment appears each time the IC-M73/IC-M73EURO is powered ON. The comment may be up to 16 characters long.

You can use same characters as “Channel naming function.” (p. 21)

◇ Opening comment programming

- ① Push **[F]** to enter the function mode, and then push **[▲]/[▼]** to select the channel naming function.
 - “OC EDIT” appears.
- ② Push **[H/L•LOCK]** to edit the opening comment.
 - The 1st character of the currently programmed comment blinks.

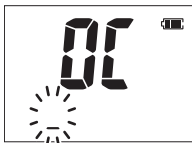

- ③ Push **[▲]/[▼]** to select a character.
- ④ Push **[CH/WX•U/I/C]** to move to the right; then push **[▲]/[▼]** to select a character.
 - Pushing **[SCAN•DUAL]**, moves to left.
- ⑧ Continue until the desired characters have been entered, then push **[H/L•LOCK]** to return to normal operation.



Deleting the opening comment (All clear):

While in the opening comment editing mode, push **[FAV•★]** to delete.

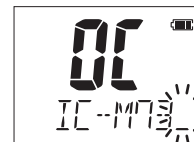

- ▨ The programmed opening comment is briefly displayed or scrolled when the transceiver is powered ON.
- ▨ However, the opening comment display can be skipped by pushing **[16/C]**.

■ ATIS code programming (For only the Dutch and German versions)

The 10-digit ATIS code can be programmed and confirmed with the following operation.

/// The ATIS code programming is not necessary and confirmation can only be performed when the ATIS code has been programmed by your dealer. The code programming can be performed 1 time only, if the code has not been programmed by your dealer.

- ① Push **[F]** to enter the function mode, and then push **[▲]/[▼]** to select the ATIS code programming function.
 - “ATIS ID” appears.
- ② Push **[H/L•LOCK]** to edit the ATIS code.
 - “Id” and “ATIS” appear, and the 1st character of the code blinks.
- ③ Push **[▲]/[▼]** to select a number.
- ④ Push **[CH/WX•U/I/C]** to move to the right; then push **[▲]/[▼]** to select a number.
 - Push **[SCAN•DUAL]** to move to the left.

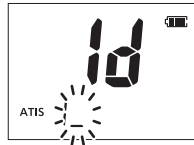
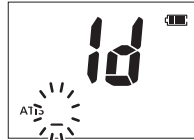

- ⑤ After inputting the 10-digit ATIS code, push **[H/L•LOCK]** to write the code into the memory, then goes to the ATIS code confirmation mode.

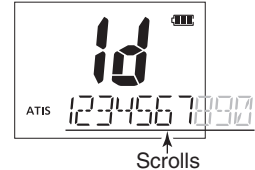

Deleting the ATIS code (All clear):

While in the ATIS code editing mode, push **[FAV•★]** to delete.

◇ ATIS code confirmation

(When the ATIS code has been programmed)

- ① Push **[F]** to enter the function mode, and then push **[▲]/[▼]** to select the ATIS code programming function.
 - “ATIS ID” appears.
- ② Push **[H/L•LOCK]** to confirm the ATIS code.
 - “Id” and “ATIS” appear.
 - The ATIS code is displayed and scrolls in the channel comment display.
- ③ Push **[H/L•LOCK]** to return to normal operation.



7 FUNCTION MODE OPERATION

■ Backlight function

This function is convenient for nighttime operation. The backlighting can also be turned OFF in the SET mode. (p. 27)

➡ Push any key other than [PTT] to turn ON the backlighting.

- The backlighting is automatically turned OFF after 5 seconds of inactivity.

① Push [F] to enter the function mode, and then push [▲]/[▼] to select the backlighting function.

- “LIGHT” appears.

② Push [H/L•LOCK] to turn the function ON or OFF.

- After pushing [H/L•LOCK], exits from the function mode.



Backlight mode
appears.

■ SET mode programming

The SET mode is used to change the status of 17 transceiver functions†: Beep tone function, Weather alert function†, Priority scan, Scan resume timer, Auto scan start function, Dual/Tri-watch function, Monitor key action, Display backlight, LCD contrast selection, Power save function, Scroll type selection, Scroll speed selection, RX noise cancel function†, TX noise cancel function†, RX bass boost function†, TX bass boost function† and the Automatic recording threshold level selection†.

◇ SET mode operation

- ① Turn OFF power.
- ② While holding down [F], turn ON power to enter the SET mode.
 - The “BEEP” (Beep tone function setting) appears.
- ③ Push [F], or push [F] and [▲]/[▼] to select the desired item.
- ④ Push [▲]/[▼] to select the desired option of the item.
- ⑤ To exit the SET mode, push [16/C].

◇ SET MODE ITEMS

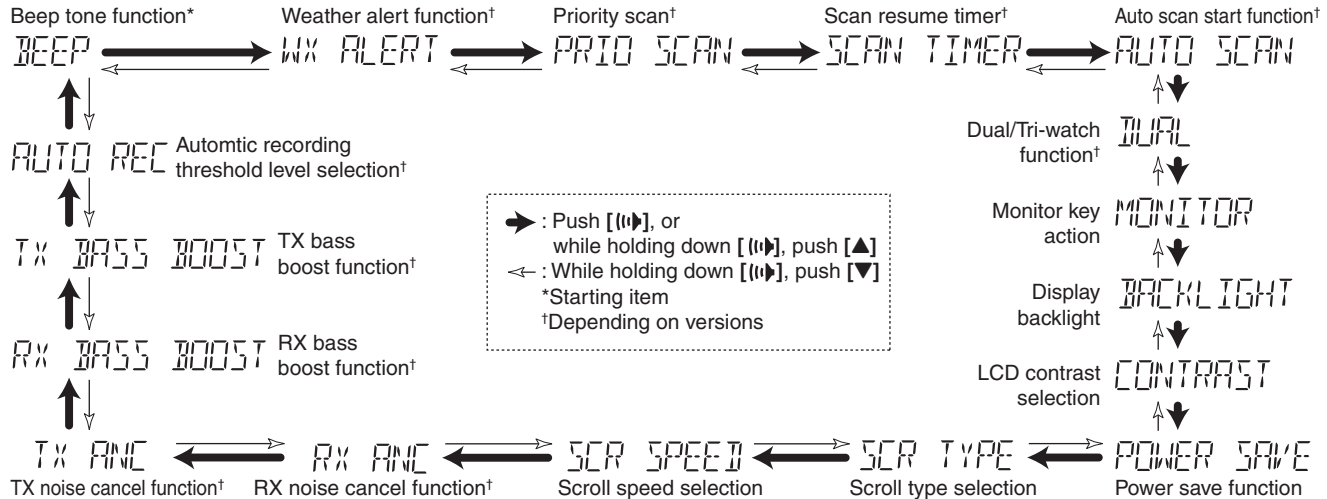

8 SET MODE

■ SET mode items

◇ Beep tone function

“BEEP”

Turns ON the key touch beep sound or AJ, or turns OFF the sound OFF.

- ON : A fixed beep sounds (default)
- AJ : The preset beeps (example: do, re, mi) sound
- OFF : Silent operation

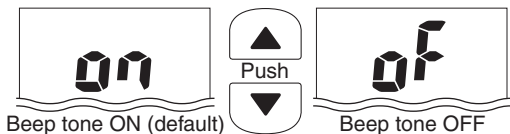

◇ Weather alert function

“WX ALERT”

For only the USA, EXP, and AUS versions, a NOAA broadcast station transmits a weather alert tone before any important weather announcements. When the weather alert function is turned ON, any detected weather alert will make the IC-M73/IC-M73EURO activate a blinking “WX” alert icon on the function display and repeatedly sound a beep tone. The blinking and beeping stops when the radio is picked up and operated. The previously selected weather channel is checked any time during standby, or while scanning, when the power save function is activated.

- “WX” appears when the function is turned ON.

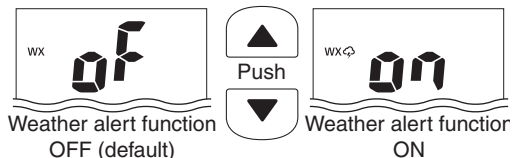

◇ Priority scan function

“PRIO SCAN”

Except for the HOL version, the transceiver has 2 scan types— normal (OFF) and priority (ON) scans. Normal scan searches all Favorite (TAG) channels in the selected channel group. Priority scan sequentially searches all Favorite (TAG) channels while monitoring Channel 16.

- The default setting may differ, depending on the version.

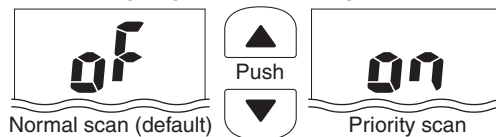

◇ Scan resume timer

“SCAN TIMER”

Except for the HOL version, the scan resume timer can be set as a pause (OFF) or timer scan (ON). When OFF is selected, the scan pauses until a received signal disappears. When ON is selected, the scan pauses for 5 seconds after receiving a signal and then resumes even if a signal has been received.

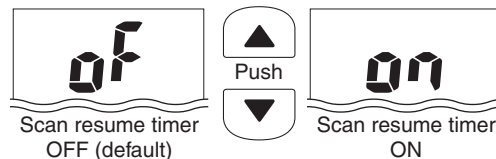

◇ **Auto scan function** "AUTO SCAN"

Except for the HOL version, the auto scan function automatically starts the desired scan when no signal is received, and no operation is performed for 30 seconds

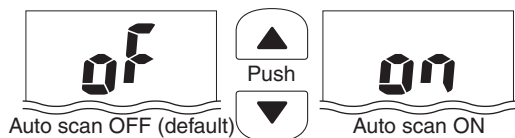

◇ **Dual/Tri-watch function** "DUAL"

Except for the HOL version, this item selects Dual or Tri-watch as desired. See page 16 for details.

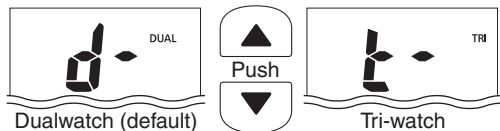

◇ **Monitor key action** "MONITOR"

The monitor key action temporarily cuts off the squelch function. This key action contains PUSH (Pu) or HOLD (Ho) settings, as shown below.

- Pu (PUSH): After pushing [MONITOR] for 1 second, the squelch opens and audio is heard. The squelch is held open while continuously holding down [MONITOR]. (default)
- Ho (HOLD): After pushing [MONITOR] for 1 second, the squelch opens and audio is heard even if [MONITOR] is released. To close the squelch, push any key.

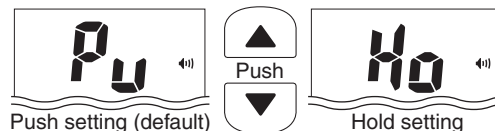

◇ **Backlight function** "BACKLIGHT"

This function is convenient for nighttime operation. The backlight can be turned ON or OFF.

- The backlight is automatically activated when any key except for [PTT] is pushed.
- The backlight is automatically turned OFF after 5 seconds of inactivity.

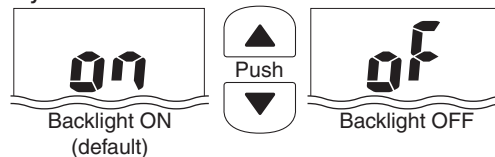

8 SET MODE

◇ LCD contrast selection “CONTRAST”

The contrast of the LCD can be set to Hi (default) or Lo.

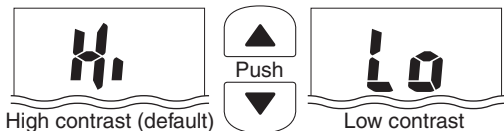

◇ Auto power save function “POWER SAVE”

The auto power save function reduces current drain by deactivating the receiver circuit for preset intervals.

- ON : The power save function is turned ON. The power save function will activate when no signal is received, and no operation is performed for 5 seconds
- OFF : The power save function is turned OFF.

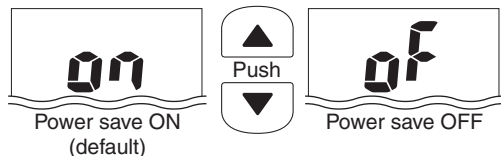

◇ Channel name scroll type “SCR TYPE”

Set the channel name/comment scroll type to 1 or 2.

- 1: The first 7 characters are displayed for approximately 1 second then scrolls. When the channel name or comment is 7 character or less, it does not scroll (default).
- 2: The channel name or comment scrolls regardless of the number of characters after no name or comment (blank) is displayed for 1 second.

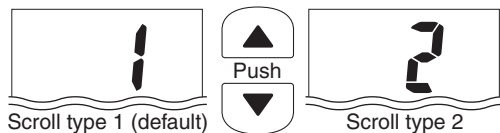

◇ Scrolling speed “SCR SPEED”

Selects the channel name/comment scroll speed.

- 1: Scrolls 3.33 characters in a second.
- 2: Scrolls 2.5 characters in a second.
- 3: Scrolls 2 characters in a second.

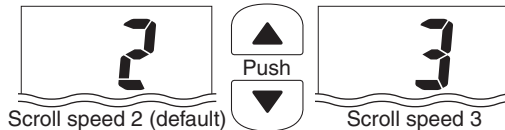

◇ RX Noise Cancel function “RX ANC”

Set the Noise Cancel function for reception. The function may not be available, depending on the transceiver version.

- OFF : Turns OFF the function.
- 1 : The Noise Cancel function reduces random noise components in the received signal to approximately one half.
- 2 : The Noise Cancel function reduces random noise components in the received signal to approximately one third.
- 3 : The Noise Cancel function reduces random noise components in the received signal to approximately one tenth.

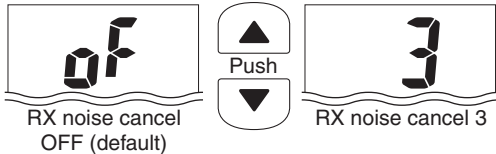

◇ TX Noise Cancel function “TX ANC”

Set the Noise Cancel function for transmission. The function may not be available, depending on the transceiver version.

- OFF : Turns OFF the function.
- ON : The Noise Cancel function reduces random noise components in the transmitted signal to one third.

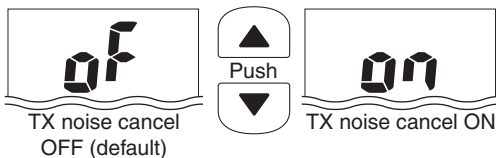

◇ RX bass boost function “RX BASS BOOST”

Set the bass boost function for reception. The function may not be available, depending on the transceiver version.

- OFF : Turns OFF the function.
- ON : The RX bass boost function boosts the bass level of the receive audio tone.

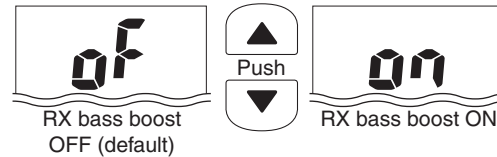

◇ TX bass boost function “TX BASS BOOST”

Set the bass boost function for transmission. The function may not be available, depending on the transceiver version.

- OFF : Turns OFF the function.
- ON : The TX bass boost function boosts the bass level of the transmit audio tone.

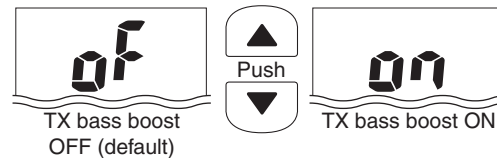

8 SET MODE

◇ Automatic recording threshold level

“AUTO REC”

Set the automatic recording threshold level. The function may not be available, depending on the transceiver version.

- 1: Set the threshold level to shallow. Weak signals will automatically be recorded into memory.
- 2: Set the threshold level to mid.
- 3: Set the threshold level to deep. Weak signals will not automatically be recorded into memory.

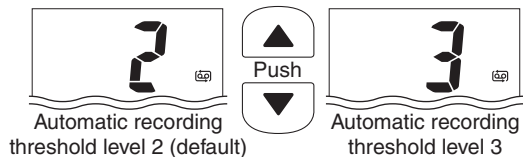

■ Battery cautions

Misuse of Lithium-ion batteries may result in the following hazards: smoke, fire, or battery rupture. Misuse can also cause other battery damage or degradation of battery performance.

- **⚠ DANGER!** Use and charge only specified Icom battery pack with Icom transceiver. Only Icom battery pack is tested and approved for use with Icom transceiver. Using third-party or counterfeit battery packs may cause smoke, fire, or cause the battery to burst.
- ◇ **Battery caution**
 - **⚠ DANGER! DO NOT** hammer or otherwise impact the battery. Do not use the battery if it has been severely impacted or dropped, or if the battery has been subjected to heavy pressure. Battery damage may not be visible on the outside of the case. Even if the surface of the battery does not show cracks or any other damage, the cells inside the battery may rupture or catch fire.
 - **⚠ DANGER! NEVER** use or leave battery pack in areas with temperatures above +60°C (+140°F). High temperature buildup in the battery, such as could occur near fires or stoves, inside a sun-heated car, or by setting the battery in direct sunlight may cause the battery to rupture or catch fire. Excessive temperatures may also degrade battery performance or shorten battery life.

- **⚠ DANGER! DO NOT** expose the battery to rain, snow, seawater, or any other liquids. Do not charge or use a wet battery. If the battery gets wet, be sure to wipe it dry before using. The battery by itself is not waterproof.
- **⚠ DANGER! NEVER** incinerate a used battery pack since internal battery gas may cause a rupture or explosion.
- **⚠ DANGER! NEVER** solder the battery terminals, or **NEVER** modify the battery pack. This may cause heat generation, and the battery may rupture, emit smoke or catch fire.
- **⚠ DANGER!** Use the battery only with the transceiver for which it is specified. Never use a battery with any other equipment, or for any purpose that is not specified in this instruction manual.
- **⚠ DANGER!** If fluid from inside the battery gets in your eyes, blindness can result. Rinse your eyes with clean water, without rubbing them, and see a doctor immediately.
- **⚠ WARNING!** Immediately stop using the battery if it emits an abnormal odor, heats up, or is discolored or deformed. If any of these conditions occur, contact your Icom dealer or distributor.
- **⚠ WARNING!** Immediately wash, using clean water, any part of the body that comes into contact with fluid from inside the battery.

9 BATTERY CHARGING

- **⚠ WARNING! NEVER** put the battery in a microwave oven, high-pressure container, or in an induction heating cooker. This could cause overheating, a fire, or cause the battery to rupture.
- **CAUTION:** Always use the battery within the specified temperature range for the transceiver* and the battery itself (–20°C to +60°C; –4°F to +140°F).

* EXP/USA	: –20°C to +60°C; –4°F to +140°F
CHN/EUR/FRG/HOL/UK	: –15°C to +55°C; +5°F to +131°F
AUS	: –10°C to +55°C; +14°F to +131°F

Using the battery out of its specified temperature range will reduce the battery's performance and battery life. Please note that the specified temperature range of the battery may exceed that of the transceiver. In such cases, the transceiver may not work properly because it is out of its operating temperature range.

- **CAUTION:** Shorter battery life could occur if the battery is left fully charged, completely discharged, or in an excessive temperature environment (above +50°C; +122°F) for an extended period of time. If the battery must be left unused for a long time, it must be detached from the radio after discharging. You may use the battery until the remaining capacity is about half, then keep it safely in a cool dry place with the temperature range as below;
- | | | |
|----------------|------------------|-----------------------|
| –20°C to +50°C | (–4°F to +122°F) | (within a month) |
| –20°C to +35°C | (–4°F to +95°F) | (within three months) |
| –20°C to +20°C | (–4°F to +68°F) | (within a year) |

◇ Charging caution

- **⚠ DANGER! NEVER** charge the battery pack in areas with extremely high temperatures, such as near fires or stoves, inside a sun-heated car, or in direct sunlight. In such environments, the safety/protection circuit in the battery will activate, causing the battery to stop charging.
- **⚠ WARNING! DO NOT** charge or leave the battery in the battery charger beyond the specified time for charging. If the battery is not completely charged by the specified time, stop charging and remove the battery from the battery charger. Continuing to charge the battery beyond the specified time limit may cause a fire, overheating, or the battery may rupture.
- **⚠ WARNING! NEVER** insert the battery and transceiver (battery attached to the transceiver) into the charger if it is wet or soiled. This could corrode the battery charger terminals or damage the charger. The charger is not waterproof.
- **CAUTION: DO NOT** charge the battery outside of the specified temperature range: +10°C to +40°C (+50°F to +104°F). Icom recommends charging the battery at +20°C (+68°F). The battery may heat up or rupture if charged out of the specified temperature range. Additionally, battery performance or battery life may be reduced.

■ Supplied battery charger

◇ BC-210 installation

- To a desktop
Supplied screws

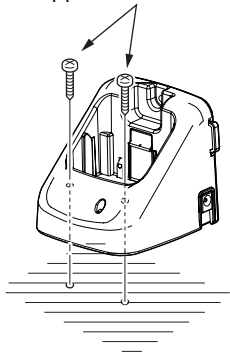

- To a wall

Supplied screws

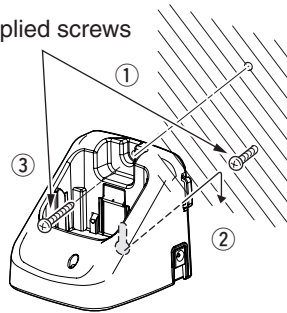

- For added stability

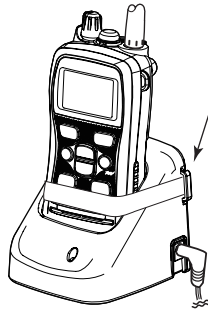

Eyelet:
Use a rubber band to secure the transceiver, if desired.

◇ Charging

- ① Connect the AC adapter as shown below.
- ② Insert the battery pack with or without the transceiver into the charger.
 - The charge indicator lights orange.
- ③ Charge the battery pack approximately 2.5 hours, depending on the remaining power level.
 - The charge indicator lights green when charging is complete.

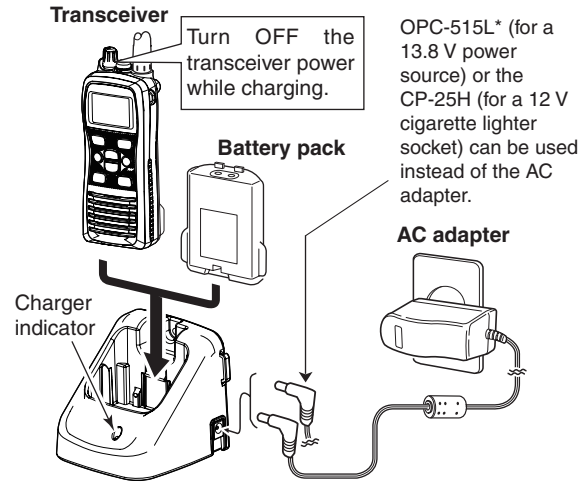

CAUTION: NEVER connect the OPC-515L to a power source using reverse polarity. This will ruin the battery charger.
White line: ⊕ Black line: ⊖

9 BATTERY CHARGING

■ Optional battery chargers

◇ AD-129 installation

- ① Connect the 8-pin connector of the each charger slot to the AD-129 desktop charger adapter's plug.
- ② Install the adapter into the each charger slot in the direction of the arrow, then use the two supplied screws to secure the adapter to the charger.

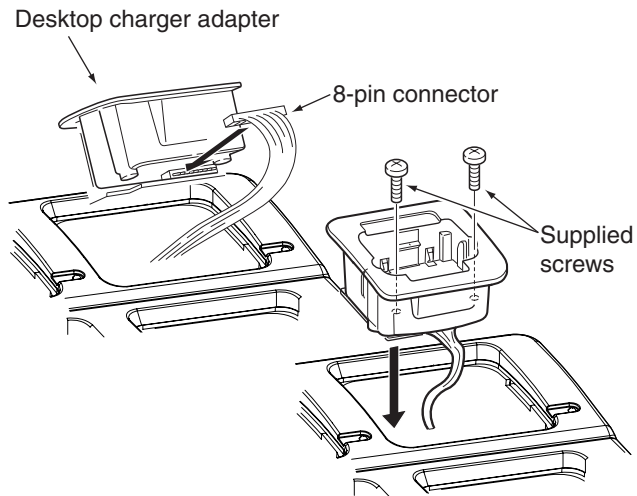

◇ Rapid charging with the BC-197+BC-157S or OPC-656

The optional BC-197 with the BC-157S will simultaneously charge up to 6 Li-ion battery packs. The following items are additionally required. (Charging time: approximately 2.5 hours)

- Six AD-129 charger adapters
- An AC adapter (BC-157S) or the DC power cable (OPC-656)

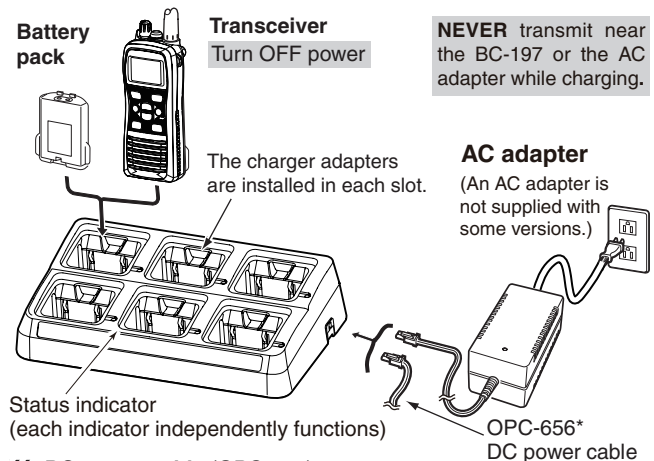

* DC power cable (OPC-656)

(Connect to a DC power supply: 12 to 16 V/at least 7 A)

NEVER reverse the polarity when connecting the power cable to a power source. This will ruin the battery charger.

Red line : ⊕ Black line : ⊖

OPTIONAL SWIVEL BELT CLIP 10

■ Attaching

- ① Screw the base clip to the back of the transceiver using the two screws (supplied), as shown to the right.

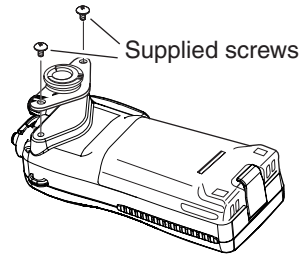

- ② Clip the belt clip over your belt and insert the transceiver.

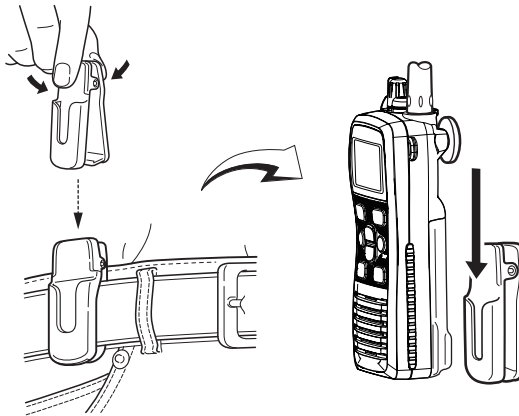

- ③ Once the transceiver is locked in place, it swivels.

■ Detaching

- Turn the transceiver upside down in the direction of the arrow and pull out from the belt clip.

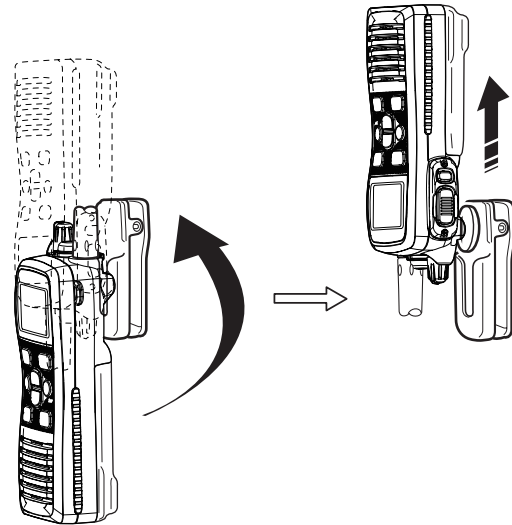

⚠ CAUTION: HOLD THE TRANSCEIVER TIGHTLY WHEN HANGING OR DETACHING THE TRANSCEIVER FROM THE BELT CLIP.

Otherwise the transceiver may not be attached to the belt clip or swivelled properly if the transceiver is accidentally dropped and the base clip is scratched or damaged.

11

OPTIONAL SPEAKER-MICROPHONE

■ HM-167 descriptions

HM-202 is also an optional speaker microphone. see the page 43 for details.

Alligator type clip

To attach the speaker-microphone to your shirt or collar.

PTT switch

Push to transmit.
Release to receive.

Microphone

Speaker

Turn OFF the transceiver power when connecting the HM-167.

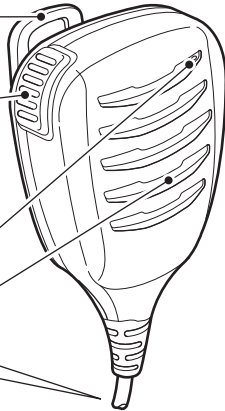

NEVER immerse the connector in water. If the connector becomes wet, be sure to dry it **BEFORE** attaching it to the transceiver.

NOTE: The microphone is located at the top of the speaker-microphone, as shown in the diagram above. To maximize the readability of your transmitted signal (voice), hold the microphone approximately 5 to 10 cm (2 to 4 inches) from your mouth, and speak in a normal voice level.

■ Attaching

Insert the speaker-mic connector onto the [SP MIC] connector and carefully screw it tight, as shown in the diagram below. Be careful not to cross-thread the connection.

Set the triangle mark to the front side.

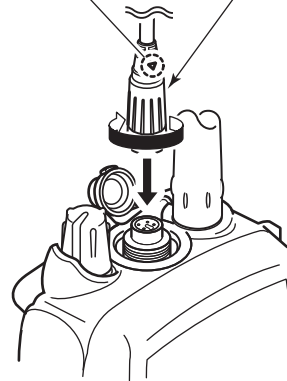

CAUTION: Attach the speaker-microphone's connector securely to prevent accidental dropping, or water intrusion in the connector.

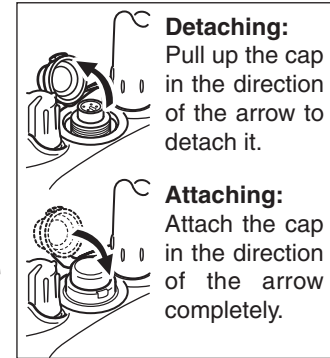

Detaching:

Pull up the cap in the direction of the arrow to detach it.

Attaching:

Attach the cap in the direction of the arrow completely.

IMPORTANT: **KEEP** the transceiver's [SP MIC] connector cap attached when the speaker-microphone is not in use. Water will not get into the transceiver even if the cover is not attached; however, the terminals (pins) will become rusty, or the transceiver will function abnormally if the connector has become wet.

TROUBLESHOOTING 12

PROBLEM	POSSIBLE CAUSE	SOLUTION	REF.
The transceiver does not turn ON.	<ul style="list-style-type: none"> The battery is depleted. Bad connection to the battery pack. 	<ul style="list-style-type: none"> Recharge the battery pack. Check the connection to the transceiver. 	pp. 33, 34 p. 3
No sound from the speaker.	<ul style="list-style-type: none"> Squelch level is too tight. Volume level is too low. Speaker has been exposed to water. Water has entered to [SP MIC] connector. 	<ul style="list-style-type: none"> Set squelch to the threshold point. Rotate [VOL] to set a suitable level. Hold down [F] to drain water from the speaker. Dry [SP MIC] connector. 	p. 13 p. 11 p. 13 —
Transmitting is impossible, or high power can not be selected.	<ul style="list-style-type: none"> Some channels are for low power or receive only. The battery is exhausted. The battery is overcharged. The output power is set to low. The transceiver is over heated. 	<ul style="list-style-type: none"> Change channels. Recharge the battery pack. Verify the battery voltage is correct. Push [H/L•LOCK] to select high power. Turn OFF the power, leave it at room temperature for a while. 	pp. 11, 12, 40–42 pp. 33, 34 — p. 11 —
The displayed channel cannot be changed.	<ul style="list-style-type: none"> Lock function is activated. 	<ul style="list-style-type: none"> Push [H/L•LOCK] for 1 second to cancel the function. 	p. 12
Scan does not start.	<ul style="list-style-type: none"> Favorite (TAG) channels are not programmed. 	<ul style="list-style-type: none"> Set the desired channels as “Favorite (TAG)” channels. 	p. 15
No beeps.	<ul style="list-style-type: none"> Beep tones are turned OFF. 	<ul style="list-style-type: none"> Set the beep tones to ON (Fix Beep/Preset) in the SET mode. 	p. 26
Does not record or does not record properly.	<ul style="list-style-type: none"> The read/write capacity has been exceeded (the recording counter displays 100 or more. (p. 4)), or the memory is damaged. 	<ul style="list-style-type: none"> The memory IC should be replaced. Ask your technical dealer for service. 	—
The weak signal is not recorded by the automatic recording function.	<ul style="list-style-type: none"> The automatic recording threshold level is too deep. 	<ul style="list-style-type: none"> Set the automatic recording threshold level to shallow. 	p. 30
“CHARGE” comment blinks	<ul style="list-style-type: none"> The connected battery is depleted. 	<ul style="list-style-type: none"> Recharge the battery pack. 	pp. 33, 34

13 SPECIFICATIONS

• IC-M73

◇ General

- Frequency coverage : Tx 156.025–157.425 MHz
: Rx 156.050–163.275 MHz
- Mode : FM (16K0G3E)
- Operating temperature range : –20°C to +60°C (–4°F to +140°F)
- Current drain (at 7.4 V) : TX high 1.5 A
(approximately) Max. audio 0.45 A
- Power supply requirement : 7.4 V DC nominal (negative ground)
- Frequency stability : ±10 ppm (–20°C to +60°C)
- Antenna impedance : 50 Ω nominal
- Dimensions (approximately) : 52.5(W) × 125(H) × 30(D)mm
(Projections not included) : 2.0(W) × 4.9(H) × 1.2(D) inches
- Weight (approximately) : 280 g/9.9 oz with BP-245N

◇ Transmitter

- Output power : 6 W/3 W/1 W
- Modulation system : Variable reactance frequency modulation
- Max. frequency deviation : ±5.0 kHz
- Adjacent channel power : 70 dB
- Spurious emissions (typical) : –68 dBc

◇ Receiver

- Sensitivity (typical)
USA and EXP versions : 0.22 μV (12 dB SINAD)
- Squelch sensitivity (at threshold, typical)
: 0.35 μV

- Intermodulation rejection ratio : 70 dB (typical)
- Spurious response rejection ratio : 70 dB (typical)
- Adjacent channel selectivity : 70 dB (typical)
- Audio output power (at 10% distortion with an 8 Ω load)
: 0.35 W typical (External)
: 0.7 W typical (Internal)

• IC-M73EURO

◇ General

- Frequency coverage : Tx 156.000–161.450 MHz
: Rx 156.000–163.425 MHz
- Mode : FM (16K0G3E)
- Operating temperature range : –15°C to +55°C
- Current drain (approximately) : Tx (6 W) 1.5 A
: Tx (1 W) 0.7 A
: Tx (0.5 W) 0.6 A
: Rx Max. audio 0.45 A
- Power supply requirement : 7.4 V DC nominal (negative ground)
- Frequency stability : ±1.5 kHz
- Antenna impedance : 50 Ω nominal
- Dimensions (approximately) : 52.5(W) × 125(H) × 30(D) mm
(Projections not included)
- Weight (approximately) : 280 g with BP-245N

◇ Transmitter

- Output power : 6 W/3 W/1 W/0.5 W*
*German version only
- Modulation system : Variable reactance frequency modulation
- Max. frequency deviation : ± 5 kHz
- Adjacent channel power : 70 dB
- Spurious emissions : 0.25 μ W

◇ Receiver

- Sensitivity (typical) : -4 dB μ emf at 20 dB SINAD
- Squelch sensitivity (threshold) : -5 dB μ emf (typical)
- Intermodulation rejection ratio : 68 dB
- Spurious response rejection ratio : 70 dB
- Adjacent channel selectivity : 70 dB
- Audio output power (at 10% distortion with an 8 Ω load)
: 0.2 W (External)
0.7 W typical at 1 kHz (Internal)

• IC-M73EURO (AUS version)

◇ General

- Frequency coverage : Tx 156.025–157.425 MHz
: Rx 156.300–162.025 MHz
- Mode : FM (16K0G3E)
- Operating temperature range : -10°C to $+55^{\circ}\text{C}$
- Current drain (at 7.4 V)
(approximately) : TX high 1.4 A
Max. audio 0.45 A

- Power supply requirement : 7.4 V DC nominal (negative ground)
- Frequency stability : ± 10 ppm (-10°C to $+55^{\circ}\text{C}$)
- Antenna impedance : 50 Ω nominal
- Dimensions (approximately)
(Projections not included) : 52.5(W) \times 125(H) \times 30(D)mm
: 2.0(W) \times 4.9(H) \times 1.2(D) inches
- Weight (approximately) : 280 g/9.9 oz with BP-245N

◇ Transmitter

- Output power : 5 W/3 W/1 W
- Modulation system : Variable reactance frequency modulation
- Max. frequency deviation : ± 5.0 kHz
- Adjacent channel power : 70 dB
- Spurious emissions (typical) : 0.25 μ W

◇ Receiver

- Sensitivity (typical) : -5 dB μ emf (20 dB SINAD)
- Squelch sensitivity (at threshold, typical)
: -6 dB μ emf
- Intermodulation rejection ratio : 65 dB
- Spurious response rejection ratio : 65 dB
- Adjacent channel selectivity : 65 dB
- Audio output power (at 10% distortion with an 8 Ω load)
: 0.2 W (External)
: 0.7 W typical at 1 kHz (Internal)

All stated specifications are subject to change without notice or obligation.

14 VHF MARINE CHANNEL LIST

◇ For IC-M73EURO

• International channels

CH	Frequency (MHz)		CH	Frequency (MHz)		CH	Frequency (MHz)		CH	Frequency (MHz)		CH	Frequency (MHz)		CH	Frequency (MHz)	
	Transmit	Receive		Transmit	Receive		Transmit	Receive		Transmit	Receive		Transmit	Receive		Transmit	Receive
01	156.050	160.650	11	156.550	156.550	21	157.050	161.650	61	156.075	160.675	71	156.575	156.575	81	157.075	161.675
02	156.100	160.700	12	156.600	156.600	22	157.100	161.700	62	156.125	160.725	72	156.625	156.625	82	157.125	161.725
03	156.150	160.750	13	156.650	156.650	23	157.150	161.750	63	156.175	160.775	73	156.675	156.675	83	157.175	161.775
04	156.200	160.800	14	156.700	156.700	24	157.200	161.800	64	156.225	160.825	74	156.725	156.725	84	157.225	161.825
05	156.250	160.850	15 ^{*1}	156.750	156.750	25	157.250	161.850	65	156.275	160.875	75 ^{*3}	156.775	156.775	85	157.275	161.875
06	156.300	156.300	16	156.800	156.800	26	157.300	161.900	66	156.325	160.925	76 ^{*3}	156.825	156.825	86	157.325	161.925
07	156.350	160.950	17 ^{*1}	156.850	156.850	27	157.350	161.950	67	156.375	156.375	77	156.875	156.875	87	157.375	157.375
08	156.400	156.400	18	156.900	161.500	28	157.400	162.000	68	156.425	156.425	78	156.925	161.525	88	157.425	157.425
09	156.450	156.450	19	156.950	161.550	37A ^{*2}	157.850	157.850	69	156.475	156.475	79	156.975	161.575	P4 ^{*2}	161.425	161.425
10	156.500	156.500	20	157.000	161.600	60	156.025	160.625	70	RX Only	156.525	80	157.025	161.625			

*1 Channels 15 and 17 may also be used for on-board communications provided the effective radiated power does not exceed 1 W, and subject to the national regulations of the administration concerned when these channels are used in its territorial waters.

*2 UK Marina Channels: M1=37A (157.850 MHz), M2=P4 (161.425 MHz) for U.K. version only.

*3 The output power of channels 75 and 76 are limited to low power (1 W) only. The use of these channels should be restricted to navigation-related communications only and all precautions should be taken to avoid harmful interference to channel 16, e.g. by means geographical separation.

◇ For IC-M73EURO

• USA channels (for U.K. version only)

CH	Frequency (MHz)		CH	Frequency (MHz)		CH	Frequency (MHz)		CH	Frequency (MHz)		CH	Frequency (MHz)		CH	Frequency (MHz)	
	Transmit	Receive		Transmit	Receive		Transmit	Receive		Transmit	Receive		Transmit	Receive		Transmit	Receive
01A	156.050	156.050	12	156.600	156.600	22A	157.100	157.100	64A	156.225	156.225	75*1	156.775	156.775	85	157.275	161.875
--	---	---	13*1	156.650	156.650	23A	157.150	157.150	65A	156.275	156.275	76*1	156.825	156.825	85A	157.275	157.275
03A	156.150	156.150	14	156.700	156.700	24	157.200	161.800	66A	156.325	156.325	77*1	156.875	156.875	86	157.325	161.925
--	---	---	15*1	156.750	156.750	25	157.250	161.850	67*1	156.375	156.375	78A	156.925	156.925	86A	157.325	157.325
05A	156.250	156.250	16	156.800	156.800	26	157.300	161.900	68	156.425	156.425	79A	156.975	156.975	87	157.375	161.975
06	156.300	156.300	17*1	156.850	156.850	27	157.350	161.950	69	156.475	156.475	80A	157.025	157.025	87A	157.375	157.375
07A	156.350	156.350	18A	156.900	156.900	28	157.400	162.000	70	RX Only	156.525	81A	157.075	157.075	88	157.425	162.025
08	156.400	156.400	19A	156.950	156.950	37A*2	157.850	157.850	71	156.575	156.575	82A	157.125	157.125	88A	157.425	157.425
09	156.450	156.450	20	157.000	161.600	61A	156.075	156.075	72	156.625	156.625	83A	157.175	157.175	P4*2	161.425	161.425
10	156.500	156.500	20A	157.000	157.000	--	---	---	73	156.675	156.675	84	157.225	161.825			
11	156.550	156.550	21A	157.050	157.050	63A	156.175	156.175	74	156.725	156.725	84A	157.225	157.225			

*1 Low power only.

*2 UK Marina Channels: M1=37A (157.850 MHz), M2=P4 (161.425 MHz) for U.K. version only.

NOTE: Simplex channels, 3, 21, 23, 61, 64, 81, 82 and 83 **CANNOT** be lawfully used by the general public in U.S.A. waters.

14 VHF MARINE CHANNEL LIST

◇ For IC-M73 and IC-M73EURO (Australia)

USA	INT	CAN	Transmit	Receive
	01	01	156.050	160.650
01A			156.050	156.050
	02	02	156.100	160.700
	03	03	156.150	160.750
03A			156.150	156.150
	04		156.200	160.800
		04A	156.200	156.200
	05		156.250	160.850
05A		05A	156.250	156.250
06	06	06	156.300	156.300
	07		156.350	160.950
07A		07A	156.350	156.350
08	08	08	156.400	156.400
09	09	09	156.450	156.450
10	10	10	156.500	156.500
11	11	11	156.550	156.550
12	12	12	156.600	156.600
13 ^{*1}	13	13 ^{*1}	156.650	156.650
14	14	14	156.700	156.700
15 ^{*1}	15 ^{*1}	15 ^{*1}	156.750	156.750
16	16	16	156.800	156.800
17 ^{*1}	17	17 ^{*1}	156.850	156.850
	18		156.900	161.500
18A		18A	156.900	156.900
	19		156.950	161.550
19A		19A	156.950	156.950
20	20	20 ^{*1}	157.000	161.600
20A			157.000	157.000

USA	INT	CAN	Transmit	Receive
	21	21	157.050	161.650
21A		21A	157.050	157.050
		21b	Rx only	161.650
	22		157.100	161.700
22A		22A	157.100	157.100
	23	23	157.150	161.750
23A			157.150	157.150
24	24	24	157.200	161.800
25	25	25	157.250	161.850
		25b	Rx only	161.850
26	26	26	157.300	161.900
27	27	27	157.350	161.950
28	28	28	157.400	162.000
		28b	Rx only	162.000
	60	60	156.025	160.625
	61		156.075	160.675
61A		61A	156.075	156.075
	62		156.125	160.725
		62A	156.125	156.125
	63		156.175	160.775
63A			156.175	156.175
	64	64	156.225	160.825
64A		64A	156.225	156.225
	65		156.275	160.875
65A	65A	65A	156.275	156.275
	66		156.325	160.925
66A	66A	66A ^{*1}	156.325	156.325
67 ^{*1}	67	67	156.375	156.375

USA	INT	CAN	Transmit	Receive
68	68	68	156.425	156.425
69	69	69	156.475	156.475
70	70	70	RX only	156.525
71	71	71	156.575	156.575
72	72	72	156.625	156.625
73	73	73	156.675	156.675
74	74	74	156.725	156.725
75 ^{*1}	75 ^{*1}	75 ^{*1}	156.775	156.775
76 ^{*1}	76 ^{*1}	76 ^{*1}	156.825	156.825
77 ^{*1}	77	77 ^{*1}	156.875	156.875
	78		156.925	161.525
78A		78A	156.925	156.925
	79		156.975	161.575
79A		79A	156.975	156.975
	80		157.025	161.625
80A		80A	157.025	157.025
	81		157.075	161.675
81A		81A	157.075	157.075
	82		157.125	161.725
82A		82A	157.125	157.125
	83	83	157.175	161.775
83A		83A	157.175	157.175
		83b	Rx only	161.775
84	84	84	157.225	161.825
84A			157.225	157.225
85	85	85	157.275	161.875
85A			157.275	157.275
86	86	86	157.325	161.925

USA	INT	CAN	Transmit	Receive
86A			157.325	157.325
87	87	87	157.375	161.975
87A			157.375	157.375
88	88	88	157.425	162.025
88A			157.425	157.425
	A1 ^{*2}		161.975	161.975
	A2 ^{*2}		162.025	162.025

WX channel	Frequency (MHz)	
	Transmit	Receive
1	RX only	162.550
2	RX only	162.400
3	RX only	162.475
4	RX only	162.425
5	RX only	162.450
6	RX only	162.500
7	RX only	162.525
8	RX only	161.650
9	RX only	161.775
10	RX only	163.275

*1 Low power only.

*2 Australian version only

NOTE: Simplex channels, 3, 21, 23, 61, 64, 81, 82 and 83 **CANNOT** be lawfully used by the general public in U.S.A. waters.

◇ BATTERY CASE AND PACK

- **BP-245N** Li-ion BATTERY PACK

The same as supplied with the transceiver.

Voltage : 7.4 V

Capacity: 1900 mAh (minimum)/2000 mAh (typical)

◇ CHARGERS

- **BC-210** DESKTOP CHARGER + **BC-123SA/SE/SV** AC ADAPTER

For rapid charging of battery packs. The same as supplied with the transceiver. An AC adapter is supplied with the charger depending on versions.

Charging time: Approximately 2.5 hours

- **BC-197** MULTI-CHARGER + **AD-129** CHARGER ADAPTER (6 pcs.)
+ **BC-157S** AC ADAPTER

For rapid charging of up to 6 battery packs (six AD-129's are required) simultaneously. An AC adapter should be purchased separately.

Charging time: Approximately 2.5 hours.

◇ DC CABLES

- **CP-25H** CIGARETTE LIGHTER CABLE

The same as supplied with some of the transceiver versions.

Specification: 12 V DC/1 A

NOTE: The CP-25H is equipped with a 2 A fuse. If the fuse blows, replace it with a new rated fuse. **DO NOT** use a fuse with amp ratings other than this rating.

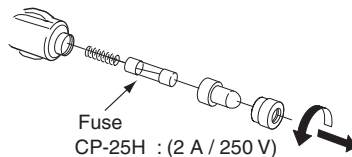

- **OPC-515L/OPC-656** DC POWER CABLES

Charges the battery pack using 13.8 V power source instead of the AC adapter.

OPC-515L: For BC-210

OPC-656 : For BC-197

◇ BELT CLIPS

- **MB-103** BELT CLIP

The same as supplied with the transceiver.

- **MB-86** SWIVEL BELT CLIP

Belt clip for swivel type.

- **MB-96N/F** LEATHER BELT HANGER

◇ OTHER OPTIONS

- **HM-167** SPEAKER-MICROPHONE

Full sized waterproof speaker-microphone including alligator type clip to attach to your shirt or collar, etc.

- **HM-202** SPEAKER-MICROPHONE

The HM-202 meets IP67 requirements for waterproof protection. Once the item has been dropped, the waterproof protection cannot be guaranteed because of possible damage to the case or the waterproof seals.

- **FA-S59V*/FA-S64V** FLEXIBLE ANTENNA

*For only for the EUR, UK, FRG and HOL versions.

Approved Icom optional equipment is designed for optimal performance when used with an Icom transceiver. Icom is not responsible for the destruction or damage to an Icom transceiver in the event the Icom transceiver is used with equipment that is not manufactured or approved by Icom.

Available or applicable options may differ according to countries. Ask your authorized dealer for details.

INDEX

- A -	
About the function mode	17
AD-129 installation	34
Adjusting the squelch level	13
AquaQuake water draining function	13
ATIS code confirmation	23
ATIS code programming	23
Attaching	35, 36
Attachments	2
Automatic recording function	19
Automatic recording threshold level	30
Auto power save function	28
Auto scan function	27

- B -	
Backlight function	24, 27
BASIC OPERATION	8
BATTERY CASE AND PACK	43
Battery caution	31
BATTERY CHARGING	31
Battery pack	3
BC-210 installation	33
Beep tone function	26
Belt clip	3, 43

- C -	
Call channel	8
Call channel programming	12
Channel 16	8
Channel name programming	21
Channel name scroll type	28
Channel naming function	21
Channel selection	8

CHARGERS	43
Charging	33

Charging caution	32
COUNTRY CODE LIST	v

- D -	
DC CABLES	43
Description	16
Detaching	35
Dual/Tri-watch function	27
DUALWATCH/TRI-WATCH	16

- E -	
Entering the function mode	17
EXPLICIT DEFINITIONS	i

- F -	
FCC INFORMATION	v
FEATURES	i
Flexible antenna	2
FOREWORD	i
Front, top and side panels	4
Function display	6
FUNCTION MODE ITEMS	17
FUNCTION MODE OPERATION	17

- G -	
General	38, 39

- H -	
Handstrap	2
HM-167 descriptions	36

- I -	
IMPORTANT	i
IN CASE OF EMERGENCY	vi

- L -	
LCD contrast selection	28
Lock function	12

- M -

Manual recording function 18

Monitor function 12

Monitor key action..... 27

- N -

NORMAL SCAN 14

- O -

Opening comment entry function 22

Opening comment programming..... 22

OPERATING RULES 1

Operation 16

Optional battery chargers 34

OPTIONAL SPEAKER-MICROPHONE..... 36

OPTIONAL SWIVEL BELT CLIP..... 35

OPTIONS..... 43

OTHER OPTIONS 43

- P -

PANEL DESCRIPTION 4

Play back function..... 20

PRECAUTIONS ii

Priorities..... 1

PRIORITY SCAN 14

Priority scan function 26

Privacy 1

- R -

Radio licenses 1

RADIO OPERATOR WARNING..... iii

Rapid charging with the BC-197+BC-157S or OPC-656..... 34

Receiver 38, 39

Receiving and transmitting 11

RECOMMENDATION vi

RX bass boost function..... 29

RX Noise Cancel function 29

- S -

SCAN OPERATION 14

Scan resume timer 26

Scan types 14

Scrolling speed..... 28

SET MODE 25

SET MODE ITEMS 25, 26

SET mode operation 25

SET mode programming..... 25

Setting Favorite channels 15

SPECIFICATIONS 38

Starting a scan..... 15

Supplied accessories 2

SUPPLIED ACCESSORIES AND ATTACHMENTS..... 2

Supplied battery charger 33

- T -

TABLE OF CONTENTS vii

Transmitter 38, 39

TROUBLESHOOTING..... 37

TX bass boost function 29

TX Noise Cancel function..... 29

- U -

Usable characters 21

U.S.A., International, Canadian and ATIS channels..... 9

- V -

VHF MARINE CHANNEL LIST 40

- W -

Weather alert function 26

Weather channels..... 10