



JBL Marine MA704 / MA4505 AMPLIFIERS



MANUAL



by **HARMAN**

THANK YOU FOR YOUR PURCHASE ...

Your JBL product has been designed to provide you with the performance and ease of operation you would expect from JBL.

- Please take time to read your owner's manual in its entirety before operating or installing your amplifier.
- Keep the owner's manual for your amplifier in safe keeping along with the owner's manual for your boat or vehicle.
- Put your amplifier sales receipt with other important documents in order to expedite warranty service if needed.

ABOUT THE MANUAL

This manual describes general installation guidelines and operation instructions. However, please note that proper installation of mobile audio and video components requires qualified experience with mechanical and electrical procedures. If you do not have the knowledge and tools to successfully perform this installation, we strongly recommend consulting an authorized JBL dealer about your installation options. Keep all instructions and sales receipts for reference. Consider this manual as an indispensable feature of your amplifier.



JBL MARINE

TABLE OF CONTENTS

CHAPTER 1: PICTORIAL INDEX OF INPUT CONNECTIONS	01
CHAPTER 2: INSTALLATION AND WIRING	02
What's in the box	02
Precautions	02
1. Power indicator	03
2. Protect indicator	03
3. Speaker output connectors	03
4. Fuses	06
5. Power input connectors	06
6. Front and rear inputs and outputs (RCA)	06
7. Input level	07
8. Crossover filter selectors	07
9. Gain	07
10. Crossover frequency controls	07
CHAPTER 3: OPERATIONS	08
CHAPTER 4: TROUBLESHOOTING	09
CHAPTER 5: SPECIFICATIONS	10



by HARMAN

CHAPTER 1: PICTORIAL INDEX OF INPUT CONNECTIONS

MARINE Amplifier top panel

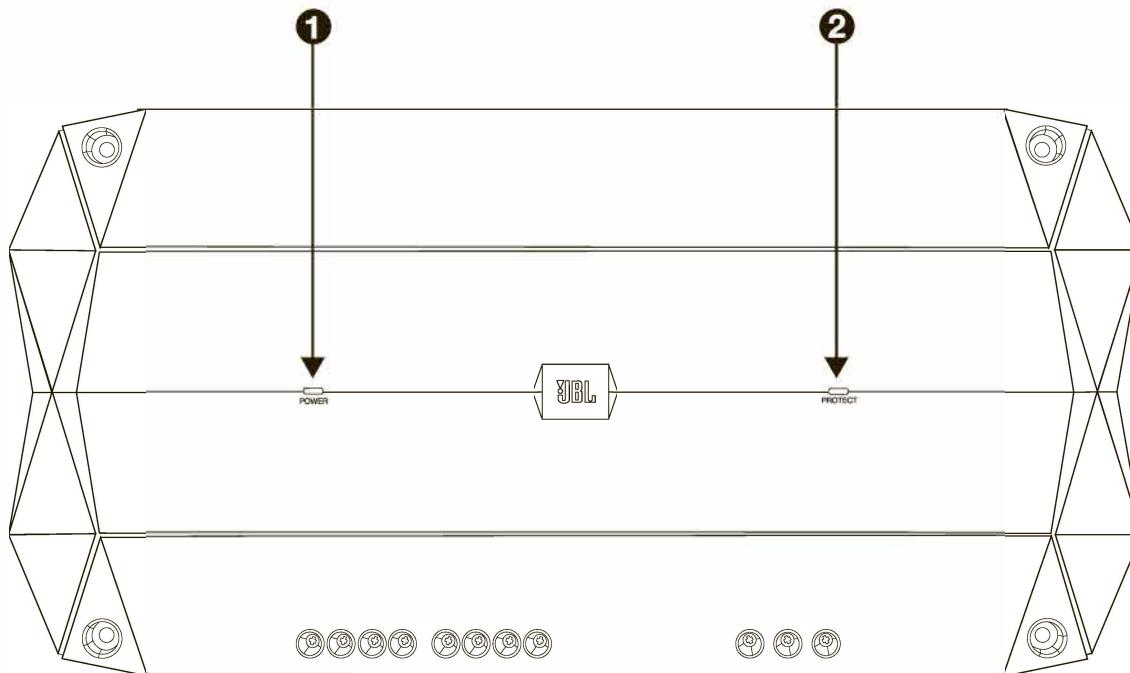

MARINE Amplifier front panel

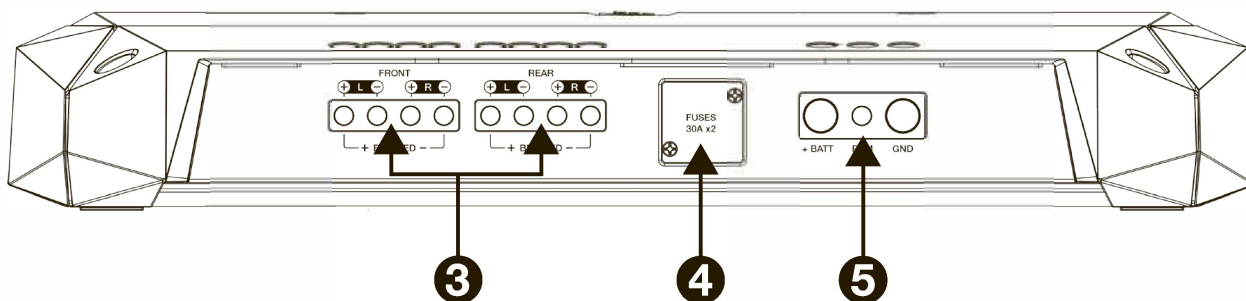

MARINE Amplifier back panel

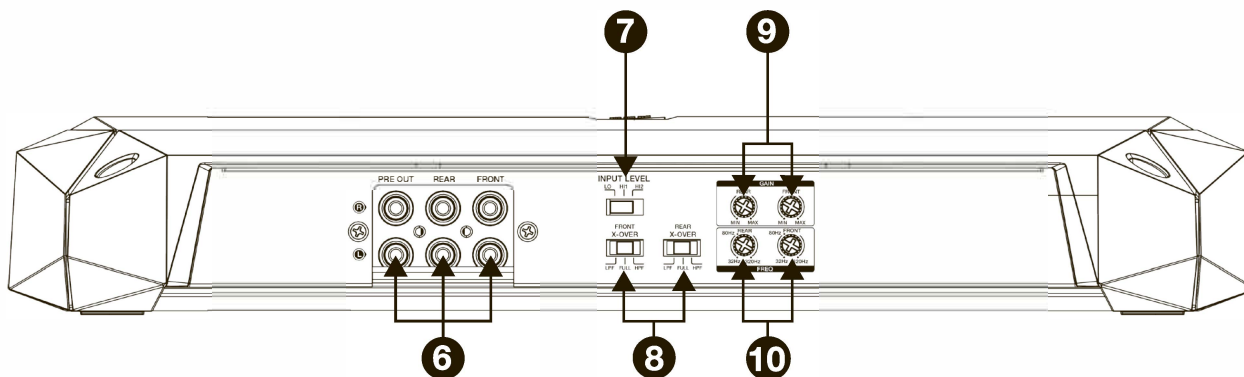

JBL MARINE

CHAPTER 2: INSTALLATION AND WIRING

What's in the box:

JBL Marine MA704

1 amplifier
Stainless steel mounting hardware
Rubber inserts
4 High-level input adapters
2 spare fuses
2 2-color brand stickers
Quick start guide

JBL Marine MA4505

1 amplifier
Stainless steel mounting hardware
Rubber inserts
4 High-level input adapters
3 spare fuses
2 2-color brand stickers
Quick start guide

Precautions:

IMPORTANT: Disconnect the vehicle's negative (–) battery terminal before beginning the installation.

- Always wear protective eyewear when using tools.
- Choose a safe mounting location, away from moisture. Check clearances on both sides of a planned mounting surface. Be sure that screws or wires will not puncture brake lines, fuel lines, or wiring harnesses and that wire routing will not interfere with the safe vehicle operation. Use caution when drilling or cutting in the mounting area.
- When making electrical connections, make sure they are secure and properly insulated.
- If you must replace any of the amplifier's fuses, use the same type of fuse and current rating as the original.
- To keep the amplifier cool, choose a location that provides good air circulation.
- Do not mount the amplifier with the heat sink facing downward, as this interferes with cooling.
- **Mount the amplifier in an area protected from the outdoor environment where it will not be exposed to direct contact with the elements.**
- Mount the amplifier so that it will not be damaged by shifting cargo, and so that it remains dry.
- Using the amplifier as a template, mark the locations of the holes on the mounting surface.
- Drill pilot holes in the mounting surface.
- Attach the amplifier to the mounting surface with four appropriate mounting screws (included).

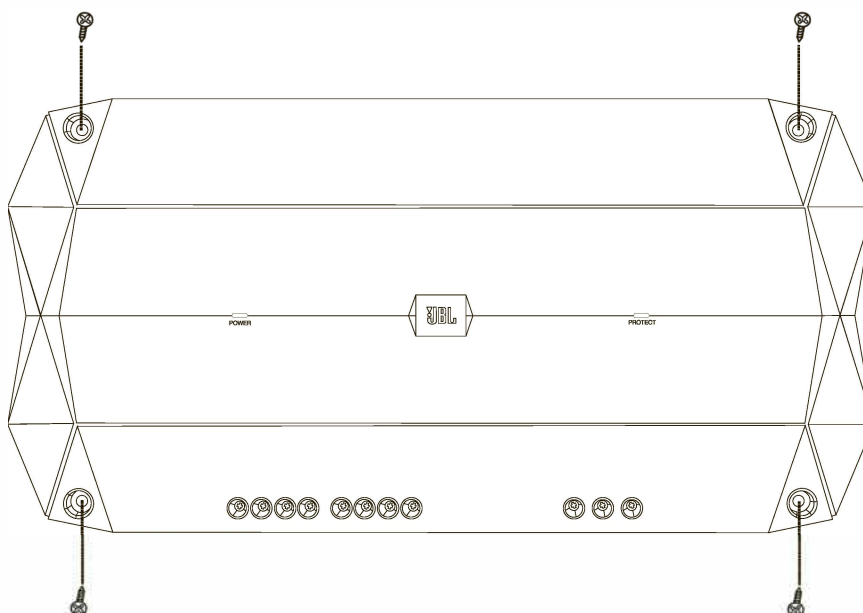

NOTE: You may find it more convenient to make all of the connections to the amplifier before you permanently mount it.



1. Power indicator:

The light will illuminate in blue when the amp is receiving power and playing.

2. Protect indicator:

The indicator will illuminate in red if the amp enters Protect mode in the event of conditions such as over/under voltage, short circuit, amplifier output circuit failure, or excessive heat.

3. Speaker Output Connectors:

- Connect the speakers to these terminals, observing proper polarity (connect each speaker's positive (+) lead to the appropriate positive (+) terminal, and negative (-) lead to the appropriate negative (-) terminal).
- The MA704 features Front L+, L-, R+, and R- terminals, and Rear L+, L-, R+, and R- terminals.
 - 4-channel operation: Connect the front left speaker to the Front L+ and L- terminals, and the front right speaker to the Front R+ and R- terminals. Connect the rear left speaker to the Rear L+ and L- terminals, and the rear right speaker to the Rear R+ and R- terminals.

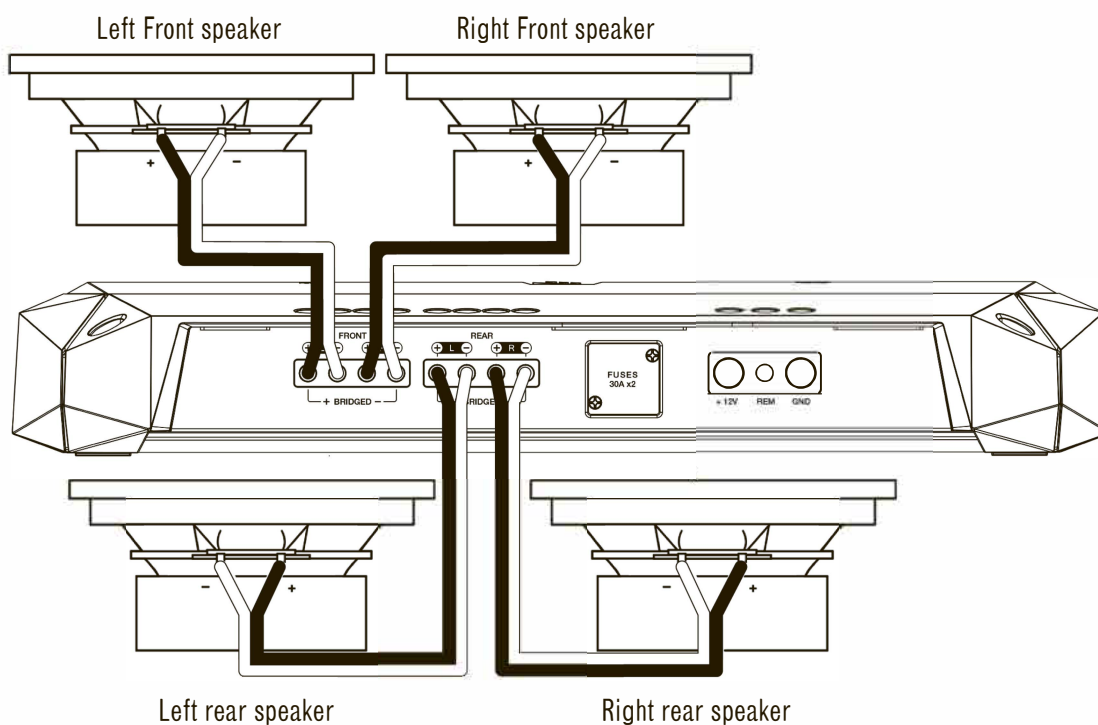

JBL MARINE

- 3-channel operation: Connect the stereo speakers to the Front terminals, as described above. Connect the single speaker's + lead to the Rear L+ terminal, and the - lead to the Rear R- terminal.

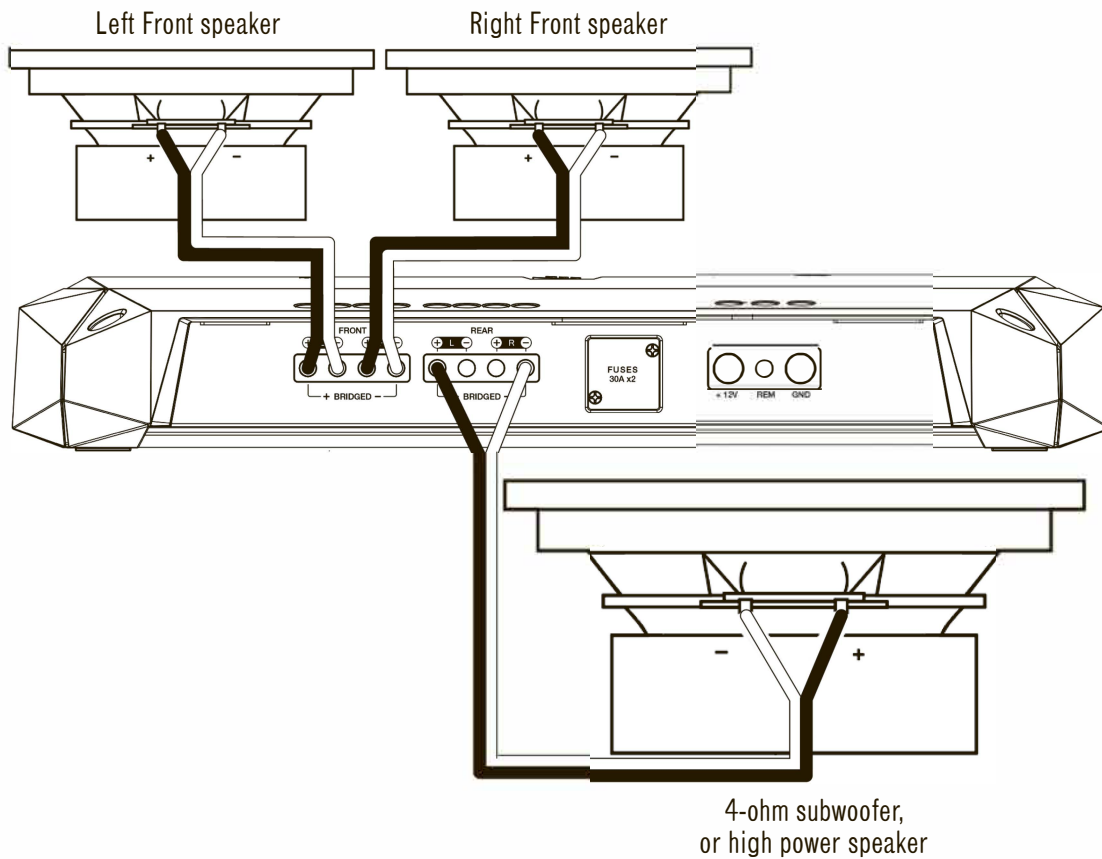

- 2-channel (bridged) operation: Connect one speaker's + lead to the Front L+ terminal, and the - lead to the Front R- terminal. Connect the other speaker's + lead to the Rear L+ terminal, and the - lead to the Rear R- terminal.

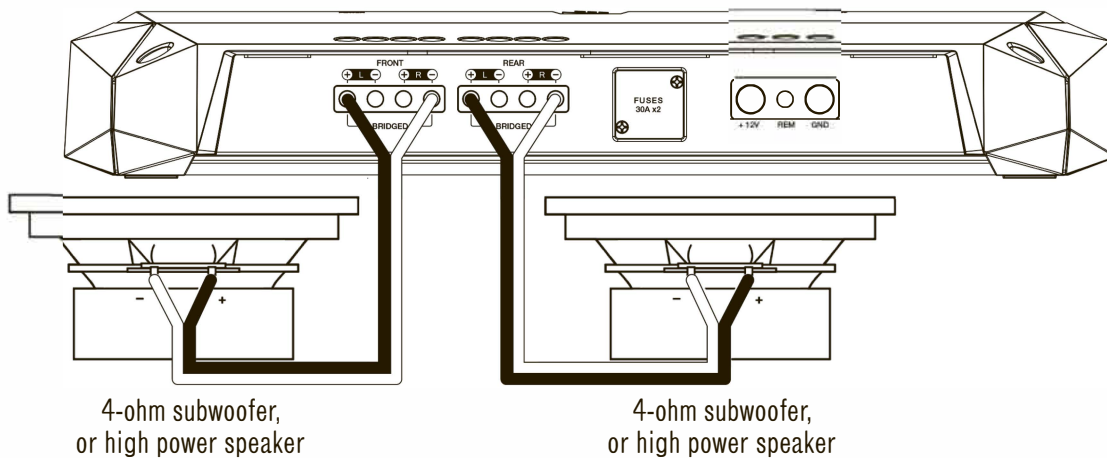



- The MA4505 features Front L+, L-, R+, and R- terminals; Rear L+, L-, R+, and R- terminals; and Sub + and - terminals.
 - 5-channel operation: Connect the front left speaker to the Front L+ and L- terminals, and the front right speaker to the Front R+ and R- terminals. Connect the rear left speaker to the Rear L+ and L- terminals, and the rear right speaker to the Rear R+ and R- terminals. Connect the subwoofer's positive (+) lead to the + terminal, and the negative (-) lead to the - terminal.

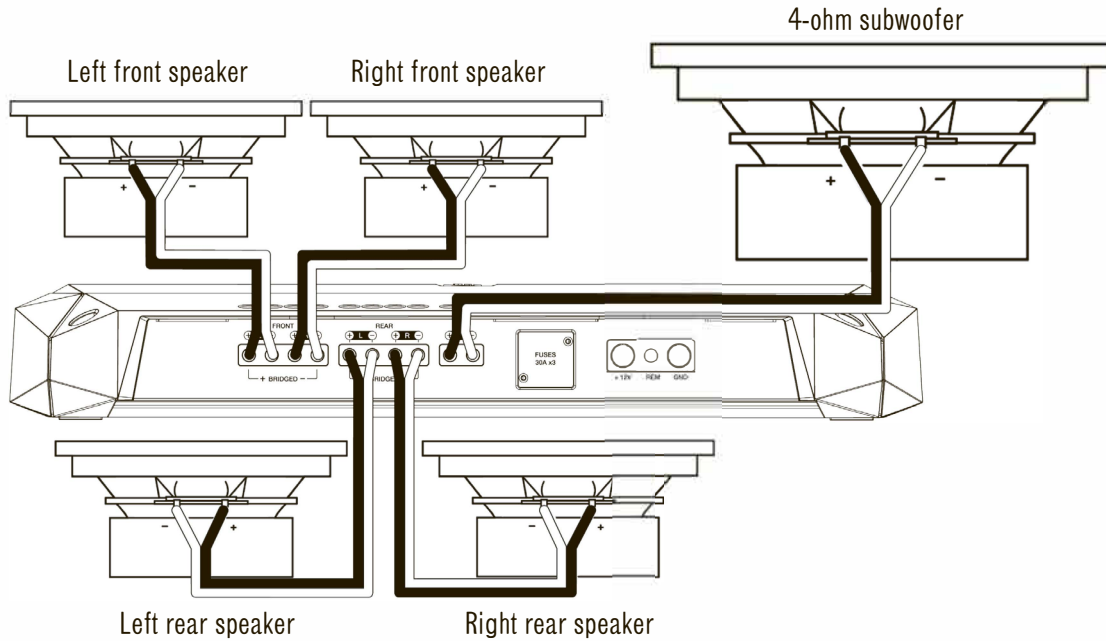

- 3-channel (front and rear bridged) operation: Connect one speaker's + lead to the Front L+ terminal, and the - lead to the Front R- terminal. Connect the other speaker's + lead to the Rear L+ terminal, and the - lead to the Rear R- terminal. Connect the subwoofer's positive (+) lead to the + terminal, and the negative (-) lead to the - terminal.

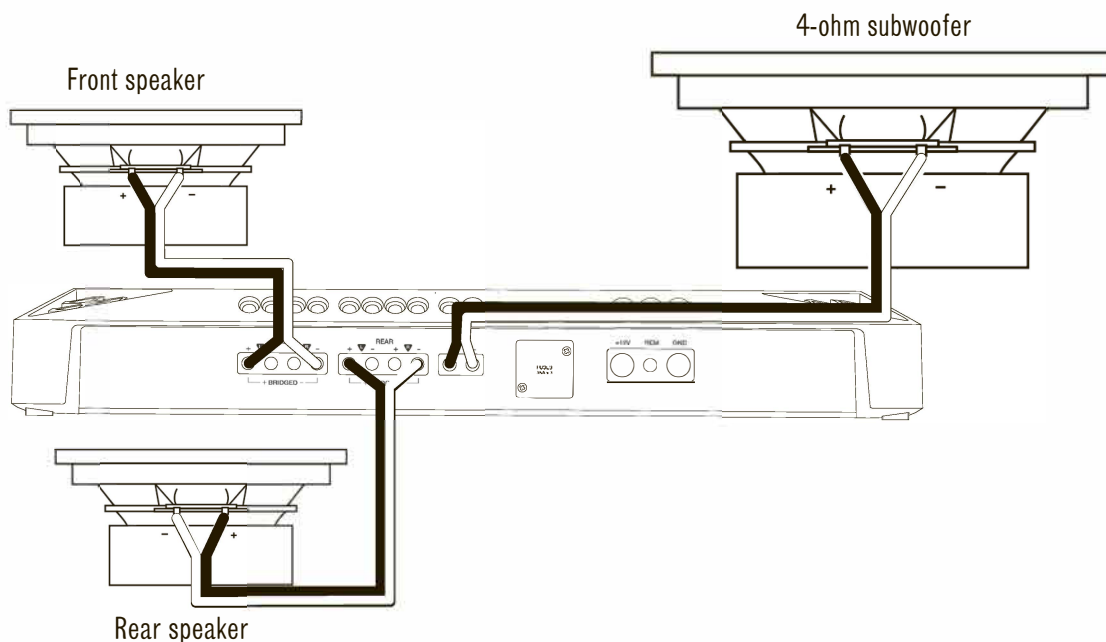

NOTE: Minimum speaker impedance for stereo full-range and subwoofer operation is 2ohms. Minimum speaker impedance for bridged operation is 4ohms.

JBL MARINE

4. Fuses:

- Replace only with fuses of the same amperage:
 - MA704: 30A
 - MA4505: 30A

5. Power Input Connectors:

- **Power:** Run power wire from the +12V input to the positive terminal of the vehicle's battery. Install an appropriate fuse holder and fuse (60A minimum on MA704, 105A to 100A minimum on MA4505) within 18" (457mm) of the battery. Make sure the wire is not damaged or pinched during installation. Install protective grommets when routing wires through the bulkhead or other sheet metal. Use larger-gauge wiring for longer runs.
 - MA704 minimum wire size: 8 gauge
 - MA4505 minimum wire size: 4 gauge

- **Ground:** Run a wire (the same gauge as the power wire) from the GND input to the battery's negative terminal, using a ring terminal.

Note: A larger gauge wire may be needed when the amplifier is not located near the battery. Where applicable, remove any paint from the vehicle chassis and connect with a bolt and star washer (below the ring terminal) for a secure connection.

- **Remote:** Connect a 20-gauge wire from the "Remote Out" lead of the source unit to the REM input. This lead turns the amplifier on when using low-level input signals.

6. Front and rear inputs and outputs (RCA):

- If your source unit offers preamp outputs, connect to the FRONT, REAR, and/or SUB inputs using RCA patch cables.
- To connect a second amp directly to the **MA704** amplifier, run a patch cable from the PRE OUT outputs to the second amp's preamp inputs.

If your audio system's head unit does not have line-level outputs:

Use the supplied bare wire-to-RCA adapters to connect the amplifier's inputs to either the front or the rear speaker outputs of your car audio system's head unit (splice crimps not included).

Use a small Phillips screwdriver to loosen the adapter's set screws and insert the speaker wires into the holes on the back of the adapter. Tighten the set screws to secure the wires.

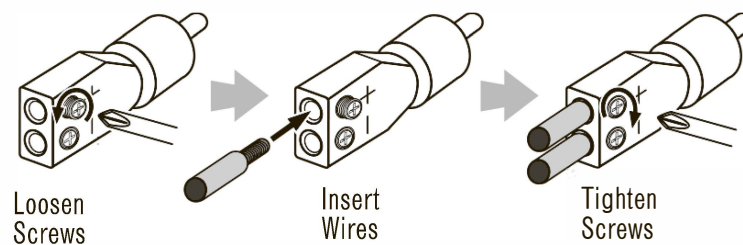



Always connect the (+) speaker wire to the adapter's (+) terminal and the (-) speaker wire to the adapter's (-) terminal. When all wires are connected, plug the adapters into the amplifier's FRONT (and REAR, if using the 4-channel amplifier) preamp inputs.

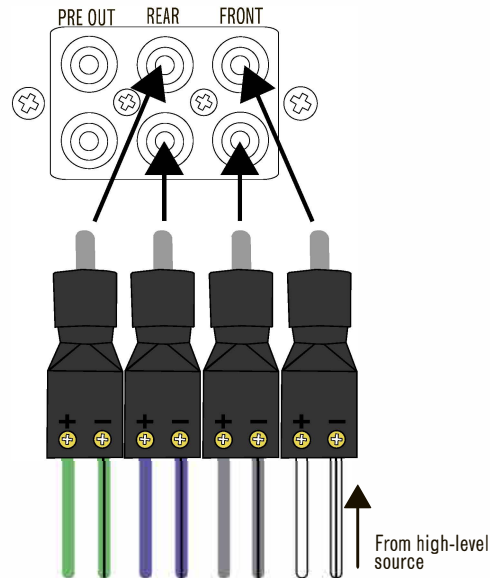

7. Input level:

Use this switch along with the gain control to set the amplifier's input level. If use a radio's RCA-level outputs, set the Input Level switch to the "LO" position. If using high-level outputs, start the control-setting process with the Input Level switch set in the "HI1" position.

Note: If you have connected your amplifier to the audio system's speaker outputs, the audio signal may fail to play. If this happens, change the Input Level switch to the "HI2" position. The "HI2" position includes a circuit designed to fool this type of factory audio system into "seeing" a speaker connected to its input.

Important: The "HI2" setting should never be used when the amplifier is connected to an aftermarket head unit's line-level (RCA-type) outputs.

8. Crossover filter selectors (X-OVER):

Crossover-filter selectors.

- LP: Low pass. Choose this setting if you're connecting a subwoofer(s), or want to provide a low-pass filter for separate mid-bass speakers.
- FULL: Full range. Choose this setting if you're connecting full-range speakers, and not using a subwoofer in your system.
- HP: High pass. Choose this setting to prevent lowbass from reaching midrange or full-range speakers when you're using a subwoofer in your system. (See **setting the crossovers** in Chapter 3.)

9. Input level selectors (GAIN):

Input level controls. Use these to match the amp's input sensitivity to the output level of your source unit. See 17 for a recommended adjustment procedure. (See **Setting the input levels** in Chapter 3 for a recommended adjustment procedure.)

10. Crossover-filter frequency controls (FREQ):

Crossover-filter frequency controls. Turn the dials to the left to lower the crossover point, and to the right to raise the crossover point. Crossover point settings vary by listener preference.

JBL MARINE

CHAPTER 3: OPERATIONS

Setting the input levels:

To match your amplifier's input sensitivity (gain) to your source unit's output level, we recommend the following procedure:

- A. Turn both input level controls counterclockwise to MIN (minimum).
- B. Play a dynamic music track through your source unit. Turn the source unit's volume control to the 3/4 position.
- C. Turn the front input level control dial clockwise towards MAX until you hear distortion in the music (it's no longer clear).
- D. Slowly turn the front level input control dial counterclockwise until the music sounds clear again.
- E. Your front input level is now correctly set. Repeat this process with the rear channels.

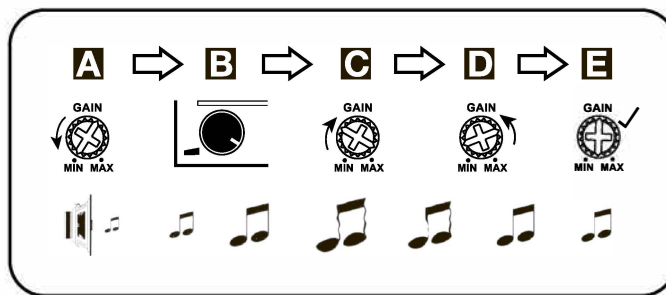

Setting the crossover

Properly setting crossover filter selectors optimizes frequency distribution for efficient speaker operation and best sound.

Step 1: Use the slider controls to select low-pass (LP), FULL, or high-pass (HP).

- LP: Low pass. Choose this setting if you are connecting a subwoofer(s) or want to provide a low-pass filter for separate mid-bass speakers.
- FULL: Full range. Choose this setting if you are connecting full-range speakers and are not using a subwoofer in your system.
- HP: High pass. Choose this setting to prevent low bass from reaching midrange or full-range speakers when you are using a subwoofer in your system.

Step 2: Use crossover-filter frequency controls to adjust crossover point settings for coaxial speakers and subwoofers to suit listener preference. Turn the dials to the left to lower the crossover point and to the right to raise the crossover point. Exact crossover settings for coaxial speakers and subwoofers finally depend on your listening preferences. **NOTE:** crossover point does not apply in FULL mode.

Adjusting the subwoofer:

Select INT if you're connecting a subwoofer to the MA4505 amplifier, but your source unit does not feature a subwoofer output (this will send a summed audio signal to the subwoofer). If your source unit does feature a subwoofer output, select EXT to connect to that output.

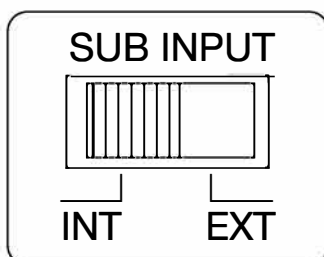



Selecting the subwoofer phase

You can choose a subwoofer phase output of 0° or 180°. To check your sub's phase, play music with lots of bass and listen as another person slowly flips the 0/180 degree phase switch back and forth. The correct setting is the one that gives you more bass. If you don't detect any real difference, leave the switch in the 0 setting.

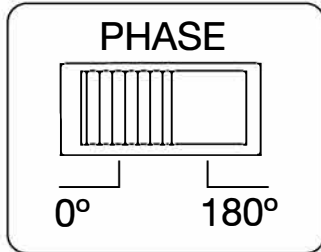

Boosting the bass

Turn the dial clockwise to increase the bass output from 0 dB to +9 dB.

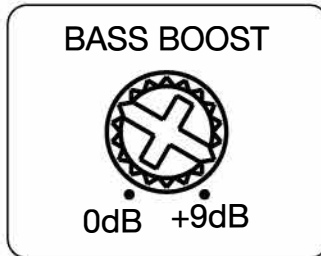

CHAPTER 4: TROUBLESHOOTING

PROBLEM: No audio and POWER INDICATOR is off.

CAUSE and SOLUTION: No voltage at BATT+ and/or REM terminals, or bad or no ground connection. Check voltages at amplifier terminals with VOM.

PROBLEM: No audio and PROTECT INDICATOR flashes every 4 seconds.

CAUSE and SOLUTION: DC voltage on amplifier output. Amplifier may need service; see enclosed warranty card for service information.

PROBLEM: No audio and PROTECT INDICATOR is on.

CAUSE and SOLUTION: Amplifier is overheated. Make sure amplifier cooling is not blocked at mounting location. Verify that speaker-system impedance is within specified limits. Or, there may be voltage greater than 16V (or less than 8.5V) on BATT+ connection. Check vehicle charging system.

PROBLEM: No audio and PROTECT and POWER INDICATORS flash.

CAUSE and SOLUTION: Voltage less than 9V on BATT+ connection. Check vehicle charging system.

PROBLEM: Distorted audio.

CAUSE and SOLUTION: Gain is not set properly. Check INPUT LEVEL setting. Check speaker wires for shorts or grounds. Amplifier or source unit may be defective.

JBL MARINE

PROBLEM: Distorted audio and PROTECT INDICATOR flashes.

CAUSE and SOLUTION: Short circuit in speaker or wire. Remove speaker leads one at a time to locate shorted speaker or wire, and repair.

PROBLEM: Music lacks dynamics or "punch."

CAUSE and SOLUTION: Speakers are not connected properly. Check speaker connections for proper polarity.

PROBLEM: Amplifier fuse keeps blowing.

CAUSE and PROBLEM: The wiring is connected incorrectly or there is a short circuit. Review installation precautions and procedures in manual. Check wiring connections.

PROBLEM: Engine noise—whining or clicking—in system when the engine is on.

CAUSE and PROBLEM: Amplifier is picking up alternator noise. Turn down gain. Move audio cables away from power wires. Install an alternator noise filter on power line between battery and alternator. Check ground connections on the amplifier since a loose or improper ground is one of the main causes for extraneous noise in your audio system.

CHAPTER 5: SPECIFICATIONS

Model	RMS power @ 4 ohms	RMS power @ 2 ohms	RMS bridged power @ 4 ohms	Total peak power	Frequency response	Maximum signal input	Maximum sensitivity
MA704	70W x 4	100W x 4	200W x 2	1000W	10Hz-40kHz	20V	200mV
MA4505	45W x 4	65W x 4	130W x 2	1800W	10Hz-40kHz (full range)	20V	200mV
	320W x 1	500W x 1	N/A		10Hz-320Hz (sub)		

Model	Line in signal-to-noise ratio (reference to 1 watt)	THD+N at rated power (20Hz - 20kHz)	Product dimensions (L x W x H)	Shipping weight	Fuse size	Operating voltage	Minimum Current Draw
MA704	≥85dB	≤1%	375 x 189.4 x 59mm (14-13/16" x 7-1/2" x 2-3/8")	3.61kg (7.96lbs)	30A x 2	9-16VDC	≤1.2A
MA4505	Full: ≥85dB	≤1%	400 x 189.4 x 59mm (15-3/4" x 7-1/2" x 2-3/8")	4.12kg (9.08lbs)	30A x 3	9-16VDC	≤2A
	Sub: ≥80dB						

[View other marine amplifiers made by JBL on our website.](#)