

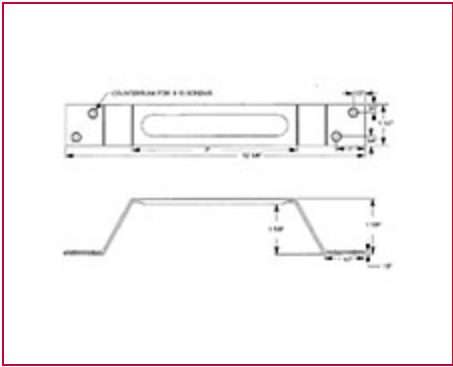

Part # 12571W, AGH-715 Aluminum Gate Handle

Dual mounting holes on each end for added strength.



[Specifications](#) | [Applications](#)

Specifications	
Width (Fractional)	1-1/2 in
Overall Length	10-1/4 in
	12-1/4 in
	14-1/4 in
Hinge Length	7 in
Material Thickness	0.120 in
	11 gauge
Material	Aluminum
Finish	Satin clear Anodized for Corrosion protection

Weight

0.230 lb

Applications

Applications

Can be used on Gates, Fences,
Around Pools, Industrial Equipment
Beach or Coastal Properties, Farms
or Outdoors.