

KLYMIT 

*Sleep Outside*TM



2021-2022 CATALOG



KLYMIT 
Sleep Outside
.....
DESIGNED & TESTED
IN THE
WASATCH MOUNTAINS

We're here to make your outdoor experience the best one yet.

Born in the backcountry of the Wasatch Mountains and based in Kaysville, UT, Klymit has been challenging the conventional approach to outdoor gear since 2007. We know nothing ruins a camping trip like a poor night's sleep, which is why we work hard every day to create gear that is comfortable, easy-to-use, and engineered for every adventure. Our team designs and tests all of our gear in the illustrious deserts and mountains of Utah to ensure everything is **durable, high-quality, value driven and most importantly, comfortable.**



“An outdoor adventure can be swiftly spoiled by a poor night's rest; Klymit's focus is solely on preventing this from happening.”

— *Conde Nast Traveler*



TABLE OF CONTENTS

Who Is Klymit?	2
NEW Everglow™ Light Tubes	8
NEW Homestead™ & Horizon™ Blankets	12
NEW Big Cottonwood™ Sleeping Bags	16
More NEW Products	18
Klymaloft™ Sleeping Pads	24
Static™ Sleeping Pads	28
Inertia™ Sleeping Pads	40
Sleeping Bags	42
Pillows	50
Tents	54
Accessories	64
Hammocks & Shelters	74
Backpacks	80





A person wearing a pink beanie, a dark puffy jacket, and light-colored pants is sitting on a black camp stool, looking out over a calm lake. The sun is low on the horizon, creating a bright reflection on the water and a lens flare effect. In the background, there are large, rugged mountains with patches of snow. To the left, a white tent is partially visible, and a brown dog is sitting on the grass. The overall scene is peaceful and scenic.

“This brand has succeeded in winning the hearts of millions of customers with its super-affordable products.”

— *Gear Hungry*

THE ALL-NEW EVERGLOW™ LIGHT TUBE

BRIGHT IDEA

Go-anywhere, inflatable camp lantern

The Everglow™ Light Tube is an inflatable, easy-to-use light tube that provides both directional and lantern-style lighting. The efficient five-volt white LED light tube is perfect for camping and outdoor adventures. The Everglow™ Light Tube's inflatable chamber reduces harsh light by diffusing the LED light. It packs down to fit in your pocket and easily attaches to your tent, awning, or car door via a hypalon carabiner loop. Powered by a USB input. Light up your next adventure.



DIMMER SWITCH

Controls brightness
up to 270 lumens
(LG and XL models only)

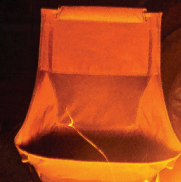



**3 MAGNETIC POINTS
OF ATTACHMENT**

Attach to your car or
most metal surfaces



YOUR CHOICE OF POWER

Plugs into most USB
power banks or sources



NEW PRODUCTS





EVERGLOW™ LIGHT TUBE (REG)

Weight	1.9 oz (55 g)
Dimensions	18 x 3 in (46 x 8 cm)
Lumens	160
Power Usage	800 mAh / 3 watt hours
Pack Size	4 x 3 x 3 in (10 x 8 x 8 cm)
Fabric	TPU
Cord Length	14 in / 36 cm
Warranty	Two-Year Warranty
SKU	17EVGR01C

- Lightweight and flexible design offers a variety of lighting options
- White LED light
- Compatible with most USB power sources*
- Note: REG size does NOT include dimmer switch, magnets, or stuff sack



EVERGLOW™ LIGHT TUBE (LG)

Weight	3.7 oz (104 g)
Dimensions	26 x 3 in (66 x 8 cm)
Lumens	220
Power Usage	1200 mAh / 4.5 watt hours
Pack Size	4 x 3 x 3 in (10 x 8 x 8 cm)
Fabric	TPU
Cord Length	21 in / 53 cm
Warranty	Two-Year Warranty
SKU	17EVGR01D

- Lightweight and flexible design offers a variety of lighting options
- White LED light with a dimmer switch to easily control the intensity of light
- Compatible with most USB power sources*



EVERGLOW™ LIGHT TUBE (XL)

Weight	4 oz (113 g)
Dimensions	34 x 4.75 in (86 x 12 cm)
Lumens	270
Power Usage	1600 mAh / 6 watt hours
Pack Size	5 x 3 x 3 in (13 x 8 x 8 cm)
Fabric	TPU
Cord Length	21 in / 53 cm
Warranty	Two-Year Warranty
SKU	17EVGR01E

- Lightweight and flexible design offers a variety of lighting options
- White LED light with a dimmer switch to easily control the intensity of light
- Compatible with most USB power sources*

To clean: spot wash with warm water only and hang to dry.
*Power source not included.

THE ALL-NEW HOMESTEAD™ AND HORIZON™ BLANKETS

WE'VE GOT YOU COVERED



Our new blanket line features a full range of blankets for every type of adventure from lightweight backpacking to plush luxury comfort. Every blanket is meticulously designed to be the best “one more piece of gear” you have to have on your next trip.

HORIZON TRAVEL BLANKET (a)

Meet your new must-have travel accessory. The Horizon Travel Blanket is the ultimate take-everywhere blanket. The blanket features four corner stake locations* perfect for securing your blanket to the ground for picnics and game day. Designed with durable, water resistant, lightweight fabric that packs down small. *Stakes not included.

HORIZON BACKPACKING BLANKET (b)

The Horizon Backpacking Blanket is a technical, lightweight backpacking blanket featuring a soft-touch, high performance, lightweight 20D polyester fabric. Synthetic high loft insulation keeps you warm on chilly nights. Quilted stitch pattern keeps insulation in place and eliminates cold spots. Perfect for fast and light adventurers.

HORIZON OVERLAND BLANKET (c)

The Horizon Overland Blanket is adventure ready. Tough, rugged, and durable, this blanket is designed for trailblazers who are hard on their gear. Featuring a soft fleece interior and a water resistant, durable PU coated ripstop exterior, the Horizon Overland Blanket is perfect for tossing down in the dirt.

HOMESTEAD CABIN COMFORTER (d)

The Homestead Cabin Fleece Comforter is the ultimate in luxury comfort. Wrap yourself up in this plush, soft, high loft, fleece-lined blanket with a durable, canvas exterior. Thick, synthetic high loft insulation will keep you warm while you cozy up next to the fire. Perfect for draping over the chair at the cabin or throwing in your RV.



HORIZON™ TRAVEL BLANKET

LIGHTWEIGHT AND DURABLE TAKE-EVERYWHERE BLANKET

Weight	27.4 oz / 777 g
Dimensions	80 x 58 in / 204 x 148 cm
Pack Size	10 x 6 in / 25 x 15 cm
Fabric	Soft Touch 68D Polyester
Insulation	120 GSM 100% Polyester Fiber
Warranty	Two-Year Warranty
SKU	13HTGY01C



CAR/TENT
CAMPING



GAME
DAY

- Durable, water resistant, soft touch polyester fabric
- Synthetic insulation
- Four corner stake locations (stakes not included)
- Quilted stitch pattern keeps insulation in place and eliminates cold spots
- Machine washable on delicate cycle (do not use agitator), hang to dry
- Stuff sack included

HORIZON™ BACKPACKING BLANKET

BACKPACKING BLANKET FOR LIGHTWEIGHT ADVENTURES

Weight	29 oz / 822 g
Dimensions	80 x 58 in / 204 x 148 cm
Pack Size	10 x 6 in / 25 x 15 cm
Fabric	20D Ripstop Polyester
Insulation	170 GSM 100% Polyester Fiber
Warranty	Two-Year Warranty
SKU	13HBBL01C



BACKPACKING



GAME
DAY

- Water resistant, lightweight 20D polyester fabric
- Synthetic high loft insulation
- Quilted stitch pattern keeps insulation in place
- Included compression stuff sack packs down small
- Machine washable on delicate cycle (do not use agitator), hang to dry



HORIZON™ OVERLAND BLANKET

RUGGED, DURABLE BLANKET FOR YOUR NEXT ADVENTURE

Weight	54.5 oz / 1,545 g
Dimensions	80 x 58 in / 204 x 148 cm
Pack Size	14 x 14 x 8 in / 36 x 36 x 20 cm
Fabric	200D PU Coated Ripstop
Insulation	100% Polyester Fleece Liner
Warranty	Two-Year Warranty
SKU	13HOGY01C



CAR/TENT
CAMPING



GAME
DAY

- Soft fleece interior
- Durable, water resistant PU coated ripstop exterior
- Quilted stitch pattern keeps insulation in place and eliminates cold spots
- Synthetic high loft insulation
- Machine washable on delicate cycle (do not use agitator), hang to dry
- Integrated stuff sack that doubles as an interior pocket when the blanket is in use



HOMESTEAD™ CABIN COMFORTER

PLUSH FLEECE-LINED COMFORTER FOR THE ULTIMATE IN LUXURY COMFORT

Weight	REG: 80 oz / 2,270 g
	QUEEN: 120 oz / 3,402 g
Dimensions	REG: 80 x 58 in / 204 x 148 cm
	QUEEN: 90 x 80 in / 229 x 204 cm
Pack Size	REG: 17 x 17 x 8 in / 43 x 43 x 20 cm
	QUEEN: 23 x 20 x 11 in / 58 x 51 x 28 cm
Fabric	Nylon Poly Dobby
Insulation	High Loft Fleece Liner
Warranty	Two-Year Warranty
SKU	REG: 13HCBL01C / QUEEN: 13HCBL01D



CAR/TENT
CAMPING



CABIN
VACATION



RV
CAMPING

- Plush, soft, high loft, fleece-lined interior
- Synthetic high loft insulation
- Quilted stitch pattern keeps insulation in place and eliminates cold spots
- Durable, water resistant canvas exterior
- Machine washable on delicate cycle (do not use agitator), hang to dry
- Stuff sack included

THE ALL-NEW BIG COTTONWOOD SLEEPING BAGS

PLENTY OF ROOM FOR COMFORT

Four-season canvas sleeping bag with plenty of room for comfort

The Big Cottonwood sleeping bag is designed for those unwilling to sacrifice comfort. You'll forget all about your bed at home in this oversized, rectangular sleeping bag with plenty of room to stretch out. Featuring a rugged, canvas exterior with a soft-touch polyester liner, the Big Cottonwood's high loft synthetic insulation will keep you warm in below freezing temperatures. A drawstring shoulder baffle seals in warmth and eliminates a cold draft. This ultra-comfortable sleeping bag is perfect for base camping, vans, RVs, trailers, and cabins.



BIG COTTONWOOD -20

FOUR-SEASON CANVAS SLEEPING BAG WITH PLENTY OF ROOM FOR COMFORT

Weight	18 lb / 8.1 kg
EN Rating	-20° F / -29° C
Dimensions	80 x 38 in (203 x 97 cm)
Pack Size	40 x 16 in / 102 x 41 cm
Insulation Type	100% Polyester Hollow Fibre
Shoulder Girth	76 in / 193 cm
Fabric	420D Poly Canvas Exterior 190T Brushed Poly Pongee Liner
Warranty	Two-Year Warranty
SKU	13CTWAN2D

PRODUCT FEATURES:

- Rectangular design allows plenty of room to stretch out
- Rugged, canvas exterior with a soft-touch polyester liner
- High loft synthetic insulation keeps you warm in below freezing temperatures
- Adjustable, detachable sleeping bag hood to customize your sleep experience
- Drawstring shoulder baffle seals in warmth and eliminates a cold draft
- Zip together with a second sleeping bag to create room for two
- Carry bag included



BIG COTTONWOOD 0

FOUR-SEASON CANVAS SLEEPING BAG WITH PLENTY OF ROOM FOR COMFORT

Weight	15.8 lb / 7.1 kg
EN Rating	0° F / -18° C
Dimensions	80 x 38 in (203 x 97 cm)
Pack Size	40 x 14 in / 102 x 36 cm
Insulation Type	100% Polyester Hollow Fibre
Shoulder Girth	76 in / 193 cm
Fabric	420D Poly Canvas Exterior 190T Brushed Poly Pongee Liner
Warranty	Two-Year Warranty
SKU	13CTGR00D

PRODUCT FEATURES:

- Rectangular design allows plenty of room to stretch out
- Rugged, canvas exterior with a soft-touch polyester liner
- High loft synthetic insulation keeps you warm in below freezing temperatures
- Adjustable, detachable sleeping bag hood to customize your sleep experience
- Drawstring shoulder baffle seals in warmth and eliminates a cold draft
- Zip together with a second sleeping bag to create room for two
- Carry bag included





COAST™ TRAVEL PILLOW

COMFORTABLE, SYNTHETIC FILL PILLOW THAT PACKS DOWN SMALL

Weight	4 oz / 116 g
Dimensions	18 x 12 in / 31 x 46 cm
Pack Size	11 x 5 in / 28 x 13 cm
Fabric	Brushed Polyester
Fill	9 oz Polyester Fiber
Warranty	Two-Year Warranty
SKU	Teal: 12CTBL01C / Yellow: 12CTYL01C

- Brushed polyester, soft outer pillowcase
- Comfortable synthetic fill
- Packs down small for easy travel
- Storage bag included



NEST™ LG XL

SOFT-TOUCH SLEEPING BAG LINER FOR HYGIENE AND EXTRA WARMTH

Weight	LG: 9.6 oz / 272 g
	XL: 11.2 oz / 318 g
Dimensions	LG: 78 x 35 in / 198 x 89 cm
	XL: 82 x 39 in / 208 x 99 cm
Pack Size	LG: 8.5 x 6.5 in / 22 x 17 cm
	XL: 10 x 8 in / 25 x 20 cm
Fabric	Polyester Pongee
Warranty	Two-Year Warranty
SKU	LG: 13NEGY01C / XL: 13NEGY01D

- Ultra brushed soft-touch fabric
- Quarter length slit opening with a velcro closure for easy entry and exit
- Pull string hood keeps you warm and your pillow in place
- Compatible with all Klymit sleeping bags, designed for both mummy and rectangular bags
- Integrated stuff sack doubles as a pocket
- Machine washable



(XL size shown in photo)



NEST™ LG XL

SOFT AND COOL BAMBOO FABRIC SLEEPING BAG LINER

FOR HOT WEATHER

Weight	LG: 21 oz / 590 g
	XL: 24 oz / 680 g
Dimensions	LG: 78 x 35 in / 198 x 89 cm
	XL: 82 x 39 in / 208 x 99 cm
Pack Size	LG: 8.5 x 8.5 in / 22 x 22 cm
	XL: 10 x 10 in / 25 x 25 cm
Fabric	100% Bamboo Fiber
Warranty	Two-Year Warranty
SKU	LG: 13NWGR01C / XL: 13NWGR01D

- Soft and cool bamboo fabric for hot weather
- Quarter length slit opening with a velcro closure for easy entry and exit
- Pull string hood keeps you warm and your pillow in place
- Compatible with all Klymit sleeping bags, designed for both mummy and rectangular bags
- Integrated stuff sack doubles as a pocket
- Machine washable



(XL size shown in photo)

NEST™ LG XL

MICROFLEECE SLEEPING BAG LINER

FOR COLD WEATHER

Weight	LG: 34 oz / 953 g
	XL: 40 oz / 1,134 g
Dimensions	LG: 78 x 35 in / 198 x 89 cm
	XL: 82 x 39 in / 208 x 99 cm
Pack Size	LG: 11 x 6 in / 28 x 15 cm
	XL: 12 x 6.5 in / 30 x 17 cm
Fabric	Microfleece
Warranty	Two-Year Warranty
SKU	LG: 13NCOR01C / XL: 13NCOR01D

- Microfleece fabric increases the warmth of your sleeping bag
- Quarter length slit opening with a velcro closure for easy entry and exit
- Pull string hood keeps you warm and your pillow in place
- Compatible with all Klymit sleeping bags, designed for both mummy and rectangular bags
- Compression sack included
- Machine washable



(XL size shown in photo)



“Klymit has taken the camping world by storm in recent years with a series of outstandingly well-made and affordable products.”

—*Adventure Digest*







GEAR DUFFEL 65L™ / 95L™ / 125L™

TRAVEL-FRIENDLY DUFFEL FOR ORGANIZING YOUR GEAR

Weight	65L: 2 lb / 907 g
	95L: 2.5 lb / 1,134 g
	125L: 2.92 lb / 1,306 g
Dimensions	65L: 25 x 13 x 12 in / 64 x 33 x 31 cm
	95L: 28 x 16 x 13 in / 71 x 41 x 33 cm
	125L: 32 x 17 x 14 in / 64 x 33 x 31 cm
Fabric	Tarpaulin
Warranty	Two-Year Warranty
SKU	65L: 12GDBK65D
	95L: 12GDBK95E
	125L: 12GDBK25F

- Durable, water-resistant outer fabric to keep your gear dry and protected
- Removable, comfortable shoulder straps allow the duffel to be worn as a backpack and feature cut outs to easily double as grab handles
- Two internal small accessory pockets and one external pocket
- Large internal pocket for storing dirty shoes or laundry
- Daisy chain webbing loops for attaching extra gear
- Grab handles on all sides of the duffel

INSULATED STATIC V CAMO™

REALTREE EDGE® EDITION

HEAT-RETAINING, LIGHTWEIGHT, EASY-TO-INFLATE
REALTREE EDGE® SLEEPING PAD

Weight	24 oz / 680 g
Dimensions	72 x 23 x 2.5 in / 183 x 58 x 6 cm
R-Value	4.4 (1.9 ASTM F3340-18)
Pack Size	8 x 5 in / 20 x 13 cm
Fabric	75D Polyester
Warranty	Klymit Limited Lifetime Warranty
SKU	06IVED02C

- Rugged 75D polyester fabric is soft and quiet
- Raised V-Chambers maximize loft and warmth, creating comfortable loft pockets that support the body's pressure points
- Side rails make it easier to stay on the pad through the night
- Inflation is fast and easy; compatible with Klymit Electric Pump and Rapid Air Pump™
- Patch and stuff sack included



PUMP SACK

AN EFFORTLESS ROLL-TOP PUMP

Weight	3.8 oz / 108 g
Dimensions	13.75 x 28 in / 35 x 71 cm
Pack Size	5 x 1.75 in / 13 x 4 cm
Capacity	20 Liters of air
Fabric	75D Polyester
Warranty	Two-Year Warranty
SKU	03PSGYFVC

COMPATIBILITY:

- **KLYMIT FLIP VALVE**
- Note: Confirm the valve type of your sleeping pad before ordering



THE KLYMALOFT™ SERIES

THIS IS REAL COMFORT

Inflatable sleeping pads with plush foam toppers for unmatched comfort

At Klymit, we're on a mission to deliver superior sleep comfort for your best night of sleep outside. **When we set out to design the Klymaloft sleeping pad, we asked ourselves one question: how can we make sleeping outside more like sleeping at home?** The Klymaloft Series features an innovative air and foam design. A plush foam topper conforms to support the body and eliminate pressure points, while the underlying I-beam chambers create loft and stabilize the sleeping pad. The air and foam strikes the perfect balance between comfort, pack size, and weight.



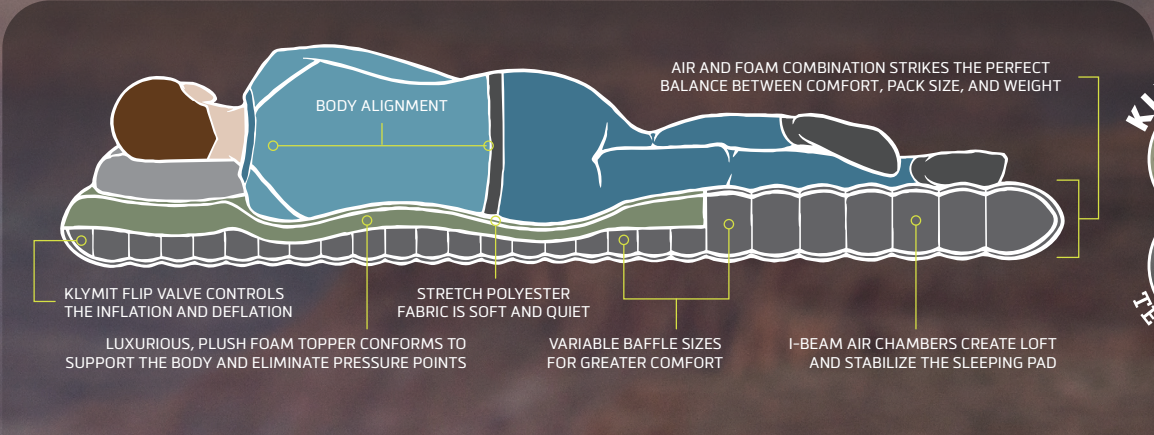

KLYMALOFT
 FOAM
 +
 AIR
 TECHNOLOGY



The Klymaloft Series features three sections: a **soft stretch polyester top**, a **layer of plush foam**, and a **section of I-beam air chambers** that vary in size. The small and large air chamber baffles support the foam topper resulting in a comfortable, cradled sleep position for the user.

What makes the Klymaloft series so comfortable?

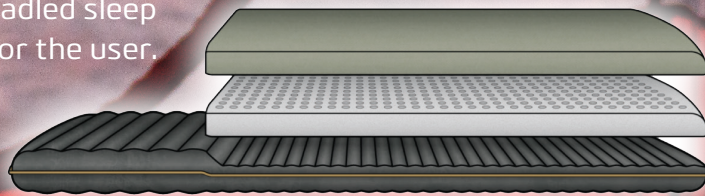

“It’s tough to say you’ll get your best sleep ever when practically sleeping on the ground, but this sleeping pad ensures you won’t miss your bed too much. The Klymaloft’s **foam topper is the definition of comfortable**, delivering much-needed support and stabilization while you sleep.”

—*Business Insider*



KLYMALOFT™ REG

Weight	2.4 lb / 1.1 kg
Dimensions	72 x 23 x 3.5 in / 183 x 58 x 9 cm
R-Value	2.1 ASTM F3340-18
Pack Size	11.5 x 8 in / 29 x 20 cm
Fabric	75D Polyester + Soft Stretch Top
Warranty	Klymit Limited Lifetime Warranty
SKU	06KLGRO1C



KLYMALOFT™ XL

Weight	3.2 lb / 1.45 kg
Dimensions	78x 29 x 5 in / 198 x 74 x 13 cm
Pack Size	15 x 7.5 in / 38 x 19 cm
Fabric	75D Polyester + Soft Stretch Top
Warranty	Klymit Limited Lifetime Warranty
SKU	06KLGRO1D

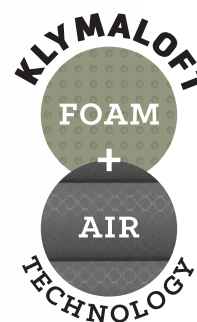

KLYMALOFT™ DBL

Weight	6 lb / 2.72 kg
Dimensions	78 x 53 x 5 in / 183 x 135 x 13 cm
Pack Size	26.75 x 9 in / 68 x 22 cm
Fabric	75D Polyester + Soft Stretch Top
Warranty	Klymit Limited Lifetime Warranty
SKU	06KLGRO1E



INFLATABLE SLEEPING PADS WITH PLUSH FOAM TOPPERS FOR UNMATCHED COMFORT



CAR/TENT CAMPING

- Conforms to support the body and eliminate pressure points
- Stretch polyester fabric is soft and quiet
- I-beam air chambers create loft and stabilize the sleeping pad
- Air and foam combination strikes the perfect balance between comfort, pack size, and weight
- Flip valve inflation, compatible with Klymit USB Rechargeable Pump and Rapid Air™ pump
- Patch and stuff sack included
- Patent pending design
- To clean: spot wash with warm water only and hang to dry



THE STATIC SERIES

CATCH SOME VVV'S

Our patented V-Chamber design offers a comfortable night of sleep at an optimized weight and pack size

We've designed our Static™ Series to be comfortable, lightweight, and packable because the last thing you need to worry about on your outdoor adventure is a good night's rest.

Since the inception of the original Static V®, new iterations have been engineered for every body and every adventurer—from the ultralight explorer to the family car camper and everyone in between. It's no wonder the Static V® has earned a loyal following, making Klymit the fastest growing sleeping pad company in the world.



MAIN FEATURES

Raised V-chambers create ultra-comfortable loft pockets that support your body's pressure points from head-to-toe, giving side, back, and stomach sleepers a generous bed of air

Deep welds between air chambers maximize the loft and warmth of your sleeping bag

Dynamic side rails keep you centered on the pad all night long

Support and comfort no matter how you sleep—on your side, stomach, or back

High quality, durable fabrics are soft against the skin, quiet to sleep on, and easily pack down to a small size

Limited lifetime warranty on every pad

Inflation is fast and easy; compatible with Klymit USB Rechargeable Pump and Rapid Air™ pump

SUPPORTIVE BODY MAPPING DIAGRAM

EASY INFLATION
from engineered
air flow

RELIABLE
because of
patented weld
terminations

STAY CENTERED
on your pad
with the help
of side rails

KEEP WARM
with our deep
V-chambers

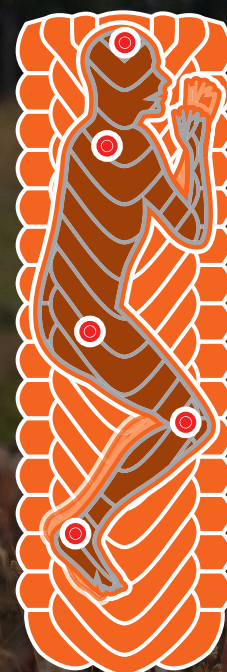
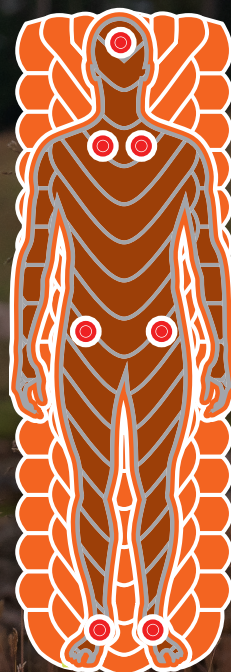
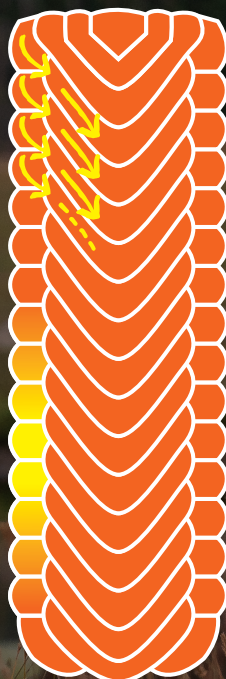

STATIC SERIES™

Comparison Chart



ULTRALITE

Insulated V Ultralite SL



Weight	16 oz / 454 g
Size (in)	72 x 20 x 2.5
Size (cm)	183 x 51 x 6
R-Value	4.4
Pack Size (in)	7 x 4.5
Pack Size (cm)	18 x 11
Color	Orange

LIGHTWEIGHT OVERSIZED

Static V Luxe SL

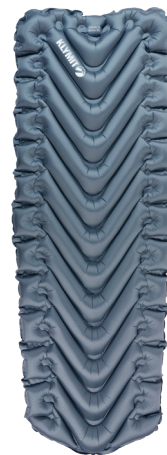

Insulated Static V Luxe SL







Weight	21 oz / 590 g	31.3 oz / 887 g
Size (in)	78 x 27 x 3.5	78 x 27 x 3.5
Size (cm)	198 x 69 x 9	198 x 69 x 9
R-Value	15	6.5
Pack Size (in)	8.5 x 5.5	9 x 7
Pack Size (cm)	22 x 14	23 x 18
Color	Atlantic Deep	Recon

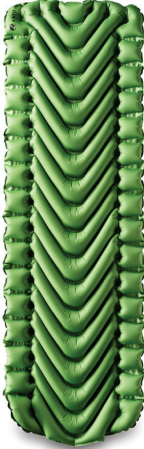

LIGHTWEIGHT

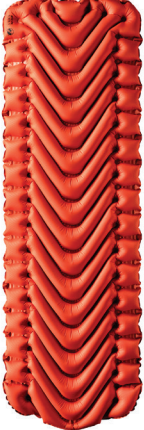
Static V2	Insulated Static V Lite
	
16.6 oz / 470 g	20 oz / 567 g
72 x 23 x 2.5	72 x 23 x 2.5
183 x 58 x 6	183 x 58 x 6
13	4.4
8 x 3	8 x 5
20 x 8	20 x 13
Green	Mango

REGULAR

Static V	Insulated Static V
  	  
18.7 oz / 530 g	24 oz / 680 g
72 x 23 x 2.5	72 x 23 x 2.5
183 x 58 x 6	183 x 58 x 6
13	4.4
8 x 3	8 x 5
20 x 8	20 x 13
Green, Recon, Realtree Edge®	Orange, Recon, Realtree Edge®

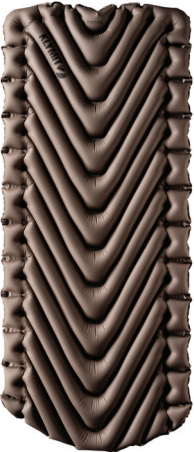
OVERSIZED

Static V Luxe	Insulated Static V Luxe
	
27 oz / 771 g	35 oz / 992 g
76 x 30 x 3	76 x 30 x 3
193 x 76 x 8	193 x 76 x 8
15	5
8 x 4.5	10 x 5
20 x 11	25 x 13
Stone	Red

TWO-PERSON

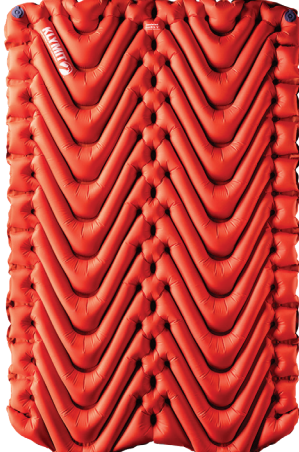
Double V	Insulated Double V
	
43 oz / 1,225 g	53 oz / 1,502 g
74 x 47 x 3	74 x 47 x 3
188 x 119 x 8	188 x 119 x 8
15	4.4
9 x 5	12 x 7
23 x 13	30 x 18
Blue	Orange



BACKPACKING



COLD WEATHER

INSULATED V ULTRALITE SL™

THE MOST CAPABLE PAD FOR CHILLY ULTRALITE ADVENTURES

Weight	16 oz / 454 g
Dimensions	72 x 20 x 2.5 in / 183 x 51 x 6 cm
R-Value	4.4
Pack Size	7 x 4.5 in / 18 x 11 cm
Fabric	20D Polyester
Warranty	Klymit Limited Lifetime Warranty
SKU	06IUOR02C

- Lightest insulated sleeping pad in the Static™ series
- Klymalite™ lofted synthetic insulation creates additional warmth that lasts through the night
- Slightly slimmer than the Insulated Static V™

STATIC V2™

FULL-SIZE PAD THAT WEIGHS ONE POUND

Weight	16.6 oz / 470 g
Dimensions	72 x 23 x 2.5 in / 183 x 58 x 6 cm
R-Value	1.3 ASTM F3340-18
Pack Size	8 x 3 in / 20 x 8 cm
Fabric	30D Polyester Top - 75D Polyester Bottom
Warranty	Klymit Limited Lifetime Warranty
SKU/Color	06S2GR03C

- Same exceptional comfort as the Static V™, in a pad that weighs one pound
- Weight is shed by using lighter fabric on top, while still retaining an ultra-durable underside



BACKPACKING



CAR/TENT CAMPING

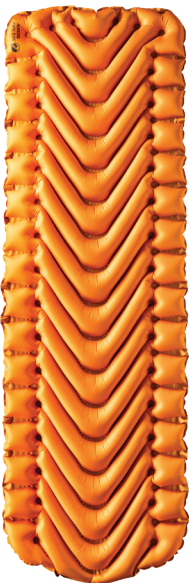
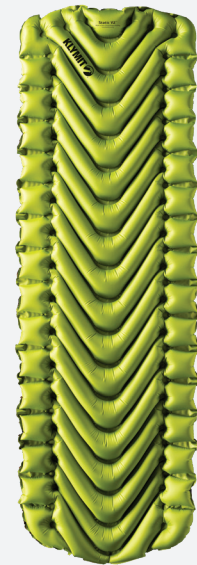

BACKPACKING



CAR/TENT CAMPING



COLD WEATHER

INSULATED STATIC V LITE™

LIGHTWEIGHT V-CHAMBERED PAD FOR WARMTH IN THE COLD

Weight	20 oz / 567 g
Dimensions	72 x 23 x 2.5 in / 183 x 58 x 6 cm
R-Value	4.4
Pack Size	8 x 5 in / 20 x 13 cm
Fabric	30D Polyester
Warranty	Klymit Limited Lifetime Warranty
SKU/Color	06I2OR03C

- A lighter weight version of the Insulated Static V™
- Klymalite™ lofted synthetic insulation creates additional warmth that lasts through the night
- V-Chambers and dynamic side rails limit air movement, helping warmth stay closer to the top of the pad—meaning closer to you

STATIC V SHORT™

A LIGHTER, 3/4-LENGTH VERSION OF THE STATIC V PAD

Weight	14 oz / 383 g
Dimensions	50 x 23 x 2.5 in / 127 x 58 x 6 cm
R-Value	1.3 ASTM F3340-18
Pack Size	8 x 3 in / 20 x 8 cm
Fabric	75D Polyester
Warranty	Klymit Limited Lifetime Warranty
SKU	06SJGR02A

- A 3/4-length version of the Static V™
- Perfect for ounce counters and shorter campers



BACKPACKING



CAR/TENT
CAMPING



BACKPACKING



CAR/TENT
CAMPING

STATIC V™

COMFORTABLE, DURABLE V-CHAMBERED PAD

Weight	18.7 oz / 530 g
Dimensions	72 x 23 x 2.5 in / 183 x 58 x 6 cm
R-Value	1.3 ASTM F3340-18
Pack Size	8 x 3 in / 20 x 8 cm
Fabric	75D Polyester
Warranty	Klymit Limited Lifetime Warranty
SKU	06SVGR02C

- Raised V-Chambers create comfortable loft pockets that support the body's pressure points
- Pad maximizes the loft and warmth of a sleeping bag
- Side rails make it easier to stay on the pad through the night

STATIC V LONG™

TALL, LIGHTWEIGHT, EASY-TO-INFLATE SLEEPING PAD THAT PACKS DOWN SMALL

Weight	22 oz / 623 g
Dimensions	78 x 23 x 2.5 in / 198 x 58 x 6 cm
R-Value	1.3 ASTM F3340-18
Pack Size	8 x 3 in / 20 x 8 cm
Fabric	75D Polyester
Warranty	Klymit Limited Lifetime Warranty
SKU/Color	06SVGR02D

- Designed to comfortably accommodate users up to 6' 6" (198.1 cm)
- Raised V-Chambers maximize loft and warmth, creating comfortable loft pockets that support the body's pressure points
- Side rails make it easier to stay on the pad through the night



BACKPACKING



CAR/TENT
CAMPING



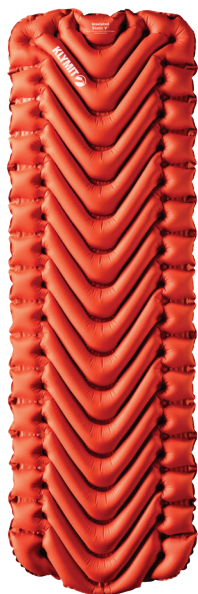

BACKPACKING

CAR/TENT
CAMPINGCOLD
WEATHER

INSULATED STATIC V™

INSULATED PAD FOR EXTRA WARMTH ON COLD NIGHTS

Weight 24 oz / 680 g

Dimensions 72 x 23 x 2.5 in / 183 x 58 x 6 cm

R-Value 4.4

Pack Size 8 x 5 in / 20 x 13 cm

Fabric 75D Polyester

Warranty Klymit Limited Lifetime Warranty

SKU 06IVOR02C

- Klymalite™ lofted synthetic insulation creates additional warmth that lasts through the night
- V-Chambers & dynamic side rails limit air movement, helping warmth stay closer to the top of the pad—meaning closer to you

STATIC V RECON™

THE ORIGINAL STATIC V, SPEC'D IN MILITARY-READY COLOR

Weight 18.7 oz / 530 g

Dimensions 72 x 23 x 2.5 in / 183 x 58 x 6 cm

R-Value 1.3 ASTM F3340-18

Pack Size 8 x 3 in / 20 x 8 cm

Fabric 75D Polyester

Warranty Klymit Limited Lifetime Warranty

SKU/Color 06SVCY02C

- Raised V-Chambers create ultra-comfortable loft pockets that support the body's pressure points
- Pad maximizes the loft and warmth of a sleeping bag
- Side rails make it easier to stay on the pad through the night

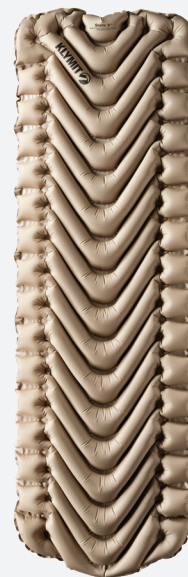

BACKPACKING

CAR/TENT
CAMPING

INSULATED STATIC V RECON™

THE ORIGINAL INSULATED STATIC V, SPEC'D IN MILITARY-READY COLOR

Weight 24 oz / 680 g

Dimensions 72 x 23 x 2.5 in / 183 x 58 x 6 cm

R-Value 4.4

Pack Size 8 x 5 in / 20 x 13 cm

Fabric 75D Polyester

Warranty Klymit Limited Lifetime Warranty

SKU/Color 06IVCY02C

- Insulated version of the Static V Recon™
- Klymalite™ lofted synthetic insulation creates additional warmth that lasts through the night



BACKPACKING

CAR/TENT
CAMPINGCOLD
WEATHER

“Klymit is undeniably an innovator in the sleeping pad space.”

—Active Junky





STATIC V CAMO™ REALTREE EDGE® EDITION

LIGHTWEIGHT, EASY-TO-INFLATE REALTREE EDGE® SLEEPING PAD

Weight	18.7 oz / 530 g
Dimensions	72 x 23 x 2.5 in / 183 x 58 x 6 cm
R-Value	1.3 ASTM F3340-18
Pack Size	8 x 3 in / 20 x 8 cm
Fabric	75D Polyester
Warranty	Klymit Limited Lifetime Warranty
SKU	06SVED02C

- Raised V-Chambers create comfortable loft pockets that support the body's pressure points
- Pad maximizes the loft and warmth of a sleeping bag
- Side rails make it easier to stay on the pad through the night

STATIC V LUXE SL™

EASY-TO-INFLATE, LIGHTWEIGHT, LUXURY SLEEPING PAD

Weight	21 oz / 590 g
Dimensions	78 x 27 x 3.5 in / 198 x 69 x 9 cm
R-Value	1.5
Pack Size	8.5 x 5.5 in / 22 x 14 cm
Fabric	30D Polyester
Warranty	Klymit Limited Lifetime Warranty
SKU	06LLBL02D

- Thickest and tallest pad in the Static™ series
- Slight taper at bottom of pad to trim weight
- Raised V-Chambers maximize loft and warmth, creating comfortable loft pockets that support the body's pressure points
- Side rails make it easier to stay on the pad through the night

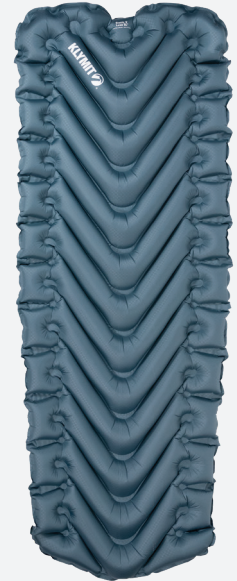

INSULATED STATIC V LUXE SL™

HEAT-RETAINING, LIGHTWEIGHT, LUXURY SLEEPING PAD FOR FOUR-SEASON ADVENTURES

Weight	31 oz / 887 g
Dimensions	78 x 27 x 3.5 in / 198 x 69 x 9 cm
R-Value	6.5
Pack Size	9 x 7 in / 23 x 18 cm
Fabric	30D Polyester
Warranty	Klymit Limited Lifetime Warranty
SKU/Color	06ISCY02D

- Thickest, tallest, and warmest pad in the Static™ series
- Slight taper at bottom of pad to trim weight
- Raised V-Chambers maximize loft and warmth, creating comfortable loft pockets that support the body's pressure points
- Side rails make it easier to stay on the pad through the night

STATIC V LUXE™

THE ULTIMATE V-CHAMBERED PAD FOR PACKABLE LUXURY

Weight	27 oz / 771 g
Dimensions	76 x 30 x 3 in / 193 x 76 x 8 cm
R-Value	1.5
Pack Size	8 x 4.5 in / 20 x 11 cm
Fabric	75D Polyester
Warranty	Klymit Limited Lifetime Warranty
SKU	06VLST02D

- Wider, luxurious version of the Static V™
- Extra-wide pad maximizes loft and warmth of a sleeping bag



CAR/TENT CAMPING



CABIN VACATION

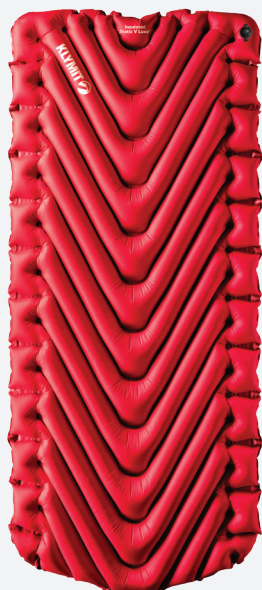

CAR/TENT CAMPING



CABIN VACATION



COLD WEATHER

INSULATED STATIC V LUXE™

THE ULTIMATE INSULATED PAD FOR PACKABLE LUXURY

Weight	32 oz / 992 g
Dimensions	76 x 30 x 3 in / 193 x 76 x 8 cm
R-Value	5
Pack Size	10 x 5 in / 25 x 13 cm
Fabric	75D Polyester
Warranty	Klymit Limited Lifetime Warranty
SKU/Color	06LIRD02D

- Insulated version of the Static V Luxe™
- Klymalite™ lofted synthetic insulation creates additional warmth that lasts through the night
- Extra-wide pad maximizes loft and warmth of a sleeping bag

DOUBLE V™

SIDE-BY-SIDE V-CHAMBERS CREATE THE IDEAL PAD FOR PARTNERS

Weight	43 oz / 1,225 g
Dimensions	74 x 47 x 3 in / 188 x 119 x 8 cm
R-Value	1.5
Pack Size	9 x 5 in / 23 x 13 cm
Fabric	75D Polyester
Warranty	Klymit Limited Lifetime Warranty
SKU/Color	06DVBL02E

- Dual V-Chambers create ultra-comfortable loft pockets for two that support the body's pressure points
- Stuff sack doubles as an inflation pump



COUPLES



CAR/TENT CAMPING



CABIN VACATION

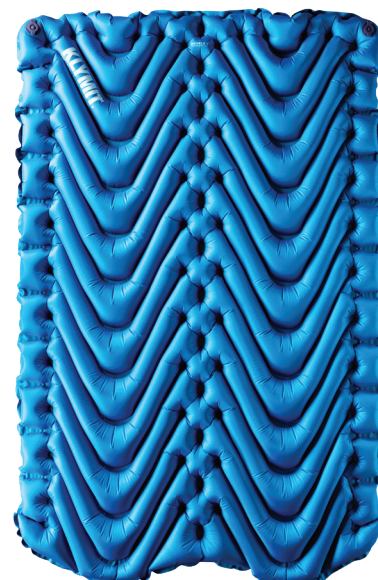

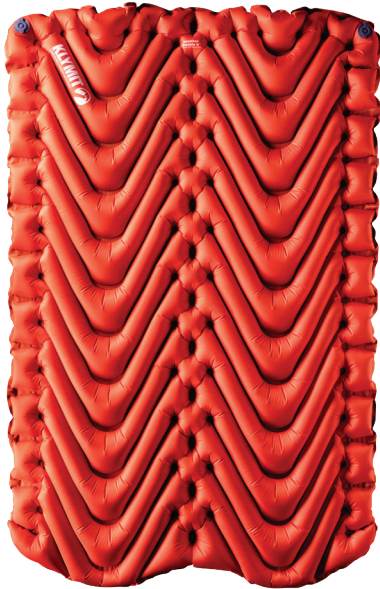

COUPLES



CAR/TENT CAMPING



CABIN VACATION



COLD WEATHER

INSULATED DOUBLE V™

INSULATED PAD WITH ENOUGH ROOM FOR TWO

Weight 53 oz / 1,502 g

Dimensions 74 x 47 x 3 in / 188 x 119 x 8 cm

R-Value 4.4

Pack Size 12 x 7 in / 30 x 18 cm

Fabric 75D Polyester

Warranty Klymit Limited Lifetime Warranty

SKU/Color 06IDOR02E

- Insulated version of the Double V™
- Klymalite™ lofted synthetic insulation creates additional warmth that lasts through the night
- Stuff sack doubles as an inflation pump



HAMMOCK



BACKPACKING



CAR/TENT CAMPING



COLD WEATHER

INSULATED HAMMOCK V™

INSULATED V-CHAMBERED PAD DESIGNED EXCLUSIVELY FOR HAMMOCKS

Weight 36 oz / 1,021 g

Dimensions 78 x 47 x 2.5 in / 198 x 119 x 6 cm

R-Value 4.4

Pack Size 8 x 5.5 in / 20 x 14 cm

Fabric 20D Polyester

Warranty Klymit Limited Lifetime Warranty

SKU 06IHRD02D

- Insulated version of the Hammock V™
- Klymalite™ lofted synthetic insulation creates additional warmth that lasts through the night
- Side wings provide wind protection
- Non-slip zones on top/bottom prevent unwanted movement



ALL-NEW
Horizon
Backpacking
Blanket
pp 12-14



THE INERTIA SERIES

EVERYTHING YOU NEED
AND NOTHING YOU DON'T

Advanced design & engineering for minimalist adventures

Inertia pads are engineered exclusively around features that deliver everything you need and nothing you don't for minimalist backcountry adventures. Each iteration provides support for your head, shoulders, hips, and feet while cutting ounces elsewhere. Unique cutouts in each Inertia pad maximize the loft & warmth of your sleeping bag, similar to our V-Chamber welds in the Static V™ line. The result is an unconventional design **perfect for a light, portable, and comfortable sleep experience.**

MAIN FEATURES

Minimalist Design advanced patterning removes all extraneous material to create an ultralight, minimalist design that delivers comfort and support

High quality, durable fabrics are soft against the skin, quiet to sleep on, and easily pack down to a small size

Body Mapping patterning places air only where padding is needed & eliminates them where they are not, allowing us to shed weight without sacrificing comfort

Inflation is fast and easy

Lifetime warranty on every pad

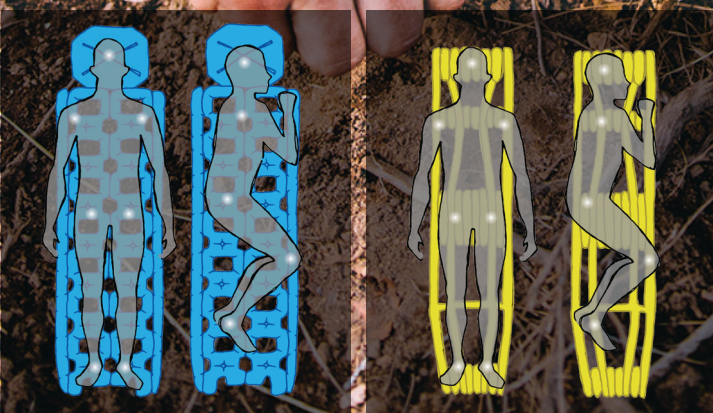

BODY MAPPING

Pressure points where your body is supported by Klymit's Inertia Series



BACKPACKING



TENT CAMPING

INERTIA X LITE™

THE ABSOLUTE LIGHTEST SUPPORT FOR YOUR HEAD, SHOULDERS, AND HIPS

Weight	5 oz / 145 g
Dimensions	42 x 18 x 1.5 in / 107 x 46 x 4 cm
Pack Size	5.5 x 2.5 in / 14 x 6 cm
Fabric	30D Polyester
Warranty	Klymit Limited Lifetime Warranty
SKU/Color	06ILOR02A

- Body Mapping Technology™ provides the support you need at critical pressure points
- Loft pockets maximize the fill and warmth of a sleeping bag
- Packs as small as a banana
- Suitable for three-season conditions

INERTIA X FRAME™

A COMFORTABLE, MINIMALIST PAD THAT FITS INSIDE A SLEEPING BAG

Weight	10 oz / 272 g
Dimensions	72 x 18 x 1.5 in / 183 x 46 x 4 cm
Pack Size	6 x 3 in / 15 x 8 cm
Fabric	30D Polyester
Warranty	Klymit Limited Lifetime Warranty
SKU/Color	06IXRD02A

- Body Mapping Technology™ provides the support you need at critical pressure points
- Packs as small as a soda can
- Loft pockets maximize the fill and warmth of a sleeping bag
- Suitable for three-season conditions



BACKPACKING



TENT CAMPING

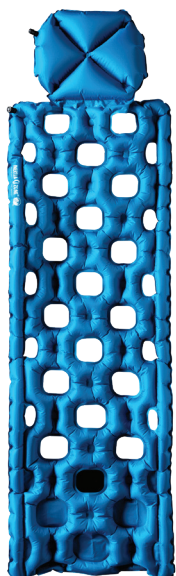
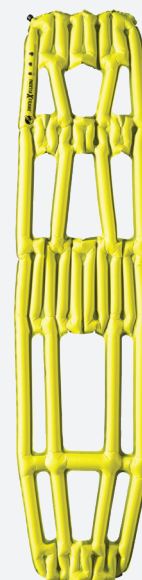

BACKPACKING



TENT CAMPING

INERTIA OZONE™

A COMFORTABLE, MINIMALIST PAD WITH A BUILT-IN, SELF-CENTERING PILLOW

Weight	13 oz / 369 g
Dimensions	72 x 21.5 x 1.75 in / 183 x 55 x 4 cm
Pack Size	6 x 3.5 in / 15 x 9 cm
Fabric	30D Polyester
Warranty	Klymit Limited Lifetime Warranty
SKU/Color	06OZBL02C

- Body Mapping Technology™ provides the support you need at critical pressure points
- Integrated, self-centering Pillow X with separate inflation
- Loft pockets maximize the fill and warmth of a sleeping bag
- Suitable for three-season conditions



THE KSB SERIES

COZY IN AND STRETCH OUT

Engineered with essential features, designed for every body

We engineer every KSB for **optimal thermal performance above all else**, because a bag that keeps you warm throughout the night is one of the most important pieces of gear you'll ever own. 650 fill power down top and synthetic fill bottom provides an exceptional warmth-to-weight ratio, as well as impressive compression ability when it's time to hit the trail. Add to that exclusive features like Length Locks™ that let you adjust your sleeping bag to match your height, as well as an anti-snag two-way zipper, stash pocket, draft collar, stretch baffles, an overstuffed foot box, and oversized options for people who want the space.

MAIN FEATURES

Move freely and stay warmer with flexible elastic stretch baffles that keep warm fill next to your body and stretch when you move or sit up

Customize the length of your bag from 82" to 74" or 67" to eliminate air pockets and maximize warmth with our innovative **Length Locks™**

Exceptional warmth-to-weight ratio comes from down fill top and synthetic fill bottom

Responsibly sourced down

High quality, durable fabrics are soft against the skin

Snag-free YKK zipper

Compression sack included

Water resistant, DWR coated fabric

Two-year warranty on every sleeping bag





KSB 35™

THREE-SEASON DOWN HYBRID MUMMY SLEEPING BAG WITH PLENTY OF ROOM FOR COMFORT

Weight	2.1 lb / 1.0 kg
Temp	35° F / 2° C
Dimensions	82 x 30 in / 208 x 76 cm
Pack Size	12.5 x 6.5 in / 32 x 17 cm
Fill Power	650
Insulation Type	650 Duck Down (Top) / Synthetic (Bot)
Shoulder Girth	58 in / 147 cm
Fabric	20D Nylon
Warranty	Two-Year Warranty
SKU	13KHTL35C

PRODUCT FEATURES:

- 650 fill power down top and synthetic fill bottom provides exceptional warmth-to-weight ratio
- Anti-snap, two-way YKK zipper opens from the bottom or top to easily control the flow of air
- Built-out foot box for plenty of comfort where it's needed most
- Mummy hood with draft collar and draw cord reduces draft
- Packs down small with included compression sack



BACKPACKING



CAR/TENT CAMPING



LG



KSB DOUBLE™

THREE-SEASON DOWN HYBRID SLEEPING BAG WITH PLENTY OF ROOM FOR COMFORT

Weight	5 lb / 2.3 kg
Temp	30° F / -1° C
Dimensions	82 x 46 in / 208 x 117 cm
Pack Size	17.5 x 11.25 in / 45 x 29 cm
Fill Power	650
Insulation Type	650 Duck Down (Top) / Synthetic (Bot)
Girth	90 in / 229 cm
Fabric	20D Nylon
Warranty	Two-Year Warranty
SKU	13DHGY30E



COUPLES

PRODUCT FEATURES:

- 650 fill power down top and synthetic fill bottom provides exceptional warmth-to-weight ratio
- Tall side baffling increases the overall sleeping area of the bag, while still fitting comfortably in a two-person tent
- Individual draft covers let each sleeper control their warmth
- Hood snap eliminates the draft between two sleepers and creates two separate compartments if you prefer a personal hood
- Bag top is removable for a full-size down comforter
- Pad sleeve on the underside of the bag will keep two regular sleeping pads in place and is also compatible with the Klymit Double V™

KSB 0™

FOUR-SEASON DOWN HYBRID MUMMY SLEEPING BAG WITH PLENTY OF ROOM FOR COMFORT

Weight	LG: 3.9 lb / 1.7 kg XL: 4.5 lb / 2.0 kg
Temp	0° F / -18° C
Dimensions	LG: 82 x 30 in / 208 x 76 cm XL: 82 x 40 in / 208 x 102 cm
Pack Size	LG: 16 x 9.5 in / 41 x 24 cm XL: 16.25 x 9.75 in / 41 x 25 cm
Fill Power	650
Insulation Type	650 Duck Down (Top) / Synthetic (Bot)
Shoulder Girth	LG: 58 in / 147 cm XL: 78 in / 198 cm
Fabric	20D Nylon
Warranty	Two-Year Warranty
SKU	LG: 13KHOR00C XL: 13KHOR00D



PRODUCT FEATURES:

- 650 fill power down top and synthetic fill bottom provides exceptional warmth-to-weight ratio
- Anti-s snag, two-way YKK zipper opens from the bottom or top to easily control the flow of air
- Built-out foot box for plenty of comfort where it's needed most
- Mummy hood with draft collar and draw cord reduces draft
- Packs down small with included compression sack
- Stash pocket located inside bag for easy access



KSB 20™

THREE-SEASON DOWN HYBRID MUMMY SLEEPING BAG WITH PLENTY OF ROOM FOR COMFORT

Weight	LG: 3.1 lb / 1.4 kg XL: 3.7 lb / 1.7 kg
Temp	20° F / -7° C
Dimensions	LG: 82 x 30 in / 208 x 76 cm XL: 82 x 40 in / 208 x 102 cm
Pack Size	LG: 14.25 x 9 in / 36 x 23 cm XL: 16.25 x 9.75 in / 41 x 25 cm
Fill Power	650
Insulation Type	650 Duck Down (Top) / Synthetic (Bot)
Shoulder Girth	LG: 58 in / 147 cm XL: 78 in / 198 cm
Fabric	20D Nylon
Warranty	Two-Year Warranty
SKU	LG: 13KHUR20C XL: 13KHUR20D

PRODUCT FEATURES:

- 650 fill power down top and synthetic fill bottom provides exceptional warmth-to-weight ratio
- Anti-s snag, two-way YKK zipper opens from the bottom or top to easily control the flow of air
- Built-out foot box for plenty of comfort where it's needed most
- Mummy hood with draft collar and draw cord reduces draft
- Packs down small with included compression sack
- Stash pocket located inside bag for easy access



THE WILD ASPEN SERIES

GET OUT THERE



WILD ASPEN 20™ LG

THREE-SEASON SYNTHETIC RECTANGULAR SLEEPING BAG WITH PLENTY OF ROOM FOR COMFORT

Weight	4.2 lb / 1.9 kg
Temp	20° F / -7° C
Dimensions	74 x 34 in / 188 x 86 cm
Pack Size	20 x 8.5 in / 51 x 22 cm
Fill Power	650
Insulation Type	120g/m2 Double Layer Thermapro
Shoulder Girth	68 in / 172 cm
Fabric	66D 230T Polyester 90T Brushed Polyester Lining
Warranty	Two-Year Warranty
SKU	13WRGR20D

PRODUCT FEATURES:

- Rectangular design allows plenty of room to stretch out
- Synthetic fill insulation provides an exceptional warmth-to-weight ratio
- Breathable, soft-touch polyester liner
- Reliable, water repellent treated fabric
- Zip together with a second sleeping bag to create room for two
- Packs down small with included compression sack



BACKPACKING



CAR/TENT
CAMPING

WILD ASPEN 0™

FOUR-SEASON SYNTHETIC MUMMY SLEEPING BAG WITH PLENTY OF ROOM FOR COMFORT

Weight	REG: 3.2 lb / 1.5 kg
	LG: 3.7 lb / 1.7 kg
	XL: 4.2 lb / 1.9 kg
Temp	0° F / -18° C
Dimensions	REG: 74 x 30 in / 188 x 76 cm
	LG: 82 x 32 in / 208 x 81 cm
	XL: 82 x 36 in / 208 x 91 cm
Pack Size	REG: 15 x 9 x 9 in / 38 x 23 x 23 cm
	LG: 17 x 9 x 9 in / 43 x 23 x 23 cm
	XL: 17 x 10 x 10 in / 43 x 25 x 25 cm
Insulation Type	180g/m2 Double Layer Thermapro
Shoulder Girth	REG: 56 in / 142 cm
	LG: 60 in / 152 cm
	XL: 68 in / 173 cm
Fabric	Cire Coated 66D 230T Polyester
Warranty	Two-Year Warranty
SKU	REG: 13WAYLOOC
	LG: 13WAYLOOD
	XL: 13WAYLOOE



BACKPACKING



CAR/TENT CAMPING

PRODUCT FEATURES:

- Synthetic fill provides exceptional warmth-to-weight ratio
- Breathable soft touch polyester liner
- Reliable, water repellent treated fabric
- Mummy hood with draw cord closure reduces draft
- Packs down small with included compression sack



BACKPACKING



CAR/TENT CAMPING

PRODUCT FEATURES:

- Synthetic fill provides exceptional warmth-to-weight ratio
- Breathable soft touch polyester liner
- Reliable, water repellent treated fabric
- Mummy hood with draw cord closure reduces draft
- Packs down small with included compression sack

WILD ASPEN 20™

FOUR-SEASON SYNTHETIC MUMMY SLEEPING BAG WITH PLENTY OF ROOM FOR COMFORT

Weight	REG: 2.5 lb / 1.1 kg
	LG: 3.1 lb / 1.4 kg
Temp	20° F / -7° C
Dimensions	REG: 74 x 30 in / 188 x 76 cm
	LG: 82 x 32 in / 208 x 81 cm
Pack Size	REG: 15 x 9 x 9 in / 38 x 23 x 23 cm
	LG: 17 x 9 x 9 in / 43 x 23 x 23 cm
Insulation Type	120g/m2 Double Layer Thermapro
Shoulder Girth	REG: 56 in / 142 cm
	LG: 60 in / 152 cm
Fabric	Cire Coated 66D 230T Polyester
Warranty	Two-Year Warranty
SKU	REG: 13WAGR2OC
	LG: 13WAGR2OD



**Cross Canyon
Tents
pp 54-59**



ALL-NEW
Horizon &
Homestead
Blankets
pp 12-15



DRIFT PILLOW

SLEEP ON IT

Do you miss your pillow when you're traveling?

The Drift Pillow is a versatile, shredded memory foam pillow that strikes the perfect balance between support and comfort. The pillow features a durable, easy-to-clean, water resistant outer shell for travel. **When it's time to go to sleep, the pillow morphs from travel-friendly use to a soft jersey cotton pillowcase.**



MAIN FEATURES

- Versatile pillow easily morphs from travel-friendly use, to a soft, clean sleep surface
- Shredded memory foam strikes the balance between support and comfort
- Durable, easy-to-clean, water resistant outer shell
- Comfortable, jersey cotton inner pillowcase
- Patent pending design
- Shell is removable and machine washable
- Packs down small for easy travel



DRIFT PILLOW™

VERSATILE PILLOW EASILY MORPHS FROM TRAVEL-FRIENDLY USE TO A SOFT, CLEAN SLEEP SURFACE



Fabric Outer Shell: 70D Polyester Ripstop
Inner Shell: 100% Jersey Cotton

Warranty Two-Year Warranty
Fill Shredded Memory Foam



LARGE ORANGE

Weight 28 oz / 785 g
Dimensions 23 x 16 x 6.5 in / 58 x 41 x 17 cm
Pack Size 13.5 x 5 x 7 in / 34 x 13 x 18 cm
SKU 12DROR01D



REGULAR ORANGE

Weight 19 oz / 540 g
Dimensions 18 x 12 x 5.5 in / 46 x 30 x 14 cm
Pack Size 11 x 5 x 5 in / 28 x 13 x 13 cm
SKU 12DROR01C



LARGE GREEN

Weight 28 oz / 785 g
Dimensions 23 x 16 x 6.5 in / 58 x 41 x 17 cm
Pack Size 13.5 x 5 x 7 in / 34 x 13 x 18 cm
SKU 12DRGR01D



REGULAR GREEN

Weight 19 oz / 540 g
Dimensions 18 x 12 x 5.5 in / 46 x 30 x 14 cm
Pack Size 11 x 5 x 5 in / 28 x 13 x 13 cm
SKU 12DRGR01C



INFLATABLE PILLOWS

USE YOUR HEAD

A basic necessity for any comfortable sleep system

When you sleep in your bed at home, a pillow is considered a must. It shouldn't be any different when you're sleeping outside. And no, a rolled-up sweater doesn't count. When your head is properly supported, the natural curve of your neck and your shoulders are supported, too. The result is a more restful sleep so you can enjoy your day outside.

MAIN FEATURES

- X-shaped welds** cradle your head while you sleep
- High quality, durable fabrics** are soft against the skin, quiet to sleep on and easily pack down to a small size
- Small pack size** makes our pillows the perfect accessory to a good night's sleep

PILLOW X™

A SUPPORTIVE, ULTRALIGHT CAMPING PILLOW

Weight	2.5 oz / 71 g
Dimensions	15 x 11 x 3.5 in / 38 x 28 x 9 cm
Inflation	3-5 Breaths
Pack Size	4.5 x 2.5 in / 11 x 6 cm
Fabric	75D Polyester
Warranty	Klymit Limited Lifetime Warranty
SKU	12PXR01C

- Self-centering X design supports your head
- Adjustable height and pressure
- Fits in your pocket



PILLOW X LARGE™

A SOFT TOUCH FABRIC, SUPPORTIVE, INCREDIBLY COMFORTABLE CAMPING PILLOW

Weight	3.2 oz / 91 g
Dimensions	12 x 17 x 4.25 in / 43 x 30 x 11 cm
Inflation	3-5 Breaths
Pack Size	4 x 3 in / 10 x 8 cm
Fabric	75D Polyester
Warranty	Klymit Limited Lifetime Warranty
SKU	12PLT01D

- Self-centering X design supports your head
- Adjustable height and pressure
- Fits in your pocket

LUXE PILLOW™

HYBRID-FILL PILLOW THAT COMBINES THE CUSHIONING OF AIR WITH THE LOFTY SUPPORT OF POLY FILL

Weight	7 oz / 200 g
Dimensions	22 x 12.5 x 5 in / 56 x 32 x 13 cm
Pack Size	7 x 3 in / 18 x 8 cm
Fabric	30D Stretch Polyester with Synthetic Case
Warranty	Klymit Limited Lifetime Warranty
SKU	12LPGY01D

- A large, quilted pillow for those who crave extra comfort
- Removable quilted cover is machine washable
- Adjustable height and pressure





THE CROSS CANYON SERIES

MAKE YOURSELF AT HOME

The Cross Canyon Tent Series is perfect for weekend warriors

Designed to deliver comfortable interior living space with exceptional storage options at a great value. The series features quality materials and premium aluminum poles. Two entry doors and dual overhead ventilation keep the tent cool and condensation free. Easy setup and takedown means you'll spend less time setting up and more time enjoying the outdoors.



MAIN FEATURES

Rectangular freestanding tent design allows for **multiple sleeping configurations**

Innovative patent pending Cross Canyon Mat™ doubles as a roll-style stuff sack and ensures clean work surface for tent set-up and ease of repackaging

Aluminum poles create a robust and lightweight structure

Multi-anchor point front vestibule creates a spacious exterior storage area protected from wind and rain

Use the Cross Canyon™ Footprint, poles, rainfly, and stakes for **fast fly mode** to reduce weight and pack size



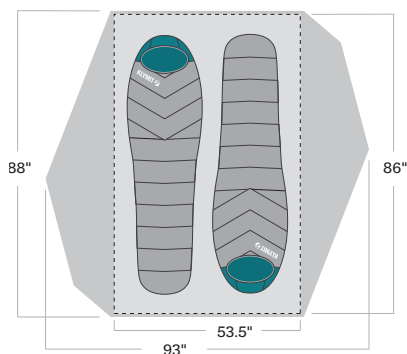

CROSS CANYON 2™

2-PERSON TENT

Sleeping Capacity	2-Person
Seasons	3-Seasons
Packed Weight	6 lb / 2.7 kg
Trail Weight	5.4 lb / 2.4 kg
Fast Fly Weight	4 lb / 1.8 kg
Pack Size	20 x 6.5 in / 51 x 17 cm
Floor Dimensions	86 x 53.5 in / 218 x 135 cm
Peak Height	46 in / 117 cm
Floor Area	31 ft ² / 2.9 m ²
Vestibule Areas	15 ft ² / 1.4 m ² ; (front + back vestibules)
Pole Construction	Cross Pole
Pole Type	Aluminum
Fly Fabric	68D Polyester Taffeta PU 1800mm
Inner Tent Mesh	40D Polyester
Floor Fabric	75D Polyester PU 3000mm
Warranty	Two-Year Warranty
SKU	09C2RD01B

- *Three overhead pockets and two corner pockets* create unrivaled interior storage options



CROSS CANYON 3™

3-PERSON TENT

Sleeping Capacity	3-Person
Seasons	3-Seasons
Packed Weight	7.6 lb / 3.4 kg
Trail Weight	7 lb / 3.2 kg
Fast Fly Weight	5.1 lb / 2.3 kg
Pack Size	20 x 7.5 in / 51 x 18 cm
Floor Dimensions	86 x 75 in / 218 x 191 cm
Peak Height	52 in / 132 cm
Floor Area	44 ft ² / 4.1 m ²
Vestibule Areas	27 ft ² / 2.5 m ² ; (front + back vestibules)
Pole Construction	Cross Pole
Pole Type	Aluminum
Fly Fabric	68D Polyester Taffeta PU 1800mm
Inner Tent Mesh	40D Polyester
Floor Fabric	75D Polyester PU 3000mm
Warranty	Two-Year Warranty
SKU	09C3RD01C



CAR/TENT
CAMPING



BACKPACKING



FAMILY

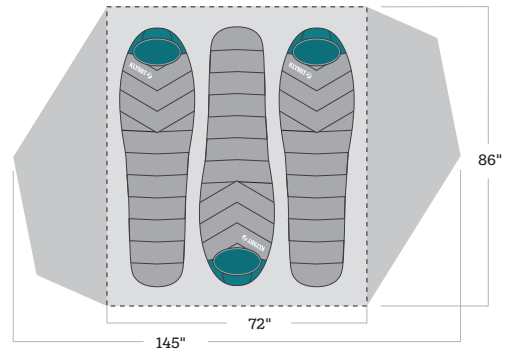

- **Three overhead pockets and two corner pockets** create unrivaled interior storage options



Innovative Cross Canyon Mat™

CROSS CANYON 4™

4-PERSON TENT

Sleeping Capacity	4-Person
Seasons	3-Seasons
Packed Weight	10.7 lb / 4.9 kg
Trail Weight	10 lb / 4.5 kg
Fast Fly Weight	7.5 lb / 3.4 kg
Pack Size	20 x 9.5 in / 51 x 24 cm
Floor Dimensions	100 x 86 in / 254 x 218 cm
Peak Height	65 in / 165 cm
Floor Area	59 ft ² / 5.5 m ²
Vestibule Areas	30 ft ² / 2.8 m ² ; (front + back vestibules)
Pole Construction	Cross Pole
Pole Type	Aluminum
Fly Fabric	68D Polyester Taffeta PU 1800mm
Inner Tent Mesh	40D Polyester
Floor Fabric	75D Polyester PU 3000mm
Warranty	Two-Year Warranty
SKU	O9C4RD01D



CAR/TENT
CAMPING



BACKPACKING



FAMILY

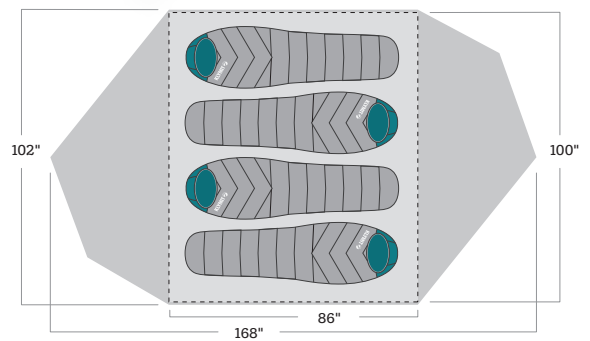

- **Three overhead pockets and four corner pockets** create unrivaled interior storage options





CROSS CANYON 2™

2-PERSON TENT FOOTPRINT

Dimensions	84 x 51.5 in / 213 x 131 cm
Pack Size	9 x 4 in / 23 x 10 cm
Packed Weight	10 oz / 272 g
Fabric	75D Polyester PU 3000mm
Warranty	Two-Year Warranty
SKU	09C2GRFPB

CROSS CANYON 3™

3-PERSON TENT FOOTPRINT

Dimensions	84 x 73 in / 213 x 185 cm
Pack Size	9.5 x 4.5 in / 24 x 11 cm
Packed Weight	13 oz / 369 g
Fabric	75D Polyester PU 3000mm
Warranty	Two-Year Warranty
SKU	09C3GRFPC



CROSS CANYON 4™

4-PERSON TENT FOOTPRINT

Dimensions	98 x 84 in / 249 x 213 cm
Pack Size	10 x 5.5 in / 25 x 14 cm
Packed Weight	16 oz / 454 g
Fabric	75D Polyester PU 3000mm
Warranty	Two-Year Warranty
SKU	09C4GRFPD



Your best night of Sleep Outside™ starts with the Maxfield Tent Series.

The series offers an ultra-lightweight structure without compromise.

Designed to deliver comfortable interior space, revolutionary packability, and intelligently designed storage. Large vestibules

maximize exterior equipment storage, resulting in more usable interior space. Sil-nylon fabrics and premium aluminum hardware deliver maximum strength without sacrificing weight.

MAIN FEATURES

Innovative patent pending Maxfield Mat™ doubles as a roll-style stuff sack and ensures clean work surface for tent set-up and ease of repackaging

Vestibule Space allows a large storage area without blocking front door access

Three-port ventilation optimizes airflow, decreasing condensation

Use the Maxfield™ Footprint, poles, rainfly, and stakes for **fast fly mode** to reduce weight and pack size

THE MAXFIELD SERIES

A HIT ABOVE ITS
WEIGHT CLASS



TENT
CAMPINGULTRALITE
BACKPACKING

COUPLES

- **Multi-point front vestibule** allows a large storage area without blocking front door access
- Three **interior mesh pockets**

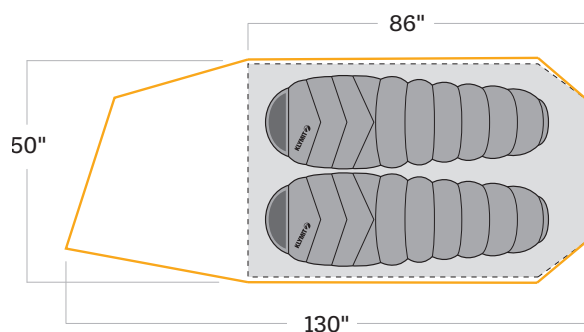

MAXFIELD 2™

2-PERSON TENT FOOTPRINT

Dimensions	83 x 50 in / 211 x 127 cm
Pack Size	9.5 x 4.5 in / 24 x 11 cm
Packed Weight	8 oz / 247 g
Fabric	75D Polyester PU 3000mm
Warranty	Two-Year Warranty
SKU	09C2GRFPB



MAXFIELD 2™

2-PERSON BACKPACKING TENT

Sleeping Capacity	2 Person
Seasons	3-Seasons
Packed Weight	4 lb 3 oz / 1.9 kg
Trail Weight	3 lb 13 oz / 1.7 kg
Fast Fly Weight	3 lb / 1.4 kg
Pack Size	19 x 6 in / 48 x 15 cm
Full Size	86 x 50 x 44 in / 218 x 127 x 112 cm
Peak Height	42 in / 107 cm
Floor Area	29.3 ft ² / 2.72 m ²
Vestibule Area	12.5 ft ² / 1.2 m ²
Poles	Single Chain Pole Structure
Pole Type	Aluminum 7001, Eco Friendly Coating
Fly Fabric	15D Sil/PU Nylon Ripstop 1200mm
Inner Tent Mesh	20D Nylon
Floor Fabric	40D PU Nylon Ripstop 3000mm



MAXFIELD 4™

4-PERSON BACKPACKING TENT

Sleeping Capacity	4 Person
Seasons	3-Seasons
Packed Weight	5 lb 10 oz / 2.5 kg
Trail Weight	5 lb 1 oz / 2.3 kg
Fast Fly Weight	4 lb / 1.8 kg
Pack Size	20 x 6.5 in / 51 x 17 cm
Full Size	86 x 96 x 45 in / 218 x 244 x 114 cm
Peak Height	44.5 in / 113 cm
Floor Area	53 ft ² / 4.9 m ²
Vestibule Area	25.5 ft ² / 2.4 m ² (front & rear combined)
Poles	Single Chain Pole Structure
Pole Type	Aluminum 7001, Eco Friendly Coating
Fly Fabric	15D Sil/PU Nylon Ripstop 1200mm
Inner Tent Mesh	20D Nylon
Floor Fabric	40D PU Nylon Ripstop 3000mm



- **Large vestibules** provide quick access to storage for all of your adventure gear
- **Interior access** to rear vestibule
- Two **interior mesh pockets**

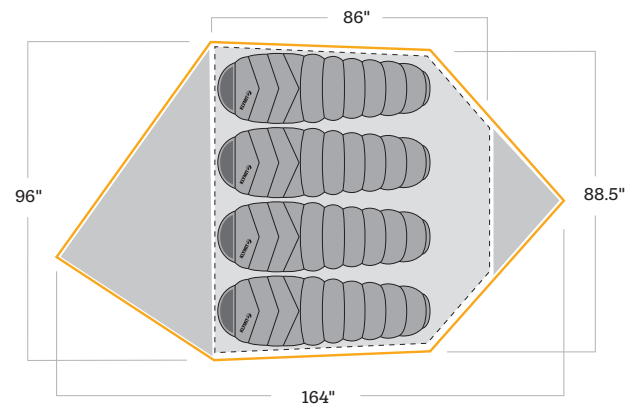

MAXFIELD 4™

4-PERSON TENT FOOTPRINT

Dimensions	95 x 85 in / 241 x 216 cm
Pack Size	9.5 x 5 in / 24 x 13 cm
Packed Weight	17.6 oz / 499 g
Fabric	75D Polyester PU 3000mm
Warranty	Two-Year Warranty
SKU	09C4GRFPD



Innovative Maxfield Mat™





ACCESSORIES

COMPLETE YOUR CAMPSITE

SEATS, BLANKETS,
SHEETS, AND MORE

Engineered with essential features, designed for every body.

At Klymit, we're hard at work trying to enhance your camping experience. Our essentials carry all the same detail-oriented engineering you already expect from Klymit products. From our V Sheets to dog beds, our attention to detail will improve your entire outdoor experience.





VERSA BLANKET™

PACKABLE, MULTI-USE BLANKET FOR ANY ADVENTURE

Weight	21 oz / 590 g
Dimensions	80 x 58 in / 203 x 147 cm
Pack Size	10 x 6 in / 25 x 15 cm
Fabric	20D Ripstop Polyester
Insulation	Synthetic Loft
Warranty	Two-Year Warranty
SKU	13VBOR01C

- Blanket stores easily in footbox, creating the perfect travel pillow
- Sized just right to completely surround one person or be shared with a friend
- Corner snap, shoulder wrap and footbox create the ideal warm weather sleep system

VERSA LUXE BLANKET™

LUXURIOUS, PACKABLE, MULTI-USE BLANKET FOR ANY ADVENTURE

Weight	50 oz / 1,417 g
Dimensions	80 x 58 in / 203 x 147 cm
Pack Size	16 x 8 in / 40 x 20 cm
Fabric	Polyester Ripstop / High Loft Fleece
Insulation	Klymaloft
Warranty	Two-Year Warranty
SKU	13VLBLO1C



- Everything you love about the award-winning Versa Blanket™, now with a technical high-loft fleece inside
- Blanket stores easily in footbox, creating the perfect travel pillow
- Sized just right to completely surround one person or be shared with a friend
- Corner snap, shoulder wrap and footbox create the ideal warm weather sleep system
- The outside soft touch ripstop serves as a barrier for the elements, while the soft fleece keeps you warm and cozy



QUILTED V SHEET™

A WARM WASHABLE, LUXURIOUS FITTED SHEET THAT IS COMPATIBLE WITH ALL REGULAR-SIZED PADS

Weight	14 oz / 408 g
Dimensions	72 x 23 in / 183 x 58 cm
Pack Size	8 x 4.5 in / 20 x 11 cm
Fabric	30D Stretch Polyester
Warranty	Two-Year Warranty
SKU	13ICORSVC

- Machine washable
- Protects your pad from dirt and sweat
- Built-in pocket to keep your pillow in place
- Quilting adds to the R-Value of your pad

V SHEET™

A WASHABLE, LUXURIOUS FITTED SHEET THAT IS COMPATIBLE WITH ALL REGULAR-SIZED PADS

Weight	11 oz / 318 g
Dimensions	72 x 23 in / 183 x 58 cm
Pack Size	8 x 3 in / 20 x 8 cm
Fabric	Polyester / Spandex Blend
Warranty	Two-Year Warranty
SKU	13PCGRSVC

- Machine washable
- Protects your pad from dirt and sweat
- Built-in pocket to keep your pillow in place



V SHEET LUXE™

A WASHABLE, LUXURIOUS, FITTED SHEET COMPATIBLE WITH KLYMIT STATIC V LUXE™ & KLYMALOFT™ XL

Weight	10 oz / 272 g
Dimensions	76 x 30 in / 193 x 76 cm
Pack Size	8 x 3 in / 20 x 8 cm
Fabric	Polyester / Spandex Blend
Warranty	Two-Year Warranty
SKU	13PCGRLXD

- Machine washable
- Protects your pad from dirt and sweat
- Built-in pocket to keep your pillow in place

V SHEET DOUBLE™

A WASHABLE, LUXURIOUS, FITTED SHEET, COMPATIBLE WITH KLYMIT DOUBLE V™ & KLYMALOFT™ DOUBLE

Weight	14 oz / 408 g
Dimensions	74 x 47 in / 188 x 119 cm
Pack Size	8.5 x 4.5 in / 22 x 11 cm
Fabric	Polyester / Spandex Blend
Warranty	Two-Year Warranty
SKU	13PCGRDVE

- Machine washable
- Protects your pad from dirt and sweat
- Built-in pocket to keep your pillow in place





V SEAT™

THE PERFECT SITTING PAD FOR EVERYTHING FROM SPORTS GAMES TO CAMPING

Weight 2.6 oz / 74 g

Dimensions 14.5 x 13.5 x 1.5 in / 37 x 34 x 4 cm

Pack Size 4.5 x 2 in / 11 x 5 cm

Fabric 75D Polyester

Warranty Lifetime Warranty

SKU 12VSBLO1B

- Raised V-Chambers create comfortable loft pockets that support the body's pressure points
- Durable enough for outdoor use yet great for long flights, cold bleachers, or use it in the office for extra padding on your office chair

CUSH SEAT™

VERSATILE, PACKABLE SEAT OR PILLOW FOR EVERYTHING FROM SPORTS GAMES TO CAMPING

Weight 3 oz / 85 g

Dimensions 29 x 9 x 1.5 in / 74 x 23 x 4 cm

Pack Size 5 x 2.5 in / 13 x 6 cm

Warranty Lifetime Warranty

SKU 12CUXX01

- Ultralight inflatable cushion makes any seat more comfortable, from the backcountry to the backyard

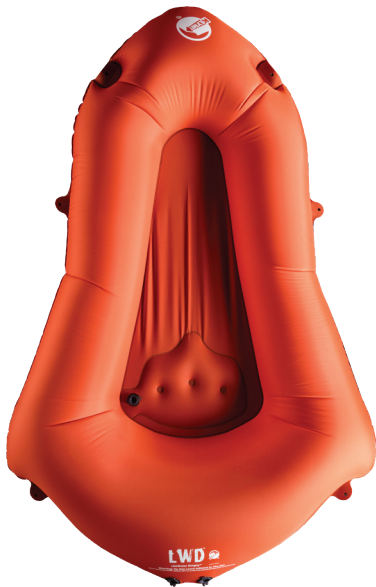
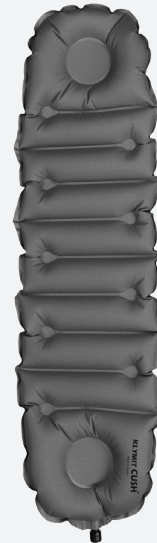

LITEWATER DINGHY™

AN ADVANCED INFLATABLE BOAT FOR CALM WATERS

Weight 44 oz / 1,270 g

Dimensions 76 x 45 x 9.5 in / 193 x 114 x 24 cm

Pack Size 9.5 x 5.75 in / 24 x 15 cm

Raft Rating Class 2: Mild flat water to small waves

Inflation Inflation Stuff Sack/Dry-bag included

Fabric 210D Ripstop

Warranty Two-Year Warranty

SKU 14LDBLO1C

- Six strategically placed tie-off zones provide multiple options for stashing gear or securing the LWD on the shore
- Separate inflatable seat adds comfort
- Pump converts to a compact storage bag to protect the LWD while traveling
- Agile, stable, and comfortable for rafters

MOON DOG BED™ MED

TRAVEL DOG BED WITH MACHINE WASHABLE COVER

Weight	16 oz / 454 g
Dimensions	39 x 32 x 2.5 in / 99 x 81 x 6 cm
Pack Size	8 x 5 in / 20 x 13 cm
Fabric	Pad: 210D polyester; Cover: 30D knit + fleece (top)
Warranty	Klymit Limited Lifetime Warranty
SKU/Color	06MDGY01C

- Ideal for dogs **up to 50 pounds**
- Lightweight and packs down small
- Easy-to-inflate
- Body Mapping Technology™ with a raised side rail
- Removable, polyester fleece cover
- Cover is machine washable

**MOON DOG BED™ LG**

TRAVEL DOG BED WITH MACHINE WASHABLE COVER

Weight	31 oz / 878 g
Dimensions	45 x 30 x 2.5 in / 114 x 76 x 6 cm
Pack Size	11 x 6 in / 28 x 15 cm
Fabric	Pad: 210D polyester; Cover: 30D knit + fleece (top)
Warranty	Klymit Limited Lifetime Warranty
SKU/Color	06MDGY01D

- Ideal for dogs **up to 100 pounds**
- Lightweight and packs down small
- Easy-to-inflate
- Body Mapping Technology™ with a raised side rail
- Removable, polyester fleece cover
- Cover is machine washable





RAPID AIR™ PUMP

AN EFFORTLESS ROLL-TOP PUMP

Weight	3.7 oz / 104 g
Dimensions	57.5 x 9 in / 146 x 23 cm
Pack Size	5 x 1.75 in / 13 x 4 cm
Capacity	18 Liters of air
Fabric	20D Ripstop Nylon
Warranty	Two-Year Warranty
SKU	06RABLTWC (Push-Pull) / 06RAGRNCNC (Flat)

COMPATIBILITY:

- **FLAT VALVE PUMP & PUSH-PULL VALVE PUMP**
- Note: See page 23 for the NEW flip valve Pump Sack
- Note: Please confirm the valve type of your sleeping pad before ordering
- Colors may vary

USB RECHARGEABLE PUMP™

COMPATIBLE WITH KLYMIT VALVES

Weight	5.6 oz / 160 g
Dimensions	3.25 x 2.5 x 2 in / 8 x 6 x 5 cm
Warranty	Two-Year Warranty
SKU	03EPGY01A

- Fast and easy inflation of Klymit sleeping pads
- Rechargeable battery, charging cable included
- Two connectors compatible with Klymit valves included
- 60-minute run time/quick charge time
- Includes pump, micro USB cable, storage bag, nozzle



LARGE STORAGE BAG™

THE PROPER WAY TO STORE AND PROTECT YOUR SLEEPING BAG

Weight	4 oz / 113 g
Dimensions	32 x 19 in / 81 x 48 cm
Pack Size	5 x 3 in / 13 x 8 cm
Warranty	Two-Year Warranty
SKU/Color	13SSGY01D

- Sleeping bags work best when they are clean and uncompressed
- While not in use, the storage bag protects your bag and gives it space to loft, increasing the lifetime of the sleeping bag

PATCH KIT™

AN ESSENTIAL REPAIR TOOL FOR EVERY ADVENTURE

Weight 0.5 oz / 14 g

Dimensions 2.5 x 1.75 in / 6.4 cm x 4.4 cm

SKU 06RKXX01C

- Contains two patches, each measuring 2.5 x 1.5 in (6.4 x 3.8 cm)
- Patches can be cut to size
- Glue tube is small and packable





CAR/TENT
CAMPING



BACKPACKING



GAME
DAY

ROAMER THROW TARP™ (REG)

A SIMPLE, MULTI-PURPOSE TARP THAT CAN BE USED AS A SHELTER OR BLANKET

Weight	8.5 oz / 240 g
Dimensions	78 x 57 in / 198 x 145 cm
Pack Size	8 x 5 in / 20 x 13 cm
Fabric	68D Polyester PU 2000mm
Warranty	Two-Year Warranty
SKU	09RMGY01C

- Multiple tether points enable numerous setup configurations
- Perfect for camping, picnics, festivals, game day, and more
- Waterproof coating will keep you dry and protected

ROAMER THROW TARP™ (LG)

A SIMPLE, MULTI-PURPOSE TARP THAT CAN BE USED AS A SHELTER OR BLANKET

Weight	23.5 oz / 667 g
Dimensions	120 x 120 in / 305 x 305 cm
Pack Size	11 x 7 in / 28 x 18 cm
Fabric	68D Polyester PU 2000mm
Warranty	Two-Year Warranty
SKU	09RMGY01D

- Multiple tether points enable numerous setup configurations
- Perfect for camping, picnics, festivals, game day, and more
- Waterproof coating will keep you dry and protected



CAR/TENT
CAMPING



BACKPACKING



GAME
DAY





HAMMOCKS & SHELTERS

HANG IN THERE





One-of-a-kind designs for a better sleeping experience

Our hammocks and shelters are designed with ultimate comfort and stability in mind. Our products protect you from the sun, rain, wind, and those pesky bugs. Sleeping outside in the trees has never been more comfortable.



TRAVERSE SINGLE HAMMOCK™

VERSATILE, PACKABLE COMFORT FOR ALL OCCASIONS

Weight	28.7 oz / 815 g
Dimensions	110 x 55 in / 280 x 140 cm
Pack Size	8 x 4.5 in / 20 x 11 cm
Fabric	75D Polyester
Capacity	400 lb / 181 kg
Warranty	Two-Year Warranty
SKU	09HSGR01B



CAR/TENT
CAMPING



BACKPACKING

- Single-panel design
- Lightweight and packs down small
- Includes two 10-ft tree straps with multi-point attachment points and two aluminum carabiners
- Innovative construction resists stretching and sagging over time



TRAVERSE DOUBLE HAMMOCK™

VERSATILE, PACKABLE COMFORT FOR ALL OCCASIONS

Weight	30 oz / 862 g
Dimensions	110 x 74 in / 280 x 188 cm
Pack Size	8.5 x 5.5 in / 22 x 14 cm
Fabric	75D Polyester
Capacity	400 lb / 181 kg
Warranty	Two-Year Warranty
SKU	09HMTN01C



CAR/TENT
CAMPING



BACKPACKING

- Single-panel design
- Lightweight and packs down small
- Includes two 10-ft tree straps with multi-point attachment points and two aluminum carabiners
- Innovative construction resists stretching and sagging over time





TRAVERSE BUG NET™

A BUG NET CUSTOMIZED FOR THE TRAVERSE HAMMOCK

Weight	13 oz / 369 g
Length	120 in / 305 cm
Pack Size	8 x 5 in / 20 x 13 cm
Fabric	20D No-see-um Mesh
Warranty	Two-Year Warranty
SKU	09TBGY01C

- Effortless magnetic closure system
- Compatible with all traditional hammocks
- Four tension lock guylines
- Guylines can be used to increase interior space
- Integrates with the Traverse Shelter™
- Lightweight, No-see-um mesh

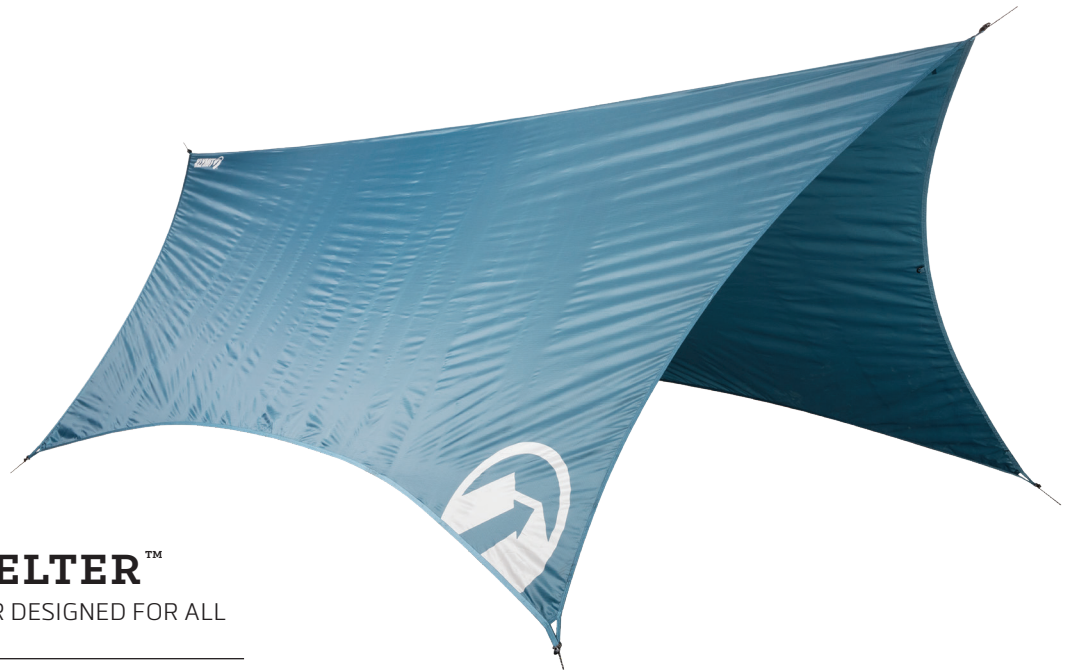

TRAVERSE SHELTER™

VERSATILE, DURABLE SHELTER DESIGNED FOR ALL WEATHER CONDITIONS

Weight	28 oz / 794 g (without stakes)
Dimensions	143 x 110 in / 363 x 279 cm
Fabric	70D Ripstop Polyester 3000mm PU
Warranty	Two-Year Warranty
SKU	09TSBL01D

- Impressive size provides coverage from the elements
- Pack includes four sturdy aluminum stakes
- Six guylines with durable cinch cord locks
- 12 tie-off points
- Durable waterproof fabric with taped seams





BACKPACKS

CARRY ON

Feature-rich packs that make it easier to stay comfortable on the go

Utilizing many of the same engineering principles from our V-Chambered Static V™ line of sleeping pads, we've introduced a whole new category of backpacks: Air Frame™ support. This innovative approach to weight distribution uses pressurized air to direct the load toward your center of gravity while maintaining optimal hip comfort, spine support, and shock absorption. Every Air Frame™ pack also features a hand pump that conveniently stows away and can be used when necessary to fine-tune the air pressure in your frame for truly personalized comfort. Our feature-rich packs are the best way to carry your entire Klymit sleep system.



MAIN FEATURES

Air Frame Technology™

leverages the tech and comfort of our sleeping pads in a pack frame

Full range of motion the technology's inherent flexibility allows the pack to move with your body for exceptional balance and agility

Adjustable pressure

integrated pump allows on-the-fly adjustments to control level of padding, support and flexibility

Ultralight because it uses air, not plastic or aluminum

Two-Year Warranty on every pack

MOTION 60™

ADJUSTABLE MULTIDAY PACK WITH THE SUPPORT AND COMFORT OF AIR FRAME TECHNOLOGY™

Weight	48 oz / 1,306 g
Volume	60 Liters
Waist Size	30-60 in / 80-117 cm
Torso Length	19-23 in / 48-59 cm
Load Rating	75 lb / 24.9 kg
Fabric	600D Polyester / 200D Polyester Ripstop
Warranty	Two-Year Warranty
SKU	12M6BK60D

- Air Frame Technology™ makes it lighter and more comfortable than traditional frame systems
- 60-liter capacity can carry everything you need for your multiday adventure
- Water resistant polyester fabric
- Adjustable torso and waist belt
- Extendable hood with three pockets





MYSTIC 20L™ HYDRATION PACK

LARGE, DURABLE HYDRATION PACK WITH A 3L RESERVOIR

Weight 28 oz / 788 g

Volume 20 Liters

Size 20 x 11 x 6 in

Fabric 300D Polyester Ripstop

Warranty Two-Year Warranty

SKU **GREEN:** 12MYCG20C / **TAN:** 12MYBW20C

- Dedicated rear compartment for 3L hydration bladder
- Hydration bladder's large top opening makes it easy to fill and clean
- Velcro hanging loop keeps bladder upright and secure in your pack
- Quick connect/disconnect bladder hose
- Push/pull lock on bladder hose bite valve to prevent leaks
- Large main compartment for storing gear
- Side accessory pockets perfect for storing your keys and snacks

ECHO 12L™ HYDRATION PACK

DURABLE HYDRATION PACK WITH A 3L RESERVOIR

Weight 23 oz / 663 g

Size 20 x 10 x 4 in

Volume 12 Liters

Fabric 300D Polyester Ripstop

Warranty Two-Year Warranty

SKU **RED:** 12ECDR12B / **DARK GRAY:** 12ECUC12B

- Hardwearing, coated fabric, and welded seams with a roll-top closure all combine to seal out water
- Inflatable Air Frame Technology™ distributes weight evenly
- An integrated hand pump lets you adjust pressure on the fly for maximum comfort
- Hip belt & sternum strap



DAY BAG

A LIGHTWEIGHT PACK FOR THE ULTIMATE IN CONVENIENCE AND COMFORT

Weight 6 oz / 181 g

Volume 20 Liters

Pack Size 5 x 2 in

Fabric Polyester Ripstop

Warranty Two-Year Warranty

SKU 12VDGR01B



- Large main compartment with zipper closure for easy access storage
- Small top pocket for keys, phone, and other small items
- **Inner back panel compatible with Klymit V Seat for added support and comfort**
- Easily folds up into top pocket for compact storage
- Breathable mesh shoulder straps and chest strap
- Lightweight, durable, and water resistant ripstop fabric
- V Seat sold separately

