

# MAGMA

U S A



*The World's Greatest Grills on Land or Sea*



# All New! Completely Redesigned Gourmet II



Mounts & serving shelves sold separately, fuel canisters not included

**"Newport II" Infrared Gas Grill A10-918-2GS**  
Grill area: 162 sq. in. (1045 sq. cm.)  
9 x 18 in. (23 x 46 cm)

**"Catalina II" Infrared Gas Grill A10-1218-2GS (shown)**  
Grill area: 315 sq. in. (2032 sq. cm)  
Primary: 12 x 18 in. (30 x 46 cm)  
Secondary: 5-1/2 x 18 in. (14 x 46 cm)

**"Monterey II" Infrared Gas Grill A10-1225-2GS**  
Grill area: 420 sq. in. (2710 sq. cm)  
Primary: 12 x 24 in. (30 x 61 cm)  
Secondary: 5-1/2 x 24 in. (14 x 61 cm)

Our top of the line Gourmet Series II Infrared Grills are finely crafted and always ready for action. Their beautiful, elegant design, with no sharp edges, glass viewing window, new combustion system, and electronic pulse ignition system is designed to perform in the most difficult windy conditions.

Magma's "Anti-Flare" Infrared technology produces intense, evenly distributed heat and immediately emulsifies drippings giving your meal a great smoky flavor. Constructed in the USA of 100% 18-9 mirror-polished marine grade stainless steel to withstand even the harshest of environments. The primary and secondary grilling surfaces give you the option of searing, slow cooking, or warming. The swiveling control valve/regulator, designed for 1 lb. disposable propane canisters, allows for quick, safe fuel canister exchanges. All Magma gas grills can easily adapt to existing on-board propane (LPG) or natural gas (CNG) fuel systems with one of our optional control valves.



- 1 New Ultra High Temp Glass Viewing Window
- 2 New Completely Redesigned Combustion System  
*Won't blow out in windy conditions*
- 3 New Advanced Electronic Pulse Ignition System  
*Lights first time, every time*
- 4 Infrared Radiant Screens *Intense even heat for searing • reduces flare-ups • eliminates blow outs*
- 5 Stainless Steel Hermetically Sealed Thermometer
- 6 Perfectly Balanced Lockable Lid *Won't slam shut • secures all inner components for transport*
- 7 Full Double Lined Lower Safety Shell *Funnels grease into front access grease tray reducing flare-up & heat discoloration.*
- 8 Sectional Grill Grates *Durable Stainless Steel • fit nicely in sinks or dishwashers*
- 9 Warming Rack/Secondary Grilling Area *For slow grilling or warming (Catalina and Monterey models only)*
- 10 Stainless Steel Dual Element Infrared Radiant Plate *Infrared technology • high even radiant heat • higher heat with less fuel • easy to clean*
- 11 Turbo Burner Design *Durable Stainless Steel • anti-blow-out • high even heat • premixes air and fuel for consistently hot, blue flame*
- 12 Integrated Fold-Away Legs *For on-shore use • completely hidden and out of the way when not in use*
- 13 Front Access, Lock-In-Place Grease Tray
- 14 Swiveling Control Valve/Regulator *Allows quick, safe canister exchanges while grilling*

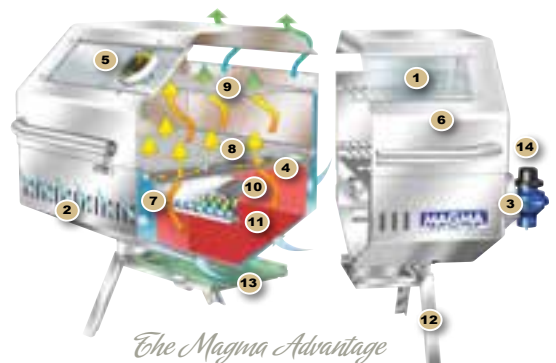

*The Magma Advantage*



## CLASSIC GOURMET SERIES II GRILLS

- **ALL NEW COMPLETELY REDESIGNED COMBUSTION SYSTEM, WON'T BLOW OUT**
- **ALL NEW ADVANCED ELECTRONIC PULSE IGNITION, LIGHTS FIRST TIME EVERYTIME**

Mounts & serving shelves  
sold separately,  
fuel canisters not included



**"Newport II" Gas Grill A10-918-2**  
Grill area: 162 sq. in. (1045 sq. cm.)  
9 x 18 in. (23 x 46 cm)

**"Catalina II" Gas Grill A10-1218-2 (shown)**  
Grill area: 315 sq. in. (2032 sq. cm)  
Primary: 12 x 18 in. (30 x 46 cm)  
Secondary: 5-1/2 x 18 in. (14 x 46 cm)

**"Monterey II" Gas Grill A10-1225-2**  
Grill area: 420 sq. in. (2710 sq. cm)  
Primary: 12 x 24 in. (30 x 61 cm)  
Secondary: 5-1/2 x 24 in. (14 x 61 cm)



- 1 New Completely Redesigned Combustion System**  
*Won't blow out in windy conditions*
- 2 New Advanced Electronic Pulse Ignition System**  
*Lights first time, every time*
- 3 Stainless Steel Hermetically Sealed Thermometer**
- 4 Perfectly Balanced Lockable Lid** *Won't slam shut • secures all inner components for transport*
- 5 Full Double Lined Lower Safety Shell** *Funnels grease into front access grease tray reducing flare-up & heat discoloration.*
- 6 Sectional Grill Grates** *Durable Stainless Steel • fit nicely in sinks or dishwashers*
- 7 Warming Rack/Secondary Grilling Area** *For slow grilling or warming (Catalina and Monterey models only)*
- 8 Stainless Steel Dual Element Infrared Radiant Plate** *Infrared technology • high even radiant heat • higher heat with less fuel • easy to clean*
- 9 Turbo Burner Design** *Durable Stainless Steel • anti-blow-out • high even heat • premixes air and fuel for consistently hot, blue flame*
- 10 Integrated Fold-Away Legs** *For on-shore use • completely hidden and out of the way when not in use*
- 11 Front Access, Lock-In-Place Grease Tray**
- 12 Swiveling Control Valve/Regulator** *Allows quick, safe canister exchanges while grilling*

Your grilling experience will be greatly enhanced with our completely redesigned, finely crafted, and always ready for action Gourmet Series II Classic Grills. Their beautiful, elegant design, with no sharp edges, new combustion system and electronic pulse ignition system is designed to perform in the most difficult windy conditions.

Constructed in the USA of 100% 18-9 mirror-polished marine grade stainless steel to withstand even the harshest of environments. The primary and secondary grilling surfaces give you the option of searing, slow cooking, or warming. The swiveling control valve/regulator, designed for 1 lb. disposable propane canisters, allows for quick, safe fuel canister exchanges. All Magma gas grills can easily adapt to existing on-board propane (LPG) or natural gas (CNG) fuel systems with one of our optional control valves.

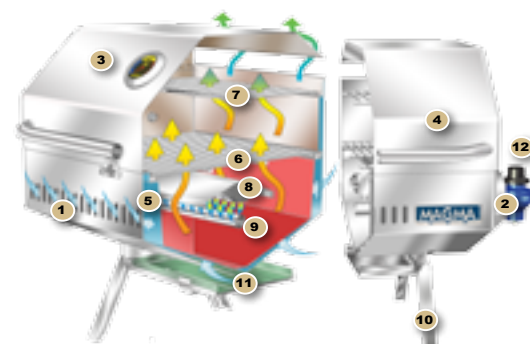

# CONNOISSEUR SERIES GRILLS

- 1 100% 18-9 Mirror Polished Stainless Steel For lasting beauty and superior corrosion resistance.
- 2 Integrated Fold-Away Legs For on-shore use • completely hidden and out of the way when not in use
- 3 Inner Safety Shell Funnels grease into front access grease tray reducing flare-ups and heat discoloration.
- 4 Perfectly Balanced Lockable Lid Won't slam shut • secures all inner components for transport
- 5 Stainless Steel Radiant Plate Convenient removal, allows quick, easy clean-up • creates perfect even heat distribution
- 6 Turbo Burner Design Durable Stainless Steel • anti-blow-out • high even heat • pre-mixes air and fuel for consistently hot, blue flame
- 7 Sectional Grill Grates Durable Stainless Steel • fit nicely in sinks or dishwashers
- 8 Front Access, Lock-In-Place Grease Tray
- 9 Swiveling Control/Valve Regulator Allows quick, safe canister exchanges while grilling

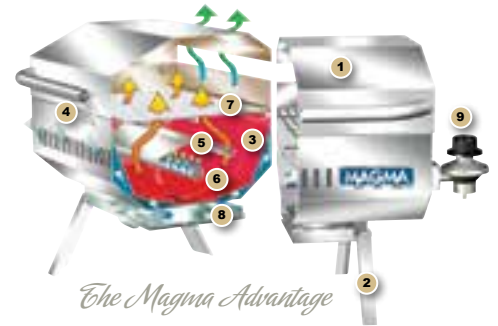

*The Magma Advantage*

Mounts & serving shelves sold separately, fuel canisters not included

- CE CE Approved for use in Europe
- AGA AGA Approved for use in Australia
- NZ NZ Approved for use in New Zealand
- ETL CSA Approved for use in North America

**ChefsMate™ Gas Grill A10-803**  
Grill area: 9 x 18 in. (23 x 46 cm)  
162 sq. in. (1045 sq. cm)

Meticulous attention to even the smallest details creates the finest value grills available. Wind tested for perfect even heat distribution, these grill's offer the cooking performance usually only found in large, back yard grills costing much more. Easily transported, the Fold-Away legs are out of the way on-board, but readily available for that quick picnic on shore. The Snap-out radiant plate provides easy access for clean up yet allows the flame kissed flavor that makes for really memorable meals onboard or ashore. Designed for beauty and performance, you'll find that the Connoisseur Series grills are constructed flawlessly for years of dependable use. The swiveling control valve/regulator, designed to use 1lb. disposable propane fuel canisters, allows for quick, safe fuel canister exchanges or easily adapt grills to existing on-board low pressure propane (LPG) or natural gas (CNG) fuel systems.

**TrailMate™ Gas Grill A10-801**  
Grill area: 9 x 12 in. (23 x 30.5 cm)  
108 sq. in. (697 sq. cm)



Mounts & serving shelves sold separately, fuel canisters not included

- CE CE Approved for use in Europe
- AGA AGA Approved for use in Australia
- NZ NZ Approved for use in New Zealand
- ETL CSA Approved for use in North America



# ADVENTURER MARINE SERIES GRILLS



Mounts & serving shelves sold separately, fuel canisters not included

**Rio™ Gas Grill A10-701** (Below)  
Grill area: 9 x 12 in. (23 x 46 cm) • 108 sq. in (697 sq. cm)

**Cabo™ Gas Grill A10-703** (Above)  
Grill area: 9 x 18 in. (23 x 46 cm) • 162 sq. in (1045 sq. cm)  
A10-703 Cabo Gas Grill - In the USA this product is only available through select retailers

**Cabo™ Electric Grill A10-703E** North America Only  
Grill area: 9 x 18 in. (23 x 46 cm) • 162 sq. in (1045 sq. cm)

**Cabo™ Charcoal Grill A10-703C**  
Grill area: 9 x 18 in. (23 x 46 cm) • 162 sq. in (1045 sq. cm)

Designed for today's boater who doesn't want to substitute quality for cost. The Adventurer Marine Series grills are available in 3 different model options; gas, charcoal, or electric. These grills are manufactured with the same quality you've come to expect from all Magma Products. With their compact design, light weight, large selection of mounts and accessories to customize to your desired application the Adventurer Marine Series grills are truly a go-anywhere grill to enhance all of your outdoor activities. Models use Single Mount (SM) mounting hardware only.

- CE Approved for use in Europe
- AGA Approved for use in Australia
- NZ Approved for use in New Zealand
- CSA Approved for use in North America

- CE Approved for use in Europe
- AGA Approved for use in Australia
- NZ Approved for use in New Zealand
- CSA Approved for use in North America

- 1** 100% 18-9 Mirror Polished Stainless Steel For lasting beauty and superior corrosion resistance
- 2** Fold-Away Legs For on-shore use • completely hidden and out of the way when not in use
- 3** Perfectly Balanced Lockable Lid Won't slam shut • secures all inner components for transport
- 4** Sectional Grill Grates durable Stainless Steel • fit nicely in sinks or dishwashers
- 5** Locking Grease Tray Accessible from either side (gas and electric models)
- 6** Swiveling Control Valve/Regulator Allows quick, safe canister exchanges while grilling (gas model)
- 7** Stainless Steel Radiant Plate convenient removal, allows quick, easy clean-up • creates perfect even heat distribution (gas model)
- 8** Turbo Burner Design Durable Stainless Steel • anti-blow-out • high even heat • premixes air and fuel for consistently hot, blue flame (gas model)
- 9** Variable Snap-In Electrical Control Assembly internal thermometer • electrical requirement: output 120V / 1500W (electric model)
- 10** Dual Draft Door Assemblies Convenient temperature control (charcoal model)
- 11** Lower Charcoal Grill easily removed for clean-up • angled side walls keep briquettes in place (charcoal model)
- 12** Sealed Grill Body Keeps grease and ash contained (Charcoal Model)

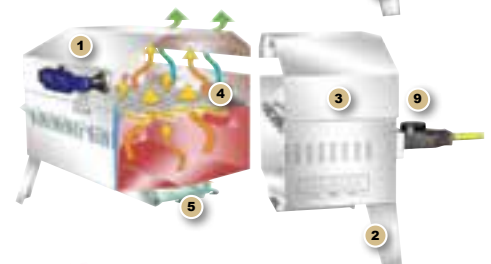
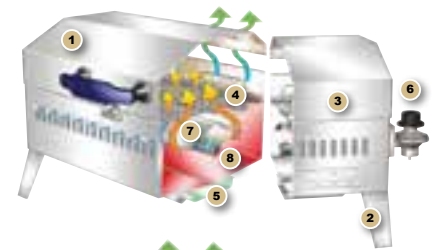

Mounts & serving shelves sold separately, fuel canisters not included



# MARINE KETTLE® 3 GAS GRILLS



## Completely Assembled

Mounts & Fuel Canisters sold separately



Enhance your grilling experience with Magma's new Marine Kettle 3 Combination Stove and Gas Grill. A redesigned version of our Marine Kettle 2, these versatile, portable grills include features that are both useful and user friendly. Incorporated with a new dependable electronic pulse ignition system that lights first time, every time. The mirror polished marine grade stainless steel construction provide superior corrosion resistance, in even the harshest environments, while adding years of life to the grill. Dependable, even in a stiff breeze, due to the virtually blow-out proof turbo venturi tube design, while the patented heat distribution system and burner directs more heat to the cooking surface than any other grill brand. The included swiveling control valve / regulator is designed to connect to 1lb. disposable propane fuel canisters and allows for quick, safe canister exchanges. Or with the purchase of an optional low pressure control valve, easily adapts to any existing on-board LPG (propane) or CNG (natural gas) fuel system. New features combined with Magma's patented radiant plate and dome system, make this the only boat grill that is truly a grill, stove, or oven -- a great advantage to boats without a galley, or if the crew just wants to cook outdoors.



**Patented Hi Tech Radiant Plate & Dome System.**  
Allows use as a grill, stove, or oven. Perfect even heat as a grill or direct open flame cooking as a stove.

**A10-207-3** Original Size  
Diameter 15 in. (38 cm)

**A10-217-3** Party Size (shown)  
Diameter 17 in. (43 cm)

- CE Approved for use in Europe
- AGA Approved for use in Australia
- NZ Approved for use in New Zealand
- CSA Approved for use in North America

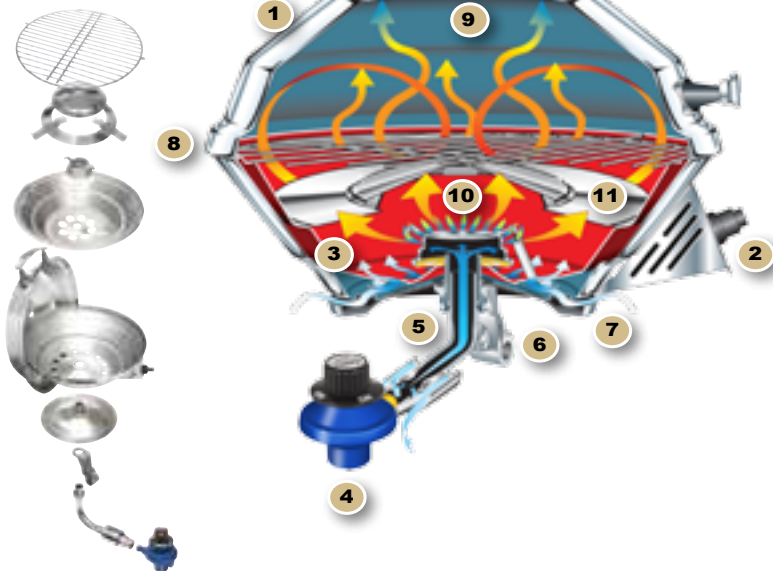

- 1** 100% 18-9 Mirror Polished Stainless Steel  
*For lasting beauty and superior corrosion resistance*
- 2** New Advanced Electronic Pulse Ignition System  
*Lights first time, every time*
- 3** New Redesigned Heavy Duty Inner Safety Shell  
*Durable Stainless Steel • keeps outer shell cooler for safety • guards against discoloration while adding years of life to the grill*
- 4** New Swiveling Control/Valve Regulator  
*Durable, increases grilling performance and allows precise temperature adjustment*
- 5** Windproof Swiveling Turbo Venturi Tube  
*Virtually eliminates blow-outs. Allows for quick, safe fuel changes even with grill in use*
- 6** Cast L-Bracket Mount Assembly  
*Indexed for easier, positive, non-slip level mounting*
- 7** Combination Grease Catch Pan/Wind Baffle  
*Easy to clean • keeps wind gusts out, keeps grease in*
- 8** Balanced Hinged Lid *Won't slam shut*
- 9** Magma's Patented Grill Design  
*Utilizes both radiant and convection cooking • quickly comes to temperature • efficient grilling with minimal fuel usage*
- 10** Heavy Gauge Stainless Steel and Brass Burner Design
- 11** Radiant Burner Plate and Dome Heat Distribution System  
*Time tested hi-tech design • less flare ups • even heat distribution • longer grill life • allows grill to be used as a single burner stove*



**Electronic Pulse Ignition**  
Lights first time every time, waterproof

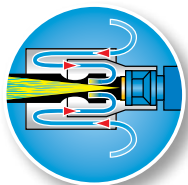

**Patented Windproof Turbo Venturi & Control Valve Design**  
Virtually eliminates blow-outs



**Hinged Lid**  
Balanced lid will not slam shut



**Patented Burner & Heat Distribution Design**  
Less flare up, even heat distribution



**"Stay Cool" Handle with Air Cooled Supports**  
Cast 18-9 Stainless



**Cast 18-9 Stainless L-Bracket & Clamp Assembly**  
Indexed for positive no-slip level mounting



# MARINE KETTLE® GAS GRILLS

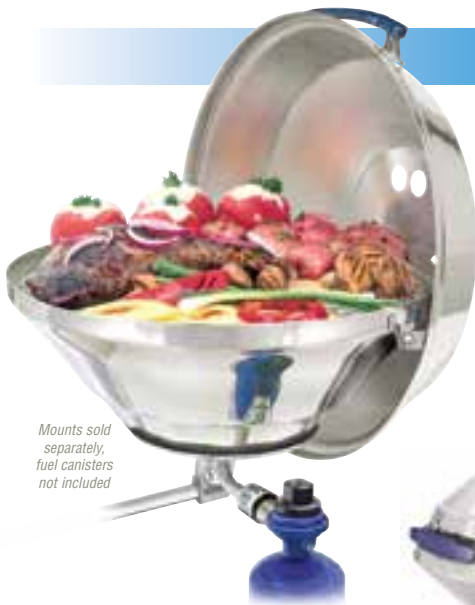

Mounts sold separately, fuel canisters not included

- CE Approved for use in Europe
- AGA Approved for use in Australia
- NZ Approved for use in New Zealand
- CSA Approved for use in North America



Instantly disassembles without tools for easy cleaning.

- 1 100% 18-9 Mirror Polished Stainless Steel** For lasting beauty and superior corrosion resistance
- 2 Balanced Hinged Lid** Won't slam shut
- 3 Windproof Swiveling Turbo Venturi Tube** Durable Stainless Steel • anti-blow-out design • places fuel where it is convenient for you
- 4 Radiant Plate Heat Distribution Design** Less flare ups • even heat distribution • longer grill life
- 5 Combination Grease Catch Pan/Wind Baffle** Easy to clean • keeps wind gusts out, keeps grease in
- 6 Magma's Patented Grill Design** Utilizes both radiant and convection cooking • quickly comes to temperature • efficient grilling with minimal fuel usage
- 7 Heavy Gauge Stainless Steel and Brass Burner Design**
- 8 Swiveling Control/Valve Regulator** Allows quick, safe canister exchanges while grilling

**A10-205 Original Size**  
Diameter 15 in. (38 cm)

**A10-215 Party Size (shown)**  
Diameter 17 in. (43 cm)

Designed for economy without sacrificing functionality. 100% 18-9 mirror polished marine grade stainless steel construction, provides superior corrosion resistance. Using Magma's time tested, high efficient radiant plate heat distribution system in conjunction with convection heating technology to achieve hot, even temperatures very quickly while using a minimum of fuel for searing steaks and fish or just grilling up some burgers or dogs.

Includes a perfectly balanced hinged lid that won't slam shut, with a sturdy heat-resistant cast plastic "Stay Cool" handle. An indexed bowl assembly which enables grill to be rotated allowing lid to be used as a wind shield. The redesigned turbo venturi tube makes it dependable in even a stiff breeze, virtually blow-out proof and a swiveling control valve/regulator, designed to use standard, 1-lb. disposable propane fuel canisters, allows for quick, safe fuel canister exchanges or easily adapts to an existing onboard LPG (propane) or CNG (natural gas) system. These grills quickly disassemble without tools for easy clean up.



*The Magma Advantage*



# MARINE KETTLE® CHARCOAL GRILLS



Mounts sold separately



Instantly disassembles without tools for easy cleaning.

- 1 100% 18-9 Mirror Polished Stainless Steel** For lasting beauty and superior corrosion resistance
- 2 Balanced Hinged Lid** Won't slam shut
- 3 Attached, Rotating Adjustable Cooking Grill**
- 4 Draft Door Assemblies** Convenient temperature control
- 5 Lower Charcoal Grate and Sealed Ash Compartment**
- 6 Indexed Bowl and Lid Design** Before lighting, grill may be rotated placing lid to act as a windshield in gusty wind conditions
- 7 Magma's Patented Grill Design** Utilizes both radiant and convection cooking • quickly comes to temperature • efficient grilling with minimal charcoal usage

**A10-104 Original Size**  
Diameter 15 in. (38 cm)

**A10-114 Party Size (shown)**  
Diameter 17 in. (43 cm)

It is meticulously crafted of 100% 18-9 mirror polished stainless steel for maximum corrosion resistance. Starts easily in windy conditions by using the lid as a windshield. You obtain perfect results through use of the rotating, adjustable height cooking grill and the variable temperature draft control door. Our "Marine Kettle" design allows oven type baking to enhance the grill flavor while retaining the natural juices in the food. It will cook more food faster on less grill area than any other charcoal grill. Safety and efficiency are obtained by closing the temperature draft control door and extinguishing the coals for future use.

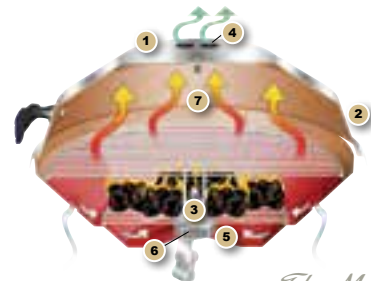

*The Magma Advantage*

# RECTANGULAR GRILL AND TABLE MOUNTS



- ▶ **STANDARD DUTY MOUNT (SD)** Designed for use while anchored or moored. Though strong and versatile, should be stowed while underway.
- ▶ **HEAVY DUTY MOUNT (HD)** Designed specifically for grilling while underway. ▶ **SINGLE MOUNT (SM)** ▶ **DUAL MOUNT (DM)**

## SIDE MOUNTS

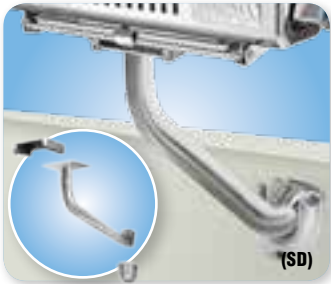

**Vertical Surface Side Mount**  
**T10-344**

Dual locking mount with quick release brackets. Fits all rect. grills & (SM) tables



**Vertical Surface Side Mount with "LevelLock"™**  
**T10-345**

Adjustable all-angle dual locking mount with quick release brackets. Fits all rect. grills & (SM) tables

## PEDESTAL MOUNT

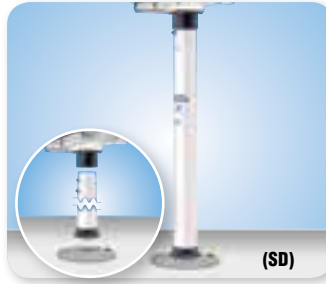

**28 in. (71 cm) Double Locking Stowable Pedestal Mount**  
**T10-185**

Fits all rect. grills & (SM) tables



**"LevelLock"™ Adjustable All-Angle Accessory for Magma Pedestal Mount**  
**T10-192**

Adapts to T10-185 mount for level all-angle adjustment. Fits all rect. grills & (SM) tables

## FISH ROD HOLDER MOUNTS



**"LevelLock"™ All-Angle Fish-Rod Holder Mount**  
**T10-355**

Fits all rect. grills & (SM) tables  
Fits standard fish rod holders



**"Pow'rGrip" LevelLock™ Double Locking Fish Rod Holder Mount**  
**T10-375**

Fits all rect. grills & (SM) tables  
Fits standard fish rod holders

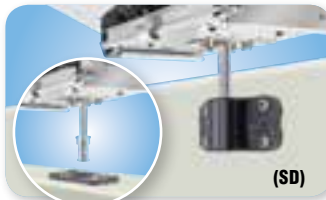

**Socket Type Fish-Rod Holder Mounts**  
**T10-360** Fits Tempress Fish-On® & Roberts Rod Holder Sockets  
Fits 12" x 18" or smaller rect. grills & (SM) Tables  
Rod holder sockets not included.



**Socket Type Fish-Rod Holder Mounts**  
**T10-365** Fits Scotty®/Striker Grip Rod Holder Sockets  
Fits 12" x 18" or smaller rect. grills & (SM) Tables  
Rod holder sockets not included.

## ROUND RAIL MOUNTS



**"Single" Horizontal Round Rail Mount**  
**T10-380** Standard Rails 7/8" or 1" (22 mm or 25.5 mm)  
**T10-385** Oversize Rails 1-1/8" or 1-1/4" (28.5 mm or 32 mm)  
**T10-390** Large Rails 1-1/2" (38 mm)  
Fits 12" x 18" or smaller rect. grills & (SM) Tables



**"Dual" Horizontal Round Rail Mount**  
**T10-580** Standard Rails 7/8" or 1" (22 mm or 25.5 mm)  
**T10-585** Oversize Rails 1-1/8" or 1-1/4" (28.5 mm or 32 mm)  
**T10-590** Large Rails 1-1/2" (38 mm)  
Fits 9" x 18" or smaller rect. grills & (DM) Tables



**"Dual" Extended Horizontal Round Rail Mount**  
**T10-680** Standard Rails 1" (25.5 mm)  
**T10-685** Oversize Rails 1-1/4" (32 mm)  
**T10-690** Large Rails 1-1/2" (38 mm)  
Fits 12" x 18" or smaller rect. grills & (SM) Tables



**Vertical "LevelLock"™ Round Rail Mount**  
**T10-780** Standard Rails 7/8" or 1" (22 mm or 25.5 mm)  
**T10-785** Oversize Rails 1-1/8" or 1-1/4" (28.5 mm or 32 mm)  
**T10-790** Large Rails 1-1/2" (38 mm)  
Fits 12" x 18" or smaller rectangular grills & (SM) tables

## SQUARE RAIL MOUNTS

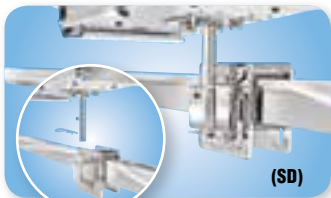

**"Single" Side, Bulkhead or Square/Flat Rail Mount**  
**T10-340**  
Fits 12" x 18" or smaller rect. grills & (SM) Tables



**"Dual" Side, Bulkhead or Square/Flat Rail Mount**  
**T10-540**  
Fits 12" x 18" or smaller rect. grills & (SM) Tables



**Extended "Dual" Side, Bulkhead or Square/Flat Rail Mount**  
**T10-640**  
Fits up to 2-1/4" (57 mm) sq. rail  
Fits 12" x 18" or smaller rect. grills & (SM) Tables

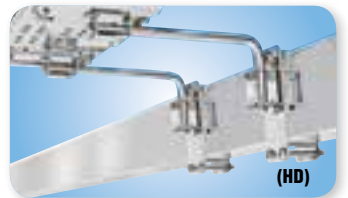

**Extended "Dual" Side, Bulkhead or Square/Flat Rail Mount**  
**T10-641**  
Fits up to 4-1/8" (105 mm) sq. rail  
Fits 12" x 18" or smaller rect. grills & (SM) Tables



## DECK SOCKET MOUNTS



(SD)

"Single" Locking Surface Deck Socket with "LevelLock" Mount  
**T10-322**

Fits 12" x 18" or smaller rect. grills & (SM) Tables

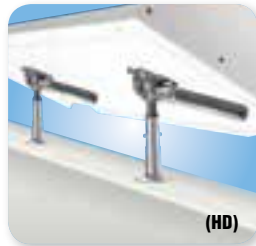

(HD)

"Dual" Locking Surface Deck Socket with "LevelLock" Mount  
**T10-522**

Fits (DM) tables



(SD)

"Single" Locking Flush Deck Socket with "LevelLock" Mount  
**T10-327**

Fits 12" x 18" or smaller rect. grills & (SM) Tables

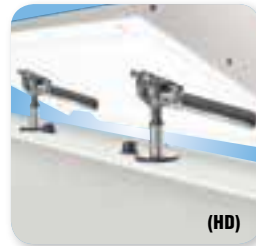

(HD)

"Dual" Locking Flush Deck Socket with "LevelLock" Mount  
**T10-527**

Fits (DM) tables



(SD)

"Single" Locking Flush Deck Socket Mount  
**T10-326**

Fits 12" x 18" or smaller rect. grills & (SM) Tables



(HD)

"Dual" Locking Flush Deck Socket Mount  
**T10-526**

Fits 12" x 18" or smaller rect. grills & (SM) Tables



(SD)

"Single" Locking Surface Deck Socket Mount  
**T10-321**

Fits 12" x 18" or smaller rect. grills & (SM) Tables

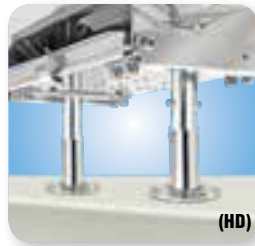

(HD)

"Dual" Locking Surface Deck Socket Mount  
**T10-521**

Fits 12" x 18" or smaller rect. grills & (SM) Tables

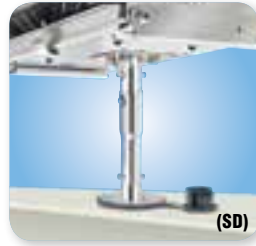

(SD)

"Single" Locking Height Extension Mount  
**T10-316** 6" (15 cm) shown  
**T10-317** 12" (30.5 cm)

Fits 12" x 18" or smaller rect. grills & (SM) Tables



(HD)

"Dual" Locking Height Extension Mount  
**T10-513** 6" (15 cm) shown  
**T10-514** 12" (30.5 cm)

Fits 12" x 18" or smaller rect. grills & (SM) Tables

## MARINE KETTLE MOUNTS



Double Locking "Stowable" Pedestal Mount  
28 in. (71 cm) **A10-184**

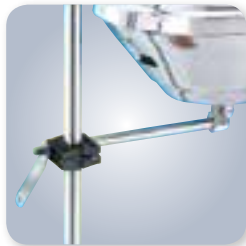

Round Rail Mount

**A10-080** Standard Rails  
7/8" or 1" (22 mm or 25.5 mm)  
**A10-085** Oversize Rails  
1-1/8" or 1-1/4" (28.5 mm or 32 mm)  
**A10-090** Large Rails 1-1/2" (38 mm)



POW'R GRIP™ Fish Rod Holder Mount  
**A10-175**  
Fits standard fish rod holders



Locking Surface Deck Socket Mount  
**A10-121**



Locking Flush Deck Socket Mount  
**A10-126**

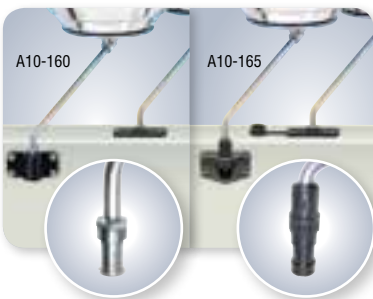

Socket Type Rod Holder Mount  
**A10-160** Fits Tempress Fish-On® & Roberts Rod Holder Sockets  
**A10-165** Fits Scotty®/Striker Grip Rod Holder Sockets  
Rod holder sockets not included.



Side (Bulkhead) or Square/Flat Rail Mount  
**A10-240**  
See website for application details



Marine Kettle Side Mount  
**A10-245**



Mounting Extension  
**A10-140**  
Adds 8" (20 cm)



Folding Shore Stand Table Top Legs  
**A10-650**

# ACCESSORIES

## GRILL COVERS

Our premium covers are made of water and fade resistant Sunbrella®, the finest name in boat cover materials, to resist damage from sunlight and mildew.

- 5 year warranty covers the fabric becoming unserviceable because of loss of color or strength from normal exposure conditions, including sunlight, mildew, rot & atmospheric chemicals.
- 1 year warranty on all other components.

© Sunbrella and Glen Raven are registered Trademarks of Glen Raven Mills, Inc.

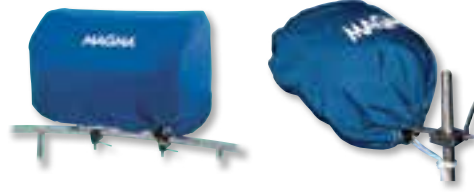

	Forest Green	Pacific Blue	Burgundy	Jet Black	Royal Blue	Captain's Navy
--	--------------	--------------	----------	-----------	------------	----------------

### Marine Kettle Grill Cover & Tote Bag

Original Size	A10-191FG	A10-191PB	A10-191BU	A10-191JB	A10-191RB	A10-191CN
Party Size	A10-492FG	A10-492PB	A10-492BU	A10-492JB	A10-492RB	A10-492CN

### Rectangular Grill Covers

9 x 12 in. Grilling Surface	A10-890FG	A10-890PB	A10-890BU	A10-890JB	A10-890RB	A10-890CN
9 x 18 in. Grilling Surface	A10-990FG	A10-990PB	A10-990BU	A10-990JB	A10-990RB	A10-990CN
12 x 18 in. Grilling Surface	A10-1290FG	A10-1290PB	A10-1290BU	A10-1290JB	A10-1290RB	A10-1290CN
12 x 24 in. Grilling Surface	A10-1291FG	A10-1291PB	A10-1291BU	A10-1291JB	A10-1291RB	A10-1291CN



**Serving Shelf with Removable Cutting Board**

**A10-902**

17-1/4" x 7-1/2" (44 cm x 19 cm)

Fits Magma 9" x 18" or larger grills

**A10-901**

11-1/4" x 7-1/2" (28.5cm x 19 cm)

Fits Magma 9" x 12" or larger grills



**Luggage Quality Padded Grill & Accessory Carrying/Storage Cases for Rectangular Grills**

**A10-992** Fits 9" x 18" Grills (23 cm x 46 cm)

**A10-1292** Fits 12" x 18" Grills (30 cm x 46 cm)

**A10-1293** Fits 12" x 24" Grills (30 cm x 61 cm)



**Luggage Quality Padded Grill & Accessory Carrying/Storage Cases for Kettle Grills**

**A10-991** Fits grills up to 17" in diameter (43 cm)



**LED Grill Light**

**A10-141**

High intensity LED light. Fits all Magma Rectangular & Marine Kettle hinged lid Grills



**"Telescoping" Stainless Grill Tools with Storage Case**

**A10-132T** 5 Piece Set

Individual tools also available



**Reversible "Non-Stick" Griddle**

**A10-195** 8" x 17" (20 cm x 43 cm)

Fits Magma 9" x 18" or larger grills

**A10-197** 11" x 17" (28 cm x 43 cm)

Fits Magma 12" x 18" or larger grills

Non-Stick coated cast aluminum with removable handle



**Reversible "Non-Stick" Griddle**

**A10-196**

11-3/4" diameter (30 cm)

Fits all Magma

Marine Kettle Grills

Non-Stick coated cast aluminum with removable handle



**Fish & Veggie Grill Tray**

**A10-297**

8" x 17" (20 cm x 43 cm)

Fits all Magma 9" x 18" or larger Rectangular grills

18-9 Stainless Steel with removable handle



**Fish & Veggie Grill Tray**

**A10-296** 18-9 Stainless Steel Non-Stick

**A10-295** 18-9 Stainless Steel

13-3/4" diameter (34.93 cm)

Fits all Magma

Marine Kettle Grills



**LED Grill Tool Light**

**A10-144**

High-intensity LED light easily attaches to any Magma Telescoping Grill Tool.



**Magma Magic Grill Restorer**

**A10-272**

Instantly restores the "New" luster to your Stainless Steel Grills. U.S.A. Only



**Gourmet Grilling Apron**

**A10-280JB** Jet Black

**A10-280MR** Magma Red

100% cotton adjustable grilling apron with embroidered Magma logo, 2 pockets, and towel loop



**Gourmet Grilling Towels**

**A10-288-JB** (2 pack)

Large 16" x 22" 100%

Push Terrycloth Cotton

Towels. Stainless Steel

Hanging Eyelet.



**Grill Mitt**

**A10-287JB** Jet Black

100% quilted heat resistant

cotton construction with

embroidered Magma logo &

silicone palm and thumb





**"Marine Cuisine"<sup>™</sup>**  
**Grill Guide & Cookbook**  
**A10-270**  
 130 pages of recipes and  
 tips for portable grilling



**Propane/Butane Canister  
 Storage Locker/Tote Bag**  
**A10-210PB** Pacific Blue  
**A10-210JB** Jet Black  
 Holds up to 3 1 lb. (450 g)  
 propane canisters



**Low Pressure Control Valves  
 (for onboard system)**  
**Propane**  
 Type 3-Low Output LPG  
**Natural Gas**  
 Type 4-Low Output CNG  
 See Website for part numbers  
 and correct product application



**LPG (Propane)  
 Low Pressure Gas  
 Grill Connection Kit**  
**A10-225**  
 North America Only  
 See website for  
 application details



**"Easy Light"<sup>™</sup>**  
**Charcoal Starter**  
**A10-150**  
 Use with any Magma  
 charcoal grill

## SHADE PRODUCTS



18-8 Marine Grade Stainless Steel and 356  
 Anodized Aluminum, Quick Release, All-Angle  
 Round Rail Mount for Horizontal, Vertical or  
 Angled Rails. Easily Adjusts to Any Position.

### BOAT UMBRELLA

- Built-in rugged polyester webbing, four corner tie-down points
- Mount to any angle round rails: 7/8" to 1-1/2" diameter
- Fully adjustable to vertical, horizontal or angled rails
- Matching Carry/Storage case included
- NEW 4 adjustable tie-down lines included
- NEW mount sizes available 1-1/8", 1-1/4" & 1-1/2" (See below)

### REFLECTIVE SILVER 100% UV Blocking, reduces temperature by 20°

- B10-403** STANDARD RAILS 7/8" or 1" (22 mm or 25.5 mm)
- B10-403-2** OVERSIZE RAILS 1-1/8" or 1-1/4" (28.5 mm or 32 mm)
- B10-403-3** LARGE RAILS 1-1/2" (38 mm)

### JET BLACK

- B10-404** STANDARD RAILS 7/8" or 1" (22 mm or 25.5 mm)
- B10-404-2** OVERSIZE RAILS 1-1/8" or 1-1/4" (28.5 mm or 32 mm)
- B10-404-3** LARGE RAILS 1-1/2" (38 mm)

### PACIFIC BLUE

- B10-405** STANDARD RAILS 7/8" or 1" (22 mm or 25.5 mm)
- B10-405-2** OVERSIZE RAILS 1-1/8" or 1-1/4" (28.5 mm or 32 mm)
- B10-405-3** LARGE RAILS 1-1/2" (38 mm)

## BOAT STABILIZER



### The Quietest, Most Effective Anti-Roll Device - Guaranteed

This hinged-wing hydrodynamic stabilizer relies on shape rather than weight, making it more efficient and easier to handle. Attaches to any sailboat boom or spinnaker pole. Or, install our 3-piece telescoping outrigger.

**R10-707** Rock'n'Roll<sup>™</sup> Outrigger System 97" (246.5 cm)

**R10-702** Rock'n'Roll<sup>™</sup> Boat Stabilizer 36" (91.5 cm)



**R10-707**

**R10-702**



# WORLD'S FINEST GOURMET NESTING COOKWARE



**18-10 Stainless Steel Nesting Cookware 10pc Set**

**A10-360L 10 Piece Set**  
**A10-360L-IND 10 Piece Set - Induction**

**10 Piece Sets Include:**

- 5 qt. Stock Pot
- 3 qt. Sauce Pan
- 2 qt. Sauce Pan
- 1½ qt. Sauce Pan
- 10 in. Skillet/Sauté Pan
- Skillet/Stock Pot Lid
- Universal Sauce Pan Lid
- Removable Handle (2)
- Bungee Securing Cord

**7 Piece Sets Include:**

- 5 qt. Stock Pot
- 2 qt. Sauce Pan
- 10 in. Skillet/Sauté Pan
- Skillet/Stock Pot Lid
- Universal Sauce Pan Lid
- Removable Handle (1)
- Bungee Securing Cord

Cookware Sets Available for:



Fully Nesting Gourmet Induction Cookware (12pcs)



"Nests" in Less Than 1/2 Cubic Foot of Space



Optional Padded Cookware Carry Case

## NESTS IN LESS THAN ½ CUBIC FOOT OF SPACE

Magma's Nesting Cookware fully nests and stores in less than ½ Cu. Ft. of space. Each set is oven safe and constructed of 18-10 Stainless Steel with fully sealed Tri-Clad bottoms for perfect even heat distribution. 7 and 10 piece sets are available with Mirror Polished Stainless Steel exteriors or Cobalt Blue, Jet Black or Magma Red enamel finishes, 18-10 Stainless Steel or Ceramica® Non-Stick Interior Surfaces are also available. Magma's nesting cookware is ideal for Gas/Electric/Induction/Halogen/Glass-Ceramic stovetops. Ceramica® Non-Stick interior is non-toxic, Earth Friendly, PFOA and PTFE Free.

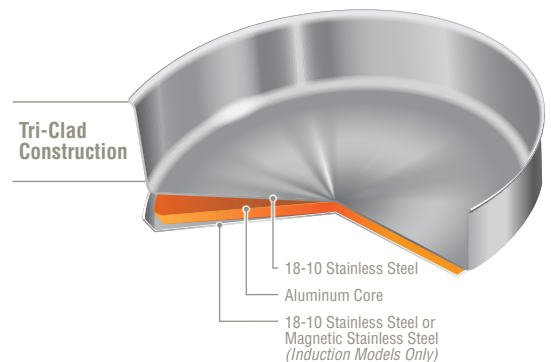



**18-10 Stainless Steel Nesting Cookware 7pc Set**

**A10-362 7-Piece Set**  
**A10-362-IND 7-Piece Set - Induction**



**18-10 Stainless Nesting Cookware with Ceramica® Non-Stick 7Pc Set**

**A10-363-2 7 Piece Set**  
**A10-363-2-IND 7 Piece Set - Induction**



**18-10 Stainless Nesting Cookware with Ceramica® Non-Stick 10pc Set**

**A10-366-2 10 Piece Set**  
**A10-366-2-IND 10 Piece Set - Induction**



**18-10 Stainless Nesting Cookware with Ceramica® Non-Stick 10pc Set Cobalt Blue Enamel Finish**

**A10-366-CB-2 10 Piece Set**  
**A10-366-CB-2-IN 10 Piece Set - Induction**



**18-10 Stainless Nesting Cookware with Ceramica® Non-Stick 10pc Set Magma Red Enamel Finish**

**A10-366-MR-2-IN 10 Piece Set - Induction**



**18-10 Stainless Nesting Cookware with Ceramica® Non-Stick 10pc Set Jet Black Enamel Finish**

**A10-366-JB-2-IN 10 Piece Set - Induction**



**COOKWARE ACCESSORIES**



**18-10 Stainless Steel "Nesting" Sauté/Omelette Pan with Ceramica® Non-Stick Interior** Dia. 9-3/4 in. (24.8 cm)  
**A10-369-2**  
**A10-369-2-IND - Induction**

**A10-367 18-10 Stainless Steel "Nesting" Colander**  
 Dia. 10-1/4 in. (26 cm)



**A10-364 Padded Cookware Carry Case**  
 Fits 12 pieces or more all nested inside 1/2 cubic foot

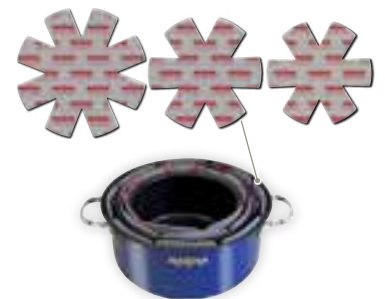

**A10-368 No-Skid Pot Protectors Set of (3)**  
 Nests inside **all** Magma Cookware Sets

# BOAT MOUNTED KAYAK/SUP RACKS



## 14"(35.6 cm) Removable Rail Mounted Kayak/SUP Rack **R10-626** 20"(50.8 cm) Removable Rail Mounted Kayak/SUP Rack **R10-626-20**

- 100% 18-8 Marine Stainless Steel for Superior Corrosion Resistance
- Fits all Straight or Tapered, Vertical or Diagonal Rails 7/8" (22 mm) to 1-1/2" (38 mm)
- Instantly Folds Flat, Out of the Way, or Completely Removes Without Tools
- Includes 2 Arms, Each with 2 Clamps, 2 Tie-Down Loops and UV Resistant Polyethylene Pad



Rotates out for use



Instantly folds flat when not in use



Fits all standard size kayaks



## Fish Rod Holder Mounted Kayak/SUP Rack **R10-625**

- 100% 18-8 Marine Stainless Steel and 356 Hard Anodized Aluminum for Superior Corrosion Resistance
- Instantly Locks into Any Angle Standard Fish Rod Holder with Magma's "Pow'rGrip"™ Technology.
- Magma's "Levelock"™ Adjusts to Fit Any Direction or Angle of Rod Holder without Tools
- Includes 2 Arms, with 4 Tie-Down Loops, Rod Holder Mounts and UV Resistant Polyethylene Foam Pads



Fits all standard fish rod holders



Fits all standard size kayaks



Holds kayaks or multiple SUPs



Fits all Standard Fish Rod Holders





# KAYAK/SUP RACKS



- Basic Upright Rack Systems are 100% 304 Marine Grade, Mirror Polished Stainless Steel
- Adjustment holes every 2 inches to maximize storage
- Stainless Steel Assembly and Mounting Fasteners included
- Include Stainless Steel tie-down end loops and UV resistant Polyethylene foam pads
- Uprights are Super-Strong, 1-1/2" dia. Double Thick .098 wall Stainless Steel (Wall Mounted Rack is 1-1/2" .049 wall)
- Uprights now come with Full length welded support/security lock rails

## Floor/Dock Basic Upright Rack System R10-1001

- Includes two 64" (162.5 cm) uprights and two 30" (76 cm) straight base support arms with UV resistant foam pads



Optional Straight or SUP Arms Required. See Below

## Two-Sided Dock/Floor Basic Upright Rack System R10-1002-64

- Includes two 64" (162.5 cm) uprights and four 30" (76 cm) straight base support arms with UV resistant foam pads



Optional Straight or SUP Arms Required. See Below

## Over the Water Basic Upright Rack System R10-1003-64

- Convenient Kayak/SUP storage without using valuable dock space
- Two 64" (162.5 cm) uprights with base support arms include UV resistant foam pads



Optional Straight or SUP Arms Required. See Below



## Wall Mounted Basic Upright Rack System R10-1004-59

- For garages, boat houses, indoors, or outdoors
- Unique design allows rack to fold flat when not in use
- Four wall mounted brackets & two 59" (150 cm) uprights

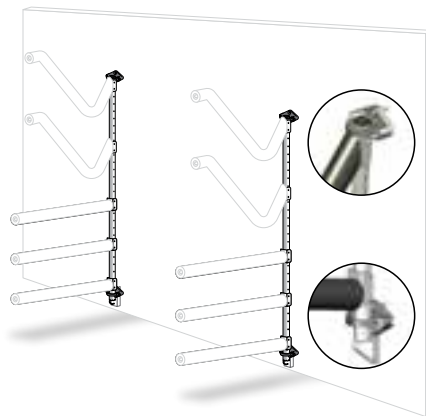

Optional Straight or SUP Arms Sold Separately. See Below

## UNIVERSAL RACK ARMS FOR RACK SYSTEMS

### 30"(76.2 cm) Straight Kayak Arms R10-1010-30

### 36"(91.4 cm) Straight Kayak Arms R10-1010-36

- Available in 30"(76.2 cm) or 36" (91.4 cm) straight arms for Kayaks or water toys
- Fits any Magma Kayak/SUP rack system
- Include pre-installed Polyethylene foam pads and attachment fasteners
- Tie-down end loops ensures your gear is secure



Adjusts every 2 inches for maximum storage efficiency

### SUP Arms R10-1020

- 1" dia. SUP arms; excellent for all water sports boards
- Stainless steel fasteners included
- Arms include UV resistant polyethylene foam pads with stainless steel tie-down points

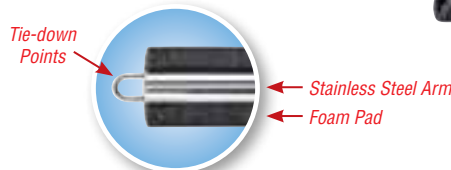

## BAIT / FILET TABLES



- 100% UV Stabilized Compression Molded High Density Color Core Polyethylene Material
- Knife and Pliers Slots
- Grooved Sides and Slotted Table Back for Overboard Drainage
- Largest Selection of Mounting Options Available

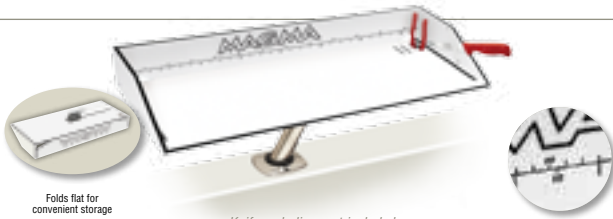

Folds flat for convenient storage

Knife and pliers not included



Knife and pliers not included

### Bait/Filet Mate™ Tables

- Choose either table only and select the appropriate mounting option from our wide section of single mounts (pages 8-9) or table including our "LevelLock" all-angle fully adjustable fish rod holder mount.

### Table Only

- T10-302B** 12-3/4" x 20" (32.5 cm x 51 cm)
- T10-303B** 12-1/2" x 31" (32 cm x 79 cm)

### Table with Mount

- T10-312B** 12-3/4" x 20" (32.5 cm x 51 cm)
- T10-313B** 12-1/2" x 31" (32 cm x 79 cm)



### Econo Mate Bait & Filet Tables

- Includes all necessary mounting hardware

- T10-310B** 20" x 16" (51 cm x 41 cm)
- T10-311B** 12" x 16" (31 cm x 41 cm)

### "First Mate™ Dual Mount" Cutting and Food Service Table

- Choose from a wide selection of dual mount options (page 8-9)

- T10-503B** 12-1/2" x 31" (32 cm x 79 cm)
- T10-504B** 12-1/2" x 41" (32 cm x 104 cm)
- T10-505B** 12-1/2" x 51" (32 cm x 130 cm)

## TOURNAMENT SERIES CLEANING STATIONS



- 100% UV Stabilized High Density Color Core Polyethylene Material
- Engraved Ruler
- (4) Knife and (2) Pliers Slots
- Available in 34" or 48"
- Largest Selection of Mounting Options Available



Folds flat for storage

Tools, Accessories and Side Station not included.

### Cleaning Station Only

- T10-434B-HDP** 34" x 16" (86 cm x 41 cm)
- T10-448B-HDP** 48" x 20" (122 cm x 51 cm)

### Dock Cleaning Station with Mount

- T10-449B-HDP** 48" x 20" (122 cm x 51 cm)
- Dock cleaning station includes : Stainless Steel 1-1/2" Diameter Railing
- (3) Round rail mounting brackets with securing knobs

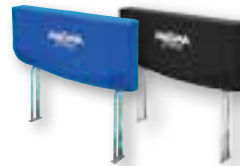

### Covers for 48" (122 cm) Dock Cleaning Station

- T10-471JB** Jet Black
- T10-471PB** Pacific Blue
- Breathable Acrylic material with a 5 year warranty against fade and mildew.

## TABLE ACCESSORY



### Side Station T10-485

- Includes a hose holder; drink holder; and slots for extra pliers, hook extractors, or filet knives. Fits all Tournament Series Cleaning Stations.

- 100% Injection Molded Polyethylene Material
- Slotted Table Back for Overboard Drainage
- Molded Ruler
- (6) Knife and (2) Pliers Slots
- Choose either table only and select the appropriate mounting option from our wide section of mounts (pages 8-9) or table including our "LevelLock" all-angle fully adjustable fish rod holder mount.



Knife and pliers not included

### Cleaning Station Only

- T10-420** 20" x 16" (51 cm x 41 cm)

### Cleaning Station with Mount

- T10-421** 20" x 16" (51 cm x 41 cm)