

T10-302B

Contents

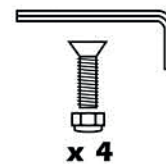

For Mounting Options

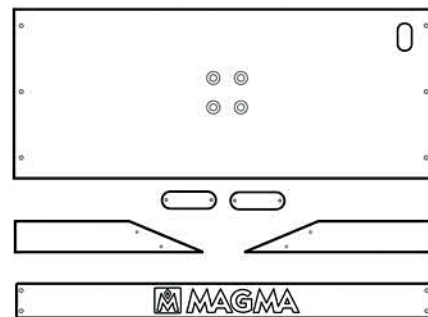
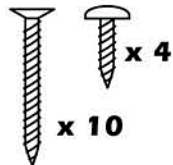
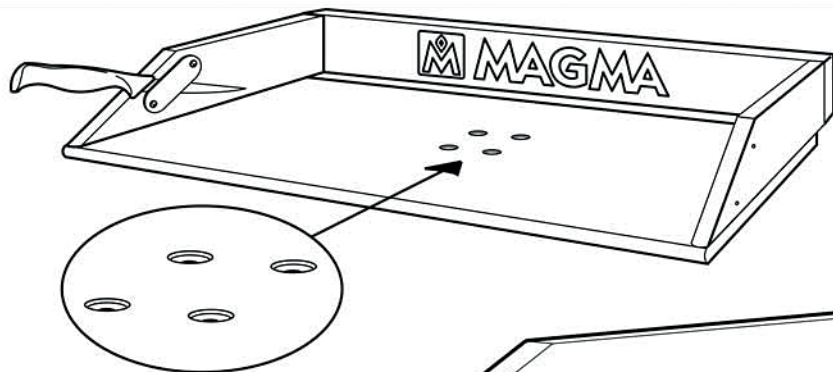

1

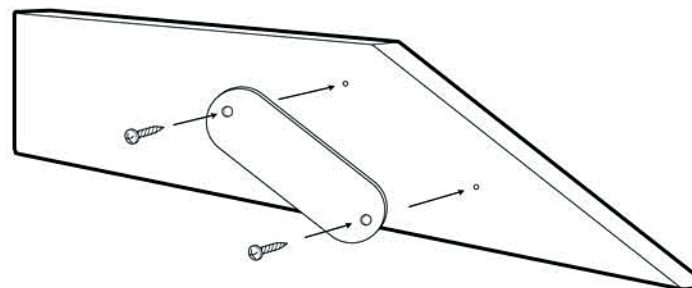

▪ Clean with soap and water, use no solvents.

2

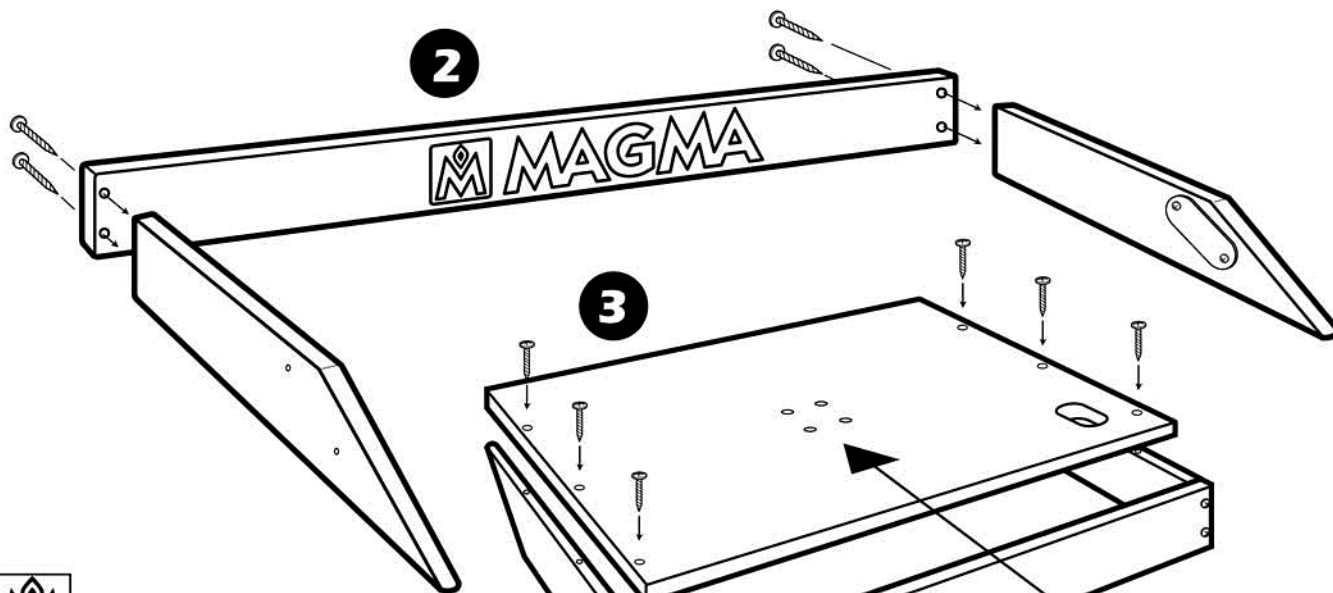

3

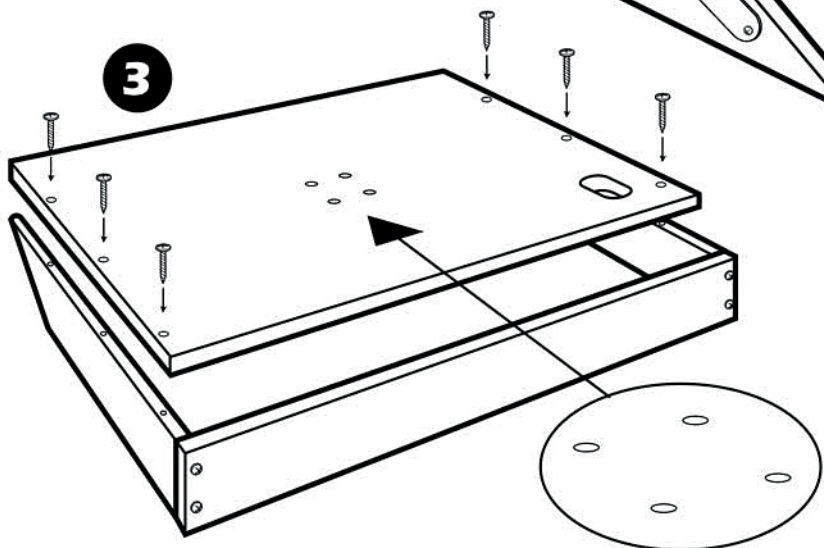

▪ For level table adjustment, see instruction sheet included with mounting hardware. Requires Single-Mount "SM" table mount for complete installation (not included).

