

MASTERVOLT

MANUAL

Mass Charger

**MASS 12/60-2 MB; 12/80-2 MB; 24/50-2 MB;
24/75 MB; 24/100 MB; 3-24/100 MB; 48/25 MB; 48/50 MB**

FULL AUTOMATIC BATTERY CHARGER



TABLE OF CONTENTS:

v 2.3 February 2014

1	GENERAL INFORMATION	4
1.1	Use of this manual.....	4
1.2	Validity of this manual.....	4
1.3	Use of pictograms.....	4
1.4	Identification label.....	4
1.5	Liability.....	4
2	IMPORTANT SAFETY INSTRUCTIONS	5
2.1	General.....	5
2.2	Explosive gases.....	5
2.3	Warnings regarding the use of batteries.....	6
2.4	Warning regarding life support applications.....	6
2.5	Guarantee specifications.....	6
3	OPERATION	7
3.1	Introduction.....	7
3.1.1	Switching on.....	7
3.1.2	Switching off:.....	7
3.2	Theory of operation.....	7
3.3	Front panel.....	7
3.3.1	Bulk (LED 1 illuminates).....	8
3.3.2	(LED 1 and 2 illuminate).....	8
3.3.3	Absorption (LED 1, 2 and 3 illuminate).....	8
3.3.4	(LED 1 to 4 illuminate).....	8
3.3.5	Float (LED 1 to 5 illuminate).....	8
3.4	Temperature compensated charging.....	8
3.5	Compensation of the cable losses.....	8
3.6	Alarm function.....	8
3.7	Charging a second battery.....	8
3.8	Equalize mode.....	8
4	INSTALLATION	9
4.1	Installation environment.....	9
4.2	Connections.....	9
4.3	Wiring.....	9
4.3.1	AC wiring.....	9
4.3.2	AC safety grounding.....	10
4.3.3	DC wiring.....	10
4.4	Battery capacity.....	10
4.5	Battery isolator.....	10
4.6	Connection of second battery (3A output).....	11
4.7	Temperature sensor.....	11
4.8	Voltage sense.....	11
4.9	Alarm function.....	11
4.9.1	Standard alarm mode.....	11
4.9.2	DC alarm mode.....	11
4.10	Connection of accessories.....	11
4.11	RJ12 splitter for enclosure C2.....	11
4.12	Overview connection compartment.....	12
4.13	Things you need.....	12
4.14	Connection.....	13
4.15	Installation step-by-step.....	14

4.16	Commissioning after installation.....	15
4.16.1	General.....	15
4.16.2	MasterBus (optional).....	15
4.17	Decommissioning.....	15
4.18	Storage and transportation.....	15
4.19	Re-installation.....	15
5	DIP SWITCH SETTINGS.....	16
5.1	DIP Switch operation.....	16
5.2	DIP switch functions.....	16
5.2.1	Force Float (DIP switch 1).....	16
5.2.2	Traction setting (DIP switch 2).....	16
5.2.3	Gel/AGM batteries (DIP switch 3).....	16
5.2.4	Diode setting (DIP switch 4).....	16
6	MASTERBUS.....	17
6.1	What is MasterBus?.....	17
6.2	How to set up a MasterBus network.....	17
7	MASTERBUS SETTINGS.....	18
7.1	Device.....	18
7.2	Presets.....	18
7.3	General.....	18
7.4	Bulk.....	18
7.5	Absorption.....	18
7.6	Float.....	19
7.7	Alarm setpoints.....	19
7.8	Traction settings.....	19
7.9	Nicad settings.....	19
7.10	MLi settings.....	19
7.11	Events.....	20
7.11.1	Mass Charger event source list (Mass Charger as event source).....	20
7.11.2	Mass Charger event target list (Mass Charger as event target).....	20
8	TROUBLE SHOOTING.....	21
8.1	Fault finding table.....	21
9	TECHNICAL DATA.....	22
9.1	Specifications.....	22
9.2	Dimensions.....	24
9.3	Characteristics (230 V AC).....	26
10	ORDERING INFORMATION.....	27
11	EC DECLARATION OF CONFORMITY.....	28

1 GENERAL INFORMATION

1.1 USE OF THIS MANUAL

Copyright © 2014 Mastervolt. All rights reserved.
 Reproduction, transfer, distribution or storage of part or all of the contents in this document in any form without the prior written permission of Mastervolt is prohibited.

This manual contains important safety and operating instructions for the safe and effective operation, maintenance and possible correction of minor malfunctions of the Mass Charger.

It is therefore obligatory that every person who works on or with the Mass Charger is completely familiar with the contents of this manual, and that he/she carefully follows the instructions and important safety instructions contained herein.

1.2 VALIDITY OF THIS MANUAL

All of the specifications, provisions and instructions contained in this manual apply solely to standard versions of the Mass Charger delivered by Mastervolt. This manual is valid for the following models:

Part no	Model
40010606	Mass 12/60-2 230V/50-60Hz charger MB
40010806	Mass 12/80-2 230V/50-60Hz charger MB
40020506	Mass 24/50-2 230V/50-60Hz charger MB
40020756	Mass 24/75 230V/50-60Hz charger MB
40021006	Mass 24/100 230V/50-60Hz charger MB
40031006	Mass 3-24/100 400V 3 phase charger MB
40040256	Mass 48/25 230V/50-60Hz charger MB
40040506	Mass 48/50 230V/50-60Hz charger MB

These models are further mentioned as “Mass Charger”

1.3 USE OF PICTOGRAMS

Safety instructions and warnings are marked in this manual by the following pictograms:



WARNING

A WARNING refers to possible injury to the user or significant material damage to the Mass Charger if the user does not (carefully) follow the procedures.



CAUTION!

Special data, restrictions and rules with regard to preventing damage.



A procedure, circumstance, etc which deserves extra attention.

1.4 IDENTIFICATION LABEL

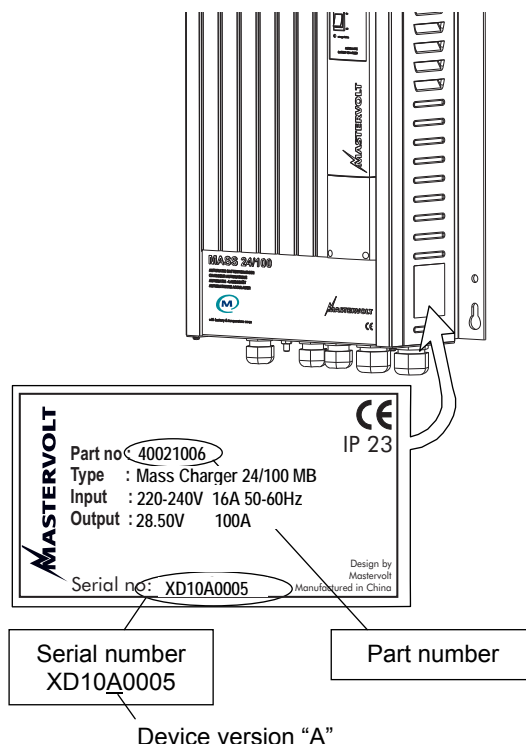

Figure 1: Identification label

The identification label is located at the right-hand side of the Mass Charger (see figure 1). Important technical information required for service, maintenance & secondary delivery of parts can be derived from the identification label.



CAUTION!

Never remove the identification label.

1.5 LIABILITY

Mastervolt can accept no liability for:

- consequential damage due to use of the Mass Charger;
- possible errors in the manuals and their results.

2 IMPORTANT SAFETY INSTRUCTIONS

READ AND SAVE THESE INSTRUCTIONS



WARNING

This chapter describes important safety and operating instructions for use of a Mass Charger in residential, recreational vehicle (RV) and marine applications.

2.1 GENERAL

- 1 Before using the Mass Charger, read all instructions and cautionary markings on the Mass Charger, the batteries, and all appropriate sections of the manual.
- 2 To reduce the risk of electric shock – Do not expose Mass Charger to rain, snow, spray, moisture, excessive pollution and condensing circumstances. To reduce risk of fire hazard, do not cover or obstruct the ventilation openings. Do not install the Mass Charger in a non-ventilated room, overheating may result.
- 3 Use of an attachment or spare part not recommended or sold by Mastervolt may result in a risk of fire, electric shock, or injury to persons.
- 4 The Mass Charger is designed to be permanently connected to an AC and DC electrical system. Installation of, and work on the Mass Charger, may be carried out only by a qualified, authorised and trained technician or electrician, consistent with the locally applicable standards and regulations.
- 5 Make sure that all wiring is properly installed and in good electrical condition; and that wire size is large enough for AC ampere rating of the Mass Charger. Check the wiring on a regular base, at least once a year. Do not use the Mass Charger when the wiring is undersized or damaged.
- 6 Do not operate the Mass Charger if it has received a sharp blow, been dropped, or otherwise damaged in any way; take it to a qualified serviceman.
- 7 Except for the connection compartment, see chapter 4, the Mass Charger may not be opened or disassembled. There are no serviceable parts inside the cabinet. Take it to a qualified, authorized and trained serviceman when service or repair is required. Incorrect reassembly may result in a risk of electric shock or fire. Only qualified, electrician installers are authorized to open the connection compartment.
- 8 To reduce risk of electric shock, disconnect the Mass Charger from both AC and DC electrical system before attempting any maintenance or cleaning. Turning off controls will not reduce this risk.
- 9 The Mass Charger must be provided with an equipment-grounding conductor to the AC-input ground terminal. Grounding and all other wiring must comply with local codes and ordinances.
- 10 Short circuiting or reversing polarity will lead to serious damage to batteries, Mass Charger, wiring as well as accessories. Fuses can not prevent damage caused by reversed polarity and the warranty will be void.
- 11 In case of fire, you must use the fire extinguisher which is appropriate for electrical equipment.
- 12 If applied in a marine application in the United States, external connections to the Mass Charger shall comply with the United States Coast Guard Electrical Regulations (33CFR183, Sub part I).

2.2 EXPLOSIVE GASES

- 1 **WARNING – RISK OF EXPLOSIVE GASES. WORKING IN VICINITY OF A LEAD-ACID BATTERY IS DANGEROUS. BATTERIES GENERATE EXPLOSIVE GASES DURING NORMAL BATTERY OPERATION. FOR THIS REASON, IT IS OF UTMOST IMPORTANCE THAT EACH TIME BEFORE USING THE MASS CHARGER, YOU READ THIS MANUAL AND FOLLOW THE INSTRUCTIONS EXACTLY.**
- 2 To reduce risk of battery explosion, follow these instructions and those published by battery manufacturer and manufacturer of any equipment you intend to use in vicinity of the battery. Review cautionary marking on these products.
- 3 **DANGER:** To reduce the risk of explosion – Never use the Mass Charger in situations where there is danger of gas or dust explosion or an area in which ignition-protected equipment is required.

2.3 WARNINGS REGARDING THE USE OF BATTERIES

- 1 Someone should be within range of your voice or close enough to come to your aid when you work near a lead-acid battery.
- 2 Have plenty of fresh water and soap nearby in case battery acid contacts skin, clothing, or eyes.
- 3 Wear complete eye protection and clothing protection. Avoid touching eyes while working near battery.
- 4 If battery acid contacts skin or clothing, wash immediately with soap and water. If acid enters eye, immediately flood eye with running cold water for at least 10 minutes and get medical attention immediately.
- 5 NEVER smoke or allow a spark or flame in vicinity of a battery or engine.
- 6 Do not short circuit batteries, as this may result in explosion and fire hazard! Be extra cautious to reduce risk of dropping a metal tool onto a battery. It might spark or short-circuit battery or other electrical part and may cause explosion.
- 7 Remove personal metal items such as rings, bracelets, necklaces, and watches when working with a battery. A battery can produce a short-circuit current high enough to weld a ring or the like to metal, causing a severe burn.
- 8 Only use the Mass Charger for charging Lead-acid, NiCad and Li-ion batteries and the supply of users attached to these batteries, in permanent systems. Do not use the Mass Charger for charging dry-cell batteries that are commonly used with home appliances. These batteries may burst and cause injury to persons and damage to property.
- 9 NEVER charge a frozen battery.
- 10 Excessive battery discharge and/or high charging voltages can cause serious damage to batteries. Do not exceed the recommended limits of discharge level of your batteries.
- 11 If it is necessary to remove a battery, always remove the grounded terminal from the battery first. Make sure all accessories are off, so as not to cause an arc.
- 12 Be sure that the area around the battery is well ventilated while the battery is being charged. Refer to the recommendations of the battery manufacturer.
- 13 Batteries are heavy! It may become a projectile if it is involved in an accident! Ensure adequate and secure mounting and always use suitable handling equipment for transportation.

2.4 WARNING REGARDING LIFE SUPPORT APPLICATIONS

The Mass Charger is not sold for applications in any medical equipment intended for use as a component of any life support system unless a specific written agreement pertaining to such intended use is executed between the manufacturer and Mastervolt. Such agreement will require the equipment manufacturer either to contract additional reliability testing of the Mass Charger and/or to commit to undertake such testing as a part of the manufacturing process. In addition the manufacturer must agree to indemnify and not hold Mastervolt responsible for any claims arising from the use of the Mass Charger in the life support equipment.

2.5 GUARANTEE SPECIFICATIONS

Mastervolt guarantees that this unit has been built according to the legally applicable standards and specifications. Should work take place, which is not in accordance with the guidelines, instructions and specifications contained in this users manual, then damage may occur and/or the unit may not fulfil its specifications. All of these matters may mean that the guarantee becomes invalid.

The guarantee is limited to the costs of repair and/or replacement of the product. Costs for installation labor or shipping of the defective parts are not covered by this guarantee.

3 OPERATION

3.1 INTRODUCTION

The Mass battery charger is a full-automatic high efficiency battery charger/rectifier, developed and produced by Mastervolt. The MASS series features a family of advanced quality battery chargers. The Mass Charger not only charges batteries rapidly and safely, it supplies the connected consumers at the same time. In addition, the Mass Charger is secured against short circuit, overload and high temperatures in an industrial environment.

3.1.1 Switching on

The battery charger will be switched on by the ON/OFF switch. One of the front LEDs will light up now and the charging starts immediately.

3.1.2 Switching off:

The battery charger will be switched off by the ON/OFF switch.



WARNING

Switching off the Mass Charger does not cut off the connection to the batteries or the AC-source. This means that voltages are still available inside the apparatus.

3.2 THEORY OF OPERATION

The battery charger is equipped with an intelligent 3-stage charge characteristic which takes care of an optimal charge of your batteries (see fig. 2). When switched on, the Mass Charger always starts at Bulk stage.

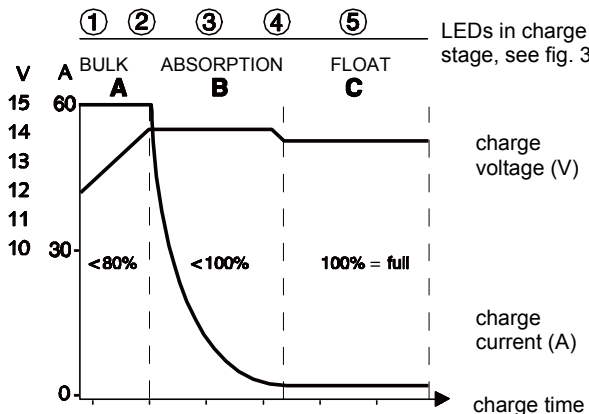

Fig. 2: Example: charge characteristic MASS 12/60-2. (For other models V/A according to specifications).

To prevent your batteries from overcharging a new cycle only starts when the battery voltage has been under the level of 12.8/25.6 or 51.2V for longer than 30 seconds or after a hard reset by switching the on/off switch back and forward.

3.3 FRONT PANEL

See figure 3. On the front of the Mass Charger LED 9 to 13 represent the charging current. The more LEDs are illuminated, the higher the charging current. LED 1-5 represent the charging stage.

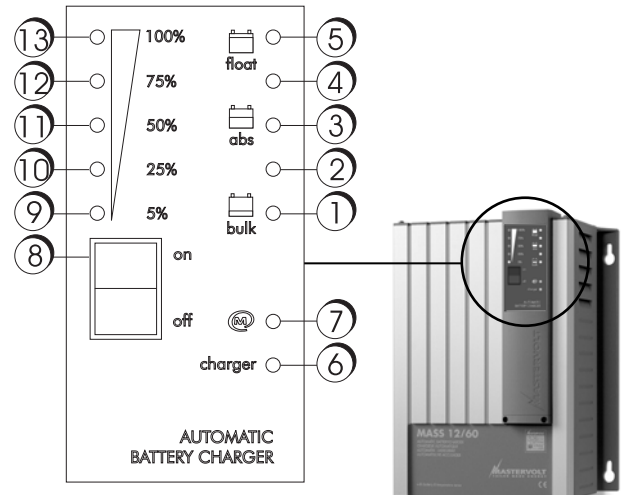

Fig 3: Front panel of the battery charger

illuminating LED's	Meaning
<i>Normal operation, LED 6 illuminates green</i>	
1	Charger on, BULK stage
1+2	$U_{out} > 27.6V$
1+2+3	ABSORPTION, $U_{out} = abs. (28.5V)$
1+2+3+4	3 hrs after start max bulk timer, or $I < return\ amps$
1+2+3+4+5	FLOAT, 6 hrs after start max bulk timer, or $I < return\ amps\ for\ 15\ min\ or\ longer$
9	Charge current 0-5% of full current
9+10	Charge current 5-25% of full current
9+10+11	Charge current 25-50% of full current
9+10+11+12	Charge current 50-75% of full current
9+10+11+12+13	Charge current 75-100% of full current
6	Green: normal operation, Red: fault condition, Off: standby or off
7	Green: MasterBus communication, Off: no MasterBus communication
<i>Fault condition, LED 6 illuminates red</i>	
6 red +1	Battery sense error
6 red +2	Charger temperature too high
6 red +3	Short circuit indication, charger will reduce the charge current to 25%
6 red +4	DC error, DC voltage too low or too high
6 red +5	Temperature sense error

3.3.1 Bulk (LED 1 illuminates)

The battery is empty when only the first LED Bulk/ON illuminates. In this stage the Mass Charger gives full current (see fig. 2 stage A) and the battery voltage will slowly increase.

3.3.2 (LED 1 and 2 illuminate)

After reaching the level of 13.8V (12V charger), 27.6V (24V charger) or 55.2V (48V charger) the battery is charged for about 25% and the second LED will also illuminate. The Mass Charger still gives the maximum output current and the voltage will increase till the absorption voltage level (see fig. 2 stage A). The maximum time of stage A is 8 hours.

3.3.3 Absorption (LED 1, 2 and 3 illuminate)

The battery has been charged for 80% (fig. 2 stage B). The Mass Charger limits the charge voltage to a safe level and the charge current will decrease slowly during charging.

3.3.4 (LED 1 to 4 illuminate)

The charge voltage is limited at the absorption level. As the battery is almost full, the charge current will further decrease.

3.3.5 Float (LED 1 to 5 illuminate)

When all LEDs are illuminated the battery is fully charged. The float charge stage provides a lower output voltage, sufficient enough to maintain the batteries at 100% charge but low enough to prevent your batteries from unnecessary stress. In this stage the Mass Charger is able to supply full current to the connected users/loads.



The Mass Charger automatically resumes operation in Bulk stage after it was disconnected from an AC-source temporarily.

3.4 TEMPERATURE COMPENSATED CHARGING

By installing the battery temperature sensor the charge voltages are automatically adapted for deviating temperatures. This can increase the battery's life time substantially and save you a lot of money.

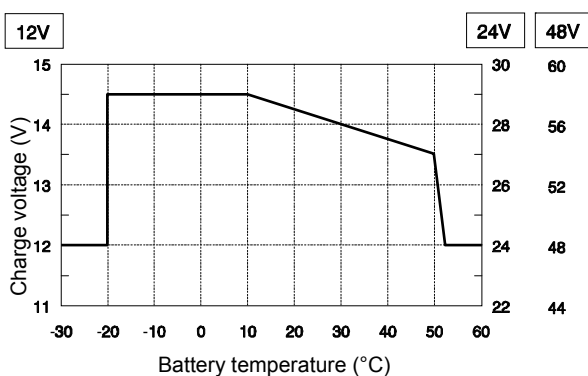

Figure 4:
Temperature compensated charging

See figure 4. When the battery temperature is low, the charge voltage increases. On the other hand, when the battery temperature is high, the charge voltage is decreased. Over charge and gassing are prevented this way. This will extend the life of your batteries.

3.5 COMPENSATION OF THE CABLE LOSSES

The Mass Charger can compensate the voltage drop occurring over the DC cables. For this purpose the Mass Charger is provided with terminals for sense wires. The sense wires are connected closest possible to the batteries in order to charge them with the right voltage. When only the minus sense wire is connected only the losses of the minus DC cable will be compensated. Connecting both cables will give the best result, all losses will be compensated until a maximum of 3V in total.

3.6 ALARM FUNCTION

The battery charger is equipped with an integrated alarm function. External equipment can be controlled by the potential free contacts of this alarm. The maximum switch current of the relay is 1A. Exceeding the setpoints (refer to section 6.7) will activate the alarm.

3.7 CHARGING A SECOND BATTERY

Some installations have a main battery set and besides this a smaller (cranking) battery with the same voltage. It is possible to maintain this second battery with the 3A output of the battery charger. This function is standard available on the models 12/60-2, 12/80-2 and 24/50-2.

3.8 EQUALIZE MODE

An equalizing charge can be necessary after very deep discharges and/or inadequate charges. This has to be carried out according to the specifications of the battery manufacturer.



WARNING!

Equalization is ONLY applicable for wet type batteries and will damage gel/AGM/Spiral type batteries!

Incorrect use of the equalize mode may lead to hazardous situations. Do not smoke or use any naked flame or other sources of ignition due to risk of explosion. Always ventilate the battery room during equalizing to clear the air.

During equalizing the batteries are brought into the gas state and permitted load voltages may be exceeded. Refer to chapter 9 for characteristics. Therefore appropriate measures must be taken, e.g. disconnect all loads from the battery and ventilate the room. For these reasons the equalizing mode should only be used by trained technical engineers.

The equalizing mode can only be started when the Mass Charger is in operation. To start the equalize mode, select Equalize in the MasterBus device settings (section 7.2)

4 INSTALLATION

During installation and commissioning of the Mass Charger, the important safety instructions are applicable at all times. See chapter 2 of this manual.

Please check the contents of the box before you start with the installation. The contents of the box need to be:

- The Mass battery charger;
- Battery temperature sensor (incl. 6 mtr cable);
- A MasterBus terminating device;
- This user's manual;

If one of these items is missing, please contact your supplier.

4.1 INSTALLATION ENVIRONMENT

Choosing a location to install:

- Install the Mass charger in a well-ventilated room protected against rain, snow, spray, vapour, bilge, moisture and dust.
- Ambient temperature: 0 ... 60°C / 32°F ... 140°F; (power derating above 40°C / 104 °F to decrease the internal heat sink temperature).
- Humidity: 0-95% non condensing.
- Never use the Mass charger at a location where there is danger of gas or dust explosions
- Mount the Mass Charger in such a way that obstruction of the airflow through the ventilation openings is prevented. No objects must be located within a distance of 10 cm / 4 inch around the Mass Charger.
- Mount the Mass Charger vertically, with the connecting cables downwards.
- Do not install the Mass Charger in the same compartment as the batteries. Do not mount the Mass Charger straight above the batteries because of possible corrosive sulphur fumes.

4.2 CONNECTIONS

Before making the connection between the battery charger and the system, be sure that the AC and DC system are switched off. Remove the fuses in order to protect yourself against unexpected start up.

4.3 WIRING



CAUTION!

The wire and fuse sizes stated in this manual are given as example only. Prescribed wire and fuse sizes may be different due to local applicable regulations and standards.

4.3.1 AC wiring

Check if the voltage of your mains source or generator corresponds with the AC input voltage of the battery charger as mentioned on the type number plate, see section 1.4.

Strip the cable according to fig. 5a. It is important that the green/ yellow earth wire is ± 1 cm (0.4 inch) longer than the other wires. By accidentally pulling at the cable, the earth wire stays connected to the Mass Charger longer which offers additional safety. Connect the green/yellow wire to PE, brown to L1 and the blue wire to the N terminal.

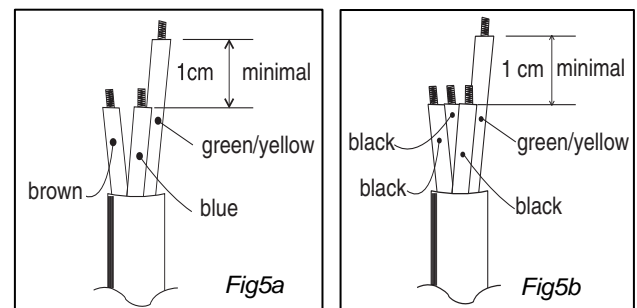

Connect the 3-24/100 according to fig. 5b. The three black wires to L1, L2 and L3. Connect the green/yellow wire to the PE. For a safe installation the correct wire cross section must be applied. Don't use a cross section that is smaller than indicated. See table below to select the appropriate cross section for the AC wiring (up to 6m / 20ft length):

AC Current	Minimum cross section:	
6-12 Amp	1.5 mm ²	14 AWG
12-20 Amp	2.5 mm ²	12 AWG
20-32 Amp	4.0 mm ²	10 AWG

Connection of AC-wiring and recommended wire colours.

- 230V/50Hz installations, see figure 5a:

Wire color	Meaning	Must be connected to:
Brown or black	Phase	L1
Blue	Neutral	N
Green/Yellow	Earth	PE / GND

- 400V/50Hz installations, see figure 5b:

Wire color	Meaning	Must be connected to:
Black	Phase	L1, L2, L3
Green/Yellow	Earth	PE / GND

4.3.2 AC safety grounding



WARNING!

The ground wire offers protection only if the cabinet of the Mass Charger is connected to the safety ground. Connect the ground terminal (PE / GND) to the hull or the chassis.



CAUTION!

For safe installation it is necessary to insert a Residual Current Device (earth leakage switch) in the AC input circuit of the Mass Charger.

4.3.3 DC wiring

Keep the cable connection between charger and batteries shortest possible. If available, use coloured battery cables. If this is not possible, mark the plus and the minus cables with coloured insulating tape, e.g. red for plus and blue/black for minus. Use the following diameters:

Model Mass Charger	Length <3 m	Length 3-6 m
Mass 12/60-2 MB	25 mm ²	35 mm ²
Mass 12/80-2 MB	35 mm ²	50 mm ²
Mass 24/50-2 MB	25 mm ²	35 mm ²
Mass 24/75 MB	35 mm ²	50 mm ²
Mass 24/100 MB	50 mm ²	70 mm ²
Mass 3-24/100 MB	50 mm ²	70 mm ²
Mass 48/25 MB	10 mm ²	16 mm ²
Mass 48/50 MB	25 mm ²	35 mm ²

Connection of main batteries

- 1 Pull the cables through the cable glands of the Mass Charger.
- 2 Crimp on the ring terminals to the cable:
 - ring M6 for 12/60-2, 12/80-2, 24/50-2 and 48/25;
 - ring M8 for 24/75, 24/100, 48/50 and 3-24/100.
- 3 Connect the cables to the terminals of the Mass Charger. Pay attention to the polarity, positive on positive / negative on negative.
- 4 Integrate a suitable fuse (charger fuse) in the positive cable. When using a DC distribution with fuses, no additional fuse is necessary.
- 5 Cut the cables at length and crimp on the ring terminals. Connect the cable to the DC distribution or batteries.



CAUTION

Reversing the positive and negative battery poles will severely damage the Mass Charger.



Too thin cables and/or loose connections can cause dangerous overheating of the cables and/or terminals.

Lay the positive and negative cables next to each other to limit the electromagnetic field around the cables. The negative cable should be connected directly to the

negative post of the battery bank or the ground side of a current shunt. Do not use the hull or chassis frame as the negative conductor.

4.4 BATTERY CAPACITY

Always follow the instructions published by battery manufacturer. The minimum required battery capacity for Mastervolt gel batteries is as follows:

Model Mass Charger	Minimum required battery capacity
Mass 12/60-2 MB	140Ah
Mass 12/80-2 MB	200Ah
Mass 24/50-2 MB	120 Ah
Mass 24/75 MB	160 Ah
Mass 24/100 MB	250 Ah
Mass 3-24/100 MB	250 Ah
Mass 48/25 MB	60 Ah
Mass 48/50 MB	120 Ah

4.5 BATTERY ISOLATOR

If one or more batteries or battery sets must be charged at the same time via one output, a battery isolator should be used. It isolates the different battery sets from one another, in order to prevent one discharging the other. A consequence of the battery isolator is a voltage drop of 0.6 Volt. This voltage drop can be compensated in two ways:

- 1 By changing DIP-switch 4 to On (Diode enabled);
- 2 By using the voltage sense function (see section 4.8);



CAUTION

Never use both methods. Your batteries will be overcharged and severely damaged!

For a proper installation, see also the connection diagram included with the battery isolator.

Steps:

- 1 Check if the Mass Charger, the main supply and the DC distribution are switched off.
- 2 Check if the Dc fuses have been removed.
- 3 Connect the battery isolator(s) using cables with the same diameter as the battery cables.
- 4 Compensate the voltage drop over the battery isolator by changing the setting of dip switch 4 (see fig. 7).
- 5 Switch on the Mass Charger.

4.6 CONNECTION OF SECOND BATTERY (3A OUTPUT)

Battery charger models Mass 12/60-2 MB, 12/80-2 MB and 24/50-2 MB are standard equipped with a second charge output which can be used to give a maintenance charge to a small second battery set like a starter battery. The maximum charge current of the second output is 3A, which comes from the main output.

- Use 2.5 to 4 mm² cable for connection.
- Connect the minus of the second battery to the minus of the main battery.
- Connect the plus of the second battery to the +3A terminal of the Mass Charger (see fig. 2 and 3).
- Integrate a 10A slow blow fuse in the plus cable.

4.7 TEMPERATURE SENSOR

The standard temperature sensor is provided with 6 m cable and a double-sided tape for easy installation. Determine the warmest place on the battery set and make it clean and grease free. Remove the piece of paper from the tape and stick the sensor on the battery. Plug the modular cable into a terminal at the right of the Mass Charger (see fig. 7). For the C3 enclosure (refer to specifications) both "RS232" and "analog" are suitable. It is not necessary to shorten the cable. When you want to shorten it anyway please notice the polarity of the plug and use the old connector as an example.

4.8 VOLTAGE SENSE

To shorten the charge time substantially, the battery cable losses can be compensated by using the sense function. Use 0,75 mm², preferably red and black wire and secure these with fuses of 2A slow blow. Connect the wires with the two upper terminals of the green connector at the right side of the cabinet (see fig. 7). Pay good attention to the polarity of the wires, red on +S and black on -S. Now connect the other side of the wires: black on the minus of the battery and red on the battery side of the Mass Charger fuse.

4.9 ALARM FUNCTION

The battery charger is equipped with a potential free contacts alarm relay, see figure 7. The alarm function has two modes: standard (factory setting) and DC alarm mode (continuous mode).

4.9.1 Standard alarm mode

In this mode the relay responds to all fault conditions that the Mass Charger can detect such as: no AC input voltage, too low DC voltage, voltage sense failure, temperature sense failure.

4.9.2 DC alarm mode

To enable this mode a DIP switch setting needs to be changed (switch 1 and 2 at ON). The alarm now works as a DC alarm and responds to the battery voltage only.

Note: In the DC alarm mode the electronics stay active permanently and drain a very small current of ± 25mA, also when the Mass Charger is switched off.

4.10 CONNECTION OF ACCESSORIES

The battery charger is equipped with several terminals for accessories. Cable to connect the accessories is not delivered as a standard. Accessories can be plugged in at all times. For C3 enclosure (refer to specifications): when using a remote panel and the temperature sensor use the specified plug for the panel and the other (free) one for the temperature sensor.



Figure 6: Standard remote panel C3-RS.

Art. no 70403040

The standard remote panel must be connected with an appropriate communication cable.

4.11 RJ12 SPLITTER FOR ENCLOSURE C2

The RJ12 connector (QRS232 communication port) can be used to connect the battery temperature sensor or the remote panel (not included). Use a RJ12-splitter to connect both at the same time (not included).

4.12 OVERVIEW CONNECTION COMPARTMENT

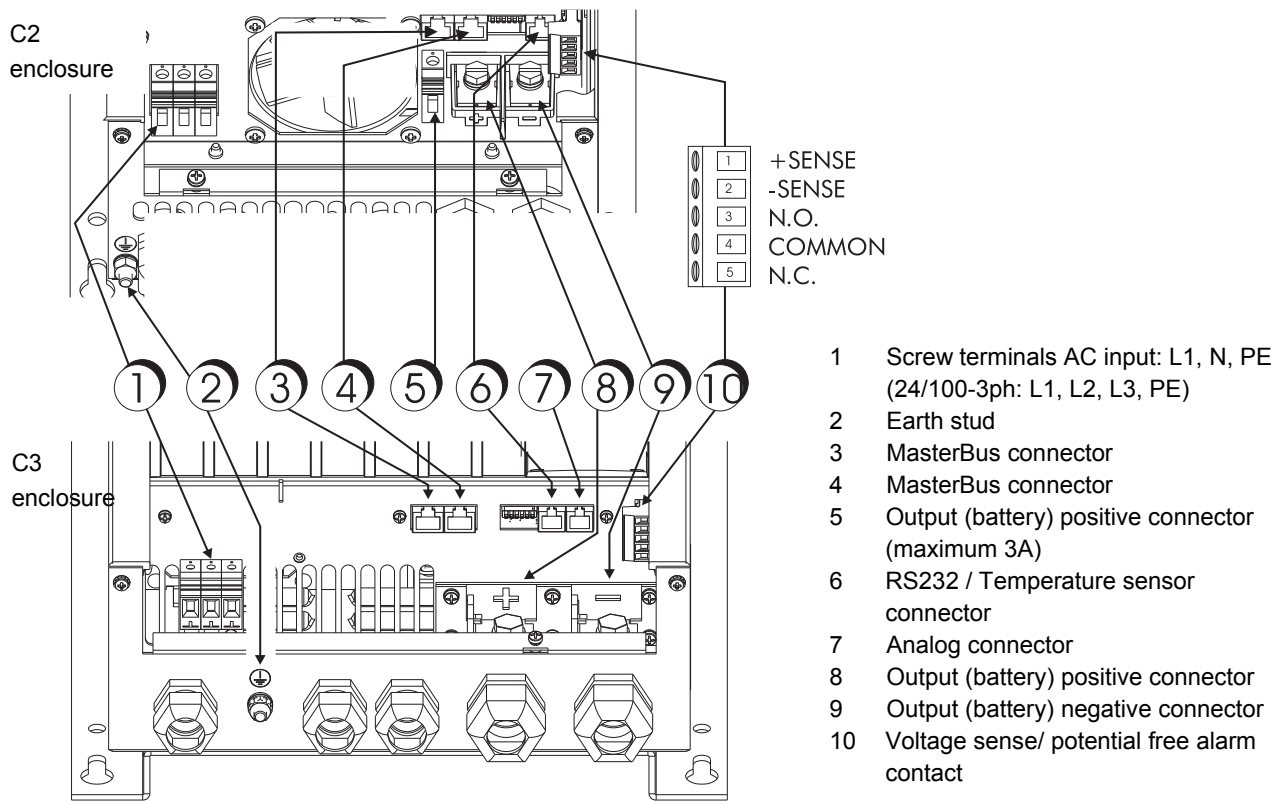

Figure 7: Overview connections Mass Charger

4.13 THINGS YOU NEED

Make sure you have all the parts you need to install the Mass Charger:

Product	Quantity
Mass Charger (included)	1
Battery temperature sensor with cable and plug (included).	1
DC-cable to connect the positive DC connection (+) of the Mass Charger to the positive pole of the DC-distribution; for specifications see section 4.3.3.	1
DC-cable to connect the negative DC connection (-) of the Mass Charger to the negative pole of the DC-distribution; for specifications see section 4.3.3.	1
DC-fuse holder with a DC-fuse, to be integrated in the positive DC-cable.	1
Screws / bolts (Ø 6mm) (with plugs) to mount the cabinet to a surface. Use mounting materials which are suitable to carry the weight of the Mass Charger	4
AC cable* to connect the AC input to an external power source (e.g. a shore connection or a generator set);	1
Batteries. See section 4.4 for recommended capacity	X
Appropriate and reliable cable terminals, cable lugs, battery terminals and cord end terminals	X

* Double insulated three wire cable with wire colours according to the locally applicable regulations. The applicable length and wire diameter depend on the electrical installation (see section 4.3.1).

We recommend as a minimum tool kit:

- Socket wrench 13mm to fix the DC-input (battery) cables
- Flat blade screw driver 1.0 x 4.0 mm to fix the screw terminals
- Tools to fix the screws / bolts (Ø 6mm) with plugs to mount the cabinets to a surface
- Philips screw driver to open the connection area of the Mass Charger
- 2 mm flat blade screw driver for the sense terminal (figure 7 point 10).

4.14 CONNECTION



WARNING

Let installation work be done by a licensed electrician. Before beginning with the connection of the wiring, make the AC distribution as well as the DC distribution voltage free.



CAUTION!

Short circuiting or reversing polarity may lead to serious damage to the batteries, the Mass Charger, the cabling and/or the terminal connections. Fuses between the batteries and the Mass Charger can not prevent damage caused by reversed polarity. The damage as a result of reverse polarity is detectable by the service department and is not covered by the warranty.



CAUTION!

Too-thin cables and/or loose connections can cause dangerous overheating of the cables and/or terminals. Therefore tighten all connections well, in order to limit transition resistance as far as possible. Use cables of the correct size.



NOTE:

If the battery temperature remains within 15-25°C, connection of the battery temperature sensor is optional.



NOTE:

The Mass Charger is feasible for the connection of MasterBus and RS 232 compatible remote control panels.

This schematic is to illustrate the general placement of the Mass Charger in a circuit. It is not meant to provide detailed wiring instructions for any particular electrical installation.

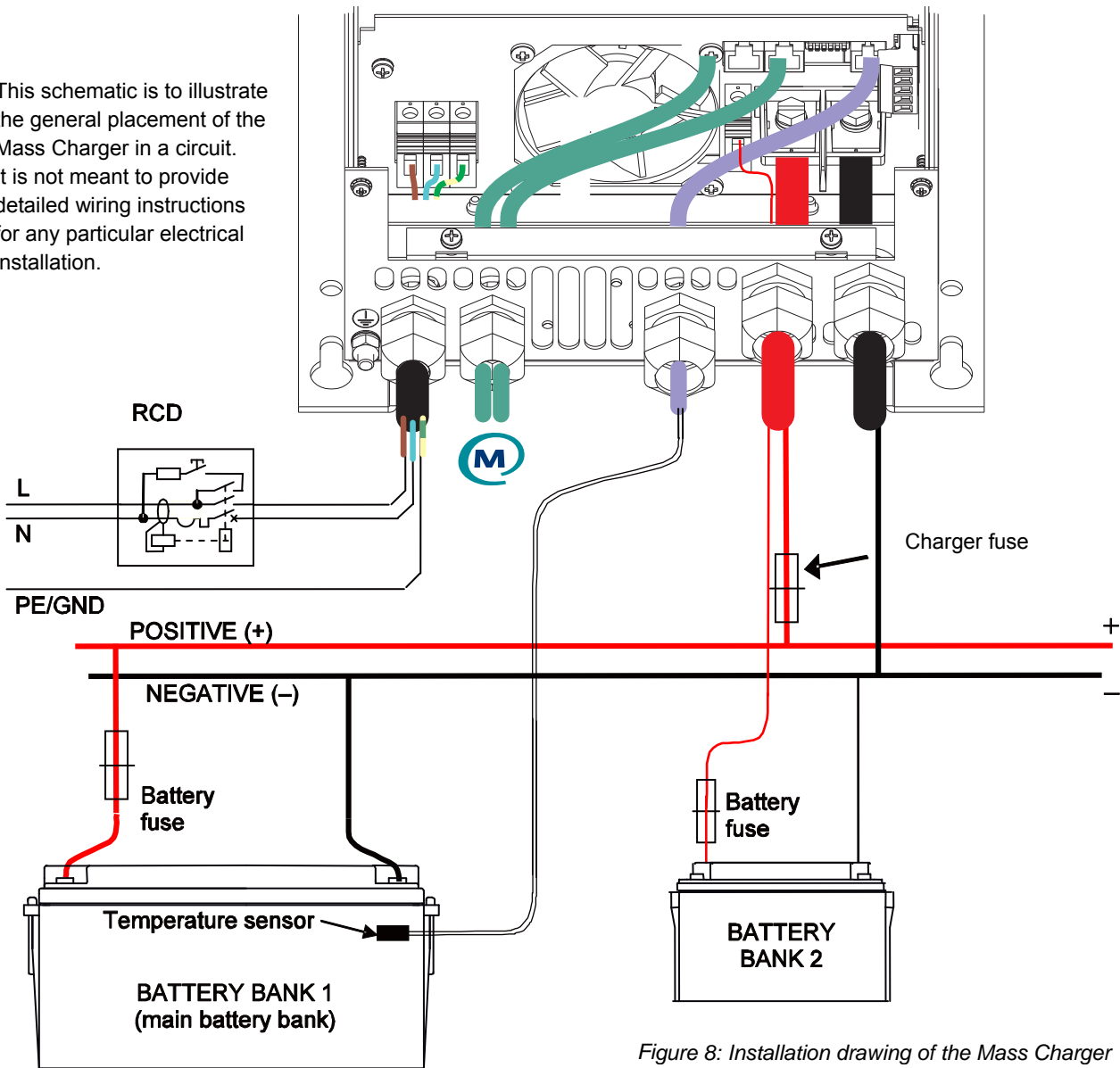
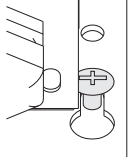

Figure 8: Installation drawing of the Mass Charger

4.15 INSTALLATION STEP-BY-STEP

1 Mark the position of the mounting spots using the drilling dimensions .

2 Place the four screws first and hang the Mass Charger over them. Then fix the Mass to the wall by securing the screws.



3 Open the connection compartment by loosening the two screws.

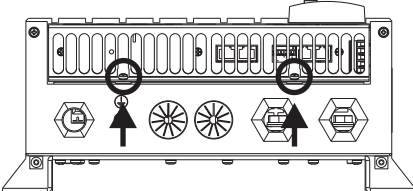

4 Feed the AC wiring through cable gland and connect the wiring to the screw terminals. Tighten the cable gland firmly.

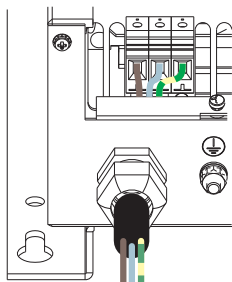

5 Connect the DC-cabling of the house bank, positive to +, negative to - .

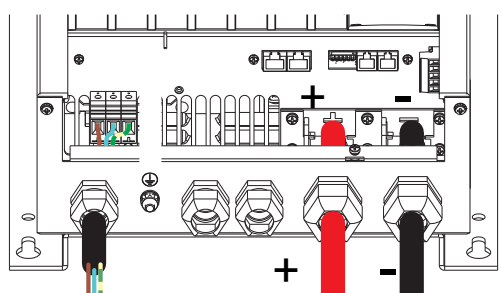

6 Option for models 12/60, 12/80 and 24/50:
Connect the DC-wiring of the second battery bank (max. 3A). This bank has a common negative with the main battery.

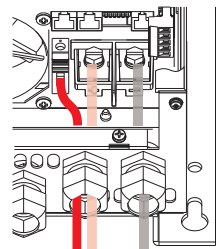

7 Attach the battery temperature sensor to the casing of the main battery bank. Plug the temperature sensor cable into the "temp.sensor" jack.

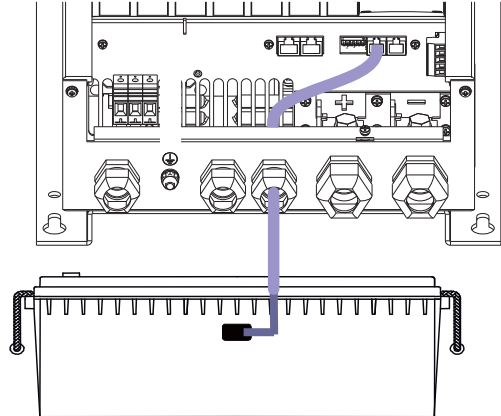

7 Option: Connect the Mass Charger to the MasterBus network.

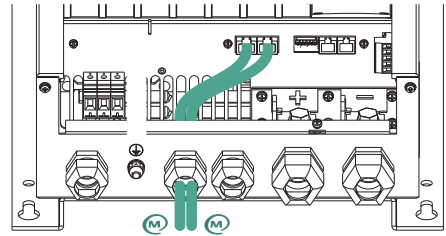

8 The factory setting of the Mass Charger is optimal for most installations. Sometimes however, it is desirable to change these settings. See ch. 5 DIP switch adjustment and chapter 7 for MasterBus settings.

9 Check all wiring; see also figure 10 for wiring details. If everything is all right, close the connection compartment by fixing the two screws.

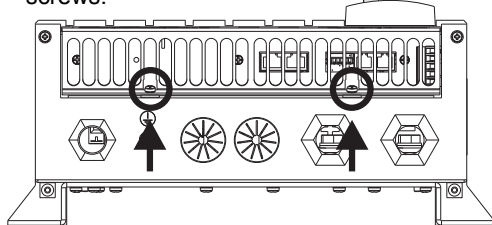

10 Continue with section 4.16 for commissioning of the Mass Charger.

4.16 COMMISSIONING AFTER INSTALLATION



When your Mass Charger is not new, you have to take into account that former users may have changed the settings. Reset the Mass Charger to factory settings when there is any doubt (see section 7.1).

4.16.1 General

The factory settings of the Mass Charger are optimal for most installations. With some applications however, it is desirable to change these settings. Therefore several adjustments can be made. See chapters 5 and 7.



NOTE:

The DIP-switches must be adjusted *prior* to commissioning; all other settings can only be made *after* commissioning.



CAUTION!

Check the polarity of all wiring before commissioning: positive connected to positive (red cables), negative connected to negative (black cables).

If all wiring is OK, place the DC-fuse(s) of the DC-distribution to connect the batteries to the Mass Charger.



WARNING

When placing this fuse, a spark can occur, caused by the capacitors used in the Mass Charger. This is particularly dangerous in places with insufficient ventilation, due to the gassing of the batteries an explosion can occur. Avoid having flammable materials close by.

Now the Mass Charger is ready for operation. After switching on the AC power supply the Mass Charger will initiate the charging process.

4.16.2 MasterBus (optional)

During first commissioning the Mass Charger will be recognized by the MasterBus network automatically. The remote control panel of the MasterBus network will indicate that a new device was found.

Some settings can only be changed via the MasterBus interface. See chapter 7 for an overview of all available MasterBus settings. Refer to the user's manual of the remote control panel to change these settings.

4.17 DECOMMISSIONING

If it is necessary to put the Mass Charger out of operation, follow the instructions in order of succession as described below:

- 1 Switch the Mass Charger to OFF (see section 3.1.2).
- 2 Remove the DC-fuse(s) of the DC-distribution and/or disconnect the batteries.
- 3 Remove the AC-fuse(s) of the AC-input and/or disconnect the AC-mains.
- 4 Open the connection compartment of the Mass Charger.
- 5 Check with a suitable voltage meter whether the inputs and the outputs of the Mass Charger are voltage free.
- 6 Disconnect all the wiring.

Now the Mass Charger can be demounted in a safe way.

4.18 STORAGE AND TRANSPORTATION

When not installed, store the Mass Charger in the original packing, in a dry and dust free environment.

Always use the original packing for transportation. Contact your local Mastervolt Service Centre for further details if you want to return the apparatus for repair.

4.19 RE-INSTALLATION

To reinstall the Mass Charger, follow the instructions as described in this chapter (chapter 4).

5 DIP SWITCH SETTINGS

The Mass Charger settings can be adjusted in two ways:

- By means of DIP-switches;
- Via the MasterBus network (by means of a remote control panel or an interface connected to a PC with MasterAdjust software); see chapter 7.



Once a DIP switch has been set to On, MasterBus settings are disabled.



CAUTION!

Invalid settings of the Mass Charger can cause serious damage to your batteries and/or the connected load! Adjustments of settings may be undertaken by authorised personnel only!

5.1 DIP SWITCH OPERATION

The Mass Charger has six DIP switches, see figure 9. These switches are operated by flipping the levers to the other position, using a small screw driver.

5.2 DIP SWITCH FUNCTIONS

See the table below for the functional overview of the six DIP switches (Switch 5 and 6 are reserved for future use)

5.2.1 Force Float (DIP switch 1)

For special applications a fixed charge voltage can be required. The battery charger allows you to change the three stage charge program to a single stage program by activating the function "Force Float", switching DIP switch 1 to "ON".

The charge voltage will be fixed at 13.25V (12V charger), 26.5V (24V charger) or 53V for a 48V charger.

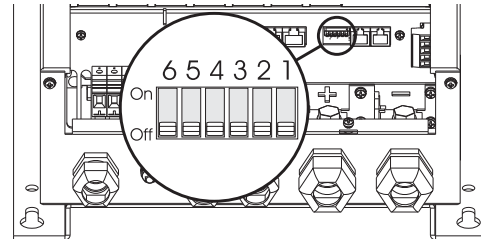
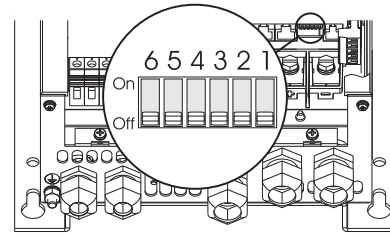

Figure 9: DIP-switches C2 (above) and C3 enclosure

5.2.2 Traction setting (DIP switch 2)

Setting for traction charging: +0.35/0.7/1.4V during bulk and +0.2/0.4/0.8 V in absorption for 12/24/48V batteries.

5.2.3 Gel/AGM batteries (DIP switch 3)

Some gel/AGM batteries need a higher float voltage for optimal charge. Changing the float voltage can be done by setting DIP switch 3 to "ON". The float voltage will increase to 13.8V (12V charger), 27.6V (24V charger) or 55.2V for a 48V charger.

5.2.4 Diode setting (DIP switch 4)

Setting for +0.6 V voltage compensation in case a battery isolator is used.

4	3	2	1	DIP switches/ Settings
0	0	0	0	Standard
1	0	0	0	Diode
0	1	0	0	Gel/AGM
1	1	0	0	Diode + Gel/AGM
0	0	1	0	Traction
1	0	1	0	Traction + Diode
0	1	1	0	ContMon + Traction
1	1	1	0	ContMon + Traction + Diode
0	0	0	1	ForceFloat
1	0	0	1	ForceFloat + Diode
0	1	0	1	ForceFloat + Gel/AGM
1	1	0	1	ForceFloat + Diode + Gel/AGM
0	0	1	1	ContMon
1	0	1	1	ContMon + Diode
0	1	1	1	ContMon + Gel
1	1	1	1	ContMon + Diode + Gel/AGM

1 = ON; 0 = OFF

ContMon: Continuous monitor mode. MasterBus, RS232 and DC-alarm stay functioning at mains failure. Remote stays functioning if it has its own power source.

Diode: Diode compensation on (+0.6V)

Gel/AGM: Gel/AGM compensation on (+0.55V during float) or 1.1V/24V or 2.2V/ 48V

Traction Traction charging (+0.35/0.7/1.4V during bulk and +0.2/0.4/0.8V in absorption).

Force float: One step charge program with fixed float voltage.

6 MASTERBUS

6.1 WHAT IS MASTERBUS?



All devices that are suitable for MasterBus are marked by the MasterBus symbol.

MasterBus is a fully decentralized data network for communication between the different Mastervolt system devices. It is CAN-bus based which has proven itself as a reliable bus-system in automotive applications. MasterBus is used as power management system for all connected devices, such as the inverter, battery charger, generator and many more. This enables communication between the connected devices, for instance to start the generator when the batteries are low.

MasterBus reduces complexity of electrical systems by using UTP patch cables. All system components are simply chained together. Therefore each device is equipped with two MasterBus data ports. As only a few MasterBus cables are needed, installation and material costs are reduced importantly. New devices can be added to the existing network easily. Consequently the MasterBus network is highly flexible for extended system configuration. Mastervolt also offers several interfaces like the Modbus and NMEA interface, making even non-MasterBus devices suitable to operate in the MasterBus network.

For central monitoring and control of the connected devices Mastervolt offers four different panels, from the small Mastervision compatible 120 x 65mm LCD screen up to the full colour MasterView System panel. All monitoring panels can be used for monitoring, control and configuration of all connected MasterBus equipment.

Connections between the devices are made by standard straight UTP patch cables.

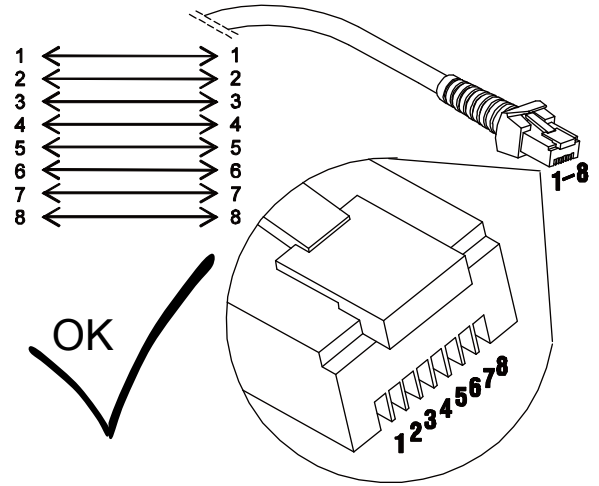

At least one device in the network must be MasterBus powering (see specifications). As all powering devices are galvanic isolated, multiple powering devices are allowed.

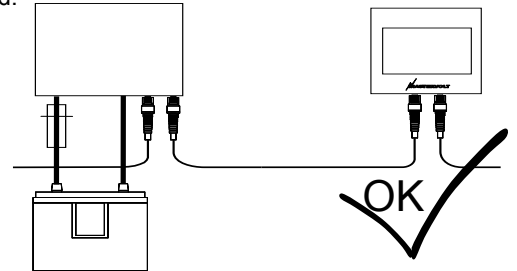

CAUTION: Never connect a non-MasterBus device to the MasterBus network directly! This will void warranty of all MasterBus devices connected.

6.2 HOW TO SET UP A MASTERBUS NETWORK

Every MasterBus device is equipped with two data ports. When two or more devices are connected via these ports, a local data network called the MasterBus is formed. Keep the following rules in mind:

Place a terminating device on both network ends.

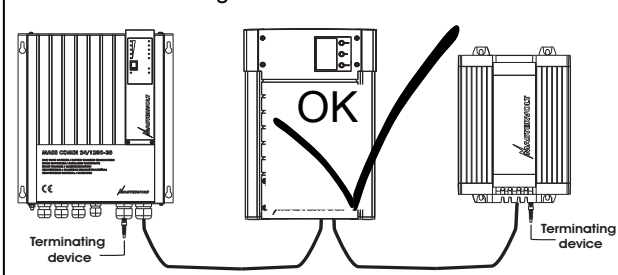

Do not make ring networks.

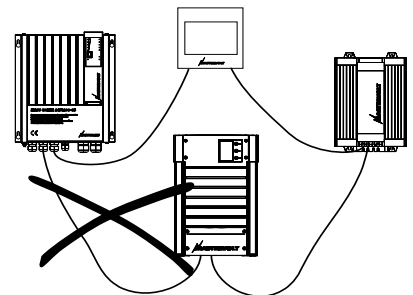

Do not make T-connections in the network.

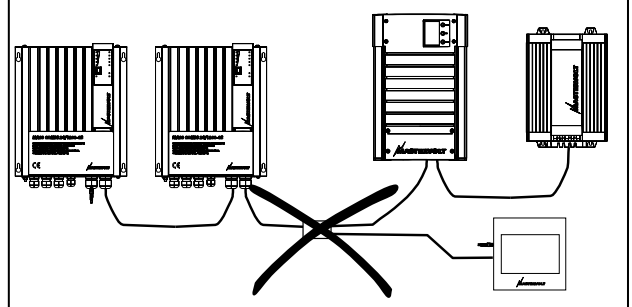

7 MASTERBUS SETTINGS

Below parameters can be changed via the MasterBus network by means of a remote control panel or by means of an interface connected to a PC with MasterAdjust software. See applicable user's manuals for details.

Value	Meaning	Factory setting	Adjustable range
7.1 DEVICE			
Language	Language that is displayed on a monitoring device connected to the MasterBus.	English	EN, NL, DE, FR, ES, IT
Name	Name for the Mass Charger.	CHG Mass+type*	0-12 characters
Device	Device name recognized by MasterBus.	Mass Charger	-
Battery name	Name for the main battery bank.	House Bank	0-16 characters
Factory settings	Option to reset the Mass Charger to default settings.	Not reset	Not reset, reset
7.2 PRESETS			
Diode compensate	Option for charger diode +0.6 V voltage compensation. If it is enabled, the compensation value is adjustable.	Disabled	Disabled, Enabled: 0-2.50 V
Forced float	Option for Forced Float or constant voltage charging. If it is enabled, Forced Float voltage is adjustable.	Disabled	Disabled, Enabled
Continuous mode	Option to keep MasterBus powered by the battery when the Mass Charger is disabled.	Disabled	Disabled, Enabled
Gel / AGM	Gel/ AGM settings option. It includes fully adjustable Bulk, Absorption and Float settings.	Disabled	Disabled, Enabled
Traction	Traction settings option. See section 7.8.	Disabled	Disabled, Enabled
NiCad	NiCad settings option See section 7.9.	Disabled	Disabled, Enabled
Li-ion	Li-ion settings option. See section 7.10.	Disabled	Disabled, Enabled
Equalize	Option to enable Equalizing. Shows only when no other battery type has been selected. Warning: Equalize is suitable for wet batteries only! Do not use Equalize for other battery types!	Disabled	Disabled, Enabled
7.3 GENERAL			
Max. current	Maximum charge current, adjustable model dependent.	(Max current)*	0 – I _{max} *
Temp. compensate	Charge voltage compensation for temperature (V/°C).	-0.030/ -0.060/ -0.120 V/°C	-1.000 .. 1.000 V/°C
7.4 BULK			
Bulk voltage	Bulk voltage	14.25/28.50/57.00 V	0.00-16.00/16.00-32.00/ 32.00-64.00 V
Max. bulk time	Maximum bulk timer	360 min	0-600 min
Min bulk time	Minimum bulk timer	4 min	0-600 min
Start bulk time	Voltage at which to start the bulk timer.	13.80/27.60/55.2 V	0.00-16.00/16.00-32.00/ 32.00-64.00 V
Bulk ret. volt.	Return to Bulk voltage	12.80/25.60/51.2 V	0.00-16.00/16.00-32.00/ 32.00-64.00 V
Bulk ret. time	Adjustable Return to Bulk time after the Return to Bulk voltage has been reached.	30 sec	0-255 sec
7.5 ABSORPTION			
Abs. voltage	Absorption voltage	14.25/28.50/ 57.00 V	0.00-16.00/16.00-32.00/ 32.00-64.00 V
Max absorption	Maximum absorption timer	360 min	0-600 min
Min absorp. time	Minimum absorption timer	15 min	0-180 min
Return amps	Return to Bulk current (in A)	6.0 %*I _{max}	0-25% * I _{max}

Value	Meaning	Factory setting	Adjustable range
7.6 FLOAT			
Float voltage	Float voltage	13.25, 26.50,53.00 V	0.00-16.00/16.00-32.00/ 32.00-64.00 V
Equalize voltage	Equalize voltage	15.50/ 31.00/ 62.00 V	0.00-16.00/16.00-32.00/ 32.00-64.00 V
Equalize time	Equalize time	360 min	0-600 min
7.7 ALARM SETPOINTS			
DC Alrm high on	Alarm DC High on	16.00/32.00/ 64.00 V	0.00-16.00/16.00-32.00/ 32.00-64.00 V
DC Alrm high off	Alarm DC High off	15.00/30.00/60.00 V	0.00-16.00/16.00-32.00/ 32.00-64.00 V
DC Alrm low on	Alarm DC low on	10.00/20.00/40.00 V	0.00-16.00/16.00-32.00/ 32.00-64.00 V
DC Alrm low off	Alarm DC low off	11.00/22.00/44.00 V	0.00-16.00/16.00-32.00/ 32.00-64.00 V
DC Alrm delay	Alarm delay time	30 sec	0-255 sec
7.8 TRACTION SETTINGS			
Bulk voltage	Bulk voltage	14.60/29.20/58.40 V	(read only)
Max bulk time	Maximum bulk time	360 min	(read only)
Min bulk time	Minimum bulk time	4 min	(read only)
Start bulk time	Start bulk time	13.80/27.60/55.20 V	(read only)
Bulk ret. volt.	Bulk return voltage	12.80/25.60/51.20 V	(read only)
Bulk return time	Bulk return time	30 sec	(read only)
Abs. voltage	Absorption voltage	14.45/28.90/57.80 V	(read only)
Max absorp. time	Maximum absorption time	480 min	(read only)
Min absorp. time	Minimum absorption time	15 min	(read only)
Return amps	Return to Bulk current (in A)	6.0 %*I max	(read only)
Float voltage	Traction float voltage	13.25/26.50/53.00 V	(read only)
7.9 NICAD SETTINGS			
Bulk voltage	Bulk voltage	14.5/29.00/58.00 V	(read only)
Max bulk time	Maximum bulk time	480 min	(read only)
Min bulk time	Minimum bulk time	2 min	(read only)
Start bulk time	Start bulk time	13.25/26.50/53.00 V	(read only)
Bulk ret. volt.	Bulk return voltage	10.00/20.00/40.00 V	(read only)
Bulk return time	Bulk return time	30 sec	(read only)
Abs. voltage	Absorption voltage	14.50/29.00/58.00 V	(read only)
Max absorp. time	Maximum absorption time	480 min	(read only)
Min absorp. time	Minimum absorption time	15 min	(read only)
Return amps	Return to Bulk current (in A)	6.0 %*I max	(read only)
Float	NiCad float voltage	13.00/26.00/52.00 V	(read only)
7.10 MLI SETTINGS			
Bulk voltage	Bulk voltage	14.60/29.20/58.40 V	(read only)
Max bulk time	Maximum bulk time	480 min	(read only)
Min bulk time	Minimum bulk time	2 min	(read only)
Start bulk time	Start bulk time	13.25/26.50/53.00 V	(read only)
Bulk ret. volt.	Bulk return voltage	13.15/26.30/52.60 V	(read only)
Bulk return time	Bulk return time	240 sec	(read only)
Abs. voltage	Absorption voltage	14.50/29.00/58.00 V	(read only)
Max absorp. time	Maximum absorption time	480 min	(read only)
Min absorp. time	Minimum absorption time	15 min	(read only)
Return amps	Return to Bulk current (in A)	6.0 %*I max	(read only)
Forced Float	LI-ion forced float voltage	13.25/26.50/53.00 V	(read only)

* Depending on model

7.11 EVENTS

Event x source	See section 7.11.1 and 7.11.2	Disabled	
Event x target	Select a connected MasterBus device that should take action due to a Mass Charger event.	Select...	Selectable targets are system dependent.
Event x command	Action to be taken by the target device.	Select...	See command list in selected device manual
Event x data	Data is linked to the command. See also figure 10.	Off	Off, On, Copy, Copy Invert, Toggle.
Event x+1	The next event appears after enabling Event x.	Disabled	See Event x.

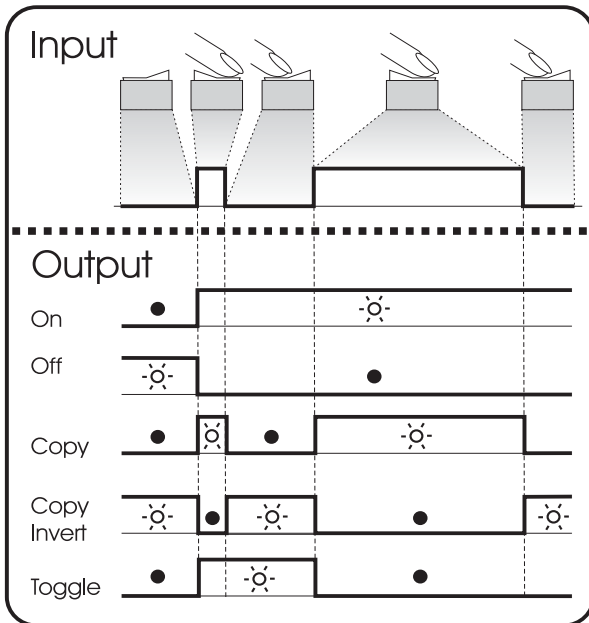

Figure 10 shows the meaning of the event data.

Input (pulses)

The input is represented by an on/off switch.

Output (data)

On changes the status to On at the first signal.

Off changes the status to Off at the first signal.

Copy lets the status follow the input.

Copy Invert lets the status follow the opposite of the input

Copy is used for dimming too by holding the pulse switch pressed for a longer time.

Toggle changes the status at the first signal and back at the second signal. It is used in combination with a pulse switch.

Figure 10: Event data

7.11.1 Mass Charger event source list (Mass Charger as event source)

Charging	Mass Charger state is On
Bulk	Charge stage is Bulk
Absorption	Charge stage is Absorption
Float	Charge stage is Float
Failure	Charger failure MasterBus alarm
CSI	Charger Status Interface MasterBus alarm to generate an audible alarm at charger failure
Equalize	Mass Charger is in Equalize mode
TC Error	Battery temperature sensor error
Fan	MasterBus signal for an external fan to start (at 50% load / 50°C)
LED Bulk	LED Bulk illuminates
LED 20-40	LED 2 illuminates (see figure 3)
LED Abs	LED Abs illuminates
LED 60-80	LED 4 illuminates (see figure 3)
LED Float	LED Float illuminates
LED Failure	LED Failure illuminates

7.11.2 Mass Charger event target list (Mass Charger as event target)

Mpc reduce	Command to reduce AC current at a 5%/sec rate
Mpc off	Command to reduce AC current fast
Bulk	Command to start the Bulk stage of charge
Absorption	Command to start the Absorption stage of charge
Float	Command to start the Float stage of charge
On/ Standby	Command to switch on the Mass Charger

8 TROUBLE SHOOTING

In case of a failure, the Mass Charger display shows an error code to help you find its source. See section 3.3 for error codes. If you cannot solve a problem with the aid of the fault finding table, contact your local Mastervolt

Make sure you have the article and serial number present if you have to contact your local Mastervolt Service Center to solve a problem (See section 1.4).

8.1 FAULT FINDING TABLE

Malfunction	Possible cause	What to do
No output voltage and/or current	No AC-input.	Check AC wiring, check remote control panel.
	AC-input voltage too low (< 180VAC) .	Check input voltage, check generator.
	AC input frequency out of range.	Check input voltage, check generator.
Output voltage too low, charger supplies maximum current	Load that is connected to the batteries is larger than charger can supply.	Reduce load taken from the batteries.
	Batteries not 100% charged.	Measure battery voltage. After some time this will be higher.
Charge current too low	Batteries almost fully charged.	Nothing, this is normal when the battery is almost fully charged.
	High ambient temperature.	Nothing; if ambient temperature is more than 40°C the charge current is automatically reduced.
	Low AC input voltage. At lower AC-input voltages the charge current is reduced. See figure 14.	Check AC-input voltage.
Batteries not fully charged	Charge current too low.	See "Charge current too low".
	Current to load is too high.	Reduce load taken from the batteries.
	Charge time too short.	Use a battery charger with higher capacity.
	Battery temperature too low.	Use the battery temperature sensor.
Batteries are discharged too fast	Defective or old battery.	Check battery and replace if necessary.
	Battery capacity reduced due to wastage or sulphation, stagnation.	Charge and recharge a few times, this might help. Check battery and replace if necessary.
Batteries are too warm, gassing	Defective battery (short circuit in cell).	Check battery and replace if necessary.
	Battery temperature too high.	Use the battery temperature sensor.
	Charge voltage too high.	Check settings (see chapter 6).

9 TECHNICAL DATA

9.1 SPECIFICATIONS

Model	Mass 12/60-2 MB	Mass 12/80-2 MB	Mass 24/50-2 MB	Mass 24/75 MB
Article no.	40010606	40010806	40020506	40020756
INPUT				
Mains voltage	230V, -10% + 15%	230V, -10% + 15%	230V, -10% + 15%	230V, -10% + 15%
Frequency	50-60 Hz ± 5 Hz	50-60 Hz ± 5 Hz	50-60 Hz ± 5 Hz	50-60 Hz ± 5 Hz
Inrush current	None, the battery charger is equipped with a soft start in accordance with IEC 1003-3			
Input current	4A	6A	7A	12A
Power factor (Cos phi)	1	1	1	1
Maximum efficiency	89%	89%	89%	89%
Input power	900W	1400W	1600W	2700W
OUTPUT				
Nominal voltage	12V DC	12V DC	24V DC	24V DC
Max charge current (I _{max})*	60 A	80 A	50 A	75 A
Outputs	1x60 A and 1x3 A	1x80 A and 1x3 A	1x50 A and 1x3 A	1 x 75 A
Charge characteristic*	three-step plus, fully automatic	three-step plus, fully automatic	three-step plus, fully automatic	three-step plus, fully automatic
Battery types:	Flooded lead acid, gel/AGM lead acid, NiCd, Mastervolt MLI (see chapter 7 for settings)			
Default charge voltages at 25°C				
Absorption voltage*	14.25V	14.25V	28.5V	28.5V
Float voltage*	13.25V	13.25V	26.5V	26.5V
Voltage ripple	max. 100mV RMS with resistive load @ full power			
Short circuit current (1/4 of I _{max})	15A	20A	12.5A	18.75A
Wire gauge (up to 3 m length)	25 mm ²	35 mm ²	25 mm ²	35 mm ²
Charger fuse (external)	63A	100A	63A	80A
ENVIRONMENTAL				
Ambient temperature	-20 to 40°C @ 100% output power, derated with 2,5% / °C above 40°C			
Cooling	Forced air, by means of a ventilator with variable speed			
Humidity	Maximum 95%RV, non condensing			
MASTERBUS				
MasterBus powering capability	Yes	Yes	Yes	Yes
MasterBus menu languages	English, Dutch, German, French, Spanish, Italian			
ENCLOSURE TYPE				
	C2	C2	C2	C3
Dimensions (hxwxd) mm	See figure 12	See figure 12	See figure 12	See figure 13
Protection degree	IP23	IP23	IP23	IP23
Weight	5 kg	5 kg	5 kg	9 kg

* Adjustable, see chapter 5.

Specifications are subject to change without prior notice.

Model	Mass 24/100 MB	Mass 3-24/100 MB	Mass 48/25 MB	Mass 48/50 MB
Article no.	40021006	40031006	40040256	40040506
INPUT				
Mains voltage	230V, -10% + 15%	3 x 365..550 V**	230V, -10% + 15%	230V, -10% + 15%
Frequency	50-60 Hz ± 5 Hz	50-60 Hz ± 5 Hz	50-60 Hz ± 5 Hz	50-60 Hz ± 5 Hz
Inrush current	None, the battery charger is equipped with a soft start in accordance with IEC 1003-3			
Current	16 A	6.5 A	8 A	16 A
Power factor (Cos phi)	1	0.8	1	1
Efficiency	89%	89%	89%	89%
Input power	3600W	3500W	1800W	3600W
OUTPUT				
Nominal voltage	24V DC	24V DC	48 V DC	48 V DC
Max charge current (I _{max})*	100 A	100 A	25 A	50 A
Outputs	1 x 100 A	1 x 100 A	1x25 A	1x50 A
Charge characteristic*	three-step plus, fully automatic	three-step plus, fully automatic	three-step plus, fully automatic	three-step plus, fully automatic
Battery types:	Flooded lead acid, gel/AGM lead acid, NiCad, Mastervolt MLI (settings: section 7.10)			
Default charge voltages at 25°C				
Absorption voltage*	28.5 V	28.5 V	57 V	57 V
Float voltage*	26.5 V	26.5 V	53 V	53 V
Voltage ripple	max. 100mV RMS with resistive load @ full power			
Short circuit current (1/4 of I _{max})	25 A	25 A	6 A	12.5 A
Cable size (within 3 m)	35 mm ²	35 mm ²	16 mm ²	25 mm ²
Charger fuse (external)	125 A	125 A	32 A	63 A
ENVIRONMENTAL				
Ambient temperature	-20 to 40°C @ 100% output power, derated with 2,5% / °C above 40°C			
Cooling	Forced air, by means of a ventilator with variable speed			
Humidity	Maximum 95%RV, non condensing			
MASTERBUS				
MasterBus powering capability	Yes	Yes	Yes	Yes
MasterBus menu languages	English, Dutch, German, French, Spanish, Italian			
ENCLOSURE TYPE				
	C3	C3	C2	C3
Dimensions (hxwxd) mm	See figure 13	See figure 13	See figure 12	See figure 13
Protection degree	IP23	IP23	IP23	IP23
Weight	9 kg	10 kg	5 kg	9 kg

* Adjustable, see chapter 5.

** for device versions up to J (refer to section 1.4): 3x 365..440 V

Specifications are subject to change without prior notice.

9.2 DIMENSIONS

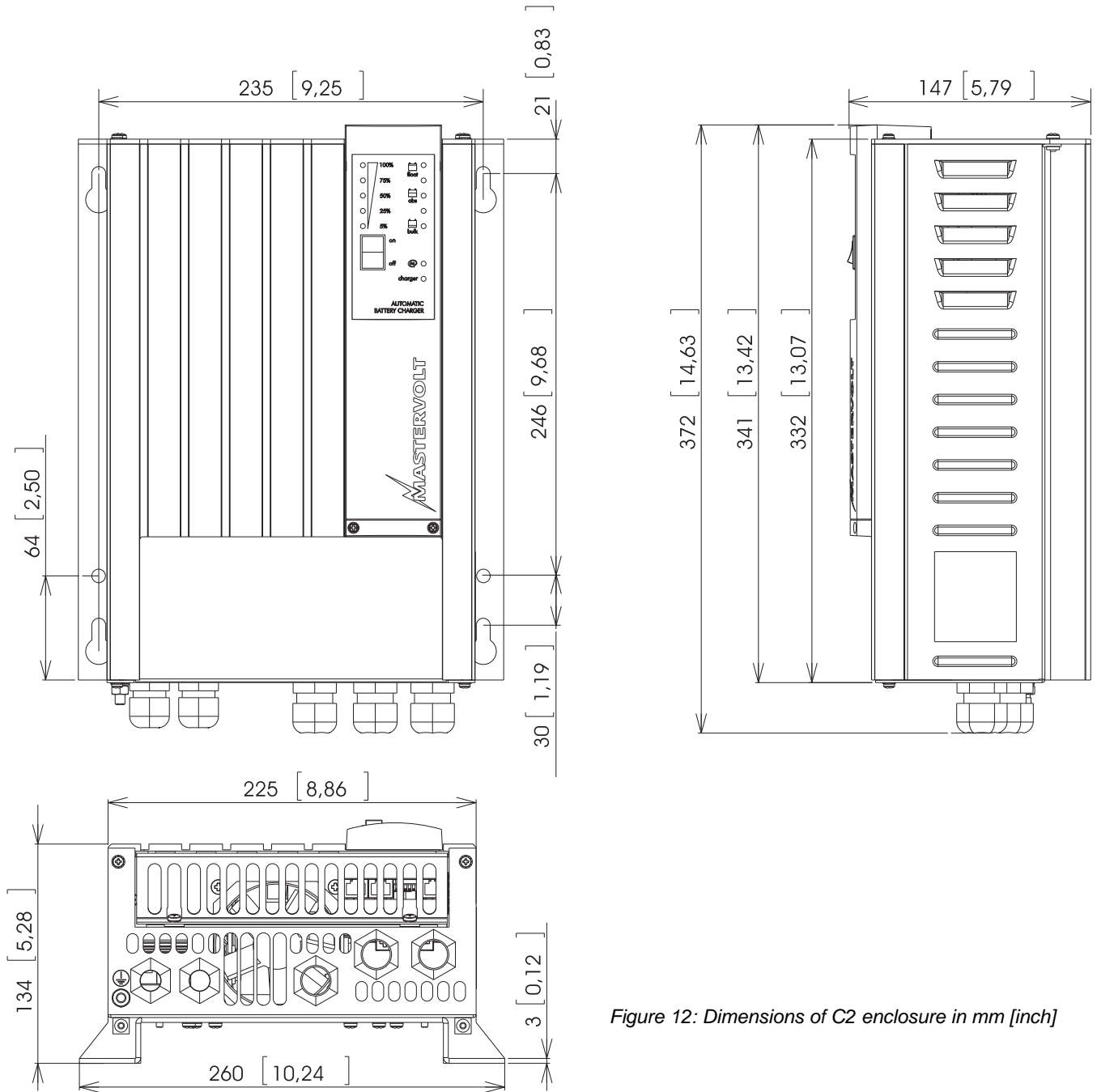

Figure 12: Dimensions of C2 enclosure in mm [inch]

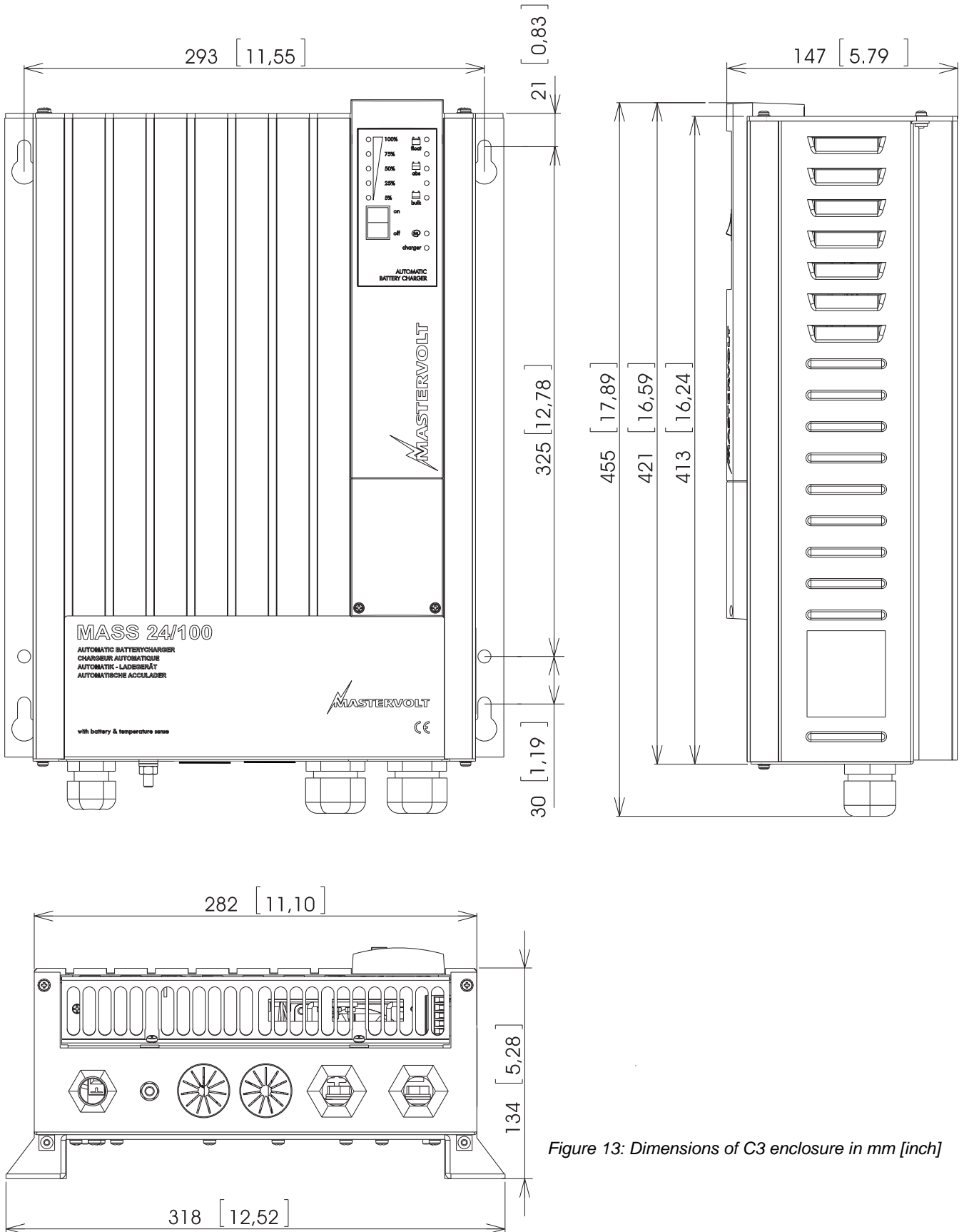
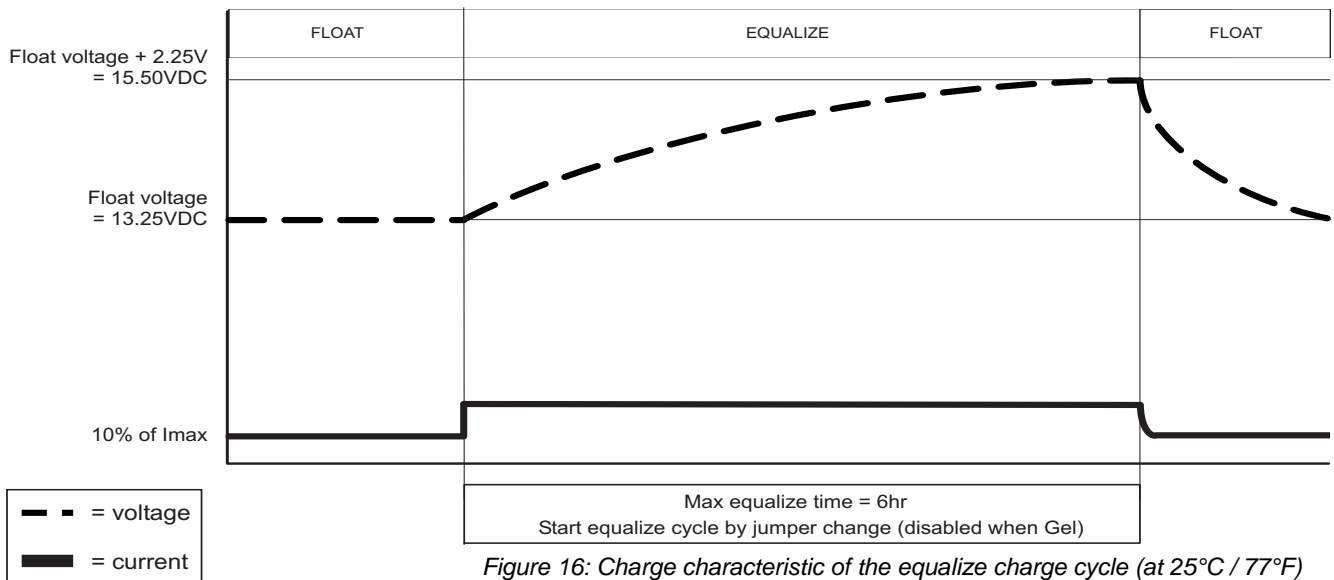
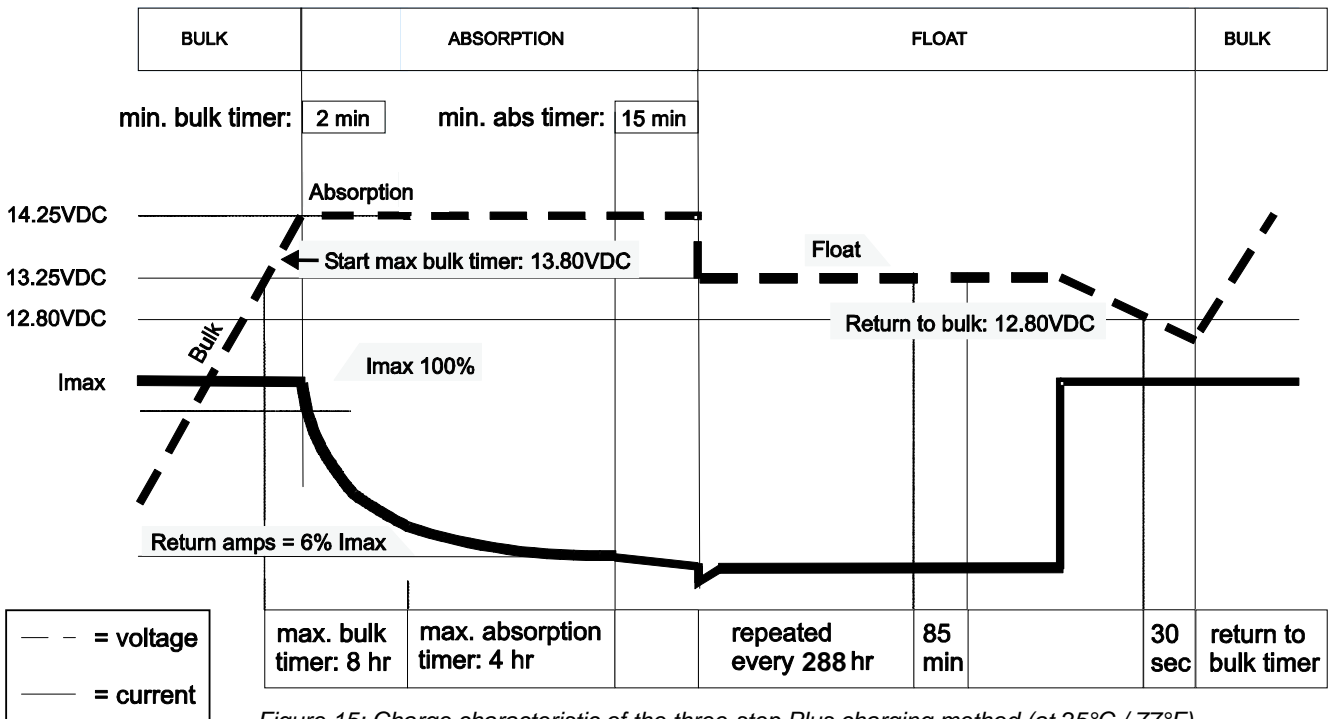
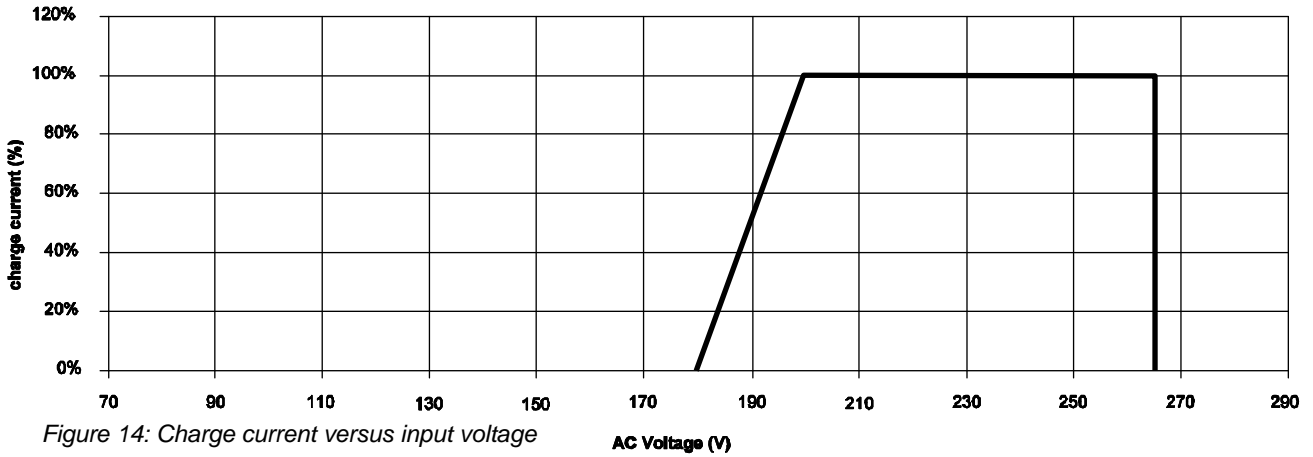

Figure 13: Dimensions of C3 enclosure in mm [inch]

9.3 CHARACTERISTICS (230 V AC)



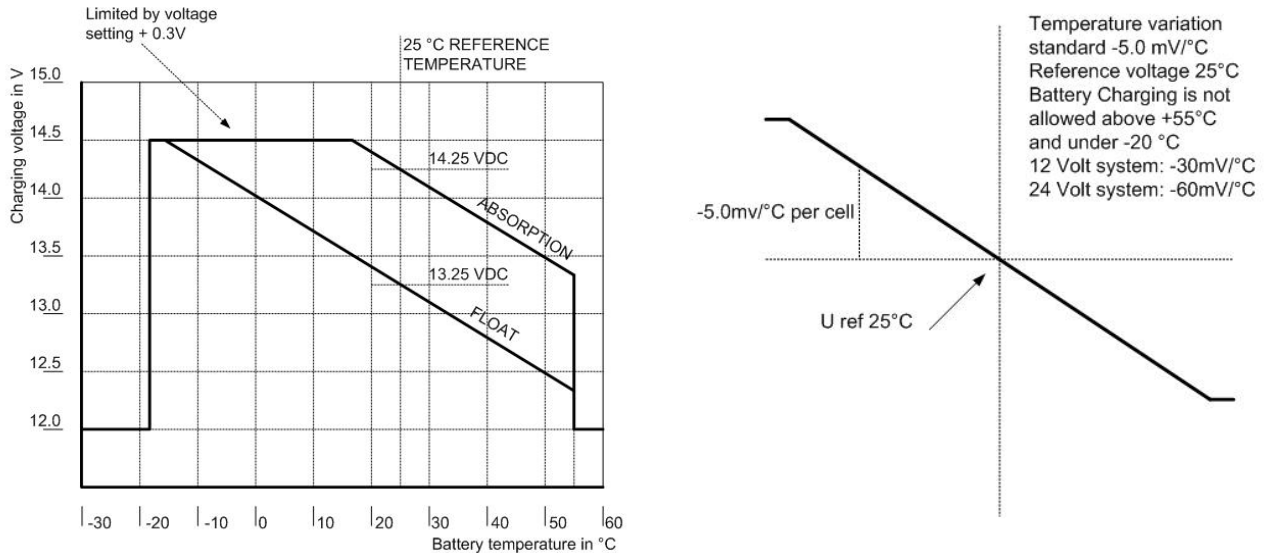

Figure 17: Temperature compensation characteristic (charge voltage versus temperature)

10 ORDERING INFORMATION

Part number	Description
77040000	MasterBus terminating device
77040100	MasterBus connection cable (UTP patch cable), 1,0m / 3.3ft
77040300	MasterBus connection cable, 3.0m / 10ft
77040600	MasterBus connection cable, 6.0m / 20ft
77041000	MasterBus connection cable, 10m / 33ft
77041500	MasterBus connection cable, 15m / 49ft
77042500	MasterBus connection cable, 25m / 82ft
77050100	100m / 330ft MasterBus cable
6502001030	Modular communication cable, cross wired, 6 pole, 6 meter / 19 ft
6502100100	Modular communication cable, cross wired, 6 pole, 10 meter / 33 ft
6502100150	Modular communication cable, cross wired, 6 pole, 15 meter / 49 ft
77050200	50 pcs. modular jacks
77050000	Set to assemble MasterBus cables. Delivery: 100m / 330ft cable, 50 pcs. modular jacks and crimping tool
77030100	MasterBus USB interface, interface between your PC and the MasterBus
77010305	MasterView Easy MkII, Touch screen to control and monitor all MasterBus products
77010400	MasterView System, Full-colour touch screen to control and monitor all MasterBus products
77020100	MasterShunt 500, DC-distribution module for exact readout of battery voltage, charge / discharge current, and state of charge a MasterView monitoring panel. continuous rating: 250A, peak current: 500A
77020200	DC Distribution 500, DC connection device with integrated fuses.
6384003200	Industrial DC fuse 32A DIN 00
6384006300	Industrial DC fuse 63A DIN 00
6384008000	Industrial DC fuse 80A DIN 00
6384010000	Industrial DC fuse 100A DIN 00
6384012500	Industrial DC fuse 125A DIN 00
6381001000	Fuse base DIN 00 (max. 160A)
701	Battery switch 275A
6387000600	Double pole automatic circuit breaker DPN 6A-B, 1P+N
6387001000	Double pole automatic circuit breaker DPN 10A-B, 1P+N
6387001600	Double pole automatic circuit breaker DPN 16A-B, 1P+N
6385401610	Double pole automatic circuit breaker and earth leakage switch DPN VIGI 16A / B / 16mA, 1P + N
41500500*	Battery temperature sensor, incl. 6 meter / 19 ft cable
21730200	RJ12 splitter for C2 enclosure, refer to section 4.11

* standard included with the delivery of the Mass Charger

Mastervolt can offer a wide range of products for your electrical installation.

11 EC DECLARATION OF CONFORMITY



Declare under our sole responsibility that

Product: Mass battery charger
Model: Mass 12/60 MB, 12/80 MB
Mass 24/50 MB, 24/75 MB, 24/100 MB, 3-24/100 MB
Mass 48/24 MB, 48/50 MB

Is in conformity with the provisions of the following EC directives:

2006/95/EC (Safety directive); the following harmonized standards have been applied:

- EN 60950-1:2001+ A11:2004 Safety of Information technology equipment
- EN 60335-2-29: 2004 Safety of household and similar electrical appliances

2004/108/EC (EMC directive); the following harmonized standards have been applied:

- EN 61000-6-3: 2007 Emission for residential, commercial and light-industrial environments
- EN 61000-6-2: 2007 Immunity for industrial environments
- EN 55022: 2006, Class B Information technology equipment - Radio disturbance characteristics
- EN 55024 Information technology equipment - Immunity characteristics
- IEC 61000-3-3 Voltage dip & flicker
- IEC 61000-4-11 Voltage dip & flicker measurement techniques
- IEC 6100-4-2 ESD immunity
- IEC 6100-4-4 Burst and surge
- IEC 6100-4-5 Burst & surge measurement techniques
- IEC 6100-4-3 EMC test and measurement techniques
- IEC 6100-4-6 Conducted disturbance immunity
- IEC 6100-3-2 Limits for harmonic current emissions ≤ 16 A per phase

2011/65/EU (RoHS directive): all serial numbers with device version "N" or higher (refer to section 1.4)

Amsterdam, 21 February 2014

H.A. Poppelier
Product Manager marine & mobile

MASTERVOLT
THE POWER TO BE INDEPENDENT