

Mac Plus

DC-DC CHARGER

12/12-50, 12/24-30, 24/12-50, 24/24-30



USER AND INSTALLATION MANUAL

MASTERVOLT
THE POWER TO BE INDEPENDENT

10000013205/02

Table of Content

1.	INTRODUCTION	4
2.	SAFETY INSTRUCTIONS	4
3.	PRODUCT DESCRIPTION	7
4.	DIMENSIONS	8
5.	FRONT PANEL	9
6.	IDENTIFICATION LABEL	10
7.	INSTALLATION INSTRUCTIONS.....	11
8.	PLACEMENT AND MOUNTING	12
9.	CONNECTION	12
10.	CONFIGURATION.....	15
11.	OPERATION	18
12.	TROUBLE SHOOTING	19
13.	TECHNICAL SPECIFICATIONS	21
14.	MASTERBUS	25
15.	MASTERBUS: CONTROL AND CONFIGURING OF THE MAC PLUS	29

1. Introduction

Most boats, service vans, campers and trucks have service batteries. When a service battery is charged in a traditional way, there can be quite some problems:

- Charging the service battery takes a lot of time.
- The service battery does not charge completely.
- The service battery damages due to peak voltages.

Modern, fuel efficient engines that are equipped with smart alternators made these problems even worse, and so the demand for a solution has grown.

The solution: Mac Plus DC-DC chargers. The Mac Plus monitors the service battery and compensates the cable voltage loss. The proven 3-Step algorithm ensures a quick and safe charge. Moreover, by stabilizing the charge voltage, Mac Plus protects your service battery and sensitive equipment and makes sure it's always fully charged.

2. Safety instructions

READ AND SAVE THESE INSTRUCTIONS



WARNING

This chapter describes important safety and operating instructions for use of a Mac Plus in residential, vehicle (RV) and marine applications.

General

- 1 Before using the Mac Plus, read all instructions and cautionary markings on the Mac Plus, the batteries, and all appropriate sections of the manual.
- 2 To reduce the risk of electric shock – Do not expose Mac Plus to rain, snow, spray, moisture, excessive pollution and condensing circumstances. To reduce risk of fire hazard, do not cover or obstruct the ventilation openings. Do not install the Mac Plus in a poorly ventilated room, this may result in overheating.
- 3 Use of an attachment or spare part not recommended or sold by Mastervolt may result in a risk of fire, electric shock, or injury to persons.
- 4 The Mac Plus is designed to be permanently connected to a DC electrical system. Installation of, and work on the Mac Plus, may be carried out only by a qualified, authorised and trained technician or electrician, consistent with the locally applicable standards and regulations.
- 5 Make sure that all wiring is properly installed and in good electrical condition; and that wire size is large enough for DC ampere rating of the Mac Plus. Check the wiring on a regular base, at

- least once a year. Do not use the Mac Plus when the wiring is undersized or damaged and replace the wiring immediately.
- 6 Do not operate Mac Plus if it has received a sharp blow, been dropped, or otherwise damaged in any way; take it to a qualified service technician.
 - 7 Except for the connection compartment, the Mac Plus may not be opened or disassembled. There are no serviceable parts inside the cabinet. Take it to a qualified, authorized and trained service technician when service or repair is required. Incorrect reassembly may result in a risk of electric shock or fire. Only qualified, electrician installers are authorized to open the connection compartment.
 - 8 To reduce risk of electric shock, disconnect the Mac Plus from the DC electrical system before attempting any maintenance or cleaning. Turning off controls will not reduce this risk.
 - 9 The Mac Plus may not be used by children or by those who cannot read and understand the manual if they are not supervised by a responsible person who can guarantee that the charger is being used in a safe manner. Keep the charger away from children.
 - 10 Short circuiting or reversing polarity will lead to serious damage to batteries, Mac Plus, wiring as well as accessories. Fuses cannot prevent damage caused by reversed polarity and the warranty will be void.
 - 11 In case of fire, you must use the fire extinguisher which is appropriate for electrical equipment.
 - 12 If applied in a marine application in the United States, external connections to the Mac Plus shall comply with the United States Coast Guard Electrical Regulations (33CFR183, Sub part I).

Explosive gases

- 1 **WARNING – RISK OF EXPLOSIVE GASES. WORKING IN VICINITY OF A LEAD-ACID BATTERY IS DANGEROUS. BATTERIES GENERATE EXPLOSIVE GASES DURING NORMAL BATTERY OPERATION. FOR THIS REASON, IT IS OF UTMOST IMPORTANCE THAT EACH TIME BEFORE USING THE MAC PLUS, YOU READ THIS MANUAL AND FOLLOW THE INSTRUCTIONS EXACTLY.**
- 2 To reduce risk of battery explosion, follow these instructions and those published by battery manufacturer and manufacturer of any equipment you intend to use in vicinity of the battery. Review cautionary marking on these products.
- 3 **DANGER:** To reduce the risk of explosion – Never use the Mac Plus in situations where there is danger of gas or dust explosion or area in which ignition-protected equipment is required.

Warnings regarding the use of batteries

- 1 Someone should be within range of your voice or close enough to come to your aid when you work near a battery.
- 2 Have plenty of fresh water and soap nearby in case battery acid contacts skin, clothing, or eyes.
- 3 Wear complete eye protection and clothing protection. Avoid touching eyes while working near battery.
- 4 If battery acid contacts skin or clothing, wash immediately with soap and water. If acid enters eye, immediately flood eye with running cold water for at least 10 minutes and get medical attention immediately.
- 5 NEVER smoke or allow a spark or flame in vicinity of battery or engine.
- 6 Do not short circuit batteries, as this may result in explosion and fire hazard! Be extra cautious to reduce risk of dropping a metal tool onto battery. It might spark or short-circuit battery or other electrical part that may cause explosion.
- 7 Remove personal metal items such as rings, bracelets, necklaces, and watches when working with a battery. A battery can produce a short-circuit current high enough to weld a ring or the like to metal, causing a severe burn.
- 8 Only use Mac Plus for charging a LEAD-ACID or Mastervolt Li-Ion batteries and the supply of users attached to these batteries, in permanent systems. Do not use Mac Plus for charging dry-cell batteries that are commonly used with home appliances. These batteries may burst and cause injury to persons and damage to property.
- 9 NEVER charge a frozen battery.
- 10 Excessive battery discharge and/or high charging voltages can cause serious damage to batteries. Do not exceed the recommended limits of discharge level of your batteries.
- 11 If it is necessary to remove a battery, always remove grounded terminal from battery first. Make sure all accessories are off, so as not to cause an arc.
- 12 Be sure that the area around battery is well ventilated while battery is being charged. Refer to the recommendations of the battery manufacturer.
- 13 Batteries are heavy! It may become a projectile if it is involved in an accident! Ensure adequate and sure mounting and always use suitable handling equipment for transportation.

Warning regarding life support applications

Do not use the Mac Plus for applications in any medical equipment intended for use as a component of a life support system. For this type of use a specific written agreement between the customer and Mastervolt is required.

Guarantee specifications

The correct functioning of this product is subject to warranty.

For making an appeal on warranty you can contact your supplier directly, stating your complaint, application, date of purchase and part number / serial number.

3. Product description

The Mac Plus charger converts a DC (battery) voltage to a regulated DC voltage. It can be used as:

- 1 a 3-Step + battery charger or;
- 2 a stabilized DC power supply.

The Mac Plus can only be used in installations with a negative ground.

For different system voltages the following models are available.

Overview of the Mac Plus models			
Model	Input	Output	Article number
12/12-50	12 V	12 V; 50 A	81205100
12/24-30	12 V	24 V; 30 A	81205300
24/12-50	24 V	12 V; 50 A	81205200
24/24-30	24 V	24 V; 30 A	81205400

4. Dimensions

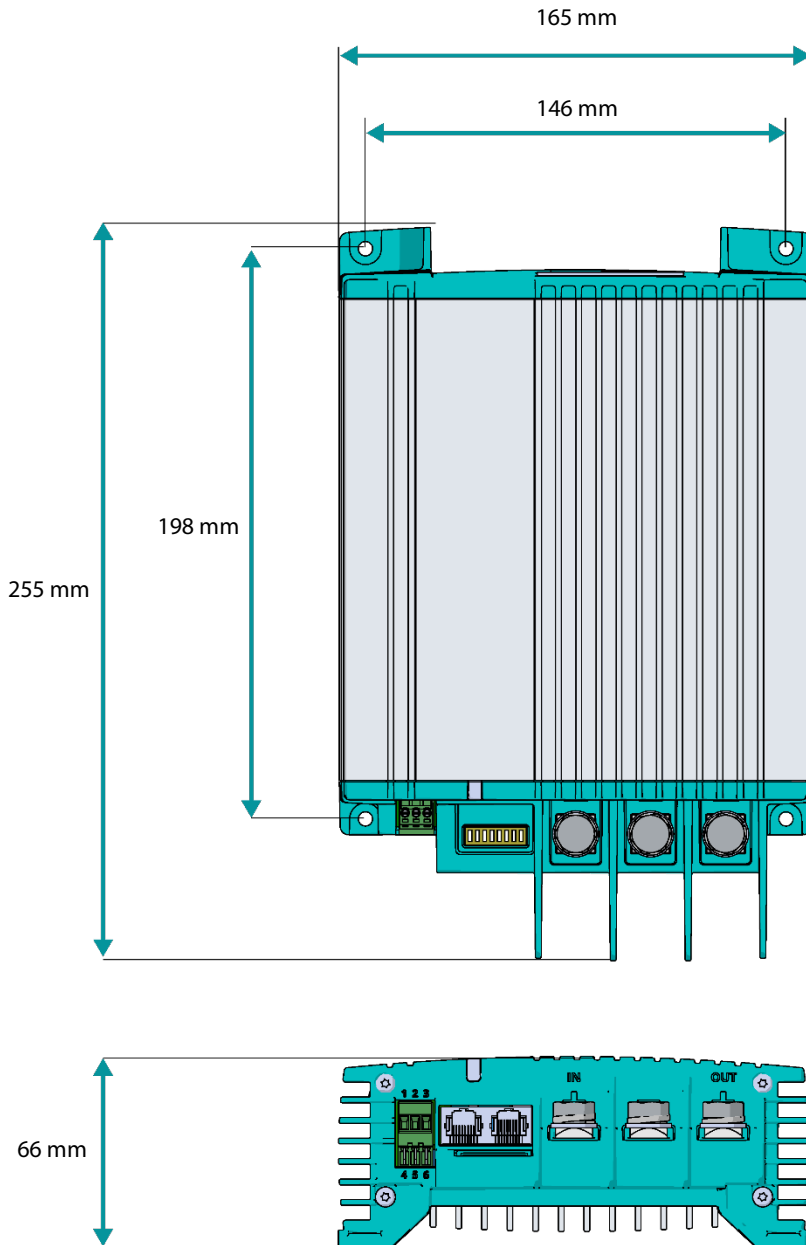

5. Front panel

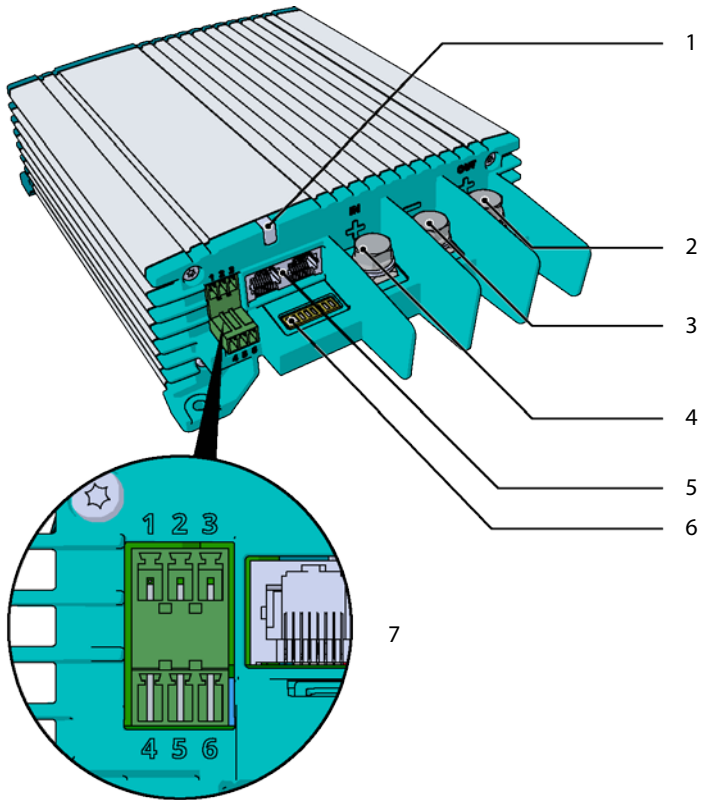

Front panel

- | | |
|---|--|
| 1 | Status LED |
| 2 | + Output |
| 3 | Ground |
| 4 | + Input |
| 5 | MasterBus (2x) |
| 6 | DIP switch |
| 7 | Accessories connector |
| | Pin 1 : + battery voltage sense input |
| | Pin 2 : - battery voltage sense input |
| | Pin 3 : not used |
| | Pin 4 : remote switch input |
| | Pin 5-6 : battery temperature sensor input |

6. Identification label

Identification label

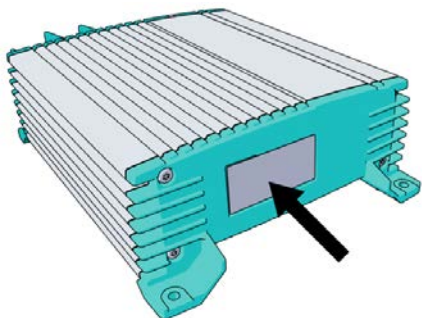

MASTERVOLT		IP23
	Part no: 81205100	
	Type: MAC Plus 12/12-50	
	Input: 12Vdc, 50A dc	CE
Output: 12Vdc, 50A dc		
	Serial no: J821A0001	Designed by Mastervolt Manufactured in PRC
Snijdersbergweg 93, 1105AN, Amsterdam, The Netherlands		

7. Installation instructions

Installation steps:

- 1 Place and mount the Mac Plus
- 2 Connect the Mac Plus
- 3 Configure the Mac Plus

These three steps are described in this chapter.



WARNING!

Read the entire manual before installing the Mac Plus. Keep the manual at a safe location for future reference.

- Install the Mac Plus in a well-ventilated room protected against rain, snow, spray, vapour, bilge, moisture and dust.
- Operating temperature range: -20 up to +60 °C, >40 °C derating power
- Never use the Mac Plus at a location where there is danger of gas or dust explosions.
- Mount the Mac Plus in such a way that obstruction of the airflow through the heatsink is prevented. No objects must be located within a distance of 10 cm / 4 inch around the Mac Plus.
- Do not install the Mac Plus in the same compartment as the batteries. Do not mount the Mac Plus straight above the batteries because of possible corrosive sulphur fumes.
- Be sure that the output of the supplying source is switched off during installation. Also be sure that no consumers are connected to the batteries during installation, to prevent hazardous situations.
- Use cables with an appropriate size, see the table below.

Recommended wire sizes DC input/output

Model	Minimum wire size Input	Minimum wire size Output
12/12-50	16 mm ²	16 mm ²
12/24-30	16 mm ²	10 mm ²
24/12-50	10 mm ²	16 mm ²
24/24-30	10 mm ²	10 mm ²

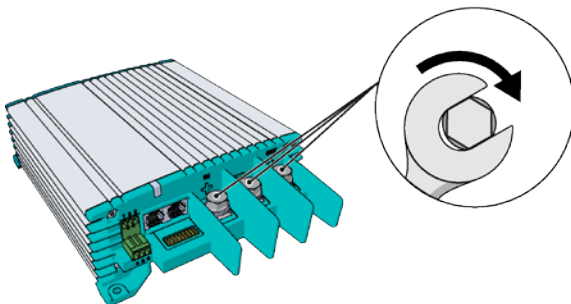

Min. 3 Nm – max. 5 Nm

8. Placement and mounting

Mount the Mac Plus with four screws to a solid flat surface.

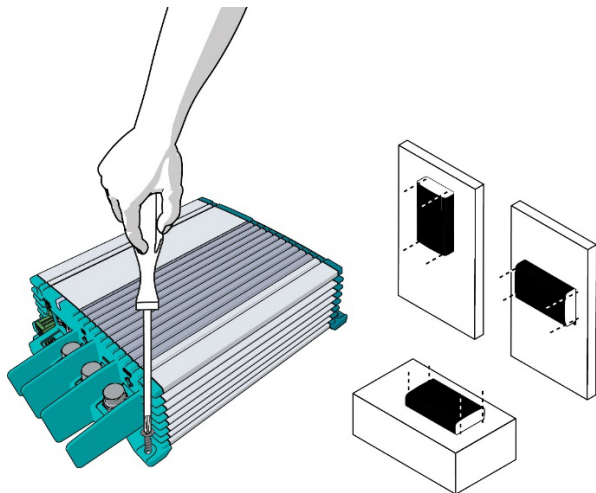

9. Connection

- Mac Plus as a battery charger, see installation drawing A.
- Mac Plus as a stabilized DC power supply, see installation drawing B.

Installation drawing A

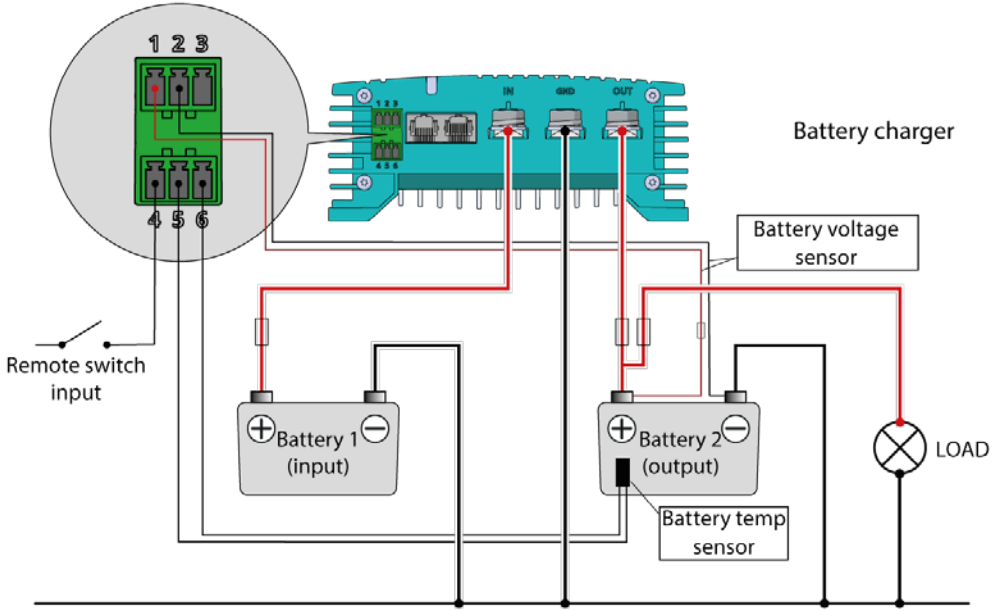

Installation drawing B

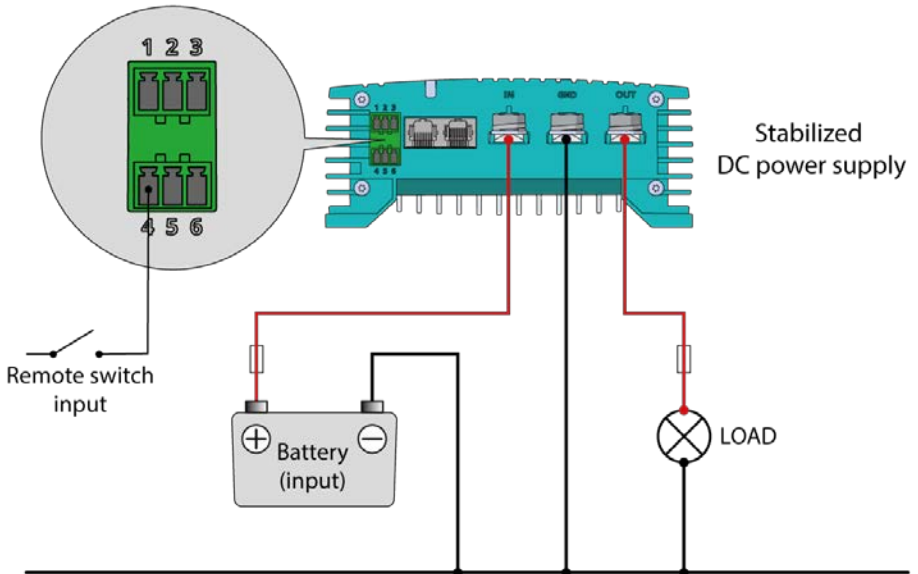

Remote switch input

The remote switch input can be used to enable and disable the battery charger. In a vehicle application it is recommended to connect the engine run signal. Depending on the vehicle the engine run signal can be provided in different ways. For details contact your vehicle distributor.

The remote input can accept two different enable levels:

- active low, connect to ground (between 0 and 0.5 V)
- active high, connect to + battery voltage (between 3 and 32 V)

The remote switch input configuration can be done by DIP switch (see chapter 10) or by MasterBus (see chapter 14 and 15).

Battery temperature sensor (included)

By installing the Mastervolt temperature sensor, the charge voltages are automatically adapted for deviating temperatures.

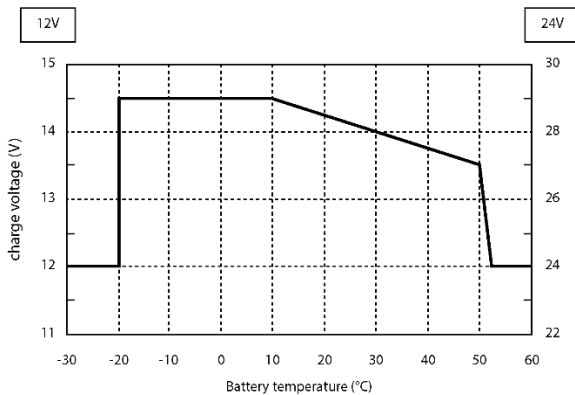

Figure 1. Temperature compensated charging

When the battery temperature is low, the charge voltage increases. In case the battery temperature is high, the charge voltage is decreased. Over charge and gassing are prevented this way. This will extend the life of your battery.

Voltage drop compensation

The Mac Plus is able to compensate the voltage drop occurring over the output cables. For this purpose the MAC PLUS is equipped with terminals for voltage sense wires. Use 0,75 mm², preferably red and black wire and protect these with a 2 A fuses slow blow. Pay good attention to the polarity of the wires.

In order to accurately measure the battery voltage, connect the voltage sense wires as close to the battery poles as possible. The positive and negative voltage sense wires must be connected. Cable losses will be compensated up to a maximum of 2.5 V.

10. Configuration

The Mac Plus settings can be adjusted in two ways:

- By means of DIP switches;
- Via the MasterBus network (by means of a remote control panel or an interface connected to a PC with MasterAdjust software); see chapter 14 and 15.

Once a DIP switch has been set to On, the related setting cannot be configured via MasterBus.

CAUTION!







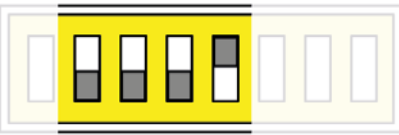
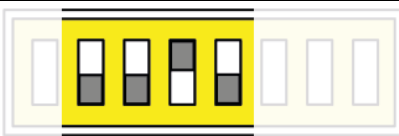
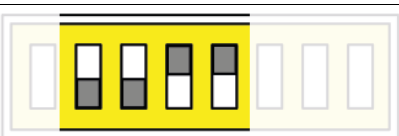
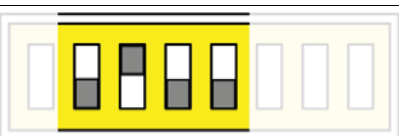
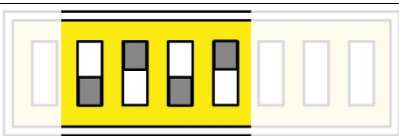
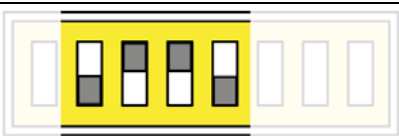

Incorrect settings of the Mac Plus can cause serious damage to your batteries and/or the connected load! Adjustments of settings may be undertaken by authorised personnel only!

For an overview of the various DIP switch settings, please see the following three tables.

MasterBus communication	
	No MasterBus communication in sleep mode (Low no-load consumption 2 mA)
	Always MasterBus communication (No-load consumption < 10 mA)

Charger on conditions	Typical use	
	<p>MasterBus settings apply. See chapter 14 and 15.</p> <p>Default factory setting:</p> <p>Remote switch input 'active high' and input voltage greater than enable voltage setpoint (12.50 V* / 25.00 V**)</p>	<p>Default factory setting:</p> <p>Recommended setting for vehicle with proper engine run signal</p>

 <p>1 0</p>	<p>Always on (Remote switch input not used)</p>	<p>When the battery charger must be always active</p>
 <p>1 0</p>	<p>Remote switch input 'active low'</p>	<p>Enable the battery charger by external operating signal</p>
 <p>1 0</p>	<p>Remote switch input 'active high'</p>	<p>Enable the battery charger by external operating signal</p>
 <p>1 0</p>	<p>Remote switch input 'active low' and input voltage greater than enable voltage setpoint (12.50 V* / 25.00 V**)</p>	<p>Recommended setting for vehicle with proper engine run signal</p>
 <p>1 0</p>	<p>Remote switch input 'active high' and input voltage greater than enable voltage setpoint (12.50 V* / 25.00 V**)</p>	<p>Recommended setting for vehicle with proper engine run signal</p>
 <p>1 0</p>	<p>Input voltage greater than enable voltage setpoint (13.50 V* / 27.00 V**) (Remote switch input not used)</p>	<p>Higher enable voltage setpoint. Setting for vehicle without engine run signal</p>
<p>Any other DIP switch combination</p>	<p>MasterBus settings apply. See chapter 14 and 15.</p>	

Battery*		6 7 8	
1			MasterBus settings apply. See chapter 14 and 15. Default factory setting: Flooded battery
0			Flooded battery Bulk/Abs/Float: 14.25/14.25/13.25 V** 28.50/28.50/26.50 V***
1			Gel Bulk/Abs/Float: 14.25/14.25/13.80 V** 28.50/28.50/27.60 V***
0			AGM Bulk/Abs/Float: 14.25/14.25/13.80 V** 28.50/28.50/27.60 V***
1			Spiral Bulk/Abs/Float: 14.25/14.25/13.80 V** 28.50/28.50/27.60 V***
0			Traction Bulk/Abs/Float: 14.55/14.55/13.25 V** 29.10/29.10/26.50 V***
1			NiCad Bulk/Abs/Float: 14.50/14.50/14.50 V** 29.00/29.00/29.00 V***
0			Constant output voltage 13,25 V*/26,50 V***
			* For Li-Ion see MasterBus settings, chapter 14 and 15 ** 12/12-50 and 24/12-50 ***12/24-30 and 24/24-30

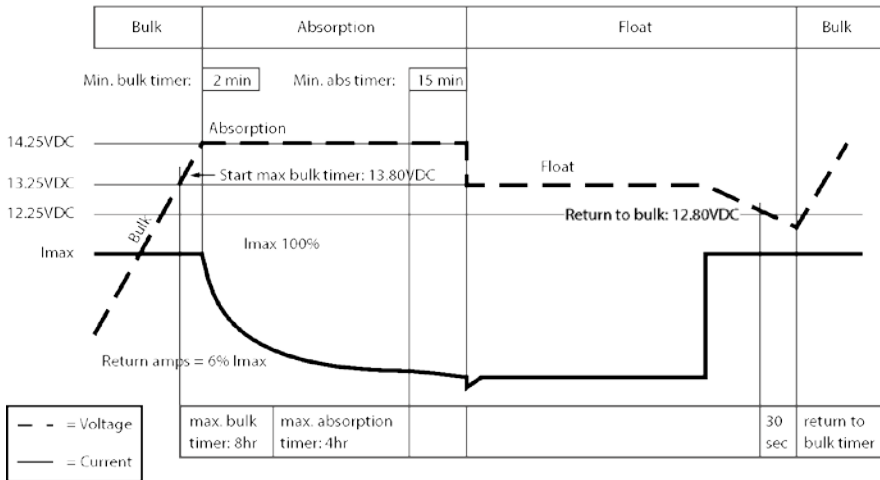

Figure 2. Typical charge characteristic (at 25°C / 77°F). For a 24 V battery charger, multiply the voltages by two.







11. Operation

Battery charger operation modes

Mode	Explanation
Charging	The Mac Plus is in charging mode if it meets the switch-on conditions (see dipswitch/ MasterBus settings)
Standby	The Mac Plus goes to standby when it does not meet the switch-on conditions (see dipswitch/ MasterBus settings)
	Or
	Switched off by the on / off button in the MasterBus menu or by a MasterBus event
Sleep (low no-load power consumption)	The Mac Plus goes to sleep mode when the sleep delay has passed to reduce the no-load power consumption Every 5 seconds, the Mac Plus scans if the configured battery charger meets the switch-on conditions
Alarm	Possible error, connect MasterBus and analyse the situation

LED indicator

Use the following table to understand the meaning of the LED signals.

LED color	LED indication	Meaning	What to do?
Green	 Solid	Charging	Normal operation
Green	 Slow blinking	Software update	Normal operation
Blue	 Solid	Standby	Normal operation
Red-Blue	 Fast blinking	Sleep	Normal operation
Red	 Solid  Slow blinking	Possible error	Connect MasterBus and analyse the situation

12. Trouble shooting

Malfunction	Possible cause	What to do
No output voltage and/or current	No input voltage	Check wiring
	Input voltage too low	Check input voltage, check configuration
	No enable signal on the remote switch input	Check remote switch input
	The primary (input) battery is discharged too far	Charge input battery
LED is red	Check chapter 11 for an overview of fault indications of the LED's.	
Output voltage too low, charger supplies maximum current	Load connected to the batteries is larger than battery charger can supply.	Reduce load taken from the batteries.
	Batteries not 100% charged	Measure battery voltage. After some time this will be higher.
	Wrong setting of the charge voltage	Check settings
Charge current too low	Batteries almost fully charged	Nothing, this is normal when the battery is almost fully charged.

Malfunction	Possible cause	What to do
	High ambient temperature	Nothing; if ambient temperature is more than the setting limit, the charge current is automatically reduced.
Batteries not fully charged	Charge current too low	See "Charge current too low" in this table.
	Current to load is too high	Reduce load taken from the batteries.
	Charge time too short	Use a battery charger with higher capacity.
	Battery temperature too low	Use the battery temperature sensor.
	Defective or old battery	Check battery and replace if necessary.
	Wrong setting of the charge voltage	Check settings
Batteries are discharged too fast	Battery capacity reduced due to wastage or sulphation, stagnation	Charge and recharge a few times, this might help. Check battery and replace if necessary.
	Defective battery (short circuit in cell)	Check battery and replace if necessary.
Batteries are too warm, gassing	Battery temperature too high	Use the battery temperature sensor.
	Charge voltage too high	Check settings
	Error in the MasterBus wiring.	Check the MasterBus cables.
Slow or no MasterBus communication.	No terminating device placed at the ends of the network.	MasterBus needs a terminating device on both ends of the network. Check if connected.
	MasterBus network is configured as a ring network.	Ring networks are not allowed. Check the connections of the network.

13. Technical specifications

	MAC PLUS 12/12-50	MAC PLUS 12/24-30	MAC PLUS 24/12-50	MAC PLUS 24/24-30
Article no.	81205100	81205300	81205200	81205400

Input specifications

Nominal input voltage	12 V	12 V	24 V	24 V
Input voltage range	10-16 V	10-16 V	19-32 V	19-32 V
Max input current	50 A	50 A	30 A	30 A
No load consumption	< 2 mA			

Output specifications

Nominal output voltage	12 V	24 V	12 V	24 V
Output voltage range	10-15 V	20-30 V	10-15 V	20-30 V
Max output current	50 A	30 A	50 A	30 A
Flat battery charge	yes, reduced (25%) charge current at low (<9 V / <18 V) battery voltage			
Protection against overload	yes			
Reverse polarity detection	yes, internally fused, non replaceable			
Charge characteristic	Mastervolt 3-Step algorithm			
Battery types	Flooded, Li-Ion, Gel, AGM, Spiral, Traction NiCad, Constant voltage, User defined			

General specifications

Galvanic insulation	No
Efficiency	> 95% at full output
Protection against over-temperature	Yes
Weight	2 kg
Dimensions, hxxwxd	255x165x66 mm (10.0x6.5x5.6 inch)
Cooling	Natural cooling
IP rating	IP23
Connection in- and output	M8 screw terminal, wire size 10-50 mm ²
MasterBus	Yes (not powering)
Battery temperature sense	Yes, sensor included
Battery voltage sense	Yes, sensor included
Remote switch input	Yes (active high / active low)
DIP switches	Yes, for basic setup
LED	Yes, 3-color LED
Operating temperature range	-20 up to +60 °C, >40 °C derating power
Approvals	CE, E-mark (pending)

Battery settings

Flooded	
Bulk voltage	14.25/28.50 V
Max bulk time	480 min
Min bulk time	120 s
Start bulk time	13.25/26.50 V
Bulk ret. volt.	12.80/25.60 V
Bulk return time	30 s
Abs. voltage	14.25/28.50 V
Max absorp. time	240 min
Min absorp. time	15 min
Return amps	6.0 %*I max
Float voltage	13.25/26.50 V

Gel

Bulk voltage	14.25/28.50 V
Max bulk time	480 min
Min bulk time	120 s
Start bulk time	13.25/26.50 V
Bulk ret. volt.	12.80/25.60 V
Bulk return time	30 s
Abs. voltage	14.25/28.50 V
Max absorp. time	240 min
Min absorp. time	15 min
Return amps	6.0 %*I max
Float voltage	13.80/27.60 V

AGM

Bulk voltage	14.25/28.50 V
Max bulk time	480 min
Min bulk time	120 s
Start bulk time	13.25/26.50 V
Bulk ret. volt.	12.80/25.60 V
Bulk return time	30 s
Abs. voltage	14.25/28.50 V
Max absorp. time	240 min
Min absorp. time	15 min
Return amps	6.0 %*I max
Float voltage	13.80/27.60 V

Spiral

Bulk voltage	14.25/28.50 V
Max bulk time	480 min
Min bulk time	120 s
Start bulk time	13.25/26.50 V
Bulk ret. volt.	12.80/25.60 V
Bulk return time	30 s
Abs. voltage	14.25/28.50 V
Max absorp. time	240 min
Min absorp. time	15 min
Return amps	6.0 %*I max
Float voltage	13.80/27.60 V

Li-Ion

Bulk voltage	14.25/28.50 V
Max bulk time	480 min
Min bulk time	120 s
Start bulk time	13.25/26.50 V
Bulk ret. volt.	13.25/26.50 V
Bulk return time	240 s
Abs. voltage	14.25/28.50 V
Max absorp. time	240 min
Min absorp. time	15 min
Return amps	6.0 %*I max
Float voltage	13.50/27.00 V

Traction

Bulk voltage	14.55/29.10 V
Max bulk time	480 min
Min bulk time	120 s
Start bulk time	13.25/26.50 V
Bulk ret. volt.	12.80/25.60 V
Bulk return time	30 s
Abs. voltage	14.55/29.10 V
Max absorp. time	240 min
Min absorp. time	15 min
Return amps	6.0 %*I max
Float voltage	13.25/26.50 V

NiCad	
Bulk voltage	14.50/29.00 V
Max bulk time	480 min
Min bulk time	120 s
Start bulk time	13.25/26.50 V
Bulk ret. volt.	13.50/27.00 V
Bulk return time	30 s
Abs. voltage	14.50/29.00 V
Max absorp. time	240 min
Min absorp. time	240 min
Return amps	6.0 %*I max
Float voltage	14,50/29.00 V

14. MasterBus

What is MasterBus



All devices that are suitable for MasterBus are marked by the MasterBus symbol

MasterBus is a fully decentralized data network for communication between the different Mastervolt system devices. It is a CAN-bus based communication network which has proven itself as a reliable bus-system in automotive applications. MasterBus is used as power management system for all connected devices, such as the inverter, battery charger, generator and many more. This gives the possibility for communication between the connected devices, for instance to start the generator when the batteries are low.

MasterBus reduces complexity of electrical systems by using UTP patch cables. All system components are simply chained together. Therefore each device is equipped with two MasterBus data ports. When two or more devices are connected to each other through these data ports, they form a local data network, called the MasterBus. The results are a reduction of material costs as only a few electrical cables are needed and less installation time.

For central monitoring and control of the connected devices Mastervolt offers a wide range of panels which show full status information of your electrical system at a glance and a push of a button. Four different panels are available, from the small Mastervision compatible 120 x 65 mm LCD screen up to the full colour EasyView 5. All panels can be used for monitoring, control and configuration of all connected MasterBus equipment.

New devices can be added to the existing network in a very easy way by just extending the network. This gives the MasterBus network a high degree of flexibility for extended system configuration, not only today, but in the future as well!

Mastervolt also offers several interfaces, making even non-MasterBus devices suitable to operate in the MasterBus network.

How to set up a MasterBus network

Each device that is suitable for the MasterBus network is equipped with two data ports. When two or more devices are connected to each other through these ports, they form a local data network, called the MasterBus.

Keep the following rules in mind:

Connections between the devices are made by standard straight UTP patch cables. Mastervolt can supply these cables. These cables are also commonly available at computer supply stores.

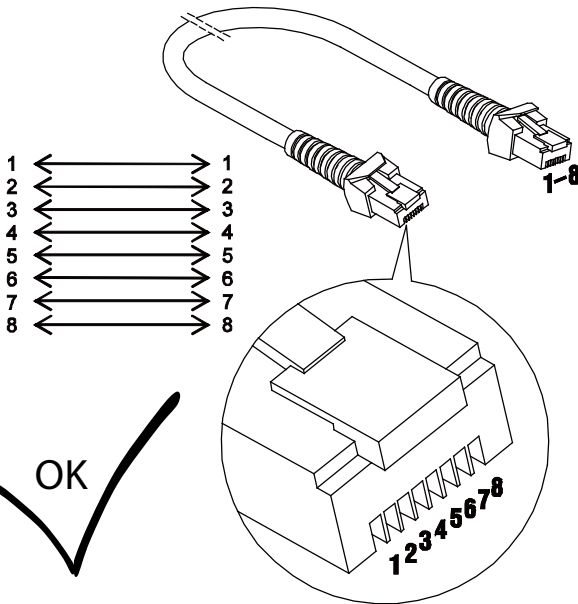

As with all high speed data networks, MasterBus needs a terminating device on both ends of the network.

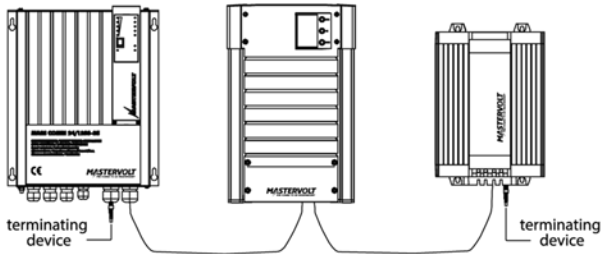

The electric power for the network comes from the connected devices.
At least one device in the network should have powering capabilities (see specifications).
One powering device can power up to three non-powering devices.
As all powering devices are galvanically isolated, multiple powering devices are allowed.

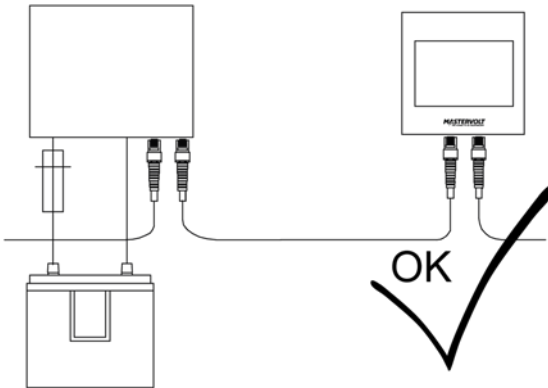

Do not make ring networks.

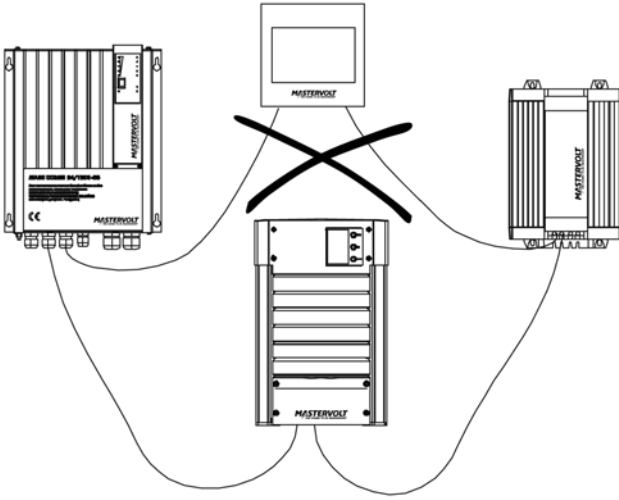

Do not make T-connections in the network.

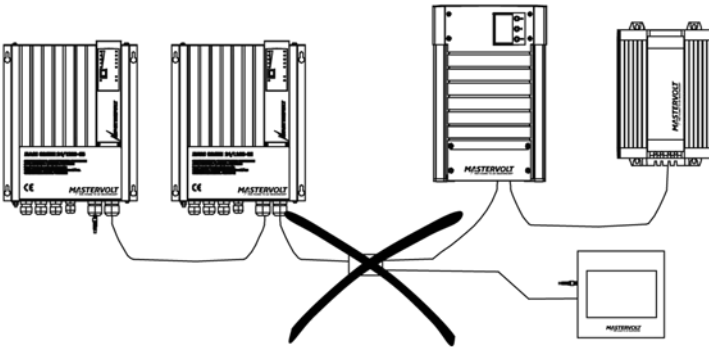

15. MasterBus: Control and Configuring of the Mac Plus

Monitoring

Value	Meaning	Default	Adjustable range
Status			
Device state	Shows the actual operation mode: Standby / Charging / Alarm / Off		(read only)
Charge state	State of charge algorithm: Off / Bulk / Absorption / Float / Constant voltage		(read only)
Standby	Button to toggle the device state. Note: in the standby mode, the Mac Plus can be switched on again automatically. This happens, for example, after a restart.	On	On, Off
General			
Input voltage	Voltage at the input		(read only)
Input current	Current of the input		(read only)
Output voltage	Voltage at the output		(read only)
Output current	Current of the output		(read only)
Bat. volt sense	Battery voltage measured by the battery voltage sensor. If the Shunt device function is enabled for a MasterShunt (MSH) or a MLI-Ultra (BAT): voltage measured by the MasterShunt / MLI-Ultra.		(read only)
Remote sw. input	Remote input signal detected. Only applicable when Remote input mode is active low or active high configured.		(read only)
Temperatures			
Device	Device temperature		(read only)
Battery	Actual battery temperature measured by the Battery temperature sensor. If no battery temperature sensor is used or when Battery is set to "Li-Ion": "---" is shown. If the Shunt device function is enabled for a MasterShunt (MSH): Battery temperature measured by the MasterShunt is shown (available in upcoming software update).		(read only)

Alarm

Value	Meaning
Alarm status	
Temperature high	Internal temperature is too high
Bat. temp. high	Battery temperature is too high (> 55 °C)
Bat. temp. low	Battery temperature is too low (< -20 °C)
Input high	Input voltage is too high
Input low	Input voltage is too low
Output high	Output voltage is too high
Output low	Output voltage is too low
OVP/OCP	Over Voltage Protection or Over Current Protection shutdown
HW fault	Internal hardware error
Cable loss high	Cable loss is too high (>2.5 V)
Shunt mismatch (available in upcoming software update)	Setting for nominal voltage (12 or 24 V) at the MasterShunt or the nominal voltage of the MLI Ultra battery differs from nominal output voltage of the Mac Plus, Check battery voltage and settings of the MasterShunt or voltage of the MLI-Ultra battery.

Configuration

Value	Meaning	Factory setting	Adjustable range
Device			
Language (available in upcoming software update)	Language that is displayed on a monitoring device connected to the MasterBus	English	EN, NL, DE, FR, ES, IT, NO, SV, FI, DA
Name	Device name (user defined). The device will be represented by this name throughout the MasterBus network.	Plus 12/12 Plus 12/24 Plus 24/12 Plus 24/24	0-12 chars
Back to default	Button to reset the Mac Plus to default settings	Off	On, Off

Value	Meaning	Factory setting	Adjustable range
Remote sw. input			
Mode	Active low: active if voltage between 0-0.5 V, Active high: active if voltage between 3-32 V, Not used: always active	Active high	Not used, Active low, Active high
Input threshold			
Enabled	Enabled: input voltage thresholds are active Disabled: input voltage thresholds are not active	Enabled	Enabled, Disabled
Enable voltage	Enable input voltage	12.50 / 25.00 V	8-16 / 16-32 V
Enable delay	Enable delay	2 s	0-300 s
Disable voltage	Disable input voltage	12.00 / 24.00 V	8-16 / 16-32 V
Disable delay	Disable delay	300 s	0-300 s
Instant disable	Disable input voltage, no delay	11.00 V	8-16 / 16-32 V
Sleep delay	Delay before the Mac Plus switches to sleepmode	300 s	0-3600 s
Charger			
Battery type	Selection of pre-set charge algorithm. Individual adjustments are only possible if "User defined" is selected here.	Flooded	Flooded, Gel, AGM, Spiral, Li-Ion, Traction, NiCad, Constant voltage, User defined,
Max output	Maximum output (charge) current	50 A 30 A	0-50 A 0-30 A
Max input	Maximum input current	50 A 30 A	0-50 A 0-30 A
Current ramp up	Charge current ramp up after enabling the charger.	5 A/s	0-50 A/s
Temp. compensate	Temperature compensation for charge voltage	-0.030 V/°C -0.060 V/°C	-0.1 - +0.1 V
Shunt			
Shunt device (available in upcoming software update)	Selection of the shunt device to which the Mac Plus is connected. This can either be a	No connection	No connection, MSH+Product Name,

MasterShunt (MSH) or a MLI-Ultra battery (BAT). Enabling this function allows

to: - Compensate the charge voltage for cable losses - Adjust the actual Charge state based on the state of charge of the battery - Compensate the charge voltage for deviating battery temperatures (MasterShunt only)

BAT+Product
Name

Bulk			
Bulk voltage	Bulk voltage	14.25 / 28.50 V	8-15 / 16-30 V
Max. bulk time	Maximum bulk time	480 min	0-1440 min
Min. bulk time	Minimum bulk time	120 s	0-240 s
Start bulk time	Start bulk timer	13.25 V	8-15 / 16-30 V
Bulk ret. volt	Return to bulk voltage	12.80 / 25.60 V	8-15 / 16-30 V
Bulk return time	Return to bulk time delay	30 s	0-240 s
Absorption			
Abs. voltage	Absorption voltage	14.25 / 28.50 V	8-15 / 16-30 V
Max absorp. time	Maximum absorption time	240 min	0-1440 min
Min absorp. time	Minimum absorption time	15 min	0-240 min
Return amps	Return amps (% of maximum charge current)	6 %	0-50 %
Float			
Float voltage	Float voltage	13.25 / 26,50 V	8-15 / 16-30 V
Constant voltage			
Constant voltage	Constant output voltage	13.25 / 26.50 V	8-15 / 16-30 V
Input alarm			
High alarm on	High input voltage alarm on	16.00 / 32.00 V	8-16 / 16-32 V
High alarm off	High input voltage alarm off	15.50 / 31.00 V	8-16 / 16-32 V
Low alarm off	Low input voltage alarm off	11.00 / 22.00 V	8-16 / 16-32 V
Low alarm on	Low input voltage alarm on	10.00 / 20.00 V	8-16 / 16-32 V
Low alarm delay	Low input alarm delay time	5 s	0-300 s

Value	Meaning	Factory setting	Adjustable range
Output alarm			
High alarm on	High output voltage alarm on	15.25 / 30.50 V	8-16 / 16-32 V
High alarm off	High output voltage alarm off	14.75 / 29.50 V	8-16 / 16-32 V
Low alarm off	High output voltage alarm off	11.00 / 22.00 V	8-16 / 16-32 V
Low alarm on	High output voltage alarm on	10.00 / 20.00 V	8-16 / 16-32 V
Low alarm delay	Low output alarm delay time	30 s	0-300 s
DIP switch			
12345678	DIP switch state 0=off, 1=on	0	0,1
Event source			
(available in upcoming software update)	Description		
Off	Device state is Off		
Standby	Device state is Standby		
Charging	Device state is Charging		
Error	Device state is Error		
Bulk	State of charge is Bulk		
Absorption	State of charge is Absorption		
Float	State of charge is Float		
Any alarm	Any of the alarms is triggered		
Event command			
Description			
Standby	Command to switch on/off the Mac Plus. If the Mac Plus was switched off by means of this event command, it will switch on again when it come out of sleep mode.		
Bulk			
(available in upcoming software update)	Command to start the Bulk state of charge		
Absorption			
(available in upcoming software update)	Command to start the Absorption state of charge		
Float			
(available in upcoming software update)	Command to start the Float state of charge		