

MASTERVOLT

USERS MANUAL

MAGIC

12/12-20, 12/24-10 24/12-20, 24/24-20

DC-DC converter



CE

10000002796/03

Copyright © 2018 Mastervolt

Product description

The DC-DC converter MAGIC converts a DC-voltage into another stabilized DC-voltage with a full galvanic isolation between the input and output.

Applications

It offers you the following applications (see drawings "INSTALLATION"):

MAGIC 24/12-20A (part no. 81300100)

- *Drawing 1A, 1B:* a stabilized 13.6V DC power supply / single stage float charger (e.g. to supply 12V equipment from a 24V system), or
- *Drawing 2A, 2B:* a three-stage battery charger to charge a 12V battery from a 24V system fully automatically, or
- *Drawing 3A, 3B:* a 24/36 converter *without* galvanic isolation, where the input is connected in series with output.
- *Drawing 4:* a dimmer for 12V lights

MAGIC 24/24-20A (part no. 81300200)

- *Drawing 1A, 1B:* a 27.2VDC stabilized DC power supply / single stage float charger (e.g. for a galvanic isolation of the vehicle's electrical system)
- *Drawing 2A, 2B:* a three-stage battery charger to charge a 24V battery from a 24V system fully automatically, or
- *Drawing 3A, 3B:* a 24/48V converter *without* galvanic isolation, where the input is connected in series with output.
- *Drawing 4:* a dimmer for 24V lights

MAGIC 12/12-20A (part no. 81300400)

- *Drawing 1A, 1B:* a 13.6VDC stabilized DC power supply / single stage float charger (e.g. for a galvanic isolation of the vehicle's electrical system)
- *Drawing 2A, 2B:* a three-stage battery charger to charge a 12V battery from a 12V system fully automatically or
- *Drawing 4:* a dimmer for 12V lights.

MAGIC 12/24-10A (part no. 81300300)

- *Drawing 1A, 1B:* a 27.2V stabilized DC power supply / single stage float charger (e.g. for a galvanic isolation of the 24V system), or
- *Drawing 2A, 2B:* a three-stage battery charger to charge a 24V battery from a 12V system fully automatically, or
- *Drawing 3A, 3B:* a 12/36V converter *without* galvanic isolation, where the input is connected in series with output.

Safety regulations and measures

1. Install the converter according to the stated instructions.
2. Never use the converter at a location where there is danger of gas or dust explosions.
3. Connections and safety features must be executed according to the locally applicable regulations.
4. The converter may only be taken into operation while the cover is closed as lethal voltages may exist.

The converter is provided with a non-replaceable input fuse. If the plus and minus connections on the battery are exchanged, the converter will become irreparable. Do not use fuses larger than those indicated in the specifications.

Installation

- Be sure that the output of the supplying source is switched off during installation. Also be sure that no consumers are connected to the batteries during installation, to prevent hazardous situations.
- Check that the battery voltage is the same as the converter's input voltage (e.g. 24V battery for a 24V input voltage). Also check that the output voltage satisfies loading requirements
- Due to possible moisture accumulation and optimal heat discharge, the converter must be installed in a well-ventilated room protected against rain, vapour, moisture and dust. We advise to mount the unit in a vertical position with the connecting cables downward.
- Integrate a fuse in the positive wiring and place it nearby the battery. See specifications for the recommended fuse.
- Do not install the DC-DC converter straight above the batteries because of possible corrosive sulphur fumes.

Settings

There is no need to change the settings if the converter is used as a stabilized DC power supply. Inside the converter four DIP switches can be found to adjust the converter according to your personal preferences. (see table "DIP SWITCH SETTINGS").

To adjust the DIP switches, proceed as follows:

1. Be sure the converter is disconnected from any power source;
2. Remove the back cover of the converter by loosen the four screws (see drawing "DIMENSIONS");
3. Use a small flat-blade screw driver to change the DIP-settings;
4. Remount the back cover again.

When more converters are paralleled to increase the total output current, DIP-switches 1, 2 and 4 must be set to the "OFF"-position and DIP-switch 3 depended to the preferred output voltage.

Connections

For correct connection - see drawings "INSTALLATION".

- Use reliable cord end terminals to fix the wires to the DC-input and -output.
- See specifications for the recommended wire size.
- To minimize any EMC-interference we advise to connect the negative pole of the supplying battery to the ground.



Connect a momentary switch between the "switch"-connection and the DC-output ground if you want to use the remote switch function and/or the light dimmer function (see drawing 1B, 2B, 3B).

Alarm contact

The alarm contact, right side connection on the back (see drawings "DIMENSIONS"), is connected to the contact. The contact is activated and connected to the output ground in a normal situation, and will be deactivated if the input voltage is too low (default 10.0V or 20.0V), if the input voltage is too high (default 16.0V or 32.0V), in case of overload or short-circuit. The contact is also deactivated when the MAGIC is switched off.

Operation

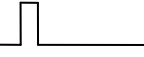
The converter operates automatically. Under normal circumstances, there is no need for operation. Despite its low no-load consumption, the converter should be disconnected from the supplying battery when it is not in use to protect the battery from discharging. Refer to table "SWITCH OPERATION" for explanation of the remote switch function / dimmer operation.

SWITCH OPERATION		
	Short	Converter switches off. Press again to switch on.
	Long	After 1 sec. the output voltage slowly decreases to 4V or 8V. Press again to increase the voltage

Extended functions

Via the "QRS232 communication port" various settings can be adjusted in terms of software to your specific demands (control software and interface not included). Please mind that this plug is not intended for connecting any remote panels or a battery temperature sensor.

Battery charger

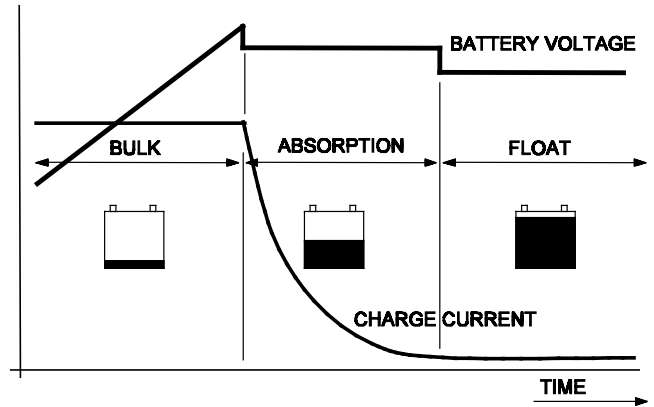

Three-stage charge curve: Stage A: BULK, for quick charging from 0 to 80%, Stage B: ABSORPTION, the battery is charged from 80 to 100%. Stage C: FLOAT, battery is maintained in fully charged state.

Guarantee terms

Mastervolt guarantees that this converter was built according to the legally applicable standards and stipulations. During production and before delivery all converters were exhaustively tested and controlled. If you fail to act in accordance with the regulations, instructions and stipulations in this user's manual, damage can occur and/or the converter will not fulfil the specifications. This may mean that the guarantee will become null and void.

The guarantee period is 2 years.

Liability

Mastervolt cannot be held liable for:

- Consequential damage resulting from the use of the converter.
- Possible errors in the included manual and the consequences of these.
- Use that is inconsistent with the purpose of the product

INSTALLATION 1A: STABILIZED VOLTAGE SUPPLY

DIP switch setting:

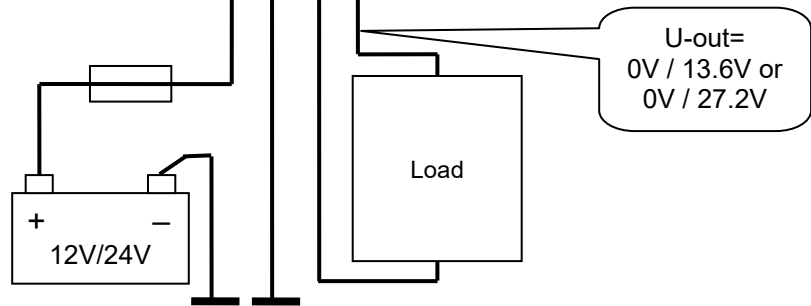
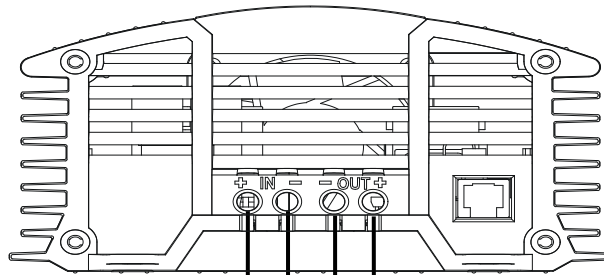
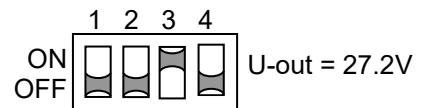
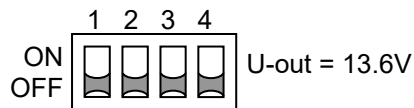

- Stabilized DC-power supply / single stage charger

INSTALLATION 1B: STABILIZED VOLTAGE SUPPLY WITH REMOTE SWITCH

DIP switch setting:

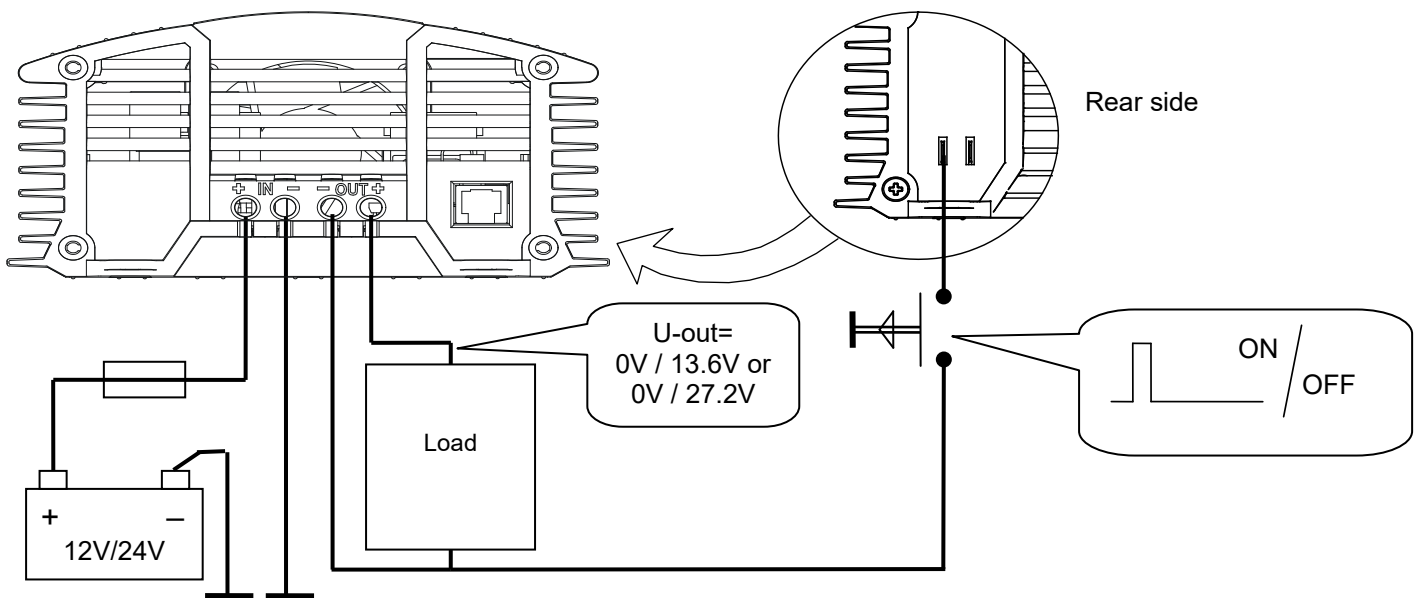
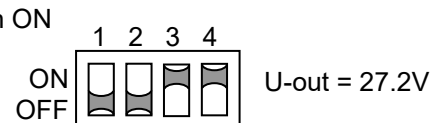
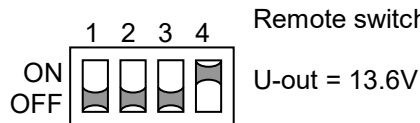

- Stabilized DC power supply with remote switch function

INSTALLATION 2A: 3-STEP BATTERY CHARGER

DIP switch setting: 3 stage charger.

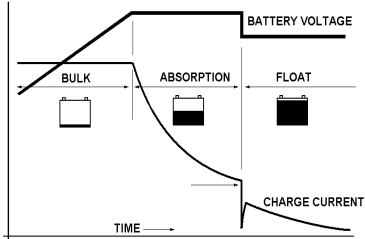
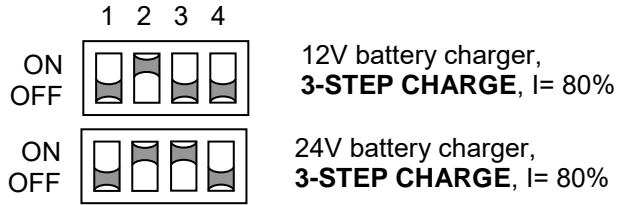

- Automatic **3-step** battery charger

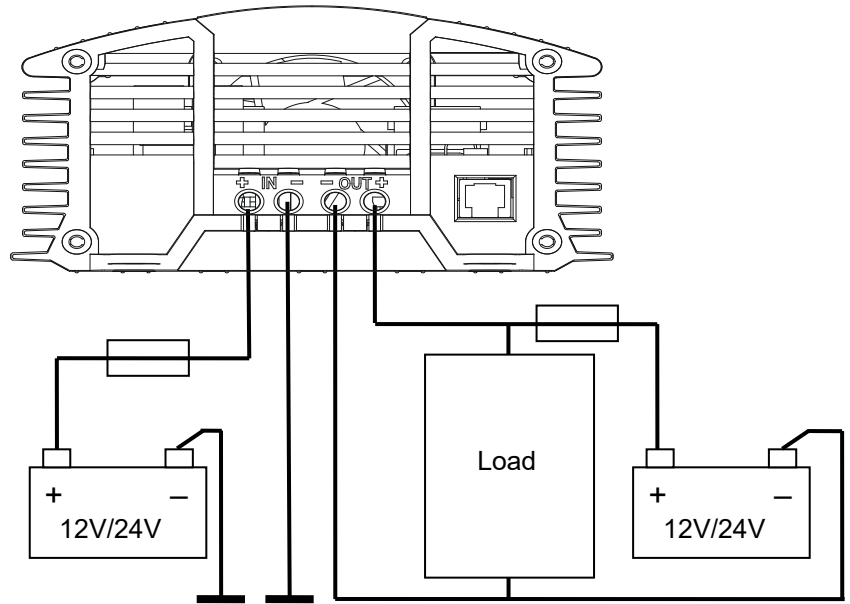

INSTALLATION 2B: 3-STEP BATTERY CHARGER WITH REMOTE SWITCH



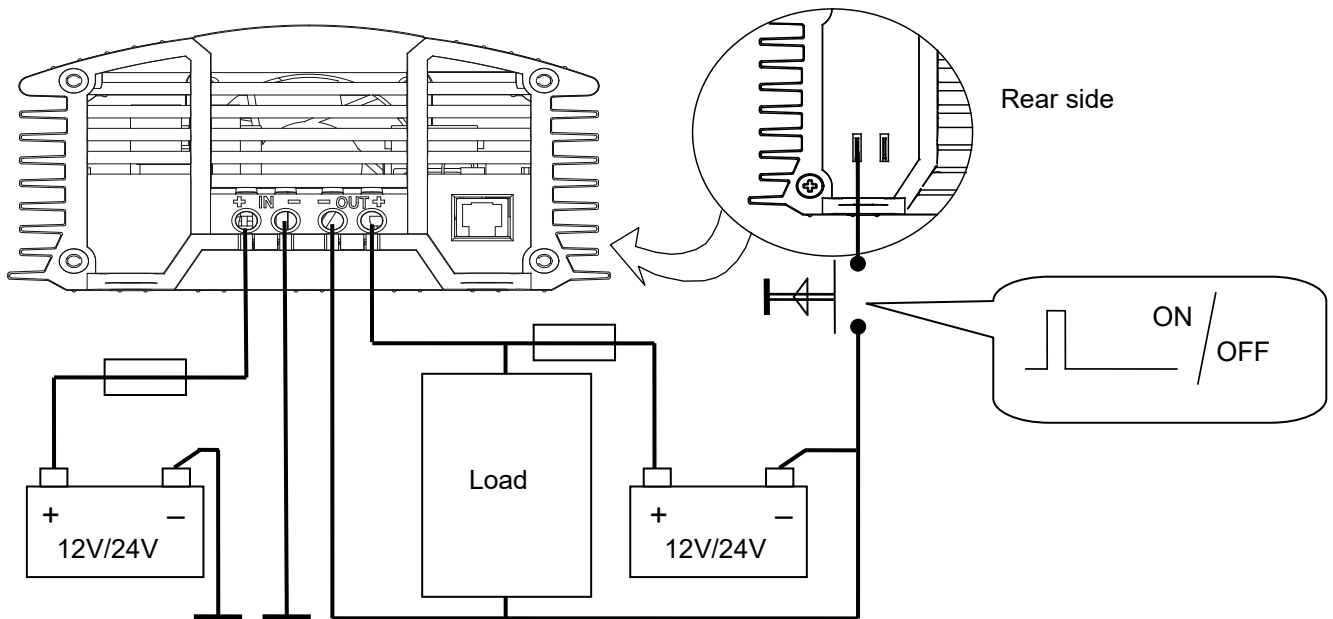
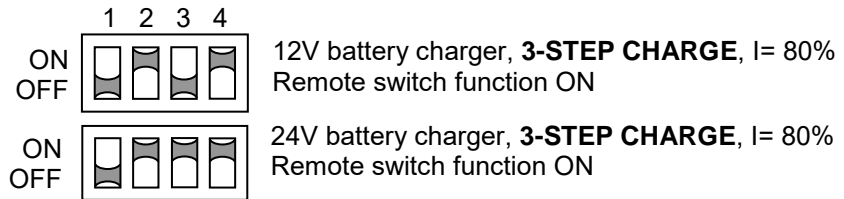

DIP switch setting:

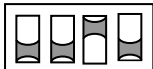
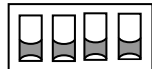
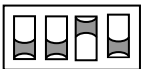

- Automatic **3-step** battery charger with remote switch function

INSTALLATION 3A: 12/36, 24/36 OR 24/48 CONVERTER

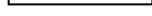
DIP switch setting:



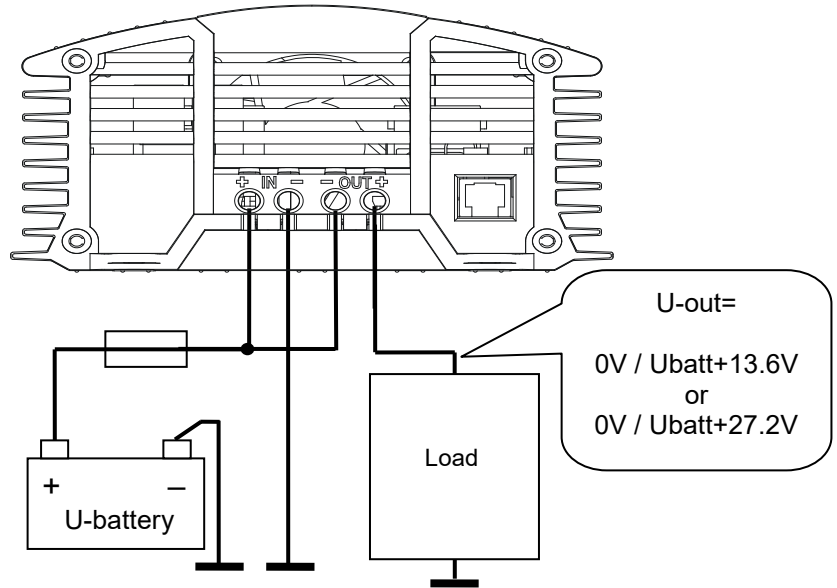

Model	MAGIC 12/24-10	MAGIC 24/12-20	MAGIC 24/24-20
U-battery	12V	24V	24V
U-out	U-battery + 27.2V	U-battery + 13.6V	U-battery + 27.2V
I-out	10A	20A	20A
ON			
OFF			

- A 12/36, 24/36 or 24/48V converter without galvanic isolation.

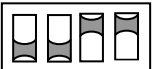
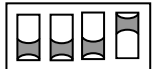
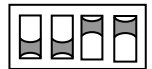

INSTALLATION 3B: 12/36, 24/36 OR 24/48 CONVERTER WITH REMOTE SWITCH

DIP switch setting:

Model	MAGIC 12/24-10	MAGIC 24/12-20	MAGIC 24/24-20
U-battery	12V	24V	24V
U-out	U-battery + 27.2V	U-battery + 13.6V	U-battery + 27.2V
I-out	10A	20A	20A
ON			
OFF			

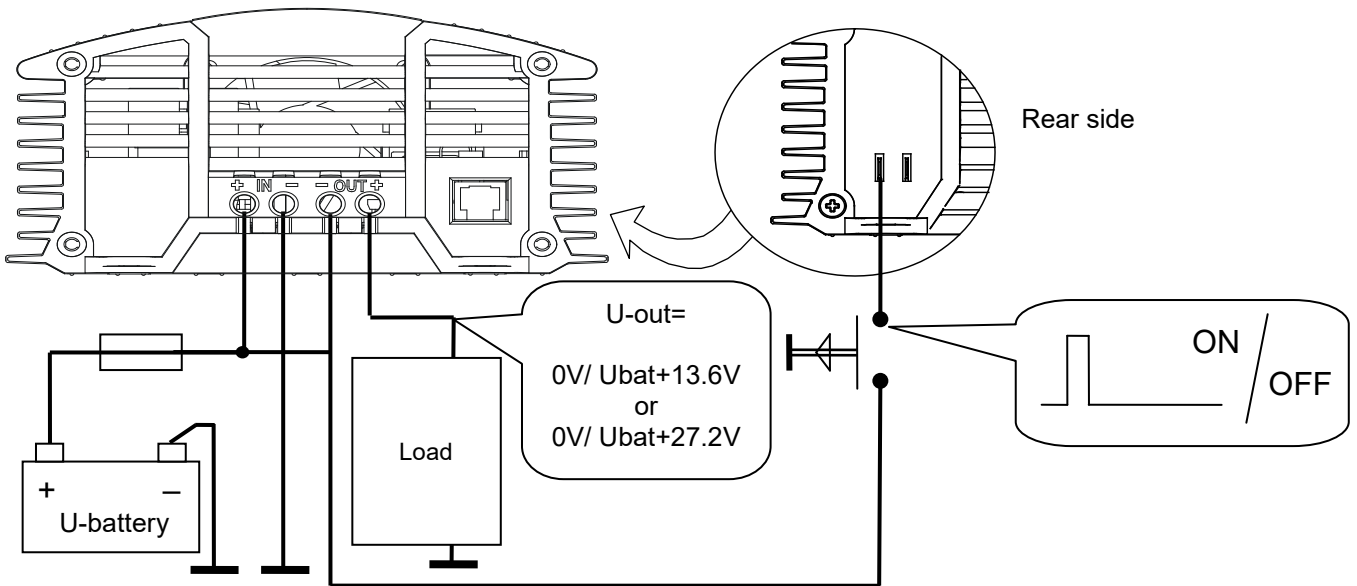

- A 12/36, 24/36 or 24/48V converter without galvanic insulation with remote switch function

INSTALLATION 4: DIMMER

DIP switch setting:

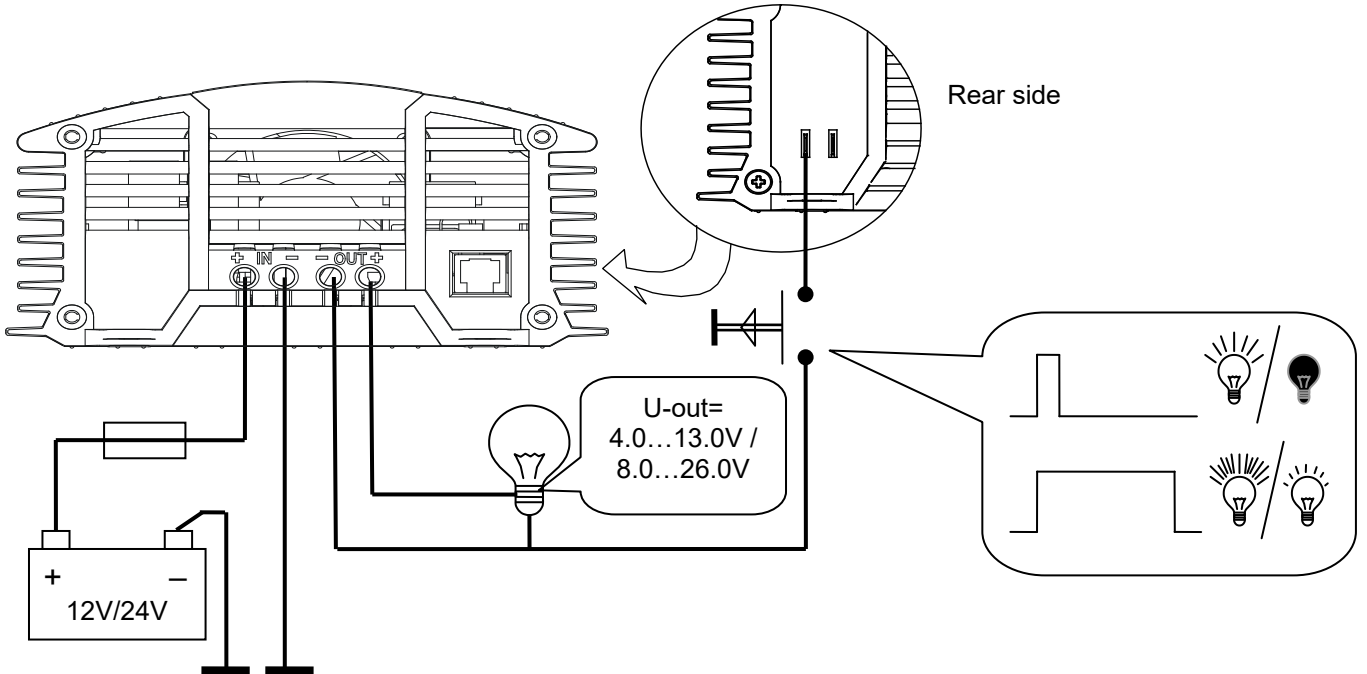
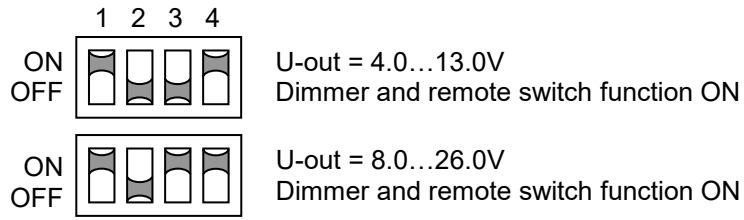

Dimmer configuration for 12 or 24V halogen lights with remote switch function

DIP SWITCH SETTINGS

#	1 Activate → ON	2 Activate → ON	3 12V → OFF 24V → ON	4 Activate → ON
Function	Dimmer function	3-step charge mode	Output voltage 13.6V / 27.2V	Remote switch

DIMENSIONS

- Remove the back cover to change the DIP-switches (see text)

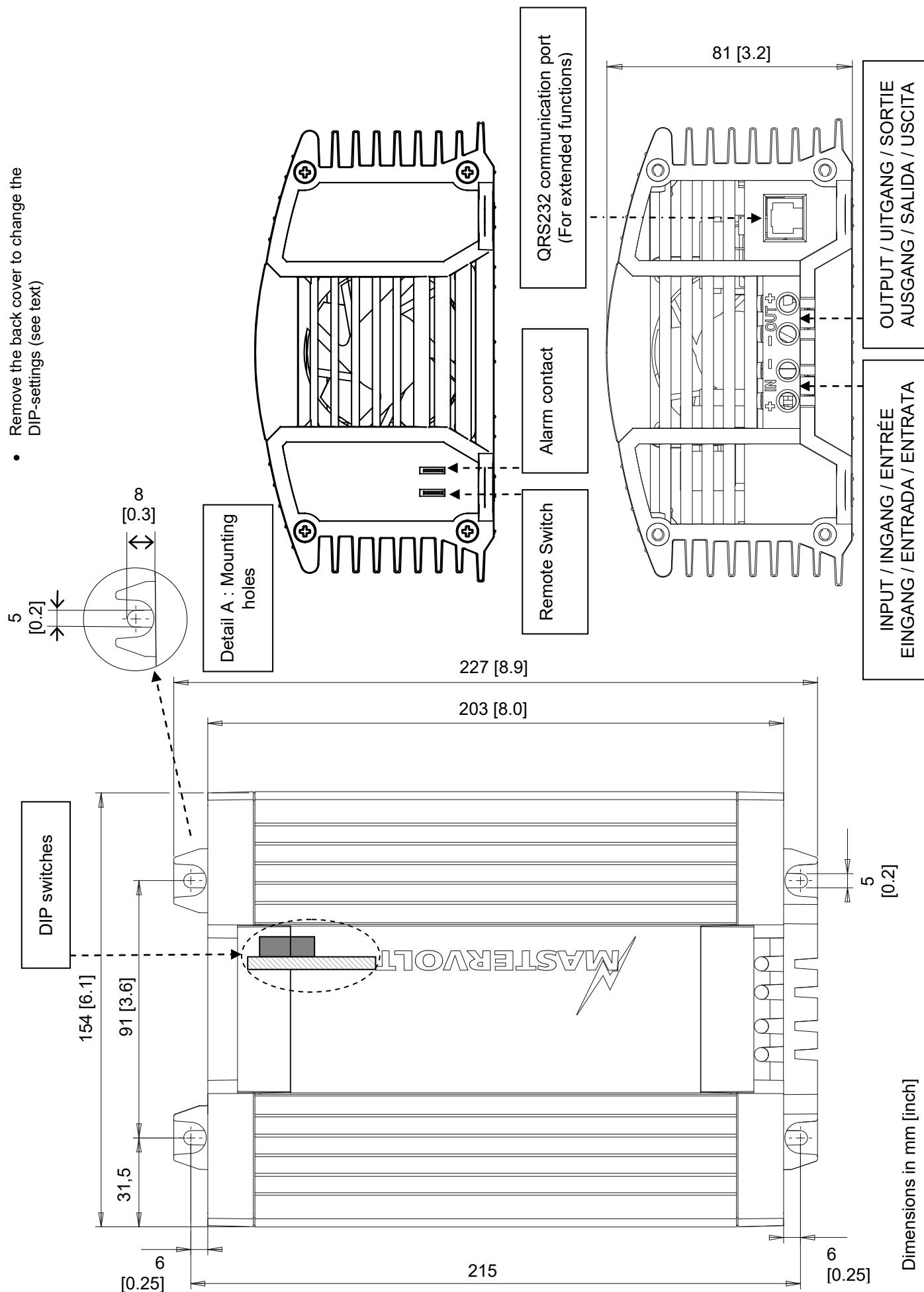

Dimensions in mm [inch]

SPECIFICATIONS MAGIC

Model	MAGIC 24/12-20A	MAGIC 24/24-20A	MAGIC 12/12-20A	MAGIC 12/24-10A
Part no.	81300100	81300200	81300400	81300300
Nominal input voltage	24V	24V	12V	12V
Input range, full output specifications	19-32V DC	19-32V DC	11-16V DC	11-16V DC
Input range, three step charger mode	24-32V DC	24-32V DC	12-16V DC	12-16V DC
Input range, no defects	0-35V DC	0-35V DC	0-17.5V DC	0-17.5V DC
Low voltage set point to trigger alarm *	20.0V DC	20.0V DC	10.0V DC	10.0V DC
Delay lower input set point *	30 sec.	30 sec.	30 sec.	30 sec.
Recommended fuse input	15A-T	30A-T	30A-T	30A-T
Wire size < 3m	4mm ² /AWG11	6mm ² /AWG9	6mm ² /AWG9	6mm ² /AWG9
Wire size > 3m	6mm ² /AWG9	10mm ² /AWG7	10mm ² /AWG7	10mm ² /AWG7

Output

Voltage adjustable *	10-15V DC	20-28.5V DC	10-15V DC	20-28.5V DC
Nominal voltage <i>stabilized voltage</i> *	13.6V DC	27.2V DC	13.6V DC	27.2V DC
Output voltage <i>3 step charger</i>				
Absorption / Float	14.25 / 13.25V DC	28.5 / 26.5V DC	14.25 / 13.25V DC	28.5 / 26.5V DC
Output voltage <i>dimmer</i>	4.0-13.0V DC	8.0-26.0V DC	4.0-13.0V DC	8.0-26.0V DC
Stabilized	2% at extremes of temperature, load and input			
Ripple	Max 1% peak peak			
Maximum power	300W @ U _{out} =12.0V	580W @ U _{out} =24.0V	300W @ U _{out} =12.0V	300W @ U _{out} =24.0V
Rated power	300W @ U _{out} =12.0V	580W @ U _{out} =24.0V	300W @ U _{out} =12.0V	300W @ U _{out} =24.0V
Current max. (derating >40°C, 5%/°C)	20A	20A	20A	10A
Maximum <i>3 step charge</i> current (bulk)	16A	16A	16A	8A
Wire size < 2m	6mm ² /AWG9	6mm ² /AWG9	6mm ² /AWG9	4mm ² /AWG11

General

Ambient operating temperature	Guaranteed operation: 0°C to 60°C (derating above +40°C, 5% per °C); in practice: -20°C to 60°C/ guaranteed operation: 32 °F to 140 °F (derating above 104 °F, 3% per °F), in practice -4°F to 140 °F
Storage temperature	-25°C to 85°C/ -13 °F to 185 °F
Operating humidity	95% max., non-condensing
Galvanic isolation	Yes
Current limited	Yes, I-max
Three stage battery charge option	Yes (DIP switch setting).
Efficiency	90% (at nominal input voltage, full load) typical; 92% peak
No load consumption	Typical <115mA

Protections

Over current	Limited by current sensing circuit
Over heat	Limited power by temperature sense circuit

Options

3 Step battery Charger	Yes, all models, by means of DIP switch settings
Dimmer function	Yes, by external momentary switch via fast-on connection. To be activated by DIP-switch setting
Alarm contact	Yes (fast-on connector)
Communication	Quasi RS232, modular RJ12 connection, to alter set points and to change characteristics. Optional: MasterBus serial interface (art. no. 77030450) to control & configure from MasterBus network.
Parallel connectability	In mode Stabilized Voltage, up to 6 devices in parallel

Mechanical

Connections input/output	Screw terminals, maximum wire size 16mm ² / AWG 5
Dimensions (HxWxD)	227 x 154 x 81 mm [8.9 x 6.1 x 3.2 inch]
Mounting holes	Diameter 5mm
Weight	1.8 kg / 3.9 lbs
Cabinet	Anodized aluminium, strapton ABS blend, blue RAL 5021
Directives and standards:	<ul style="list-style-type: none"> - EMC directive 2004/108/EC - Transient voltage protection: meets ISO 7637-2 - Electrostatic voltage protection: meets ISO10605, 14892, 8kV contact, 15kV discharge - RoHS directive 2011/65/EC

Setpoints software

Default setting

Low input voltage switch off level	10.0V / 20.0V; three step charger mode:12.0VDC / 24.0VDC.
Low input voltage switch off delay	30 seconds
Low input voltage switch on level	11.0V / 22.0V; three step charger mode: 13.0VDC / 26.0VDC.
High input voltage switch off level	16.0V / 32.0V
High input voltage switch on level	15.0V / 30.0V
Output voltage	13.6V / 27.2V

EC DECLARATION OF CONFORMITY

We,

Manufacturer: Mastervolt



Declare under our sole responsibility that:

Product:

81300100	MAGIC 24/12
81300200	MAGIC 24/24
81300400	MAGIC 12/12
81300300	MAGIC 12/24

Is in conformity with the following provisions of the EC:

2004/108/EC EMC directive.

The following harmonized standards have been applied:

- EN 61000-6-1:2007: Immunity for residential, commercial and light-industrial environments
- EN 61000-6-3: 2007: Emission standard for residential, commercial and light-industrial environments

2011/65/EC RoHS directive

Amsterdam,
8 January 2012

A handwritten signature in black ink that reads 'Marc Persoon'. The signature is written in a cursive style and is underlined with a long horizontal stroke.

Marc Persoon
Product Manager Power Conversion products
MASTERVOLT

MASTERVOLT
THE POWER TO BE INDEPENDENT