



2020 MASTER CATALOG

OUTBOARD & STERNDRIVE PROPELLERS



Evinrude® | Johnson® | Force® | Chrysler® | U.S. Marine®
Honda® | Mercury® | Mariner® | Nissan® | Tohatsu®
Mercruiser® | Volvo Penta® | Yamaha® | Suzuki® | OMC®

Evinrude/Johnson

15 HP (E-Tec) 2011 & Newer; **20 HP** 1984-1997; **25 & 30 HP** 1984 & Newer; **25 & 30 HP (E-Tec)** 2009 & Newer; **35 HP** 1976 & Newer; 14 Tooth..... **118...E**
25 & 30 HP (4-Stroke) 2004-2007; 10 Tooth Spline..... **121...E**
40 & 50 HP (4-Stroke) 1999-2005; 13 Tooth Spline..... **115...D**
40-75 HP Small Gearcase (3-3/8") 1975-2005; 13 Tooth Spline..... **111...C**
40-75 HP Large Gearcase (4-1/4") 1968 & Newer; 13 Tooth Spline..... **206...B**
60 & 70 HP (4-Stroke) 1998 & Newer; 13 Tooth Spline..... **210...B**
85-140 HP 1969 & Newer; 13 Tooth Spline..... **206...B**
90 & 115 HP (4-Stroke) 2002-2005; 15 Tooth Spline..... **225...B**
140 HP (4-Stroke) 2002-2005; 15 Tooth Spline..... **226...B**
90-300 HP, Lg. Gearcase 1976-1990; 15 Tooth Spline..... **201...A**
90-300 HP, Lg. Gearcase 1991 & Newer; 15 Tooth Spline..... **200...A**
200 & 225 HP (4-Stroke) 2004-2005; 15 Tooth Spline..... **204...A**
150-300 HP E-TEC G2 Gearcase 2014 & Newer; 15 Tooth Spline..... **228...A**

Force

25 HP 1995-1998; 10 Tooth Spline..... **120...E**
40 & 50 HP 1995-1998; **70 HP** 1991-1995; **75 HP** 1996-1998; 13 Tooth **114...D**
75-150 HP 1995-1999; **85-150 HP (Dual Exhaust)** 1988-1994; 15 Tooth. **202...B**

Honda

BF 25 1994 & Newer; **BF 30** 1995 & Newer; 10 Tooth Spline..... **119...E**
BF 35 & 45 1991-1994; **BF 40/50/50A** 1995 & Newer;
BF 60; 2010 & Newer; 13 Tooth Spline..... **113...D**
BF 75 & BF 90 1995-1998; 15 Tooth Spline..... **202...B**
BFP 60 2010 & Newer; **BF 75 & BF 90** 1999 & Newer; **BF 100** 2016 & Newer;
BF 115 1998-2010; **BF 130** 1998-2004; 15 Tooth Spline..... **207...B**
BF 135-250 HP 2002 & Newer; **BF 115D** 2011 & Newer; 15 Tooth..... **207...A**

Mercury/Mariner/Mercruiser

9.9, 15 HP (4-Stroke/Bigfoot/Sail) 1999-2005; **18 HP (Mercury)** 1980-1985;
20 & 25 HP (Not 4-Stroke) 1980-2005; 10 Tooth Spline..... **120...E**
25 & 30 HP (4-Stroke - Not Bigfoot) 2006 & Newer; 10 Tooth Spline... **122...E**
25 HP Bigfoot 1999-2005; **30 HP (Sea Pro/Marathon)** 1994 & Newer;
30 HP (2- & 4-Stroke) 1994-2005; **35 HP** 1984-1989; **40-50 HP** 1974-1976;
40/50/70 HP 1977-1984; **45 HP** 1986-1989;
40 & 50 HP (2- & 4-Stroke, Not Bigfoot) 1977 & Newer;
48 HP (Mariner) All Years; **55 HP (Mercury/Sea Pro/Marathon)** 1995 & Newer;
60 HP (Not Bigfoot) 1978 & Newer; **60 HP (Mariner)** 1976; **65 HP** 1972-1976;
70 HP Thru 1983; **80 HP (Mariner)** 1977; 13 Tooth Spline..... **114...D**
40-140 HP (Except 135 HP) V4 Gearcase 1961 & Newer; 15 Tooth..... **202...B**
135-300 HP 1978 & Newer; 15 Tooth Spline..... **202...A**
Mercruiser Alpha One & Bravo One (< 400 HP); 15 Tooth Spline..... **202...A**

Nissan/Tohatsu

25 & 30 HP 1985-2001; **25 & 30 HP (4-Stroke)** 2002 & Newer..... **122...E**
35 HP (35B Only) Thru 1984; **40 HP** 1984 & Newer;
50 HP (All Except 50C) 1992 & Newer; 13 Tooth Spline..... **116...D**
50 HP (50C Only) 1987-1991; **55 HP** 1981-1988;
60A 1986-1999; **70A & 70B** 1981-1995; 13 Tooth Spline..... **112...C**
60-140 HP, 4-1/4" Gearcase 1987 & Newer; 15 Tooth Spline..... **209...B**

OMC/Cobra Sterndrives

Model 400 Cobra 1978-1991; 13 Tooth Spline..... **206...B**
Model 800/Cobra/King Cobra 1978-1990; 15 Tooth Spline..... **201...A**
Model 800/Cobra/King Cobra 1991-1994; 15 Tooth Spline..... **200...A**
Cobra SX 1994 & Newer; 19 Tooth Spline..... **205...A**

Suzuki

DT 20 & DT 25 1985-1988; **DT 25C** 1989-2000; **DF 25A** 2014 & Newer;
DT 30 1983-1997; **DT 30C** 1987-1997; **DF 30A** 2014 & Newer;
DF 25 & DF 30 (4-Stroke) 2000-2007; 10 Tooth..... **121...E**
DT 35C 1987-1989; **DT 40** 1983-1998; **DF 40 & DF 50 (4-Stroke)** 1999-2010;
DF 40A & 50A 2011 & Newer; **DT 50 & 50M** 1983-1984; **DT 55** 1985-1997;
DT 60 1983-1984; **DF 60A** 2010 & Newer; **DT 65** 1985-1997; 13 Tooth **115...D**
DF 60 (4-Stroke) 1998-2009; **DF 70 (4-Stroke)** 1998-2008;
DT 75/85/100/115/140 1979-2001; 13 Tooth Spline..... **210...B**
DF 50AV/60AV 2015 & Newer; **DF 90** 2001-2008;
DF 100 2009 & Newer; **DF 115** 2001-2012; 15 Tooth Spline..... **225...B**
DF 115A & 140A 2013 & Newer; **DF 140** 2002-2012; 15 Tooth Spline... **226...B**
DF 70A/80A/90A 2009 & Newer; 15 Tooth Spline..... **227...B**
150-300 HP (Including 4-Stroke) 1986 & Newer; 15 Tooth Spline..... **204...A**

Yamaha

20 HP 1996-1997; **25 HP** 1980 & Newer; **F25 (4-Stroke)** 1998-2006
F25 (4-Stroke) 2010 & Newer; **30 HP** 1983-2002; 10 Tooth Spline..... **123...E**
T25 2010 & Newer; **F30 (4-Stroke)** 2001-2005;
40 HP & 50 HP (Not T50) 1984 & Newer; **F40 (4-Stroke)** 1999 & Newer;
48 HP 1995-2000; **F50 (4-Stroke)** 1995 & Newer; **55 HP** 1976-1995;
60 HP 1976-1991; **F60 (4-Stroke)** 1999 & Newer..... **117...D**
50-100 HP (Including 4-Stroke) 1984 & Newer; 15 Tooth Spline..... **208...B**
115 & 130 HP 1984 & Newer; **F115 (4-Stroke)** 2000 & Newer..... **203...B**
80-140 HP 1977-1983; 15 Tooth Spline..... **202...B**
150-175 HP 1978-1983; 15 Tooth Spline..... **202...A**
150-300 HP (Including 4-Stroke) 1984 & Newer; **300 HP** 2004-07..... **203...A**
Sterndrives 1989-1993; 15 Tooth Spline..... **203...A**

Volvo Penta

SX Sterndrives 1994 & Newer; 19 Tooth Spline..... **205...A**

VORTEX® XHS® SERIES ALUMINUM PROPELLERS

PROP SERIES A			PROP SERIES B			PROP SERIES C			PROP SERIES D						PROP SERIES E		
3 & 4-Blade			3 & 4-Blade			3 & 4-Blade			Standard 3 & 4-Blade			Lg. Diameter 3 & 4-Blade			Standard 3-Blade		
DIA x PITCH	BLD #	P/N	DIA x PITCH	BLD #	P/N	DIA x PITCH	BLD #	P/N	DIA x PITCH	BLD #	P/N	DIA x PITCH	BLD #	P/N	DIA x PITCH	BLD #	P/N
16 x 13	3	992001	14 x 10	3	992109	11-1/2 x 8	4	992401	10-5/8 x 12	4	941212	11-1/2 x 8	4	992401	10-1/2 x 9	3	992501
15-1/4 x 15	3	992002	14 x 11	3	992111	11-1/2 x 9	4	992402	10-5/8 x 13	4	941213	11-1/2 x 9	4	992402	10-1/2 x 10	3	992502
16 x 16	3	931516	13-3/4 x 13	3	992112	11-1/2 x 10	4	992403	10-1/8 x 14	4	941214	11-1/2 x 10	4	992403	10-1/2 x 11	3	992503
15 x 17	3	992003	13-1/2 x 15	3	992113	11-3/4 x 13	3	992301	10-1/8 x 15	4	941215	12-1/4 x 9	3	992601	10-1/8 x 12	3	992504
14-1/2 x 19	3	992004	13-1/4 x 17	3	992114	11-3/4 x 15	3	992302	10-3/8 x 11	3	992404	11-3/4 x 10	3	992602	10-1/8 x 13	3	992505
14-1/4 x 21	3	992005	13 x 19	3	992115	11-3/4 x 17	3	992303	10-3/8 x 12	3	992405	11-5/8 x 11	3	992603	10-1/8 x 14	3	992506
14 x 23	3	992006	13 x 21	3	992116	12-1/2 x 13	3	992311	10-3/8 x 13	3	992406	11-3/8 x 12	3	992604			
15 x 16	4	992202	13-7/8 x 11	4	941411	12-1/4 x 15	3	992312	10-3/8 x 14	3	992407	11-1/8 x 13	3	992605			
14-1/2 x 18	4	992203	13-7/8 x 13	4	941413				10 x 15	3	992408	11-1/4 x 14	3	992606			
14 x 20	4	992204	13-3/8 x 15	4	941415				10 x 16	3	992409						
			13 x 17	4	941417												
			12-1/2 x 19	4	941419												

BALLISTIC® XHS® SERIES STAINLESS STEEL PROPELLERS

PROP SERIES A V8/V6 APPLICATIONS			PROP SERIES B V4 APPLICATIONS			PROP SERIES C			PROP SERIES D		PROP SERIES E	
Standard 3-Blade			Ballistic XL			Standard 3-Blade & XL			Standard 3-Blade		Standard 3-Blade	
DIA x PITCH	RH P/N	LH P/N	DIA x PITCH	BLD #	RH P/N	DIA x PITCH	BLD #	RH P/N	DIA x PITCH	RH P/N	DIA x PITCH	RH P/N
14-7/8 x 15	933515		14-3/4 x 22	3	953522	13-5/8 x 15	Std. 3-Blade	933415	12-3/8 x 15	933315	10-1/8 x 13	933213
14-3/4 x 17	933517	937517	14-3/4 x 24	3	953524	13-1/2 x 17	Std. 3-Blade	933417	12 x 17	933317	10-1/8 x 15	933215
14-1/2 x 19	933519	937519	14-3/4 x 26	3	953526	13-3/8 x 19	Std. 3-Blade	933419				
14-3/8 x 21	933521	937521				13-1/8 x 21	Std. 3-Blade	933421				
14-1/4 x 23	933523	937523	14-1/8 x 23	4	963523							
14-1/4 x 25	933525		14-1/8 x 25	4	963525	13-1/2 x 22	3-Blade XL	953422				
			14-1/8 x 27	4	963527	13-1/2 x 24	3-Blade XL	953424				

* For Apollo XHS Series Stainless Steel propeller offering, please refer to 2019 XHS Application Chart, or applicable engine category within this catalog.

Contents:

Propeller Basics	A3 - A6
Choosing the Correct Pitch	A7
Basic Troubleshooting	A8
Engine RPM Chart.....	A10 - A11
Michigan Propellers.....	A12 - A14

OUTBOARD PROPELLERS



How to Use the Application Guide	A15
Evinrude®, Johnson® Outboards.....	2 - 11
Force®, Chrysler, U.S. Marine Outboards.....	12 - 15
Honda® Outboards	16 - 19
Mercury®, Mariner®, Sea Ray Outboards	20 - 26
Nissan® / Tohatsu® Outboards.....	28 - 32
Suzuki® Outboards.....	33 - 37
Yamaha® Outboards	38 - 42
Parsun® / Selva® Outboards	43 - 46

STERNDRIVE PROPELLERS



Mercruiser® Sterndrives	47 - 48
OMC® Sterndrives	49 - 50
Volvo Penta® Sterndrives	51
Yamaha® Sterndrives.....	52
XHS® / XHS II® Attachment Hardware.....	54
XHS® / XHS II® Propeller Accessories.....	55 - 56

SKI & TOWBOAT PROPELLERS



Dyna-Jet® 3-Blade Ski Propeller.....	A14
Extreme 4-Blade Ski/Towboat Propeller	A14

PROPELLER CROSS REFERENCE



Michigan Wheel Alpha-Numeric Cross Reference.....	B2 - B4
Michigan Wheel - Turning Point® Cross Reference	B4
Michigan Wheel to Solas® Cross Reference.....	B5
Michigan Wheel to Quicksilver® Cross Reference.....	B6
XHS® / XHS II® Hub System Cross Reference	B7
OEM Cross Reference	B8 - B31
Michigan Wheel Warranty	B32

PROPELLER BASICS

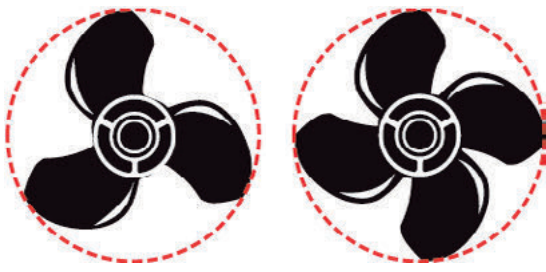

Diameter

Diameter is two times the distance from the center of the hub to the tip of the blade. It also can be looked at as the distance across the circle that the propeller would make when rotating. It is the first number listed when describing a propeller.

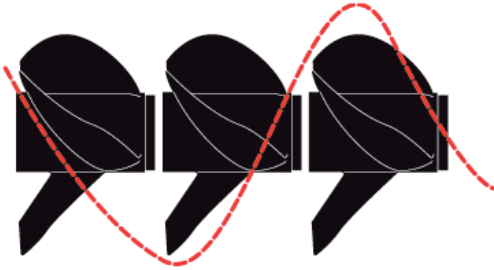

Pitch

Pitch is defined as the theoretical forward movement of a propeller during one revolution - assuming there is no “slippage” between the propeller blade and the water. For most boats, there is slippage and therefore the distance advanced is less than the design pitch. The amount of slippage varies from boat to boat. Pitch is the second number listed in the propeller description.

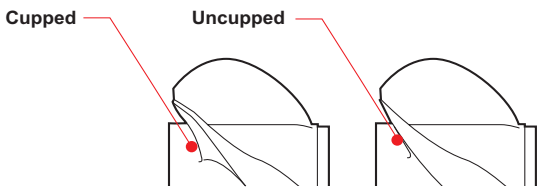

Cupping

Many of today’s propellers incorporate a cup at the trailing edge of the propeller blade. This curved lip on the propeller allows it to get a better bite on the water. This results in reduced ventilation, slippage, and allows for better hole shot in many cases. A cupped propeller also works very well where the motor can be trimmed so that the propeller is near the surface of the water. The cup will typically result in higher top end speed on one of these applications.

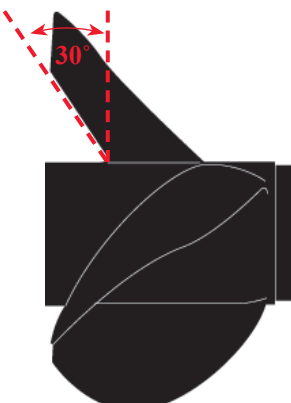

Rake

Rake is the degree that the blades slant forward or backwards in relation to the hub. Rake can affect the flow of water through the propeller, and has implications with respect to boat performance.

Aft Rake helps to trim the bow of the boat upwards, which often results in less wetted surface area and therefore higher top end speed. Aft Rake propellers also typically provide better “bite” on ventilating-type applications.

Forward, or Negative Rake , helps hold the bow of the boat down. This is more common in workboat type applications.

Ventilation

Ventilation is a situation where surface air or exhaust gases are drawn into the propeller blades. When this situation occurs, boat speed is lost and engine RPM climbs rapidly. This can result from excessively tight cornering, a motor that is mounted very high on the transom, or by over-trimming the engine.

Cavitation

Cavitation, which is often confused with ventilation, is a phenomena of water vaporizing or “boiling” due to the extreme reduction of pressure on the back of the propeller blade. Many propellers partially cavitate during normal operation, but excessive cavitation can result in physical damage to the propeller’s blade surface due to the collapse of microscopic bubbles on the blade.

There may be numerous causes of cavitation such as incorrect matching of propeller style to application, incorrect pitch, physical damage to the blade edges, etc.

Be advised disturbances in the water flow forward of the propeller can result in blade damage, which appears to be blade cavitation, but is actually due to non-favorable water flow into the propeller.

PROPELLER BASICS

Finding the right match between the propeller, engine type and boat size will optimize the following performance factors:

- Increased Top End Speed
- Faster Planing Speed (Hole Shot)
- Improved Low End Punch
- Load Carrying Capability

If you want to modify your boat's performance, consider the following before making your selection:

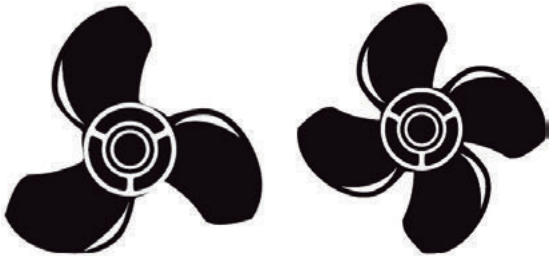

3-Blade Propeller vs. 4-Blade Propeller

We recommend 3-Blade propellers for recreational boats with 3, 4, and 6 cylinder outboards and I/O engines. These propellers provide good hole shot and top-speed performance.

We recommend 4-Blade propellers for practical, all-around boat performance. These propellers enhance handling, hole shot, load-carrying performance, and fuel efficiency.



Aluminum vs. Stainless Steel

Most pleasure boats are factory equipped with aluminum propellers. Aluminum propellers are relatively inexpensive, easy to repair, and under normal conditions can last for many years.

Stainless steel is more expensive, but much stronger and durable than aluminum. If you are looking for better performance than can be provided by your aluminum propeller, such as ultimate top speed or better acceleration, a stainless steel propeller may be required.



Advantage of a Left Hand Propeller

Two propellers spinning in the same direction on twin engine boats will create steering torque. In other words, two right-hand propellers pull the stern hard to the right and the bow to the left.

Two opposite-direction (counter-rotating) propellers on twin engines eliminate this steering torque because the left-hand propeller balances out the right-hand propeller. This results in better straight-line tracking and helm control at high speed.



Theoretical 
Actual 

Affect of Slip on Performance

Slip is the difference between actual and theoretical travel of the propeller blades through water. A properly matched propeller will actually move forward about 80 to 90 percent of the theoretical pitch.

PROPELLER BASICS

What is the difference between thru-hub exhaust, over-hub exhaust, and non thru-hub exhaust?

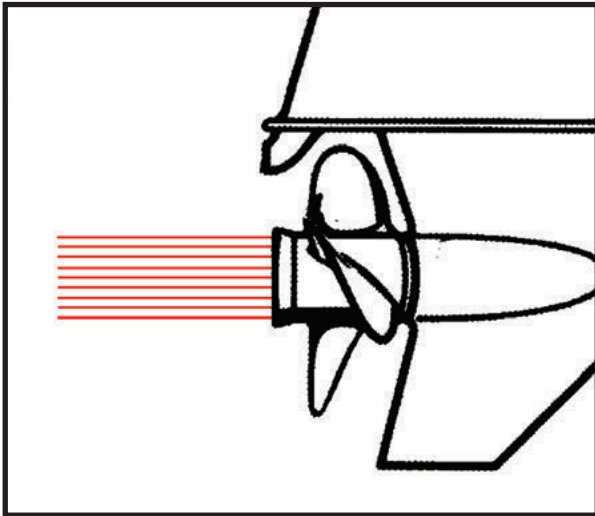

THRU-HUB EXHAUST

Thru-hub exhaust propellers consist of a round barrel to which the blades are attached. The exhaust passes through the barrel and out the back, without making contact with the propeller blades. This provides a good, clean water flow to the blades, usually resulting in good acceleration and hole shot.

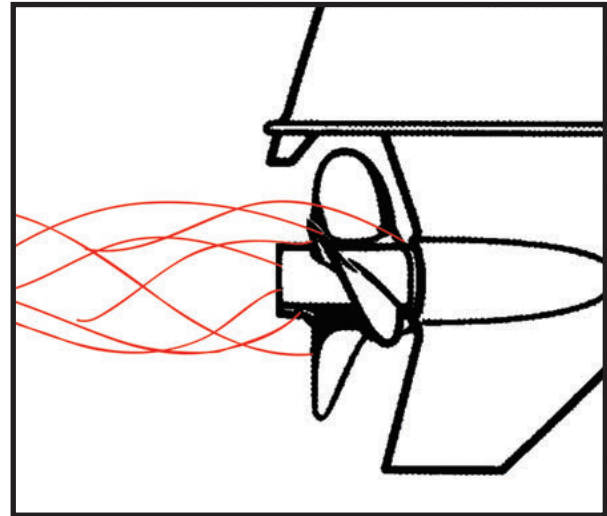

OVER-HUB EXHAUST

Over-hub exhaust propellers have the blades attached directly to the smaller tube that fits over the propeller shaft, eliminating the larger exhaust tube. These types of propellers are often used for attaining maximum top speeds. (On some boats, the hole shot can often suffer due to the extreme exhaust flooding that occurs around the propeller blades during acceleration.)

THRU-HUB EXHAUST and **OVER-HUB EXHAUST** propellers are used on boats where the exhaust passes out through the rear of the “torpedo” on the lower unit, around the propeller shaft. Most outboards utilize this type of exhaust.

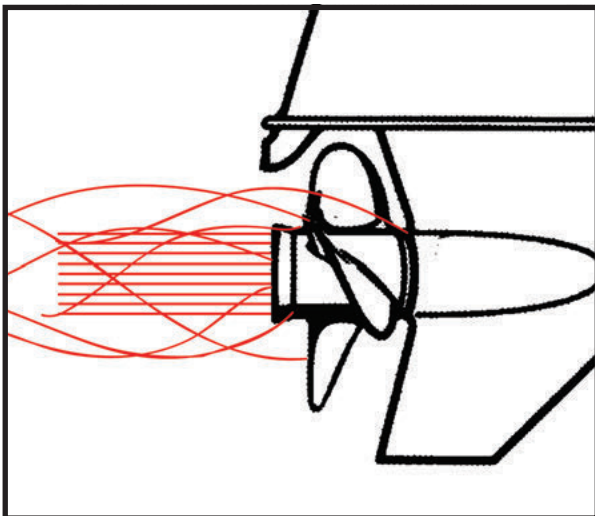

OVER/THRU-HUB EXHAUST

Over/Thru-hub exhaust propellers are a combination of thru-hub and over-hub exhaust propellers. This allows some exhaust to escape at lower RPM, providing a controlled amount of exhaust flooding. These types of propellers will allow the propeller to be slightly easier to turn during initial acceleration, allowing for better hole shot on some engine/boat combinations.

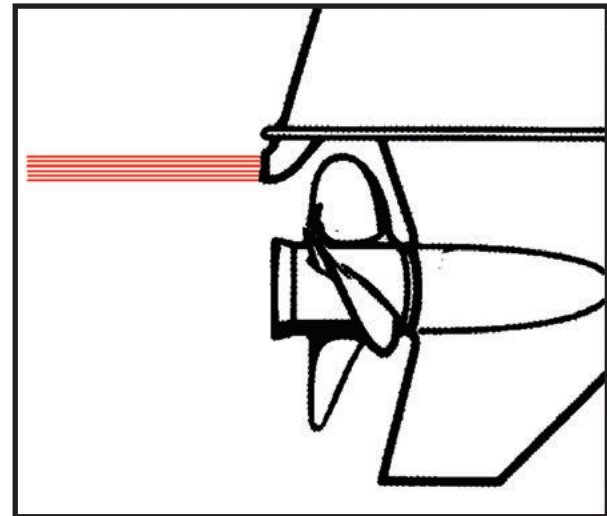

NON THRU-HUB EXHAUST

Non thru-hub exhaust propellers are used for inboards using shaft driven propellers, sterndrives using through hull exhaust, and on some outboards that don't route the exhaust through the lower unit torpedo.

CHOOSING THE CORRECT PITCH

For safety and efficient performance, it is critical that your engine operates within the RPM range recommended by the manufacturer. Matching the right prop for the load is the most significant factor when choosing a new propeller.

1) Determine Manufacturer's Recommended RPM

Find the manufacturer's recommended RPM range in the owner's manual or ask your dealer. A reference chart showing common engine applications is shown on Pages A6-A7 of this catalog.

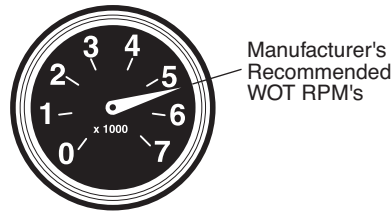

2) Test for Maximum RPM

Using the existing propeller or a new propeller, make test runs to determine the maximum RPM and boat speed. Vary the trim angle for optimum performance.



3a) If RPM are Higher Than Recommended

If the actual WOT RPM are *above* the recommended RPM range, install the next larger pitch propeller to *decrease* your WOT RPM. Re-test the WOT RPM.

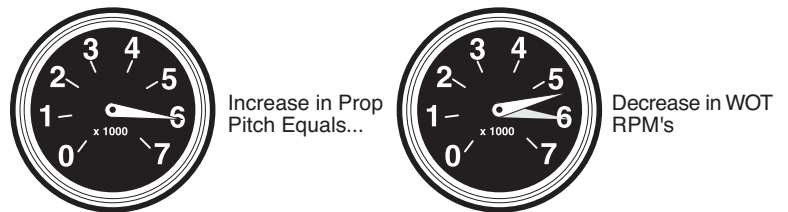

3b) If RPM are Lower Than Recommended

If the actual WOT RPM range is *below* the recommended range, install the next smaller pitch propeller to *increase* your WOT RPM. Re-test the WOT RPM.

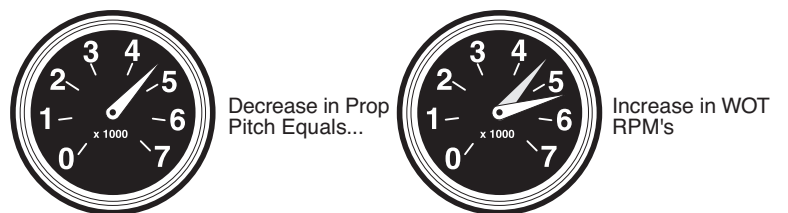

When you combine all these factors, you have the information you need to select the correct propeller for maximum performance, safety, and fuel efficiency.

Effect of Propeller Pitch on RPM

A pitch change can increase or decrease the RPM and bring RPM into the recommended range. A 2" increase in pitch (for example, from 21" to 23") typically results in a decrease of approximately 300-400 RPM.

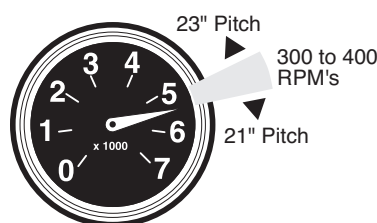

BASIC TROUBLESHOOTING

• When installing an XHS / XHS II Hub System:

1. Confirm that the propeller is meant for use with your engine application (Figure 4).
2. Gearcase adapter rings are required for ALL VORTEX® “E” Series propellers. Gearcase adapter rings are supplied with every V4 VORTEX® and APOLLO® propeller, and may or may not be required (Figure 1 - 3).

Boat Description/Length	VORTEX MICHIGAN					APOLLO MICHIGAN					Drop-In Hub Use XHS II® Hub Kit 209 Refer to pages 51-52 for Details on Hub Kit Component.		
	Dis.	Rot.	Pitch	Blk #	OEM Part #	Part #	Dis.	Rot.	Pitch	Blk #		OEM Part #	Part #
CR, HB	14	R	11	3		992111							
22'-25"-AL, SK	13-3/4	R	13	3	3N48645271	992112							
19'-22"-AL, SK	13-1/2	R	15	3	3N48645321	992113	13-3/8	R	15	3	PT7011SP15	993143	
18'-21"-AL, SK	13-1/4	R	17	3	3N48645361	992114	13-3/8	L	15	3		993151	
18'-21"-AL, SK	13-1/4	R	17	3	3N48645361	992114	13-1/4	R	17	3	NM589610170	993144	
17'-20"-AL, SK	13	R	19	3	3N48645411	992115	13-1/4	L	17	3		993152	
17'-20"-AL, SK	13	R	19	3	3N48645411	992115	13-1/8	R	19	3		993142	
15'-18"-AL, SK	13	R	21	3	3N48645451	992116	13-1/8	L	19	3		993155	
15'-18"-AL, SK	13	R	21	3	3N48645451	992116	13	R	21	3		993146	
15'-18"-AL, SK	13	R	21	3	3N48645451	992116	13	L	21	3		993156	

25-30 HORSEPOWER (4-STROKE) • 3" GEARCASE Thru Hub Exhaust & 10 Tooth Spline		25 HP 4-Stroke.....2004-2007		30 HP 4-Stroke.....2004-2007																																																								
<table border="1"> <thead> <tr> <th rowspan="2">Boat Description/Length</th> <th colspan="5">VORTEX MICHIGAN</th> <th rowspan="2">Drop-In Hub Use XHS II® Hub Kit 121 Refer to pages 51-52 for Details on Hub Kit Component.</th> </tr> <tr> <th>Dis.</th> <th>Rot.</th> <th>Pitch</th> <th>Blk #</th> <th>OEM Part #</th> <th>Part #</th> </tr> </thead> <tbody> <tr> <td>20' & Up -AL</td> <td>10-1/2</td> <td>R</td> <td>9</td> <td>3</td> <td></td> <td>992201</td> </tr> <tr> <td>17'-20" -AL</td> <td>10-1/2</td> <td>R</td> <td>10</td> <td>3</td> <td></td> <td>992202</td> </tr> <tr> <td>17'-20" -AL</td> <td>10-1/2</td> <td>R</td> <td>11</td> <td>3</td> <td></td> <td>992203</td> </tr> <tr> <td>15'-18" -AL</td> <td>10-1/8</td> <td>R</td> <td>12</td> <td>3</td> <td></td> <td>992204</td> </tr> <tr> <td>13'-15" -AL</td> <td>10-1/8</td> <td>R</td> <td>13</td> <td>3</td> <td></td> <td>992205</td> </tr> <tr> <td>Up to 15" -LL</td> <td>10-1/8</td> <td>R</td> <td>14</td> <td>3</td> <td></td> <td>992206</td> </tr> </tbody> </table>						Boat Description/Length	VORTEX MICHIGAN					Drop-In Hub Use XHS II® Hub Kit 121 Refer to pages 51-52 for Details on Hub Kit Component.	Dis.	Rot.	Pitch	Blk #	OEM Part #	Part #	20' & Up -AL	10-1/2	R	9	3		992201	17'-20" -AL	10-1/2	R	10	3		992202	17'-20" -AL	10-1/2	R	11	3		992203	15'-18" -AL	10-1/8	R	12	3		992204	13'-15" -AL	10-1/8	R	13	3		992205	Up to 15" -LL	10-1/8	R	14	3		992206
Boat Description/Length	VORTEX MICHIGAN						Drop-In Hub Use XHS II® Hub Kit 121 Refer to pages 51-52 for Details on Hub Kit Component.																																																					
	Dis.	Rot.	Pitch	Blk #	OEM Part #	Part #																																																						
20' & Up -AL	10-1/2	R	9	3		992201																																																						
17'-20" -AL	10-1/2	R	10	3		992202																																																						
17'-20" -AL	10-1/2	R	11	3		992203																																																						
15'-18" -AL	10-1/8	R	12	3		992204																																																						
13'-15" -AL	10-1/8	R	13	3		992205																																																						
Up to 15" -LL	10-1/8	R	14	3		992206																																																						

Fig. 1 (Above) All Vortex “E” Series Propellers are shipped with a set of (3) gearcase adapter rings, and requires use of appropriate ring - indicated on the tabs.



Fig. 2 All Vortex and Apollo “B” Series (V4) Propellers are shipped with (1) gearcase adapter ring. Some engines require use of this gearcase adapter ring (Top Left), others do not (Bottom Left).



Fig. 3 Failure to install gearcase adapter ring leaves gap that causes excessive ventilation, poor performance.

3. Confirm the correct XHS® / XHS II® Hub Kit has been selected for your engine.
4. All OEM attachment hardware must be removed prior to installation of XHS® / XHS II® Hub Kits. The shaft taper must be visible (Figure 5). If the propeller shaft taper is not visible, the OEM forward thrust washer is likely still installed (Figure 6).
5. The forward thrust washer is tapered and will nest with the taper on the propeller shaft with little effort (Figure 7).
6. Each additional XHS® / XHS II® Hub Kit component is designed to be installed in a specific order. Refer to XHS® Installation Instructions (Form 990445) for correct order (Figure 8).
7. Verify all hardware components packaged with your XHS® / XHS II® Hub Kit have been used. Component part numbers can be found on Pg. 56 & 57.
8. Ensure your propeller nut is torqued to the manufacturer’s recommended value identified in your engine owner’s manual.



Fig. 4 Vortex “C” Series (3-3/8”) Propeller installed on a V4 (4-1/4”) gearcase. Results in poor performance and excessive ventilation. Vortex “B” Series (4-1/4”) Propeller should be used.



Fig. 5 Propeller shaft taper is visible, indicating OEM forward thrust washer has been removed. XHS Hub Kit forward thrust washer ready to be installed.



Fig. 6 OEM forward thrust washer was not removed. XHS Hub Kit and Michigan Wheel propeller will not fit properly.



Fig. 7 The forward thrust washer is tapered and will nest with the taper on the propeller shaft. When properly installed, the part number will be visible.

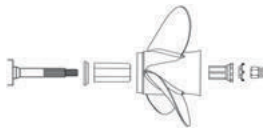

Fig. 8 The forward thrust washer MUST be installed first. Failure to install a forward thrust washer will cause gearcase damage and potential injury.

• Other Common Installation Mistakes:



Over time, the forward thrust washer may appear as part of the propeller shaft. It is still necessary to remove the thrust washer when installing an XHS propeller.



The gearcase adapter ring will snap into place, and lay flush with the propeller. If there is a gap, it is not properly installed.



Aft drive adapter incorrectly installed. The propeller will fall off the propeller shaft if run with this incorrect installation.



The shaft taper takes forward thrust from the thrust washer. Without a forward thrust washer, the gearcase takes the forward thrust as the propeller will continue to move forward on the shaft, causing severe damage to the gearcase.



... Seriously?

• When installing a rubber hub propeller:

1. Determine if this is a “drop-in hub” to Michigan Match® installation. If yes, follow the replacement instructions on Page. 27.
2. If this is an OEM to Michigan Match® installation, make sure all hardware components are available. Confirm that the forward thrust washer is not stuck in the old propeller.
3. Michigan Match® is an OEM-equivalent propeller. If the correct OEM propeller and attachment hardware was being used, the Michigan Match® equivalent will fit without issue.

WATER LUBRICATED BEARINGS

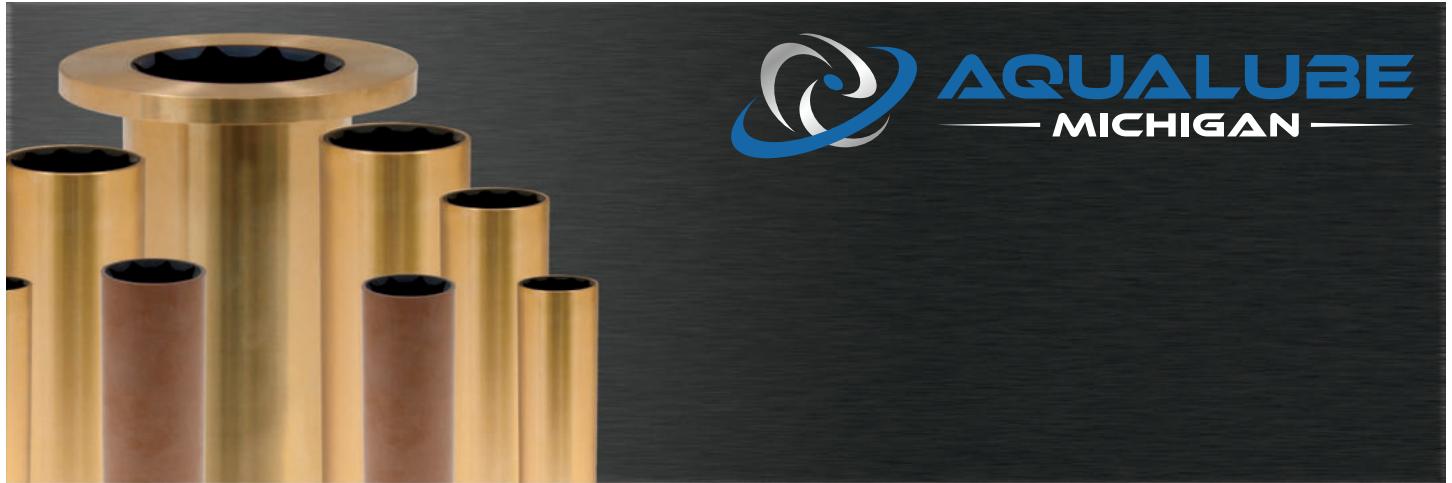

AQUALUBE®



Aqualube bearings are designed for marine and industrial applications. The bearings feature a specially formulated rubber and are molded into various shell materials. The rubber is an extremely tough, chemical and oil resistant nitrile which offers outstanding resistance to abrasion and wear even in the most adverse conditions.

Part Number	Material	I.D.	O.D.	Length	Part Number	Material	I.D.	O.D.	Length
907501	Brass	3/4	1-1/4	3	917501	Brass	1-3/4	2-3/8	7
908751	Brass	7/8	1-1/4	3-1/2	917503	Brass	1-3/4	2-1/2	7
908752	Brass	7/8	1-3/8	3-1/2	917502	Brass	1-3/4	2-5/8	7
908753	Brass	7/8	1-1/2	3-1/2	918251	Brass	1-7/8	2-5/8	7-1/2
910001	Brass	1	1-1/4	4	918252	Brass	1-7/8	2-15/16	7-1/2
910002	Brass	1	1-3/8	4	920001	Brass	2	2-5/8	8
910003	Brass	1	1-1/2	4	920002	Brass	2	2-3/4	8
910004	Brass	1	1-5/8	4	920003	Brass	2	3	8
910005	Brass	1	2	4	921252	Brass	2-1/8	2-15/16	8-1/2
911251	Brass	1-1/8	1-1/2	4-1/2	921254	Brass	2-1/8	3-1/8	8-1/2
911252	Brass	1-1/8	1-5/8	4-1/2	922501	Brass	2-1/4	2-15/16	9
911253	Brass	1-1/8	1-3/4	4-1/2	922502	Brass	2-1/4	3	9
911254	Brass	1-1/8	2	4-1/2	922503	Brass	2-1/4	3-1/8	9
912501	Brass	1-1/4	1-1/2	5	922505	Brass	2-1/4	3-3/8	9
912503	Brass	1-1/4	1-3/4	5	923751	Brass	2-3/8	3-3/8	9-1/2
912505	Brass	1-1/4	2	5	925002	Brass	2-1/2	3-1/8	10
912507	Brass	1-1/4	2-1/8	5	925003	Brass	2-1/2	3-1/4	10
913751	Brass	1-3/8	1-7/8	5-1/2	925004	Brass	2-1/2	3-3/8	10
913752	Brass	1-3/8	2	5-1/2	925005	Brass	2-1/2	3-1/2	10
913754	Brass	1-3/8	2-1/8	5-1/2	926252	Brass	2-5/8	3-3/8	10-1/2
915001	Brass	1-1/2	2	6	927501	Brass	2-3/4	3-3/8	11
915004	Brass	1-1/2	2-3/8	6	927502	Brass	2-3/4	3-1/2	11
916251	Brass	1-5/8	2-1/8	6-1/2	927503	Brass	2-3/4	3-3/4	11
916255	Brass	1-5/8	2-5/8	6-1/2	927701	Brass	2-7/8	3-3/4	11-1/2

Aqualube bearings available in sizes up to 30" in length, in brass and phenolic (non-metallic) material. Metric dimensions also available. Contact Michigan Wheel Europe Headquarters for Aqualube bearing part numbers and stock.

MICHIGAN PROPELLERS

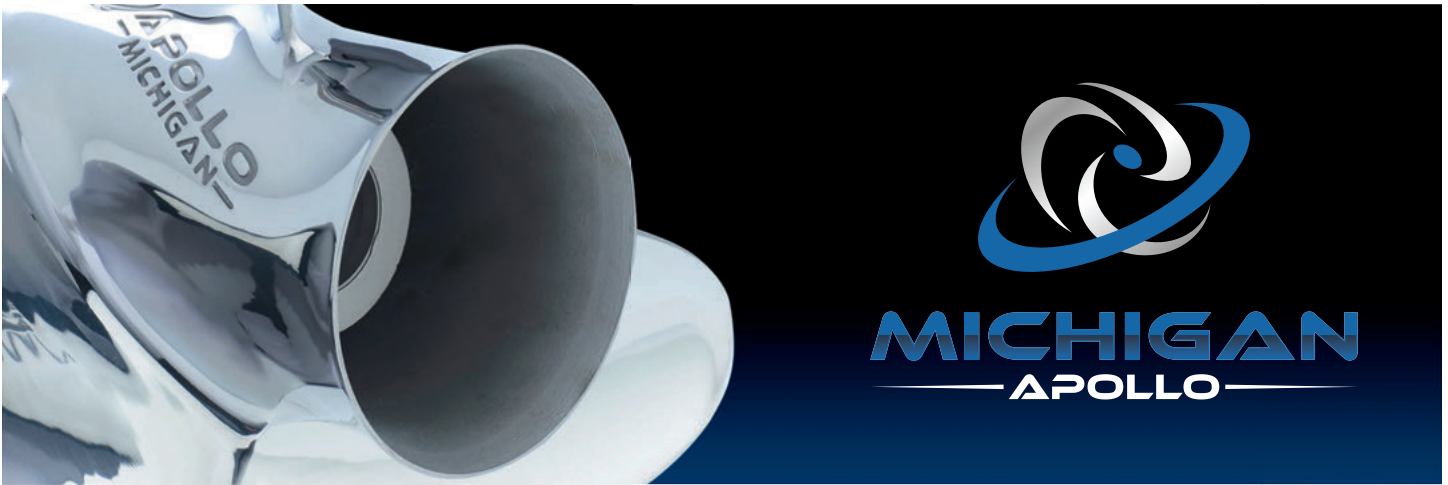

APOLLO® STANDARD 3-BLADE

Apollo® propellers are highly polished, ultimate performance, stainless steel wheels. Apollo® is designed to use Michigan Wheel's XHS® / XHS II® hub system, and is interchangeable with Mercury's Flo-Torq® II hub system.

- **Ø - Ø HP (12" - 15" pitch; RH rotation)**
- **V4 Outboard (15" - 21" pitch; RH & LH rotation)**
- **V6 V8 OBSD (15" - 23" pitch; RH & LH rotation)**

Recommend d Boat Applications: Inflatables, Aluminum Consoles, Bass Boats, Flats Boats, Sport Boat Singles, Sport Boat Duals

APOLLO® LARGE DIAMETER 3-BLADE

The Apollo® 3-Blade Large Diameter propeller is great for heavier applications that require increased blade area. Common to the entire Apollo® line, the Apollo® Large Diameter 3-Blade features CAD designed high performance blade geometry.

- **V6 V8 OBSD (17" - 23" pitch; RH & LH rotation)**

Recommend d Boat Applications: Bay Boats, Offshore Singles & Duals, Sport Boat Singles & Duals, Pontoons, Family Cruisers, Workboats, Houseboats

APOLLO® 4-BLADE

The Apollo® 4-Blade propeller is designed to improve hole shot on heavier loads. This propeller is ideal for pulling/towing in water sports. High performance blade geometry, high luster finish, utilization of XHS® / XHS II® hub kit, and interchangeability with Mercury's Flo-Torq® II hub system makes the Apollo® 4-Blade the perfect propeller for a wide range of boats.

- **V6 V8 OBSD (16" - 22" pitch; RH & LH rotation)**

Recommend d Boat Applications: Aluminum Consoles, Bay Boats, Walleye Boats, Offshore Singles & Duals, Sportboat Singles & Duals, Skiboats



BALLISTIC®

High performance stainless steel propellers with the proven Power Tip for peak efficiency, Ballistic is designed to use Michigan Wheel's XHS® / XHS II® hub system. The blade tip and cup combine to improve bite and reduce power losses caused by cavitation. Highly cambered blade sections provide for higher speed and better bow lift.

- **Interchangeable with Mercury's Flo-Torq® II hub system**
- **Tapered leading edges minimize drag**
- **Performance characteristics of racing style propellers**
- **Maintains optimum blade strength and thickness**
- **Ideal for the performance-minded boater**
- **Available in stainless steel, RH & LH rotation**

Recommend d Boat Applications: Bass Boats, Bay Boats, Flats Boats, Pontoons, Sport Boat Single, Sport Boat Dual, Skiboats

MICHIGAN PROPELLERS

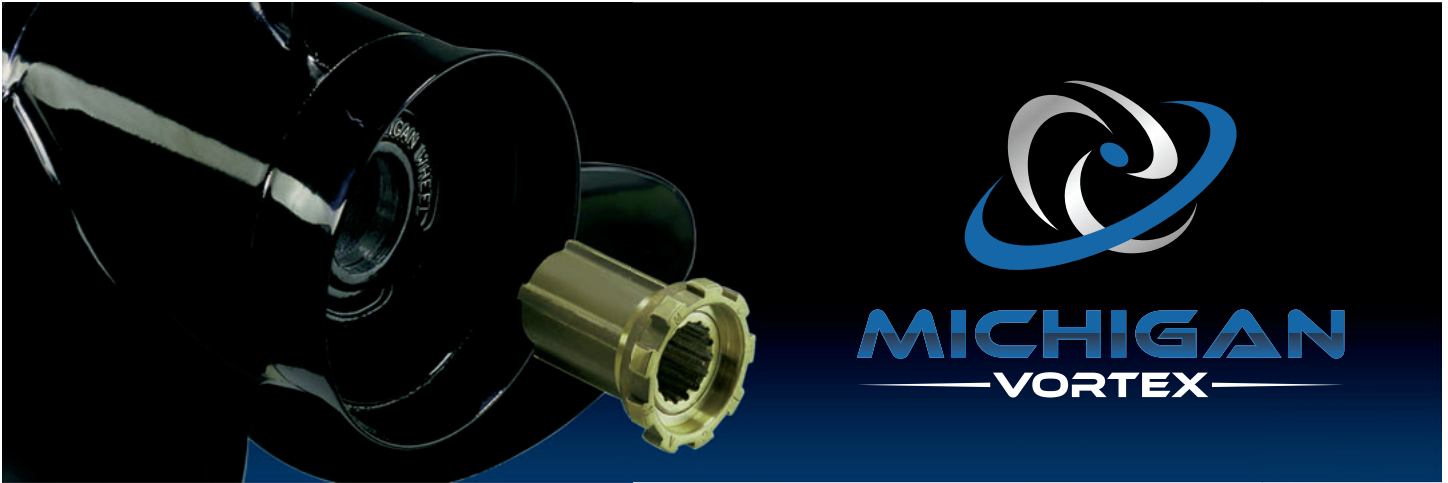

VORTEX® 3-BLADE

Michigan Wheel's high performance aluminum propeller utilizing XHS® / XHS II® Xchangeable Hub System. Featuring high performance blade geometry, precision balanced blades, high gloss powder coat and interchangeability with the Mercury Flo-Torq® II system, the Vortex® XHS® / XHS II® is a great choice for a replacement or spare propeller for boaters.

- 0 HP (9" - 17" pitch; RH rotation)
- V4 Outboard (10" - 21" pitch; RH rotation)
- V6 V8 OBSD (15" - 23" pitch; RH rotation)

Recommend d Boat Applications: Inflatables, Aluminum Consoles, Walleye Boats, Offshore Singles, Pontoons, Skiboats, Family Cruisers

VORTEX® 4-BLADE

For quicker planing, improved handling and acceleration. Vortex® 4-Blade aluminum propellers are a great alternative to a comparable 3-Blade propeller, offering enhanced performance when towing water skiers, tubers, knee and wakeboarders.

- 0 HP (8" - 10" pitch; RH rotation)
- V4 Outboard (11" - 19" pitch; RH rotation)
- V6 V8 OBSD (16" - 18" - 20" pitch; RH rotation)

Recommend d Boat Applications: Inflatables, Aluminum Consoles, Walleye Boats, Offshore Singles, Pontoons, Skiboats, Family Cruisers



MICHIGAN MATCH®

We pass the savings on to you in the form of a high quality, better-performing propeller that typically costs less than the engine manufacturer propeller you're replacing. Every Michigan Match® propeller features a NAVAL brass spindle with a rubber cushioned hub which absorbs impact and the stress caused by shifting gears. The rubber bushing is designed to spin free under significant impact, reducing the potential for lower unit damage. Great primary propeller, yet priced as a weekend-saver spare!

- Improved powder coating and beefier bushing
- Perfect replacement propeller
- Available in aluminum

Recommend d Boat Applications: Inflatables, Aluminum Consoles, Walleye Boats, Offshore Singles, Pontoons, Skiboats, Family Cruisers, Workboats, Houseboats

MICHIGAN PROPELLERS

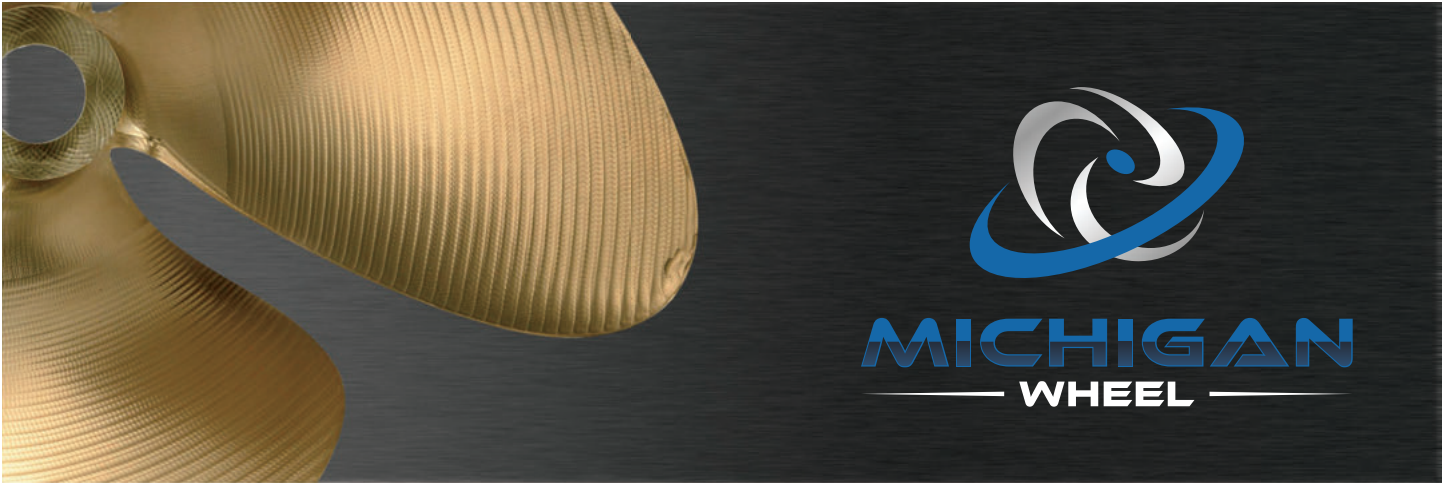

DYNA-JET® CUPPED



Michigan Wheel's Federal Series ski boat propellers provide consistent response to your throttle commands. The 3-Blade Dyna-Jet Cupped Propellers are made of a NiBrAl alloy which provides extra strength, less flex, and greater durability. All are cupped to minimize the performance draining effects of cavitation.



Part Number	Dia x Pitch	Rotation	Bore	Part Number	Dia x Pitch	Rotation	Bore	Part Number	Dia x Pitch	Rotation	Bore
310649	13" x 12"	LH	1"	310724	13" x 14"	RH	1"	310836	13" x 17"	RH	1"
310625	13" x 12-1/2"	LH	1-1/8"	310725	13" x 14"	LH	1"	311244	14" x 15"	RH	1"
310660	13" x 13"	RH	1"	310727	13" x 14"	LH	1-1/8"	311284	14" x 16"	RH	1"
310661	13" x 13"	LH	1"	310763	13" x 15"	LH	1"	311360	14" x 18"	RH	1-1/8"
310659	13" x 13"	LH	1-1/8"	310765	13" x 15"	LH	1-1/8"	311361	14" x 18"	LH	1-1/8"
310705	13" x 13-1/2"	LH	1-1/8"	310801	13" x 15-1/2"	LH	1-1/8"				

HOW TO USE APPLICATION CHART

- If the original equipment part number (OEM) is known and a size or style change is not desired, then refer to Part Number Cross Reference on Pages B8-B31 to locate the equivalent Michigan propeller.
- If an original part number is not known, the part number can not be found in the Part Number reference, or a propeller size or style change is desired, use the following procedure for selecting a propeller.

1. Locate the **BRAND** of outboard or sterndrive engine using the table of contents.
2. Locate the **HORSEPOWER/MODEL** and **YEAR** that corresponds with the engine brand.
3. Find the range of your **BOAT LENGTH**, and the boat use that best describes your vessel and usage.
4. Select the propeller **DIAMETER/PITCH** that best meets your vessel and usage. Refer to pages A3-A6 for information on choosing the right propeller.
5. Order the propeller using the **MICHIGAN PART NUMBER**. (If aluminum is desired, read across to the correct column for the part number. If stainless steel is desired, read across to the correct column for part number.)
6. If **VORTEX**®, **APOLLO**®, or **BALLISTIC**® propellers are selected, the **XHS**® / **XHS II**® **HUB KIT** indicated must be ordered.
7. Carefully read ALL notes for additional important attachment information. (If specific to a propeller, it will be noted next to the part number.)

Unless otherwise noted: The XHS® / XHS II® hub kit is sold separately from the propeller. See pages 40-41 for XHS® / XHS II® hub kit and miscellaneous hardware information. Vortex® and Apollo® propellers fit existing Mercury Flo-Torq® II hubs. Check existing hub for wear or damage and replace if necessary with Michigan Wheel XHS® / XHS II® hub.

NOTE: This is a "general" application guideline for determining the appropriate propeller size for your vessel. Performance characteristics may vary due to the many kinds of boats, hull styles, loads and style of boating.

MERCURY®, MARINER®, SEA RAY OUTBOARDS

40-140 HORSEPOWER • 4-1/4" GEARCASE Thru Hub Exhaust & 15 Tooth Spline

40 & 50 HP 4-Stroke / Bigfoot All Years	80 HP 1978-1989	100 HP 1988 & Newer
60 HP 4-Stroke / Bigfoot 1995 & Newer	80 HP (Mariner®) 1978-1983	115 HP (Yamaha®) 1978-1983
60 HP (Sea Pro/Marathon) 1995 & Newer	80 HP (Model 800; 2 & 4 Cyl.) Thru 1977	115 HP 1978 & Newer
65 HP (Model 650 - 2 Cyl.) Thru 1971	80 HP (Yamaha®) 1977-1983	115 HP 4-Stroke 2001 & Newer
65 HP (Model 650 - 4 Cyl.) 1961-1970	85 HP (Model 850; 2 & 4 Cyl.) Thru 1977	125 HP 1994-2005
70 HP 1987-1989	90 HP (Yamaha®) 1978-1983	140 HP (Includes Sea Pro/Offshore) 1978-1981
75 HP (Sea Pro/Marathon) All Years	90 HP 2-Stroke 1978 & Newer	140 HP (Yamaha®) 1978-1979
75 HP 2-Stroke 1984-2005	90 HP 4-Stroke 2001 & Newer	Models 900-1150-1500 Thru 1977
75 HP 4-Stroke 2001 & Newer		Includes EFI engines.

VORTEX MICHIGAN					APOLLO MICHIGAN					
3-BL ALUMINUM - B SERIES					4-BL ALUMINUM - B SERIES					Drop-In Hub
Dia.	Rot.	Pitch	Bld #	Part #	Dia.	Rot.	Pitch	Bld #	Part #	
14	R	11	3	992111	13-7/8	R	11	4	941411	Drop-In Hub
13-3/4	R	13	3	992112	13-7/8	R	13	4	941413	
13-1/2	R	15	3	992113	13-3/8	R	15	4	941415	Drop-In Hub
13-1/4	R	17	3	992114	13	R	17	4	941417	
13	R	19	3	992115	12-1/2	R	19	4	941419	Drop-In Hub
13	R	21	3	992116						

Boat Description/ Length	VORTEX MICHIGAN						BALLISTIC MICHIGAN						Drop-In Hub			
	ALUMINUM PROPELLERS						STAINLESS STEEL - B SERIES PROPELLERS									
	Dia.	Rot.	Pitch	Bld #	OEM Part #	Part #	3-BLADE BALLISTIC			3-BLADE BALLISTIC XL						
19'-24' - AL, SK	13-1/2	R	15	3	48-77342A45	031041	13-5/8	R	15	3	* 933415				Drop-In Hub	
17'-20' - AL, SK	13-1/4	R	17	3	48-77344A45	031042	13-1/2	R	17	3	* 933417					
16'-19' - AL, SK	13	R	4	3	48-77346A45	031043	13-3/8	R	19	3	* 933419				Drop-In Hub	
15'-18' - AL, SK	13	R	21	3	48-77348A45	031044	13-1/8	R	21	3	* 933421					
High Performance	12-1/2	R	23	3	48-77350A45	* 031045						13-1/2	R	22	3	* 953422
High Performance												13-1/2	R	24	3	* 953424

Key to Abbreviations: LL = Light Loads; SB = Sailboat; AL = All Loads; SK = Skiboat; WB = Workboat; HB = Houseboat; CR = Cruisers; HL = Heavy Loads; WD = Weedless

* Limited Inventory Item.

* To avoid damage or injury, replace standard trim tab with trim tab 822777A1.

* Pontoon Boat Propeller (Extended Cup)

6-15 HORSEPOWER

Non-Thru Hub Exhaust & Pin Drive

6 HP1966-1979 10 HP..... 1958-1963 8-15 HP.....2000 & Newer
 9.5 HP.....1964-1973 10, 12, 14 HP***..... 1982-1994

						
ALUMINUM PROPELLERS						
Boat Description/ Length	Dia.	Rot.	Pitch	Bld #	OEM Part #	Part #
14'-16' - AL	8-1/4	R	8	3	763588	012008
12'-14' - LL	8	R	7-1/4	2	763745	012005
12'-14' - LL	8-1/4	R	8-1/2	3	763586	012007



Rubber
Hub
Bushing
Part # 65-098

8, 9.9-15 HORSEPOWER • 2-1/2" GEARCASE

Thru Hub Exhaust & 13 Tooth Spline

8 HP 4-Stroke1996-2005 9.9 - 15 HP 2-Stroke..... 1974-2005 9.9, 15 HP 4-Stroke 1995-2001

						
ALUMINUM PROPELLERS						
Boat Description/ Length	Dia.	Rot.	Pitch	Bld #	OEM Part #	Part #
14'-16' - AL	10	R	7	3	763456	012112
Standard Replacement	9-1/2	R	10	3	778772	012111



Rubber
Hub
Bushing
Part # 65-234

9.9-15 HORSEPOWER • JOHNSON • 2-1/2" GEARCASE

Thru Hub Exhaust & 10 Tooth Spline

9.9 HP 4-Stroke2002-2007 15 HP 4-Stroke 2002-2007

						
ALUMINUM PROPELLERS						
Boat Description/ Length	Dia.	Rot.	Pitch	Bld #	OEM Part #	Part #
14'-19' - AL	9-1/4	R	9	3	5005384	062103
14'-19' - AL	9-1/4	R	10	3	5005385	062104
14'-16' - LL	9-1/4	R	11	3	5033203	062105



Rubber
Hub
Bushing
Part # 65-298

9.8 HORSEPOWER

Thru Hub Exhaust & 12 Tooth Spline

9.8 HP 4-Stroke2012 & Newer

						
ALUMINUM PROPELLERS						
Boat Description/ Length	Dia.	Rot.	Pitch	Bld #	OEM Part #	Part #
	8-1/2	R	7	3	5040538	142102
	8-1/2	R	8	3		142103





Rubber
Hub
Bushing
Part # 65-531

15 HORSEPOWER

Thru Hub Exhaust & 14 Tooth Spline





15 HP 4-Stroke 2012 & Newer

Boat Description/ Length							 142206	142204 Standard Replacement for: • 20" Shaft Length • 25" Shaft Length	Rubber Hub Bushing Part # 65-369
	ALUMINUM PROPELLERS								
	Dia.	Rot.	Pitch	Bld #	OEM Part #	Part #			
14'-19' - AL	9-1/4	R	8	3		142203			
Standard Replacement	9-1/4	R	9	3	5040590	142204			
Standard Replacement	9-1/4	R	10	3	5040591	142205			
14'-16' - LL	9-1/4	R	11	3	5040592	142206			
Up to 16' - LL	9-1/4	R	12	3		142207			

10-28 HORSEPOWER

Non-Thru Hub Exhaust & Pin Drive





10 HP 1951-1957 18 HP 1957-1973 25 HP 1969-1977
 15 HP 1953-1956 20 HP 1969-1973 28 HP 1964

Boat Description/ Length							 012102	 012011	 012013	Rubber Hub Bushing Part # 65-079
	ALUMINUM PROPELLERS									
	Dia.	Rot.	Pitch	Bld #	OEM Part #	Part #				
CR, HB, SB	9-1/4	R	7	3	388294	012102				
14'-16' - HL	9	R	9	3	763587	012109				
12'-14' - LL	9	R	10	3	763583	012011				
12'-14' - LL	9-1/4	R	11	3		012013				

14-28 HORSEPOWER

Non-Thru Hub Exhaust & 13 Tooth Spline



14 HP 1988-1989 25 HP** 1978-1991; 1994 & Newer 28 HP 1986-1996
 25 HP 1978-1984

Boat Description/ Length							 012015	 012016	 012030	Rubber Hub Bushing Part # 65-281
	ALUMINUM PROPELLERS									
	Dia.	Rot.	Pitch	Bld #	OEM Part #	Part #				
16'-18' - HL	9	R	9	3	763585	012021				
15'-17' - AL	9	R	10	3	763589	012015				
14'-17' - AL	9-1/4	R	11	3	763584	012016				
14'-17' - LL	9-1/4	R	12	3	763590	012030				

25-40 HORSEPOWER

Non-Thru Hub Exhaust & Pin Drive

25 HP 1951-1955 33 HP 1965-1970 40 HP 1960-1976
 28 HP 1962-1964 35 HP 1957-1959 40 HP** 1978-1985
 30 HP 1956

Boat Description/ Length							 012023	Rubber Hub Bushing Part # 65-126
	ALUMINUM PROPELLERS							
	Dia.	Rot.	Pitch	Bld #	OEM Part #	Part #		
17'-19' - AL, SK	10-3/8	R	11-1/2	3		012023		
14'-16' - AL, SK	10-1/2	R	12	3		012024		

Key to Abbreviations: LL = Light Loads; SB = Sailboat; AL = All Loads; SK = Skiboat; WB = Workboat; HB = Houseboat; CR = Cruisers; HL = Heavy Loads; WD = Weedless

** Commercial & Workhorse Application.

25-30 HORSEPOWER (4-STROKE) • 3" GEARCASE

Thru Hub Exhaust & 10 Tooth Spline • **MUST use Gearcase Adapter Ring supplied with propeller.**

25 HP 4-Stroke2004-2007 30 HP 4-Stroke 2004-2007

Boat Description/ Length	VORTEX MICHIGAN					
	ALUMINUM - E SERIES PROPELLERS					
	Dia.	Rot.	Pitch	Bld #	OEM Part #	Part #
20' & Up - AL	10-1/2	R	9	3		992501
17'-20' - AL	10-1/2	R	10	3		992502
17'-20' - AL	10-1/2	R	11	3		992503
15'-18' - AL	10-1/8	R	12	3		992504
13'-15' - AL	10-1/8	R	13	3		992505
Up to 15' - LL	10-1/8	R	14	3		992506

Drop-In Hub
Use XHS® or XHS II® Hub Kit
121
OR
221



Boat Description/ Length	MATCH MICHIGAN					
	ALUMINUM PROPELLERS					
	Dia.	Rot.	Pitch	Bld #	OEM Part #	Part #
20' & Up - AL	10-1/4	R	9	3	5032171	062208
20' & Up - AL	10-1/4	R	10	3	5032107	062204
17'-20' - AL	10-1/4	R	11	3	5032108	062205
15'-18' - AL	10-1/4	R	12	3	5032109	062206
13'-15' - AL	10-1/4	R	13	3	5032110	062207
13'-15' - AL	10-1/4	R	14	3	5032106	062209
Up to 15' - LL	10-1/4	R	15	3		062210

Rubber Hub Bushing
Part # 65-339

Boat Description/ Length	BALLISTIC MICHIGAN					
	STAINLESS STEEL - E SERIES PROPELLERS					
	Dia.	Rot.	Pitch	Bld #	OEM Part #	Part #
	10-1/8	R	13	3		* 933013
	10-1/8	R	15	3		* 933015

Drop-In Hub
Use XHS® or XHS II® Hub Kit
121
OR
221

* May interfere with trim tab.

15-35 HORSEPOWER • 3" GEARCASE

Thru Hub Exhaust & 14 Tooth Spline • **MUST use Gearcase Adapter Ring supplied with propeller.** • VORTEX® PROPELLER MAY INTERFERE WITH SKEG ON ANY MODEL

15 HP E-TEC® H.O.2011 & Newer 25 HP 2 & 3 Cyl.1984 & Newer 30 HP E-TEC®2009 & Newer
 20 HP 2 Cyl.1984-1997 25 HP E-TEC®2009 & Newer 35 HP 2 Cyl 1979-1983
 25 HP (Commercial)1993-2005 30 HP 2 Cyl.1984 & Newer 35 HP 3 Cyl 1997-2001

Boat Description/ Length	VORTEX MICHIGAN					
	ALUMINUM - E SERIES PROPELLERS					
	Dia.	Rot.	Pitch	Bld #	OEM Part #	Part #
17'-20' - AL, SK	10-1/2	R	9	3		992501
17'-20' - AL, SK	10-1/2	R	10	3		992502
16'-18' - AL, SK	10-1/2	R	11	3	765049	992503
16'-18' - AL, SK	10-1/8	R	12	3		992504
15'-17' - AL, SK	10-1/8	R	13	3	778863	992505
13'-15' - AL, SK	10-1/8	R	14	3		992506

Drop-In Hub
Use XHS® or XHS II® Hub Kit
118
OR
218



Boat Description/ Length	MATCH MICHIGAN					
	ALUMINUM PROPELLERS					
	Dia.	Rot.	Pitch	Bld #	OEM Part #	Part #
17'-20' - AL, SK	11	R	9	3	765048	012054
16'-18' - AL, SK	10-1/2	R	11	3	765049	012055
15'-17' - AL, SK	10	R	13	3	778863	012056
13'-15' - AL, SK	10	R	15	3	763486	012057
15'-17' - AL, SK	10	R	13	3	778863	012213

Rubber Hub Bushing
Part # 65-251

Boat Description/ Length	BALLISTIC MICHIGAN					
	STAINLESS STEEL - E SERIES PROPELLERS					
	Dia.	Rot.	Pitch	Bld #	OEM Part #	Part #
	10-1/8	R	13	3		933013
	10-1/8	R	15	3		933015

Drop-In Hub
Use XHS® or XHS II® Hub Kit
118
OR
218

40-50 HORSEPOWER • JOHNSON • 3-1/4" GEARCASE

Thru Hub Exhaust & 13 Tooth Spline

40 HP 4-Stroke1999-2005 50 HP 4-Stroke 1999-2005

VORTEX MICHIGAN				APOLLO MICHIGAN									
ALUMINUM - D SERIES PROPELLERS				STAINLESS STEEL - D SERIES PROPELLERS									
3-BLADE		LG. DIAMETER 3-BLADE		4-BLADE									
Dia.	Rot.	Pitch	Part #	Dia.	Rot.	Pitch	Part #	Dia.	Rot.	Pitch	Bld #	OEM Part #	Part #
				11-1/2	R	8	992401						
				12-1/4	R	9	992601	11-1/2	R	9			
				11-3/4	R	10	992602	11-1/2	R	10			
10-3/8	R	11	992404	11-5/8	R	11	992603	4-BLADE					
10-3/8	R	12	992405	11-3/8	R	12	992604	10-5/8	R	12			993405
10-3/8	R	13	992406	11-1/8	R	13	992605	10-3/8	R	13			993406
10-3/8	R	14	992407	11-1/4	R	14	992606	10-1/8	R	14			993407
10	R	15	992408					10-1/8	R	15			993408
10	R	16	992409										

Drop-In Hub

Use XHS® or XHS II® Hub Kit

115 OR 215

Refer to Pages 55-57 for Details on Hub Kit Components.

Drop-In Hub

Use XHS® or XHS II® Hub Kit

115 OR 215

Refer to Pages 55-57 for Details on Hub Kit Components.

		MATCH MICHIGAN				BALLISTIC MICHIGAN							
		ALUMINUM PROPELLERS				STAINLESS STEEL - D SERIES PROPELLERS							
Boat Description/Length		Dia.	Rot.	Pitch	Bld #	OEM Part #	Part #	Dia.	Rot.	Pitch	Bld #	OEM Part #	Part #
18'-21' - AL		12-1/4	R	9	3	776807	032046						
18'-21' - AL		11-3/4	R	10	3	778606	032045						
16'-19' - AL		11-1/2	R	11	3	778607	062211						
16'-19' - AL		11-1/2	R	12	3	778608	062212						
14'-18' - AL		11-1/2	R	13	3	778609	062213	10-1/8	R	13	3		933213
14'-18' - AL		11-1/2	R	14	3	778610	062214						
13'-15' - AL		11-1/4	R	15	3		062215	10-1/8	R	15	3		933215
13'-15' - LL		11-1/8	R	16	3		062216						
Up to 15' - LL		11	R	17	3		062217						

Rubber Hub Bushing

Part # 65-205

Drop-In Hub

Use XHS® or XHS II® Hub Kit

115 OR 215

Refer to Pages 55-57 for Details on Hub Kit Components.

40-75 HORSEPOWER • SMALL (3-3/8") GEARCASE

Thru Hub Exhaust & 13 Tooth Spline

40 HP 2 Cyl.....1984-2005 55 HP 1976-1979 75 HP 3 Cyl. 1975-1985
 48 HP.....1987-1996 65 HP 2 Cyl..... 1980-1985 Sprint/Formula E 1986-1992
 50 HP 2 Cyl.....1975-2005

VORTEX MICHIGAN				APOLLO MICHIGAN									
ALUMINUM - C SERIES PROPELLERS				STAINLESS STEEL - C SERIES PROPELLERS									
3-BLADE		LG. DIAMETER 3-BLADE		4-BLADE									
Dia.	Rot.	Pitch	Part #	Dia.	Rot.	Pitch	Part #	Dia.	Rot.	Pitch	Bld #	OEM Part #	Part #
				11-1/2	R	8	992401						
				11-1/2	R	9	992402						
				11-1/2	R	10	992403						
11-3/4	R	13	992301	12-1/2	R	13	992311						
11-3/4	R	15	992302	12-1/4	R	15	992312						
11-3/4	R	17	992303										



992303



012036



012037



011027

		MATCH MICHIGAN				BALLISTIC MICHIGAN							
		ALUMINUM PROPELLERS				STAINLESS STEEL - C SERIES PROPELLERS							
Boat Description/Length		Dia.	Rot.	Pitch	Bld #	OEM Part #	Part #	Dia.	Rot.	Pitch	Bld #	OEM Part #	Part #
CR, HB		13	R	11	3	763488	012036						
15'-18' - AL, SK		12-1/2	R	13	3	763461	012037						
14'-17' - AL, SK		12-1/4	R	15	3	778774	011027	12-3/8	R	15	3		933315
13'-15' - LL		11-3/4	R	17	3	763462	011028	12	R	17	3		933317

Rubber Hub Bushing

Part # 65-241

Drop-In Hub

Use XHS® or XHS II® Hub Kit

111 OR 211

Refer to Pages 55-57 for Details.

EVINRUDE / JOHNSON

40-75 HORSEPOWER • LARGE (4-1/4") GEARCASE

Thru Hub Exhaust & 13 Tooth Spline

40 HP E-TEC®2004 & Newer
45 HP 2 Cyl. Commercial1986-1995
50 HP E-TEC®2004 & Newer
50 HP 2 Cyl. Commercial1977-1979
50 HP 2 Cyl. Pleasure1971-1974
50 HP 3 Cyl. Pleasure1994-1998
55 HP 3 Cyl.1968-1969

55 HP 2 Cyl. Commercial1980 & Newer
55 HP E-TEC®2009 & Newer
60 HP 3 Cyl. Pleasure1970-1971; 1986-2001
60 HP E-TEC®2004 & Newer
60 HP 4-Stroke1998 & Newer
65 HP 3 Cyl. Pleasure1972-1973
65 HP 3 Cyl. Commercial1984-2001

65 HP Pontoon Series2014 & Newer
70 HP 3 Cyl. Pleasure1974 & Newer
70 HP 3 Cyl. Commercial1974-2001
70 HP 4-Stroke1998 & Newer
75 HP 3 Cyl. Pleasure1975-1984
75 HP E-TEC®2004 & Newer

VORTEX MICHIGAN						APOLLO MICHIGAN									
3-BL ALUMINUM - B SERIES			4-BL ALUMINUM - B SERIES			Drop-In Hub	STAINLESS STEEL - B SERIES PROPELLERS						Drop-In Hub		
Dia.	Rot.	Pitch	Bld #	Part #	Dia.		Rot.	Pitch	Bld #	OEM Part #	Part #				
14	R	10	3	992109											
14	R	11	3	992111	13-7/8	R	11	4	941411						
14	R	13	3	992112	13-7/8	R	13	4	941413						
13-3/4	R	15	3	992113	13-3/8	R	15	4	941415	13-3/8	R	15	3	763950	993143
										13-3/8	L	15	3		993153
13-1/4	R	17	3	992114	13	R	17	4	941417	13-1/4	R	17	3	763951	993144
										13-1/4	L	17	3		993154
13	R	19	3	992115	12-1/2	R	19	4	941419	13-1/8	R	19	3	763952	993145
										13-1/8	L	19	3		993155
12-3/4	R	21	3	992116						13	R	21	3		993146
										13	L	21	3		993156

Boat Description/ Length	MATCH MICHIGAN						Drop-In Hub	BALLISTIC MICHIGAN					
	ALUMINUM PROPELLERS							STAINLESS STEEL - B SERIES PROPELLERS					
	Dia.	Rot.	Pitch	Bld #	OEM Part #	Part #		Dia.	Rot.	Pitch	Bld #	OEM Part #	Part #
CR, HB	14	R	11	3	763301	012047							
19'-22' - AL	14	R	13	3	◆ 765181	011001	Rubber Hub Bushing Part # 65-172						
17'-19' - AL	13-3/4	R	15	3	◆ 765182	011002		13-5/8	R	15	3		933415
15'-17' - AL	13-1/4	R	17	3	◆ 765183	011003		13-1/2	R	17	3		933417
15'-17' - AL, SK	14	R	17	3	176214	* 011024							
14'-16' - AL	13	R	19	3	◆ 765184	011004		13-3/8	R	19	3		933419
14'-16' - AL, SK	14	R	19	3	176215	* 011025							
13'-15' - AL, SK	12-3/4	R	21	3	◆ 765185	011005		13-1/8	R	21	3		933421
14'-16' - AL	13-1/4	R	19	3	◆ 765184	011419							

Note: For 60 HP & 70 HP 4-Stroke engine applications, 1998 & Newer, use XHS II® (Drop-In Hub) Kit # 210. For all other engine applications use XHS II® (Drop-In Hub) Kit # 206.

Note: ◆ When replacing Interchangeable Hub Evinrude® aluminum propeller with Michigan Match, Michigan Match Thrust Washer P/N 990406 is required.



011003



011024



941413



990406



Key to Abbreviations: LL = Light Loads; SB = Sailboat; AL = All Loads; SK = Skiboat; WB = Workboat; HB = Houseboat; CR = Cruisers; HL = Heavy Loads; WD = Weedless

* If currently using uncupped propeller, use cupped propeller having 2" less pitch. Boats with power trim use same pitch.

85-140 HORSEPOWER • V-4 (4-1/4") GEARCASE

Thru Hub Exhaust & 13 Tooth Spline

85 HP.....1969-1980; 1991-1995	100 HP.....1979-1980; 1989-1993	120 HP.....1986-1994
88 HP.....1981-1996	110 HP.....1986-1989	125 HP.....1971-1972
90 HP.....1981 & Newer	112 HP.....1994-1996	130 HP E-TEC® (20" Shaft Length) . 2004-2010
90 HP E-TEC® (20" Shaft Length).....2004 & Newer	115 HP.....1973 & Newer	135 HP.....1973-1976
90 HP Pontoon Series.....2014 & Newer	115 HP E-TEC® (20" Shaft Length).....2004 & Newer	140 HP.....1977-1994

VORTEX MICHIGAN					4-BL ALUMINUM - B SERIES				
Dia.	Rot.	Pitch	Bld #	Part #	Dia.	Rot.	Pitch	Bld #	Part #
14	R	10	3	992109					
14	R	11	3	992111	13-7/8	R	11	4	941411
14	R	13	3	992112	13-7/8	R	13	4	941413
13-3/4	R	15	3	992113	13-3/8	R	15	4	941415
13-1/4	R	17	3	992114	13	R	17	4	941417
13	R	19	3	992115	12-1/2	R	19	4	941419
12-3/4	R	21	3	992116					

Drop-In Hub

Use XHS II® Hub Kit

206

Do NOT use Gearcase Adapter Ring supplied with propeller.

Refer to Pages 55-57 for Details on Hub Kit Components.

APOLLO MICHIGAN						STAINLESS STEEL - B SERIES PROPELLERS					
Dia.	Rot.	Pitch	Bld #	OEM Part #	Part #	Dia.	Rot.	Pitch	Bld #	OEM Part #	Part #
						13-3/8	R	15	3	763950	993143
						13-3/8	L	15	3		993153
						13-1/4	R	17	3	763951	993144
						13-1/4	L	17	3		993154
						13-1/8	R	19	3	763952	993145
						13-1/8	L	19	3		993155
						13	R	21	3		993146
						13	L	21	3		993156

Drop-In Hub

Use XHS II® Hub Kit

206

Do NOT use Gearcase Adapter Ring supplied with propeller.

Refer to Pages 55-57 for Details on Hub Kit Components.

Boat Description/Length	MATCH MICHIGAN					
	ALUMINUM PROPELLERS					
	Dia.	Rot.	Pitch	Bld #	OEM Part #	Part #
CR, HB	14	R	11	3	763301	012047
CR, HB	14	R	13	3	♦ 765181	011001
20'-24' - AL	13-3/4	R	15	3	♦ 765182	011002
19'-22' - AL	13-1/4	R	17	3	♦ 765183	011003
19'-22' - AL, SK	14	R	17	3	176214	011024
17'-19' - AL	13	R	19	3	♦ 765184	011004
17'-19' - AL, SK	14	R	19	3	176215	011025
15'-18' - AL, SK	12-3/4	R	21	3	♦ 765185	011005
14'-16' - AL	13-1/4	R	19	3	♦ 765184	011419
High Performance						
High Performance						

Rubber Hub

Bushing

Part # 65-172

BALLISTIC MICHIGAN														
3-BLADE BALLISTIC XHS						3-BLADE BALLISTIC XHS XL								
Dia.	Rot.	Pitch	Bld #	Part #		Dia.	Rot.	Pitch	Bld #	Part #				
						13-5/8	R	15	3	933415				
						13-1/2	R	17	3	933417				
						13-3/8	R	19	3	933419				
						13-1/8	R	21	3	933421				
										13-1/2	R	22	3	953422
										13-1/2	R	24	3	953424

Drop-In Hub

Use XHS II® Hub Kit

206

Do NOT use Gearcase Adapter Ring supplied with propeller.

Refer to Pages 55-57 for Details on Hub Kit Components.

Note: ♦ When replacing Interchangeable Hub Evinrude® aluminum propeller with Michigan Match, Michigan Match Thrust Washer P/N 990406 is required.



90, 115 & 140 HORSEPOWER • JOHNSON • 4-1/4" GEARCASE

Thru Hub Exhaust & 15 Tooth Spline

90 HP 4-Stroke2002-2005 115 HP 4-Stroke 2002-2005 140 HP 4-Stroke 2002-2005

		VORTEX MICHIGAN					APOLLO MICHIGAN											
		3-BL ALUMINUM - B SERIES					4-BL ALUMINUM - B SERIES					STAINLESS STEEL - B SERIES PROPELLERS						
		Dia.	Rot.	Pitch	Bld #	Part #	Dia.	Rot.	Pitch	Bld #	Part #	Dia.	Rot.	Pitch	Bld #	OEM Part #	Part #	
		14	R	10	3	992109												
		14	R	11	3	992111	13-7/8	R	11	4	941411							
		14	R	13	3	992112	13-7/8	R	13	4	941413							
		13-3/4	R	15	3	992113	13-3/8	R	15	4	941415	13-3/8	R	15	3	763950	993143	
												13-3/8	L	15	3		993153	
		13-1/4	R	17	3	992114	13	R	17	4	941417	13-1/4	R	17	3	793951	993144	
												13-1/4	L	17	3		993154	
		13	R	19	3	992115	12-1/2	R	19	4	941419	13-1/8	R	19	3	763952	993145	
												13-1/8	L	19	3		993155	
		12-3/4	R	21	3	992116						13	R	21	3		993146	
												13	L	21	3		993156	
		MATCH MICHIGAN					BALLISTIC MICHIGAN											
		ALUMINUM PROPELLERS					STAINLESS STEEL - B SERIES PROPELLERS											
		Dia.	Rot.	Pitch	Bld #	OEM Part #	Part #	3-BLADE BALLISTIC			3-BLADE BALLISTIC XL							
Boat Description/Length		Dia.	Rot.	Pitch	Bld #	OEM Part #	Part #	Dia.	Rot.	Pitch	Bld #	Part #	Dia.	Rot.	Pitch	Bld #	Part #	
	24' & Up - AL	14	R	15	3		061020	13-5/8	R	15	3	933415						
	20'-24' - AL, SK	14	R	17	3		061024	13-1/2	R	17	3	933417						
	20'-24' - AL	14	R	18	3		061026											
	17'-19' - AL, SK	14	R	19	3		061028	13-3/8	R	19	3	933419						
	16'-18' - AL, SK	14	R	21	3		061032	13-1/8	R	21	3	933421	13-1/2	R	22	3	953422	
	15'-18' - AL, SK												13-1/2	R	24	3	953424	

Drop-In Hub
Use XHS II® Hub Kit
225 / 226
USE Gearcase Adapter Ring supplied with propeller.
Refer to Pages 55-57 for Details on Hub Kit Components.

Drop-In Hub
Use XHS II® Hub Kit
225 / 226
USE Gearcase Adapter Ring supplied with propeller.
Refer to Pages 55-57 for Details on Hub Kit Components.

Rubber Hub Bushing
Part # 65-441

Drop-In Hub
Use XHS II® Hub Kit
225 / 226
USE Gearcase Adapter Ring supplied with propeller.

Note: For 90 HP & 115 HP 4-Stroke engine applications use XHS II® (Drop-In Hub) Kit # 225.
For 140 HP 4-Stroke engine applications use XHS II® (Drop-In Hub) Kit # 226.



061020



061028



200 & 225 HORSEPOWER • JOHNSON • 4-3/4" GEARCASE

Thru Hub Exhaust & 15 Tooth Spline • VORTEX® AND APOLLO® PROPELLER DIAMETERS ARE SLIGHTLY LESS THAN ORIGINAL EQUIPMENT PROPELLERS.

200 HP 4-Stroke2004-2005

225 HP 4-Stroke 2004-2005

VORTEX
MICHIGAN

APOLLO
MICHIGAN

3-BL ALUMINUM - A SERIES					4-BL ALUMINUM - A SERIES				
Dia.	Rot.	Pitch	Bld #	Part #	Dia.	Rot.	Pitch	Bld #	Part #
16	R	13	3	992001					
15-1/4	R	15	3	992002					
16	R	16	3	931516					
15	R	17	3	992003	15	R	16	4	992202
14-1/2	R	19	3	992004	14-1/2	R	18	4	992203
14-1/4	R	21	3	992005	14	R	20	4	992204
14	R	23	3	992006					

Drop-In Hub
Use XHS II® Hub Kit
204

Refer to Pages 55-57 for Details on Hub Kit Components.

STD. 3-BLADE A SERIES				LG DIA. 3-BLADE A SERIES				4-BLADE A SERIES			
Dia.	Rot.	Pitch	Part #	Dia.	Rot.	Pitch	Part #	Dia.	Rot.	Pitch	Part #
14-3/8	R	15	993042								
14-3/8	L	15	993052								
14-1/4	R	17	993043	15-1/2	R	17	993023	14-5/8	R	16	993203
14-1/4	L	17	993053	15-1/2	L	17	993033	14-5/8	L	16	993213
14-1/8	R	19	993044	15-1/4	R	19	993024	14-3/8	R	18	993204
14-1/8	L	19	993054	15-1/4	L	19	993034	14-3/8	L	18	993214
14	R	21	993045	14-3/4	R	21	993025	14-1/8	R	20	993205
14	L	21	993055	14-3/4	L	21	993035	14-1/8	L	20	993215
13-7/8	R	23	993046	14-5/8	R	23	993026	14	R	22	993206
13-7/8	L	23	993056	14-5/8	L	23	993036	14	L	22	993216

Drop-In Hub
Use XHS II® Hub Kit
204

Refer to Pages 55-57 for Details on Hub Kit Components.

BALLISTIC
MICHIGAN

STAINLESS STEEL - A SERIES PROPELLERS

3-BLADE BALLISTIC					3-BLADE BALLISTIC XL				
Dia.	Rot.	Pitch	Bld #	Part #	Dia.	Rot.	Pitch	Bld #	Part #
14-7/8	R	15	3	933515					
14-3/4	R	17	3	933517					
14-3/4	L	17	3	937517					
14-1/2	R	19	3	933519					
14-1/2	L	19	3	937519					
14-3/8	R	21	3	933521					
14-3/8	L	21	3	937521					
14-1/4	R	23	3	933523					
14-1/4	L	23	3	937523					
14-1/4	R	25	3	* 933525					
					14-3/4	R	22	3	* 953522
					14-3/4	R	24	3	* 953524
					14-3/4	R	26	3	* 953526

Drop-In Hub
Use XHS II® Hub Kit
204

Refer to Pages 55-57 for Details on Hub Kit Components.

* May interfere with trim tab.



150-300 HORSEPOWER • EVINRUDE® E-TEC® G2® GEARCASE

Thru Hub Exhaust & 15 Tooth Spline

150 HP G2.....	2016 & Newer
150 HP H.O. G2.....	2016 & Newer
175 HP G2.....	2016 & Newer
200 HP G2.....	2016 & Newer

200 HP H.O. G2.....	2014 & Newer
225 HP G2.....	2014 & Newer
225 HP H.O. G2.....	2014 & Newer

250 HP G2.....	2014 & Newer
250 HP H.O. G2.....	2014 & Newer
300 HP G2.....	2014 & Newer

EVINRUDE / JOHNSON

VORTEX
MICHIGAN

APOLLO
MICHIGAN

3-BL ALUMINUM - A SERIES					4-BL ALUMINUM - A SERIES				
Dia.	Rot.	Pitch	Bld #	Part #	Dia.	Rot.	Pitch	Bld #	Part #
16	R	13	3	992001					
15-1/4	R	15	3	992002					
16	R	16	3	931516					
15	R	17	3	992003	15	R	16	4	992202
14-1/2	R	19	3	992004	14-1/2	R	18	4	992203
14-1/4	R	21	3	992005	14	R	20	4	992204
14	R	23	3	992006					

Drop-In Hub

Use XHS II® Hub Kit **228**

Refer to Pages 55-57 for Details on Hub Kit Components.

STD. 3-BLADE A SERIES				LG DIA. 3-BLADE A SERIES				4-BLADE A SERIES			
Dia.	Rot.	Pitch	Part #	Dia.	Rot.	Pitch	Part #	Dia.	Rot.	Pitch	Part #
14-3/8	R	15	993042								
14-3/8	L	15	993052								
14-1/4	R	17	993043	15-1/2	R	17	993023	14-5/8	R	16	993203
14-1/4	L	17	993053	15-1/2	L	17	993033	14-5/8	L	16	993213
14-1/8	R	19	993044	15-1/4	R	19	993024	14-3/8	R	18	993204
14-1/8	L	19	993054	15-1/4	L	19	993034	14-3/8	L	18	993214
14	R	21	993045	14-3/4	R	21	993025	14-1/8	R	20	993205
14	L	21	993055	14-3/4	L	21	993035	14-1/8	L	20	993215
13-7/8	R	23	993046	14-5/8	R	23	993026	14	R	22	993206
13-7/8	L	23	993056	14-5/8	L	23	993036	14	L	22	993216

Drop-In Hub

Use XHS II® Hub Kit **228**

Refer to Pages 55-57 for Details on Hub Kit Components.

BALLISTIC
MICHIGAN

STAINLESS STEEL - A SERIES PROPELLERS

3-BLADE BALLISTIC					3-BLADE BALLISTIC XL				
Dia.	Rot.	Pitch	Bld #	Part #	Dia.	Rot.	Pitch	Bld #	Part #
14-7/8	R	15	3	933515					
14-3/4	R	17	3	933517					
14-3/4	L	17	3	937517					
14-1/2	R	19	3	933519					
14-1/2	L	19	3	937519					
14-3/8	R	21	3	933521					
14-3/8	L	21	3	937521					
14-1/4	R	23	3	933523					
14-1/4	L	23	3	937523	14-3/4	R	22	3	953522
14-1/4	R	25	3	933525	14-3/4	R	24	3	953524
					14-3/4	R	26	3	953526
					4-BLADE BALLISTIC XL				
					14-1/8	R	23	4	963523
					14-1/8	R	25	4	963525
					14-1/8	R	27	4	963527

Drop-In Hub

Use XHS II® Hub Kit **228**

Refer to Pages 55-57 for Details on Hub Kit Components.



90-300 HORSEPOWER • V-6 (4-3/4") GEARCASE (Includes E-TEC® & E-TEC® H.O. 25" Shaft Length)
 Thru Hub Exhaust & 15 Tooth Spline

90 HP.....1995 & Newer	135 HP.....2014 & Newer	225 HP (Includes E-TEC®).....1986 & Newer
90 HP E-TEC® (25" Shaft Length)2004 & Newer	140 (25") HP1989-1994	235 HP1978-1985
100 HP Commercial1984 & Newer	150 HP Commercial1995 & Newer	250 HP (Includes E-TEC®).....1991 & Newer
115 HP.....1995 & Newer	150 HP (Includes E-TEC®).....1978 & Newer	275 HP1986-1988
115 HP E-TEC® (25" Shaft Length)....2004 & Newer	150 HP Pontoon Series.....2014 & Newer	300 HP1988-1995; 09 & Newer
115 HP Pontoon Series.....2014 & Newer	155 HP Commercial1978 & Newer	2.6 Liter1984-1985
120-140 HP1985	175 HP (Includes E-TEC®).....1977 & Newer	3.6 Liter1986-1987
130 HP.....1995-1996	185 HP1984-1985	*For engines 300 HP or higher, use "High Horsepower Sleeve" (P/N 991372). See Page 48 for more details.
130 HP E-TEC® (25" Shaft Length)2009-2010	200 HP (Includes E-TEC®).....1976 & Newer	

VORTEX
MICHIGAN

3-BL ALUMINUM - A SERIES					4-BL ALUMINUM - A SERIES				
Dia.	Rot.	Pitch	Bld #	Part #	Dia.	Rot.	Pitch	Bld #	Part #
16	R	13	3	992001					
15-1/4	R	15	3	992002					
16	R	16	3	931516					
15	R	17	3	992003	15	R	16	4	992202
14-1/2	R	19	3	992004	14-1/2	R	18	4	992203
14-1/4	R	21	3	992005	14	R	20	4	992204
14	R	23	3	992006					

Drop-In Hub

Use XHS II® Hub Kit
200 / 201

Refer to Pages 55-57 for Details on Hub Kit Components.

APOLLO
MICHIGAN

STD. 3-BLADE A SERIES				LG DIA. 3-BLADE A SERIES				4-BLADE A SERIES			
Dia.	Rot.	Pitch	Part #	Dia.	Rot.	Pitch	Part #	Dia.	Rot.	Pitch	Part #
14-3/8	R	15	993042								
14-3/8	L	15	993052								
14-1/4	R	17	993043	15-1/2	R	17	993023	14-5/8	R	16	993203
14-1/4	L	17	993053	15-1/2	L	17	993033	14-5/8	L	16	993213
14-1/8	R	19	993044	15-1/4	R	19	993024	14-3/8	R	18	993204
14-1/8	L	19	993054	15-1/4	L	19	993034	14-3/8	L	18	993214
14	R	21	993045	14-3/4	R	21	993025	14-1/8	R	20	993205
14	L	21	993055	14-3/4	L	21	993035	14-1/8	L	20	993215
13-7/8	R	23	993046	14-5/8	R	23	993026	14	R	22	993206
13-7/8	L	23	993056	14-5/8	L	23	993036	14	L	22	993216

Drop-In Hub

Use XHS II® Hub Kit
200 / 201

Refer to Pages 55-57 for Details on Hub Kit Components.

MATCH
MICHIGAN

Boat Description/ Length	ALUMINUM PROPELLERS					
	Dia.	Rot.	Pitch	Bld #	OEM Part #	Part #
CR, HB	15-1/2	R	13	3	763453	011016
CR, HB	15-1/2	R	15	3	765186	011006
20'-26' - AL, SK	15	R	17	3	765187	011007
20'-26' - AL, SK						
18'-22' - AL, SK	14-1/2	R	19	3	765188	011008
18'-22' - AL, SK						
17'-19' - AL, SK	14-1/4	R	21	3	765189	011009
17'-19' - AL, SK						
15'-18' - AL, SK						
15'-18' - AL, SK						
High Performance						
High Performance						
50-62 MPH						
55-67 MPH						
60-72 MPH						

Rubber Hub Bushing
Part # 65-254

BALLISTIC
MICHIGAN

STAINLESS STEEL - A SERIES PROPELLERS									
3-BLADE BALLISTIC					3-BLADE BALLISTIC XL				
Dia.	Rot.	Pitch	Bld #	Part #	Dia.	Rot.	Pitch	Bld #	Part #
14-7/8	R	15	3	933515					
14-3/4	R	17	3	933517					
14-3/4	L	17	3	937517					
14-1/2	R	19	3	933519					
14-1/2	L	19	3	937519					
14-3/8	R	21	3	933521					
14-3/8	L	21	3	937521					
14-1/4	R	23	3	933523					
14-1/4	L	23	3	937523	14-3/4	R	22	3	953522
14-1/4	R	25	3	933525	14-3/4	R	24	3	953524
					14-3/4	R	26	3	953526
4-BLADE BALLISTIC XL									
					14-1/8	R	23	4	963523
					14-1/8	R	25	4	963525
					14-1/8	R	27	4	963527

Drop-In Hub

Use XHS II® Hub Kit
200 / 201

Refer to Pages 55-57 for Details on Hub Kit Components.

Note: For engine applications 1976-1990 use XHS II® (Drop-In Hub) Kit #201.
 For engine applications 1991 & Newer use XHS II® (Drop-In Hub) Kit #200.

3.5-8 HORSEPOWER

Non-Thru Hub Exhaust & 9 Tooth / Pin Drive

3.5 HP.....1982-1984	5 HP.....1987-1998	7 HP.....1968-1988
4 HP.....1977-1987	6 HP.....1975-1981	7.5 HP.....1979-1984
4.4 HP.....1968-1988	6.6 HP.....1968-1988	8 HP.....1975-1978

MATCH MICHIGAN						
ALUMINUM PROPELLERS						
Boat Description/ Length	Dia.	Rot.	Pitch	Bld #	OEM Part #	Part #
Standard Replacement	7-1/4	R	5-1/2	3	48-FP488	072123



Rubber Hub Bushing Part # 65-220

6-10 HORSEPOWER

Non-Thru Hub Exhaust & 14 Tooth / Pin Drive

6 & 10 HP Sailor.....1976-1977	Sailor 180.....1979-1984	Sailor 280.....1979
Sailor 150.....1978	Sailor 250.....1979-1984	

MATCH MICHIGAN						
ALUMINUM PROPELLERS						
Boat Description/ Length	Dia.	Rot.	Pitch	Bld #	OEM Part #	Part #
SB	10-3/8	R	10	3	FP-278	072014



Rubber Hub Bushing Part # 65-164

9.9-15 HORSEPOWER

Thru Hub Exhaust & 8 Tooth Spline

9.9 HP.....1996-1998	15 HP.....1996-1998
----------------------	---------------------

MATCH MICHIGAN						
ALUMINUM PROPELLERS						
Boat Description/ Length	Dia.	Rot.	Pitch	Bld #	OEM Part #	Part #
16'-20' - AL	9-1/4	R	7	3	48-828152A12	032056
14'-20' - AL	9	R	8	3	48-828154A12	032053
14'-18' - AL	9	R	9	3	48-828156A12	032052
14'-16' - AL	9	R	10-1/2	3	48-828158A12	032050



Rubber Hub Bushing Part # 65-429

25 HORSEPOWER • 3" GEARCASE

Thru Hub Exhaust & 10 Tooth Spline • **MUST use Gearcase Adapter Ring supplied with propeller.**

25 HP 3 Cyl.....1995-1998

VORTEX MICHIGAN						
ALUMINUM - E SERIES PROPELLERS						
Boat Description/ Length	Dia.	Rot.	Pitch	Bld #	OEM Part #	Part #
	10-1/2	R	9	3		992501
	10-1/2	R	10	3		992502
15'-19' - AL	10-1/2	R	11	3	48-19638A40	992503
15'-17' - AL	10-1/8	R	12	3		992504
13'-15' - LL	10-1/8	R	13	3	48-19640A40	992505
Up to 14' - LL	10-1/8	R	14	3		992506

Drop-In Hub
Use XHS® or XHS II® Hub Kit
120 OR 220

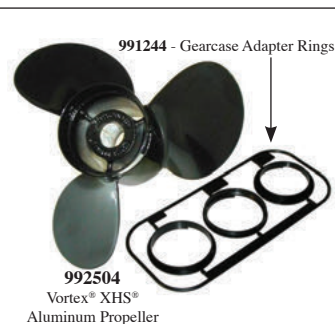

MATCH MICHIGAN						
ALUMINUM PROPELLERS						
Boat Description/ Length	Dia.	Rot.	Pitch	Bld #	OEM Part #	Part #
15'-19'	10-3/8	R	11	3	48-19638A40	031049
13'-15'	10-3/8	R	13	3	48-19640A40	031048
Up to 14'						

Rubber Hub Bushing Part # 65-308

BALLISTIC MICHIGAN						
STAINLESS STEEL - E SERIES PROPELLERS						
Boat Description/ Length	Dia.	Rot.	Pitch	Bld #	OEM Part #	Part #
	10-1/8	R	13	3		933013
	10-1/8	R	15	3		933015

Drop-In Hub
Use XHS® or XHS II® Hub Kit

120 OR 220

Note: * May interfere with trim tab.

Key to Abbreviations: LL = Light Loads; SB = Sailboat; AL = All Loads; SK = Skiboat; WB = Workboat; HB = Houseboat; CR = Cruisers; HL = Heavy Loads; WD = Weedless

FORCE / CHRYSLER / US MARINE

20-60 HORSEPOWER

Non-Thru Hub Exhaust & 14 Tooth / Pin Drive • Will fit Sailor 6-10 HP engines, as required for RPM

20-25 HP.....1979-1981	40 HP.....1992-1994	55 HP ❖❖.....1966-1983
30 HP.....1966-1976	45 HP.....1966-1984	60 HP ❖❖.....1966-1975
35 HP.....1966-1991	50 HP.....1982-1994	

Boat Description/ Length	MATCH MICHIGAN					
	ALUMINUM PROPELLERS					
	Dia.	Rot.	Pitch	Bld #	OEM Part #	Part #
CR, HB, SB	10-3/8	R	10	3	48-819337A40	072014
17'-19' - AL, SK	10-3/8	R	11-1/2	3	48-819336A40	072131
16'-17' - AL, SK	10-3/8	R	12-1/2	3	48-819335A40	072132
14'-16' - AL, SK	10-3/8	R	13-1/2	3	48-819334A40	072133



072014

Rubber
Hub
Bushing
Part # 65-164

FORCE / CHRYSLER /
U.S. MARINE

40-75 HORSEPOWER • 3-1/4" GEARCASE

Thru Hub Exhaust & 13 Tooth Spline

40 HP.....1995-1998	70 HP.....1991-1995	75 HP.....1996-1998
50 HP.....1995-1998		

VORTEX MICHIGAN											
ALUMINUM - D SERIES PROPELLERS											
3-BLADE				LG. DIAMETER 3-BLADE			4-BLADE				
Dia.	Rot.	Pitch	Part #	Dia.	Rot.	Pitch	Part #	Dia.	Rot.	Pitch	Part #
								11-1/2	R	8	992401
				12-1/4	R	9	992601	11-1/2	R	9	992402
				11-3/4	R	10	992602	11-1/2	R	10	992403
10-3/8	R	11	992404	11-5/8	R	11	992603	4-BLADE			
10-3/8	R	12	992405	11-3/8	R	12	992604	10-5/8	R	12	941212
10-3/8	R	13	992406	11-1/8	R	13	992605	10-3/8	R	13	941213
10-3/8	R	14	992407	11-1/4	R	14	992606	10-1/8	R	14	941214
10	R	15	992408					10-1/8	R	15	941215
10	R	16	992409								

Drop-In
Hub
Use XHS®
or XHS II®
Hub Kit

114
OR
214

Refer to
Pages 55-57
for Details
on Hub Kit
Components.

APOLLO MICHIGAN						
STAINLESS STEEL - D SERIES PROPELLERS						
Dia.	Rot.	Pitch	Bld #	OEM Part #	Part #	
10-3/4	R	12	3		993405	
10-1/2	R	13	3		993406	
10-3/8	R	14	3		993407	
10-1/8	R	15	3		993408	

Drop-In
Hub

Use XHS®
or XHS II®
Hub Kit

114
OR
214

Refer to
Pages 55-57
for Details
on Hub Kit
Components.

Boat Description/ Length	MATCH MICHIGAN					
	ALUMINUM PROPELLERS					
	Dia.	Rot.	Pitch	Bld #	OEM Part #	Part #
19' & Up	12-1/2	R	8	3	48-42738A10	032141
19' & Up	12-1/4	R	9	3		032143
17'-19' - AL, SK	11-1/4	R	10	3	48-73132A40	031015
16'-18' - AL, SK	12	R	10-1/2	3	48-42740A10	032142
16'-18' - AL, SK	10-7/8	R	11	3	48-85632A40	031053
15'-17' - AL, SK	10-3/4	R	12	3	48-816702A40	031056
15'-17' - AL, SK	10-5/8	R	12	3	48-73134A40	031016
14'-17' - AL, SK	10-1/2	R	13	3	48-816704A40	031057
14'-17' - AL, SK	10-3/8	R	13	3	48-73136A40	031017
14'-16' - LL	10-3/8	R	14	3	48-816706A40	031058
14'-16' - LL	10-1/4	R	14	3	48-73138A40	031018
13'-15' - LL	10-1/8	R	15	3	48-73140A40	031019
Up to 15'	10	R	17	3	48-73144A40	031020

Rubber
Hub
Bushing
Part # 65-264

BALLISTIC MICHIGAN						
STAINLESS STEEL - D SERIES PROPELLERS						
Dia.	Rot.	Pitch	Bld #	OEM Part #	Part #	
10-1/8	R	13	3		933213	
10-1/8	R	15	3		933215	

Drop-In
Hub

Use XHS®
or XHS II®
Hub Kit

114
OR
214

Refer to
Pages 55-57
for Details
on Hub Kit
Components.

Key to Abbreviations: LL = Light Loads; SB = Sailboat; AL = All Loads; SK = Skiboat; WB = Workboat; HB = Houseboat; CR = Cruisers; HL = Heavy Loads; WD = Weedless

❖❖ Two-piece lower unit.

75-140 HORSEPOWER • SINGLE EXHAUST UNITS ❖ (SEE BELOW)

Non-Thru Hub Exhaust & 15 Tooth Spline

75 HP Std. & Charger1980-1984	105 HP1977-1978; 1982	135 HP1977
85 HP Std. & Charger1978-1989	115 HP Std. & Charger1978-1984	140 HP1978-1984
90 HP1983-1984	120 HP1977	
100 HP1979-1984	125 HP1977; 1982; 1985-1989	

Boat Description/ Length	MATCH MICHIGAN					
	ALUMINUM PROPELLERS					
	Dia.	Rot.	Pitch	Bld #	OEM Part #	Part #
16'-17' - AL, SK	13-1/8	R	15	3	FPS519	072055
14'-16' - AL, SK	13-1/4	R	17	3	FPS623	072107
14'-16' - LL	13	R	19	3	FPS625	072108



Rubber
Hub
Bushing
Part # 65-376

85-150 HORSEPOWER • DUAL EXHAUST UNITS • 4-1/4" GEARCASE (SEE BELOW)

Thru Hub Exhaust & 15 Tooth Spline

85 HP1988-1989	120 HP1990-1994	150 HP1989-1994
90 HP1990-1994	120 HP L-Drive1989-1991	150 HP L-Drive1991
90 HP L-Drive1989-1991	125 HP1988-1989	

VORTEX MICHIGAN				
3-BL ALUMINUM - B SERIES			4-BL ALUMINUM - B SERIES	
Dia.	Rot.	Pitch	Bld #	Part #
14	R	10	3	992109
14	R	11	3	992111
14	R	13	3	992112
13-3/4	R	15	3	992113
13-1/4	R	17	3	992114
13	R	19	3	992115
12-3/4	R	21	3	992116

Drop-In
Hub
Use XHS
II®
Hub Kit
202

Do NOT use
Gearcase
Adapter Ring
supplied with
propeller.



941417

071036



072128

072127

Boat Description/ Length	MATCH MICHIGAN					
	ALUMINUM PROPELLERS					
	Dia.	Rot.	Pitch	Bld #	OEM Part #	Part #
17'-22' - AL, SK	13-1/2	R	15	3	48-FP669-1	* 071035
17'-22' - AL, SK	13-1/2	R	15	3	48-FP692-1	072127
16'-20' - AL, SK	13-1/2	R	17	3	48-FP685-1	* 071036
16'-20' - AL, SK	13-1/2	R	17	3	48-FP685-1	072128

Rubber
Hub
Bushing
Part # 65-262

Single vs. Dual Exhaust

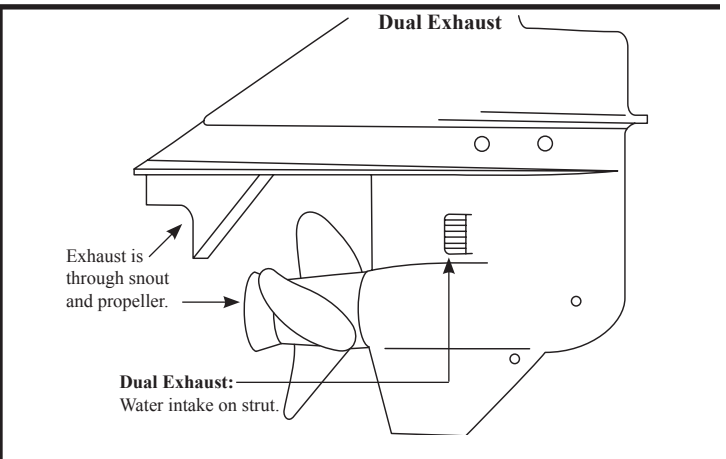
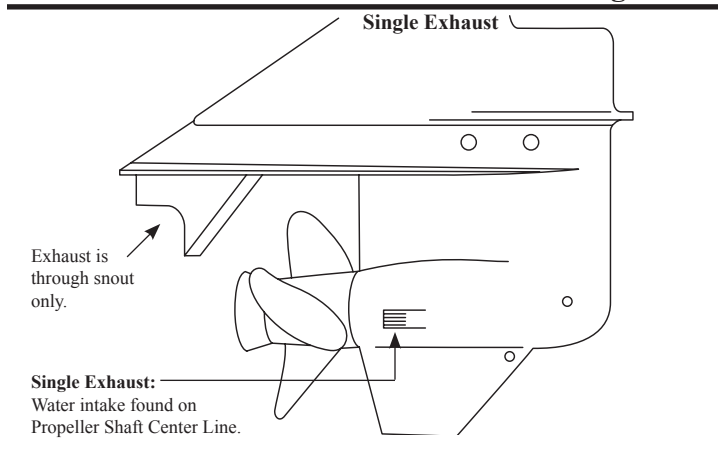

Key to Abbreviations: LL = Light Loads; SB = Sailboat; AL = All Loads; SK = Skiboat; WB = Workboat; HB = Houseboat; CR = Cruisers; HL = Heavy Loads; WD = Weedless

* If currently using uncupped propeller, use cupped propeller having 2" less pitch. Boats with power trim use same pitch.

75-150 HORSEPOWER • USING MERCURY 4-1/4" GEARCASE (SEE BELOW)

Thru Hub Exhaust & 15 Tooth Spline

75 HP1999	120 HP1995 & Newer	150 HP1989-1994
90 HP1995 & Newer	120 HP L-Drive1990-1991	150 HP L-Drive1991
90 HP L-Drive1990-1991		

VORTEX
MICHIGAN

3-BL ALUMINUM - B SERIES					4-BL ALUMINUM - B SERIES				
Dia.	Rot.	Pitch	Bld #	Part #	Dia.	Rot.	Pitch	Bld #	Part #
14	R	10	3	992109					
14	R	11	3	992111	13-7/8	R	11	4	941411
14	R	13	3	992112	13-7/8	R	13	4	941413
13-3/4	R	15	3	992113	13-3/8	R	15	4	941415
13-1/4	R	17	3	992114	13	R	17	4	941417
13	R	19	3	992115	12-1/2	R	19	4	941419
12-3/4	R	21	3	992116					

Drop-In Hub

Use XHS II® Hub Kit
202

USE Gearcase Adapter Ring supplied with propeller.

Refer to Pages 55-57 for Details on Hub Kit Components.

APOLLO
MICHIGAN

STAINLESS STEEL - B SERIES PROPELLERS					
Dia.	Rot.	Pitch	Bld #	OEM Part #	Part #
13-3/8	R	15	3		993143
13-3/8	L	15	3		993153
13-1/4	R	17	3		993144
13-1/4	L	17	3		993154
13-1/8	R	19	3		993145
13-1/8	L	19	3		993155
13	R	21	3		993146
13	L	21	3		993156

Drop-In Hub

Use XHS II® Hub Kit
202

USE Gearcase Adapter Ring supplied with propeller.

Refer to Pages 55-57 for Details on Hub Kit Components.

MATCH
MICHIGAN

Boat Description/Length	ALUMINUM PROPELLERS					
	Dia.	Rot.	Pitch	Bld #	OEM Part #	Part #
25' & Up - AL	14	R	10	3		031061
25' & Up	14	R	11	3	48-77338A45	031254
22' & Up	14	R	13	3	48-77340A45	031055
19'-24' - AL	13-1/2	R	15	3	48-77342A45	031041
17'-20' - AL, SK	13-1/4	R	17	3	48-77344A45	031042
16'-19' - AL	13	R	19	3	48-77346A45	031043
15'-18' - AL	12-3/4	R	21	3	48-77348A45	031044

Rubber Hub Bushing
Part # 65-444

BALLISTIC
MICHIGAN

STAINLESS STEEL - B SERIES PROPELLERS									
3-BLADE BALLISTIC					3-BLADE BALLISTIC XL				
Dia.	Rot.	Pitch	Bld #	Part #	Dia.	Rot.	Pitch	Bld #	Part #
13-5/8	R	15	3	933415					
13-1/2	R	17	3	933417					
13-3/8	R	19	3	933419					
13-1/8	R	21	3	933421	13-1/2	R	22	3	* 953422
					13-1/2	R	24	3	* 953424

Drop-In Hub

Use XHS II® Hub Kit
202

USE Gearcase Adapter Ring supplied with propeller.

Refer to Pages 55-57 for Details on Hub Kit Components.

Note: * Requires Michigan Wheel high performance trim tab P/N 990404.



031042



031043



990404

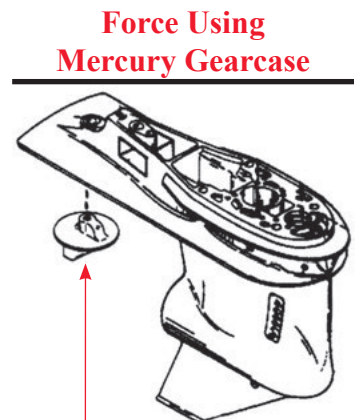

Force Using Mercury Gearcase

Exhaust is through propeller only. No exhaust snout, trim tab only.

Key to Abbreviations: LL = Light Loads; SB = Sailboat; AL = All Loads; SK = Skiboat; WB = Workboat; HB = Houseboat; CR = Cruisers; HL = Heavy Loads; WD = Weedless

* Limited Inventory Item.

For all units 1995 & Newer. Requires thrust washer 13191A1.

FORCE / CHRYSLER / U.S. MARINE

7.5-10 HORSEPOWER

Non-Thru Hub Exhaust & Pin Drive

BF 7.5.....1978-1987 BF 8..... 1987-1999 BF 100 (10 HP)All Years

Boat Description/ Length	MATCH MICHIGAN					
	ALUMINUM PROPELLERS					
	Dia.	Rot.	Pitch	Bld #	OEM Part #	Part #
16' & Up - LL	9-1/4	R	7	3		012102
14'-16' - LL	9	R	9	3	58130-881-840ZA	012109
12'-14' - LL	9	R	10	3		012011
12'-14' - LL	9-1/4	R	11	3		012013



Rubber
Hub
Bushing
Part # 65-079

8-20 HORSEPOWER • 2-1/2" GEARCASE

Thru Hub Exhaust & 8 Tooth Spline

BF 8.....2000 & Newer BF 15.....1991 & Newer BF 20.....2003 & Newer
BF 9.9.....1988 & Newer

Boat Description/ Length	MATCH MICHIGAN					
	ALUMINUM PROPELLERS					
	Dia.	Rot.	Pitch	Bld #	OEM Part #	Part #
15'-17' - AL	9-1/4	R	8	3	58130-ZV4-008AH	102003
14'-16' - AL	9-1/4	R	9	3	58130-ZV4-009AH	102004
14'-16' - AL	9-1/4	R	9-3/4	3		102106
Up to 15' - LL	9-1/4	R	10-1/2	3	58130-ZV4-010AH	102005
Up to 15' - LL	9-1/4	R	12	3		102107



Rubber
Hub
Bushing
Part # 65-359

Refer to
Pages 53-54
for Details
on Attachment
Hardware
Components.

25-30 HORSEPOWER • 3" GEARCASE

Thru Hub Exhaust & 10 Tooth Spline • **MUST use Gearcase Adapter Ring supplied with propeller.**

BF 25.....1994 & Newer BF 30.....1995 & Newer

Boat Description/ Length	VORTEX MICHIGAN					
	ALUMINUM - E SERIES PROPELLERS					
	Dia.	Rot.	Pitch	Bld #	OEM Part #	Part #
20' & Up	10-1/2	R	9	3		992501
20' & Up	10-1/2	R	10	3		992502
17'-20' - AL	10-1/2	R	11	3	48-19638A40	992503
15'-18' - AL	10-1/8	R	12	3		992504
13'-15' - LL	10-1/8	R	13	3	48-19640A40	992505
13'-15' - LL	10-1/8	R	14	3		992506

Drop-In
Hub
Use XHS®
or XHS II®
Hub Kit
119
OR
219

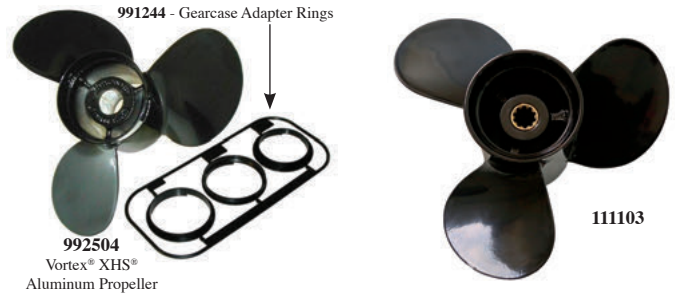

Boat Description/ Length	MATCH MICHIGAN					
	ALUMINUM PROPELLERS					
	Dia.	Rot.	Pitch	Bld #	OEM Part #	Part #
20' & Up	9-7/8	R	9	3	58130-ZW2-F11AZ	111103
18'-20' - AL	9-7/8	R	10	3	58130-ZW2-F21ZA	111107
17'-20' - AL	9-7/8	R	11	3	58130-ZW2-F31ZA	111105
15'-18' - AL	9-7/8	R	12	3	58130-ZW2-F01ZA	111106
13'-15' - LL	9-7/8	R	13	3	58130-ZW2-F41AZ	111108
Up to 15' - LL						

Rubber
Hub
Bushing
Part # 65-448
Refer to
Pages 53-54
for Details
on Attachment
Hardware
Components.

Boat Description/ Length	BALLISTIC MICHIGAN					
	STAINLESS STEEL - E SERIES PROPELLERS					
	Dia.	Rot.	Pitch	Bld #	OEM Part #	Part #
	10-1/8	R	13	3		* 933013
	10-1/8	R	15	3		* 933015

Drop-In
Hub
Use XHS®
or XHS II®
Hub Kit
119
OR
219

Note: * May interfere with trim tab.

35-60 HORSEPOWER • 3-1/4" GEARCASE

Thru Hub Exhaust & 13 Tooth Spline

BF 35.....1991-1994	BF 45..... 1991-1994	BF 60 / 60A2010 & Newer
BF 40..... 1995 & Newer	BF 50 / 50A 1995 & Newer	

VORTEX MICHIGAN										Drop-In Hub Use XHS® or XHS II® Hub Kit 113 OR 213 <small>Refer to Pages 55-57 for Details on Hub Kit Components.</small>	APOLLO MICHIGAN							Drop-In Hub Use XHS® or XHS II® Hub Kit 113 OR 213 <small>Refer to Pages 55-57 for Details on Hub Kit Components.</small>	
ALUMINUM - D SERIES PROPELLERS											STAINLESS STEEL - D SERIES PROPELLERS								
3-BLADE				LG. DIAMETER 3-BLADE			4-BLADE				Nearest Equivalent OEM Part #								
Dia.	Rot.	Pitch	Part #	Dia.	Rot.	Pitch	Part #	Dia.	Rot.		Pitch	Bld #	OEM Part #	Part #					
								11-1/2	R		8								
				12-1/4	R	9	992601	11-1/2	R		9								
				11-3/4	R	10	992602	11-1/2	R		10								
10-3/8	R	11	992404	11-5/8	R	11	992603	4-BLADE											
10-3/8	R	12	992405	11-3/8	R	12	992604	10-5/8	R		12		59133-ZV5-012AH	993405					
10-3/8	R	13	992406	11-1/8	R	13	992605	10-3/8	R		13		59133-ZV5-013AH	993406					
10-3/8	R	14	992407	11-1/4	R	14	992606	10-1/8	R	14		59133-ZV5-014AH	993407						
10	R	15	992408					10-1/8	R	15		59133-ZV5-015AH	993408						
10	R	16	992409																
MATCH MICHIGAN										Rubber Hub Bushing Part # 65-205 <small>Refer to Pages 53-54 for Details on Attachment Hardware Components.</small>	BALLISTIC MICHIGAN							Drop-In Hub Use XHS® or XHS II® Hub Kit 113 OR 213 <small>Refer to Pages 55-57 for Details on Hub Kit Components.</small>	
ALUMINUM PROPELLERS											STAINLESS STEEL - D SERIES PROPELLERS								
Boat Description/Length		Dia.	Rot.	Pitch	Bld #	OEM Part #	Part #	Dia.	Rot.		Pitch	Bld #	OEM Part #	Part #					
Pontoon		12-1/4	R	9	3	59130-ZV5-009AH	032046												
17' & Up - AL, SK		11-3/4	R	10	3	59130-ZV5-860ZA	032045												
16'-18' - AL, SK		11-5/8	R	11	3	59130-ZV5-011AH	032044												
15'-17' - CUPPED		10-5/8	R	12	3		031074												
15'-17' - AL, SK		11-3/8	R	12	3	59130-ZV5-012AH	032043												
14'-17' - CUPPED		10-3/8	R	13	3		031075												
14'-17' - AL, SK		11-1/8	R	13	3	59130-ZV5-013AH	032042	10-1/8	R		13	3		933213					
14'-16' - CUPPED		10-1/4	R	14	3		031076												
14'-16' - AL, SK		11-1/4	R	14	3	59130-ZV5-014AH	032041												
13'-15' - AL, SK		11	R	15	3	59130-ZV5-015AH	032040	10-1/8	R	15	3		933215						

HONDA



032046



031074



Key to Abbreviations: LL = Light Loads; SB = Sailboat; AL = All Loads; SK = Skiboat; WB = Workboat; HB = Houseboat; CR = Cruisers; HL = Heavy Loads; WD = Weedless

60-130 HORSEPOWER • 4-1/4" GEARCASE

Thru Hub Exhaust & 15 Tooth Spline

BFP 60.....2010 & Newer	BF 90.....1995 & Newer	BF 115.....1998-2010
BF 75.....1995 & Newer	BF 100.....2016 & Newer	BF 130.....1998-2004

VORTEX
MICHIGAN

APOLLO
MICHIGAN

3-BL ALUMINUM - B SERIES					4-BL ALUMINUM - B SERIES				
Dia.	Rot.	Pitch	Bld #	Part #	Dia.	Rot.	Pitch	Bld #	Part #
14	R	10	3	992109					
14	R	11	3	992111	13-7/8	R	11	4	941411
14	R	13	3	992112	13-7/8	R	13	4	941413
13-3/4	R	15	3	992113	13-3/8	R	15	4	941415
13-1/4	R	17	3	992114	13	R	17	4	941417
13	R	19	3	992115	12-1/2	R	19	4	941419
12-3/4	R	21	3	992116					

Drop-In Hub
Use XHS II® Hub Kit
202 / 207
USE Gearcase Adapter Ring supplied with propeller.
Refer to Pages 55-57 for Details on Hub Kit Components.

STAINLESS STEEL - B SERIES PROPELLERS						
Dia.	Rot.	Pitch	Bld #	OEM Part #	Part #	
13-3/8	R	15	3	58133-ZW1-A15P		993143
13-3/8	L	15	3			993153
13-1/4	R	17	3			993144
13-1/4	L	17	3			993154
13-1/8	R	19	3			993145
13-1/8	L	19	3			993155
13	R	21	3			993146
13	L	21	3			993156

Drop-In Hub
Use XHS II® Hub Kit
202 / 207
USE Gearcase Adapter Ring supplied with propeller.
Refer to Pages 55-57 for Details on Hub Kit Components.

MATCH
MICHIGAN

BALLISTIC
MICHIGAN

Boat Description/Length	ALUMINUM PROPELLERS					
	Dia.	Rot.	Pitch	Bld #	OEM Part #	Part #
25' & Up - AL	14	R	10	3		031061
25' & Up	14	R	11	3	58130-ZW1-011AH	031254
22' & Up	14	R	13	3	58130-ZW1-013AH	031055
19'-24' - AL	13-3/4	R	15	3	58130-ZW1-015AH	031041
17'-20' - AL, SK	13-1/4	R	17	3	58130-ZW1-017AH	031042
16'-19' - AL	13	R	19	3	58130-ZW1-019AH	031043
15'-18' - AL	12-3/4	R	21	3	58130-ZW1-021AH	031044
Up to 17' - LL	12-1/2	R	23	3	58130-ZW1-W512A	Ⓢ 031045

Rubber Hub Bushing
Part # 65-444
Refer to Pages 53-54 for Details on Attachment Hardware Components.

STAINLESS STEEL - B SERIES PROPELLERS									
3-BLADE BALLISTIC					3-BLADE BALLISTIC XL				
Dia.	Rot.	Pitch	Bld #	Part #	Dia.	Rot.	Pitch	Bld #	Part #
13-5/8	R	15	3	Ⓢ 933415					
13-1/2	R	17	3	Ⓢ 933417					
13-3/8	R	19	3	Ⓢ 933419					
13-1/8	R	21	3	Ⓢ 933421	13-1/2	R	22	3	Ⓢ 953422
					13-1/2	R	24	3	Ⓢ 953424

Drop-In Hub
Use XHS II® Hub Kit
202 / 207
USE Gearcase Adapter Ring supplied with propeller.
Refer to Pages 55-57 for Details on Hub Kit Components.

Ⓢ May interfere with trim tab.

Note: For BF 75 & BF 90 HP 1995-1998 engine applications use XHS II® (Drop-In Hub) Kit #202.
For BF 75 & BF 90 HP 1999 & Newer engine applications use XHS II® (Drop-In Hub) Kit #207.
For BFP 60, BF 115 & BF 130 HP 1998 & Newer engine applications use XHS II® (Drop-In Hub) Kit #207.



031042



031043



115-250 HORSEPOWER • 4-3/4" GEARCASE

Thru Hub Exhaust & 15 Tooth Spline

BF 1152011 & Newer
 BF 1352004 & Newer

BF 1502004 & Newer
 BF 2002002 & Newer

BF 2252002 & Newer
 BF 2502012 & Newer

VORTEX
MICHIGAN

3-BL ALUMINUM - A SERIES					4-BL ALUMINUM - A SERIES				
Dia.	Rot.	Pitch	Bld #	Part #	Dia.	Rot.	Pitch	Bld #	Part #
16	R	13	3	992001					
15-1/4	R	15	3	992002					
16	R	16	3	931516					
15	R	17	3	992003	15	R	16	4	992202
14-1/2	R	19	3	992004	14-1/2	R	18	4	992203
14-1/4	R	21	3	992005	14	R	20	4	992204
14	R	23	3	992006					

Drop-In Hub

Use XHS II[®] Hub Kit

207

Refer to Pages 55-57 for Details on Hub Kit Components.

APOLLO
MICHIGAN

STD. 3-BLADE A SERIES				LG DIA. 3-BLADE A SERIES				4-BLADE A SERIES			
Dia.	Rot.	Pitch	Part #	Dia.	Rot.	Pitch	Part #	Dia.	Rot.	Pitch	Part #
14-3/8	R	15	993042								
14-3/8	L	15	993052								
14-1/4	R	17	993043	15-1/2	R	17	993023	14-5/8	R	16	993203
14-1/4	L	17	993053	15-1/2	L	17	993033	14-5/8	L	16	993213
14-1/8	R	19	993044	15-1/4	R	19	993024	14-3/8	R	18	993204
14-1/8	L	19	993054	15-1/4	L	19	993034	14-3/8	L	18	993214
14	R	21	993045	14-3/4	R	21	993025	14-1/8	R	20	993205
14	L	21	993055	14-3/4	L	21	993035	14-1/8	L	20	993215
13-7/8	R	23	993046	14-5/8	R	23	993026	14	R	22	993206
13-7/8	L	23	993056	14-5/8	L	23	993036	14	L	22	993216

Drop-In Hub

Use XHS II[®] Hub Kit

207

Refer to Pages 55-57 for Details on Hub Kit Components.

MATCH
MICHIGAN

Boat Description/ Length	ALUMINUM PROPELLERS					
	Dia.	Rot.	Pitch	Bld #	OEM Part #	Part #
CR, HB	16	R	13	3	58130-ZY3-013A	031513
21'-24' - AL	15-1/4	R	15	3	58130-ZY3-015A	031023
20'-23' - AL, SK	16	R	16	3		031516
19'-23' - AL, SK	14-1/2	R	17	3		031024
19'-23' - AL, SK	15	R	17	3	58130-ZY3-017A	031064
19'-22' - AL, SK	15-1/2	R	18	3		031052
18'-22' - AL, SK	14	R	19	3		031025
18'-22' - AL, SK	14-1/2	R	19	3	58130-ZY3-019A	031065
18'-20' - AL, SK	13-3/4	R	21	3		031026
18'-20' - AL, SK	14-1/4	R	21	3	58130-ZY3-021A	031066
17'-20' - AL, SK						
17'-20' - AL, SK						
Up to 18'						
High Performance						
High Performance						
High Perf. (EFI)						
High Performance						
High Performance						
High Perf. (EFI)						

Rubber Hub Bushing

Part # 65-322

Refer to Pages 53-54 for Details on Attachment Hardware Components.

BALLISTIC
MICHIGAN

STAINLESS STEEL - A SERIES PROPELLERS									
3-BLADE BALLISTIC					3-BLADE BALLISTIC XL				
Dia.	Rot.	Pitch	Bld #	Part #	Dia.	Rot.	Pitch	Bld #	Part #
14-7/8	R	15	3	933515					
14-3/4	R	17	3	933517					
14-3/4	L	17	3	937517					
14-1/2	R	19	3	933519					
14-1/2	L	19	3	937519					
14-3/8	R	21	3	933521					
14-3/8	L	21	3	937521					
14-1/4	R	23	3	933523					
14-1/4	L	23	3	937523					
14-1/4	R	25	3	933525					
					14-3/4	R	22	3	953522
					14-3/4	R	24	3	953524
					14-3/4	R	26	3	953526
					4-BLADE BALLISTIC XL				
					14-1/8	R	23	4	963523
					14-1/8	R	25	4	963525
					14-1/8	R	27	4	963527

Drop-In Hub

Use XHS II[®] Hub Kit

207

Refer to Pages 55-57 for Details on Hub Kit Components.



4-6 HORSEPOWER

Thru Hub Exhaust & 12 Tooth Spline

4 HP 4-Stroke1999 & Newer 5 HP 2-Stroke1987 & Newer 6 HP 4-Stroke1999 & Newer
 4 HP 2-Stroke1987 & Newer

MATCH MICHIGAN						
ALUMINUM PROPELLERS						
Boat Description/ Length	Dia.	Rot.	Pitch	Bld #	OEM Part #	Part #
Std. Replacement	7-7/8	R	8	3	48-812950A02	032055

* Standard replacement for 4-Stroke models.



Rubber
Hub
Bushing
Part # 65-531

4-10 HORSEPOWER

Thru Hub Exhaust & 8 Tooth Spline

4 HP (Model 40)1973-1975 7.5 HP (Model 75 / Model 7.5)1968-1978 9.8 HP (Model 110 / Model 9.8)...1968-1985
 4.5 HP (Model 45 / Model 4.5).....1973-1981

MATCH MICHIGAN						
ALUMINUM PROPELLERS						
Boat Description/ Length	Dia.	Rot.	Pitch	Bld #	OEM Part #	Part #
Standard Replacement	9	R	9	2	48-47922A10	032021
14'-16' - AL	9	R	7	3	48-47670A10	032020

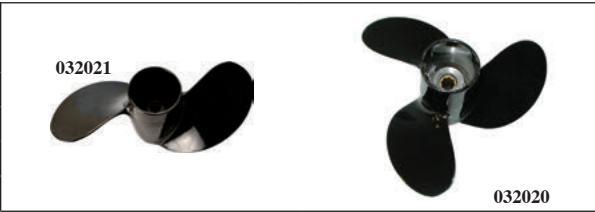

Rubber
Hub
Bushing
Part # 65-185

6-15 HORSEPOWER • 2-1/2" GEARCASE

Thru Hub Exhaust & 8 Tooth Spline

6 HP 2-Stroke (Includes Merc 6)1986-2002 9.9 HP 4-Stroke (Not Bigfoot)1995-2004 15 HP 2-Stroke1989-2005
 8 HP 2-Stroke (Includes Merc 8)1986-2005 10 HP1995 & Newer 15 HP 4-Stroke1999-2006
 8 HP 4-Stroke (Not Bigfoot)1995-2004 10 HP (Sea Pro/Marathon)1995-2001
 9.9 HP 2-Stroke (Includes Merc 9.9)1986-2005 15 HP (Sea Pro/Marathon)1995-2001

MATCH MICHIGAN						
ALUMINUM PROPELLERS						
Boat Description/ Length	Dia.	Rot.	Pitch	Bld #	OEM Part #	Part #
15'-20' - AL	9-1/4	R	7	3	48-828152A12	032056
14'-20' - AL	9	R	8	3	48-828154A12	032053
14'-19' - AL	9	R	9	3	48-828156A12	032052
14'-16' - AL	9	R	10-1/2	3	48-828158A12	032050



Rubber
Hub
Bushing
Part # 65-429

8-9.9 HORSEPOWER (4-STROKE) • 2-1/2" GEARCASE

Thru Hub Exhaust & 12 Tooth Spline

8 HP 4-Stroke (Non Bigfoot)2005 & Newer 9.9 HP 4-Stroke (Not Bigfoot)2005 & Newer

MATCH MICHIGAN						
ALUMINUM PROPELLERS						
Boat Description/ Length	Dia.	Rot.	Pitch	Bld #	OEM Part #	Part #
14'-17' - AL	8-1/2	R	7	3	48-897614A10	142102
13'-16' - AL	8-1/2	R	8	3	48-897618A10	142103



Rubber
Hub
Bushing
Part # 65-531

9.9-25 HORSEPOWER • 3" GEARCASE

Thru Hub Exhaust & 10 Tooth Spline • **⚠ MUST use Gearcase Adapter Ring supplied with propeller.**

9.9 HP 4-Stroke Bigfoot/Sail1999-2005	20 HP 2-Stroke (Mercury®) 1986-2002	25 HP 2-Stroke (Mariner®)1985 & Newer
15 HP 4-Stroke Bigfoot/Sail1999-2005	25 HP 2-Stroke (Mercury®) 1980-2005	25 HP (Sea Pro/Marathon).....All Years
18 HP (Mercury®)1980-1985		

Boat Description/ Length	VORTEX MICHIGAN					
	ALUMINUM - E SERIES PROPELLERS					
	Dia.	Rot.	Pitch	Bld #	OEM Part #	Part #
HB, SB	10-1/2	R	9	3		992501
19' & Up	10-1/2	R	10	3		992502
15'-19'	10-1/2	R	11	3	48-19638A40	992503
13'-17'	10-1/8	R	12	3	48-19639A40	992504
13'-17'	10-1/8	R	13	3	48-19640A40	992505
Up to 14'	10-1/8	R	14	3		992506

Drop-In Hub
Use XHS® or XHS II® Hub Kit
120 OR 220
⚠

991244 - Gearcase Adapter Rings

992504 Vortex® XHS® Aluminum Propeller

031048

031049

Boat Description/ Length	MATCH MICHIGAN					
	ALUMINUM PROPELLERS					
	Dia.	Rot.	Pitch	Bld #	OEM Part #	Part #
15'-19'	10-3/8	R	11	3	48-19638A40	031049
13'-17'	10-3/8	R	13	3	48-19640A40	031048
Up to 14'						

Rubber Hub Bushing
Part # 65-308

Boat Description/ Length	BALLISTIC MICHIGAN					
	STAINLESS STEEL - E SERIES PROPELLERS					
	Dia.	Rot.	Pitch	Bld #	OEM Part #	Part #
15'-19'	10-3/8	R	11	3	48-19638A40	031049
13'-17'	10-3/8	R	13	3	48-19640A40	031048
Up to 14'	10-1/8	R	13	3	48-19644A5	933013
	10-1/8	R	15	3		933015

Drop-In Hub
Use XHS® or XHS II® Hub Kit
120 OR 220
⚠

9.9-20 HORSEPOWER

Thru Hub Exhaust & 14 Tooth Spline

9.9 HP Bigfoot2005-2013	15 HP 4-Stroke2007 & Newer	20 HP 4-Stroke2007 & Newer
9.9 HP Command Thrust.....2016 & Newer		

Boat Description/ Length	MATCH MICHIGAN					
	ALUMINUM PROPELLERS					
	Dia.	Rot.	Pitch	Bld #	OEM Part #	Part #
15'-19' - AL	9-1/4	R	8	3	48-897748A11	142203
Standard Replacement	9-1/4	R	9	3	48-897750A11	*142204
Standard Replacement	9-1/4	R	10	3	48-897752A11	*142205
Up to 16' - LL	9-1/4	R	11	3	48-897754A11	142206
Up to 16' - LL	9-1/4	R	12	3		142207

142206

142204 Standard Replacement for:
• 15 HP 4-Stroke

142205 Standard Replacement for:
• 20 HP 4-Stroke

Rubber Hub Bushing
Part # 65-369

20 HORSEPOWER

Thru Hub Exhaust & 8 Tooth Spline

20 HP (Includes Merc 20 / Merc 200)1963-1981

Boat Description/ Length	MATCH MICHIGAN					
	ALUMINUM PROPELLERS					
	Dia.	Rot.	Pitch	Bld #	OEM Part #	Part #
Standard Replacement	9-7/8	R	11	2	48-33480A1	032135
14'-16' - AL	10	R	9	3	48-86962A4	032136

032136

Rubber Hub Bushing
Part # 65-101

MERCURY / MARINER / SEA RAY

15-25 HORSEPOWER • MARINER

Non-Thru Hub Exhaust & Pin Drive

15 HP.....1976-1981 W15 1977-1985 25 HP 1977-1979
15A.....1979-1982 20 HP 1976-1979



ALUMINUM PROPELLERS

Table with columns: Boat Description/Length, Dia., Rot., Pitch, Bld #, OEM Part #, Part #. Rows include HB, SB; 12'-14' - HL; 12'-14' - HL; 12'-14' - LL.



012102 012011 012013

Rubber Hub Bushing Part # 65-079

25-30 HORSEPOWER • MARINER • 3" GEARCASE

Thru Hub Exhaust & 10 Tooth Spline

25 HP.....1980-1984 28 HP 1976-1979 30 HP 1979-1990



ALUMINUM PROPELLERS

Table with columns: Boat Description/Length, Dia., Rot., Pitch, Bld #, OEM Part #, Part #. Rows include 16'-18' - AL, SK; 14'-17' - AL, SK; 13'-16' - LL; 13'-16' - LL; Up to 13' - LL; Up to 13' - LL.

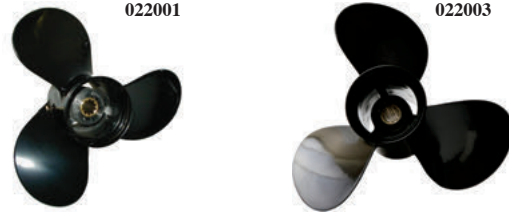

022001 022003

Rubber Hub Bushing Part # 65-265

25-30 HORSEPOWER 4-STROKE • MERCURY • 3" GEARCASE

Thru Hub Exhaust & 10 Tooth Spline • MUST use Gearcase Adapter Ring supplied with propeller.

25 HP 4-Stroke (Not Bigfoot)2006 & Newer 30 HP 4-Stroke (Not Bigfoot)2006 & Newer



ALUMINUM - E SERIES PROPELLERS

Table with columns: Boat Description/Length, Dia., Rot., Pitch, Bld #, OEM Part #, Part #. Rows include 16'-20' - AL; 14'-18' - AL; 14'-18' - AL; 14'-18' - AL; 12'-16' - AL; 12'-16' - AL.

Drop-In Hub Use XHS® or XHS II® Hub Kit 122 OR 222



992504 Vortex® XHS® Aluminum Propeller

141306



Rubber Hub Bushing Part # 65-370

MERCURY / MARINER / SEA RAY

40-65 HORSEPOWER • 3-1/4" GEARCASE

Thru Hub Exhaust & 13 Tooth Spline

40 HP (Model 402)1974-1976
50 HP (Model 500)1974-1976

60 HP (Mariner®).....1976

65 HP (Model 650)..... 1972-1976

VORTEX MICHIGAN										Drop-In Hub Use XHS® or XHS II® Hub Kit 114 OR 214 Refer to Pages 55-57 for Details on Hub Kit Components.	APOLLO MICHIGAN							Drop-In Hub Use XHS® or XHS II® Hub Kit 114 OR 214 Refer to Pages 55-57 for Details on Hub Kit Components.	
ALUMINUM - D SERIES PROPELLERS											STAINLESS STEEL - D SERIES PROPELLERS								
3-BLADE				LG. DIAMETER 3-BLADE			4-BLADE												
Dia.	Rot.	Pitch	Part #	Dia.	Rot.	Pitch	Part #	Dia.	Rot.		Pitch	Part #	Dia.	Rot.	Pitch	Bld #	OEM Part #		Part #
								11-1/2	R		8	992401							
				12-1/4	R	9	992601	11-1/2	R		9	992402							
				11-3/4	R	10	992602	11-1/2	R		10	992403							
10-3/8	R	11	992404	11-5/8	R	11	992603	4-BLADE											
10-3/8	R	12	992405	11-3/8	R	12	992604	10-5/8	R		12	941212	10-3/4	R	12	3	993405		
10-3/8	R	13	992406	11-1/8	R	13	992605	10-3/8	R		13	941213	10-1/2	R	13	3	993406		
10-3/8	R	14	992407	11-1/4	R	14	992606	10-1/8	R	14	941214	10-3/8	R	14	3	993407			
10	R	15	992408					10-1/8	R	15	941215	10-1/8	R	15	3	993408			
10	R	16	992409																

Boat Description/ Length	MATCH MICHIGAN						Rubber Hub Bushing Part # 65-205 Use OEM Fwd Washer 65758 Aft Washer 62124	BALLISTIC MICHIGAN							Drop-In Hub Use XHS® or XHS II® Hub Kit 114 OR 214 Refer to Pages 55-57 for Details on Hub Kit Components.
	ALUMINUM PROPELLERS							STAINLESS STEEL - D SERIES PROPELLERS							
	Dia.	Rot.	Pitch	Bld #	OEM Part #	Part #		Dia.	Rot.	Pitch	Bld #	OEM Part #	Part #		
19'-22' - AL	12-1/4	R	9	3		032046									
19'-22' - AL	11-3/4	R	10	3	48-61812A1	032045									
17'-19' - AL, SK	11-5/8	R	11	3	48-61814A1	032044									
16'-17' - CUPPED	10-5/8	R	12	3		031074									
16'-17' - AL, SK	11-3/8	R	12	3	48-61816A1	032043									
14'-16' - CUPPED	10-3/8	R	13	3		031075									
14'-16' - LL	11-1/8	R	13	3	48-61818A1	032042		10-1/8	R	13	3	933213			
12'-14' - CUPPED	10-1/4	R	14	3		031076									
12'-14' - LL	11-1/4	R	14	3	48-61820A1	032041									
12'-14' - LL	11	R	15	3	48-61822A1	032040	10-1/8	R	15	3	933215				



032046



031074



990407



Key to Abbreviations: LL = Light Loads; SB = Sailboat; AL = All Loads; SK = Skiboat; WB = Workboat; HB = Houseboat; CR = Cruisers; HL = Heavy Loads; WD = Weedless

MERCURY / MARINER / SEA RAY

25-70 HORSEPOWER • 3-1/4" GEARCASE

Thru Hub Exhaust & 13 Tooth Spline

25 HP 4-Stroke/Bigfoot1999-2005
 30 HP 2-Stroke1994-2002
 30 HP 4-Stroke1999-2005
 30 HP (Sea Pro/Marathon) 1994 & Newer
 35 HP1984-1989
 40 HP 2-Stroke (Includes Model 402) 1977 & Newer

40 HP 4-Stroke (Not Bigfoot)1997 & Newer
 40 HP (Sea Pro/Marathon)1977 & Newer
 45 HP 1986-1989
 48 HP (Mariner®).....All Years
 50 HP 2-Stroke (Includes Model 500) ..1977 & Newer

50 HP 4-Stroke (Not Bigfoot)1995 & Newer
 55 HP (Mercury/Sea Pro/Marathon)1995 & Newer
 60 HP 2-Stroke1978 & Newer
 60 HP 4-Stroke (Not Bigfoot)2001 & Newer
 70 HP (Includes Model 700).....Thru 1983



ALUMINUM - D SERIES PROPELLERS

3-BLADE				LG. DIAMETER 3-BLADE				4-BLADE			
Dia.	Rot.	Pitch	Part #	Dia.	Rot.	Pitch	Part #	Dia.	Rot.	Pitch	Part #
								11-1/2	R	8	992401
				12-1/4	R	9	992601	11-1/2	R	9	992402
				11-3/4	R	10	992602	11-1/2	R	10	992403
10-3/8	R	11	992404	11-5/8	R	11	992603	4-BLADE			
10-3/8	R	12	992405	11-3/8	R	12	992604	10-5/8	R	12	941212
10-3/8	R	13	992406	11-1/8	R	13	992605	10-3/8	R	13	941213
10-3/8	R	14	992407	11-1/4	R	14	992606	10-1/8	R	14	941214
10	R	15	992408					10-1/8	R	15	941215
10	R	16	992409								

Drop-In Hub
 Use XHS® or XHS II® Hub Kit
114 OR 214
 Refer to Pages 55-57 for Details on Hub Kit Components.



STAINLESS STEEL - D SERIES PROPELLERS

Dia.	Rot.	Pitch	Bld #	OEM Part #	Part #
10-3/4	R	12	3	48-855856A5	993405
10-1/2	R	13	3	48-855858A5	993406
10-3/8	R	14	3	48-855860A5	993407
10-1/8	R	15	3	48-855862A5	993408

Drop-In Hub
 Use XHS® or XHS II® Hub Kit
114 OR 214
 Refer to Pages 55-57 for Details on Hub Kit Components.



ALUMINUM PROPELLERS

Boat Description/ Length	Dia.	Rot.	Pitch	Bld #	OEM Part #	Part #
19' & Up	12-1/2	R	8	3	48-42738A10	• 032141
19' & Up	12-1/4	R	9	3		• 032143
17'-19' - AL, SK	11-1/4	R	10	3	48-73132A40	• 031015
16'-18' - AL, SK	12	R	10-1/2	3	48-42740A10	• 032142
16'-18' - AL, SK	10-7/8	R	11	3	48-85632A40	• 031053
15'-17' - AL, SK	10-3/4	R	12	3	48-816702A40	• 031056
15'-17' - AL, SK	10-5/8	R	12	3	48-73134A40	• 031016
14'-17' - AL, SK	10-1/2	R	13	3	48-816704A40	• 031057
14'-17' - AL, SK	10-3/8	R	13	3	48-73136A40	• 031017
14'-16' - LL	10-3/8	R	14	3	48-816706A40	• 031058
14'-16' - LL	10-1/4	R	14	3	48-73138A40	• 031018
13'-15' - LL	10-1/8	R	15	3	48-73140A40	• 031019
Up to 15'	10	R	17	3	48-73144A40	• 031020

Rubber Hub Bushing
 Part # 65-264
 When Replacing Mercury Reflex Hub with Michigan Match propeller, OEM Thrust Washer P/N 73345A1 Is Required



STAINLESS STEEL - D SERIES PROPELLERS

Dia.	Rot.	Pitch	Bld #	OEM Part #	Part #
10-1/8	R	13	3		933213
10-1/8	R	15	3		933215

Drop-In Hub
 Use XHS® or XHS II® Hub Kit
114 OR 214
 Refer to Pages 55-57 for Details on Hub Kit Components.

Note: Mercury® Reflex® Hub System is not compatible with Michigan Wheel XHS Hub Systems.
 ♦ When replacing Mercury® Reflex® Hub System with Michigan Match propeller, Michigan Forward Thrust Washer P/N 990407 is required.

MERCURY / MARINER / SEA RAY

40-140 HORSEPOWER • 4-1/4" GEARCASE

Thru Hub Exhaust & 15 Tooth Spline

40 & 50 HP 4-Stroke / BigfootAll Years
40 HP Command Thrust2014 & Newer
40 HP Sea Pro 4-Stroke2016 & Newer
50 HP Command Thrust2014 & Newer
60 HP 4-Stroke / Bigfoot1995 & Newer
60 HP (Sea Pro/Marathon)1995 & Newer
60 HP Command Thrust2014 & Newer
60 HP Sea Pro 4-Stroke2016 & Newer
65 HP (Model 650 - 2 Cyl.)Thru 1971
65 HP (Model 650 - 4 Cyl.)1961-1970
70 HP1987-1989

75 HP (Sea Pro/Marathon)All Years
75 HP 2-Stroke1984-2005
75 HP 4-Stroke2001 & Newer
80 HP1978-1989
80 HP (Mariner®)1978-1983
80 HP (Model 800; 2 & 4 Cyl.)Thru 1977
80 HP (Yamaha®)1977-1983
85 HP (Model 850; 2 & 4 Cyl.)Thru 1977
90 HP (Yamaha®)1978-1983
90 HP 2-Stroke1978 & Newer
90 HP 4-Stroke*2001 & Newer

100 HP1988 & Newer
115 HP (Yamaha®)1978-1983
115 HP1978 & Newer
115 HP 4-Stroke*2001 & Newer
125 HP1994 & Newer
140 HP (Includes Sea Pro/Offshore)1978-1981
140 HP (Yamaha®)1978-1979
Models 900-1150-1500Thru 1977

Includes EFI, OptiMax, Pro XS engines.
*Does not include Command Thrust model.

VORTEX
MICHIGAN

3-BL ALUMINUM - B SERIES					4-BL ALUMINUM - B SERIES				
Dia.	Rot.	Pitch	Bld #	Part #	Dia.	Rot.	Pitch	Bld #	Part #
14	R	10	3	992109					
14	R	11	3	992111	13-7/8	R	11	4	941411
14	R	13	3	992112	13-7/8	R	13	4	941413
13-3/4	R	15	3	992113	13-3/8	R	15	4	941415
13-1/4	R	17	3	992114	13	R	17	4	941417
13	R	19	3	992115	12-1/2	R	19	4	941419
12-3/4	R	21	3	992116					

Drop-In Hub

Use XHS II® Hub Kit

202

USE Gearcase Adapter Ring supplied with propeller.

Refer to Pages 55-57 for Details on Hub Kit Components.

APOLLO
MICHIGAN

STAINLESS STEEL - B SERIES PROPELLERS					
Dia.	Rot.	Pitch	Bld #	OEM Part #	Part #
13-3/8	R	15	3		993143
13-3/8	L	15	3		993153
13-1/4	R	17	3		993144
13-1/4	L	17	3		993154
13-1/8	R	19	3		993145
13-1/8	L	19	3		993155
13	R	21	3		993146
13	L	21	3		993156

Drop-In Hub

Use XHS II® Hub Kit

202

USE Gearcase Adapter Ring supplied with propeller.

Refer to Pages 55-57 for Details on Hub Kit Components.

MATCH
MICHIGAN

Boat Description/ Length	ALUMINUM PROPELLERS					
	Dia.	Rot.	Pitch	Bld #	OEM Part #	Part #
25' & Up - AL	14	R	10	3	48-854342A45	031061
25' & Up	14	R	11	3	48-77338A45	031254
22' & Up	14	R	13	3	48-77340A45	031055
19'-24' - AL	13-3/4	R	15	3	48-77342A45	031041
17'-20' - AL, SK	13-1/4	R	17	3	48-77344A45	031042
16'-19' - AL	13	R	19	3	48-77346A45	031043
15'-18' - AL	12-3/4	R	21	3	48-77348A45	031044
High Performance	12-1/2	R	23	3	48-77350A45	9931045
High Performance						

Rubber Hub Bushing Part # 65-444

Use MWM Fwd Washer 990332 or MWM Kit 9660-1 (Fwd Washer, Tab Washer, Propeller Nut)
See Page 27 for details.

BALLISTIC
MICHIGAN

STAINLESS STEEL - B SERIES PROPELLERS										
3-BLADE BALLISTIC						3-BLADE BALLISTIC XL				
Dia.	Rot.	Pitch	Bld #	Part #	Dia.	Rot.	Pitch	Bld #	Part #	
13-5/8	R	15	3	933415						
13-1/2	R	17	3	933417						
13-3/8	R	19	3	933419						
13-1/8	R	21	3	933421						
					13-1/2	R	22	3	953422	
					13-1/2	R	24	3	953424	

Drop-In Hub

Use XHS II® Hub Kit

202

USE Gearcase Adapter Ring supplied with propeller.

Refer to Pages 55-57 for Details on Hub Kit Components.

Note: * Replace standard trim tab with Michigan Wheel trim tab P/N 990404.



"...We have had great success with the Ballistic on 22' pontoons with 115 HP 4-Stroke motors. The pontoon boat is faster than a 22' TriToon with a 150 HP 4-Stroke and a stock propeller. Check it out!"
- Lake Keowee Marina
Seneca, SC



990404



Key to Abbreviations: LL = Light Loads; SB = Sailboat; AL = All Loads; SK = Skiboat; WB = Workboat; HB = Houseboat; CR = Cruisers; HL = Heavy Loads; WD = Weedless

Ⓢ Limited Inventory Item.

90-300 HORSEPOWER • V-6 (4-3/4") GEARCASE

Thru Hub Exhaust & 15 Tooth Spline

90 HP Command Thrust.....2014 & Newer
 115 HP Command Thrust.....2014 & Newer
 135 HP.....1987 & Newer
 150 HP.....1978 & Newer
 Add 4" Pitch for Twin Motors
 Includes DFI, EFI, Magnum, Offshore,
 Optimax, Sea Pro XRI, Marathon & Verado.

150 HP (Yamaha®).....1979-1983
 175 HP.....1978 & Newer
 175 HP (Yamaha®).....1978-1979
 200 HP.....1978 & Newer
 220 HP.....1987-1988
 225 HP.....1980 & Newer
 225 HP (Sea Pro/Marathon).....All Years

250 HP.....1994 & Newer
 275 HP.....1990-1994
 300 HP.....1983; 1999 & Newer
 3.4 Litre.....1984-1986

***For engines 300 HP or higher, use "High Horsepower Sleeve" (P/N 991372). See Page 48 for more details.**

VORTEX MICHIGAN						APOLLO MICHIGAN						MATCH MICHIGAN						BALLISTIC MICHIGAN																
3-BL ALUMINUM - A SERIES						4-BL ALUMINUM - A SERIES						STD. 3-BLADE A SERIES		LG DIA. 3-BLADE A SERIES		4-BLADE A SERIES		ALUMINUM PROPELLERS				STAINLESS STEEL - A SERIES PROPELLERS												
Dia.	Rot.	Pitch	Bld #	Part #		Dia.	Rot.	Pitch	Part #		Dia.	Rot.	Pitch	Part #	Dia.	Rot.	Pitch	Part #	Dia.	Rot.	Pitch	Bld #	Part #	Dia.	Rot.	Pitch	Bld #	Part #	Dia.	Rot.	Pitch	Bld #	Part #	
16	R	13	3	992001																														
15-1/4	R	15	3	992002							14-3/8	R	15	* 993042																				
16	R	16	3	931516							14-3/8	L	15	* 993052																				
15	R	17	3	992003	15 R 16 4 992202						14-1/4	R	17	* 993043	15-1/2 R 17 * 993023	14-5/8	R	16	* 993203															
											14-1/4	L	17	* 993053	15-1/2 L 17 * 993033	14-5/8	L	16	* 993213															
14-1/2	R	19	3	992004	14-1/2 R 18 4 992203						14-1/8	R	19	* 993044	15-1/4 R 19 * 993024	14-3/8	R	18	* 993204															
											14-1/8	L	19	* 993054	15-1/4 L 19 * 993034	14-3/8	L	18	* 993214															
14-1/4	R	21	3	992005	14 R 20 4 992204						14	R	21	* 993045	14-3/4 R 21 * 993025	14-1/8	R	20	* 993205															
											14	L	21	* 993055	14-3/4 L 21 * 993035	14-1/8	L	20	* 993215															
14	R	23	3	992006							13-7/8	R	23	* 993046	14-5/8 R 23 * 993026	14	R	22	* 993206															
											13-7/8	L	23	* 993056	14-5/8 L 23 * 993036	14	L	22	* 993216															
Boat Description/ Length	ALUMINUM PROPELLERS						RUBBER HUB BUSHING						4-BLADE BALLISTIC XL																					
	CR, HB	16	R	13	3	48-78114A45	031513	Use MWM Kit 990312 (Conductivity Washer, Aft Washer) or MWM Kit 9661-1 (Fwd Washer, Conductivity Washer, Aft Washer, Tab Washer, Propeller Nut) See Page 27 for details.	4-BLADE BALLISTIC XL																									
	21'-24' - AL	15-1/4	R	15	3	48-78116A45	031023		14-1/8	R	23	4	963523																					
	20'-23' - AL, SK	16	R	16	3	48-16440A45	031516		14-1/8	R	25	4	963525																					
	19'-23' - AL, SK	14-1/2	R	17	3	48-78118A40	031024		14-1/8	R	27	4	963527																					
	19'-23' - AL, SK	15	R	17	3	48-832828A45	031064																											
	19'-22' - AL, SK	15-1/2	R	18	3	48-11324A45	031052																											
	18'-22' - AL, SK	14	R	19	3	48-78120A40	031025																											
	18'-22' - AL, SK	14-1/2	R	19	3	48-832830A45	031065																											
	18'-20' - AL, SK	13-3/4	R	21	3	48-78122A40	031026																											
	18'-20' - AL, SK	14-1/4	R	21	3	48-832832A45	031066																											
	17'-20' - AL, SK																																	
	17'-20' - AL, SK																																	
	Up to 18'																																	
	High Performance																																	
High Performance																																		
High Performance																																		
50-62 MPH																																		
55-67 MPH																																		
60-72 MPH																																		

Note: * Replace standard trim tab with Michigan Wheel trim tab P/N 990404.

Replacing a Flo-Torq® Hub with Michigan Propellers

Replacing a Flo-Torq® Drop In Hub Design with Michigan Propellers

Propellers supplied from Mercury®, Mariner® and Force® since 1996 come with the Flo-Torq® II drop in hubs. When switching to Michigan Match® or Ballistic® propellers, change the attaching hardware set-up as follows.

When converting to a Michigan Propeller on a **V-4 gearcase**, eliminate B & C, replace A with H and use existing hardware F & G.

When converting to a Michigan Propeller on a **V-6 gearcase**, eliminate B & C and use A, D, E, F & G as attaching hardware (D & E replace C). Be sure to use high-performance trim tab 822777A1 for stainless steel installations.

Michigan Wheel offers the following attaching hardware kits for these installations:

- 990312 Includes D & E for the V-6 gearcase.
- 990332 Includes Forward Thrust Washer H for V-4 gearcase.
- 9661-1 Includes A, D, E, F & G for the V-6 gearcase.
- 9660-1 Includes H, F & G for the V-4 gearcase.

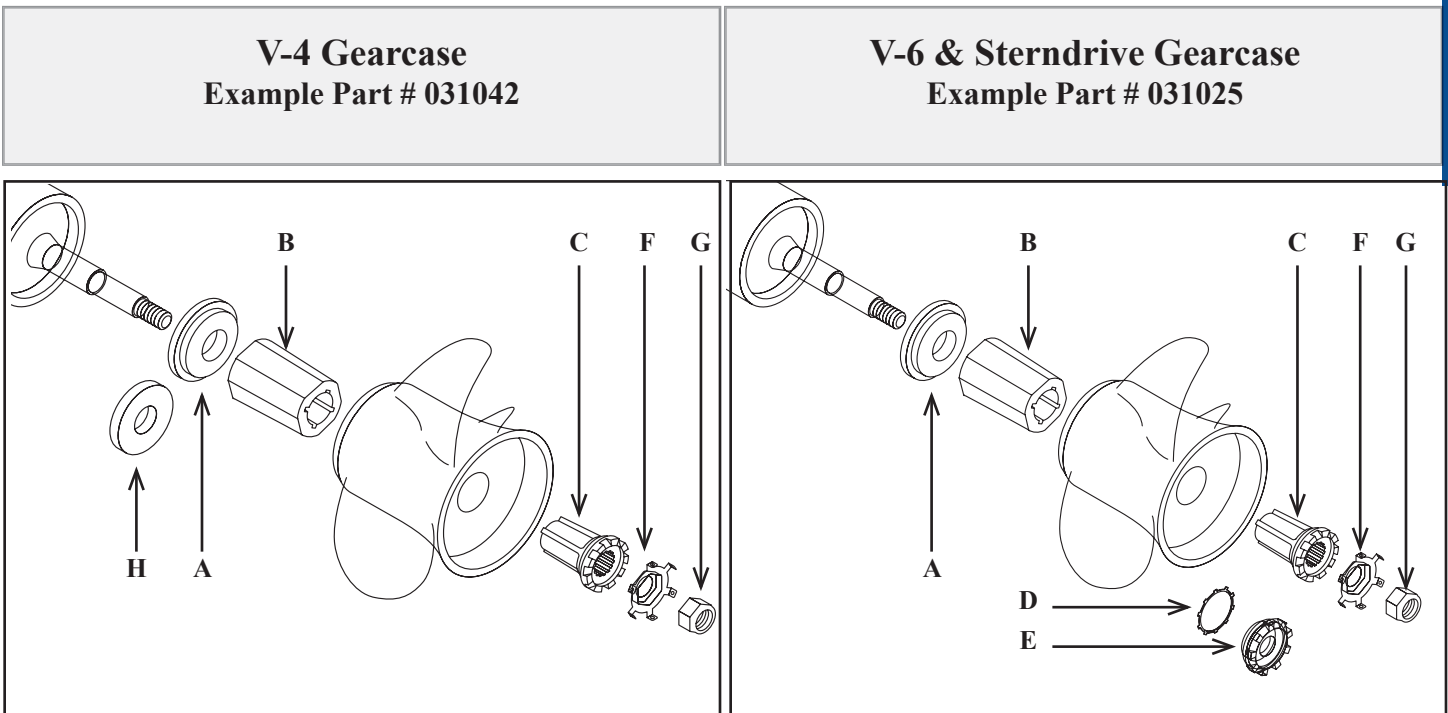

- A) **991204** Forward Thrust Washer
- B) **991301** Plastic Drive Sleeve
- C) **991205** Metal Sleeve Adapter
- D) **990340** Conductivity (Star) Washer

- E) **990348** Aft Castle Washer
- F) **990344** Locking Tab Washer
- G) **990346** Shaft Propeller Nut
- H) **990347** Forward Thrust Washer

8-9.8 HORSEPOWER (4-STROKE) • 2-1/2" GEARCASE

Thru Hub Exhaust & 12 Tooth Spline

8 HP 4-Stroke2005 & Newer 9.8 HP 4-Stroke2005 & Newer

Boat Description/ Length	MATCH MICHIGAN ALUMINUM PROPELLERS						142103 	142102 Standard Replacement for: • MFS8 / NSF8 • MFS9.8 / NSF9.8 (Long Shaft)	142103 Standard Replacement for: • M8B / NS8B (Long Shaft) • M9.8B (Long Shaft) • MSF9.8 / NSF9.8 (Short Shaft)	Rubber Hub Bushing Part # 65-531
	Dia.	Rot.	Pitch	Bld #	OEM Part #	Part #				
	Heavy Loads	8-1/2	R	7	3	3B2B645140				
Moderate Loads	8-1/2	R	8	3	3B2B645151	142103				

9.9-20 HORSEPOWER • 2-1/2" GEARCASE

Thru Hub Exhaust & 14 Tooth Spline



9.9 HP 2-Stroke1984 & Newer 15 HP 2-Stroke1985 & Newer 18 HP 4-Stroke2001-2008
 9.9 HP 4-Stroke2000-2003 15 HP 4-Stroke2000 & Newer 20 HP 4-Stroke2007 & Newer
 12 HP1985-1988 18 HP 2-Stroke1985 & Newer

Boat Description/ Length	MATCH MICHIGAN ALUMINUM PROPELLERS						142206 	142204 Standard Replacement for: • M9.9 / NS9.9 (Short Shaft) • MFS9.9 / NSF 9.9 (Short Shaft) • M15 / NS15 / (Short Shaft) • MFS15 / NSF15 (Long Shaft) • M18 / NS18 • MFS18 / NSF18 (Long Shaft) • MFS20 / NSF20 (Long Shaft)	142205 Standard Replacement for: • MFS15 / NSF15 (Short Shaft) • MSF18 / NSF18 (Short Shaft) • MSF20 / NSF20 (Short Shaft)	Rubber Hub Bushing Part # 65-369 See Pages 53-54 for Attachment Hardware
	Dia.	Rot.	Pitch	Bld #	OEM Part #	Part #				
	15'-19' - AL	9-1/4	R	8	3	3BAB645161				
14'-17' - AL	9-1/4	R	9	3	362B641010	142204				
Up to 16' - LL	9-1/4	R	10	3	362B641080	142205				
Up to 16' - LL	9-1/4	R	11	3		142206				
Up to 16' - LL	9-1/4	R	12	3		142207				

25-30 HORSEPOWER • 3" GEARCASE

Thru Hub Exhaust & 10 Tooth Spline • **MUST use Gearcase Adapter Ring supplied with propeller.**

25 HP1986-2001 30 HP1985-2001 30 HP 4-Stroke2002 & Newer
 25 HP 4-Stroke2002 & Newer 30 HP TLDI2016 & Newer

Boat Description/ Length	VORTEX MICHIGAN ALUMINUM - E SERIES PROPELLERS						Drop-In Hub Use XHS® or XHS II® Hub Kit 122 OR 222 	991244 - Gearcase Adapter Rings  992504 Vortex® XHS® Aluminum Propeller
	Dia.	Rot.	Pitch	Bld #	OEM Part #	Part #		
	16'-20' - AL	10-1/2	R	9	3	346-64101-5		
14'-18' - AL	10-1/2	R	10	3	346-64102-5	992502		
14'-18' - AL	10-1/2	R	11	3	346-64103-5	992503		
14'-18' - AL	10-1/8	R	12	3		992504		
12'-16' - AL	10-1/8	R	13	3	346-64104-5	992505		
12'-16' - AL	10-1/8	R	14	3		992506		

Boat Description/ Length	MATCH MICHIGAN ALUMINUM PROPELLERS						141306 	141305 Standard Replacement for: • M25 / NS25 (Long Shaft) • M30 / NS30 (Long Shaft)	141306 Standard Replacement for: • M25 / NS25 (Short Shaft) • M30 / NS30 (Short Shaft)
	Dia.	Rot.	Pitch	Bld #	OEM Part #	Part #			
	16'-20' - AL	9-7/8	R	9	3	3R0B645180			
16'-20' - AL	9-7/8	R	10	3	3R0B645210	141307			
12'-16' - AL	9-7/8	R	11	3	3R0B645230	141305			
12'-16' - AL	9-7/8	R	12	3	3R0B645250	141308			
Up to 16' - LL	9-7/8	R	13	3	3R0B645270	141306			
Up to 16' - LL	9-7/8	R	14-1/4	3	349B645291	142309			

NISSAN / TOHATSU

35-60 HORSEPOWER • 3-1/4" GEARCASE

Thru Hub Exhaust & 13 Tooth Spline

35 HP (35B Only) Thru 1984
40 HP (Includes TLDI; 40C; M40D; MD40)..... 1984 & Newer

MFS40 2015 & Newer
50 HP (Except 50C - Includes TLDI; M50D; MD50) .. 1992 & Newer

MSF50 2015 & Newer
BFT60 2014 & Newer



ALUMINUM - D SERIES PROPELLERS

3-BLADE				LG. DIAMETER 3-BLADE				4-BLADE			
Dia.	Rot.	Pitch	Part #	Dia.	Rot.	Pitch	Part #	Dia.	Rot.	Pitch	Part #
								11-1/2	R	8	992401
				12-1/4	R	9	992601	11-1/2	R	9	992402
				11-3/4	R	10	992602	11-1/2	R	10	992403
10-3/8	R	11	992404	11-5/8	R	11	992603	4-BLADE			
10-3/8	R	12	992405	11-3/8	R	12	992604	10-5/8	R	12	941212
10-3/8	R	13	992406	11-1/8	R	13	992605	10-3/8	R	13	941213
10-3/8	R	14	992407	11-1/4	R	14	992606	10-1/8	R	14	941214
10	R	15	992408					10-1/8	R	15	941215
10	R	16	992409								

Drop-In Hub
Use XHS® or XHS II® Hub Kit
113 OR 213
116 OR 216
Refer to Pages 55-57 for Details on Hub Kit Components.



STAINLESS STEEL - D SERIES PROPELLERS

Dia.	Rot.	Pitch	Bld #	OEM Part #	Part #
10-3/4	R	12	3	PT4050P12	993405
10-1/2	R	13	3	PT4050P13	993406
10-3/8	R	14	3	PT4050P14	993407
10-1/8	R	15	3	PT4050P15	993408

Drop-In Hub
Use XHS® or XHS II® Hub Kit
113 OR 213
116 OR 216
Refer to Pages 55-57 for Details on Hub Kit Components.



ALUMINUM PROPELLERS

Boat Description/ Length	Dia.	Rot.	Pitch	Bld #	OEM Part #	Part #
	19'-21' - AL	12-1/4	R	9	3	3T5B645180
17'-20' - AL	11-3/4	R	10	3		142408
16'-19' - AL	11-5/8	R	11	3	3T5B645230	*142405
15'-18' - AL	11-3/8	R	12	3	3T5B645250	*142409
14'-18' - AL	11-1/8	R	13	3	3T5B645270	*142406
14'-16' - AL	11-1/4	R	14	3	3T5B645290	142410
13'-15' - LL						

Rubber Hub Bushing
Part # 65-377
Refer to Pages 53-54 for Details on Attachment Hardware Components.



STAINLESS STEEL - D SERIES PROPELLERS

Dia.	Rot.	Pitch	Bld #	OEM Part #	Part #
10-1/8	R	13	3		933213
10-1/8	R	15	3		933215

Drop-In Hub
Use XHS® or XHS II® Hub Kit
113 OR 213
116 OR 216

* 142405 Standard Replacement for M40C / NS40C; 142409 Standard Replacement for M40D / NS40D; 142406 Standard Replacement for MD50 / NS50D

Note: For BFT60 use XHS (Drop-In Hub) Kit #113 / 213.
For all other engine applications XHS (Drop-In Hub) Kit #116 / 216.

50-70 HORSEPOWER • 3-1/4" GEARCASE

Thru Hub Exhaust & 13 Tooth Spline

50 HP (50C Only) 1987-1991
55 HP 1981-1988

60A & 60B (Excludes 60C) 1986-1999
For 60C & 70C, See 60-140 HP (Pg. 31).

70A & 70B (Excludes 70C) 1981-1995



ALUMINUM - C SERIES PROPELLERS

3-BLADE				LG. DIAMETER 3-BLADE				4-BLADE			
Dia.	Rot.	Pitch	Part #	Dia.	Rot.	Pitch	Part #	Dia.	Rot.	Pitch	Part #
								11-1/2	R	8	992401
								11-1/2	R	9	992402
								11-1/2	R	10	992403
11-3/4	R	13	992301	12-1/2	R	13	992311				
11-3/4	R	15	992302	12-1/4	R	15	992312				
11-3/4	R	17	992303								

Drop-In Hub
Use XHS® or XHS II® Hub Kit
112 OR 212
Refer to Pages 55-57 for Details on Hub Kit Components.



Drop-In Hub
Use XHS® or XHS II® Hub Kit
112 OR 212
Refer to Pages 55-57 for Details on Hub Kit Components.



STAINLESS STEEL - C SERIES PROPELLERS

Dia.	Rot.	Pitch	Bld #	OEM Part #	Part #
12-3/8	R	15	3		* 933315
12	R	17	3		* 933317

Drop-In Hub
Use XHS® or XHS II® Hub Kit
112 OR 212

* May interfere with trim tab.

60-90 HORSEPOWER • 4-1/4" GEARCASE

Thru Hub Exhaust & 15 Tooth Spline

BFW60.....2014 & Newer

BFT75.....2014 & Newer

BFT90.....2014 & Newer

VORTEX MICHIGAN										Drop-In Hub Use XHS II® Hub Kit 207 USE Gearcase Adapter Ring supplied with propeller. Refer to Pages 55-57 for Details on Hub Kit Components.	APOLLO MICHIGAN							Drop-In Hub Use XHS II® Hub Kit 207 USE Gearcase Adapter Ring supplied with propeller. Refer to Pages 55-57 for Details on Hub Kit Components.
3-BL ALUMINUM - B SERIES					4-BL ALUMINUM - B SERIES						STAINLESS STEEL - B SERIES PROPELLERS							
Dia.	Rot.	Pitch	Bld #	Part #	Dia.	Rot.	Pitch	Bld #	Part #		Dia.	Rot.	Pitch	Bld #	OEM Part #	Part #		
14	R	10	3	992109														
14	R	11	3	992111	13-7/8	R	11	4	941411									
14	R	13	3	992112	13-7/8	R	13	4	941413									
13-3/4	R	15	3	992113	13-3/8	R	15	4	941415		13-3/8	R	15	3		993143		
											13-3/8	L	15	3		993153		
13-1/4	R	17	3	992114	13	R	17	4	941417		13-1/4	R	17	3		993144		
											13-1/4	L	17	3		993154		
13	R	19	3	992115	12-1/2	R	19	4	941419	13-1/8	R	19	3		993145			
										13-1/8	L	19	3		993155			
12-3/4	R	21	3	992116						13	R	21	3		993146			
										13	L	21	3		993156			

Boat Description/Length	MATCH MICHIGAN						Rubber Hub Bushing Part # 65-444	BALLISTIC MICHIGAN										Drop-In Hub Use XHS II® Hub Kit 207 USE Gearcase Adapter Ring supplied with propeller. Refer to Pages 55-57 for Details on Hub Kit Components.			
	ALUMINUM PROPELLERS							STAINLESS STEEL - B SERIES PROPELLERS													
	Dia.	Rot.	Pitch	Bld #	OEM Part #	Part #		3-BLADE BALLISTIC					3-BLADE BALLISTIC XL								
25' & Up - AL	14	R	10	3		031061															
25' & Up	14	R	11	3		031254															
22' & Up	14	R	13	3		031055															
19'-24' - AL	13-3/4	R	15	3		031041						13-5/8	R	15	3	* 933415					
17'-20' - AL, SK	13-1/4	R	17	3		031042						13-1/2	R	17	3	* 933417					
16'-19' - AL	13	R	19	3		031043						13-3/8	R	19	3	* 933419					
15'-18' - AL	12-3/4	R	21	3		031044						13-1/8	R	21	3	* 933421	13-1/2	R	22	3	* 953422
Up to 17' - LL	12-1/2	R	23	3		* 031045											13-1/2	R	24	3	* 953424

Note: * May interfere with trim tab.



60-140 HORSEPOWER • 4-1/4" GEARCASE

Thru Hub Exhaust & 15 Tooth Spline

60C (Large Gearcase) Thru 1999	90 HP..... 1987-2001	120 HP 1988-2003
70C (Large Gearcase) Thru 2002	90 HP TLDI..... 2001 & Newer	140 HP 1988-2003
70 HP TLDI..... 2002-2009	115 HP..... 1992-2001	
75 HP TLDI..... 2010 & Newer	115 HP TLDI..... 2004 & Newer	

VORTEX MICHIGAN						APOLLO MICHIGAN									
3-BL ALUMINUM - B SERIES			4-BL ALUMINUM - B SERIES			STAINLESS STEEL - B SERIES PROPELLERS									
Dia.	Rot.	Pitch	Bld #	Part #	Dia.	Rot.	Pitch	Bld #	Part #	Dia.	Rot.	Pitch	Bld #	OEM Part #	Part #
14	R	10	3	992109											
14	R	11	3	992111	13-7/8	R	11	4	941411						
14	R	13	3	992112	13-7/8	R	13	4	941413						
13-3/4	R	15	3	992113	13-3/8	R	15	4	941415	13-3/8	R	15	3	PT70115P15	993143
										13-3/8	L	15	3		993153
13-1/4	R	17	3	992114	13	R	17	4	941417	13-1/4	R	17	3	NM889610170	993144
										13-1/4	L	17	3		993154
13	R	19	3	992115	12-1/2	R	19	4	941419	13-1/8	R	19	3		993145
										13-1/8	L	19	3		993155
12-3/4	R	21	3	992116						13	R	21	3		993146
										13	L	21	3		993156

MATCH MICHIGAN							BALLISTIC MICHIGAN						
Boat Description/ Length	ALUMINUM PROPELLERS						Rubber Hub Bushing Part # 65-376	STAINLESS STEEL - B SERIES PROPELLERS					
	Dia.	Rot.	Pitch	Bld #	OEM Part #	Part #		Dia.	Rot.	Pitch	Bld #	OEM Part #	Part #
22'-29' - AL	13-5/8	R	13	3	3N4B645271	142213		13-5/8	R	15	3		933415
21'-26' - AL	13-1/2	R	15	3	3N4B645321	142215		13-1/2	R	17	3		933417
18'-21' - AL	13-1/4	R	17	3	3N4B645361	141217		13-3/8	R	19	3		933419
17'-20' - AL	13	R	19	3	3N4B645411	141219		13-1/8	R	21	3		933421
15'-18' - AL	12-5/8	R	21	3	3N4B645451	141221							

Drop-In Hub
Use XHS II® Hub Kit
209
Use Gearcase Adapter Ring supplied with propeller.
Refer to Pages 55-57 for Details on Hub Kit Components.

Drop-In Hub
Use XHS II® Hub Kit
209
Use Gearcase Adapter Ring supplied with propeller.
Refer to Pages 55-57 for Details on Hub Kit Components.

Rubber Hub Bushing
Part # 65-376

Drop-In Hub
Use XHS II® Hub Kit
209

NISSAN / TOHATSU

NISSAN / TOHATSU



MATCH
MICHIGAN



VORTEX
MICHIGAN



APOLLO
MICHIGAN



BALLISTIC
MICHIGAN

Key to Abbreviations: LL = Light Loads; SB = Sailboat; AL = All Loads; SK = Skiboat; WB = Workboat; HB = Houseboat; CR = Cruisers; HL = Heavy Loads; WD = Weedless

115-250 HORSEPOWER • 4-3/4" GEARCASE

Thru Hub Exhaust & 15 Tooth Spline

BFT1152014 & Newer
BFT1502014 & Newer

BFT200.....2014 & Newer
BFT225.....2014 & Newer

BFT250.....2014 & Newer

VORTEX
MICHIGAN

APOLLO
MICHIGAN

3-BL ALUMINUM - A SERIES					4-BL ALUMINUM - A SERIES				
Dia.	Rot.	Pitch	Bld #	Part #	Dia.	Rot.	Pitch	Bld #	Part #
16	R	13	3	992001					
15-1/4	R	15	3	992002					
16	R	16	3	931516					
15	R	17	3	992003	15	R	16	4	992202
14-1/2	R	19	3	992004	14-1/2	R	18	4	992203
14-1/4	R	21	3	992005	14	R	20	4	992204
14	R	23	3	992006					

Drop-In Hub

Use XHS II® Hub Kit

207

Refer to Pages 55-57 for Details on Hub Kit Components.

STD. 3-BLADE A SERIES				LG DIA. 3-BLADE A SERIES				4-BLADE A SERIES			
Dia.	Rot.	Pitch	Part #	Dia.	Rot.	Pitch	Part #	Dia.	Rot.	Pitch	Part #
14-3/8	R	15	993042								
14-3/8	L	15	993052								
14-1/4	R	17	993043	15-1/2	R	17	993023	14-5/8	R	16	993203
14-1/4	L	17	993053	15-1/2	L	17	993033	14-5/8	L	16	993213
14-1/8	R	19	993044	15-1/4	R	19	993024	14-3/8	R	18	993204
14-1/8	L	19	993054	15-1/4	L	19	993034	14-3/8	L	18	993214
14	R	21	993045	14-3/4	R	21	993025	14-1/8	R	20	993205
14	L	21	993055	14-3/4	L	21	993035	14-1/8	L	20	993215
13-7/8	R	23	993046	14-5/8	R	23	993026	14	R	22	993206
13-7/8	L	23	993056	14-5/8	L	23	993036	14	L	22	993216

Drop-In Hub

Use XHS II® Hub Kit

207

Refer to Pages 55-57 for Details on Hub Kit Components.

MATCH
MICHIGAN

BALLISTIC
MICHIGAN

Boat Description/ Length	ALUMINUM PROPELLERS					
	Dia.	Rot.	Pitch	Bld #	OEM Part #	Part #
CR, HB	16	R	13	3	58130-ZY3-013A	031513
21'-24' - AL	15-1/4	R	15	3	58130-ZY3-015A	031023
20'-23' - AL, SK	16	R	16	3		031516
19'-23' - AL, SK	14-1/2	R	17	3	58130-ZY3-017A	031024
19'-23' - AL, SK	15	R	17	3		031064
19'-22' - AL, SK	15-1/2	R	18	3		031052
18'-22' - AL, SK	14	R	19	3	58130-ZY3-019A	031025
18'-22' - AL, SK	14-1/2	R	19	3		031065
18'-20' - AL, SK	13-3/4	R	21	3	58130-ZY3-021A	031026
18'-20' - AL, SK	14-1/4	R	21	3		031066
17'-20' - AL, SK						
17'-20' - AL, SK						
Up to 18'						
High Performance						
High Performance						
High Perf. (EFI)						
High Performance						
High Performance						
High Perf. (EFI)						

Rubber Hub Bushing

Part # 65-322

STAINLESS STEEL - A SERIES PROPELLERS									
3-BLADE BALLISTIC					3-BLADE BALLISTIC XL				
Dia.	Rot.	Pitch	Bld #	Part #	Dia.	Rot.	Pitch	Bld #	Part #
14-7/8	R	15	3	933515					
14-3/4	R	17	3	933517					
14-3/4	L	17	3	937517					
14-1/2	R	19	3	933519					
14-1/2	L	19	3	937519					
14-3/8	R	21	3	933521					
14-3/8	L	21	3	937521					
14-1/4	R	23	3	933523					
14-1/4	L	23	3	937523					
14-1/4	R	25	3	933525					
					14-3/4	R	22	3	953522
					14-3/4	R	24	3	953524
					14-3/4	R	26	3	953526
					4-BLADE BALLISTIC XL				
					14-1/8	R	23	4	963523
					14-1/8	R	25	4	963525
					14-1/8	R	27	4	963527

Drop-In Hub

Use XHS II® Hub Kit

207

Refer to Pages 55-57 for Details on Hub Kit Components.



NISSAN / TOHATSU

8-20 HORSEPOWER • 2-1/2" GEARCASE

Thru Hub Exhaust & 10 Tooth Spline

DF 8A 4-Stroke2011 & Newer	DF 9.9A / 9.9B 4-Stroke.....2010 & Newer	DF 15 4-Stroke1996 & Newer
DT 9.91983-1987	DT 15 1983-1988	DF 15A 4-Stroke.....2013 & Newer
DF 9.9 4-Stroke.....1996 & Newer	DT 15C 1989-1997	DF 20A 4-Stroke.....2013 & Newer



Boat Description/ Length	MATCH MICHIGAN						ALUMINUM PROPELLERS	062103		062103 Standard Replacement for: • DF 15A 4-Stroke	Rubber Hub Bushing Part # 65-540
	ALUMINUM PROPELLERS										
	Dia.	Rot.	Pitch	Bld #	OEM Part #	Part #					
14'-19' - AL	9-1/4	R	9	3	58100-90L50-019	*062103					
14'-19' - AL	9-1/4	R	10	3	58100-90L60-019	*062104					
14'-16' - LL	9-1/4	R	11	3	58100-89L40-019	*062105					

Note: * All engines require OEM Aft Spacer Washer Part # 57633-93901.

20-30 HORSEPOWER • 3" GEARCASE

Thru Hub Exhaust & 10 Tooth Spline • **!** MUST use Gearcase Adapter Ring supplied with propeller.

DT 20 ☆1985-1986	DF 25 4-Stroke (Includes V-Twin).....2000 & Newer	DT 30 1987-1997
DT 201987-1988	DF 25R2010 & Newer	DT 30C 1987-1997
DT 25 ☆1985-1986	DF 25A2014 & Newer	DF 30 4-Stroke 2000-2007
DT 251987-1988	DT 30 ☆ 1983-1986	DF 30A2014 & Newer
DT 25C.....1989-2000		<i>Includes 'AQH', 'AR', 'AT', 'ATH', and 'R' models.</i>

Boat Description/ Length	VORTEX MICHIGAN						Drop-In Hub Use XHS® or XHS II® Hub Kit 121 OR 221 !			062205 Standard Replacement for: • DF 25 4-Stroke • DF 25R 4-Stroke
	ALUMINUM - E SERIES PROPELLERS									
	Dia.	Rot.	Pitch	Bld #	OEM Part #	Part #				
20' & Up - AL	10-1/2	R	9	3	58100-96370-019	992501				
18'-20' - AL	10-1/2	R	10	3	58100-96470-019	992502				
16'-18' - AL	10-1/2	R	11	3	58100-96420-019	992503				
14'-16' - AL	10-1/8	R	12	3	58100-96480-019	992504				
14'-16' - AL	10-1/8	R	13	3	58100-96490-019	992505				
14'-16' - LL	10-1/8	R	14	3		992506				

Boat Description/ Length	MATCH MICHIGAN						Rubber Hub Bushing Part # 65-339 Refer to Pages 53-54 for Details on Attachment Hardware Components.	BALLISTIC MICHIGAN						Drop-In Hub Use XHS® or XHS II® Hub Kit 121 OR 221 !
	ALUMINUM PROPELLERS							STAINLESS STEEL - E SERIES PROPELLERS						
	Dia.	Rot.	Pitch	Bld #	OEM Part #	Part #		Dia.	Rot.	Pitch	Bld #	OEM Part #	Part #	
20' & Up - AL	10-1/4	R	9	3	58100-96371-019	062208								
20' & Up - AL	10-1/4	R	10	3	58100-96471-019	062204								
17'-20' - AL	10-1/4	R	11	3	58100-96421-019	062205								
15'-18' - AL	10-1/4	R	12	3	58100-96481-019	062206								
13'-15' - AL	10-1/4	R	13	3	58100-96491-019	062207								
13'-15' - AL	10-1/4	R	14	3	58100-95D01-019	062209								
Up to 15' - LL	10-1/4	R	15	3	58100-96462-019	062210								

Note: * May interfere with trim tab.

35-65 HORSEPOWER • 3-1/4" GEARCASE

Thru Hub Exhaust & 13 Tooth Spline

DT 35C.....1987-1989	DT 50 & 50M..... 1983-1984	DT 60..... 1983-1984
DT 40.....1983-1998	DF 50 4-Stroke..... 1999-2010	DF 60A 4-Stroke (Not 60AV) ...2010 & Newer
DF 40 4-Stroke.....1999-2010	DF 50A 4-Stroke (Not 50AV).....2010 & Newer	DT 65..... 1985-1997
DF 40A 4-Stroke.....2010 & Newer	DT 55..... 1985-1997	

VORTEX —MICHIGAN—				APOLLO —MICHIGAN—							
ALUMINUM - D SERIES PROPELLERS				STAINLESS STEEL - D SERIES PROPELLERS							
3-BLADE		LG. DIAMETER 3-BLADE		4-BLADE							
Dia.	Rot. Pitch Part #	Dia.	Rot. Pitch Part #	Dia.	Rot. Pitch Part #	Dia.	Rot.	Pitch	Bld #	OEM Part #	Part #
				11-1/2	R 8	992401					
		12-1/4	R 9	992601	11-1/2	R 9	992402				
		11-3/4	R 10	992602	11-1/2	R 10	992403				
10-3/8	R 11	992404	11-5/8	R 11	992603	4-BLADE					
10-3/8	R 12	992405	11-3/8	R 12	992604	10-5/8	R 12	992406		993405	
10-3/8	R 13	992406	11-1/8	R 13	992605	10-3/8	R 13	992407		993406	
10-3/8	R 14	992407	11-1/4	R 14	992606	10-1/8	R 14	992408		993407	
10	R 15	992408				10-1/8	R 15	992409		993408	
10	R 16	992409									

		MATCH —MICHIGAN—				BALLISTIC —MICHIGAN—							
		ALUMINUM PROPELLERS						STAINLESS STEEL - D SERIES PROPELLERS					
Boat Description/ Length		Dia.	Rot.	Pitch	Bld #	OEM Part #	Part #	Dia.	Rot.	Pitch	Bld #	OEM Part #	Part #
18'-21' - AL		12-1/4	R	9	3		032046						
18'-21' - AL		11-3/4	R	10	3	58100-88L13-019	032045						
16'-19' - AL		11-1/2	R	11	3	58100-88L23-019	062211						
16'-19' - AL		11-1/2	R	12	3	58100-88LAO-019	062212						
14'-18' - AL		11-1/2	R	13	3	58100-92L30-019	062213	10-1/8	R	13	3	933213	
14'-18' - AL		11-1/2	R	14	3	58100-88L52-019	062214						
13'-15' - AL		11-1/4	R	15	3	58100-88L62-019	062215	10-1/8	R	15	3	933215	
13'-15' - LL		11-1/8	R	16	3	58100-88L72-019	062216						
Up to 15' - LL		11	R	17	3	58100-88L83-019	062217						

Drop-In Hub
Use XHS® or XHS II® Hub Kit
115 OR 215
Refer to Pages 55-57 for Details on Hub Kit Components.

Rubber Hub Bushing
Part # 65-205
Refer to Pages 53-54 for Details on Attachment Hardware Components.

Drop-In Hub
Use XHS® or XHS II® Hub Kit
115 OR 215
Refer to Pages 55-57 for Details on Hub Kit Components.

Drop-In Hub
Use XHS® or XHS II® Hub Kit
115 OR 215
Refer to Pages 55-57 for Details on Hub Kit Components.



APOLLO
—MICHIGAN—



BALLISTIC
—MICHIGAN—

60-140 HORSEPOWER • 4-1/4" GEARCASE

Thru Hub Exhaust & 13 Tooth Spline

DF 60 4-Stroke.....1998-2009	DT 85.....1979-2000	DT 115.....1981-2001
DF 70 4-Stroke.....1998-2008	DT 90.....1989-1997	DT 140.....1981-2001
DT 75.....1983-1997	DT 100.....1989-2000	

VORTEX MICHIGAN						APOLLO MICHIGAN									
3-BL ALUMINUM - B SERIES					4-BL ALUMINUM - B SERIES					STAINLESS STEEL - B SERIES PROPELLERS					
Dia.	Rot.	Pitch	Bld #	Part #	Dia.	Rot.	Pitch	Bld #	Part #	Dia.	Rot.	Pitch	Bld #	OEM Part #	Part #
14	R	10	3	992109											
14	R	11	3	992111	13-7/8	R	11	4	941411						
14	R	13	3	992112	13-7/8	R	13	4	941413						
13-3/4	R	15	3	992113	13-3/8	R	15	4	941415	13-3/8	R	15	3		993143
										13-3/8	L	15	3		993153
13-1/4	R	17	3	992114	13	R	17	4	941417	13-1/4	R	17	3		993144
										13-1/4	L	17	3		993154
13	R	19	3	992115	12-1/2	R	19	4	941419	13-1/8	R	19	3		993145
										13-1/8	L	19	3		993155
12-3/4	R	21	3	992116						13	R	21	3		993146
										13	L	21	3		993156

Drop-In Hub

Use XHS II® Hub Kit

210

Do NOT use Gearcase Adapter Ring supplied with propeller.

Refer to Pages 55-57 for Details on Hub Kit Components.

Drop-In Hub

Use XHS II® Hub Kit

210

Do NOT use Gearcase Adapter Ring supplied with propeller.

Refer to Pages 55-57 for Details on Hub Kit Components.

Boat Description/ Length	MATCH MICHIGAN						Rubber Hub Bushing Part # 65-172	BALLISTIC MICHIGAN					
	ALUMINUM PROPELLERS							STAINLESS STEEL - B SERIES PROPELLERS					
	Dia.	Rot.	Pitch	Bld #	OEM Part #	Part #		Dia.	Rot.	Pitch	Bld #	OEM Part #	Part #
19'-22' - AL, SK								13-5/8	R	15	3		933415
18'-21' - AL, SK								13-1/2	R	17	3		933417
17'-20' - AL, SK	13	R	19	3	58100-94522-019	Ⓢ 061103		13-3/8	R	19	3		933419
15'-18' - AL, SK	13	R	21	3	58100-94532-019	Ⓢ 061104		13-1/8	R	21	3		933421

Drop-In Hub

Use XHS II® Hub Kit

210

Do NOT use Gearcase Adapter Ring supplied with propeller.



MATCH
MICHIGAN



VORTEX
MICHIGAN



APOLLO
MICHIGAN



BALLISTIC
MICHIGAN

Key to Abbreviations: LL = Light Loads; SB = Sailboat; AL = All Loads; SK = Skiboat; WB = Workboat; HB = Houseboat; CR = Cruisers; HL = Heavy Loads; WD = Weedless

Ⓢ Limited Inventory Item.

50-140 HORSEPOWER (4-STROKE) • 4-1/4" GEARCASE

Thru Hub Exhaust & 15 Tooth Spline

DF 50AV 4-Stroke2015 & Newer	DF 90 4-Stroke 2001-2008	DF 115A 4-Stroke.....2013 & Newer
DF 60AV 4-Stroke2015 & Newer	DF 90A 4-Stroke2009 & Newer	DF 140 4-Stroke 2002-2012
DF 70A 4-Stroke2009 & Newer	DF 100 4-Stroke2009 & Newer	DF 140A 4-Stroke.....2013 & Newer
DF 80A 4-Stroke2009 & Newer	DF 115 4-Stroke 2001-2012	

VORTEX <small>MICHIGAN</small>							APOLLO <small>MICHIGAN</small>									
3-BL ALUMINUM - B SERIES					4-BL ALUMINUM - B SERIES					Drop-In Hub	STAINLESS STEEL - B SERIES PROPELLERS					Drop-In Hub
Dia.	Rot.	Pitch	Bld #	Part #	Dia.	Rot.	Pitch	Bld #	Part #		Dia.	Rot.	Pitch	Bld #	OEM Part #	
14	R	10	3	992109												
14	R	11	3	992111	13-7/8	R	11	4	941411							
14	R	13	3	992112	13-7/8	R	13	4	941413							
13-3/4	R	15	3	992113	13-3/8	R	15	4	941415							
										13-3/8	R	15	3		993143	
										13-3/8	L	15	3		993153	
13-1/4	R	17	3	992114	13	R	17	4	941417							
										13-1/4	R	17	3		993144	
										13-1/4	L	17	3		993154	
13	R	19	3	992115	12-1/2	R	19	4	941419							
										13-1/8	R	19	3		993145	
										13-1/8	L	19	3		993155	
12-3/4	R	21	3	992116						13	R	21	3		993146	
										13	L	21	3		993156	

Drop-In Hub
Use XHS II® Hub Kit #225 / #226 / #227*
USE Gearcase Adapter Ring supplied with propeller.
Refer to Pages 55-57 for Details on Hub Kit Components.

Drop-In Hub
Use XHS II® Hub Kit #225 / #226 / #227*
USE Gearcase Adapter Ring supplied with propeller.
Refer to Pages 55-57 for Details on Hub Kit Components.

Boat Description/ Length	MATCH <small>MICHIGAN</small>						Rubber Hub Bushing Part # 65-441 Refer to Pages 53-54 for Details on Attachment Hardware Components.	BALLISTIC <small>MICHIGAN</small>						Drop-In Hub Use XHS II® Hub Kit #225 / #226 / #227* USE Gearcase Adapter Ring supplied with propeller.		
	ALUMINUM PROPELLERS							STAINLESS STEEL - B SERIES PROPELLERS								
	Dia.	Rot.	Pitch	Bld #	OEM Part #	Part #		3-BLADE BALLISTIC			3-BLADE BALLISTIC XL					
20'-24' - AL, SK	14	R	15	3	990C0-00760-15P	061020										
17'-19' - AL, SK	14	R	17	3	990C0-00760-17P	061024										
17'-19' - AL	14	R	18	3		061026										
16'-18' - AL, SK	14	R	19	3	990C0-00760-19P	061028										
15'-18' - AL, SK	14	R	21	3	990C0-00760-21P	061032										
High Performance																

Note: For DF 50AV / DF 60AV / DF 90 / DF 100 / DF 115 HP 4-Stroke engine applications use XHS II® (Drop-In Hub) Kit #225.
For DF 115A / DF 140 HP / DF 140A 4-Stroke engine applications use XHS II® (Drop-In Hub) Kit #226.
For DF 70A / 80A / 90A applications use XHS II® (Drop-In Hub) Kit #227.

Did You Know?
Michigan Wheel truly has a global presence, with offices in both England and Dubai, United Arab Emirates.



MATCH
MICHIGAN



VORTEX
MICHIGAN



APOLLO
MICHIGAN



BALLISTIC
MICHIGAN

150-300 HORSEPOWER • 4-3/4" GEARCASE

Thru Hub Exhaust & 15 Tooth Spline

DT 150	1986-2003
DF 150 4-Stroke	2006 & Newer
DF 150TG	2014 & Newer
DT 175	1987-1992
DF 175 4-Stroke	2006 & Newer
DT 175TG	2014 & Newer
DT 200	1986-2000

DF 200 4-Stroke ①	2004 & Newer
DF 200A 4-Stroke	2015 & Newer
DF 200AP 4-Stroke ①	2015 & Newer
DT 225	1986-2003
DF 225 4-Stroke ①	2004 & Newer

DF 250 4-Stroke ①	2004 & Newer
DF 250AP 4-Stroke ①	2014 & Newer
DF 300 4-Stroke ①	2007 & Newer
DF 300AP 4-Stroke ①	2014 & Newer

① Listed propeller diameters are slightly less than original equipment propeller.

*For engines 300 HP or higher, use "High Horsepower Sleeve" (P/N 991372). See Page 48 for more details.

VORTEX MICHIGAN										APOLLO MICHIGAN														
3-BL ALUMINUM - A SERIES					4-BL ALUMINUM - A SERIES					STD. 3-BLADE A SERIES					LG DIA. 3-BLADE A SERIES					4-BLADE A SERIES				
Dia.	Rot.	Pitch	Bld #	Part #	Dia.	Rot.	Pitch	Bld #	Part #	Dia.	Rot.	Pitch	Part #	Dia.	Rot.	Pitch	Part #	Dia.	Rot.	Pitch	Part #			
16	R	13	3	992001																				
15-1/4	R	15	3	992002						14-3/8	R	15	993042											
16	R	16	3	931516						14-3/8	L	15	993052											
15	R	17	3	992003	15	R	16	4	992202	14-1/4	R	17	993043	15-1/2	R	17	993023	14-5/8	R	16	993203			
										14-1/4	L	17	993053	15-1/2	L	17	993033	14-5/8	L	16	993213			
14-1/2	R	19	3	992004	14-1/2	R	18	4	992203	14-1/8	R	19	993044	15-1/4	R	19	993024	14-3/8	R	18	993204			
										14-1/8	L	19	993054	15-1/4	L	19	993034	14-3/8	L	18	993214			
14-1/4	R	21	3	992005	14	R	20	4	992204	14	R	21	993045	14-3/4	R	21	993025	14-1/8	R	20	993205			
										14	L	21	993055	14-3/4	L	21	993035	14-1/8	L	20	993215			
14	R	23	3	992006						13-7/8	R	23	993046	14-5/8	R	23	993026	14	R	22	993206			
										13-7/8	L	23	993056	14-5/8	L	23	993036	14	L	22	993216			

Drop-In Hub
Use XHS II® Hub Kit
204
Refer to Pages 55-57 for Details on Hub Kit Components.

Drop-In Hub
Use XHS II® Hub Kit
204
Refer to Pages 55-57 for Details on Hub Kit Components.



BALLISTIC MICHIGAN									
STAINLESS STEEL - A SERIES PROPELLERS									
3-BLADE BALLISTIC					3-BLADE BALLISTIC XL				
Dia.	Rot.	Pitch	Bld #	Part #	Dia.	Rot.	Pitch	Bld #	Part #
14-7/8	R	15	3	* 933515					
14-3/4	R	17	3	* 933517					
14-3/4	L	17	3	* 937517					
14-1/2	R	19	3	* 933519					
14-1/2	L	19	3	* 937519					
14-3/8	R	21	3	* 933521					
14-3/8	L	21	3	* 937521					
14-1/4	R	23	3	* 933523					
14-1/4	L	23	3	* 937523					
14-1/4	R	25	3	* 933525					
					14-3/4	R	22	3	* 953522
					14-3/4	R	24	3	* 953524
					14-3/4	R	26	3	* 953526
4-BLADE BALLISTIC XL									
14-1/8	R	23	4	* 963523					
14-1/8	R	25	4	* 963525					
14-1/8	R	27	4	* 963527					

Drop-In Hub
Use XHS II® Hub Kit
204
Refer to Pages 55-57 for Details on Hub Kit Components.

* May interfere with trim tab.

4-6 HORSEPOWER

Non-Thru Hub Exhaust & 9 Tooth Spline

4 HP 2-Stroke1986-1999 5 HP 2-Stroke 1995-2002 F6A 4-Stroke (1 Cyl.)2011 & Newer
 F4 4-Stroke..... 1999 & Newer

		MATCH MICHIGAN					
		ALUMINUM PROPELLERS					
Boat Description/ Length		Dia.	Rot.	Pitch	Bld #	OEM Part #	Part #
		7-1/2	R	7	3	6E0-45943-01-00	102017
		7-1/2	R	8	3	6E0-45941-01-00	102018



Rubber
Hub
Bushing
Part # 65-539

6-9.9 HORSEPOWER

Thru Hub Exhaust & 7 Tooth Spline • Replaces Yamaha® “N” Series Propellers

6 HP 2-Stroke1986-2000 8 HP 2-Stroke 1986-2009 F9.9 4-Stroke2008 & Newer
 F6 4-Stroke.....2001-2010 F8 4-Stroke.....2001 & Newer

		MATCH MICHIGAN					
		ALUMINUM PROPELLERS					
Boat Description/ Length		Dia.	Rot.	Pitch	Bld #	OEM Part #	Part #
General Usage		8-1/2	R	7-1/2	3	6G1-45943-00-00	102002
		8-1/2	R	8-1/2	3	6G1-45943-00-00	102085

102002



Rubber
Hub
Bushing
Part # 65-360

8 HORSEPOWER

Non-Thru Hub Exhaust & Pin Drive

8 HP.....1976-1983

		MATCH MICHIGAN					
		ALUMINUM PROPELLERS					
Boat Description/ Length		Dia.	Rot.	Pitch	Bld #	OEM Part #	Part #
14'-16' - AL		8-1/4	R	8	3		012008

012008



Rubber
Hub
Bushing
Part # 65-098

9.9-20 HORSEPOWER • 2-1/2” GEARCASE

Thru Hub Exhaust & 8 Tooth Spline • Replaces Yamaha® “J” Series Propellers

9.9 HP 2-Stroke1984-2009 15 HP 2-Stroke 1984-2009 F15 C2007 & Newer
 F9.9 4-Stroke.....2000-2007 F15 4-Stroke.....1998 & Newer F20 4-Stroke2007 & Newer

		MATCH MICHIGAN					
		ALUMINUM PROPELLERS					
Boat Description/ Length		Dia.	Rot.	Pitch	Bld #	OEM Part #	Part #
14'-20' - HL		9-1/4	R	8	3	63V-45947-00-00	102003
14'-19' - AL		9-1/4	R	9	3	63V-45945-10-00	102004
14'-19' - AL		9-1/4	R	9-3/4	3	683-45952-00-00	102106
14'-16' - AL		9-1/4	R	10-1/2	3	683-45943-00-00	102005
Up to 14' - LL		9-1/4	R	12	3	683-45941-00-00	102107

102003

102004



Rubber
Hub
Bushing
Part # 65-359

See Pages
53-54 for
Attachment
Hardware

Did You Know?

Michigan Wheel propellers intended for use on Yamaha® engines will also fit Parsun® outboards and Selva® 4-Stroke outboards.

Look for the Parsun® and Selva® engine listings on Pages 43-46.



15-28 HORSEPOWER

Non-Thru Hub Exhaust & Pin Drive

15A & W15 HP1976-1983 25 HP 2 Cyl..... 1977-1979 28 HP 1976-1978
 20 HP.....1976-1978

Boat Description/ Length	MATCH MICHIGAN					
	ALUMINUM PROPELLERS					
	Dia.	Rot.	Pitch	Bld #	OEM Part #	Part #
HB, SB	9-1/4	R	7	3	650-45943-01-36	012102
12'-14' - HL	9	R	9	3		012109
12'-14' - HL	9	R	10	3	651-45947-00-36	012011
12'-14' - AL	9-1/4	R	11	3	653-45941-01-36	012013



Rubber
Hub
Bushing
Part # 65-079

20-30 HORSEPOWER • 3" GEARCASE

Thru Hub Exhaust & 10 Tooth Spline • Replaces Yamaha® "F" Series Propellers • **! MUST use Gearcase Adapter Ring supplied with propeller.**

20 HP.....1996-1997 F25 4-Stroke..... 1998-2006; 2010 & Newer 30 HP 1983-2002
 25 HP..... 1980 & Newer

Boat Description/ Length	VORTEX MICHIGAN					
	ALUMINUM - E SERIES PROPELLERS					
	Dia.	Rot.	Pitch	Bld #	OEM Part #	Part #
16'-18' - AL	10-1/2	R	9	3		992501
14'-17' - AL	10-1/2	R	10	3		992502
14'-17' - AL	10-1/2	R	11	3		992503
13'-16' - LL	10-1/8	R	12	3		992504
13'-16' - LL	10-1/8	R	13	3		992505
13'-16' - LL	10-1/8	R	14	3		992506

Drop-In
Hub
Use XHS®
or XHS II®
Hub Kit
123
OR
223
!



Boat Description/ Length	MATCH MICHIGAN					
	ALUMINUM PROPELLERS					
	Dia.	Rot.	Pitch	Bld #	OEM Part #	Part #
16'-18' - AL	9-7/8	R	9	3	664-45941-01-00	022001
15'-17' - AL	9-7/8	R	10-1/2	3	664-45945-00-00	022002
14'-16' - AL	9-7/8	R	11-1/4	3	664-45947-10-00	022004
13'-16' - LL	9-7/8	R	12	3	664-45954-01-00	022003
13'-16' - LL	9-7/8	R	13	3	664-45949-02-00	022005
Up to 15' - LL	9-7/8	R	14	3	664-45952-00-00	022006
Up to 15' - LL						

Rubber
Hub
Bushing
Part # 65-265
Refer to
Pages 53-54
for Details
on Attachment
Hardware
Components.

Boat Description/ Length	BALLISTIC MICHIGAN					
	STAINLESS STEEL - E SERIES PROPELLERS					
	Dia.	Rot.	Pitch	Bld #	OEM Part #	Part #
	10-1/8	R	13	3		* 933013
	10-1/8	R	15	3		* 933015

Drop-In
Hub
Use XHS®
or XHS II®
Hub Kit
123
OR
223
!

Note: * May interfere with trim tab.
Gearcase adaptor rings may be slightly larger than engine gearcase.

Did You Know?

A recently conducted independent survey, conducted in cooperation with Michigan Wheel, found Michigan Wheel to have the highest overall customer satisfaction among aftermarket propeller manufacturers.



25-60 HORSEPOWER • 3-1/2" GEARCASE

Thru Hub Exhaust & 13 Tooth Spline • Replaces Yamaha® "G" Series Propellers

T25 HP.....2010 & Newer	48 HP.....1995-2000	55 HP.....1976-1995
F30 4-Stroke.....2001-2005; 2015 & Newer	50 HP (Not T50).....1984 & Newer	60 HP.....1976-1991
40 HP (Includes 40C).....1984 & Newer	F50 4-Stroke.....1995 & Newer	F60 4-Stroke.....1999 & Newer
F40 4-Stroke.....1999 & Newer		

VORTEX MICHIGAN								Drop-In Hub Use XHS® or XHS II® Hub Kit 117 OR 217 <small>NEW</small> Refer to Pages 55-57 for Details on Hub Kit Components.	APOLLO MICHIGAN								Drop-In Hub Use XHS® or XHS II® Hub Kit 117 OR 217 <small>NEW</small> Refer to Pages 55-57 for Details on Hub Kit Components.		
ALUMINUM - D SERIES PROPELLERS									STAINLESS STEEL - D SERIES PROPELLERS										
3-BLADE				LG. DIAMETER 3-BLADE					4-BLADE										
Dia.	Rot.	Pitch	Part #	Dia.	Rot.	Pitch	Part #		Dia.	Rot.	Pitch	Part #	Dia.	Rot.	Pitch	Bld #		OEM Part #	Part #
									11-1/2	R	8	992401							
				12-1/4	R	9	992601		11-1/2	R	9	992402							
				11-3/4	R	10	992602		11-1/2	R	10	992403							
10-3/8	R	11	992404	11-5/8	R	11	992603		4-BLADE										
10-3/8	R	12	992405	11-3/8	R	12	992604		10-5/8	R	12	941212	10-3/4	R	12	3		MAR-10512-HR-C0	993405
10-3/8	R	13	992406	11-1/8	R	13	992605		10-3/8	R	13	941213	10-1/2	R	13	3		MAR-10513-HR-C0	993406
10-3/8	R	14	992407	11-1/4	R	14	992606	10-1/8	R	14	941214	10-3/8	R	14	3	MAR-10514-HR-C0	993407		
10	R	15	992408					10-1/8	R	15	941215	10-1/8	R	15	3	MAR-10515-HR-C0	993408		
10	R	16	992409																

Boat Description/ Length	MATCH MICHIGAN						Rubber Hub Bushing Part # 65-205 Refer to Pages 53-54 for Details on Attachment Hardware Components.	BALLISTIC MICHIGAN						Drop-In Hub Use XHS® or XHS II® Hub Kit 117 OR 217 <small>NEW</small> Refer to Pages 55-57 for Details on Hub Kit Components.
	ALUMINUM PROPELLERS							STAINLESS STEEL - D SERIES PROPELLERS						
	Dia.	Rot.	Pitch	Bld #	OEM Part #	Part #		Dia.	Rot.	Pitch	Bld #	OEM Part #	Part #	
18' & Up - HL	12-1/4	R	9	3	663-45956-01-00	032046								
17' & Up - HL	11-3/4	R	10	3		032045								
16'-18' - AL, SK	11-5/8	R	11	3	69W-45947-00-00	032044								
15'-17' - CUPPED	10-5/8	R	12	3	6H5-45952-00-00	031074								
15'-17' - AL, SK	11-3/8	R	12	3	69W-45952-00-00	032043								
14'-17' - CUPPED	10-3/8	R	13	3	6H5-45945-00-00	031075								
14'-17' - AL, SK	11-1/8	R	13	3	69W-45945-00-00	032042		10-1/8	R	13	3		933213	
14'-16' - CUPPED	10-1/4	R	14		6H5-45958-00-00	031076								
14'-16' - LL	11-1/4	R	14	3	69W-45958-00-00	032041								
12'-14' - LL	11	R	15	3	69W-45943-00-00	032040	10-1/8	R	15	3		933215		

80-140 HORSEPOWER

Thru Hub Exhaust & 15 Tooth Spline

80 HP.....1977-1983	90 & 115 HP.....1978-1983	140 HP.....1978-1979
---------------------	---------------------------	----------------------

See Mercury® 40-140 HP Product Offering on Page 25.

150-175 HORSEPOWER

Thru Hub Exhaust & 15 Tooth Spline

150 HP.....1979-1983	175 HP.....1978-1979
----------------------	----------------------

See Mercury® V-6 Product Offering on Page 26.



50-130 HORSEPOWER • 4-1/4" GEARCASE



Thru Hub Exhaust & 15 Tooth Spline • Replaces Yamaha® "K" Series Propellers

T50 HP 1996 & Newer
 T60 HP 2003 & Newer
 60 HP (Includes C60/E60/P60) 1992-2005
 F70 4-Stroke 2010 & Newer
 70 HP 1984 & Newer
 F75 4-Stroke 2003 & Newer

75 HP (Includes C75/E75/P75) 1994-1999
 80 HP 1997
 F80 4-Stroke 1999-2002
 85 HP 1991-1997
 F90 4-Stroke 1999 & Newer

90 HP (Includes C90) 1984 & Newer
 F100 4-Stroke 2000 & Newer
 F115 4-Stroke 2000 & Newer
 115 HP (Includes C115/P115) 1984 & Newer
 130 HP 1984 & Newer

																	
3-BL ALUMINUM - B SERIES					4-BL ALUMINUM - B SERIES					Drop-In Hub Use XHS II® Hub Kit 203 / 208 USE Gearcase Adapter Ring supplied with propeller. Refer to Pages 55-57 for Details on Hub Kit Components.	STAINLESS STEEL - B SERIES PROPELLERS						Drop-In Hub Use XHS II® Hub Kit 203 / 208 USE Gearcase Adapter Ring supplied with propeller. Refer to Pages 55-57 for Details on Hub Kit Components.
Dia.	Rot.	Pitch	Bld #	Part #	Dia.	Rot.	Pitch	Bld #	Part #		Dia.	Rot.	Pitch	Bld #	OEM Part #	Part #	
14	R	10	3	992109													
14	R	11	3	992111	13-7/8	R	11	4	941411								
14	R	13	3	992112	13-7/8	R	13	4	941413								
13-3/4	R	15	3	992113	13-3/8	R	15	4	941415		13-3/8	R	15	3		* 993143	
											13-3/8	L	15	3		* 993153	
13-1/4	R	17	3	992114	13	R	17	4	941417		13-1/4	R	17	3	688-45930-02-00	* 993144	
											13-1/4	L	17	3	6L6-45930-01-00	* 993154	
13	R	19	3	992115	12-1/2	R	19	4	941419		13-1/8	R	19	3	688-45970-03-00	* 993145	
										13-1/8	L	19	3	6L6-45970-00-00	* 993155		
12-3/4	R	21	3	992116						13	R	21	3	688-45972-02-00	* 993146		
										13	L	21	3	6L6-45972-00-00	* 993156		

Boat Description/Length																
	ALUMINUM PROPELLERS						STAINLESS STEEL - B SERIES PROPELLERS									
	Dia.	Rot.	Pitch	Bld #	OEM Part #	Part #	3-BLADE BALLISTIC			3-BLADE BALLISTIC XL						
							Dia.	Rot.	Pitch	Bld #	Part #	Dia.	Rot.	Pitch	Bld #	Part #
25' & Up	14	R	11	3		101036										
22'-25' - AL	13-5/8	R	13	3	6E5-45949-00-00	101031										
20'-24' - AL	13-1/2	R	15	3	6E5-45947-00-00	101032	13-5/8	R	15	3	933415					
17'-19' - AL	13-1/4	R	17	3	6E5-45945-01-00	101033	13-1/2	R	17	3	933417					
16'-18' - AL	13	R	19	3	6E5-45941-00-00	101034	13-3/8	R	19	3	933419					
15'-18' - AL	12-5/8	R	21	3		101035	13-1/8	R	21	3	* 933421					
High Performance												13-1/2	R	22	3	* 953422
High Performance												13-1/2	R	24	3	* 953424

Note: For F75B (4-Stroke), F90B (4-Stroke), 115 HP, F115 (4-Stroke), and 130 HP engine applications use XHS II® (Drop-In Hub) Kit #203.
 For all other engine applications use XHS II® (Drop-In Hub) Kit #208.

Note: * Michigan Wheel high performance trim tab P/N 990341 is required when using stainless steel propellers on Yamaha 50-130 HP engines.

150-300 HORSEPOWER • 4-3/4" GEARCASE

Thru Hub Exhaust & 15 Tooth Spline • Replaces Yamaha® "M" or "T" Series Propellers

150 HP.....	1986 & Newer
F150 4-Stroke.....	2004 & Newer
175 HP.....	1984 & Newer
F175 4-Stroke.....	2014 & Newer
200 HP.....	1984 & Newer
200 HP V MAX®.....	2001
F200 4-Stroke.....	2002 & Newer
VF200 V MAX® SHO.....	2010 & Newer

220 HP (Special).....	1984-1985
225 HP (Excel).....	1987-1988
225 HP.....	1986 & Newer
F225 4-Stroke.....	2002 & Newer
VF225 V MAX® SHO.....	2010 & Newer
F225 Offshore.....	2010 & Newer
250 HP.....	1990 & Newer
250 HP V MAX®.....	2001

F250 4-Stroke.....	2002 & Newer
VF250 V MAX® SHO.....	2010 & Newer
F250 Offshore.....	2010 & Newer
300 HP.....	2004-2007
F300 Offshore.....	2010 & Newer

*For engines 300 HP or higher, use "High Horsepower Sleeve" (P/N 991372). See Page 48 for more details.

VORTEX MICHIGAN									
3-BL ALUMINUM - A SERIES					4-BL ALUMINUM - A SERIES				
Dia.	Rot.	Pitch	Bld #	Part #	Dia.	Rot.	Pitch	Bld #	Part #
16	R	13	3	992001					
15-1/4	R	15	3	992002					
16	R	16	3	931516					
15	R	17	3	992003	15	R	16	4	992202
14-1/2	R	19	3	992004	14-1/2	R	18	4	992203
14-1/4	R	21	3	992005	14	R	20	4	992204
14	R	23	3	992006					

Drop-In Hub
Use XHS II® Hub Kit
203
Refer to Pages 55-57 for Details on Hub Kit Components.

APOLLO MICHIGAN											
STD. 3-BLADE A SERIES				LG DIA. 3-BLADE A SERIES				4-BLADE A SERIES			
Dia.	Rot.	Pitch	Part #	Dia.	Rot.	Pitch	Part #	Dia.	Rot.	Pitch	Part #
14-3/8	R	15	993042								
14-3/8	L	15	993052								
14-1/4	R	17	993043	15-1/2	R	17	993023	14-5/8	R	16	993203
14-1/4	L	17	993053	15-1/2	L	17	993033	14-5/8	L	16	993213
14-1/8	R	19	993044	15-1/4	R	19	993024	14-3/8	R	18	993204
14-1/8	L	19	993054	15-1/4	L	19	993034	14-3/8	L	18	993214
14	R	21	993045	14-3/4	R	21	993025	14-1/8	R	20	993205
14	L	21	993055	14-3/4	L	21	993035	14-1/8	L	20	993215
13-7/8	R	23	993046	14-5/8	R	23	993026	14	R	22	993206
13-7/8	L	23	993056	14-5/8	L	23	993036	14	L	22	993216

Drop-In Hub
Use XHS II® Hub Kit
203
Refer to Pages 55-57 for Details on Hub Kit Components.

Boat Description/ Length	MATCH MICHIGAN					
	ALUMINUM PROPELLERS					
	Dia.	Rot.	Pitch	Bld #	OEM Part #	Part #
20'-22' - AL, SK	15-1/4	R	15	3	6G5-45941-00-00	101025
19'-21' - AL, SK	14-1/2	R	17	3	6G5-45947-01-00	101027
19'-21' - AL, SK						
18'-20' - AL, SK	14	R	19	3	6G5-45945-01-00	101028
18'-20' - AL, SK						
18'-20' - AL, SK	13-3/4	R	21	3	6G5-45943-01-00	101029
18'-20' - AL, SK						
Up to 18' - AL, SK						
Up to 18' - AL, SK						
Up to 18' - AL, SK						
High Performance						
High Performance						
High Performance						
High Performance						
High Performance						
High Performance						

Rubber Hub Bushing
Part # 65-441
Refer to Pages 53-54 for Details on Attachment Hardware Components.

BALLISTIC MICHIGAN														
STAINLESS STEEL - A SERIES PROPELLERS														
3-BLADE BALLISTIC						3-BLADE BALLISTIC XL								
Dia.	Rot.	Pitch	Bld #	Part #	Dia.	Rot.	Pitch	Bld #	Part #	Dia.	Rot.	Pitch	Bld #	Part #
14-7/8	R	15	3	933515										
14-3/4	R	17	3	933517										
14-3/4	L	17	3	937517										
14-1/2	R	19	3	933519										
14-1/2	L	19	3	937519										
14-3/8	R	21	3	933521										
14-3/8	L	21	3	937521										
14-1/4	R	23	3	933523										
14-1/4	L	23	3	937523										
14-1/4	R	25	3	933525										
										14-3/4	R	22	3	* 953522
										14-3/4	R	24	3	* 953524
										14-3/4	R	26	3	* 953526
										4-BLADE BALLISTIC XL				
										14-1/8	R	23	4	* 963523
										14-1/8	R	25	4	* 963525
										14-1/8	R	27	4	* 963527

Drop-In Hub
Use XHS II® Hub Kit
203
Refer to Pages 55-57 for Details on Hub Kit Components.



* May interfere with trim tab.

6 - 9.9 HORSEPOWER

Thru Hub Exhaust & 7 Tooth Spline



Parsun® 6 HP 4-StrokeAll Years Parsun® 8 HP 4-StrokeAll Years Parsun® 9.8 HP 4-StrokeAll Years
 Selva® 8 HP (Ray)2014 & Newer Selva® 9.9 HP (Pike)2014 & Newer

Boat Description/ Length	MATCH MICHIGAN						102002	102085	 102002	Rubber Hub Bushing Part # 65-360
	ALUMINUM PROPELLERS									
	Dia.	Rot.	Pitch	Bld #	OEM Part #	Part #				
General Usage	8-1/2	R	7-1/2	3	6G1-45943-00-00	102002				
	8-1/2	R	8-1/2	3	6G1-45943-00-00	102085				

9.9 - 15 HORSEPOWER • 2-1/2" GEARCASE

Thru Hub Exhaust & 8 Tooth Spline

Parsun® 9.9 HP 4-StrokeAll Years Parsun® 15 HP 4-StrokeAll Years Parsun® T15All Years
 Parsun® T9.9All Years
 Selva® 9.9XS (Wahoo)2014 & Newer Selva® 15 HP (Wahoo)2014 & Newer

Boat Description/ Length	MATCH MICHIGAN						102003	102004	 102003	 102004	Rubber Hub Bushing Part # 65-359
	ALUMINUM PROPELLERS										
	Dia.	Rot.	Pitch	Bld #	OEM Part #	Part #					
14'-20' - HL	9-1/4	R	8	3	63V-45947-00-00	102003					
14'-19' - AL	9-1/4	R	9	3	63V-45945-10-00	102004					
14'-19' - AL	9-1/4	R	9-3/4	3	683-45952-00-00	102106					
14'-16' - AL	9-1/4	R	10-1/2	3	683-45943-00-00	102005					
Up to 14' - LL	9-1/4	R	12	3	683-45941-00-00	102107					

20-25 HORSEPOWER • 3" GEARCASE

Thru Hub Exhaust & 10 Tooth Spline **!** MUST use Gearcase Adapter Ring supplied with propeller.

Parsun® 20 HP 4-StrokeAll Years Parsun® 25 HP 4-StrokeAll Years Parsun® T25All Years
 Parsun® T20All Years
 Selva® 25 HP (Kingfish)2014 & Newer

Boat Description/ Length	VORTEX MICHIGAN						Drop-In Hub Use XHS® or XHS II® Hub Kit 123 OR 223 !	991244 - Gearcase Adapter Rings 	022001 	022003 
	ALUMINUM - E SERIES PROPELLERS									
	Dia.	Rot.	Pitch	Bld #	OEM Part #	Part #				
16'-18' - AL	10-1/2	R	9	3	992501	992501				
14'-17' - AL	10-1/2	R	10	3	992502	992502				
14'-17' - AL	10-1/2	R	11	3	992503	992503				
13'-16' - LL	10-1/8	R	12	3	992504	992504				
13'-16' - LL	10-1/8	R	13	3	992505	992505				
13'-16' - LL	10-1/8	R	14	3	992506	992506				

Boat Description/ Length	MATCH MICHIGAN						Drop-In Hub Use XHS® or XHS II® Hub Kit 123 OR 223 !	BALLISTIC MICHIGAN STAINLESS STEEL - E SERIES PROPELLERS
	ALUMINUM PROPELLERS							
	Dia.	Rot.	Pitch	Bld #	OEM Part #	Part #		
16'-18' - AL	9-7/8	R	9	3	664-45941-01-00	022001		
15'-17' - AL	9-7/8	R	10-1/2	3	664-45945-00-00	022002		
14'-16' - AL	9-7/8	R	11-1/4	3	664-45947-10-00	022004		
13'-16' - LL	9-7/8	R	12	3	664-45954-01-00	022003		
13'-16' - LL	9-7/8	R	13	3	664-45949-02-00	022005		
Up to 15' - LL	9-7/8	R	14	3	664-45952-00-00	022006		
Up to 15' - LL							10-1/8 R 13 3 * 933013 10-1/8 R 15 3 * 933015	

Note: * May interfere with trim tab.

15-60 HORSEPOWER • 3-1/2" GEARCASE

Thru Hub Exhaust & 13 Tooth Spline

Parsun® T35.....All Years	Parsun®T40.....All Years	
Selva® 15 XS EFI (Aruana)2014 & Newer	Selva® 30 XS (Dorado)2014 & Newer	Selva® 60 EFI (Dorado).....2014 & Newer
Selva® 20 XS (Dorado)2014 & Newer	Selva® 40 EFI (Aruana).....2014 & Newer	Selva® 60XSR EFI (Dorado) ..2014 & Newer
Selva® 25 XS (Dorado)2014 & Newer	Selva® 50XSR (Dorado).....2014 & Newer	

VORTEX
MICHIGAN

ALUMINUM - D SERIES PROPELLERS

3-BLADE				LG. DIAMETER 3-BLADE				4-BLADE			
Dia.	Rot.	Pitch	Part #	Dia.	Rot.	Pitch	Part #	Dia.	Rot.	Pitch	Part #
								11-1/2	R	8	992401
				12-1/4	R	9	992601	11-1/2	R	9	992402
				11-3/4	R	10	992602	11-1/2	R	10	992403
10-3/8	R	11	992404	11-5/8	R	11	992603	4-BLADE			
10-3/8	R	12	992405	11-3/8	R	12	992604	10-5/8	R	12	941212
10-3/8	R	13	992406	11-1/8	R	13	992605	10-3/8	R	13	941213
10-3/8	R	14	992407	11-1/4	R	14	992606	10-1/8	R	14	941214
10	R	15	992408					10-1/8	R	15	941215
10	R	16	992409								

Drop-In Hub

Use XHS® or XHS II® Hub Kit

117 OR 217

Refer to Pages 55-57 for Details on Hub Kit Components.

APOLLO
MICHIGAN

STAINLESS STEEL - D SERIES PROPELLERS

Dia.	Rot.	Pitch	Bld #	OEM Part #	Part #
10-3/4	R	12	3	MAR-10512-HR-C0	993405
10-1/2	R	13	3	MAR-10513-HR-C0	993406
10-3/8	R	14	3	MAR-10514-HR-C0	993407
10-1/8	R	15	3	MAR-10515-HR-C0	993408

Drop-In Hub

Use XHS® or XHS II® Hub Kit

117 OR 217

Refer to Pages 55-57 for Details on Hub Kit Components.

MATCH
MICHIGAN

ALUMINUM PROPELLERS

Boat Description/ Length	Dia.	Rot.	Pitch	Bld #	OEM Part #	Part #
	18' & Up - HL	12-1/4	R	9	3	663-45956-01-00
17' & Up - HL	11-3/4	R	10	3		032045
16'-18' - AL, SK	11-5/8	R	11	3	69W-45947-00-00	032044
15'-17' - CUPPED	10-5/8	R	12	3	6H5-45952-00-00	031074
15'-17' - AL, SK	11-3/8	R	12	3	69W-45952-00-00	032043
14'-17' - CUPPED	10-3/8	R	13	3	6H5-45945-00-00	031075
14'-17' - AL, SK	11-1/8	R	13	3	69W-45945-00-00	032042
14'-16' - CUPPED	10-1/4	R	14	3	6H5-45958-00-00	031076
14'-16' - LL	11-1/4	R	14	3	69W-45958-00-00	032041
12'-14' - LL	11	R	15	3	69W-45943-00-00	032040

Rubber Hub Bushing
Part # 65-205

BALLISTIC
MICHIGAN

STAINLESS STEEL - D SERIES PROPELLERS

Dia.	Rot.	Pitch	Bld #	OEM Part #	Part #
10-1/8	R	13	3		933213
10-1/8	R	15	3		933215

Drop-In Hub

Use XHS® or XHS II® Hub Kit

117 OR 217

Refer to Pages 55-57 for Details on Hub Kit Components.

30-115 HORSEPOWER • 4-1/4" GEARCASE

Thru Hub Exhaust & 15 Tooth Spline • Replaces Yamaha® "K" Series Propellers

Parsun® T60.....All Years	Parsun® T85.....All Years	Parsun® T90.....All Years
Parsun® T75.....All Years		
Selva® 30XS (Marlin).....2014 & Newer	Selva® 50XS (Marlin).....2014 & Newer	Selva® 80XS (Marlin).....2014 & Newer
Selva® 40XS (Marlin).....2014 & Newer	Selva® 50XS (Murena).....2014 & Newer	Selva® 100 XS (Marlin).....2014 & Newer
Selva® 40XS (Tarpon).....2014 & Newer	Selva® 70XSR EFI (Murena).....2014 & Newer	Selva® 115 EFI (Tarpon).....2014 & Newer

VORTEX MICHIGAN					4-BL ALUMINUM - B SERIES				
Dia.	Rot.	Pitch	Bld #	Part #	Dia.	Rot.	Pitch	Bld #	Part #
14	R	10	3	992109					
14	R	11	3	992111	13-7/8	R	11	4	941411
14	R	13	3	992112	13-7/8	R	13	4	941413
13-3/4	R	15	3	992113	13-3/8	R	15	4	941415
13-1/4	R	17	3	992114	13	R	17	4	941417
13	R	19	3	992115	12-1/2	R	19	4	941419
12-3/4	R	21	3	992116					

Drop-In Hub

Use XHS II® Hub Kit
203 / 208

USE Gearcase Adapter Ring supplied with propeller.

Refer to Pages 55-57 for Details on Hub Kit Components.

APOLLO MICHIGAN						STAINLESS STEEL - B SERIES PROPELLERS					
Dia.	Rot.	Pitch	Bld #	OEM Part #	Part #	Dia.	Rot.	Pitch	Bld #	OEM Part #	Part #
						13-3/8	R	15	3		* 993143
						13-3/8	L	15	3		* 993153
						13-1/4	R	17	3	688-45930-02-00	* 993144
						13-1/4	L	17	3	6L6-45930-01-00	* 993154
						13-1/8	R	19	3	688-45970-03-00	* 993145
						13-1/8	L	19	3	6L6-45970-00-00	* 993155
						13	R	21	3	688-45972-02-00	* 993146
						13	L	21	3	6L6-45972-00-00	* 993156

Drop-In Hub

Use XHS II® Hub Kit
203 / 208

USE Gearcase Adapter Ring supplied with propeller.

Refer to Pages 55-57 for Details on Hub Kit Components.

Boat Description/Length	MATCH MICHIGAN					
	ALUMINUM PROPELLERS					
	Dia.	Rot.	Pitch	Bld #	OEM Part #	Part #
25' & Up	14	R	11	3		101036
22'-25' - AL	13-5/8	R	13	3	6E5-45949-00-00	101031
20'-24' - AL	13-1/2	R	15	3	6E5-45947-00-00	101032
17'-19' - AL	13-1/4	R	17	3	6E5-45945-01-00	101033
16'-18' - AL	13	R	19	3	6E5-45941-00-00	101034
15'-18' - AL	12-5/8	R	21	3		101035
High Performance						
High Performance						

Rubber Hub Bushing
Part # 65-441

BALLISTIC MICHIGAN														
3-BLADE BALLISTIC						3-BLADE BALLISTIC XL								
Dia.	Rot.	Pitch	Bld #	Part #	Dia.	Rot.	Pitch	Bld #	Part #	Dia.	Rot.	Pitch	Bld #	Part #
						13-5/8	R	15	3	933415				
						13-1/2	R	17	3	933417				
						13-3/8	R	19	3	933419				
						13-1/8	R	21	3	* 933421				
										13-1/2	R	22	3	* 953422
										13-1/2	R	24	3	* 953424

Drop-In Hub

Use XHS II® Hub Kit
203 / 208

USE Gearcase Adapter Ring supplied with propeller.

Refer to Pages 55-57 for Details on Hub Kit Components.

Note: For 115 HP use XHS II® (Drop-In Hub) Kit #203.
For all other engine applications use XHS II® (Drop-In Hub) Kit #208.

Note: * Michigan Wheel high performance trim tab P/N 990341 is required when using stainless steel propellers.

150-250 HORSEPOWER • 4-3/4" GEARCASE

Thru Hub Exhaust & 15 Tooth Spline • Replaces Yamaha® "M" or "T" Series Propellers

Selva® 150XSR EFI (Killer Whale)..2014 & Newer
Selva® 150 EFI (Killer Whale).....2014 & Newer

Selva® 200 EFI (Grey Whale)2014 & Newer
Selva® 225 EFI (Fin Whale).....2014 & Newer

Selva® 250 EFI (Blue Whale)..2014 & Newer

VORTEX
MICHIGAN

APOLLO
MICHIGAN

3-BL ALUMINUM - A SERIES **4-BL ALUMINUM - A SERIES**

STD. 3-BLADE A SERIES **LG DIA. 3-BLADE A SERIES** **4-BLADE A SERIES**

Dia.	Rot.	Pitch	Bld #	Part #	Dia.	Rot.	Pitch	Bld #	Part #
16	R	13	3	992001					
15-1/4	R	15	3	992002					
16	R	16	3	931516					
15	R	17	3	992003	15	R	16	4	992202
14-1/2	R	19	3	992004	14-1/2	R	18	4	992203
14-1/4	R	21	3	992005	14	R	20	4	992204
14	R	23	3	992006					

Drop-In Hub
Use XHS II® Hub Kit
203
Refer to Pages 55-57 for Details on Hub Kit Components.

Dia.	Rot.	Pitch	Part #	Dia.	Rot.	Pitch	Part #	Dia.	Rot.	Pitch	Part #
14-3/8	R	15	993042								
14-3/8	L	15	993052								
14-1/4	R	17	993043	15-1/2	R	17	993023	14-5/8	R	16	993203
14-1/4	L	17	993053	15-1/2	L	17	993033	14-5/8	L	16	993213
14-1/8	R	19	993044	15-1/4	R	19	993024	14-3/8	R	18	993204
14-1/8	L	19	993054	15-1/4	L	19	993034	14-3/8	L	18	993214
14	R	21	993045	14-3/4	R	21	993025	14-1/8	R	20	993205
14	L	21	993055	14-3/4	L	21	993035	14-1/8	L	20	993215
13-7/8	R	23	993046	14-5/8	R	23	993026	14	R	22	993206
13-7/8	L	23	993056	14-5/8	L	23	993036	14	L	22	993216

Drop-In Hub
Use XHS II® Hub Kit
203
Refer to Pages 55-57 for Details on Hub Kit Components.

MATCH
MICHIGAN

BALLISTIC
MICHIGAN

ALUMINUM PROPELLERS

STAINLESS STEEL - A SERIES PROPELLERS

Boat Description/Length

Dia.	Rot.	Pitch	Bld #	OEM Part #	Part #	
20'-22' - AL, SK	15-1/4	R	15	3	6G5-45941-00-00	101025
19'-21' - AL, SK	14-1/2	R	17	3	6G5-45947-01-00	101027
19'-21' - AL, SK						
18'-20' - AL, SK	14	R	19	3	6G5-45945-01-00	101028
18'-20' - AL, SK						
18'-20' - AL, SK	13-3/4	R	21	3	6G5-45943-01-00	101029
18'-20' - AL, SK						
Up to 18' - AL, SK						
Up to 18' - AL, SK						
Up to 18' - AL, SK						
High Performance						
High Performance						
High Performance						
High Performance						
High Performance						
High Performance						
High Performance						

Rubber Hub Bushing
Part # 65-441

3-BLADE BALLISTIC					3-BLADE BALLISTIC XL				
Dia.	Rot.	Pitch	Bld #	Part #	Dia.	Rot.	Pitch	Bld #	Part #
14-7/8	R	15	3	933515					
14-3/4	R	17	3	933517					
14-3/4	L	17	3	937517					
14-1/2	R	19	3	933519					
14-1/2	L	19	3	937519					
14-3/8	R	21	3	933521					
14-3/8	L	21	3	937521					
14-1/4	R	23	3	933523					
14-1/4	L	23	3	937523					
14-1/4	R	25	3	933525					
					14-3/4	R	22	3	⊗ 953522
					14-3/4	R	24	3	⊗ 953524
					14-3/4	R	26	3	⊗ 953526
					4-BLADE BALLISTIC XL				
					14-1/8	R	23	4	⊗ 963523
					14-1/8	R	25	4	⊗ 963525
					14-1/8	R	27	4	⊗ 963527



⊗ May interfere with trim tab.

Drop-In Hub
Use XHS II® Hub Kit
203
Refer to Pages 55-57 for Details on Hub Kit Components.

MERCURISER®, ALPHA ONE™, BRAVO ONE™ • 4-3/4" GEARCASE

Thru Hub Exhaust & 15 Tooth Spline

MODELS 1A, 1B, 1C.....Thru 1982
 MODELS 120, 140, 145 DTS.....Thru 1982
 MODELS 165, 228, 470, 485, 888, 898 ...Thru 1982
 MODELS 225S, 233, 255TRS.....Thru 1982
 MODELS 260, 280TRS, 330TRSThru 1982
 120-190 HP Mercruiser®.....1983-1985
 200-260 HP Mercruiser®.....1983-1985

Alpha One™
 2.5L - 5.7L Alpha One™
 6.2L MPI Alpha One™
 262, 350, 454 Magnum
 320 EFI Alpha One™

All Years
 All Years
 All Years
 All Years

Bravo One™ (Bravo One™ & Bravo One™ X Drives only)
 320 EFI, 350, 377All Years
 5.0L - 7.4L Bravo One™All Years
 D2.8L - D7.3L (Diesel).....All Years

*For engines 300 HP or higher, use "High Horsepower Sleeve" (P/N 991372). See Page 48 for more details.

STERNDRIVES

VORTEX MICHIGAN					4-BL ALUMINUM - A SERIES			
Dia.	Rot.	Pitch	Bld #	Part #	Dia.	Rot.	Pitch	Part #
16	R	13	3	992001				
15-1/4	R	15	3	992002				
16	R	16	3	931516				
15	R	17	3	992003	15	R	16	4 992202
14-1/2	R	19	3	992004	14-1/2	R	18	4 992203
14-1/4	R	21	3	992005	14	R	20	4 992204
14	R	23	3	992006				

Drop-In Hub
 Use XHS II® Hub Kit
202

Refer to Pages 55-57 for Details on Hub Kit Components.

APOLLO MICHIGAN											
STD. 3-BLADE A SERIES				LG DIA. 3-BLADE A SERIES				4-BLADE A SERIES			
Dia.	Rot.	Pitch	Part #	Dia.	Rot.	Pitch	Part #	Dia.	Rot.	Pitch	Part #
14-3/8	R	15	993042								
14-3/8	L	15	993052								
14-1/4	R	17	993043	15-1/2	R	17	993023	14-5/8	R	16	993203
14-1/4	L	17	993053	15-1/2	L	17	993033	14-5/8	L	16	993213
14-1/8	R	19	993044	15-1/4	R	19	993024	14-3/8	R	18	993204
14-1/8	L	19	993054	15-1/4	L	19	993034	14-3/8	L	18	993214
14	R	21	993045	14-3/4	R	21	993025	14-1/8	R	20	993205
14	L	21	993055	14-3/4	L	21	993035	14-1/8	L	20	993215
13-7/8	R	23	993046	14-5/8	R	23	993026	14	R	22	993206
13-7/8	L	23	993056	14-5/8	L	23	993036	14	L	22	993216

Drop-In Hub
 Use XHS II® Hub Kit
202

Refer to Pages 55-57 for Details on Hub Kit Components.

Boat Description/ Length	MATCH MICHIGAN					
	ALUMINUM PROPELLERS					
	Dia.	Rot.	Pitch	Bld #	OEM Part #	Part #
CR, HB	16	R	13	3	48-78114A45	031513
21'-24' - AL	15-1/4	R	15	3	48-78116A45	031023
20'-23' - AL, SK	16	R	16	3	48-16440A45	031516
19'-23' - AL, SK	14-1/2	R	17	3	48-78118A40	031024
19'-23' - AL, SK	15	R	17	3	48-832828A45	031064
19'-22' - AL, SK	15-1/2	R	18	3	48-11324A45	031052
18'-22' - AL, SK	14	R	19	3	48-78120A40	031025
18'-22' - AL, SK	14-1/2	R	19	3	48-832830A45	031065
18'-20' - AL, SK	13-3/4	R	21	3	48-78122A40	031026
18'-20' - AL, SK	14-1/4	R	21	3	48-832832A45	031066
17'-20' - AL, SK						
17'-20' - AL, SK						
Up to 18'						
High Performance						
High Performance						
High Performance						
High Performance						
High Performance						
High Performance						

Rubber Hub Bushing
 Part # 65-322
 Use MWM Kit 990312 (Conductivity Washer, Aft Washer) or MWM Kit 9661-1 (Fwd Washer, Conductivity Washer, Aft Washer, Tab Washer, Propeller Nut)
 See Page 24 for details.

BALLISTIC MICHIGAN														
STAINLESS STEEL - A SERIES PROPELLERS														
3-BLADE BALLISTIC						3-BLADE BALLISTIC XL								
Dia.	Rot.	Pitch	Bld #	Part #	Dia.	Rot.	Pitch	Bld #	Part #	Dia.	Rot.	Pitch	Bld #	Part #
14-7/8	R	15	3	933515										
14-3/4	R	17	3	933517										
14-3/4	L	17	3	937517										
14-1/2	R	19	3	933519										
14-1/2	L	19	3	937519										
14-3/8	R	21	3	933521										
14-3/8	L	21	3	937521										
14-1/4	R	23	3	933523										
14-1/4	L	23	3	937523										
14-1/4	R	25	3	933525										
										14-3/4	R	22	3	953522
										14-3/4	R	24	3	953524
										14-3/4	R	26	3	953526

Drop-In Hub
 Use XHS II® Hub Kit
202

Refer to Pages 55-57 for Details on Hub Kit Components.

Note: * Replace standard trim tab with Michigan Wheel trim tab P/N 990404.
 ☞ These applications will require Michigan Wheel anode plate P/N 990405.

BRAVO ONE™ • OVER 365 HP • (SOLID HUB) • 4-3/4" GEARCASE

Thru Hub Exhaust & 15 Tooth Spline

454 Magnum (385 HP) 1995 & Newer
 496 Magnum (375 HP) All Years

496 Magnum H.O. (425 HP) All Years
 502 Magnum (390-415 HP) 1990 & Newer

450 HP 1995
 465 HP 1991 & 1994



APOLLO
MICHIGAN

STD. 3-BLADE A SERIES					LG DIA. 3-BLADE A SERIES					4-BLADE A SERIES				
Dia.	Rot.	Pitch	Part #		Dia.	Rot.	Pitch	Part #		Dia.	Rot.	Pitch	Part #	
14-3/8	R	15	* 993042											
14-3/8	L	15	* 993052											
14-1/4	R	17	* 993043		15-1/2	R	17	993023		14-5/8	R	16	* 993203	
14-1/4	L	17	* 993053		15-1/2	L	17	993033		14-5/8	L	16	* 993213	
14-1/8	R	19	* 993044		15-1/4	R	19	993024		14-3/8	R	18	* 993204	
14-1/8	L	19	* 993054		15-1/4	L	19	993034		14-3/8	L	18	* 993214	
14	R	21	993045		14-3/4	R	21	993025		14-1/8	R	20	* 993205	
14	L	21	993055		14-3/4	L	21	993035		14-1/8	L	20	* 993215	
13-7/8	R	23	993046		14-5/8	R	23	993026		14	R	22	* 993206	
13-7/8	L	23	993056		14-5/8	L	23	993036		14	L	22	* 993216	

Drop-In Hub
 Use XHS II® Hub Kit
202SH
 Refer to Pages 55-57 for Details on Hub Kit Components.

BALLISTIC
MICHIGAN

STAINLESS STEEL - A SERIES PROPELLERS

3-BLADE BALLISTIC					3-BLADE BALLISTIC XL				
Dia.	Rot.	Pitch	Bld #	Part #	Dia.	Rot.	Pitch	Bld #	Part #
14-7/8	R	15	3	* 933515					
14-3/4	R	17	3	* 933517					
14-3/4	L	17	3	* 937517					
14-1/2	R	19	3	* 933519					
14-1/2	L	19	3	* 937519					
14-3/8	R	21	3	* 933521					
14-3/8	L	21	3	* 937521					
14-1/4	R	23	3	* 933523					
14-1/4	L	23	3	* 937523					
14-1/4	R	25	3	* 933525					
					14-3/4	R	22	3	* 953522
					14-3/4	R	24	3	* 953524
					14-3/4	R	26	3	* 953526

Drop-In Hub
 Use XHS II® Hub Kit
202SH
 Refer to Pages 55-57 for Details on Hub Kit Components.



990404



990405

Note: * Replace standard trim tab with Michigan Wheel trim tab P/N 990404. These applications will require Michigan Wheel anode plate P/N 990405.

BRAVO II™ • (BRAVO BRASS DRIVE) • 4-3/4" GEARCASE

Thru Hub Exhaust & 19 Tooth Spline

4.3 L (155-250 HP) 1996 & Newer
 5.7 L (210-300 HP) 1993 & Newer

7.4 L (300-385 HP) 1990 & Newer
 496 Magnum (375-425 HP) 2001 & Newer

D2.8 L (150 HP) 1997 & Newer
 D4.2 L (200-250 HP) 1996 & Newer

MATCH
MICHIGAN

ALUMINUM PROPELLERS

Boat Description/ Length	Dia.	Rot.	Pitch	Bld #	OEM Part #	
					OEM Part #	Part #
28' - 32' (21-31 MPH)	18-3/4	R	17	3	48-18612A40	081612
28' - 32' (21-31 MPH)	18-3/4	L	17	3	48-18613A40	081613
26' - 30' (32-36 MPH)	18-1/4	R	19	3	48-18614A40	081614
26' - 30' (32-36 MPH)	18-1/4	L	19	3	48-18615A40	081615
25' - 28' (35-40 MPH)	17-3/4	R	21	3	48-18616A40	081616
25' - 28' (35-40 MPH)	17-3/4	L	21	3	48-18617A40	081617
24' - 27' (39-44 MPH)	17-1/2	R	23	3	48-18618A40	081618
24' - 27' (39-44 MPH)	17-1/2	L	23	3	48-18619A40	081619



031619

Rubber Hub Bushing

Note: Part numbers and availability may differ in European market.

MODEL 400, COBRA® • 4-1/4" GEARCASE

Thru Hub Exhaust & 13 Tooth Spline

Model 400	Cobra®
2.3 L (120 HP) Thru 1991	2.3 L (128 HP)..... 1988-1991
2.5 L (120 HP)1978-1984	2.5 L (120 HP)..... 1985-1987
3.0 L (140 HP) Thru 1989	3.0 L (140 HP)..... 1985-1987

VORTEX MICHIGAN

3-BL ALUMINUM - B SERIES					4-BL ALUMINUM - B SERIES				
Dia.	Rot.	Pitch	Bld #	Part #	Dia.	Rot.	Pitch	Bld #	Part #
14	R	10	3	992109					
14	R	11	3	992111	13-7/8	R	11	4	941411
14	R	13	3	992112	13-7/8	R	13	4	941413
13-3/4	R	15	3	992113	13-3/8	R	15	4	941415
13-1/4	R	17	3	992114	13	R	17	4	941417
13	R	19	3	992115	12-1/2	R	19	4	941419
12-3/4	R	21	3	992116					

Drop-In Hub

Use XHS II® Hub Kit

206

Do NOT use Gearcase Adapter Ring supplied with propeller.

Refer to Pages 55-57 for Details on Hub Kit Components.

APOLLO MICHIGAN

STAINLESS STEEL - B SERIES PROPELLERS					
Dia.	Rot.	Pitch	Bld #	OEM Part #	Part #
13-3/8	R	15	3		993143
13-3/8	L	15	3		993153
13-1/4	R	17	3		993144
13-1/4	L	17	3		993154
13-1/8	R	19	3		993145
13-1/8	L	19	3		993155
13	R	21	3		993146
13	L	21	3		993156

Drop-In Hub

Use XHS II® Hub Kit

206

Do NOT use Gearcase Adapter Ring supplied with propeller.

Refer to Pages 55-57 for Details on Hub Kit Components.

MATCH MICHIGAN

Boat Description/ Length	ALUMINUM PROPELLERS					
	Dia.	Rot.	Pitch	Bld #	OEM Part #	Part #
CR, HB	14	R	11	3	763301	012047
19'-22' - AL, SK	14	R	13	3	763302	011001
17'-19' - AL, SK	13-3/4	R	15	3	763466	011002
15'-17' - AL, SK	13-1/4	R	17	3	763463	011003
15'-17' - AL, SK	14	R	17	3	763463	011024
14'-16' - AL	13	R	19	3	763464	011004
14'-16' - AL, SK	14	R	19	3	763464	011025
13'-15' - AL, SK	12-3/4	R	21	3	763465	011005
14'-16' - AL	13-1/4	R	19	3	765184	011419

Rubber Hub Bushing
Part # 65-172

BALLISTIC MICHIGAN

STAINLESS STEEL - B SERIES PROPELLERS					
Dia.	Rot.	Pitch	Bld #	OEM Part #	Part #
13-5/8	R	15	3		933415
13-1/2	R	17	3		933417
13-3/8	R	19	3		933419
13-1/8	R	21	3		933421

Drop-In Hub

Use XHS II® Hub Kit

206

Do NOT use Gearcase Adapter Ring supplied with propeller.

Refer to Pages 55-57 for Details on Hub Kit Components.

SEA DRIVE® 1982 & NEWER • 4-1/4" GEARCASE

Thru Hub Exhaust & 13 Tooth Spline

1.6 L V-4 1982 & Newer	1.8 L V-4..... 1987 & Newer
------------------------------	-----------------------------

For twin installations increase pitch 2".

MATCH MICHIGAN

Boat Description/ Length	ALUMINUM PROPELLERS					
	Dia.	Rot.	Pitch	Bld #	OEM Part #	Part #
CR, HB	14	R	11	3	763301	012047
19'-22' - AL	14	R	13	3	763302	011001
17'-19' - AL	13-3/4	R	15	3	763466	011002
15'-17' - AL	13-1/4	R	17	3	763463	011003
15'-17' - AL, SK	14	R	17	3	763463	011024
14'-16' - AL	13	R	19	3	763464	011004
14'-16' - AL, SK	14	R	19	3	763464	011025
13'-15' - AL, SK	13	R	21	3	763465	011005



011003



011024

Rubber Hub Bushing
Part # 65-172

MODEL 800, KING COBRA®, COBRA®, SEA DRIVE® • 4-3/4" GEARCASE

Thru Hub Exhaust & 15 Tooth Spline

3.0 L1990-1993	5.0 L 1978-1993	7.4 L 1990-1993
3.2 L (Diesel)1992-1993	5.7 L 1978-1993	7.5 L 1987-1990
3.8 L1978-1985	5.8 L (Cobra®) 1989-1993	8.2 L 1992-1993
4.3 L1985-1993	5.8 L (King Cobra®) 1992-1994	Sea Drive® 2.0 L - 4.0 LAll Years

Includes H.O. and EFI Models

Note: For SX Drive, see Volvo Penta section on Page 51.

VORTEX MICHIGAN

3-BL ALUMINUM - A SERIES					4-BL ALUMINUM - A SERIES				
Dia.	Rot.	Pitch	Bld #	Part #	Dia.	Rot.	Pitch	Bld #	Part #
16	R	13	3	992001					
15-1/4	R	15	3	992002					
16	R	16	3	931516					
15	R	17	3	992003	15	R	16	4	992202
14-1/2	R	19	3	992004	14-1/2	R	18	4	992203
14-1/4	R	21	3	992005	14	R	20	4	992204
14	R	23	3	992006					

Drop-In Hub

Use XHS II® Hub Kit
200 / 201

Refer to Pages 55-57 for Details on Hub Kit Components.

APOLLO MICHIGAN

STD. 3-BLADE A SERIES				LG DIA. 3-BLADE A SERIES				4-BLADE A SERIES			
Dia.	Rot.	Pitch	Part #	Dia.	Rot.	Pitch	Part #	Dia.	Rot.	Pitch	Part #
14-3/8	R	15	993042								
14-3/8	L	15	993052								
14-1/4	R	17	993043	15-1/2	R	17	993023	14-5/8	R	16	993203
14-1/4	L	17	993053	15-1/2	L	17	993033	14-5/8	L	16	993213
14-1/8	R	19	993044	15-1/4	R	19	993024	14-3/8	R	18	993204
14-1/8	L	19	993054	15-1/4	L	19	993034	14-3/8	L	18	993214
14	R	21	993045	14-3/4	R	21	993025	14-1/8	R	20	993205
14	L	21	993055	14-3/4	L	21	993035	14-1/8	L	20	993215
13-7/8	R	23	993046	14-5/8	R	23	993026	14	R	22	993206
13-7/8	L	23	993056	14-5/8	L	23	993036	14	L	22	993216

Drop-In Hub

Use XHS II® Hub Kit
200 / 201

Refer to Pages 55-57 for Details on Hub Kit Components.

MATCH MICHIGAN

Boat Description/ Length	ALUMINUM PROPELLERS					
	Dia.	Rot.	Pitch	Bld #	OEM Part #	Part #
Non-Plane Heavy CR	15-1/2	R	13	3	763453	011016
22"-28" (22-32 MPH)	15-1/2	R	15	3	763471	011006
19"-26" (28-39 MPH)						
18"-26" (30-46 MPH)	15	R	17	3	763467	011007
18"-26" (30-46 MPH)						
17"-24" (36-52 MPH)	14-1/2	R	19	3	763468	011008
17"-24" (36-52 MPH)						
16"-22" (40-60 MPH)	14-1/4	R	21	3	763469	011009
16"-22" (40-60 MPH)						
15"-20" (45-66 MPH)						
15"-20" (45-66 MPH)						
Hi Perf. (50-66 MPH)						

Rubber Hub Bushing
Part # 65-254

BALLISTIC MICHIGAN

STAINLESS STEEL - A SERIES PROPELLERS					
Dia.	Rot.	Pitch	Bld #	OEM Part #	Part #
14-7/8	R	15	3		933515
14-3/4	R	17	3		933517
14-3/4	L	17	3		937517
14-1/2	R	19	3		933519
14-1/2	L	19	3		937519
14-3/8	R	21	3		933521
14-3/8	L	21	3		937521
14-1/4	R	23	3		933523
14-1/4	L	23	3		937523
14-1/4	R	25	3		933525

Drop-In Hub

Use XHS II® Hub Kit
200 / 201

Refer to Pages 55-57 for Details on Hub Kit Components.

Note: For engine applications 1976-1990 use XHS II® (Drop-In Hub) Kit #201.
For engine applications 1991 & Newer use XHS II® (Drop-In Hub) Kit #200.

MODEL 14 LARGE GEARCASE 1967-1977

Non-Thru Hub Exhaust & Pin Drive

Suggestion: For twin installation increase pitch 2".
HP Range: 100-245

Boat Description/ Length	MATCH MICHIGAN ALUMINUM PROPELLERS					
	Dia.	Rot.	Pitch	Bld #	OEM Part #	Part #
HP Range: 100-245	14	R	14	3	381185	012091
HP Range: 100-245	14	R	16	3	381186	012092



012091

Rubber Hub Bushing
Part # 65-156

SX COBRA™, VOLVO PENTA SX • 4-3/4" GEARCASE

Thru Hub Exhaust & 19 Tooth Spline

3.0 L.....1994 & Newer	5.7 L.....1994 & Newer	7.4 L.....1997 & Newer
4.3 L.....1994 & Newer	5.8 L.....1994-1997	8.2 L.....1997
5.0 L.....1994 & Newer		

VORTEX MICHIGAN					APOLLO MICHIGAN				
3-BL ALUMINUM - A SERIES					4-BL ALUMINUM - A SERIES				
Dia.	Rot.	Pitch	Bld #	Part #	Dia.	Rot.	Pitch	Bld #	Part #
16	R	13	3	992001					
15-1/4	R	15	3	992002					
16	R	16	3	931516					
15	R	17	3	992003	15	R	16	4	992202
14-1/2	R	19	3	992004	14-1/2	R	18	4	992203
14-1/4	R	21	3	992005	14	R	20	4	992204
14	R	23	3	992006					

Drop-In Hub
Use XHS II® Hub Kit
205
Refer to Pages 55-57 for Details on Hub Kit Components.

Drop-In Hub
Use XHS II® Hub Kit
205
Refer to Pages 55-57 for Details on Hub Kit Components.



Boat Description/ Length	MATCH MICHIGAN						BALLISTIC MICHIGAN					
	ALUMINUM PROPELLERS						STAINLESS STEEL - A SERIES PROPELLERS					
	Dia.	Rot.	Pitch	Bld #	OEM Part #	Part #	Dia.	Rot.	Pitch	Bld #	OEM Part #	Part #
24'-25' (26-36 MPH)	15-1/2	R	15	3	3850299	161001	14-7/8	R	15	3		933515
22'-27' (34-44 MPH)	15	R	17	3	3850300	161002	14-3/4	R	17	3		933517
22'-27' (33-44 MPH)							14-3/4	L	17	3		937517
19'-25' (39-50 MPH)	14-1/2	R	19	3	3850301	161003	14-1/2	R	19	3		933519
19'-25' (39-50 MPH)							14-1/2	L	19	3		937519
17'-22' (39-50 MPH)	14-1/4	R	21	3	3850302	161004	14-3/8	R	21	3		933521
17'-22' (39-50 MPH)							14-3/8	L	21	3		937521
17'-20' (44-57 MPH)	14-1/4	R	23	3	3850303	161005	14-1/4	R	23	3		933523
17'-20' (44-57 MPH)							14-1/4	L	23	3		937523

Rubber Hub Bushing
Part # 65-380

Drop-In Hub
Use XHS II® Hub Kit
205
Refer to Pages 55-57 for Details on Hub Kit Components.

DUOPROP™ TYPE A & B • DP280, 290 DRIVES

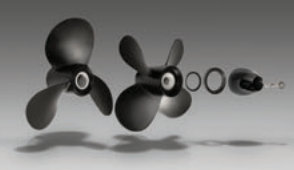
Gasoline and Diesel Engines

Propeller Series	MATCH MICHIGAN				Propeller Series	MATCH MICHIGAN							
	OEM Part #	Kit Part #	ALUMINUM PROPELLERS			OEM	Front Part #	OEM	Rear Part #				
Type A3	854766	085010			Type B3	854824	086008	854832	086009				
Type A4	854767	085013			Type B4	854825	086011	854833	086012				
Type A5	854768	085016			Type B5	854826	086014	854834	086015				
Type A6	854769	085019			Type B6	854827	086017	854835	086018				
Type A7	854770	085022			Type B7	854828	086020	854836	086021				
ALUMINUM PROPELLERS					<p>Note: Type B single propellers available only through Michigan Wheel US warehouse.</p>								
Type B3	854816	086007											
Type B4	854817	086010											
Type B5	854818	086013											
Type B6	854819	086016											
Type B7	854820	086019											

Note: Type A & B propeller kits available only through Michigan Wheel UK warehouse.

YAMAHA STERNDRIVES • 4-3/4" GEARCASE

Thru Hub Exhaust & 15 Tooth Spline

3.0 L (130 HP) EST/PSR1989-1993
 4.3 L (205 HP) EST/PSR/YEMS 1989-1993

5.0 L (205 HP) EST/PSR/YEMS 1989-1993
 5.7 L (260 HP) EST/PSR/YEMS 1989-1993

7.4 L (300 HP*) Hydra Drive EST 1992-1993
 *For engines 300 HP or higher, use "High Horsepower Sleeve" (P/N 991372). See Page 48 for more details.

VORTEX
MICHIGAN

APOLLO
MICHIGAN

3-BL ALUMINUM - A SERIES					4-BL ALUMINUM - A SERIES				
Dia.	Rot.	Pitch	Bld #	Part #	Dia.	Rot.	Pitch	Bld #	Part #
16	R	13	3	992001					
15-1/4	R	15	3	992002					
16	R	16	3	931516					
15	R	17	3	992003	15	R	16	4	992202
14-1/2	R	19	3	992004	14-1/2	R	18	4	992203
14-1/4	R	21	3	992005	14	R	20	4	992204
14	R	23	3	992006					

Drop-In Hub
 Use XHS II® Hub Kit
203

Refer to Pages 55-57 for Details on Hub Kit Components.

STD. 3-BLADE A SERIES				LG DIA. 3-BLADE A SERIES				4-BLADE A SERIES			
Dia.	Rot.	Pitch	Part #	Dia.	Rot.	Pitch	Part #	Dia.	Rot.	Pitch	Part #
14-3/8	R	15	993042								
14-3/8	L	15	993052								
14-1/4	R	17	993043	15-1/2	R	17	993023	14-5/8	R	16	993203
14-1/4	L	17	993053	15-1/2	L	17	993033	14-5/8	L	16	993213
14-1/8	R	19	993044	15-1/4	R	19	993024	14-3/8	R	18	993204
14-1/8	L	19	993054	15-1/4	L	19	993034	14-3/8	L	18	993214
14	R	21	993045	14-3/4	R	21	993025	14-1/8	R	20	993205
14	L	21	993055	14-3/4	L	21	993035	14-1/8	L	20	993215
13-7/8	R	23	993046	14-5/8	R	23	993026	14	R	22	993206
13-7/8	L	23	993056	14-5/8	L	23	993036	14	L	22	993216

Drop-In Hub
 Use XHS II® Hub Kit
203

Refer to Pages 55-57 for Details on Hub Kit Components.

MATCH
MICHIGAN

BALLISTIC
MICHIGAN

Boat Description/Length	ALUMINUM PROPELLERS					
	Dia.	Rot.	Pitch	Bld #	OEM Part #	Part #
21'-26" (18-31 MPH)	15-1/4	R	15	3	6G5-45941-00-98	101025
19'-23" (27-37 MPH)	14-1/2	R	17	3	6G5-45947-01-98	101027
19'-23" (27-37 MPH)						
17'-21" (33-42 MPH)	14	R	19	3	6G5-45945-01-98	101028
17'-21" (33-42 MPH)						
18'-19" (37-46 MPH)	13-3/4	R	21	3	6G5-45943-01-98	101029
18'-19" (37-46 MPH)						
17'-19" (39-48 MPH)						
17'-19" (39-48 MPH)						

Rubber Hub Bushing
 Part # 65-441

STAINLESS STEEL - A SERIES PROPELLERS					
Dia.	Rot.	Pitch	Bld #	OEM Part #	Part #
14-7/8	R	15	3		933515
14-3/4	R	17	3		933517
14-3/4	L	17	3		937517
14-1/2	R	19	3		933519
14-1/2	L	19	3		937519
14-3/8	R	21	3		933521
14-3/8	L	21	3		937521
14-1/4	R	23	3		933523
14-1/4	L	23	3		937523

Drop-In Hub
 Use XHS II® Hub Kit
203

Refer to Pages 55-57 for Details on Hub Kit Components.



MATCH
MICHIGAN



VORTEX
MICHIGAN



APOLLO
MICHIGAN



BALLISTIC
MICHIGAN































































Key to Abbreviations: LL = Light Loads; SB = Sailboat; AL = All Loads; SK = Skiboat; WB = Workboat; HB = Houseboat; CR = Cruisers; HL = Heavy Loads; WD = Weedless

RUBBER HUB ATTACHMENT HARDWARE

Part Number	Description	Page Listing	Engine Applications
990577	Forward Thrust Washer		HONDA 8-20 HP
990578	Forward Thrust Washer		HONDA 25-30 HP
990579	Forward Thrust Washer		HONDA 35-60 HP
990580	Forward Thrust Washer		HONDA 75-130 HP
990581	Forward Thrust Washer		HONDA 115-250 HP
990582	Forward Thrust Washer		NISSAN/TOHATSU 9.9-20 HP
990583	Forward Thrust Washer		NISSAN/TOHATSU 25-30 HP
990584	Forward Thrust Washer		NISSAN/TOHATSU 35-55 HP
990585	Forward Thrust Washer		SUZUKI 9.9-20 HP
990586	Forward Thrust Washer		SUZUKI 20-30 HP
990587	Forward Thrust Washer		SUZUKI 40-65 HP
990588	Forward Thrust Washer		SUZUKI V4 4-STROKE
990589	Forward Thrust Washer		YAMAHA "J" 9.9-15 HP
990590	Forward Thrust Washer		YAMAHA "F" 20-30 HP
990591	Forward Thrust Washer		YAMAHA "G" 40-60 HP
990592	Forward Thrust Washer		YAMAHA "K" 60-100 HP
990593	Forward Thrust Washer		YAMAHA "M" 115-300 HP



RUBBER HUB ATTACHMENT HARDWARE

Part Number	Description		Prop Nut	Flat Washer	Spacer Washer	Cotter Pin
990754	Aft Hardware Kit	HONDA 8-20 HP / YAMAHA "J" 9.9-15 HP			-	
990755	Aft Hardware Kit	HONDA 25-30 HP			-	
990756	Aft Hardware Kit	HONDA 35-60 HP				
990757	Aft Hardware Kit	HONDA 75-130 HP			-	
990758	Aft Hardware Kit	HONDA 115-250 HP				
990759	Aft Hardware Kit	NISSAN/TOHATSU 9.9-20 HP			-	
990760	Aft Hardware Kit	NISSAN/TOHATSU 25-30 HP			-	
990761	Aft Hardware Kit	NISSAN/TOHATSU 35-55 HP				
990762	Aft Hardware Kit	SUZUKI 9.9-15 HP				
990763	Aft Hardware Kit	SUZUKI DF 15A/20A HP			-	
990764	Aft Hardware Kit	SUZUKI 20-30 HP				
990765	Aft Hardware Kit	SUZUKI 40-65 HP				
990766	Aft Hardware Kit	SUZUKI V4 4-STROKE				
990767	Aft Hardware Kit	YAMAHA "F" 20-30 HP				
990768	Aft Hardware Kit	YAMAHA "G" 40-60 HP				
990769	Aft Hardware Kit	YAMAHA "K" 60-100 HP				
990770	Aft Hardware Kit	YAMAHA "M" 115-300 HP				

XHS® / XHS II® PROPELLER ACCESSORIES

 9500-140	 9660-1	 9661-1	 990312	 990332	 990340
 990341	 990344	 990346	 990347	 990348	 990404
 990405	 990406	 990407	 991202	 991203	 991204
 991205	 991206	 991207	 991208	 991209	 991210
 991211	 991212	 991213	 991214	 991215	 991216
 991225	 991226	 991227	 991228	 991229	 991230
 991232	 991233	 991234	 991235	 991236	 991237
 991238	 991239	 991240	 991241	 991242	 991243
 991244	 991247	 991253	 991273	 991301	 991312
 991316	 991372				

XHS® / XHS II® PROPELLER ACCESSORIES

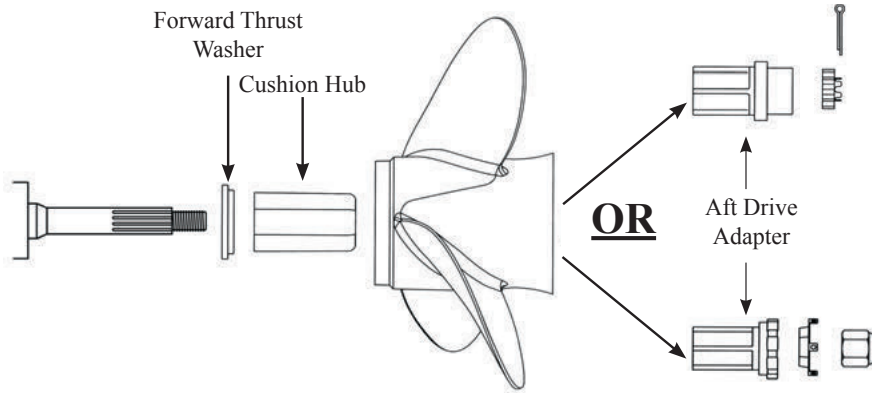

Hub Kit	Description	Part Number / Description
200	Evinrude / Johnson 15 spline, 4-3/4" Gearcase 1991 to Present	991202 Forward Thrust Washer
		991203 Aft Drive Adapter
		991301 Cushion Hub
201	Evinrude / Johnson 15 spline, 4-3/4" Gearcase 1984 - 1990	991204 Forward Thrust Washer
		991203 Aft Drive Adapter
		991301 Cushion Hub
202	Mercury/Force/Honda 15 spline, 4-3/4" Gearcase	991204 Forward Thrust Washer
		990344 Tab Washer
		991205 Aft Drive Adapter
		990346 Propeller Nut
		991301 Cushion Hub
203	Yamaha V6 15 spline, 4-1/4" Gearcase	991213 Forward Thrust Washer
		991206 Aft Drive Adapter
		991301 Cushion Hub
204	Suzuki 15 spline, 4-1/4" Gearcase	991207 Forward Thrust Washer
		991208 Aft Drive Adapter
		991301 Cushion Hub
205	Volvo SX 19 spline, 4-3/4" Gearcase	991202 Forward Thrust Washer
		991209 Aft Drive Adapter
		991301 Cushion Hub
206	Evinrude/Johnson 13 spline, 4-1/4" Gearcase	991210 Forward Thrust Washer
		991211 Aft Drive Adapter
		991301 Cushion Hub
207	Honda 15 spline, 4-3/4" Gearcase	991207 Forward Thrust Washer
		991205 Aft Drive Adapter
		991301 Cushion Hub
208	Yamaha V4 15 spline, 4-1/4" Gearcase	991212 Forward Thrust Washer
		991206 Aft Drive Adapter
		990338 (1) - Washer SS 30 x 17 x 2.5 mm
		991301 Cushion Hub
209	Nissan/Tohatsu 15 spline, 4-1/4" Gearcase	991213 Forward Thrust Washer
		991214 Aft Drive Adapter
		991301 Cushion Hub
210	Suzuki 13 spline, 4-1/4" Gearcase	991215 Forward Thrust Washer
		991211 Aft Drive Adapter
		991301 Cushion Hub
225	Suzuki/Johnson 15 spline, 4-1/4" Gearcase	991253 Forward Thrust Washer
		991205 Aft Drive Adapter
		990337 (1) - Washer SS 32 x 19.2 x 2.5 mm
		991301 Cushion Hub
226	Suzuki/Johnson DF140hp 4 stroke 15 spline 4-1/4" Gearcase	991204 Forward Thrust Washer
		991205 Aft Drive Adapter
		990337 (1) - Washer SS 32 x 19.2 x 2.5 mm
		991301 Cushion Hub
227	Suzuki/Johnson DF70A/DF80A/DF90A 15 spline 4-1/4" Gearcase	991312 Forward Thrust Washer
		991206 Aft Drive Adapter
		990337 (1) - Washer SS 32 x 19.2 x 2.5 mm
		991301 Cushion Hub
228	Evinrude ETEC G2 15 spline G2 Gearcase	991402 G2 Forward Thrust Washer
		991403 G2 Aft Drive Adapter
		991401 G2 Cushion Hub

XHS® / XHS II® PROPELLER ACCESSORIES

Hub Kit	Description	Part Number / Description
111 / 211	Evinrude / Johnson 13 spline, 3-3/8" Gearcase	991247 Forward Thrust Washer
		991232 Aft Drive Adapter
		991225 Urethane Cushion Hub (111 Only)
		991501 Delrin Cushion Hub (211 Only)
112 / 212	Nissan / Tohatsu 13 spline, 3-1/4" Gearcase	991273 Forward Thrust Washer
		991232 Aft Drive Adapter
		991225 Urethane Cushion Hub (112 Only)
		991501 Delrin Cushion Hub (212 Only)
113 / 213	Honda, Nissan/Tohatsu 13 spline, 3-1/4" Gearcase	991234 Forward Thrust Washer
		991227 Aft Drive Adapter
		991225 Urethane Cushion Hub (113 Only)
		991501 Delrin Cushion Hub (213 Only)
114 / 214	Mercury / Mariner / Force 13 spline, 3-1/4" Gearcase	991236 Forward Thrust Washer
		991227 Aft Drive Adapter
		991225 Urethane Cushion Hub (114 Only)
		991501 Delrin Cushion Hub (214 Only)
115 / 215	Evinrude/Johnson, Suzuki 13 spline, 3-1/4" Gearcase	991239 Forward Thrust Washer
		991232 Aft Drive Adapter
		990337 (2) - Washer SS 32 x 19.2 x 2.5 mm
		991225 Urethane Cushion Hub (115 Only)
		991501 Delrin Cushion Hub (215 Only)
116 / 216	Nissan / Tohatsu 13 spline, 3-1/4" Gearcase	991241 Forward Thrust Washer
		991227 Aft Drive Adapter
		990338 (2) - Washer SS 17 x 30 x 2.5 mm
		991225 Urethane Cushion Hub (116 Only)
		991501 Delrin Cushion Hub (216 Only)
117 / 217	Yamaha Outboards 13 spline, 3-1/2" Gearcase	991243 Forward Thrust Washer
		991227 Aft Drive Adapter
		990338 (1) - Washer SS 17 x 30 x 2.5 mm
		991225 Urethane Cushion Hub (117 Only)
		991501 Delrin Cushion Hub (217 Only)
118 / 218	Evinrude / Johnson Outboards 14 spline, 3" Gearcase	991237 Forward Thrust Washer
		991229 Aft Drive Adapter
		991225 Urethane Cushion Hub (118 Only)
		991501 Delrin Cushion Hub (218 Only)
119 / 219	Honda Outboards 10 spline, 3" Gearcase	991233 Forward Thrust Washer
		991226 Aft Drive Adapter
		991225 Urethane Cushion Hub (119 Only)
		991501 Delrin Cushion Hub (219 Only)
120 / 220	Mercury / Mariner / Force 10 spline, 3" Gearcase	991235 Forward Thrust Washer
		991228 Aft Drive Adapter
		991225 Urethane Cushion Hub (120 Only)
		991501 Delrin Cushion Hub (220 Only)
121 / 221	Evinrude/Johnson & Suzuki 10 spline, 3" Gearcase	991238 Forward Thrust Washer
		991230 Aft Drive Adapter
		990338 (1) - Washer SS 17 x 30 x 2.5 mm
		991225 Urethane Cushion Hub (121 Only)
		991501 Delrin Cushion Hub (221 Only)
122 / 222	Nissan / Tohatsu 10 spline 3" Mercury / Mariner / Sea Ray Outboards 10 spline, 3" Gearcase	991240 Forward Thrust Washer
		991226 Aft Drive Adapter
		991225 Urethane Cushion Hub (122 Only)
		991501 Delrin Cushion Hub (222 Only)
123 / 223	Yamaha Outboards 10 spline, 3" Gearcase	991242 Forward Thrust Washer
		991230 Aft Drive Adapter
		990338 (1) - Washer SS 17 x 30 x 2.5 mm
		991225 Urethane Cushion Hub (123 Only)
		991501 Delrin Cushion Hub (223 Only)
	XHS II Standard Cushion Hub	991301 Delrin Cushion Hub
	XHS II High Horsepower Inner Hub (Mercury® Part #850821A2)	991372 Solid Hub
	V4 Gearcase Adapter Ring (3-Blade Propellers Only)	991216 V4 Adapter Ring (3-Blade)
	V4 Gearcase Adapter Ring (4-Blade Propellers Only)	991316 V4 Adapter Ring (4-Blade)
	20-30 Horsepower Gearcase Adapter Ring	991244 Package Includes All Three Sizes
	XHS 9.9 HP - 70 HP Standard Cushion Hub	991225 Urethane Cushion Hub (111-123 Only)
	NEW - XHS 9.9 HP - 70 HP Delrin Cushion Hub	991501 Delrin Cushion Hub (211-223 Only)

PROPELLER CROSS REFERENCE

**MWM ALPHA-NUMERIC CROSS REFERENCE
(PAGE B2-B4)**

**MWM - TURNING POINT® CROSS REFERENCE
(PAGE B4)**

**MWM - SOLAS® CROSS REFERENCE
(PAGE B5)**

**MWM - QUICKSILVER® CROSS REFERENCE
(PAGE B6)**

**XHS® / XHS II® HUB SYSTEM CROSS REFERENCE
(PAGE B6-B7)**

**OEM CROSS REFERENCE
(PAGES B8-B31)**

*Propeller dimensions and performance may vary from OEM propeller.
Product names may belong to Original Equipment Manufacturer.*

Evinrude®, Johnson®, TBX® and Cobra® are registered trademarks of BRP US, Inc. Honda® is a registered trademark of American Honda Motor Co., Inc. Mercury®, Mariner®, Force®, MerCruiser®, and Alpha One™ are registered trademarks of Brunswick Corporation. Nissan® is a registered trademark of Nissan Marine. Parsun® is a registered trademark of Parsun Power Machine (Suzhou) Co., Ltd. Selva® is a registered trademark of Selva Marine. Suzuki® is a registered trademark of American Suzuki Motor Corporation. Tohatsu® is a registered trademark of Tohatsu Corp. Volvo® is a registered trademark of AB Volvo Penta. Yamaha® is a registered trademark of Yamaha Motor Corporation, U.S.A. Solas® is a registered trademark of Solas Science & Engineering Co., Ltd. Turning Point® is a registered trademark of Turning Point Propellers, Inc.

Additional product names may belong to Original Equipment Manufacturers (OEM). All references to OEM, after-market, their trade names or their part numbers are for replacement identification purposes only.

MICHIGAN WHEEL ALPHA-NUMERIC CROSS REFERENCE

Alpha			Alpha			Alpha		
<u>Numeric</u>	<u>Numeric</u>	<u>Status/Year</u>	<u>Numeric</u>	<u>Numeric</u>	<u>Status/Year</u>	<u>Numeric</u>	<u>Numeric</u>	<u>Status/Year</u>
		<u>Discontinued</u>			<u>Discontinued</u>			<u>Discontinued</u>
AJC-63	152001	Dis. 1992	PJ-10	012007	Current	PJ-300	012060	Dis. 2009
AJC-317	016002	Current	PJ-11	012008	Current	PM-4	032012	Dis. 1992
AJC-318	012062	Dis. 1990	PJ-13	012009	Dis. 1994	PM-6	032013	Dis. 1996
AJC-417	012063	Dis. 1996	PJ-15	012010	Dis. 2007	PM-8	032014	Dis. 2003
AJC-418	012064	Dis. 1992	PJ-16	012011	Current	PM-10	032015	Dis. 1994
AJC-469	012065	Dis. 1992	PJ-18	012013	Current	PM-11	032016	Dis. 1994
AM-416	012066	Dis. 1991	PJ-19	012109	Current	PM-16	032017	Dis. 1992
AM-431	012067	Dis. 2007	PJ-21	012014	Dis. 2010	PM-18	032018	Dis. 1992
AMC-128-C	071010	Dis. 1995	PJ-22	012015	Current	PM-19	032019	Dis. 2008
AMC-152-C	071021	Dis. 1995	PJ-24	012016	Current	PM-20	032020	Current
AMC-308	072014	Current	PJ-27	012019	Dis. 1996	PM-21	032021	Current
AMC-310	072131	Current	PJ-28	012020	Dis. 1990	PM-22-C	031047	Dis. 2008
AMC-314	072133	Current	PJ-29	012021	Current	PM-23-C	031048	Current
AMC-316	072134	Dis. 2006	PJ-30	012022	Dis. 2008	PM-24-C	031049	Current
AMC-394	072132	Current	PJ-31	012023	Current	PM-26	032111	Dis. 1993
AMC-422	012068	Dis. 2008	PJ-32	012024	Current	PM-27	032025	Dis. 1996
AMC-444	012070	Dis. 1991	PJ-33	012025	Dis. 2011	PM-28	032027	Dis. 1992
AMC-445	012071	Dis. 1992	PJ-40	012026	Dis. 2006	PM-29	032028	Dis. 1992
AMC-448	012072	Dis. 1996	PJ-41	012027	Dis. 2008	PM-30	032112	Dis. 1993
AMC-490	152002	Dis. 2003	PJ-42	012028	Dis. 2007	PM-39	032030	Dis. 1987
AMC-503	032073	Dis. 1991	PJ-44	012029	Dis. 1993	PM-40	032031	Dis. 1987
AMC-506	032074	Dis. 1991	PJ-45	012030	Current	PM-42	032032	Dis. 1987
AMC-535	152003	Dis. 1996	PJ-47	012031	Dis. 2006	PM-54	032033	Dis. 1991
AMC-577-S	032075	Dis. 1991	PJ-49	012032	Current	PM-55	032034	Dis. 1994
AMC-580-S	032077	Dis. 2006	PJ-50	012033	Dis. 2003	PM-56	032035	Dis. 1993
C-15	152011	Dis. 1993	PJ-51	012034	Dis. 1991	PM-60	032036	Dis. 1987
C-18	152012	Dis. 1991	PJ-53	012035	Dis. 1992	PM-61	032037	Dis. 1987
DQ-320	012074	Dis. 2006	PJ-58	012036	Current	PM-62	032038	Dis. 1987
DQ-328	012075	Dis. 2007	PJ-58-C	011018	Dis. 1990	PM-211-C	031021	Dis. 2008
DQ-430	032078	Dis. 1991	PJ-59	012037	Current	PM-213-C	031022	Current
E-40	152013	Dis. 1990	PJ-59-C	011019	Dis. 1990	PM-215-C	031023	Current
EWC-19	012076	Dis. 2006	PJ-60	012038	Dis. 2007	PM-217-C	031024	Current
EWC-28	012077	Dis. 1987	PJ-60-C	011020	Dis. 1990	PM-219-C	031025	Current
EWC-29	012078	Dis. 1988	PJ-61	012039	Limited Inv.	PM-221-C	031026	Current
G-20	072017	Dis. 2010	PJ-62	012040	Dis. 2008	PM-223-C	031027	Dis. 2006
G-30	152014	Dis. 2005	PJ-73	012041	Dis. 1996	PM-315-C	031041	Current
G-40	152015	Dis. 1996	PJ-74	012042	Dis. 2005	PM-317-C	031042	Current
G-45	152016	Dis. 1992	PJ-75	012043	Dis. 2005	PM-319-C	031043	Current
G-50	152017	Dis. 1996	PJ-76	012044	Dis. 2008	PM-321-C	031044	Current
GC-54	072018	Dis. 1996	PJ-77	012045	Dis. 2008	PM-323-C	031045	Current
GC-55	072019	Dis. 1996	PJ-78	012046	Dis. 1994	PM-513	032039	Dis. 2008
K-40	032079	Dis. 1992	PJ-79	012048	Dis. 2000	PM-515	032040	Current
K-50	032080	Dis. 1992	PJ-80	012049	Dis. 1996	PM-518	032041	Current
K-70	032081	Dis. 1992	PJ-81	012050	Dis. 1996	PM-521	032042	Current
K-74	032082	Dis. 1992	PJ-82	012051	Dis. 1996	PM-524	032043	Current
PC-4	072020	Dis. 1991	PJ-83-C	011105	Current	PM-527	032044	Current
PC-5	072120	Dis. 1992	PJ-87	012047	Current	PM-530	032045	Current
PC-6	072021	Dis. 1996	PJ-88-C	011001	Current	PM-600-C	031015	Current
PC-9	072022	Dis. 1996	PJ-89-C	011002	Current	PM-612-C	031016	Current
PC-10	072023	Dis. 1996	PJ-90-C	011003	Current	PM-613-C	031017	Current
PC-12	072024	Dis. 2006	PJ-91-C	011004	Current	PM-614-C	031018	Current
PC-20	072026	Dis. 2006	PJ-94	012053	Dis. 2006	PM-615-C	031019	Current
PC-24	072121	Dis. 2006	PJ-95	012054	Current	PM-617-C	031020	Current
PC-26	072125	Dis. 1996	PJ-96	012055	Current	PR-4	072027	Dis. 1991
PC-28	072122	Dis. 2006	PJ-97	012056	Current	PR-8	072028	Dis. 1996
PC-32	072121	Dis. 2006	PJ-98	012057	Current	PR-10	072029	Dis. 1991
PC-90	072126	Dis. 1994	PJ-199-C	011015	Dis. 2008	PR-20	012079	Dis. 1993
PC-112	072123	Current	PJ-200	012059	Dis. 1996	PR-22	012080	Dis. 1993
PJ-3	012001	Dis. 2007	PJ-200-C	011016	Current	PR-24	012081	Dis. 1992
PJ-5	012002	Dis. 1996	PJ-201-C	011006	Current	PR-26	012082	Dis. 1992
PJ-6	012003	Dis. 1996	PJ-202-C	011007	Current	PR-31	032083	Dis. 1996
PJ-7	012004	Dis. 2006	PJ-203-C	011008	Current	PR-33	032084	Dis. 2007
PJ-8	012005	Current	PJ-204-C	011009	Current	PR-35	032085	Dis. 2007
PJ-9	012006	Dis. 2008	PJ-205-C	011010	Dis. 2010	PR-37	032086	Dis. 2006

MICHIGAN WHEEL ALPHA-NUMERIC CROSS REFERENCE

Alpha	Status/Year	Alpha	Status/Year	Alpha	Status/Year			
<u>Numeric</u>	<u>Numeric</u>	<u>Numeric</u>	<u>Numeric</u>	<u>Numeric</u>	<u>Numeric</u>			
	<u>Discontinued</u>		<u>Discontinued</u>		<u>Discontinued</u>			
PR-39	032087	Dis. 2007	PR-409	072063	Dis. 1987	SMC-339	082026	Dis. 1997
PR-43	032088	Dis. 1994	PR-412	072064	Dis. 1987	SMC-340	082059	Dis. 1997
PR-74	072030	Dis. 1991	PR-413	072065	Dis. 1987	SMC-341	082060	Dis. 1997
PR-76	072031	Dis. 1992	PR-416	072066	Dis. 1987	SMC-342	082027	Dis. 1997
PR-78	072032	Dis. 2007	PR-417	072067	Dis. 1987	SMC-343	082028	Dis. 1997
PR-80	072033	Dis. 2006	PR-420	012095	Dis. 1993	SMC-344	082029	Dis. 1997
PR-82	072034	Dis. 2005	PR-421	016006	Dis. 1992	SMC-345	082030	Dis. 1997
PR-90	012083	Dis. 1992	PR-422	012096	Dis. 1992	SMC-346	082031	Dis. 1997
PR-92	012084	Dis. 1993	PR-423	016007	Dis. 1991	SMC-350	082053	Dis. 1996
PR-94	012085	Dis. 1992	PR-424	012097	Dis. 1994	SMC-351	082036	Dis. 1995
PR-95	016004	Dis. 1991	PR-425	016008	Dis. 1992	SMC-374-C	031035	Dis. 2003
PR-96	012086	Dis. 1993	PR-426	012098	Dis. 1992	SMC-376-C	031036	Dis. 2003
PR-97	016005	Dis. 1992	PR-427	016009	Dis. 1987	SMC-378-C	031037	Dis. 2005
PR-105	012087	Dis. 1993	PR-432	072114	Dis. 1993	SMC-380-C	031038	Dis. 2005
PR-109	012088	Dis. 1992	PR-434	072068	Dis. 1996	SMC-382-C	031039	Dis. 2005
PR-115	012089	Dis. 2008	PR-552	072069	Dis. 1992	SMC-384-C	031040	Dis. 1997
PR-118	012090	Dis. 2007	PR-553	072070	Dis. 1996	SMC-434	036004	Dis. 1992
PR-120	012091	Current	PR-554	072071	Dis. 1992	SMC-435	036005	Dis. 1992
PR-122	012092	Current	PR-555	072072	Dis. 1990	SMC-436	036006	Dis. 1992
PR-124	012093	Dis. 2007	PR-884	072073	Dis. 1991	SMC-437	036007	Dis. 1992
PR-126	012094	Dis. 2007	PS-1	062001	Dis. 1992	SMC-438	036008	Dis. 1991
PR-130	072035	Dis. 1991	PS-2	062002	Dis. 1992	SMC-439	036009	Dis. 1992
PR-132	072036	Dis. 1991	PS-5	062003	Dis. 1992	SMC-440	036010	Dis. 1987
PR-134	072037	Dis. 1991	PS-6	062004	Dis. 1993	SMC-504-C	031034	Dis. 2003
PR-136	072038	Dis. 1991	PS-7	062005	Dis. 1991	SMC-530	072078	Dis. 1987
PR-138	072039	Dis. 1991	PS-25	152020	Dis. 1992	SMC-556	072077	Dis. 1987
PR-151	032089	Dis. 2004	PS-40	152021	Dis. 1993	SMC-566	072076	Dis. 1987
PR-153	032090	Dis. 2004	PS-71	152023	Dis. 1992	SMC-570	072079	Dis. 1987
PR-155	032091	Dis. 2004	PS-72	152024	Dis. 1991	SMC-582	072086	Dis. 1987
PR-155-C	031001	Dis. 2003	PS-73	152025	Dis. 1992	SMC-592	072083	Dis. 1987
PR-157	032092	Dis. 2004	PS-513	062006	Dis. 1991	SMC-604	072084	Dis. 1987
PR-157-C	031002	Dis. 2003	PS-515	062007	Dis. 1991	SMC-606	072085	Dis. 1987
PR-159	032093	Dis. 2004	PS-518	062008	Dis. 1991	SMC-635	152035	Dis. 1991
PR-159-C	031003	Dis. 2003	PS-521	062009	Dis. 1991	SMC-637	152036	Dis. 1992
PR-161	032094	Dis. 2004	PS-524	062010	Dis. 1991	SMC-713	152037	Dis. 1992
PR-161-C	031004	Dis. 2003	PS-527	062011	Dis. 1991	SMC-715	152038	Dis. 1992
PR-163	032095	Dis. 2004	PY-315-C	101001	Dis. 1997	SMC-720	072088	Dis. 1993
PR-163-C	031005	Dis. 1994	PY-317-C	101003	Dis. 1997	SMC-721	072090	Dis. 1992
PR-248	072047	Dis. 1987	PY-319-C	101005	Dis. 1997	SMC-733	072092	Dis. 1990
PR-250	072048	Dis. 1987	PY-321-C	101007	Dis. 1997	SMC-734	072093	Dis. 1991
PR-256	072049	Dis. 1987	PY-323-C	101009	Dis. 1994	SMC-735	072095	Dis. 1990
PR-258	072050	Dis. 1987	PY-415-C	101010	Dis. 1997	SMC-736	072089	Dis. 1992
PR-260	072051	Dis. 1987	PY-417-C	101011	Dis. 1997	SMC-737	072091	Dis. 1992
PR-264	072053	Dis. 1987	PY-419-C	101012	Dis. 1997	SMC-744	072097	Dis. 1992
PR-276	072054	Dis. 2007	PY-421-C	101013	Dis. 1997	SMC-750	072099	Dis. 1992
PR-278	072055	Current	PY-423-C	101014	Dis. 1994	SMC-751	072098	Dis. 1996
PR-333	032096	Dis. 1993	SA-10	152030	Dis. 1994	SMC-760	072096	Dis. 1996
PR-335	032097	Dis. 1996	SAC-371	152034	Dis. 1992	SMC-765	072101	Dis. 1994
PR-335-C	031007	Dis. 1990	SMC-7	152029	Dis. 1987	SMC-768	072103	Dis. 1991
PR-337	032098	Dis. 1995	SMC-12	012100	Dis. 1996	SMC-769	072104	Dis. 1996
PR-337-C	142002	Dis. 2009	SMC-18	012101	Dis. 2007	SMC-773	072105	Dis. 1990
PR-339	032099	Dis. 2007	SMC-34	016011	Dis. 1992	SMC-774	072106	Dis. 1996
PR-339-C	031009	Dis. 1990	SMC-38	016013	Dis. 1992	SMC-800	032104	Dis. 1987
PR-343	032100	Dis. 1996	SMC-39	012102	Current	SMC-801	032103	Dis. 1987
PR-343-C	031010	Dis. 1990	SMC-46	072074	Dis. 1994	SMC-802	032106	Dis. 1996
PR-345	032101	Dis. 1993	SMC-47	012063	Dis. 1996	SMC-803	032105	Dis. 1992
PR-345-C	031011	Dis. 1990	SMC-292	082022	Dis. 2007	SMC-804	032108	Dis. 1992
PR-396	072056	Dis. 1987	SMC-293	082021	Dis. 2011	SMC-805	032107	Dis. 1992
PR-397	072057	Dis. 1987	SMC-294	082024	Dis. 1996	SMC-806	032110	Dis. 1990
PR-400	072058	Dis. 1987	SMC-295	082023	Dis. 2007	SMC-807	032109	Dis. 1995
PR-401	072059	Dis. 1987	SMC-304	012103	Dis. 1992	SMC-808	072112	Dis. 1992
PR-404	072060	Dis. 1987	SMC-308	012104	Dis. 1992	SMC-809	072113	Dis. 1990
PR-405	072061	Dis. 1987	SMC-312	012105	Dis. 1992	SMC-862	012106	Dis. 1992
PR-408	072062	Dis. 1987	SMC-335	082025	Dis. 1997	SMC-864	012107	Dis. 1992

MICHIGAN WHEEL ALPHA-NUMERIC CROSS REFERENCE

Alpha		Status/Year	Alpha		Status/Year	Alpha		Status/Year
Numeric	Numeric	Discontinued	Numeric	Numeric	Discontinued	Numeric	Numeric	Discontinued
SMC-885	082035	Dis. 1992	SSM-272-C	033020	Dis. 1994	SSO-817-C	013015	Dis. 1995
SMC-898	082037	Dis. 1994	SSM-292-C	033021	Dis. 1995	SSO-819-C	013016	Dis. 1994
SMC-900	082041	Dis. 1992	SSM-312-C	033022	Dis. 1996	SSO-821-C	013017	Dis. 1996
SMC-906	082043	Dis. 1996	SSM-350-C	033007	Dis. 2005	SSO-922-C	013007	Dis. 1990
SMC-922	082047	Dis. 1992	SSM-354-C	033008	Dis. 2005	SSO-924-C	013008	Dis. 1990
SMC-925	082049	Dis. 1995	SSM-358-C	033009	Dis. 2005	SSO-926-C	013009	Dis. 1990
SMC-929	082051	Dis. 1991	SSM-615-II-C	033016	Dis. 2005	SSV-171-C	083001	Dis. 2006
SMC-940	082052	Dis. 1992	SSM-617-II-C	033017	Dis. 2006	SSV-172-C	083002	Dis. 2006
SMC-944	082054	Dis. 1992	SSM-619-II-C	033018	Dis. 2006	SSV-192-C	083004	Dis. 2006
SPC-180	072107	Current	SSM-621-II-C	033019	Dis. 2006	SSV-211-C	083005	Dis. 2006
SPC-182	072108	Current	SSM-822-C	033013	Dis. 1990	SSV-212-C	083006	Dis. 2006
SPC-184	072109	Dis. 2006	SSM-824-C	033014	Dis. 1990	SSY-615-II-C	103025	Dis. 2006
SSC-315-II-C	073002	Dis. 2005	SSM-826-C	033015	Dis. 1990	SSY-617-II-C	103026	Dis. 2006
SSC-317-II-C	073003	Dis. 2005	SSO-315-C	013010	Dis. 2007	SSY-619-II-C	103027	Dis. 2006
SSC-319-II-C	073004	Dis. 2005	SSO-515-II-C	013011	Dis. 1990	SSY-621-II-C	103028	Dis. 1997
SSC-321-II-C	073005	Dis. 1996	SSO-517-C	013012	Dis. 1990	SSY-715-C	103016	Dis. 1991
SSC-614-C	073006	Dis. 1996	SSO-519-C	013013	Dis. 1990	SSY-717-C	103018	Dis. 2006
SSM-212-C	033001	Dis. 2006	SSO-521-C	013014	Dis. 1990	SSY-719-C	103020	Dis. 2006
SSM-245-C	033002	Dis. 2006	SSO-645-C	013001	Dis. 1990	SSY-721-C	103022	Dis. 2007
SSM-247-C	033003	Dis. 2006	SSO-647-C	013002	Dis. 1990	SSY-722-C	103050	Dis. 2003
SSM-249-C	033004	Dis. 2006	SSO-649-C	013003	Dis. 1990	SSY-723-C	103024	Dis. 2003
SSM-251-C	033005	Dis. 2005	SSO-651-C	013004	Dis. 1990	SSY-724-C	103052	Dis. 2003
SSM-253-C	033006	Dis. 2006	SSO-653-C	013005	Dis. 1990	SSY-726-C	103054	Dis. 2003

CAN'T FIND YOUR ALPHA-NUMERIC PART NUMBER LISTED ABOVE?
FOR ADDITIONAL ASSISTANCE CONTACT MICHIGAN WHEEL MARINE CUSTOMER SERVICE AT 1-800-369-4335

TURNING POINT® - MICHIGAN WHEEL CROSS REFERENCE

Turning Point® Part #	Alternate TP Part #	MW Part #	Turning Point® Part #	Alternate TP Part #	MW Part #	Turning Point® Part #	Alternate TP Part #	MWM Part #
E-1415		993042	H1-1319		992115	LE2-1413	2143 1311	992112
E-1417		993043	H1-1321		992116	PA-1417	3150 1710	993043
E-1419		993044	H1-1413		992112	PA-1417-L	3150 1720	993053
E-1421		993045	H2-1117	2131 1710	992303	PA-1419	3150 1910	993044
E-1423		993046	H2-1213	2131 1310	992311	PA-1419-L	3150 1920	993054
E1-1012	3130 1211	993405	H2-1215	2131 1510	992312	PA-1421	3150 2110	993045
E1-1013	3130 1311	993406	H2-1315		992113	PA-1421-L	3150 2120	993055
E1-1014	3130 1411	993407	H2-1317		992114	PA-1423	3150 2310	993046
E1-1015	3130 1511	993408	H2-1319		992115	PA-1423-L	3150 2320	993056
E1-1315		993143	H2-1321		992116	PA1-1315	3140 1510	993143
E1-1317		993144	H2-1413		992112	PA1-1317	3140 1710	993144
E1-1319		993145	LE-1417	2150 1711	992003	PA1-1319	3140 1910	993145
E1-1321		993146	LE-1419	2150 1911	992004	PA1-1321	3140 2110	993146
E2-1315		993143	LE-1421	2150 2111	992005	PA2-1315	3141 1510	993143
E2-1317		993144	LE-1423	2150 2311	992006	PA2-1317	3141 1710	993144
E2-1319		993145	LE-1515	2150 1511	992002	PA2-1319	3141 1910	993145
E2-1321		993146	LE1-1315	2143 1511	992113	PA2-1321	3141 2110	993146
H-1417		992003	LE1-1317	2143 1711	992114	R1-1011	2120 1110	992503
H-1419		992004	LE1-1317-4	2143 1730	941417	R1-1013	2120 1310	992505
H-1421		992005	LE1-1319-4	2143 1930	941419	R2-1011	2121 1110	992503
H-1423		992006	LE1-1319	2143 1911	992115	R2-1013	2121 1310	992505
H-1515		992002	LE1-1321	2143 2111	992116	R3-1011	2122 1110	992503
H1-1011	2130 1110	992404	LE1-1413	2143 1311	992112	R3-1013	2122 1310	992505
H1-1012	2130 1210	992405	LE2-1315	2143 1511	992113	VO-1517	3152 1710	993023
H1-1013	2130 1310	992406	LE2-1317	2143 1711	992114	VO-1517-L	3152 1720	993033
H1-1014	2130 1410	992407	LE2-1317-4	2143 1730	941417	VO-1519	3152 1910	993024
H1-1015	2130 1510	992408	LE2-1319-4	2143 1930	941419	VO-1519-L	3152 1920	993034
H1-1210	2130 1010	992602	LE2-1319	2143 1911	992115	VO-1521	3152 2110	993025
H1-1315		992113	LE2-1321	2143 2111	992116	VO-1521-L	3152 2120	993035
H1-1317		992114						

SOLAS® - MICHIGAN WHEEL CROSS REFERENCE

Solas® Part #	MWM Part #	Solas® Part #	MWM Part #	Solas® Part #	MWM Part #	Solas® Part #	MWM Part #
1111-093-07	032056	2441-133-17	933417	3553-140-25	963525	9431-130-21	993146
1111-093-08	032053	2441-133-19	933419	4111-093-09	062103	9431-133-17	993144
1111-093-09	032052	2441-138-15	933415	4111-093-10	062104	9431-135-15	993143
1111-093-10	032050	2511-142-23	011010	4111-093-11	062105	9431-138-13	992112
1211-100-14	031047	2511-143-21	011009	4211-100-14	062209	9432-130-19	993155
1211-101-13	031048	2511-145-19	011008	4211-100-15	062210	9432-133-17	993154
1211-105-11	031049	2511-148-17	011007	4211-101-13	062207	9432-135-15	993153
1231-100-15	933015	2511-150-15	011006	4211-103-12	062206	9511-143-21	992005
1231-101-13	933013	2511-155-13	011016	4211-105-11	062205	9511-145-19	992004
1311-110-15	031019	2551-140-24	953524	4211-110-09	062208	9511-148-17	992003
1311-111-13	031047	2551-143-22	345051	4231-100-15	933015	9511-150-15	992002
1311-111-14	031018	2551-145-21	933521	4231-101-13	933013	9513-143-19	992204
1311-114-12	031017	2551-148-16	933515	4311-114-15	062215	9513-148-17	992203
1311-116-11	031016	2551-148-17	933517	4311-114-16	062216	9513-148-15	992202
1311-120-10	032142	2551-148-19	933519	4311-116-12	062212	9531-140-19	993044
1311-121-09	031015	2552-145-21	937521	4311-116-13	062213	9531-140-21	993045
1411-130-19	031043	2552-148-17	937517	4311-116-14	062214	9531-140-23	993046
1411-130-21	031044	2552-148-19	937519	4311-118-11	062211	9531-143-17	993043
1411-133-17	031042	2553-140-23	963523	4311-120-10	032045	9531-145-15	993042
1411-135-15	031041	2553-140-25	963525	4331-110-15	933215	9532-140-19	993054
1411-138-13	031202	3011-085-08	102002	4331-111-13	993213	9532-140-21	993055
1411-140-11	031254	3111-093-08	102003	4411-130-19	061103	9532-140-23	993056
1413-133-13	941413	3111-093-09	102004	4411-130-21	061104	9532-143-17	993053
1413-130-15	941415	3111-093-10	102005	4411-133-17	061102	9532-145-15	993052
1413-128-17	941417	3111-093-12	102107	4411-135-15	061101	9553-140-21	993205
1413-125-19	941419	3211-099-09	022001	4411-138-13	061105	9553-140-23	993206
1431-130-19	933419	3211-099-10	022002	4411-140-11	061107	9553-141-19	993204
1431-130-21	933421	3211-099-12	022003	4413-133-13	941413	9553-143-17	993203
1431-133-17	933417	3211-099-13	022005	4413-130-15	941415	9554-140-21	993215
1431-135-15	933415	3231-100-15	933015	4413-128-17	941417	9554-140-23	993216
1451-139-17	933417	3231-101-13	933013	4413-125-19	941419	9554-141-19	993214
1451-139-19	933419	3311-110-15	032040	5011-078-08	032055	9554-143-17	993213
1451-139-21	933421	3311-111-13	032042	5011-085-07	142102	9571-148-23	993026
1451-139-23	334135	3311-111-14	032041	5011-085-08	142103	9571-150-21	993025
1451-139-25	953424	3311-114-12	032043	5111-093-08	142203	9571-153-19	993024
1511-148-16	933515	3311-116-11	032044	5111-093-09	142204	9571-155-17	993023
1551-140-24	953524	3311-118-11	032044	5111-093-10	142205	9572-148-23	993036
1551-143-22	953522	3311-120-10	032045	5111-093-11	142206	9572-150-21	993035
1551-145-21	933521	3311-121-09	032045	5111-093-12	142207	9572-153-19	993034
1551-148-16	933515	3331-110-15	933215	5211-099-09 (Honda®)	111103	9572-155-17	993033
1551-148-17	933517	3331-111-13	993213	5211-099-09 (Tohatsu®)	141304	RBX-100	XHS II 200
1551-148-19	933519	3411-130-19 (Yamaha®)	101034	5211-099-10 (Honda®)	111107	RBX-101	XHS II 201
1552-143-22	937523	3411-130-19 (Tohatsu®)	142219	5211-099-10 (Tohatsu®)	141307	RBX-102	XHS II 202
1552-145-21	937521	3411-130-21 (Yamaha®)	101135	5211-099-11 (Honda®)	111105	RBX-103	XHS II 203
1552-148-17	937517	3411-130-21 (Tohatsu®)	142221	5211-099-11 (Tohatsu®)	141305	RBX-104	XHS II 204
1552-148-19	937519	3411-133-17 (Yamaha®)	101033	5211-099-12 (Honda®)	111106	RBX-105	XHS II 205
1553-140-23	963523	3411-133-17 (Tohatsu®)	142217	5211-099-12 (Tohatsu®)	141308	RBX-106	XHS II 206
1553-140-25	963525	3411-135-15 (Yamaha®)	101032	5211-099-13 (Honda®)	111108	RBX-107	XHS II 207
2011-083-08P (Yamaha®)	102002	3411-135-15 (Tohatsu®)	142215	5211-099-13 (Tohatsu®)	141306	RBX-108	XHS II 208
2011-083-08P (BRP®)	012008	3411-138-13 (Yamaha®)	101031	5311-121-09	142407	RBX-109	XHS II 209
2011-085-09	012007	3411-138-13 (Tohatsu®)	142213	5311-118-10	142408	RBX-110	XHS II 210
2011-085-09P	012032	3411-139-17	061024	5311-116-11	142405	RBX-111	XHS II 211
2111-090-10P	012015	3411-139-19	061028	5311-114-12	142409	RBX-112	XHS II 212
2111-093-11P	012016	3411-139-21	061032	5311-111-13	142406	RBX-113	XHS II 213
2111-093-07	012112	3411-140-11	101036	5311-111-14	142410	RBX-114	XHS II 214
2111-093-10	012111	3413-133-13	941413	8611-142-23	161005	RBX-115	XHS II 215
2111-093-11P	012013	3413-130-15	941415	8611-143-21	161004	RBX-116	XHS II 216
2211-100-15	012057	3413-128-17	941417	8611-145-19	161003	RBX-117	XHS II 217
2211-101-13	012056	3413-125-19	941419	8611-148-17	161002	RBX-125	XHS II 225
2211-105-11	012055	3431-130-21	933421	8611-150-15	161001	RBX-126	XHS II 226
2211-110-09	012054	3431-133-17	933317	8651-148-16	933515	RBX-150	XHS II 227
2231-100-15	933015	3431-135-15	933315	8651-148-17	933517	RBX-151	XHS II 228
2231-101-13	933013	3441-133-17	933417	8651-148-19	933519		
2311-120-17	011028	3441-133-19	933419	8651-148-21	933521		
2311-123-15	011027	3441-138-15	933415	8651-148-23	933523		
2311-125-13	012037	3511-145-19	101028	8652-148-17	937517		
2311-130-11	012036	3511-148-17	101027	8652-148-19	937519		
2411-130-19	011004	3551-140-24	933525	8652-148-23	937523		
2411-130-21	011105	3551-143-22	933523	9411-132-19	992115		
2411-133-17	011003	3551-145-21	933521	9411-132-21	992116		
2411-135-15	011002	3551-148-16	933515	9411-133-17	992114		
2411-138-13	011001	3551-148-17	937517	9411-135-15	992113		
2411-140-11	012047	3551-148-19	933519	9413-133-13	941413		
2413-133-13	941413	3552-145-21	937521	9413-130-15	941415		
2413-130-15	941415	3552-148-17	937517	9413-128-17	941417		
2413-128-17	941417	3552-148-19	937519	9413-125-19	941419		
2413-125-19	941419	3553-140-23	963523	9431-130-19	993145		

QUICKSILVER® - MICHIGAN WHEEL CROSS REFERENCE

Quicksilver® Part #	MWM Part #	Quicksilver® Part #	MWM Part #	Quicksilver® Part #	MWM Part #
48-33480A1	032135	QA2080X	992407	QA3122R	012057
48-47670A10	032020	QA2084X	992408	QA3136R	012016
48-47922A10	032021	QA2102R	031049	QA3150R	012011
48-8M8027498	941411	QA2106R	031048	QA3152R	012013
48-8M8027500	941413	QA2124R	032056	QA3168R	012111
48-8M8027502	941415	QA2126R	032053	QA3184R	032055
48-8M8027504	941417	QA2128R	032052	QA3190R	012032
48-8M8027506	941419	QA2130R	032050	QA3808R	022002
48-8M8027511	941212	QA2158R	142203	QA3812R	022003
48-8M8027512	941213	QA2171R	142203	QA3828X	992111
48-8M8027513	941214	QA2173R	142204	QA3832X	992112
48-8M8027514	941215	QA2175R	142205	QA3902R	102003
48-819335A40	072132	QA2182X	992202	QA3906R	102004
48-819336A40	072131	QA2184X	992203	QA3914R	102005
48-819337A45	072014	QA2186X	992204	QS5004X	993023
48-86962A4	032136	QA2196R	141305	QS5005X	993033
48-FP669-3	071035	QA2202X	992116	QS5006X	993024
48-FP685-3	071036	QA2204X	992115	QS5007X	993034
48-FP685-3	072128	QA2206X	992114	QS5008X	993025
48-FP686-4	992115	QA2208X	992113	QS5009X	993035
48-FP692-3	072127	QA2226R (Mercury®)	032044	QS5010X	993026
48-FP743-2	992112	QA2226R (Suzuki®)	062211	QS5011X	993036
QA1912X	992003	QA2230R	032042	QS5050X	993042
QA1916X	992004	QA2232R (Mercury®)	032041	QS5052X	993043
QA1918X	992005	QA2232R (Suzuki®)	062214	QS5053X	993053
QA1920X	992006	QA2234R (Mercury®)	032040	QS5054X	993044
QA2002X	992001	QA2234R (Suzuki®)	062215	QS5055X	993054
QA2008X	992002	QA2238R (Suzuki®)	062217	QS5056X	993045
QA2028X	992111	QA2242R	992501	QS5057X	993055
QA2032X	992112	QA2248R	992503	QS5058X	993046
QA2034X	992113	QA2252R	992504	QS5059X	993056
QA2036X	992114	QA2254R	992505	QS5164X	993405
QA2038X	992115	QA2828X	992111	QS5166X	993406
QA2040X	992116	QA2832X	992112	QS5168X	993407
QA2062X	992601	QA3080R	011034	QS5170X	993408
QA2064X	992602	QA3080R	012036	QA3084R	011027
QA2070X	992404	QA3082R	011035	QA3088R	011028
QA2074X	992405	QA3082R	012037	QA3114R	012055
QA2078X	992406	QA3118R	012056		

MICHIGAN WHEEL XHS® / XHS II™ CROSS REFERENCE

XHS® / XHS II® HUB SYSTEM CROSS REFERENCE TO EVINRUDE® TBX® HUB SYSTEM

Applications	Spline	Year	Evinrude® TBX®	XHS II® Hub Kit
Evinrude®/Johnson® V4 45-75 HP (4-1/4" Gearcase)	13	1968 & Newer	765195	See Note 5
Evinrude®/Johnson® V4 85-140 HP	13	1969 & Newer	765195	See Note 5
Evinrude®/Johnson® 90, 115 HP (4-Stroke)	15	2003 & Newer	765199	225
Evinrude®/Johnson® 90-140 HP (Large Gearcase)	15	1991 & Newer	765190	226
Force® 75-150 HP	15	1995 & Newer	765192	202
Honda® 75-150 HP	15	1995-1998	765192	202
Honda® 75-90 HP	15	1999 & Newer	765196	207
Honda® 115-130 HP	15	1999 & Newer	765196	207
Honda® BF 135 HP, 150 HP, 200 HP & 225 HP	15	2003 & Newer	765192	202
Mercury®/Mariner®/MerCruiser® 60 HP Bigfoot	15		765192	202
Mercury®/Mariner®/MerCruiser® 70-140 HP (Except 135 HP), XR-4, XR-6	15	1961 & Newer	765192	202
Mercury®/Mariner®/MerCruiser® 135 HP	15	1987 & Newer	765192	202
Mercury®/Mariner®/MerCruiser® 150-300 HP	15	1978 & Newer	765192	202
Nissan®/Tohatsu® 90-140 HP	15	1987 & Newer	765197	209
Suzuki® DF90, DF115 HP (4-Stroke)	15	2001 & Newer	765199	225
Suzuki® DF140 (4-Stroke)	15	2001 & Newer	765200	226
Yamaha® 80-140 HP	15	1978-1983	765192	202
Yamaha® 150-175 HP	15	1978-1983	765192	202
Yamaha® 115 HP, FS115 (4-Stroke), 130 HP	15	1984 & Newer	765193	203
Yamaha® 150-300 HP	15	1984 & Newer	765193	203
Yamaha® Sterndrives	15	1989-1993	765193	203
OMC Cobra® SX Sterndrives	19	1994 & Newer	765194	205
Volvo Penta® SX Sterndrives	19	1994 & Newer	765194	205

MICHIGAN WHEEL XHS® / XHS II™ CROSS REFERENCE

XHS® / XHS II® HUB SYSTEM CROSS REFERENCE TO MERCURY® FLO-TORQ® HUB SYSTEM

Mercury® Flo-Torq®	XHS II® Hub Kit	Mercury® Flo-Torq®	XHS II® Hub Kit
835257A1.....	.202	835265Q02.....	200
835265A1.....	.200	835266Q1.....	206
835266A1.....	.206	835267Q1.....	201
835267A1.....	.201	835270Q1.....	205
835270A1.....	.205	835271Q2.....	203
835271A1.....	.203	835272Q1.....	208
835272A1.....	.208	835277Q1.....	202
835277A1.....	.202	835279Q2.....	207
835278A1.....	.207	835278Q1.....	207
835279A1.....	.207	835281Q1.....	204
835281A1.....	.204	835282Q1.....	210
835282A1.....	.210	835283Q1.....	225
835284A1.....	.209	835283Q2.....	226
835257K1.....	.202	835283Q03.....	227
835257Q1.....	.202	835284Q1.....	209

XHS® / XHS II® HUB SYSTEM CROSS REFERENCE TO TURNING POINT® MASTERGUARD®/MASTERTORQUE® HUB SYSTEM

(MASTERGUARD® / MASTERTORQUE® HUB SYSTEMS NOT COMPATIBLE WITH MICHIGAN WHEEL XHS® PROPELLERS)

Manufacturer/ Horsepower Range	Turning Point® MasterGuard®	XHS® Hub Kit	Manufacturer/ Horsepower Range	Turning Point® MasterTorque®	XHS II® Hub Kit
Evinrude®/Johnson® 20-35 HP • 3-1/4" Gearcase (Thru Hub & 14 Tooth)	22 1120 0200	118	Evinrude®/Johnson® 90, 115, & 140 HP (4-Stroke) • 4-1/4" Gearcase (15 Tooth)	501 / 509 1150 0100/0900	See Note 4
Force® 25 HP • 3-1/4" Gearcase (Thru Hub & 10 Tooth)	21 1120 0100	120	Force® 75-150 HP • Using Mercury® 4-1/4" Gearcase (15 Tooth)	501 1150 0100	202
Mercury®/Mariner® 9.9-25 HP (Thru Hub & 10 Tooth)	21 1120 0100	120	Honda® 75-130 HP • 4-1/4" Gearcase (Thru Hub & 15 Tooth)	501 / 507 1150 0100/0700	See Note 3
Honda® 25-30 HP • 3-1/4" Gearcase (Thru Hub & 10 Tooth)	28 1120 0800	119	Mercury®/Mariner® 40-140 HP • 4-1/4" Gearcase (Thru Hub & 15 Tooth)	501 1150 0100	202
Mercury®/Mariner® 25-30 HP • Mercury 3-1/4" Gearcase (Thru Hub & 10 Tooth)	28 1120 0800	122	Nissan®/Tohatsu® 60-140 HP • 4-1/4" Gearcase (Thru Hub & 15 Tooth)	505 1150 0500	209
Nissan®/Tohatsu® 25-30 HP • 3-1/4" Gearcase (Thru Hub & 10 Tooth)	28 1120 0800	122	Suzuki® 70-140 HP (4-Stroke) • 4-1/4" Gearcase (15 Tooth)	501 / 509 1150 0100/0900	See Note 4
Yamaha® 20-30 HP • 3-1/4" Gearcase (Thru Hub & 10 Tooth)	25 1120 0500	123	Yamaha® 50-130 HP • 4-1/4" Gearcase (Thru Hub & 15 Tooth)	500 / 505 1150 0000/0500	See Note 4
Evinrude®/Johnson® 25-30 HP (4-Stroke) • 3-1/2" Gearcase (Thru Hub & 10 Tooth)	26 1120 0600	121	Evinrude®/Johnson® 40-75 HP • Large 4-1/4" Gearcase (Thru Hub & 13 Tooth)	503 1150 0300	See Note 5
Suzuki® 25-30 HP • 3-1/4" Gearcase (Thru Hub & 10 Tooth)	26 1120 0600	121	OMC® - Outboard Marine Model 400, Cobra • 4-1/4" Gearcase (Thru Hub & 13 Tooth)	503 1150 0300	206
Evinrude®/Johnson® 40-50 HP (4-Stroke) • 3-1/4" Gearcase (Thru Hub & 13 Tooth)	11 1130 0100	115	Suzuki® 60-140 HP • 4-1/4" Gearcase (Thru Hub & 13 Tooth)	506 1150 0600	210
Force® 40-75 HP • 3-1/4" Gearcase (Thru Hub & 13 Tooth)	11 1130 0100	114	Evinrude®/Johnson® 90-300 HP • V6 (4-3/4") Gearcase - Includes E-TEC Engines	502 1150 0200	See Note 2
Honda® 35-50 HP • 3-1/4" Gearcase (Thru Hub & 13 Tooth)	12 1130 0200	113	Honda® 135-225 HP • 4-3/4" Gearcase (Thru Hub & 15 Tooth)	507 1150 0700	207
Mercury®/Mariner® 25-70 HP • 3-1/4" Gearcase (Thru Hub & 13 Tooth)	11 1130 0100	114	Mercury®/Mariner®/Mercruiser® 135-300 HP • V6 (4-3/4") Gearcase & Mercruiser I/O	501 1150 0100	202
Nissan®/Tohatsu® 35-60 HP • 3-1/4" Gearcase (Thru Hub & 13 Tooth)	13 1130 0300	116	OMC® - Outboard Marine Model 800, King Cobra®, Cobra®, Sea Drive • 4-3/4" Gearcase	502 1150 0200	See Note 2
Suzuki® 35-65 HP • 3-1/4" Gearcase (Thru Hub & 13 Tooth)	11 1130 0100	115	Suzuki® 150-300 HP • 4-3/4" Gearcase (Thru Hub & 15 Tooth)	507 1150 0700	204
Yamaha® 30-60 HP • 3-1/4" Gearcase (Thru Hub & 13 Tooth)	12 1130 0200	111	Volvo Penta® SX Cobra®, Volvo Penta SX® • 4-3/4" Gearcase (19 Tooth)	504 1150 0400	205
Evinrude®/Johnson® 40-75 HP • Small 3-3/8" Gearcase (Thru Hub & 13 Tooth)	12 1130 0200	111	Yamaha® 150-300 HP & Yamaha® Sterndrives • 4-3/4" Gearcase	505 1150 0500	203

MICHIGAN WHEEL OEM CROSS REFERENCE

Original Equipment Manufacturer Part & Trade Mark		Standard Hub Propeller	XHS® / XHS II® Hub Propeller					XHS® / XHS II® Hub Kit(s)	Catalog Page #s	
		Michigan Match®	Ballistic®	Ballistic® XL	Vortex® XHS	Apollo® Std.	Apollo® Lg. Dia			Apollo® 4-Blade
BRP®, EVINRUDE®, JOHNSON®, OMC®										
174811	VIPER™ (LH)		937519			993054	993034	993214	See Note 2	11,50
174812	VIPER™ (LH)		937521			993055	993035	993215	See Note 2	11,50
174813	VIPER™ (LH)		937523			993056	993036	993216	See Note 2	11,50
174814	VIPER™	011008	933519		992004	993044	993024	993204	See Note 2	11,50
174815	VIPER™	011009	933521		992005	993045	993025	993205	See Note 2	11,50
174816	VIPER™		933523		992006	993046	993026	993206	See Note 2	11,50
174889	VIPER™	011007	933517		992003	993043	993023	993203	See Note 2	11,50
174890	VIPER™ (LH)		937517			993053	993033	993213	See Note 2	11,50
174926	SST II®	011006	933515		992002	993042			See Note 2	11,50
174927	SST II® (LH)				993052				See Note 2	11,50
174950		012111								2
175190		012055			992503			118		4
175191		012056	933013		992505			118		4
175738	Renegade™ Bass			963525					See Note 2	10,11
175739	Renegade™ Bass			963527					See Note 2	10,11
176058	Renegade™ Bass			963523					See Note 2	10,11
176196	Renegade™ Bass	011105		953422	992116	993146			See Note 5	6,7,49
176214		011024	933417		992114	993144			See Note 5	6,7,49
176215		011025	933419		992115	993145			See Note 5	6,7,49
176216		011105			992116	993146			See Note 5	6,7,49
176421		011027	933315		992312			111		5
176422		011028	933317		992303			111		5
176424					992504			118		4
176425					992506			118		4
176571	SST II®	011002	933415		992113	993143			See Note 5	6,7,49
176572	SST II®	011003	933417		992114	993144			See Note 5	6,7,49
176573	SST II®	011004	933419		992115	993145			See Note 5	6,7,49
176574	SST II®	011105		953422	992116	993146			See Note 5	6,7,49
176575	Renegade™ O.S.	011007	933517		992003	993043	993023	993203	See Note 2	11,50
176576	Renegade™ O.S.	011008	933519		992004	993044	993024	993204	See Note 2	11,50
176577	Renegade™ O.S.	011009	933521		992005	993045	993025	993205	See Note 2	11,50
176578	Renegade™ O.S. (LH)		937517			993053	993033	993213	See Note 2	11,50
176579	Renegade™ O.S. (LH)		937519			993054	993034	993214	See Note 2	11,50
176580	Renegade™ O.S. (LH)		937521			993055	993035	993215	See Note 2	11,50
176615	Swept-Blade™	011007	933517		992003	993043	993023	993203	See Note 2	11,50
176616	Swept-Blade™ (LH)		937517			993053	993033	993213	See Note 2	11,50
176617	Swept-Blade™	011008	933519		992004	993044	993024	993204	See Note 2	11,50
176618	Swept-Blade™ (LH)		937519			993054	993034	993214	See Note 2	11,50
176619	Swept-Blade™	011009	933521		992005	993045	993025	993205	See Note 2	11,50
176620	Swept-Blade™ (LH)		937521			993055	993035	993215	See Note 2	11,50
176623	VIPER™	011003	933417		992114	993144			See Note 5	6,7,49
176624	VIPER™	011004	933419		992115	993145			See Note 5	6,7,49
176625	VIPER™	011105			992116	993146			See Note 5	6,7,49
176626	VIPER™	011007	933517		992003	993043	993023	993203	See Note 2	11,50
176627	VIPER™	011008	933519		992004	993044	993024	993204	See Note 2	11,50
176628	VIPER™	011009	933521		992005	993045	993025	993205	See Note 2	11,50
176629	VIPER™ (LH)		937517			993053	993033	993213	See Note 2	11,50
176630	VIPER™ (LH)		937519			993054	993034	993214	See Note 2	11,50
176902	VIPER™ (LH)		937521			993055	993035	993215	See Note 2	11,50
176969	SST®	011008	933519		992004	993044	993024	993204	See Note 2	11,50
176970	SST®	011008	933519		992004	993044	993024	993204	See Note 2	11,50
176971	SST®	011009	933521		992005	993045	993025	993205	See Note 2	11,50
176973	SST® (LH)					993053	993033	993213	See Note 2	11,50
176999	Renegade™ O.S.		933523		992006	993046	993026	993206	See Note 2	11,50
177000	Renegade™ O.S. (LH)					993056	993036	993216	See Note 2	11,50
177034	SST®	011002	933415		992113	993143			See Note 5	6,7,49
177035	SST®	011003	933417		992114	993144			See Note 5	6,7,49
177036	SST®	011004	933419		992115	993145			See Note 5	6,7,49
177042	VIPER™	011002	933415		992113	993143			See Note 5	6,7,49
177128	Renegade™ Bass TBX™ (4)		963523						See Note 2	10,11
177129	Renegade™ Bass TBX™ (4)		963525						See Note 2	10,11
177130	Renegade™ Bass TBX™ (4)		963527						See Note 2	10,11
177131		011024	933417		992114	993144			See Note 5	6,7,49
177134		011007	933517		992003	993043	993023	993203	See Note 2	11,50
177135		011008	933519		992004	993044	993024	993204	See Note 2	11,50
177136		011009	933521		992005	993045	993025	993205	See Note 2	11,50
177137			933523		992006	993046	993026	993206	See Note 2	11,50
177139		011025	933419		992115	993145			See Note 5	6,7,49
177140			335033		992116	993145			See Note 5	6,7,49
177151		011002	933415		992113	993143			See Note 5	6,7,49
177153		012037			992311			111		5
177159		012111								3
177187		012057								4

* Indicates limited quantities.

MICHIGAN WHEEL OEM CROSS REFERENCE

Original Equipment Manufacturer Part & Trade Mark	Standard Hub Propeller	XHS® / XHS II® Hub Propeller						XHS® / XHS II® Hub Kit(s)	Catalog Page #s
	Michigan Match®	Ballistic®	Ballistic® XL	Vortex® XHS	Apollo® Std.	Apollo® Lg. Dia	Apollo® 4-Blade		

BRP®, EVINRUDE®, JOHNSON®, OMC® (Continued)

177258.....	VIPER™	011002	933415		992113	993143		See Note 5	6	
177259.....	VIPER™	011003	933417		992114	993144		See Note 5	6	
177265.....	Raker II®		953524						11,50	
177266.....	Raker II®		953526						11,50	
178811.....	VIPER™ (LH)				993054	993034	993214	See Note 2	11,50	
178814.....	VIPER™	011008			992004	993044	993024	993204	See Note 2	11,50
277212.....		012011							3	
277443.....		012011							3	
277580.....		012024							4	
277581.....		012024							4	
277583.....		012011							3	
277599.....		012011							3	
277759.....		012008							2	
375605.....		012109							3	
376506.....		012011							3	
376732.....		012024							4	
376735.....		012109							3	
376737.....		012011							3	
376805.....		012011							3	
376841.....		012109							3	
377410.....		012023							4	
377635.....		012007							2	
377636.....		012011							3	
378581.....		012023							3	
379717.....		012109							3	
380637.....		012024							3	
380958.....		012005							2	
381185.....		012091							46	
381186.....		012092							46	
381801.....		012011							3	
382761.....		012047							6,7,49	
382762.....		011001			992112			See Note 5	6,7,49	
382763.....		011002	933415		992113	993143		See Note 5	6,7,49	
382764.....		011003	933417		992114	993144		See Note 5	6,7,49	
382765.....		011004	933419		992115	993145		See Note 5	6,7,49	
382766.....		011105			992116	993146		See Note 5	6,7,49	
382768.....		011105			992116	993146		See Note 5	6,7,49	
383315.....		012008							2	
383629.....		012015							3	
384139.....	SST®	011003	933417		992114	993144		See Note 5	6,7,49	
384140.....	SST®	011105			992116	993146		See Note 5	6,7,49	
384141.....	SST®	011105			992116	993146		See Note 5	6,7,49	
384142.....	SST®	011004	933419		992115	993145		See Note 5	6,7,49	
384144.....	SST®	011002	933415		992113	993143		See Note 5	6,7,49	
384702.....	SST®	011105			992116	993146		See Note 5	6,7,49	
385319.....		012005							2	
385940.....	SST®	012008							2	
385955.....		012023							3	
386118.....		012111							3	
386317.....		012054			992501		118		4	
386637.....		012055			992503		118		4	
986786.....		011027	933315		992311		111		5	
386841.....		011028			992312		111		5	
386907.....		012036							5	
386909.....		012037			992301		111		5	
386933.....		012056			992505		118		4	
386955.....		012005							2	
386980.....	SST®	011028	933317		992303		111		5	
386981.....	SST®	011027	933315		992312		111		5	
386982.....	SST®	011035			992311		111		5	
387158.....		011016			992001			See Note 2	11,50	
387159.....		011006	933515		992002	993042		See Note 2	11,50	
387160.....		011007	933517		992003	993043	993023	993203	See Note 2	11,50
387161.....		011008	933519		992004	993044	993024	993204	See Note 2	11,50
387162.....		011009	933521		992005	993045	993025	993205	See Note 2	11,50
387163.....			933523		992006	993046	993026	993206	See Note 2	11,50
387334.....		012008							2	
387519.....	SST®	011008	933519		992004	993044	993024	993204	See Note 2	11,50
387520.....	SST®	011009	933521		992005	993045	993025	993205	See Note 2	11,50
387636.....		012056							4	
388088.....		012013							3	
388294.....		012102							3	
388883.....		012016							3	

* Indicates limited quantities.

MICHIGAN WHEEL OEM CROSS REFERENCE

Original Equipment Manufacturer Part & Trade Mark	Standard Hub Propeller	XHS® / XHS II® Hub Propeller						XHS® / XHS II® Hub Kit(s)	Catalog Page #s
	Michigan Match®	Ballistic®	Ballistic® XL	Vortex® XHS	Apollo® Std.	Apollo® Lg. Dia	Apollo® 4-Blade		

BRP®, EVINRUDE®, JOHNSON®, OMC® (Continued)

389019	SST II®		933523			993046	993026	993206	See Note 2	11,50
389068		012021								3
389069		012015								3
389510	SST II®	011004	933419		992115	993145			See Note 5	6,7,49
389512	SST II®	011105			992116	993146			See Note 5	6,7,49
389619		012015								3
389788		011105		953422	992116	993146			See Note 5	6,7,49
389855		012023								3
389923	SST II®	011009	933521		992005	993045	993025	993205	See Note 2	11,50
389924	SST II®	011008	933519		992004	993044	993024	993204	See Note 2	11,50
389925	SST®	011007	933517		992003	993043	993023	993203	See Note 2	11,50
389944		012030								3
389948	SST II®	011003	933417		992114	993144			See Note 5	6,7,49
389949	SST II®	011002	933415		992113	993143			See Note 5	6,7,49
390113	SST®	011004	933419		992115	993145			See Note 5	6,7,49
390114	SST®	011003	933417		992114	993144			See Note 5	6,7,49
390237		012032								2
390380		012057	933015							4
390725	SST®		933525							11,50
390729	SST®		933013							4
390730	SST®		933015							4
390821	SST II® (LH)		937519			993054	993034	993214	See Note 2	11,50
390822	SST II® (LH)		937521			993055	993035	993215	See Note 2	11,50
390823	SST II® (LH)		937523			993056	993036	993216	See Note 2	11,50
390833		012024								3
390849	SST®	011035			992311				111	5
390850	SST®	011027	933315		992312				111	5
390851	SST®	011028	933317		992303				111	5
390896		011004	933419		992115	993145			See Note 5	6,7,49
391198		011002	933415		992113	993143			See Note 5	6,7,49
391199		011003	933417		992114	993144			See Note 5	6,7,49
391200		011007	933517		992003	993043	993023	993203	See Note 2	11,50
391201		011008	933519		992004	993044	993024	993204	See Note 2	11,50
391202		011009	933521	953522	992005	993045	993025	993205	See Note 2	11,50
391203			933523	953524	992006	993046	993026	993206	See Note 2	11,50
391290	SST II®	011007	933517		992003	993043	993023	993203	See Note 2	11,50
391535		011006	933515		992002	993042	993022		See Note 2	11,50
391536		011016			992001				See Note 2	11,50
391668		011001								6,7,49
393160		011025			992115	993145			See Note 5	6,7,49
394752	Raker®	011007	933517		992003	993043		993203	See Note 2	11,50
394753	Raker®	011008	933519		992004	993044		993204	See Note 2	11,50
394754	Raker®	011009	933521	953522	992005	993045		993205	See Note 2	11,50
394755	Raker®		933523	953524	992006	993046		993206	See Note 2	11,50
394756	Raker®		933525	953526						11,50
394758	Raker®	011003	933417		992114	993144			See Note 5	6,7,49
394759	Raker®	011004	933419		992115	993145			See Note 5	6,7,49
394760	Raker®	011105		953422	992115	993146			See Note 5	6,7,49
394761	Raker®			953424						7
398126		012112								2
398502	Raker® (LH)		937519			993054		993214	See Note 2	11,50
398503	Raker® (LH)		937521			993055		993215	See Note 2	11,50
398504	Raker® (LH)					993056		993216	See Note 2	11,50
431717	Shooter®			963523						10,11
431718	Shooter®			963525						10,11
431930	SST II® (LH)		937517			993053		993213	See Note 2	11,50
591920		012024								3
591925		012011								3
592038		012011								3
592959		012011								3
763301		012047								6,7,49
763302		011001			992112				See Note 5	6,7,49
763304			933515		992002	993042	993022		205	51
763305						993052	993032		205	51
763306		161002	933517		992003	993043	993023	993203	205	51
763307			937517			993053	993033	993213	205	51
763308		161003	933519		992004	993044	993024	993204	205	51
763309						993054	993034	993214	205	51
763310		161004	933521		992005	993045	993025	993205	205	51
763311			937521			993055	993035	993215	205	51
763315		161001	933515		992002	993042	993022		205	51
763316		161002	933517		992003	993043	993023	993203	205	51
763317		161003	933519		992004	993044	993024	993204	205	51

* Indicates limited quantities.

MICHIGAN WHEEL OEM CROSS REFERENCE

Original Equipment Manufacturer Part & Trade Mark	Standard Hub Propeller	XHS® / XHS II® Hub Propeller						XHS® / XHS II® Hub Kit(s)	Catalog Page #s
	Michigan Match®	Ballistic®	Ballistic® XL	Vortex® XHS	Apollo® Std.	Apollo® Lg. Dia	Apollo® 4-Blade		

BRP®, EVINRUDE®, JOHNSON®, OMC® (Continued)

763318		161004	933521		992005	993045	993025	993205	205	51
763319		161005	933523		992006	993046	993026	993206	205	51
763453		011016			992001				See Note 2	11,50
763456		012112								2
763459		012055			992503				118	4
763460					992504				118	4
763461		012037			992311				111	5
763462		011028	933317		992303				111	5
763463		011003	933417		992114	993144			See Note 5	6,7,49
763464		011004	933419		992115	993145			See Note 5	6,7,49
763465		011105			992116	993146			See Note 5	6,7,49
763466		011002	933415		992113	993143			See Note 5	6,7,49
763467		011007	933517		992003	993043	993023	993203	See Note 2	11,50
763468		011008	933519		992004	993044	993024	993204	See Note 2	11,50
763469		011009	933521		992005	993045	993025	993205	See Note 2	11,50
763470			933523		992006	993046	993026	993206	See Note 2	11,50
763471		011006	933515		992002	993042			See Note 2	11,50
763486		012057	933015							4
763487		012054			992501				118	4
763488		012036								5
763568	Rebel™	011007	933517		992003	993043	993023	993203	See Note 2	11,50
763569	Rebel™ (LH)		937517			993053	993033	993213	See Note 2	11,50
763570	Rebel™	011008	933519		992004	993044	993024	993204	See Note 2	11,50
763571	Rebel™ (LH)		937519			993054	993034	993214	See Note 2	11,50
763572	Rebel™	011009	933521		992005	993045	993025	993205	See Note 2	11,50
763573	Rebel™ (LH)		937521			993055	993035	993215	See Note 2	11,50
763574	Rebel™		933523		992006	993046	993026	993206	See Note 2	11,50
763575	Rebel™ (LH)					993056	993036	993216	See Note 2	11,50
763583		012011								3
763584		012016								3
763585		012021								3
763586		012007								2
763587		012109								3
763588		012005								2
763589		012015								3
763590		012030								3
763912	VIPER™ TBX™		933515			993042			See Note 2	11,50
763913	VIPER™ TBX™ (LH)					993052			See Note 2	11,50
763914	VIPER™ TBX™	011007	933517		992003	993043	993023	993203	See Note 2	11,50
763915	VIPER™ TBX™ (LH)		937517			993053	993033	993213	See Note 2	11,50
763918	VIPER™ TBX™	011008	933519		992004	993044	993024	993204	See Note 2	11,50
763919	VIPER™ TBX™ (LH)		937519			993054	993034	993214	See Note 2	11,50
763922	VIPER™ TBX™	011009	933521		992005	993045	993025	993205	See Note 2	11,50
763923	VIPER™ TBX™ (LH)		937521			993055	993035	993215	See Note 2	11,50
763929	VIPER™ 3	011002	933415		992113	993143			See Note 5	6
763930	VIPER™ 3	011003	933417		992114	993144			See Note 5	6
763931	VIPER™ 3	011004	933419		992115	993145			See Note 5	6
763932	VIPER™ 3	011105			992116	993146			See Note 5	6
763938	Cyclone™ TBX™ 4				992202			993203	See Note 2	11,50
763939	Cyclone™ TBX™ 4 (LH)							993213	See Note 2	11,50
763940	Cyclone™ TBX™ 4				992203			993204	See Note 2	11,50
763941	Cyclone™ TBX™ 4 (LH)							993214	See Note 2	11,50
763944	Cyclone™ TBX™ 4				992204			993205	See Note 2	11,50
763945	Cyclone™ TBX™ 4 (LH)							993215	See Note 2	11,50
763950		011002	933415		992113	993143			See Note 5	6,7
763951		011003	933417		992114	993144			See Note 5	6,7
763952		011004	933419		992115	993145			See Note 5	6,7
763956	Raker®		953424						206	7
763962	SST® TBX™		933515		992002	993042			See Note 2	11,50
763963	SST® TBX™ (LH)					993052			See Note 2	11,50
763964	Rogue™ Stainless Steel				941413				See Note 5	6,7,8
763965	Rogue™ Stainless Steel				941415				See Note 5	6,7,8
763966	Rogue™ Stainless Steel				941417				See Note 5	6,7,8
763967	Rogue™ Stainless Steel				941419				See Note 5	6,7,8
763986	Rebel™ TBX™	011007	933517		992003	993043	993023	993203	See Note 2	11,50
763987	Rebel™ TBX™ (LH)		937517			993053	993033	993213	See Note 2	11,50
763990	Rebel™ TBX™	011008	933519		992004	993044	993024	993204	See Note 2	11,50
763991	Rebel™ TBX™ (LH)		937519			993054	993034	993214	See Note 2	11,50
763994	Rebel™ TBX™	011009	933521		992005	993045	993025	993205	See Note 2	11,50
763995	Rebel™ TBX™ (LH)		937519			993055	993035	993215	See Note 2	11,50
763998	Rebel™ TBX™		933523		992006	993046	993026	993206	See Note 2	11,50
763999	Rebel™ TBX™ (LH)					993056	993036	993216	See Note 2	11,50
765048	Aluminum	012054			992501				118	4

* Indicates limited quantities.

MICHIGAN WHEEL OEM CROSS REFERENCE

Original Equipment Manufacturer Part & Trade Mark	Standard Hub Propeller	XHS® / XHS II® Hub Propeller						XHS® / XHS II® Hub Kit(s)	Catalog Page #s
	Michigan Match®	Ballistic®	Ballistic® XL	Vortex® XHS	Apollo® Std.	Apollo® Lg. Dia	Apollo® 4-Blade		

BRP®, EVINRUDE®, JOHNSON®, OMC® (Continued)

765049	Aluminum	012055			992503			118	4	
765050	Aluminum				992504			118	4	
765176	SSP	012055			992503			118	4	
765178	SSP		933013					118	4	
765180	SSP		933015					118	4	
765181		011001			992112			See Note 5	6,7,49	
765182					992113	993143		See Note 5	6,7,49	
765183					992114	993144		See Note 5	6,7,49	
765184					992115	993145		See Note 5	6,7,49	
765185					992116	993146		See Note 5	6,7,49	
765186			933515		992002	993042		See Note 2	11,50	
765187		011007	933517		992003	993043	993023	993203	See Note 2	11,50
765188		011008	933519		992004	993044	993024	993204	See Note 2	11,50
765189		011009	933521		992005	993045	993025	993205	See Note 2	11,50
775713		012037			992311			111	5	
776807		032046							5	
776891		011001			992112			See Note 5	6,7,49	
777021	SST® High Luster	032042	993213		992605	993406		115	5	
777022	SST® High Luster	032041			992606	993407		115	5	
777023	SST® High Luster	032040	933215		992408	993408		115	5	
777024		061024			992114	993144		See Note 4	8	
777025		061028			992115	993145		See Note 4	8	
777026		061032			992116	993146		See Note 4	8	
777029						993154		See Note 4	8	
777030						993155		See Note 4	8	
777031						993156		See Note 4	8	
778703					992503			121	4	
778704					992504			121	4	
778705			933013		992505			121	4	
778706					992506			121	4	
778738		061020							8	
778739		061024							8	
778740		061028							8	
778741		061032							8	
778772		012111							3	
778774		011027	933315		992302			111	5	
778797		012032							2	
778863		012056	933013		992505			118	4	
5005384		062103							2	
5005385		062104							2	
5031619		032042	993213		992406	993406		115	5	
5031627		032040	933215		992408	993408		115	5	
5031628					992409			115	5	
5032107					992502			121	4	
5032108					992503			121	4	
5032109					992504			121	4	
5032110			933013		992505			121	4	
5032171					992501			121	4	
5033201		062103							2	
5033203		062105							2	
5033322		061020	933415		992113	993143		See Note 4	8	
5033323		061024	933417		992114	993144		See Note 4	8	
5033324		061028	933419		992115	993145		See Note 4	8	
5033325		061032	933421		992116	993146		See Note 4	8	
5033327		061024	933417		992114	993144		See Note 4	8	
5033328		061028	933419		992115	993145		See Note 4	8	
5033329		061032	933421		992116	993146		See Note 4	8	
5040538		142102							2	
5040590		142204							3	
5040591		142205							3	
5040592		142206							3	

FORCE®, CHRYSLER, U.S. MARINE

48-16986A45	Vengeance	031041	933415		992113	993143		202	15
48-16986A5	QSS™	031041	933415		992113	993143		202	15
48-16988A40	QSS™	031042	933417		992114	993144		202	15
48-16988A45	Vengeance	031042	933417		992114	993144		202	15
48-16990A45	Laser II™	031043	933419		992115	993145		202	15
48-16992A45	Laser II™	031044	933421	953422	992116	993146		202	15
48-19636A10					992501			120	12
48-19638A40	Black Max™	031049			992503			120	12
48-19639A40	Black Max™				992504			120	12
48-19640A40	Black Max™	031048	933013		992505			120	12

* Indicates limited quantities.

MICHIGAN WHEEL OEM CROSS REFERENCE

Original Equipment Manufacturer Part & Trade Mark	Standard Hub Propeller	XHS® / XHS II® Hub Propeller						XHS® / XHS II® Hub Kit(s)	Catalog Page #s
	Michigan Match®	Ballistic®	Ballistic® XL	Vortex® XHS	Apollo® Std.	Apollo® Lg. Dia	Apollo® 4-Blade		

FORCE®, CHRYSLER, U.S. MARINE (Continued)

48-19642A40	Black Max™							120	12
48-42738A10	Black Max™	032141							13
48-42740A10	Black Max™	032142							13
48-64724A4		031020							13
48-73132A40	Black Max™	031015							13
48-73134A4	Black Max™	031016			992405	993405		114	13
48-73134A40	Black Max™	031016			992405	993405		114	13
48-73136A4	Black Max™	031017	933213		992406	993406		114	13
48-73136A40	Black Max™	031017	933213		992406	993406		114	13
48-73138A4	Black Max™	031018			992407	993407		114	13
48-73138A40	Black Max™	031018			992407	993407		114	13
48-73140A4	Black Max™	031019	933215		992408	993408		114	13
48-73140A40	Black Max™	031019	933215		992408	993408		114	13
48-73142A40	Black Max™				992409			114	13
48-73144A40	Black Max™	031020							13
48-76228A4	QSS™	031017	933213		992406	993406		114	13
48-76228A5	Vengeance	031017	933213		992406	993406		114	13
48-76230A4	QSS™	031018			992407	993407		114	13
48-76230A5	Vengeance	031018			992407	993407		114	13
48-76232A4	QSS™	031019	933215		992408	993408		114	13
48-76232A5	Vengeance	031019	933215		992409	993408		114	13
48-77338A45	Black Max™	031254							15
48-77338CP1	Pontoon				941411			202	15
48-77340A40	Black Max™	031055			992112			202	15
48-77340A45	Black Max™	031055			992112			202	15
48-77338CP1	Pontoon				941413			202	15
48-77342A40	Black Max™	031041	933415		992113	993143		202	15
48-77342A45	Black Max™	031041	933415		992113	993143		202	15
48-77344A40	Black Max™	031042	933417		992114	993144		202	15
48-77344A45	Black Max™	031042	933417		992114	993144		202	15
48-77346A40	Black Max™	031043	933419		992115	993145		202	15
48-77346A45	Black Max™	031043	933419		992115	993145		202	15
48-77348A40	Black Max™	031044	933421	953422	992116	993146		202	15
48-77348A45	Black Max™	031044	933421	953422	992116	993146		202	15
48-77350A40	Black Max™	031045*							15
48-77350A45	Black Max™	031045*							15
48-79792A4	QSS™	031016			992405	993405		114	13
48-79792A5	Vengeance	031016			992405	993405		114	13
48-816702A40		031056			992405	993405		114	13
48-816704A40		031057			992406	993406		114	13
48-816706A40		031058	933213		992407	993407		114	13
48-819334A40		072133							13
48-819335A40		072132							13
48-819336A40		072131							13
48-819337A40		072014							13
48-819337A45		072014							13
48-855858A5	Vengeance	031057			992406	993406		114	13
48-85632A40	Black Max™	031053			992404			114	13
48-FP488		072123							12
48-FP669-1		071035			992113	993143		202	14
48-FP669-2		071035			992113	993143		202	14
48-FP669-3		071035			992113	993143		202	14
48-FP685-1		071036			992114	993144		202	14
48-FP685-2		071036			992114	993144		202	14
48-FP685-3		071036			992114	993144		202	14
48-FP686-1					992115	993145		202	14
48-FP686-3					992115	993145		202	14
48-FP686-4					992115	993145		202	14
48-FP692-1		072127			992113	993143		202	14
48-FP692-2		072127			992113	993143		202	14
48-FP692-3		072127			992113	993143		202	14
48-FP694					992116	993146		202	14
FA282265		072132							13
FA287265		072131							13
FA378265		072132							13
FP273		072133							13
FP274		072014							13
FP276		072014							13
FP277		072131							13
FP278		072014							13
FP282		072132							13
FP287		072131							13
FP293		072132							13

MICHIGAN WHEEL OEM CROSS REFERENCE

Original Equipment Manufacturer Part & Trade Mark	Standard Hub Propeller	XHS® / XHS II® Hub Propeller						XHS® / XHS II® Hub Kit(s)	Catalog Page #s
	Michigan Match®	Ballistic®	Ballistic® XL	Vortex® XHS	Apollo® Std.	Apollo® Lg. Dia	Apollo® 4-Blade		

FORCE®, CHRYSLER, U.S. MARINE (Continued)

FP328.....	072014.....								13
FP366.....	072014.....								13
FP378.....	072132.....								13
FP519.....	072055.....								14
FP523.....	072107.....								14
FP524.....	072108.....								14
FP623.....	072107.....								14
FP654.....	072108.....								14
FP665.....	071035.....								14
FP669.....	071035.....								14
FP669-1.....	071035.....								14
FP682.....	072127.....								14
FP685-1.....	072128.....								14
FP692.....	072127.....								14
FP692-1.....	072127.....								14
FPM736.....	031020.....								13
FPM738.....	031019.....			992408.....	993408.....			114.....	13
FPM752.....	031058.....	933213.....		992407.....	993407.....			114.....	13
FPM754.....	031056.....			992405.....	993405.....			114.....	13
FPM756.....	031015.....								13
FPS523.....	072107.....								14
FPS524.....	072108.....								14
FPS623.....	072107.....								14
FPS625.....	072108.....								14
FPS626.....	072109.....								14
FPS654.....	072108.....								14

HONDA®

08M60-ZW7-A10.....	Turbo 3-Blade.....	031042.....	933417.....	992114.....	993144.....			See Note 3.....	18
08M60-ZW7-A20.....	Turbo 3-Blade.....	031043.....	933419.....	992115.....	993145.....			See Note 3.....	18
08M60-ZW7-A30.....	Turbo 3-Blade.....	031044.....	933421.....	992116.....	993146.....			See Note 3.....	18
08M60-ZW7-B00.....	Turbo 3-Blade (LH).....				993153.....			See Note 3.....	18
08M60-ZW7-B10.....	Turbo 3-Blade (LH).....				993154.....			See Note 3.....	18
08M60-ZW7-B20.....	Turbo 3-Blade (LH).....				993155.....			See Note 3.....	18
08M60-ZW7-B30.....	Turbo 3-Blade (LH).....				993156.....			See Note 3.....	18
58110-ZV4-300.....		102005.....							16
58110-ZV5-E00.....	Turbo 3-Blade.....	032040.....	933215.....	992408.....	993408.....			113.....	17
58110-ZV5-E10.....	Turbo 3-Blade.....	032041.....		992606.....	993407.....			113.....	17
58110-ZV5-E20.....	Turbo 3-Blade.....	032042.....	993213.....	992605.....	993406.....			113.....	17
58110-ZV5-E30.....	Turbo 3-Blade.....	032043.....		992405.....	993405.....			113.....	17
58130-881-840ZA.....		012109.....							16
58130-881-840ZB.....		012109.....							16
58130-935-000N.....		012109.....							16
58130-935-600N.....		012109.....							16
58130-ZV4-000ZA.....		102005.....							16
58130-ZV4-008AH.....	Solas® Honda.....	102003.....							16
58130-ZV4-009AH.....	Solas® Honda.....	102004.....							16
58130-ZV4-010ZA.....	Solas® Honda.....	102005.....							16
58130-ZV4-020ZA.....		102005.....							16
58130-ZV4-030ZA.....		102005.....							16
58130-ZV4-030ZB.....		102005.....							16
58130-ZV4-700ZA.....		102004.....							16
58130-ZV4-701ZA.....		102004.....							16
58130-ZV4-702ZA.....		102004.....							16
58130-ZV4-703ZA.....		102004.....							16
58130-ZV4-703ZB.....		102004.....							16
58130-ZV5-000ZA.....		032042.....	993213.....	992605.....	993406.....			113.....	17
58130-ZV5-011AH.....	Solas® Honda.....	032044.....		992603.....	993404.....			113.....	17
58130-ZV5-012AH.....	Solas® Honda.....	032043.....		992604.....	993405.....			113.....	17
58130-ZV5-013AH.....	Solas® Honda.....	032042.....		992605.....	993406.....			113.....	17
58130-ZV5-014AH.....	Solas® Honda.....	032041.....		992606.....	993407.....			113.....	17
58130-ZV5-015AH.....	Solas® Honda.....	032040.....		992408.....	993408.....			113.....	17
58130-ZV5-850ZA.....		032043.....		992604.....	993405.....			113.....	17
58130-ZV5-860ZA.....		032045.....		992603.....				113.....	17
58130-ZV5-870ZA.....		032040.....	933215.....	992408.....	993408.....			113.....	17
58130-ZV7-009AH.....	Solas® Honda.....			992501.....				119.....	16
58130-ZV7-010AH.....	Solas® Honda.....			992502.....				119.....	16
58130-ZV7-011AH.....	Solas® Honda.....			992503.....				119.....	16
58130-ZV7-012AH.....	Solas® Honda.....			992504.....				119.....	16
58130-ZV7-013AH.....	Solas® Honda.....		933013.....	992505.....				119.....	16
58130-ZW1-011AH.....	Solas® Honda.....	031254.....		992111.....				See Note 3.....	18
58130-ZW1-013AH.....	Solas® Honda.....	031055.....		992112.....				See Note 3.....	18
58130-ZW1-015AH.....	Solas® Honda.....	031041.....	933415.....	992113.....	993143.....			See Note 3.....	18

* Indicates limited quantities.

MICHIGAN WHEEL OEM CROSS REFERENCE

Original Equipment Manufacturer Part & Trade Mark	Standard Hub Propeller	XHS® / XHS II® Hub Propeller						XHS® / XHS II® Hub Kit(s)	Catalog Page #s
	Michigan Match®	Ballistic®	Ballistic® XL	Vortex® XHS	Apollo® Std.	Apollo® Lg. Dia	Apollo® 4-Blade		

HONDA® (Continued)

58130-ZW1-015B.....	Solas® Honda (LH)								993153	See Note 3	18
58130-ZW1-017AH.....	Solas® Honda	031042	933417		992114	993144			993144	See Note 3	18
58130-ZW1-017B.....	Solas® Honda (LH)					993154			993154	See Note 3	18
58130-ZW1-019AH.....	Solas® Honda	031043	933419		992115	993145			993145	See Note 3	18
58130-ZW1-021AH.....	Solas® Honda	031044	933421	953422	992116	993146			993146	See Note 3	18
58130-ZW1-V01.....		031042	933417		992114	993144			993144	See Note 3	18
58130-ZW1-V11.....		031043	933419		992115	993145			993145	See Note 3	18
58130-ZW1-V31.....		031044	933421	953422	992116	993146			993146	See Note 3	18
58130-ZW1-W01ZA.....		031254			992111					See Note 3	18
58130-ZW1-W11ZA.....		031055			992112					See Note 3	18
58130-ZW1-W21ZA.....		031041	933415		992113	993143			993143	See Note 3	18
58130-ZW1-W31ZA.....		031042	933417		992114	993144			993144	See Note 3	18
58130-ZW1-W41ZA.....		031044	933421	953422	992116	993146			993146	See Note 3	18
58130-ZW1-W51ZA.....		031045*									18
58130-ZW1-W61ZA.....		031043	933419		992115	993145			993145	See Note 3	18
58130-ZW1-W91.....		031041	933415		992113	993143			993143	See Note 3	18
58130-ZW2-F01ZA.....		111106									16
58130-ZW2-F11AZ.....		111103									16
58130-ZW2-F21AZ.....		111107									16
58130-ZW2-F31AZ.....		111105									16
58130-ZW2-F41AZ.....		111108									16
58130-ZY3-013A.....	Solas® Honda	031513			992001					207	19
58130-ZY3-015A.....	Solas® Honda	031023	933515		992002	993042	993022			207	19
58130-ZY3-017A.....	Solas® Honda	031024	933517		992003	993043	993023	993203		207	19
58130-ZY3-017AP.....	Solas® Honda	031064	933517		992003	993043	993023	993203		207	19
58130-ZY3-017B.....	Solas® Honda (LH)		937517			993053	993033	993213		207	19
58130-ZY3-017BP.....	Solas® Honda (LH)		937517			993053	993033	993213		207	19
58130-ZY3-017P.....	Solas® Honda	031064	933517		992003	993043	993023	993203		207	19
58130-ZY3-019A.....	Solas® Honda	031025	933519		992004	993044	993024	993204		207	19
58130-ZY3-019AP.....	Solas® Honda	031065	933519		992004	993044	993024	993204		207	19
58130-ZY3-019B.....	Solas® Honda (LH)		937519			993054	993034	993214		207	19
58130-ZY3-021A.....	Solas® Honda	031026	933521		992005	993045	993025	993205		207	19
58130-ZY3-021B.....	Solas® Honda (LH)		937521			993055	993035	993215		207	19
58130-ZY3-023A.....	Solas® Honda		933523		992006	993046	993026	993206		207	19
58130-ZY3-15B.....	Solas® Honda					993052				207	19
58133-ZV4-008AH.....	Solas® Saturn	102003									16
58133-ZV4-009AH.....	Solas® Saturn	102004									16
58133-ZV4-010AH.....	Solas® Saturn	102005									16
58133-ZV5-012AH.....	Solas® Saturn	032043			992604	993405				113	17
58133-ZV5-013AH.....	Solas® Saturn	032042	993213		992605	993406				113	17
58133-ZV5-014AH.....	Solas® Saturn	032041			992606	993407				113	17
58133-ZV5-015AH.....	Solas® Saturn	032040	933215		992408	993408				113	17
58133-ZV7-013AH.....	Solas® Saturn		933013		992505					119	16
58133-ZW1-A11P.....	Solas® New Saturn				941411					See Note 3	18
58133-ZW1-A13P.....	Solas® New Saturn				941413					See Note 3	18
58133-ZW1-A15AH.....	Solas® Titan	031041	933415		992113	993143				See Note 3	18
58133-ZW1-A15HR.....	Solas® Titan HR3	031041	933415		992113	993143				See Note 3	18
58133-ZW1-A17AH.....	Solas® Titan	031042	933417		992114	993144				See Note 3	18
58133-ZW1-A17HR.....	Solas® Titan HR3	031042	933417		992114	993144				See Note 3	18
58133-ZW1-A19AH.....	Solas® Titan	031043	933419		992115	993145				See Note 3	18
58133-ZW1-A19HR.....	Solas® Titan HR3	031043	933419		992115	993145				See Note 3	18
58133-ZW1-A21HR.....	Solas® Titan HR3	031044	933421		992116	993146				See Note 3	18
58133-ZW1-B15AH.....	Solas® Titan (LH)					993153				See Note 3	18
58133-ZW1-B17AH.....	Solas® Titan (LH)					993154				See Note 3	18
58133-ZW1-B17HR.....	Solas® Titan HR3 (LH)					993154				See Note 3	18
58133-ZW1-B19AH.....	Solas® Titan (LH)					993155				See Note 3	18
58133-ZW1-B19HR.....	Solas® Titan HR3 (LH)					993155				See Note 3	18
58133-ZW1-B21HR.....	Solas® Titan HR3 (LH)					993156				See Note 3	18
58133-ZY3-A15AH.....	Solas® New Saturn	031023	933515		992002	993042				207	19
58133-ZY3-A15LX.....	Solas® Lexor	031024	933517		992003	993043	993023	993203		207	19
58133-ZY3-A15S.....	Solas® Titan	031023	933515		992002	993042				207	19
58133-ZY3-A17AH.....		031024	933517		992003	993043	993023	993203		207	19
58133-ZY3-A17HR.....	Solas® Titan HR3	031024	933517		992003	993043	993023	993203		207	19
58133-ZY3-A17LX.....	Solas® Lexor	031065	933519		992004	993044	993024	993204		207	19
58133-ZY3-A17S.....	Solas® Titan	031024	933517		992003	993043	993023	993203		207	19
58133-ZY3-A19AH.....		031065	933519		992004	993044	993024	993204		207	19
58133-ZY3-A19HR.....	Solas® Titan HR3	031065	933519		992004	993044	993024	993204		207	19
58133-ZY3-A19LX.....	Solas® Lexor	031026	933521		992005	993045	993025	993205		207	19
58133-ZY3-A19S.....	Solas® Titan	031065	933519		992004	993044	993024	993204		207	19
58133-ZY3-A21AH.....		031026	933521		992005	993045	993025	993205		207	19
58133-ZY3-A21HR.....	Solas® Titan HR	031026	933521		992005	993045	993025	993205		207	19
58133-ZY3-A21LX.....	Solas® Lexor		933523		992006	993046	993026	993206		207	19
58133-ZY3-A21S.....	Solas® Titan	031026	933521		992005	993045	993025	993205		207	19

* Indicates limited quantities.

MICHIGAN WHEEL OEM CROSS REFERENCE

Original Equipment Manufacturer Part & Trade Mark	Standard Hub Propeller	XHS® / XHS II® Hub Propeller						XHS® / XHS II® Hub Kit(s)	Catalog Page #s
	Michigan Match®	Ballistic®	Ballistic® XL	Vortex® XHS	Apollo® Std.	Apollo® Lg. Dia	Apollo® 4-Blade		

HONDA® (Continued)

58133-ZY3-A23S	Solas® Titan		933523		992006	993046	993026	993206	207	19
58133-ZY3-A25AH			933525						207	19
58133-ZY3-B15AH	Solas® New Saturn (LH)					993052			207	19
58133-ZY3-B15LX	Solas® Lexor (LH)		937517			993053	993033	993213	207	19
58133-ZY3-B17AH	Solas® New Saturn (LH)		937517			993053	993033	993213	207	19
58133-ZY3-B17HR	Solas® Titan HR3 (LH)		937517			993053	993033	993213	207	19
58133-ZY3-B17S	Solas® Titan (LH)		937517			993053	993033	993213	207	19
58133-ZY3-B19AH	Solas® New Saturn (LH)		937519			993054	993034	993214	207	19
58133-ZY3-B19HR	Solas® Titan HR3 (LH)		937519			993054	993034	993214	207	19
58133-ZY3-B19LX	Solas® Lexor (LH)		937521			993055	993035	993215	207	19
58133-ZY3-B19S	Solas® Titan (LH)		937519			993054	993034	993214	207	19
58133-ZY3-B21AH	Solas® New Saturn (LH)		937521			993055	993035	993215	207	19
58133-ZY3-B21HR	Solas® Titan HR3 (LH)		937521			993055	993035	993215	207	19
58133-ZY3-B21LX	Solas® Lexor (LH)		937523			993056	993036		207	19
58133-ZY3-B21S	Solas® Titan (LH)		937521			993055	993035	993215	207	19
58133-ZY3-B23S	Solas® Titan (LH)		937523			993056	993036	993216	207	19
58134-ZV5-009AH					992402				113	17
58134-ZV5-010AH					992403				113	17
58134-ZW1-013AH	Solas® Honda				941413				See Note 3	18
58134-ZW1-015AH	Solas® Honda				941415				See Note 3	18
58134-ZW1-017AH	Solas® Honda				941417				See Note 3	18
58134-ZW1-019AH	Solas® Honda				941419				See Note 3	18
58134-ZY3-017A	Solas® Honda				992202			993203	207	19
58134-ZY3-017B	Solas® Honda (LH)							993213	207	19
58134-ZY3-019A	Solas® Honda				992203			993204	207	19
58134-ZY3-019B	Solas® Honda (LH)							993214	207	19
58134-ZY3-021A	Solas® Honda				992204			993205	207	19
58134-ZY3-021B	Solas® Honda (LH)							993215	207	19
58134-ZY3-A18HR	Solas® Titan HR4							993204	207	19
58134-ZY3-A20HR	Solas® Titan HR4							993205	207	19
58134-ZY3-A21HR	Solas® Titan HR4							993205	207	19
58134-ZY3-B18HR	Solas® Titan HR4 (LH)							993214	207	19
58134-ZY3-B20HR	Solas® Titan HR4 (LH)							993215	207	19
58134-ZY3-B21HR	Solas® Titan HR4 (LH)							993215	207	19
58233-ZY3-A15H	Turbo 3-Blade	031023	933515		992002	993042			207	19
58233-ZY3-A17H	Turbo 3-Blade	031024	933517		992003	993043	993023	993203	207	19
58233-ZY3-A19H	Turbo 3-Blade	031025	933519		992004	993044	993024	993204	207	19
58233-ZY3-A21H	Turbo 3-Blade	031026	933521		992005	993045	993025	993205	207	19
58233-ZY3-A23H	Turbo 3-Blade	031027	933523		992006	993046	993026	993206	207	19
58233-ZY3-A23HP	Turbo Performance	031027	933523		992006	993046	993026	993206	207	19
58233-ZY3-A25H	Turbo 3-Blade		933525						207	19
58233-ZY3-B15H	Turbo 3-Blade (LH)					993052			207	19
58233-ZY3-B17H	Turbo 3-Blade (LH)		937517			993053	993033	993213	207	19
58233-ZY3-B19H	Turbo 3-Blade (LH)		937519			993054	993034	993214	207	19
58233-ZY3-B21H	Turbo 3-Blade (LH)		937521			993055	993035	993215	207	19
58233-ZY3-B23H	Turbo 3-Blade (LH)		937523			993056	993036	993216	207	19
58234-ZY3-A20H	Turbo 4-Blade							993205	207	19
58234-ZY3-A22H	Turbo 4-Blade			963523				993206	207	19
58234-ZY3-A23HP	Turbo 4-Blade Perf.			963523				993206	207	19
58333-ZY3-A15CL	PowerTech OFS		933515						207	19
58333-ZY3-A17CL	PowerTech OFS	031024	933517		992003	993043	993023	993203	207	19
58333-ZY3-A19CL	PowerTech OFS	031025	933519		992004	993044	993024	993204	207	19
58333-ZY3-A21CL	PowerTech OFS	031026	933521		992005	993045	993025	993205	207	19
58333-ZY3-A23CL	PowerTech OFS	031027	933523		992006	993046	993026	993206	207	19
58333-ZY3-B17CL	PowerTech OFS (LH)		937517			993053	993033	993213	207	19
58333-ZY3-B19CL	PowerTech OFS (LH)		937519			993054	993034	993214	207	19
58333-ZY3-B21CL	PowerTech OFS (LH)		937521			993055	993035	993215	207	19
58333-ZY3-B23CL	PowerTech OFS (LH)		937523			993056	993036	993216	207	19

MERCURY®, MARINER®, MERCURUISER®

48-11070A40	Laser™		933521	953522		993045	993025	993205	202	26,47
48-11074A40	Laser™		933523	953524		993046	993026	993206	202	26,47
48-11320A40	Black Max™	031050			992002	993042			202	26,47
48-11322A40	Black Max™	031516			992003	993043	993023	993203	202	26,47
48-11324A40	Black Max™	031052	933519		992004	993044	993024	993204	202	26,47
48-11324A45	Black Max™	031052	933519		992004	993044	993024	993204	202	26,47
48-13242A50	Mirage®	031065	933519		992004	993044	993024	993204	202	26,47
48-13243A50	Mirage® (LH)		937521			993055	993035	993215	202	26,47
48-13244A50	Mirage®	031066	933521		992005	993045	993025	993205	202	26,47
48-13245A50	Mirage® (LH)		937523			993056	993036	993216	202	26,47
48-13700A46	Mirage® Plus						993024		202	26,47
48-13701A40	Mirage® (LH)		937519						202	26,47
48-13701A41	Mirage® (LH)		937519						202	26,47

MICHIGAN WHEEL OEM CROSS REFERENCE

Original Equipment Manufacturer Part & Trade Mark	Standard Hub Propeller	XHS® / XHS II® Hub Propeller						XHS® / XHS II® Hub Kit(s)	Catalog Page #s
	Michigan Match®	Ballistic®	Ballistic® XL	Vortex® XHS	Apollo® Std.	Apollo® Lg. Dia	Apollo® 4-Blade		

MERCURY®, MARINER®, MERCURISER® (Continued)

48-13701A46	Mirage® Plus (LH)		937519			993034	993214	202	26,47
48-13702A55	Mirage® Plus	031066	933521		992005	993045	993205	202	26,47
48-13703A55	Mirage® Plus (LH)		937521			993055	993035	993215	202
48-13704A46	Mirage® Plus		933523		992006	993046	993026	993206	202
48-13705A55	Mirage® Plus (LH)		937523					202	26,47
48-13706A46	Mirage® Plus		933525					202	26,47
48-16312A46	Vengeance	031023	933515		992002	993042		202	26,47
48-16314A46	Vengeance	031064	933517		992003	993043	993023	993203	202
48-16315A46	Vengeance (LH)		937517			993053	993033	993213	202
48-16316A46	Vengeance	031065	933519		992004	993044	993024	993204	202
48-16317A46	Vengeance (LH)		937519			993054	993034	993214	202
48-16318A46	Vengeance	031066	933521		992005	993045	993025	993205	202
48-16319A46	Vengeance (LH)		937521			993055	993035	993215	202
48-16320A5	QSS™		933523		992006	993046	993026	993206	202
48-16321A4	QSS™		933523		992006	993046	993026	993206	202
48-16320A46	Vengeance		933523		992006	993046	993026	993206	202
48-16320A5	QSS™		933523		992006	993046	993026	993206	202
48-16321A46	Vengeance (LH)		937523			993056	993036	993216	202
48-16322A4	QSS™		933525					202	26,47
48-16322A46	Vengeance		933525					202	26,47
48-16438A45	Black Max™	031050			992002	993042		202	26,47
48-16440A45	Black Max™	031516			992003	993043	993023	993203	202
48-16543A46	Laser II™ (LH)		937519			993054	993034	993214	202
48-16544A46	Laser II™	031065	933519		992004	993044	993024	993204	202
48-16545A46	Laser II™ (LH)		937521			993055	993035	993215	202
48-16546A46	Laser II™	031066	933521		992005	993045	993025	993205	202
48-16547A46	Laser II™ (LH)		937523			993056	993036	993216	202
48-16548A41	Laser II™		933523		992006	993046	993026	993206	202
48-16548A45	Laser II™		933523		992006	993046	993026	993206	202
48-16548A46	Laser II™		937523			993056	993036	993216	202
48-16550A40	Laser II™		933525					202	26,47
45-16550A41	Laser II™		933525					202	26,47
48-16550A45	Laser II™		933525					202	26,47
48-16550A46	Laser II™		933525					202	26,47
48-16986A46	Vengeance	031041	933415		992113	993143		202	25
48-16988A46	Vengeance	031042	933417		992114	993144		202	25
48-16990A45	Laser II™	031043	933419		992115	993145		202	25
48-16992A40	Laser II™	031044	933421		992116	993146		202	25
48-16994A46	Laser II™		953424					202	25
48-17874A12		032050							20
48-18278A46	Mirage® Plus		933517			993043	993023	202	26,47
48-19636A10	Black Max™				992501			120	21
48-19638A40	Black Max™	031049			992503			120	21
48-19639A40	Black Max™				992504			120	21
48-19640A40	Black Max™	031048	933013		992505			120	21
48-19642A40	Black Max™		933015		992506			120	21
48-19644A5	Vengeance		933013					120	21
48-19841A46	Mirage® Plus (LH)					993052	993032	202	26,47
48-30388A1		031042	933417		992114	993144		202	25
48-30390A1		031041	933415		992113	993143		202	25
48-30396A1		031254			992111			202	25
48-30396A3		031254			992111			202	25
48-30396A4		031254			992111			202	25
48-31072A4		031041	933415		992113	993143		202	25
48-31080A1		031042	933417		992114	993144		202	25
48-31082A1		031041	933415		992113	993143		202	25
48-31454A3		031043	933419		992115	993145		202	25
48-31456A3		031042	933417		992114	993144		202	25
48-31458A3		031041	933415		992113	993143		202	25
48-32264A3		031041	933415		992113	993143		202	25
48-32386A3		031043	933419		992115	993145		202	25
48-32386A4		031048							21
48-32388A3		031042	933417		992114	993144		202	25
48-32990A3		031055			992112			202	25
48-32392A3		031254			992111			202	25
48-32392A4		031055			992112			202	25
48-32746A3		031044	933421		992116	993146		202	25
48-32748A3		031042	933417		992114	993144		202	25
48-32750A3		031042	933417		992114	993144		202	25
48-33480A1		032135							21
48-33482A1		032136							21
48-35936A3		031254			992111			202	25
48-35936A4		031055			992112			202	25

MICHIGAN WHEEL OEM CROSS REFERENCE

Original Equipment Manufacturer Part & Trade Mark	Standard Hub Propeller	XHS® / XHS II® Hub Propeller						XHS® / XHS II® Hub Kit(s)	Catalog Page #s
	Michigan Match®	Ballistic®	Ballistic® XL	Vortex® XHS	Apollo® Std.	Apollo® Lg. Dia	Apollo® 4-Blade		

MERCURY®, MARINER®, MERCUISER® (Continued)

48-36008A1		933523		992006	993046	993026	993206	202	26,47
48-36010A1	031026	933521		992005	993045	993025	993205	202	26,47
48-36010A4		933523		992006	993046	993026	993206	202	26,47
48-36012A1	031052	933519		992004	993044	993024	993204	202	26,47
48-36012A4	031026	933521		992005	993045	993025	993205	202	26,47
48-36012A5	031516	933515		992002	993043	993023	993203	202	26,47
48-36014A1	031516	933515		992002	993043	993023	993203	202	26,47
48-36014A4	032052	933519		992004	993044	993024	993204	202	26,47
48-36016A4	031516	933515		992002	993043	993023	993203	202	26,47
48-36018A1	031513			992001				202	26,47
48-36020A1	031513			992001				202	26,47
48-36020A4	031513			992001				202	26,47
48-37902A4	031042	933417		992114	993144			202	25
48-42522A10	032052								20
48-42522A11	032052								20
48-42522A12	032052								20
48-42738A10	Black Max™	032141							24
48-42738A11	Black Max™	032141							24
48-42738A13	Black Max™	032141							24
48-42740A10	Black Max™	032142							24
48-42740A11	Black Max™	032142							24
48-43584A40		031049		992503				120	21
48-43586A40		031048	933015	992505				120	21
48-43590A40				992506				120	21
48-47670A3		032020							20
48-47922A10		032021							20
48-47926A10		032021							20
48-49632A4		031043	933419	992115	993145			202	25
48-49634A4		031052		992004	993044	993024	993204	202	26,47
48-52008A4		031045*							25
48-52012A3		031045*							25
48-53892A3		031043	933419	992115	993145			202	25
48-53896A4		031043	933419	992115	993145			202	25
48-53900A3		031041	933415	992113	993143			202	25
48-58422A4		031052		992004	993044	993024	993204	202	26,47
48-58424A4		031026	933521	992005	993045	993025	993205	202	26,47
48-58426A1		031026	933521	992005	993045	993025	993205	202	26,47
48-58426A4				992006	993046	993026	993206	202	26,47
48-58826A3		031254		992111				202	25
48-58826A4		031055		992112				202	25
48-61812A4		032045		992602				114	23
48-61814A4		032044		992603				114	23
48-61816A4		032043	993213	992604	993405			114	23
48-61818A4		032042		992605	993406			114	23
48-61820A4		032041		992606	993407			114	23
48-61822A4		032040	933215	992408	993408			114	23
48-61824A1				992409				114	23
48-62274A4		032045		992602				114	23
48-63540A1		032040	933215	992408	993408			114	23
48-64724A1		031020							24
48-64724A4		031020							24
48-65022A1		031041		992113	993143			202	25
48-65024A1		031042		992114	993144			202	25
48-65480A1		031027		992006	993046	993026	993206	202	26,47
48-65588A4		031043	933417	992114	993144			202	25
48-65736A4		031045*							25
48-65748A1		031041	933415	992113	993143			202	25
48-65992A4		031026	933521	992005	993045	993025	993205	202	26,47
48-66432A4		031052		992004	993044	993024	993204	202	26,47
48-66450A4		031516		992003	993043	993023	993203	202	26,47
48-67280A1		031043	933419	992115	993145			202	25
48-67874A4		031027		992006	993046		993206	202	26,47
48-68556A4	Cleaver™			992004	993044	993024	993204	202	26,47
48-68557A4	Cleaver™ (LH)				993055	993035	993215	202	26,47
48-68558A4	Cleaver™			992005	993045	993025	993205	202	26,47
48-72764A5	QSS™	031042	933417	992114	993144			202	25
48-73132A40	Black Max™	031015							24
48-73134A40	Black Max™	031016		992405	993405			114	24
48-73136A4	Black Max™	031017	933213	992406	993406			114	24
48-73136A40	Black Max™	031017	933213	992406	993406			114	24
48-73138A4	Black Max™	031018		992407	993407			114	24
48-73138A40	Black Max™	031018		992407	993407			114	24
48-73140A4	Black Max™	031019	933215	992408	993408			114	24

MICHIGAN WHEEL OEM CROSS REFERENCE

Original Equipment Manufacturer Part & Trade Mark	Standard Hub Propeller	XHS® / XHS II® Hub Propeller						XHS® / XHS II® Hub Kit(s)	Catalog Page #s
	Michigan Match®	Ballistic®	Ballistic® XL	Vortex® XHS	Apollo® Std.	Apollo® Lg. Dia	Apollo® 4-Blade		

MERCURY®, MARINER®, MERCURISER® (Continued)

48-73140A40	Black Max™	031019	933215		992408	993408		114	24
48-73142A40	Black Max™				992409			114	24
48-73144A4	Black Max™	031020							24
48-73144A40	Black Max™	031020							24
48-73502A4		031513			992001			202	26,47
48-73504A4		031023	933515		992002	993042		202	26,47
48-73506A4		031024	933517		992003	993043	993023	993203	202
48-73508A4		031025	933519		992004	993044	993024	993204	202
48-73510A4		031026	933521		992005	993045	993025	993205	202
48-73512A4			933523		992006	993046	993026	993206	202
48-73980A4	QSS™	031025	933519		992004	993044	993024	993204	202
48-73980A5	QSS™	031025	933519		992004	993044	993024	993204	202
48-73982A4	QSS™	031026	933521		992005	993045	993025	993205	202
48-73982A5	QSS™	031026	933521		992005	993045	993025	993205	202
48-74266A4	QSS™	031025	933519		992004	993044	993024	993204	202
48-74268A4	QSS™	031026	933521		992005	993045	993025	993205	202
48-74598A4	Cleaver™	031025	933519		992004	993044	993024	993204	202
48-74599A4	Cleaver™ (LH)		937521			993055	993035	993215	202
48-74600A4	Cleaver™	031026	933521		992005	993045	993025	993205	202
48-74601A4	Cleaver™ (LH)		937523			993056	993036	993216	202
48-74872A4		031516			992003	993043	993023	993203	202
48-74874A4		031052			992004	993044	993024	993204	202
48-74876A4		031026	933521		992005	993045	993025	993205	202
48-74886A4		031052			992004	993044	993024	993204	202
48-74888A4		031026	933521		992005	993045	993025	993205	202
48-75058A4	QSS™		933523		992006	993046	993026	993206	202
48-75160A4			933523		992006	993046	993026	993206	202
48-75724A4	QSS™		933523		992006	993046	993026	993206	202
48-75724A5	QSS™		933523		992006	993046	993026	993206	202
48-75760A4		031023	933515		992002	993042			202
48-76230A4	QSS™	031058			992407	993407			114
48-76230A5	Vengeance	031058			992407	993407			114
48-76232A4	QSS™	031019	933215		992408	993408			114
48-76232A5	Vengeance	031019	933215		992408	993408			114
48-77338A4	Black Max™	031254			992111				202
48-77338A33	Black Max™	031254			992111				202
48-77338A40	Black Max™	031254			992111				202
48-77338A45	Black Max™	031254			992111				202
48-77338CP1	Black Max™ Pontoon								941411
48-77340A4	Black Max™	031055			992112				202
48-77340A33	Black Max™	031055			992112				202
48-77340A40	Black Max™	031055			992112				202
48-77340A45	Black Max™	031055			992112				202
48-77340CP1	Black Max™ Pontoon								941413
48-77342A4	Black Max™	031041	933415		992113	993143			202
48-77342A33	Black Max™	031041	933415		992113	993143			202
48-77342A40	Black Max™	031041	933415		992113	993143			202
48-77342A45	Black Max™	031041	933415		992113	993143			202
48-77344A4	Black Max™	031042	933417		992114	993144			202
48-77344A40	Black Max™	031042	933417		992114	993144			202
48-77344A45	Black Max™	031042	933417		992114	993144			202
48-77346A4	Black Max™	031043	933419		992115	993145			202
48-77346A40	Black Max™	031043	933419		992115	993145			202
48-77346A45	Black Max™	031043	933419		992115	993145			202
48-77348A4	Black Max™	031044	933421	953422	992116	993146			202
48-77348A40	Black Max™	031044	933421	953422	992116	993146			202
48-77348A45	Black Max™	031044	933421	953422	992116	993146			202
48-77350A4	Black Max™	031045*							202
48-77350A40	Black Max™	031045*							202
48-77350A45	Black Max™	031045*							202
48-78114A4	Black Max™	031513			992001				202
48-78114A40	Black Max™	031513			992001				202
48-78114A45	Black Max™	031513			992001				202
48-78116A4	Black Max™	031023	933515		992002	993042			202
48-78116A40	Black Max™	031023	933515		992002	993042			202
48-78116A45	Black Max™	031023	933515		992002	993042			202
48-78118A4	Black Max™	031024	933517		992003	993043	993023	993203	202
48-78118A40	Black Max™	031024	933517		992003	993043	993023	993203	202
48-78118A45	Black Max™	031024	933517		992003	993043	993023	993203	202
48-78120A4	Black Max™	031025	933519		992004	993044	993024	993204	202
48-78120A40	Black Max™	031025	933519		992004	993044	993024	993204	202
48-78120A45	Black Max™	031025	933519		992004	993044	993024	993204	202
48-78122A4	Black Max™	031026	933521	953522	992005	993045	993025	993205	202

* Indicates limited quantities.

MICHIGAN WHEEL OEM CROSS REFERENCE

Original Equipment Manufacturer Part & Trade Mark		Standard Hub Propeller	XHS® / XHS II® Hub Propeller					XHS® / XHS II® Hub Kit(s)	Catalog Page #s	
		Michigan Match®	Ballistic®	Ballistic® XL	Vortex® XHS	Apollo® Std.	Apollo® Lg. Dia			Apollo® 4-Blade
MERCURY®, MARINER®, MERCURUISER® (Continued)										
48-78122A40	Black Max™	031026	933521	953522	992005	993045	993025	993205	202	26,47
48-78122A45	Black Max™	031026	933521	953522	992005	993045	993025	993205	202	26,47
48-78124A4	Black Max™		933523	953524	992006	993046	993026	993206	202	26,47
48-78124A40	Black Max™		933523	953524	992006	993046	993026	993206	202	26,47
48-78124A45	Black Max™		933523	953524	992006	993046	993026	993206	202	26,47
48-78126A4	Black Max™		933525	953526					202	26,47
48-78126A40	Black Max™		933525	953526					202	26,47
48-78126A45	Black Max™		933525	953526					202	26,47
48-79572A4	Black Max™	031516	933517		992003	993043	993023	993203	202	26,47
48-79574A4	Black Max™	031025	933519		992004	993044	993024	993204	202	26,47
48-79576A4	Black Max™	031026	933521		992005	993045	993025	993205	202	26,47
48-79578A4	Black Max™		933523		992006	993046	993026	993206	202	26,47
48-79792A4	QSS™	031016			992405	993405			114	24
48-79792A5	Vengeance	031016			992405	993405			114	24
48-79794A4	QSS™	031024			992003	993043	993023	993203	202	26,47
48-79794A5	QSS™	031024			992003	993043	993023	993203	202	26,47
48-71645M		022002								22
48-812950A02		032055								20
48-81647M		022001								22
48-81649M		022002								20
48-816702A40	Black Max™	031056			992405	993405			114	24
48-816704A40	Black Max™	031057	933213		992406	993406			114	24
48-816706A40	Black Max™	031058			992407	993407			114	24
48-825860A47		031025	933519		992004	993044	993024	993204	202	26,47
48-825861A47	Tempest Plus (LH)		937519		993054	993034	993214	993214	202	26,47
48-825862A47	Tempest Plus	031026	933521		992005	993045	993025	993205	202	26,47
48-825863A47	Tempest Plus (LH)		937521		993055	993035	993215	993215	202	26,47
48-825864A47	Tempest Plus		933523		992006	993046	993026	993206	202	26,47
48-825865A47	Tempest Plus (LH)		937523		993056	993036	993216	993216	202	26,47
48-825866A47	Tempest Plus		933525						202	26,47
48-825872A47	Tempest Plus			953524					202	26,47
48-825874A47	Tempest Plus			953526					202	26,47
48-825898A48	VenSura® 4				992202			993203	202	26,47
48-825899A48	VenSura® 4 (LH)							993213	202	26,47
48-825900A48	VenSura® 4				992203			993204	202	26,47
48-825901A48	VenSura® 4 (LH)							993214	202	26,47
48-825902A48	VenSura® 4				992204			993205	202	26,47
48-825903A48	VenSura® 4 (LH)							993215	202	26,47
48-825906A48	VenSura® 4							993206	202	26,47
48-825907A48	VenSura® 4 (LH)							993216	202	26,47
48-825938A47	Trophy Plus 4			963523					202	26
48-825942A47	Trophy Plus 4			963525					202	26
48-825946A47	Trophy Plus 4			963527					202	26
48-827312A11	Black Max™	032142								24
48-82767		012102								22
48-82768		012011								22
48-828152A12	Black Max™	032056								20
48-828154A12	Black Max™	032053								20
48-828156A12	Black Max™	032052								20
48-828158A12	Black Max™	032050								20
48-82826		022003								22
48-832828A45	Black Max™	031064	933517		992003	993043	993023	993203	202	26,47
48-832830A45	Black Max™	031065	933519		992004	993044	993024	993204	202	26,47
48-832832A45	Black Max™	031066	933521		992005	993045	993025	993205	202	26,47
48-832834A45	Black Max™		933523		992006	993046	993026	993206	202	26,47
48-834850A45	Alpha 4®				992202			993203	202	26,47
48-834851A45	Alpha 4® (LH)							993213	202	26,47
48-834852A45	Alpha 4®				992203			993204	202	26,47
48-834853A45	Alpha 4® (LH)							993214	202	26,47
48-834854A45	Alpha 4®				992204			993205	202	26,47
48-834855A45	Alpha 4® (LH)							993215	202	26,47
48-854342A45		031061			992111				202	25
48-854354A46	Vengeance	031041	933415		992113	993143			202	25
48-855856A5	Vengeance				992405	993405			114	24
48-855858A5	Vengeance		933213		992406	993406			114	24
48-855860A5	Vengeance					993407			114	24
48-855862A5	Vengeance		933215			993408			114	24
48-85632A4	Black Max™	031053			992404				114	24
48-85632A40	Black Max™	031053			992404				114	24
48-86848A4		031048								21
48-86962A4		032136								21
48-88438A4	QSS™					993043		993203	202	26,47
48-88440A4	QSS™					993044		993204	202	26,47

* Indicates limited quantities.

MICHIGAN WHEEL OEM CROSS REFERENCE

Original Equipment Manufacturer Part & Trade Mark	Standard Hub Propeller	XHS® / XHS II® Hub Propeller						XHS® / XHS II® Hub Kit(s)	Catalog Page #s
	Michigan Match®	Ballistic®	Ballistic® XL	Vortex® XHS	Apollo® Std.	Apollo® Lg. Dia	Apollo® 4-Blade		

MERCURY®, MARINER®, MERCURISER® (Continued)

48-88442A4	QSS™				993045		993205	202	26,47
48-88444A4	QSS™				993046		993206	202	26,47
48-896890A10	Black Max™	141304							22
48-896892A40	Black Max™			992501				122	22
48-896896A40	Black Max™			992503				122	22
48-897618A10	Black Max™	142203							21
48-897748A11		142203							21
48-897750A11		142204							21
48-897752A11		142205							21
48-897754A11		142206							21
48-89852A4		031049		992503				120	21
48-89854A4				992506				120	21
48-898990A46	Enertia®	031023	933515	992002	993042			202	26,47
48-898991A46	Enertia® (LH)				993052			202	26,47
48-898994A46	Enertia®	031024	933517	992003	993043	993023	993203	202	26,47
48-898995A46	Enertia® (LH)		937517		993053	993033	993213	202	26,47
48-898998A46	Enertia®	031025	933519	992004	993044	993024	993204	202	26,47
48-898999A46	Enertia® (LH)		937519		993054	993034	993214	202	26,47
48-899002A46	Enertia®	031026	933521	992005	993045	993025	993205	202	26,47
48-899003A46	Enertia® (LH)		937521		993055	993035	993215	202	26,47
48-899004A46	Laser II™	031043	933419	992115	993145			202	25
48-899006A46	Laser II™	031044	933421	992116	993146			202	25
48-90159A46			937517		993053	993033	993213	202	26,47
48-93272A4	QSS™	031023	933515	992002	993042			202	26,47
48-93272A5	QSS™	031023	933515	992002	993042			202	26,47
48-96623M		012013							22
48-96625M		012011							22
48-96628M		012102							22
8M8026560	SpitFire®			941411				202	25
8M8026570	SpitFire®			941413				202	25
8M8026580	SpitFire®			941415				202	25
8M8026590	SpitFire®			941417				202	25
8M8026600	SpitFire®			941419				202	25
QA1912X	Black Diamond®	031064	933517	992003	993043	993023	993203	202	26,47
QA1916X	Black Diamond®	031065	933519	992004	993044	993024	993204	202	26,47
QA1918X	Black Diamond®	031066	933521	992005	993045	993025	993205	202	26,47
QA1920X	Black Diamond®		933523	992006	993046	993026	993206	202	26,47
QA2004X	Black Diamond®	031513							24,41
QA2006X	Black Diamond®	031050	933515	992002	993042			202	26,47
QA2008X	Black Diamond®	031023	933515	992002	993042			202	26,47
QA2010X	Black Diamond®	031516	933517	992003	993043	993023	993203	202	26,47
QA2012X	Black Diamond®	031024	933517	992003	993043	993023	993203	202	26,47
QA2014X	Black Diamond®	031052	933519	992004	993044	993024	993204	202	26,47
QA2016X	Black Diamond®	031025	933519	992004	993044	993024	993204	202	26,47
QA2018X	Black Diamond®	031026	933521	992005	993045	993025	993205	202	26,47
QA2022X	Black Diamond®		933525						24,41
QA2028X	Black Diamond®	031043	933419	992115	993145			202	25
QA2030X	Black Diamond®	031254		992111				202	25
QA2032X	Black Diamond®	031055		992112				202	25
QA2034X	Black Diamond®	031041	933415	992113	993143			202	25
QA2036X	Black Diamond®	031042	933417	992114	993144			202	25
QA2038X	Black Diamond®	031043	933419	992115	993145			202	25
QA2040X	Black Diamond®	031044	933421	992116	993146			202	25
QA2042X	Black Diamond®	031045*							25
QA2060R	Black Diamond®	032141							24
QA2064R	Black Diamond®	032044		992404				114	23
QA2064R	Black Diamond®	031015		992404				114	23
QA2066R	Black Diamond®	032142							24
QA2070R	Black Diamond®	031053		992404				114	24
QA2072R	Black Diamond®	031056		992405	993405			114	24
QA2074R	Black Diamond®	031016		992405	993405			114	24
QA2078R	Black Diamond®	032043		992405	993405			114	23
QA2078R	Black Diamond®	031017	933213	992406	993406			114	24
QA2078R	Black Diamond®	032042	993213	992406	993406			114	23
QA2080R	Black Diamond®	031058		992407	993407			114	24
QA2082R	Black Diamond®	031018	933215	992407	993407			114	24
QA2082R	Black Diamond®	032041		992407	993407			114	23
QA2084R	Black Diamond®	031019	933215	992408	993408			114	24
QA2084R	Black Diamond®	032040	933215	992408	993408			114	23
QA2088R	Black Diamond®	031020							24
QA2102R	Black Diamond®	031049		992503				120	21
QA2106R	Black Diamond®	031048	933013	992505				120	21
QA2108R	Black Diamond®		933015	992506				120	21

* Indicates limited quantities.

MICHIGAN WHEEL OEM CROSS REFERENCE

Original Equipment Manufacturer Part & Trade Mark	Standard Hub Propeller	XHS® / XHS II® Hub Propeller						XHS® / XHS II® Hub Kit(s)	Catalog Page #s
	Michigan Match®	Ballistic®	Ballistic® XL	Vortex® XHS	Apollo® Std.	Apollo® Lg. Dia	Apollo® 4-Blade		

MERCURY®, MARINER®, MERCUISER® (Continued)

QA2124R	Black Diamond®	032056							20	
QA2128R	Black Diamond®	032052							20	
QA2130R	Black Diamond®	032050							20	
QA2158R	Black Diamond®	142203							21	
QA2182X	Diamond 4			992202			993203	202	26,47	
QA2183X	Diamond 4 (LH)						993213	202	26,47	
QA2184X	Diamond 4			992203			993204	202	26,47	
QA2185X	Diamond 4 (LH)						993214	202	26,47	
QA2186X	Diamond 4			992204			993205	202	26,47	
QA2187X	Diamond 4 (LH)						993215	202	26,47	
QA2190R	Black Diamond®	141304							22	
QA2226R	Black Diamond®	032044		992603	993405			114	23	
QA2230R	Black Diamond®	032042	993213	992605	993406			114	23	
QA2232R	Black Diamond®	032041		992606	993407			114	23	
QA2234R	Black Diamond®	032040	933215	992408	993408			114	23	
QA2830X	Black Diamond®			941411				202	25	
QA2832X	Black Diamond®			941413				202	25	
QA3150R	Black Diamond®	012011							22	
QA3808R	Black Diamond®	022002							22	
QA3812R	Black Diamond®	022003							22	
QA6004	QA3	031513		992001				202	26,47	
QA6010	QA3	031516		931516				202	26,47	
QA6012	QA3	031024	933517	992003	993043	993023	993203	202	26,47	
QA6016	QA3	031025	933519	992004	993044	993024	993204	202	26,47	
QA6018	QA3	031026	933521	992005	993045	993025	993205	202	26,47	
QA6020	QA3		933523	992006	993046	993026	993206	202	26,47	
QA6030	QA3	031254		992111				202	25	
QA6032	QA3	031055		992112				202	25	
QA6034	QA3	031041		992113	993143			202	25	
QA6036	QA3	031042		992114	993144			202	25	
QA6038	QA3	031043		992115	993145			202	25	
QA6040	QA3	031044		992116	993146			202	25	
QA6042	QA3	031045*							25	
QA6060T	QA3	032141							24	
QA6064T	QA3	031015							24	
QA6070T	QA3	031053		992404				114	24	
QA6074T	QA3	031016		992405	993405			114	24	
QA6078T	QA3	031017		992406	993406			114	24	
QA6082T	QA3	031018		992407	993407			114	24	
QA6084T	QA3	031019		992408	993408			114	24	
QA6102T	QA3	031049		992503				120	21	
QA6106T	QA3	031048	933013	992505				120	21	
QA6128T	QA3	032021							20	
QS5004X	Thunderbolt	031064	933517	992003	993043	993023	993203	202	26,47	
QS5005X	Thunderbolt (LH)		937517		993053	993033	993213	202	26,47	
QS5006X	Thunderbolt	031065	933519	992004	993044	993024	993204	202	26,47	
QS5007X	Thunderbolt (LH)		937519		993054	993034	993214	202	26,47	
QS5008X	Thunderbolt	031066	933521	992005	993045	993025	993205	202	26,47	
QS5009X	Thunderbolt (LH)		937521		993055	993035	993215	202	26,47	
QS5010X	Thunderbolt		933523	992006	993046	993026	993206	202	26,47	
QS5011X	Thunderbolt (LH)		937523		993056	993036	993216	202	26,47	
QS5050X	Silverado	031023	933515	992002	993042			202	26,47	
QS5052X	Silverado	031024	933517	992003	993043	993023	993203	202	26,47	
QS5053X	Silverado (LH)		937517		993053	993033	993213	202	26,47	
QS5054X	Silverado	031025	933519	992004	993044	993024	993204	202	26,47	
QS5055X	Silverado (LH)		937519		993054	993034	993214	202	26,47	
QS5056X	Silverado	031026	933521	992005	993045	993025	993205	202	26,47	
QS5057X	Silverado (LH)		937521		993055	993035	993215	202	26,47	
QS5058X	Silverado		933523	992006	993046	993026	993206	202	26,47	
QS5059X	Silverado (LH)		937523		993056	993036	993216	202	26,47	
QS5070X	Lightspeed	031025	933519	992004	993044	993024	993204	202	26,47	
QS5071X	Lightspeed (LH)		937519		993054	993034	993214	202	26,47	
QS5072X	Lightspeed	031016	933521	992005	993045	993025	993205	202	26,47	
QS5073X	Lightspeed (LH)		937521		993055	993035	993215	202	26,47	
QS5074X	Lightspeed		933523	953422	992006	993046	993026	993206	202	26,47
QS5075X	Lightspeed (LH)		937523		993056	993036	993216	202	26,47	
QS5116X	Silverado	031041	933415	992113	993143			202	25	
QS6004X	Typhoon® 4						993204	202	26,47	
QS5118X	Silverado	031042	933417	992114	993144			202	25	
QS5120X	Silverado	031043	933419	992115	993145			202	25	
QS5122X	Silverado	031044	933421	992116	993146			202	25	
QS5124X	Silverado		953424					202	25	
QS5164R	Silverado	031056		992405	993405			114	24	

* Indicates limited quantities.

MICHIGAN WHEEL OEM CROSS REFERENCE

Original Equipment Manufacturer Part & Trade Mark	Standard Hub Propeller	XHS® / XHS II® Hub Propeller						XHS® / XHS II® Hub Kit(s)	Catalog Page #s
	Michigan Match®	Ballistic®	Ballistic® XL	Vortex® XHS	Apollo® Std.	Apollo® Lg. Dia	Apollo® 4-Blade		

MERCURY®, MARINER®, MERCURISER® (Continued)

QS5166R	Silverado	031057	933213		992406	993406		114	24
QS5168R	Silverado	031058	933215		992407	993407		114	24
QS5170R	Silverado	031058	933215		992408	993407		114	24
QS5180R	Silverado	031048	933013		992505			120	21
QS5862X	Torrent	031066	345143		992005	993045	993025	993205	202 26,47
QS5864X	Torrent		933523		992006	993046	993026	993206	202 26,47
QS6003X	Typhoon® 4 (LH)							993214	202 26,47
QS6005X	Typhoon® 4 (LH)							993215	202 26,47
QS6006X	Typhoon® 4							993205	202 26,47
TA1916X	Black Diamond® XT	031065	933519		992004	993044	993024	993204	202 26,47
TA1918X	Black Diamond® XT	031066	933521		992005	993045	993025	993205	202 26,47
TA1920X	Black Diamond® XT		933523		992006	993046	993026	993206	202 26,47
TA2004X	Black Diamond®	031513			992001				202 26,47
TA2008	Black Diamond®	031023			992002	993042			202 26,47
TA2010	Black Diamond®	031516			992003	993043	993023	993203	202 26,47
TA2012	Black Diamond®	031024			992003	993043	993023	993203	202 26,47
TA2014	Black Diamond®	031052			992004	993044	993024	993204	202 26,47
TA2016	Black Diamond®	031025			992004	993044	993024	993204	202 26,47
TA2018	Black Diamond®	031026			992005	993045	993025	993205	202 26,47
TA2020	Black Diamond®				992006	993046	993026	993206	202 26,47
TA2030X	Black Diamond®	031254			992111				202 25
TA2032X	Black Diamond®	031055			992112				202 25
TA2034	Black Diamond®	031041	933415		992113	993143			202 25
TA2036	Black Diamond®	031042	933417		992115	993144			202 25
TA2038	Black Diamond®	031043	933419		992115	993145			202 25
TA2040	Black Diamond®	031044	933421		992116	993146			202 25
TA2048	Black Diamond®	031041	933415		992113	993143			202 25
TA2050	Black Diamond®	031042	933417		992114	993144			202 25
TA2052	Black Diamond®	031043	933419		992115	993145			202 25
TA2054	Black Diamond®	031044	933421		992116	993146			202 25
TA2060T	Black Diamond®	032141							202 24
TA2064T	Black Diamond®	031015							202 24
TA2066T	Black Diamond®	032142							202 24
TA2070T	Black Diamond®	031053			992404			114	24
TA2072T	Black Diamond®	031056			992405	993405		114	24
TA2074T	Black Diamond®	031016			992405	993405		114	24
TA2076T	Black Diamond®	031057	933213		992406	993406		114	24
TA2078T	Black Diamond®	031017	933213		992406	993406		114	24
TA2080T	Black Diamond®	031058			992407	993407		114	24
TA2082T	Black Diamond®	031018			992407	993407		114	24
TA2084T	Black Diamond®	031019	933215		992408	993408		114	24
TA2088T	Black Diamond®	031513			992001			202	26,47
TA2106T	Black Diamond®	031048			992505			120	21
TA2128T	Black Diamond®	032052							202 20
TA2202	Black Diamond®	031044	933421		992116	993146		202	25
TA2204	Black Diamond®	031043	933419		992115	993145		202	25
TA2206	Black Diamond®	031042	933417		992114	993144		202	25
TA2208	Black Diamond®	031041	933415		992113	993143		202	25
TA3150T	Black Diamond®	012011							202 22
TA3152T	Black Diamond®	012013							202 22
TA3808T	Black Diamond®	022002							202 22
TS1006	Thunderbolt				992004	993044	993024	993204	202 26,47
TS1007	Thunderbolt (LH)					993054	993034	993214	202 26,47
TS1008	Thunderbolt				992005	993045	993025	993205	202 26,47
TS1009	Thunderbolt (LH)					993055	993035	993215	202 26,47
TS1010	Thunderbolt				992006	993046	993026	993206	202 26,47
TS1011	Thunderbolt (LH)					993056	993036	993216	202 26,47
TS1052	Silverado	031064	933517		992003	993043	993023	993203	202 26,47
TS1053	Silverado (LH)		937517			993053	993033	993213	202 26,47
TS1054	Silverado	031065	933519		992004	993044	993024	993204	202 26,47
TS1055	Silverado (LH)		937519			993054	993034	993214	202 26,47
TS1056	Silverado	031066	933521		992005	993045	993025	993205	202 26,47
TS1057	Silverado (LH)		937521			993055	993035	993215	202 26,47
TS1070	Lightspeed	031065	933519		992004	993044	993024	993204	202 26,47
TS1071	Lightspeed (LH)		937519			993054	993034	993214	202 26,47
TS1072	Lightspeed	031066	933521		992005	993045	993025	993205	202 26,47
TS1073	Lightspeed (LH)		937521			993055	993035	993215	202 26,47
TS1074	Lightspeed		933523		992006	993046	993026	993206	202 26,47
TS1075	Lightspeed (LH)		937523			993056	993036	993216	202 26,47
TS1116	Silverado	031041	933415		992113	993143		202	25
TS1118	Silverado	031042	933417		992114	993144		202	25
TS1120	Lightspeed	031043	933419		992115	993145		202	25
TS1122	Lightspeed	031044	933421		992116	993146		202	25

MICHIGAN WHEEL OEM CROSS REFERENCE

Original Equipment Manufacturer Part & Trade Mark	Standard Hub Propeller	XHS® / XHS II® Hub Propeller						XHS® / XHS II® Hub Kit(s)	Catalog Page #s
	Michigan Match®	Ballistic®	Ballistic® XL	Vortex® XHS	Apollo® Std.	Apollo® Lg. Dia	Apollo® 4-Blade		

MERCURY®, MARINER®, MERCUISER® (Continued)

TS1164T	Silverado	031016		992305	993405			114	24
TS1166T	Silverado	031017	933213	992406	993406			114	24
TS1168T	Silverado	031058		992407	993407			114	24

NISSAN®, TOHATSU®

345641015		141304		992501				122	28
346641015M		141304		992501				122	28
346641025M		141307		992502				122	28
346641035		141305		992503				122	28
346641035M		141305		992503				122	28
346641045M		141306		992505				122	28
346641055				992506				122	28
346641055M				992506				122	28
346641065		141304							28
346B641065		141304							28
346W641055				992506				122	28
346W641065		141304							28
348641020		142406		992605	993406			116	29
348641030		142410		992606	993407			116	29
348641040		142409		992604	993405			116	29
348641080				992401				112	29
348W641080				992401				116	29
349B645291		142309							28
353641010				992401				112	29
353641020				992402				112	29
353641030				992403				112	29
353641050				992301				112	29
353641050M				992301				112	29
353641070				992302				112	29
353641070M				992302				112	29
353641080		142008*							29
353641090				992303				112	29
353641090M				992303				112	29
361641020		142406		992605	993406			116	29
361641030		142410		992606	993407			116	29
361641130		142405		992603				116	29
361641140		142002		992604	993405			116	29
362B641010		142204							28
362B641080		142205							28
362641010M		142204							28
362641020		142203							28
362641020M		142203							28
362641080M		142205							28
362W641020		142203							28
3BAB645161		142203							28
3B2B645140		142102							28
3B2B645151		142103							28
3B7645270				992112				209	31
3B7645320		142215	933415	992113	993143			209	31
3B7645360		142215	933415	992113	993143			209	31
3B7645410		142217	933417	992114	993144			209	31
3B7645450		142219	933419	992115	993145			209	31
3B7645490		142221	933421					209	31
3C7645140		142217	933417	992114	993144			209	31
3C7645360		142217	933417	992114	993144			209	31
3C7645360M		142215	933415	992113	993143			209	31
3C7645490M		142219	933419	992115	993145			209	31
3C7645540M		142221	933421	992116	993146			209	31
3C7764510M		142217	933417	992114	993144			209	31
3E0641810M				992112				209	31
3E0641850M		142215	933415	992113	993143			209	31
3E0641890M		142217	933417	992114	993144			209	31
3E0641940M		142219	933419	992115	993145			209	31
3E0641960M		142221	933421	992116	993146			209	31
3E3645260M		142409		992604	993405			116	29
3E3645280M		142406		992605	993406			116	29
3E3645310M		142410		992606	993407			116	29
3E3645360M				992408	993408			116	29
3N4B645271		142213							31
3N4B645321		142215							31
3N4B645361		142217							31
3N4B645411		142219							31
3N4B645451		142221							31

* Indicates limited quantities.

MICHIGAN WHEEL OEM CROSS REFERENCE

Original Equipment Manufacturer Part & Trade Mark	Standard Hub Propeller	XHS® / XHS II® Hub Propeller						XHS® / XHS II® Hub Kit(s)	Catalog Page #s
	Michigan Match®	Ballistic®	Ballistic® XL	Vortex® XHS	Apollo® Std.	Apollo® Lg. Dia	Apollo® 4-Blade		

NISSAN®, TOHATSU® (Continued)

3N4W645271	142213							209	31
3N4W645321	142215	933415			992113	993143		209	31
3N4W645361	142217	933417			992114	993144		209	31
3N4W645411	142219	933419			992115	993145		209	31
3N4W645451	142221	933421			992116	993146		209	31
3R0645250M	141308				992504			122	28
3R0B645180	141304				992501			122	28
3R0B645210	141307								28
3R0B645230	141305				992503			122	28
3R0B645250	141308								28
3R0B645270	141306				992505			122	28
3R0W645210	141307				992502			122	28
3R0W645230	141305				992503			122	28
3R0W645250	141308				992504			122	28
3R0W645270	141306				992505			122	28
3R0W645480	141304				992501			122	28
3T5B645180	142407								29
3T5B645230	142405								29
3T5B645250	142409								29
3T5B645270	142406								29
3T5B645290	142410								29
3T5B645320	142405				992603			116	29
3T5645230	142405				992603			116	29
3T5645250	142409				992604	993405		116	29
3T5645270	142406				992605	993406		116	29
3T5645290	142410				992606	993407		116	29
3T5645320					992408	993408		116	29
9999RUBA313M	Solas® Rubex®	142213			992112			209	31
9999RUBA315M	Solas® Rubex®	142215			992113	993143		209	31
9999RUBA317M	Solas® Rubex®	142217			992114	993144		209	31
9999RUBA319M	Solas® Rubex®	142219			992115	993145		209	31
9999RUBA321M	Solas® Rubex®	142221			992116	993146		209	31
9999RUBE315M	Solas® Rubex®				992002			207	32
9999RUBE317M	Solas® Rubex®				992003			207	32
9999RUBE319M	Solas® Rubex®				992004			207	32
9999RUBE321M	Solas® Rubex®				992005			207	32
9999RUBH309M	Solas® Rubex®				992601			116	29
9999RUBH310M	Solas® Rubex®				992602			116	29
9999RUBH311M	Solas® Rubex®				992603			116	29
9999RUBH312M	Solas® Rubex®				992604			116	29
9999RUBH313M	Solas® Rubex®				992605			116	29
9999RUBH314M	Solas® Rubex®				992606			116	29
NM889210130		933013						122	28
NM889410120	142409				992604	993405		116	29
NM889410130	142406				992605	993406		116	29
NM889410140	142410				992606	993407		116	29
NM889410150					992408	993408		116	29
NM889510150		933315						112	29
NM889510170		933317						112	29
NM889610150	142215	933415			992113	993143		209	31
NM889610170	142217	933417			992114	993144		209	31
NM889610180	142219	933419			992115	993145		209	31
NM889610200	142221	933421			992116	993146		209	31
PTOFS3R17P						993023		207	32
PTPTZ3R17P						993043		207	32
PTPTZ3L19P						993054		207	32
PTPTZ3R19P						993044		207	32
PTPTZ3L21P						993055		207	32
PTPTZ3R21P						993045		207	32

SUZUKI®

58100-87L00-019					992112			See Note 4	36
58100-87L10-019	061020				992113	993143		See Note 4	36
58100-87L20-019	061024				992114	993144		See Note 4	36
58100-85L30-019	061028				992115	993145		See Note 4	36
58100-87L40-019	061032				992116	993146		See Note 4	36
58100-88L01-019	DF40A/50A/60A/40/50	032046			992601			115	34
58100-88L10-019	DF40A/50A/60A/40/50	032045			992602			115	34
58100-88L21-019	DF40A/50A/60A/40/50	062211			992603			115	34
58100-88L31-019	DF40A/50A/60A/40/50	062212			992604			115	34
58100-88L41-019	DF40A/50A/60A/40/50	062213			992605			115	34
58100-88L51-019	DF40A/50A/60A/40/50	062214			992606			115	34

* Indicates limited quantities.

MICHIGAN WHEEL OEM CROSS REFERENCE

Original Equipment Manufacturer Part & Trade Mark	Standard Hub Propeller	XHS® / XHS II® Hub Propeller						XHS® / XHS II® Hub Kit(s)	Catalog Page #s
	Michigan Match®	Ballistic®	Ballistic® XL	Vortex® XHS	Apollo® Std.	Apollo® Lg. Dia	Apollo® 4-Blade		

SUZUKI® (Continued)

58100-88L61-019	DF40A/50A/60A/40/50	062215							34	
58100-88L71-019		062216							34	
58100-88L81-019		062217							34	
58100-90420-019		061032			992116	993146		See Note 4	36	
58100-90J00-019		061024			992114	993144		See Note 4	36	
58100-90J01-019		061024			992114	993144		See Note 4	36	
58100-90J10-019		061028			992115	993145		See Note 4	36	
58100-90J11-019		061028			992115	993145		See Note 4	36	
58100-90J20-019		061032			992116	993146		See Note 4	36	
58100-90J21-019		061032			992116	993146		See Note 4	36	
58100-90J41-019		061020			992113	993143		See Note 4	36	
58100-90L50-019		062103							33	
58100-93723-019		062103							33	
58100-93733-019		062104							33	
58100-93743-019		062105							33	
58100-93763-019		062103							33	
58100-93773-019		062104							33	
58100-94J00-019		062103							33	
58100-94313-019		062213	993213		992605	993406		115	34	
58100-94410					992606	993407		115	34	
58100-94411					992606	993407		115	34	
58100-94412					992606	993407		115	34	
58100-94500-019		061101			992113	993143		210	35	
58100-94512-019		061102			992114	993144		210	35	
58100-94522-019		061103			992115	993145		210	35	
58100-94532-019		061104			992116	993146		210	35	
58100-94554		061101			992113	993143		210	35	
58100-94561		061103			992115	993145		210	35	
58100-94571		061104			992116	993146		210	35	
58100-94581		061102			992114	993144		210	35	
58100-95212-019		032045			992602			115	34	
58100-95222-019		062211			992603			115	34	
58100-95353-019		062214			992606	993406		115	34	
58100-95363-019		062215	993213		992408	993407		115	34	
58100-95373-019					992409	993408		115	34	
58100-95382-019			993215					115	34	
58100-95393-019		062212			992604	993405		115	34	
58100-95500-019		061101			992113	993143		210	35	
58100-95511-019		061102			992114	993144		210	35	
58100-95521-019		061103			992115	993145		210	35	
58100-95530-019		061104			992116	993146		210	35	
58100-95D00-019					992506			121	33	
58100-95D01-019		062209							33	
58100-96370-019					992501			121	33	
58100-96371-019		062208							33	
58100-96410-019		062204			992502			121	33	
58100-96420-019		062205			992503			121	33	
58100-96421-019		062205							33	
58100-96430-019		062206			992504			121	33	
58100-96440-019		062207	993013		992505			121	33	
58100-96460-019			993015					121	33	
58100-96461-019		062210							33	
58100-96470-019		062204			992502			121	33	
58100-96471-019		062204			992502			121	33	
58100-96480-019		062206			992504			121	33	
58100-96481-019		062206			992504			121	33	
58100-96490-019		062207	993013		992505			121	33	
58100-96491-019		062207	993013		992505			121	33	
58100-99E00-019		061105			992112			210	35	
58100-99E10-019		061107			992111			210	35	
58200-96400		062207	993013		992505			121	33	
990C0-00830-17P			993517		992003	993043	993023	993203	204	37
990C0-00830-19P			993519		992004	993044	993024	993204	204	37
990C0-00830-21P			993521		992005	993045	993025	993205	204	37
990C0-00830-23P			993523		992006	993046	993026	993206	204	37
990C0-0083L-17P							993033	993213	204	37
990C0-0083L-19P							993034	993214	204	37
990C0-0083L-21P							993035	993215	204	37
990C0-0083L-23P							993036	993216	204	37
99105-00100-16P		061101			992113	993143		210	35	
99105-00100-18P		061102			992114	993144		210	35	
99105-00100-20P		061103			992115	993145		210	35	
99105-00100-22P		061104			992116	993146		210	35	

MICHIGAN WHEEL OEM CROSS REFERENCE

Original Equipment Manufacturer Part & Trade Mark	Standard Hub Propeller	XHS® / XHS II® Hub Propeller						XHS® / XHS II® Hub Kit(s)	Catalog Page #s
	Michigan Match®	Ballistic®	Ballistic® XL	Vortex® XHS	Apollo® Std.	Apollo® Lg. Dia	Apollo® 4-Blade		

SUZUKI® (Continued)

99105-00101-20P	061103							210	35
99105-00101-22P	061104							210	35
99105-00103-18P	061102							210	35
99105-00103-20P	061103							210	35
99105-00103-22P	061104							210	35
99105-00200-16P								204	34
99105-00200-18P								204	34
99105-00200-20P		933519						204	37
99105-00200-22P		933521						204	37
99105-00200-24P		933523						204	37
99105-00203-23P		933523						204	37
99105-0020L-16P								204	37
99105-0020L-18P		937517						204	37
99105-0020L-20P		937519						204	37
99105-0020L-22P		937521						204	37
99105-0020L-24P		937523						204	37
99105-00300-24P		933523						204	37
99105-00400-23P		933523						204	37
99105-00500-12P								115	34
99105-00500-13P		993213						115	34
99105-00500-14P								115	34
99105-00500-15P		933215						115	34
99105-00600-13P		933013						121	33
99105-00600-15P		933015						121	33
99105-00700-16P								See Note 4	36
99105-00700-18P								See Note 4	36
99105-00700-20P								See Note 4	36
99105-0070L-18P								See Note 4	36
99105-0070L-20P								See Note 4	36

VOLVO®

3587517	SS 4-Blade Polished							205	51
3587520	SS 4-Blade Polished							993203	205
3587521	SS 4-Blade Polished (LH)							993213	205
3587522	SS 4-Blade Polished							993204	205
3587523	SS 4-Blade Polished (LH)							993214	205
3587524	SS 4-Blade Polished							993205	205
3587525	SS 4-Blade Polished (LH)							993215	205
3587526	SS 4-Blade Polished							993206	205
3817466	Aluminum 3-Blade	161001						992002	205
3817467	Aluminum 3-Blade	161002						992003	205
3817468	Aluminum 3-Blade	161003						992004	205
3817469	Aluminum 3-Blade	161004						992005	205
3817470	Aluminum 3-Blade	191005						992006	205
3840720								992001	205
3850299		161001						992002	993042
3850300		161002	933517					992003	993043
3850301		161003	933519					992004	993044
3850302		161004	933521					992005	993045
3850303		161005	933523					992006	993046
3850305	SST®	161001	933515					992002	993042
3850306	SST®	161002	933517					992003	993043
3850307	SST®	161002	933517					992003	993043
3850308	SST®	161003	933519					992004	993044
3850309	SST®	161004	933521					992005	993045
3850310	SST®	161005	933523					992006	993046
3850311	VIPER™	161002	933517					992003	993043
3850312	VIPER™	161003	933519					992004	993044
3850313	VIPER™	161004	933521					992005	993045
3850314	VIPER™	161005	933523					992006	993046
3850315	SST® (LH)							993052	993032
3850316	SST® (LH)		937517					993053	993033
3850317	SST® (LH)		937519					993054	993034
3850318	SST® (LH)		937521					993055	993035
3850319	SST® (LH)		937523					993056	993036
3850320	VIPER™ (LH)		937517					993053	993033
3850321	VIPER™ (LH)		937519					993054	993034
3850322	VIPER™ (LH)		937521					993055	993035
3850323	VIPER™ (LH)		937523					993056	993036
3855142	Raker®	161003	933521					992004	993044
3855144	Raker®	161004	933523					992005	993045
3855146	Raker®	161005	346036					992006	993046
3855152	Raker® (LH)		937521					993054	993034
3855154	Raker® (LH)		937523					993055	993035

* Indicates limited quantities.

MICHIGAN WHEEL OEM CROSS REFERENCE

Original Equipment Manufacturer Part & Trade Mark	Standard Hub Propeller	XHS® / XHS II® Hub Propeller						XHS® / XHS II® Hub Kit(s)	Catalog Page #s
	Michigan Match®	Ballistic®	Ballistic® XL	Vortex® XHS	Apollo® Std.	Apollo® Lg. Dia	Apollo® 4-Blade		

VOLVO® (Continued)

3855156.....	Raker® (LH).....				993056	993036	993216	205	51
3855481.....			937519		993054			205	51
3860708.....	SS 3-Blade Polished.....	161003	933519		992004	993044	993024	993204	205
3860709.....	SS 3-Blade Polished.....	161004	933521		992005	993045	993025	993205	205
3860714.....	SS 3-Blade Polished (LH).....		937517		993053	993033	993213	205	51
3860715.....	SS 3-Blade Polished (LH).....		937519		993054	993034	993214	205	51
3860716.....	SS 3-Blade Polished (LH).....		937521		993055	993035	993215	205	51
3860717.....	SS 3-Blade Polished (LH).....		937523		993056	993036	993216	205	51
3862462.....	SS 3-Blade Polished.....	161002	933517		992003	993043	993023	993203	205
3870710.....	SS 3-Blade Polished.....	161005	933523		992006	993046	993026	993206	205
3850298-5.....		161002	933517		992003	993043	993023	993203	205
3850299-3.....		161001	933515		992002	993042		205	51
3850300-9.....		161002	933517		992003	993043	993023	993203	205
3850301-7.....		161003	933519		992004	993044	993024	993204	205
3850302-5.....		161004	933521		992005	993045	993025	993205	205
3850303-3.....		161005	933523		992006	993046	993026	993206	205
3850305-8.....	SS Black.....	161001	933515		993042			205	51
3850307-4.....	SS Black.....	161002	933517		993043	993023	993203	205	51
3850308-2.....	SS Black.....	161003	933519		993044	993024	993204	205	51
3850309-0.....	SS Black.....	161004	933521		993045	993025	993205	205	51
3850310-8.....	SS Black.....	161005	933523		993046	993026	993206	205	51
3850311-6.....	SS 3-Blade Polished.....	161002	933517		993043	993023	993203	205	51
3850312-4.....	SS 3-Blade Polished.....	161003	933519		993044	993024	993204	205	51
3850313-2.....	SS 3-Blade Polished.....	161005	933523		993046	993026	993206	205	51
3850314-0.....	SS 3-Blade Polished.....	161004	933521		993045	993025	993205	205	51
3850315-7.....	SS Black (LH).....				993052	993032		205	51
3850316-5.....	SS Black (LH).....		937517		993053	993033	993213	205	51
3850317-3.....	SS Black (LH).....		937519		993054	993034	993214	205	51
3850318-1.....	SS Black (LH).....		937521		993055	993035	993215	205	51
3850319-9.....	SS Black (LH).....		937523		993056	993036	993216	205	51
3850320-7.....	SS 3-Blade Polished (LH).....		937517		993053			205	51
3850321-5.....	SS 3-Blade Polished (LH).....		937519		993054	993034	993214	205	51
3850322-3.....	SS 3-Blade Polished (LH).....		937523		993056	993036	993216	205	51
3850323-1.....	SS 3-Blade Polished (LH).....		937521		993055	993035	993215	205	51
3855480-4.....						993033		205	51
3855481-2.....						993034		205	51
3858026-2.....	SS 3-Blade Polished.....	161002	933517		992003	993043	993023	993203	205
3858027-0.....	SS 3-Blade Polished.....	161003	933519		992004	993044	993024	993204	205
3858028-8.....	SS 3-Blade Polished.....	161004	933521		992005	993045	993025	993205	205
3858029-6.....	SS 3-Blade Polished (LH).....		937517		993053	993033	993213	205	51
3858030-4.....	SS 3-Blade Polished (LH).....		937519		993054	993034	993214	205	51
3858031-2.....	SS 3-Blade Polished (LH).....		937521		993055	993035	993215	205	51

YAMAHA®

61A-45972-00-98.....	Black Steel.....		933521		993045	993025	993205	203	42,52
61A-45974-00-98.....	Black Steel.....		933519		993044	993024	993204	203	42,52
61A-45978-00-98.....	Black Steel.....		933517		993043	993023	993203	203	42,52
61B-45972-00-98.....	Black Steel (LH).....		937521		993055	993035	993215	203	42,52
61B-45974-00-98.....	Black Steel (LH).....		937519		993054	993034	993214	203	42,52
61B-45978-00-98.....	Black Steel (LH).....		937517		993053	993033	993213	203	42,52
62A-45970-10-00.....	Pro Series™.....		335934		993145			See Note 1.....	41
62A-45970-10-00 PRO.....	Pro Series™ HP.....				993146			See Note 1.....	41
62A-45972-10-00.....	Pro Series™.....		335935		993146			See Note 1.....	41
62A-45974-10-00 PRO.....	Pro Series™ HP.....		933419		993145			See Note 1.....	41
63V-45947-00-EL.....		102003							38
63V-45945-10-EL.....		102004							38
650-45943-01-36.....		012102							38
651-45947-00-36.....		012011							38
653-45941-01-36.....		012013							38
663-45930-00-00.....	Painted Stainless Steel.....				993407			117.....	40
663-45943-01-36.....		032040			992408	993408		117.....	40
663-45943-02-36.....		032040			992408	993408		117.....	40
663-45943-02-EL.....		032040			992408	993408		117.....	40
663-45945-00-EL.....		032042			992605	993406		117.....	40
663-45945-01-36.....		032042			992605	992406		117.....	40
663-45945-02-36.....		032042			992605	993406		117.....	40
663-45945-02-EL.....		032042			992605	993406		117.....	40
663-45947-01-36.....		032044			992603			117.....	40
63-45947-02-36.....		032044			992603			117.....	40
663-45947-02-EL.....		032044			992603			117.....	40
663-45949-01-36.....					992409			117.....	40

MICHIGAN WHEEL OEM CROSS REFERENCE

Original Equipment Manufacturer Part & Trade Mark	Standard Hub Propeller	XHS® / XHS II® Hub Propeller						XHS® / XHS II® Hub Kit(s)	Catalog Page #s
	Michigan Match®	Ballistic®	Ballistic® XL	Vortex® XHS	Apollo® Std.	Apollo® Lg. Dia	Apollo® 4-Blade		

YAMAHA® (Continued)

663-45952-01-EL								992409	117	40
663-45952-02-EL		032043						992604 993405	117	40
663-45956-01-00		032046						992601	117	40
6663-45956-01-EL		032046						992601	117	40
663-45958-00-36		032041						992606 993407	117	40
663-45958-00-EL		032041						992606 993407	117	40
663-45958-01-36		032041						992606 993407	117	40
663-45958-01-EL		032041						992606 993407	117	40
663-45976-00-00	Painted Stainless Steel							993408	117	40
664-45941-01-36		022001						992501	123	39
664-45941-01-00		022001						992501	123	39
664-45941-01-EL		022001						992501	123	39
664-45945-00-36		022002								39
664-45945-00-00		022002								39
664-45945-00-EL		022002								39
664-45949-02-00			933013					992505	123	39
664-45949-02-EL			933013					992505	123	39
664-45952-00-00								992506	123	39
664-45952-00-EL								992506	123	39
664-45954-00-EL		022003						992504	123	39
664-45954-01-EL		022003						992504	123	39
664-45947-01-00		022004								39
664-45949-02-00		022005								39
664-45952-00-00		022006								39
664-45970-00-98	Painted Stainless Steel		933013					992505	123	39
66K-45972-B0-00	Pro Series™			953526					203	42,52
66K-45974-B0-00	Pro Series™			953524			993046		203	42,52
683-45941-00-00		102107								38
683-45943-00-36		102005								38
683-45943-00-EL		102005								38
683-45945-00-36		102004								38
683-45945-00-EL		102004								38
683-45947-00-36		102003								38
683-45947-00-EL		102003								38
683-45952-00-00		102106								38
683-W4591-02-EL		102003								38
68F-45970-00-00	Reliance®		933515					992002 993042	203	42,52
68F-45972-00-00	Reliance®	101027	933517					992003 993043 993023 993203	203	42,52
68F-45974-00-00	Reliance®	101028	933519					992004 993044 993024 993204	203	42,52
68F-45976-00-00	Reliance®		933521					992005 993045 993025 993205	203	42,52
68G-45972-00-00	Reliance® (LH)		937517					993053 993033 993213	203	42,52
68G-45974-00-00	Reliance® (LH)		937519					993054 993034 993214	203	42,52
68G-45976-00-00	Reliance® (LH)		937521					993055 993035 993215	203	42,52
68U-45941-00-EL		032046						992402	117	40
69L-45974-20-00	V MAX®							992006 993046 993026 993206	203	42,52
69W-45943-00-00		032040	933215					993408	117	40
69W-45943-00-EL		032040	933215					993408	117	40
69W-45945-00-00		032042	993213					992605 993406	117	40
69W-45945-00-EL		032042	993213					992605 993406	117	40
69W-45947-00-00		032044						992603	117	40
69W-45947-00-EL		032044						992603	117	40
69W-45952-00-00		032043						992604 993405	117	40
69W-45958-00-00		032041						992606 993407	117	40
69W-45958-01-00		032041						992606 993407	117	40
6CB-45974-00-00	V MAX® Ventless		933523						203	42
6D0-45970-00-00	Saltwater Series II™	101028	933519					992004 993044 993024 993204	203	42,52
6D0-45972-00-00	Saltwater Series II™		933521					992005 993045 993025 993205	203	42,52
6D0-45978-00-00	Saltwater Series II™	101027	933517					992003 993043 993023 993203	203	42,52
6D1-45970-00-00	Saltwater Series II™ (LH)		937519					993054 993034 993214	203	42,52
6D1-45972-00-00	Saltwater Series II™ (LH)		937521					993055 993035 993215	203	42,52
6D1-45978-00-00	Saltwater Series II™ (LH)		937517					993053 993033 993213	203	42,52
6E0-45941-01-00		102018								38
6E0-45943-01-00		102017								38
6E5-45941-00-00		101034	933419					992115 993145	See Note 1	41
6E5-45941-00-36		101034	933419					992115 993145	See Note 1	41
6E5-45941-00-EL		101034	933419					992115 993145	See Note 1	41
6E5-45943-00-00		101135	933421					992116 993146	See Note 1	41
6E5-45943-00-36		101135	933421					992116 993146	See Note 1	41
6E5-45943-00-EL		101135	933421					992116 993146	See Note 1	41
6E5-45945-00-36		101033	933417					992114 993144	See Note 1	41
6E5-45945-00-EL		101033	933417					992114 993144	See Note 1	41
6E5-45945-01-00		101033	933417					992114 993144	See Note 1	41
6E5-45945-01-EL		101033	933417					992114 993144	See Note 1	41

MICHIGAN WHEEL OEM CROSS REFERENCE

Original Equipment Manufacturer Part & Trade Mark	Standard Hub Propeller	XHS® / XHS II® Hub Propeller						XHS® / XHS II® Hub Kit(s)	Catalog Page #s
	Michigan Match®	Ballistic®	Ballistic® XL	Vortex® XHS	Apollo® Std.	Apollo® Lg. Dia	Apollo® 4-Blade		
6 YAMAHA® (Continued)									
E5-45947-00-00	101032	933415		992113	993143			See Note 1	41
6E5-45947-00-36	101032	933415		992113	993143			See Note 1	41
6E5-45947-00-EL	101032	933415		992113	993143			See Note 1	41
6E5-45949-00-00	101031			992112				See Note 1	41
6E5-45949-00-36	101031			992112				See Note 1	41
6E5-45949-00-EL	101031			992112				See Note 1	41
6E5-45954-00-00	101036			992111				See Note 1	41
6E5-45954-00-EL	101036			992111				See Note 1	41
6E5-45970-10-00	101028	933519		992004	993044	993024	993204	203	42,52
6E5-45970-10-98	101028	933519		992004	993044	993024	993204	203	42,52
6E5-45972-10-00		933523		992006	993046	993026	993206	203	42,52
6E5-45972-10-98		933523		992006	993046	993026	993206	203	42,52
6E5-45976-10-00	101029	933521		992005	993045	993025	993205	203	42,52
6E5-45976-10-98	101029	933521		992005	993045	993025	993205	203	42,52
6E5-45978-10-00		933525						203	42,52
6E5-45978-10-98		933525						203	42,52
6G1-45943-00-00	102002								38
6G1-45943-00-36	102002								38
6G1-45943-00-EL	102002								38
6G5-45930-00-98		933525						203	42,52
6G5-45941-00-00	101025	933515		992002	993042	993022		203	42,52
6G5-45941-00-36	101025	933515		992002	993042	993022		203	42,52
6G5-45941-00-98	101025	933515		992002	993042	993022		203	42,52
6G5-45941-00-EL	101025	933515		992002	993042	993022		203	42,52
6G5-45943-00-36	101029	933521		992005	993045	993025	993205	203	42,52
6G5-45943-00-EL	101029	933521		992005	993045	993025	993205	203	42,52
6G5-45943-01-00	101029	933521		992005	993045	993025	993205	203	42,52
6G5-45943-01-98	101029	933521		992005	993045	993025	993205	203	42,52
6G5-45945-00-36	101028	933519		992004	993044	993024	993204	203	42,52
6G5-45945-00-EL	101028	933519		992004	993044	993024	993204	203	42,52
6G5-45945-01-00	101028	933519		992004	993044	993024	993204	203	42,52
6G5-45945-01-98	101028	933519		992004	993044	993024	993204	203	42,52
6G5-45945-01-EL	101028	933519		992004	993044	993024	993204	203	42,52
6G5-45947-01-00	101027	933517		992003	993043	993023	993203	203	42,52
6G5-45947-01-98	101027	933517		992003	993043	993023	993203	203	42,52
6G5-45947-01-EL	101027	933517		992003	993043	993023	993203	203	42,52
6G5-45949-00-36		933523		992006	993046	993026	993206	203	42,52
6G5-45949-00-98		933523		992006	993046	993026	993206	203	42,52
6G5-45949-00-EL		933523		992006	993046	993026	993206	203	42,52
6G5-45970-00-98	101025	933515		992002	993042			203	42,52
6G5-45970-01-98	101025	933515		992002	993042			203	42,52
6G5-45970-02-98	101025	933515		992002	993042			203	42,52
6G5-45972-00-98	Painted Stainless Steel	101029	933521	992005	993045	993025	993205	203	42,52
6G5-45972-01-98	Painted Stainless Steel	101029	933521	992005	993045	993025	993205	203	42,52
6G5-45972-02-98	Painted Stainless Steel	101029	933521	992005	993045	993025	993205	203	42,52
6G5-45972-03-98	Painted Stainless Steel	101029	933521	992005	993045	993025	993205	203	42,52
6G5-45974-00-98	Painted Stainless Steel	101028	933519	992004	993044	993024	993204	203	42,52
6G5-45974-01-98	Painted Stainless Steel	101028	933519	992004	993044	993024	993204	203	42,52
6G5-45974-02-98	Painted Stainless Steel	101028	933519	992004	993044	993024	993204	203	42,52
6G5-45974-03-98	Painted Stainless Steel	101028	933519	992004	993044	993024	993204	203	42,52
6G5-45976-00-98	Painted Stainless Steel	101029	933523	992005	993046	993026	993206	203	42,52
6G5-45976-01-98	Painted Stainless Steel	101029	933523	992005	993046	993026	993206	203	42,52
6G5-45978-00-98	Painted Stainless Steel	101027	933517	992003	993043	993023	993203	203	42,52
6G5-45978-01-98	Painted Stainless Steel	101027	933517	992003	993043	993023	993203	203	42,52
6G5-45978-02-98	Painted Stainless Steel	101027	933517	992003	993043	993023	993203	203	42,52
6G5-45978-03-98	Painted Stainless Steel	101027	933517	992003	993043	993023	993203	203	42,52
6H5-45952-00-00		031074							40
6H5-45943-00-00				992408				117	40
6H5-45943-00-EL				992408				117	40
6H5-45945-00-00		031075							40
6H5-45945-00-EL				992406				117	40
6H5-45952-00-00				992405				117	40
6H5-45952-00-EL				992405				117	40
6H5-45958-00-00		031076							40
6H5-45958-00-EL				992407				117	40
6J9-45972-B0-00	Pro Series™		953524		993046	993026	993206	203	42,52
6J9-45976-10-00	Pro Series™		953522		993045	993025	993205	203	42,52
6K1-45945-00-98			937519		993054	993032	993214	203	42,52
6K1-45947-00-98			937517		993053	993033	993213	203	42,52
6K1-45970-00-98					993052	993022		203	42,52
6K1-45970-01-98	Painted Stainless Steel (LH)				993052	993022		203	42,52
6K1-45972-00-00	Painted Stainless Steel (LH)		937521		993055	993035	993215	203	42,52
6K1-45972-00-98	Painted Stainless Steel (LH)		937521		993055	993035	993215	203	42,52

MICHIGAN WHEEL OEM CROSS REFERENCE

Original Equipment Manufacturer Part & Trade Mark	Standard Hub Propeller	XHS® / XHS II® Hub Propeller						XHS® / XHS II® Hub Kit(s)	Catalog Page #s
	Michigan Match®	Ballistic®	Ballistic® XL	Vortex® XHS	Apollo® Std.	Apollo® Lg. Dia	Apollo® 4-Blade		

YAMAHA® (Continued)

6K1-45972-01-98.....	Painted Stainless Steel (LH).....	937521				993055	993035	993215	203	42,52
6K1-45974-00-00.....	Painted Stainless Steel (LH).....	937519				993054	993034	993214	203	42,52
6K1-45974-01-98.....	Painted Stainless Steel (LH).....	937519				993054	993034	993214	203	42,52
6K1-45974-02-98.....	Painted Stainless Steel (LH).....	937519				993054	993034	993214	203	42,52
6K1-45976-00-98.....	Painted Stainless Steel (LH).....	937523				993056	993036	993216	203	42,52
6K1-45978-01-98.....	Painted Stainless Steel (LH).....	937523				993056	993036	993216	203	42,52
6K1-45978-00-00.....	Painted Stainless Steel (LH).....	937517				993053	993033	993213	203	42,52
6K1-45978-00-98.....	Painted Stainless Steel (LH).....	937517				993053	993033	993213	203	42,52
6K1-45978-01-98.....	Painted Stainless Steel (LH).....	937517				993053	993033	993213	203	42,52
6R4-45970-AO-00.....	Saltwater Series™.....	101028	933519	992004	993044	993024	993214	203	42,52	42,52
6R4-45972-AO-00.....	Saltwater Series™.....	101029	933521	992005	993045	993025	993215	203	42,52	42,52
6R4-45974-AO-00.....	Saltwater Series™.....		933523	992006	993046	993026	993206	203	42,52	42,52
6R4-45976-AO-00.....	Saltwater Series™.....		933523	992006	993046	993026	993206	203	42,52	42,52
6R4-45978-AO-00.....	Saltwater Series™.....	101027		992003	993043	993023	993203	203	42,52	42,52
MAR-GYT3B-02-13.....	Performance 3-Blade.....		933013					117	40	40
MAR-GYT3B-03-12.....	Performance 3-Blade.....	032043		992604	993405			117	40	40
MAR-GYT3B-03-13.....	Performance 3-Blade.....	032042	993213	992605	993406			117	40	40
MAR-GYT3B-03-14.....	Performance 3-Blade.....	032041		992606	993407			117	40	40
MAR-GYT3B-03-15.....	Performance 3-Blade.....	032040	933215	992408	993408			117	40	40
MAR-GYT3B-V4-14.....	Performance 3-Blade.....		933415					See Note 1	41	41
MAR-GYT3B-V4-16.....	Performance 3-Blade.....	101032	933417	992113	993143			See Note 1	41	41
MAR-GYT3B-V4-18.....	Performance 3-Blade.....	101033	933419	992114	993144			See Note 1	41	41
MAR-GYT3B-V4-20.....	Performance 3-Blade.....	101034	933421	992115	993145			See Note 1	41	41
MAR-GYT3B-V4-22.....	Performance 3-Blade.....	101135		992116	993146			See Note 1	41	41
MAR-GYT3B-V6-16.....	Performance 3-Blade.....		933517	992002	993042			203	42,52	42,52
MAR-GYT3B-V6-18.....	Performance 3-Blade.....	101027	933519	992003	993043	993023	993203	203	42,52	42,52
MAR-GYT3B-V6-20.....	Performance 3-Blade.....	101028	933521	992004	993044	993024	993204	203	42,52	42,52
MAR-GYT3B-V6-22.....	Performance 3-Blade.....	101029	933523	992005	993045	993025	993205	203	42,52	42,52
MAR-GYT3B-V6-24.....	Performance 3-Blade.....		933525	992006	993046	993026	993206	203	42,52	42,52
MAR-GYT3B-XL-23.....	Performance XL.....		953524					203	42	42
MAR-GYT3B-XL-25.....	Performance XL.....		953526					203	42	42
MAR-GYT4B-V6-23.....	Performance 4-Blade.....		963523				993206	203	42	42
MAR-GYT4B-V6-25.....	Performance 4-Blade.....		963525					203	42	42
MAR-GYT4B-V6-26.....	Performance 4-Blade.....		963527					203	42	42
MAR-VMAX3-04-18.....		101034	933419	992114	993144			See Note 1	41	41
MAR-VMAX3-04-20.....		101135	933421	992115	993145			See Note 1	41	41
MAR-VMAX3-04-22.....				992116	993146			See Note 1	41	41
MAR-VMAX3-06-16.....		101025	933517	992002	993042	993022		203	42,52	42,52
MAR-VMAX3-06-18.....		101027	933519	992003	993043	993023	993203	203	42,52	42,52
MAR-VMAX3-06-20.....		101028	933521	992004	993044	993024	993204	203	42,52	42,52
MAR-VMAX3-06-22.....		101029	933523	992005	993045	993025	993205	203	42,52	42,52
MAR-VMAX3-06-24.....			933525	992006	993046	993026	993206	203	42,52	42,52
MAR-VMAX3-06-26.....			963527					203	42,52	42,52
MAR-VMAX3-C6-18.....			937519		993053	93033	993213	203	42,52	42,52
MAR-VMAX3-C6-20.....			937521		993054	993034	993214	203	42,52	42,52
MAR-VMAX3-C6-22.....			937523		993056	993036	993216	203	42,52	42,52

YAMAHA®	
Note 1	T50, 1996-Present; 15 Tooth Spline 208
	60-100 HP (Including 4-Stroke), 1984-Present; 15 Tooth 208
	80-140 HP, 1978-1983; 15 Tooth Spline 202
	115-130 HP, 1984-Present; 15 Tooth Spline 203

HONDA® OUTBOARDS	
Note 3	75-90 HP, Thru 1988; 15 Tooth Spline 202
	75-90 HP, 1999-Present; 15 Tooth Spline 207
	115-130 HP, 1998-Present; 15 Tooth Spline 207
FORCE®	
	75-150 HP, 1995-Present; 15 Tooth Spline 202
YAMAHA®	
	80-140 HP, 1978-1983; 15 Tooth Spline 202

EVINRUDE®/JOHNSON® OUTBOARDS	
Note 5	60 HP & 70 HP 4-Stroke, 1998-Present; 13 Tooth Spline 210
	All Other V4 Engine Applications; 13 Tooth Spline 206
OMC®/COBRA® STERNDRIVES	
	Model 400/Cobra Stern drives; 13 Tooth Spline 206

EVINRUDE®/JOHNSON® OUTBOARDS	
Note 2	90-140 HP Large Gearcase, 1976-1990; 15 Tooth Spline 201
	90-140 HP Large Gearcase, 1991-Present; 15 Tooth Spline 200
	150-300 HP, 1976-1990; 15 Tooth Spline 201
	150-300 HP, 1991-Present; 15 Tooth Spline 200
	200-300 HP G2 Applications ONLY, 2014-Present; 15 Tooth Spline 228

OMC®/COBRA® STERNDRIVES	
	Model 800/Cobra/King Cobra, 1978-1990; 15 Tooth Spline 201
	Model 800/Cobra/King Cobra, 1991-1994; 15 Tooth Spline 200

SUZUKI®	
Note 4	DF90/DF115, 2001-Present; 15 Tooth Spline 225
	DF140, 2001-Present; 15 Tooth Spline 226
	DF70A/DF80A/DF90A, 2009-Present; 15 Tooth Spline 227
JOHNSON®	
	90/115 HP (4-Stroke), 2003-Present; 15 Tooth Spline 225
	140 HP (4-Stroke), 2003-Present; 15 Tooth Spline 226
YAMAHA®	
	50-100 HP (Including 4-Stroke), 1984-Present; 15 Tooth 208
	115-130 HP, 1984-Present; 15 Tooth Spline 203