



NAUTA® FITTINGS





NAUTA®
FLEXIBLE TANKS AND FITTING

Réf. 010

Wrench. Tightens all accessories.

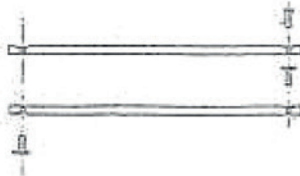

Réf. 300

15 mm · 5/8" · Drawing nipple

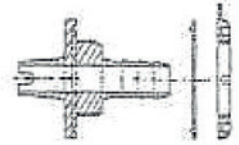

Réf. 501

Vent with cap



Réf. E 300

15 mm · 5/8" · Vent (fuel)

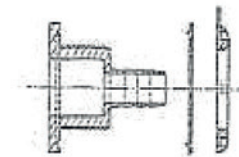

Réf. 120

Complete cap Ø 2"

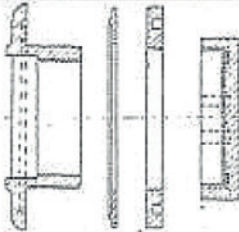

Réf. 1000

20 mm · 3/4" · Vent

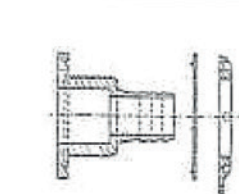

Réf. 030

4" access for cleaning with cap

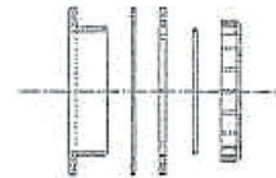

Réf. 210

35 mm · 1 3/8" · Straight Filling nipple

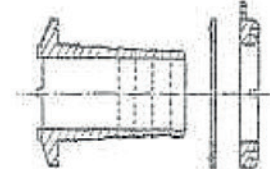

Réf. 215

25 mm · 1" · Filling nipple with cap

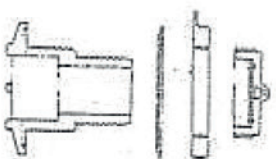

Réf. 1210

38 mm · 1 1/2" · Straight Filling nipple

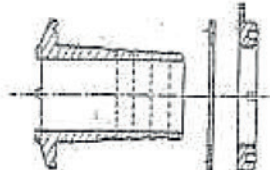

Réf. 400

6 mm · 1/4" · Drawing nipple (fuel)

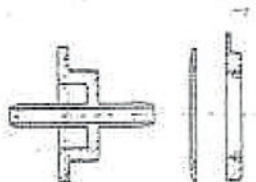

Réf. 910

42 mm · 1 5/8" · Filling nipple

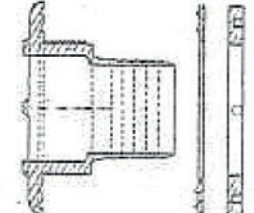

Réf. 1300

12.7 mm · 1/2" · Drawing nipple

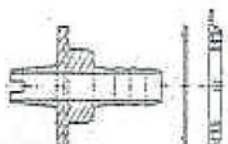

Réf. 110

50 mm · 2" · Straight Filling nipple

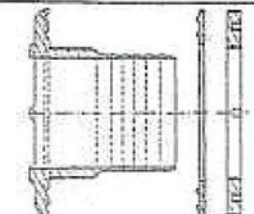



NAUTA[®]
FLEXIBLE TANKS AND FITTING

Réf. 600

8 mm - 3/16" - Drawing nipple (fuel) bent 45°

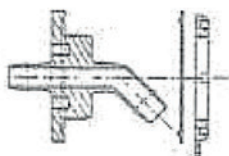

Réf. 111

50 mm - 2" - Filling nipple 90°

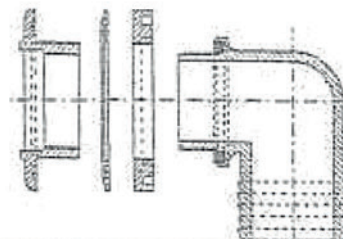

Réf. 310

15 mm - 5/8" - Drawing nipple (bent 45°)

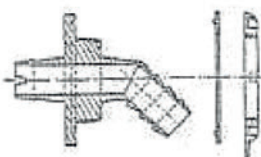

Réf. 605

8/8/8 mm - 5/16"/5/16"/5/16" - Tee piece

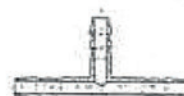

Réf. 220

35 mm - 1 3/8" - Bent Filling nipple

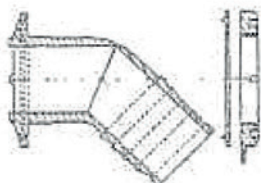

Réf. 1320

12,7/12,7/12,7 mm - 1/2"/1/2"/1/2" - Tee piece

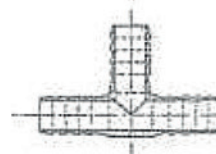

Réf. 1220

38 mm - 1 1/2" - Bent Filling nipple

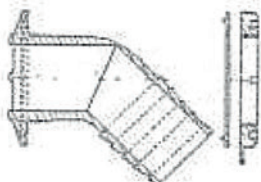

Réf. 320

15/15/15 mm - 5/8"/5/8"/5/8" - Tee piece

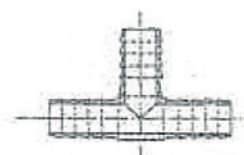

Réf. 311

15 mm - 5/8" - Drawing nipple (bent 90°)

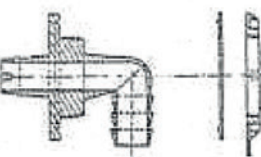

Réf. 230

35/35/35 mm - Tee piece - 1 3/8"/1 3/8"/1 3/8"

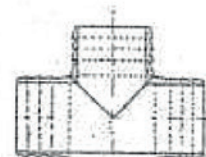

Réf. 221

35 mm - 1 3/8" - Bent Filling nipple 90°

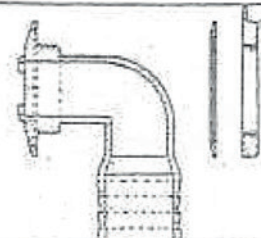

Réf. 1230

38/38/38 mm - 1 1/2"/1 1/2"/1 1/2" - Tee piece

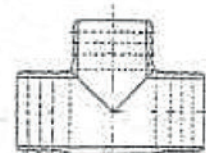

Réf. 2221

38 mm - 1 1/2" - Bent Filling nipple 90°

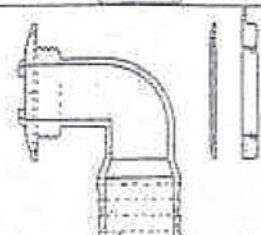

Réf. 130

50/50/50 mm - Tee piece - 2"/2"/2"

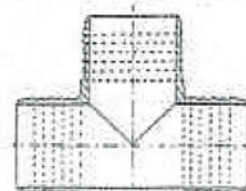



Réf. 240

Tee piece, Pumping on the filling circuit
1 3/8" / 1 1/2" / 1 1/2"

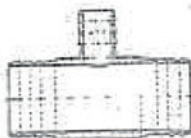

Réf. 1240

Tee piece, Pumping on the filling circuit
1 1/2" / 1/2" / 1 1/2"



Réf. 200

35 mm - 1 3/8" - Deck plug

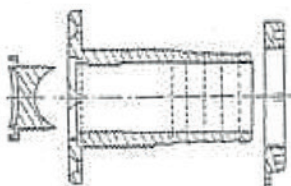

Réf. 900

42 mm - 1 5/8" - Deck plug

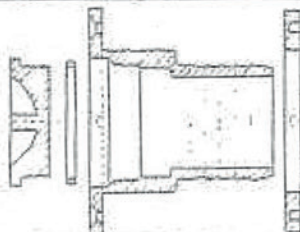

Réf. 100

50 mm - 2" - Deck plug

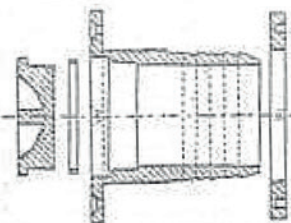

Réf. 101

50 mm - 2" - Deck plug 90°

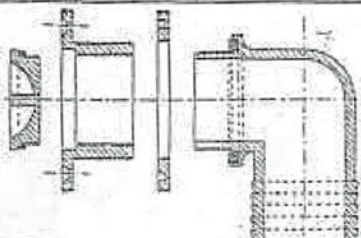

Réf. 330

Shut off valve
(Water) for 3/8" pipe
Ø 15 mm

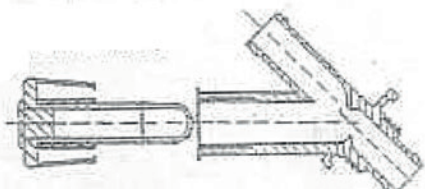

Réf. 720

Filling unit (fuel) - straight Ø 35 mm - 1 3/8"

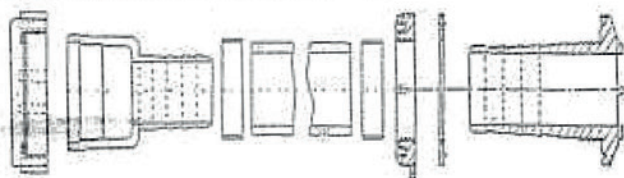

Réf. 700

Filling unit (fuel) 90° - Ø 35 mm - 1 3/8"

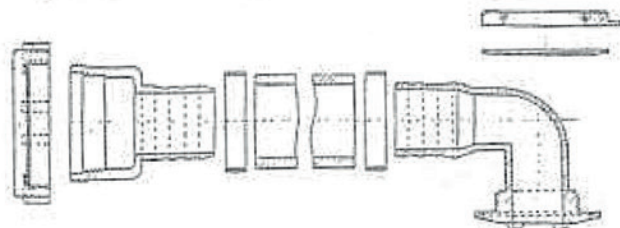

Réf. 610

8 mm - 5/8" - Drawing unit (fuel)
for outboard motors tanks

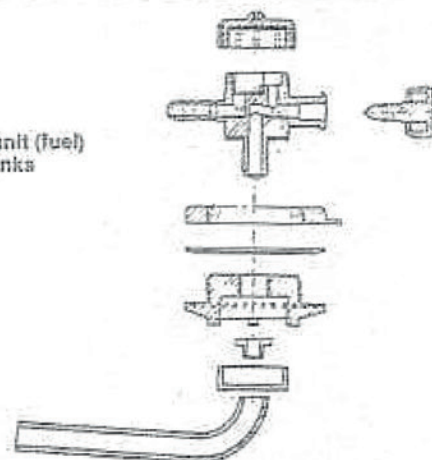

Réf. 630

Shut off valve (Fuel) for 1/2" pipe

