

# OceanLED

This installation manual covers the following products:

**PRO SERIES *HD Gen2***

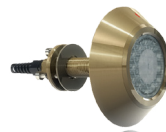
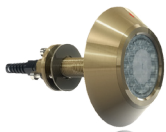

Thru-Hull

Thru-Hull

Thru-Hull

2010TH *HD Gen2*

3010TH *HD Gen2*

COLOURS TH *HD Gen2*



Xchangeable Flush Mount

Xchangeable Flush Mount

Xchangeable Flush Mount

2010XFM *HD Gen2*

3010XFM *HD Gen2*

COLOURS XFM *HD Gen2*

\*US 7,396,139 B2



**IMPORTANT:** Please read the instructions completely before proceeding with the installation. Failure to follow the instructions may invalidate your warranty. These instructions supersede any other instructions if they differ.

<b>Chapter 1</b> .....	4
Overview: Identifying your model and power source, tools and materials necessary for installation, optional accessories, selecting the mounting site, how to make cable runs.	
<b>Chapter 2</b> .....	8
Preparing the hull	
<b>Chapter 3</b> .....	10
Installation of Thru-Hull <i>HD Gen2</i> Models	
<b>Chapter 4</b> .....	13
Installation of Xchangeable Flush Mount <i>HD Gen2</i> Models	
<b>Chapter 5</b> .....	17
Installation of DC Drivers	
<b>Chapter 6</b> .....	20
Installation of Colours <i>HD Gen2</i> Models	
<b>Chapter 7</b> .....	29
Finalizing your OceanLED Installation	
<b>Chapter 8</b> .....	30
Operation, Maintenance, Repair & Parts, Troubleshooting	
<b>Chapter 9</b> .....	37
Warranty Statement and Notes	

## **PRETEST**

Always test the lights prior to installation. Failure to do this may result in additional installation time and could invalidate the warranty.

## **GENERAL**

OceanLED underwater lights are generally used for illuminating the water around a boat or yacht. Placement for achieving the best results are described in selecting the right location.

## **WARRANTY COVERAGE**

2 year warranty from time of purchase, regardless of installation.

## IMPORTANT SAFETY PRECAUTIONS!

 **ATTENTION INSTALLER:** This manual contains important information about the installation, operation and safe use of this product. This information should be given to the owner and/ or operator of this equipment.

 **DANGER! Risk of electrical shock or electrocution!**

This underwater light must be installed by a Licensed Marine Electrician in accordance with ABYC (American Boat and Yacht Council), NMMA, and any other applicable codes and ordinances. Improper installation will create an electrical hazard which could result in death or serious injury to swimmers, installers, or others due to electrical shock, and may also cause damage to property. Always disconnect the power to the light at the circuit breaker before servicing the light. Failure to do so could result in death or serious injury to serviceman, swimmers or others due to electrical shock.

 **WARNING:** Before installing your OceanLED light, read and follow all warning notices and instructions which are included. Failure to follow safety warnings and instructions can result in property damage, severe injury, or even death.



 **WARNING:** Before installing your OceanLED light, check local laws for restrictions regarding the use of colored lights in your area.

 **WARNING:** Salt is an inherently corrosive material. Metal parts and certain natural and man-made surfaces are particularly susceptible to corrosion and deterioration when used in and around salt water. Some OceanLED lights contain combinations of plastic and polymer products which are impervious to salt water corrosion, however, screws and fasteners used for the installation must be of a marine grade type stainless steel or equivalent and monitored annually to ensure the lights remain in service for years to come.

 **WARNING: (Metal & carbon fibre hull's only).** If mounting the light to metal or carbon fibre hull, ensure that suitable measures have been put in place to account for the effects of galvanic corrosion i.e. use of delrin sleeve components.

 **WARNING: Not suitable for use as on docks, piers or pilings.** See our Dock Light products.

## WARNING!

**Never Use Solvents!** Cleaners, fuel, paint, sealants, and other products that may contain strong solvents, such as acetone, that attack many plastics greatly reducing their strength and irreversibly damaging the special lens coatings and cable sheathings.

## Chapter 1: Overview

This handbook provides instructions to assist you in the installation and set up of the various underwater lights from OceanLED.

### Identifying your model and power Source



Thru-Hull	Thru-Hull	Thru-Hull
2010TH <i>HD Gen2</i>	3010TH <i>HD Gen2</i>	COLOURS TH <i>HD Gen2</i>



Xchangeable Flush Mount	Xchangeable Flush Mount	Xchangeable Flush Mount
2010XFM <i>HD Gen2</i>	3010XFM <i>HD Gen2</i>	COLOURS XFM <i>HD Gen2</i>

## Power Source

When identifying your power source, allow at least 15% reserve for voltage fluctuations due to variables beyond your control such as ambient temperature and supply voltage fluctuations to ensure your lights are always receiving the proper voltage and to ensure the power supply is not "overworked" causing premature failure. Use chart below in determining power supplies.

Model	Power Consumption in Watts	15% reserve in Watts	Recommended Fuse Value 12vDC	Recommended Fuse Value 24vDC	Recommended Fuse Value 110vDC	Recommended Fuse Value 230vDC
2010TH HD Gen2	60	69	7	4 Amps	N/A	N/A
2010XFM HD Gen2	60	69	7	4 Amps	N/A	N/A
3010TH HD Gen2	98	112	10	6.3 Amps	N/A	N/A
3010XFM HD Gen2	98	112	10	6.3 Amps	N/A	N/A
COLOURS XFM HD Gen2	200	230	N/A	N/A	3 Amps	3 Amps
COLOURS TH HD Gen2	200	230	N/A	N/A	3 Amps	3 Amps

## Tools and Materials

**WARNING: NEVER USE POWER TOOLS TO SECURE YOUR LIGHTS; HAND TIGHTEN ONLY!**

**WARNING: ONLY USE SCREWS PROVIDED TO SECURE YOUR LIGHTS TO THE HULL!**

**WARNING: OCEANLED RECOMMENDS DRY FITTING ALL PRODUCTS. WHEN INSTALLING, BE SURE THAT THE LIGHT FITS THE AREA AND SECURES TO THE HULL USING THE APPROPRIATE HARDWARE BEFORE APPLYING ANY SEALANT.**

- Power drill (with a drill bit sized to suit your light model, see Fig 1.1 on page 8)
- Phillips head screwdriver
- Mounting screws for the driver boxes
- Marine sealant - 3M 4200 or equivalent
- Zip-ties
- Waterproof Cable Connectors / Butt Splices and Waterproof Heat Shrink
- Allen tools from light kit

## Optional Extras

- **2/4 Way Junction Box - Recommended**

**WARNING:** Insufficient sealing of wires may lead to water ingress and cause product failure. Evidence of water ingress in cable due to installation errors will invalidate warranty. OceanLED recommends using a Blue Sea Systems ST Blade Fuse Block or an OceanLED Junction Box to prevent this issue.

- **Remote Systems**

A Remote System allows you to control your OceanLED lights. Multiple receivers can be used to control multiple lights on your boat.

## PRO SERIES Accessories

### DELTRIN ISOLATING SLEEVE -

- Isolation of the metal parts of the Pro Series Light from metal hulls and engine brackets to minimise galvanic corrosion between dissimilar metals.
- The isolation sleeve is easily fitted to the rear of the light fixture using a suitable adhesive. Allow drying time before installation in hull.

### PART NUMBERS -

- 2010TH HD Gen2: 001-500164 / 3010TH HD Gen2: 001-500165
- 2010XFM HD Gen2: 001-500573 / 3010XFM HD Gen2: 001-500575
- COLOURS TH HD Gen2: 001-500164 / COLOURS XFM HD Gen2: 001-500573



### REMOTE SYSTEMS -

- A Remote System allows you to control your OceanLED lights. Multiple receivers can be used to control multiple lights on your boat from a distance of up to 100' / 30m away. The remote system can be used as a general purpose remote switching unit and can be used to control your underwater lights, deck lights, flood lights, and more.
- This rugged IP68 remote control system is easy to install for power and outputs. Each receiver has 2 relay outputs, each capable of switching up to 250 watts.
- Additional transmitters may be added using the pairing process; any button on the transmitter can be used to control one or many outputs of the receiver.
- Contact your local OceanLED representative for remote system options.



### JUNCTION BOX - RECOMMENDED JUNCTION BOX BY BLUE SEA SYSTEMS

- For a more professional connection for your Pro Series lights, use the junction box to connect up to 12 lights.
- All lights are individually fused within the junction box again adding to speed and cleanliness of installation.

### PART NUMBER (FOR BLUE SEA SYSTEMS) -

- ST Blade Fuse Block: 5026



### DMX TOUCH PANEL CONTROLLER -

- For use with the COLOURS XFM system. Available as a fixed or wifi compatible controller.
- Use to change the colour and lighting effects of the above lights and choose between a spectrum of 6 million colours to suit your mood.
- The wifi controller can be easily programmed to create individual colour scenes, which can then be selected at the touch of a button.

### PART NUMBERS -

- DMX Touch Panel Controller: 001-500596
- DMX Wifi Compatible Touch Panel Controller: 001-500598
- 3M Ethernet Colours Connection Cable: 001-500594
- Colours Terminator Kit: 001-500467



Products may vary from image shown.

## Finding The Mounting Location - UNDERWATER

### Considerations

#### Design -

- Pro Series lights are suitable for Fiberglass, GRP and Wooden Hulls, as well as Aluminum/Steel Hulls using suitable mounting hardware.
- If positioning lights on a transom, more small lights look better than few bigger lights e.g. 4 x 2010's look better than 2 x 3010's.
- The recommended transom quantity is 2 - 6 for 2010 *HD Gen2* models and 4+ for 3010 *HD Gen2* models.
- All colors of light (except blue and green) are typically absorbed within the first 30 meters or 100 feet. Blue and green lights seem brighter than white lights with a better beam spread because they are more perceptible to the cones in the human eye.
- Blue light penetrates the furthest in blue sea water, but may appear whitish or bleached out in green or brown water due to water impurities. Green lights are best for fresh and brown water use.
- When lights are pointing downwards, the light can reflect off a sandy sea bed giving a mirrored effect, and light will bounce back creating even more illumination.
- Please follow instructions with any accessories used to protect warranty coverage and to ensure product longevity.

**TIP:** When installing the XFM units, please check the inside spacing to ensure that if maintenance is required, there is enough space on the inside of the boat to remove the insert. For example, the 2010 XFM unit requires an additional 200mm / 8" from the rear of the housing to allow the insert to be removed.

#### Depth -

- Ideal mounting depth is 200 - 250mm (8 - 10") to top of fixture for 2010 *HD Gen2* models and 250 - 300mm (10 - 12") to top of fixture for 3010 *HD Gen2* models.
- Minimum mounting depth is 100mm (4") to top of fixture.
- Ideally mount your lights at similar depth levels when using underwater to ensure matching color consistency through the water. Deeper lights will look duller and possibly differ in color to shallower mounted units.

#### Spacing -

- If positioning lights on a transom, take into consideration swim platforms and obstacles that may block the initial portion of the light, it may be necessary to use the next model size up.
- The recommended transom spacing is 1 - 1.5m (3 - 5') for 2010 *HD Gen2* models and 1 - 1.8m (3 - 6') for 3010 *HD Gen2* models.
- The recommended hull spacing is 1 - 1.8m (3 - 6') for 2010 *HD Gen2* models and 1.2 - 2.4m (4 - 8') for 3010 *HD Gen2* models.

#### Installation -

- Test units before installation.
- Make sure that when installing any underwater light, the entire rear of the light is always coated in sealant to prevent any water ingress into the hull from rear of the unit.
- When switching lights on for the first time, take into consideration water clarity, ambient light etc as first time impressions can be marred by poor conditions.
- Test units after installation.

## Chapter 2: Preparing the Hull



**Note:** OceanLED makes every effort to protect our marine and fresh water environment as well as our natural resources. Please take care to keep packaging away from and out of the water by ensuring loose packaging materials are secured and not susceptible to being blown into the water. Please recycle all packaging materials as the sustainability of our environment is everyone's responsibility.

**WARNING:** There are several different hull types most are either solid fiberglass or cored. Be sure you follow the correct procedures for the hull you are preparing since all require different preparation methods. We will cover the two most common types below. If in doubt please contact your local OceanLED representative or the boat manufacturer for assistance.

**WARNING:** Please check all components prior to installation. If there is any damage to connectors, cables, and/or any other component, please notify OceanLED BEFORE installation. Failure to notify OceanLED of damage in transit prior to installation will lead to violation of warranty.

### 2.1 Preparing a Solid Fiberglass Hull

**TIP:** Always wear safety goggles and a dust mask.

1. Drill a 3mm / 1/8" pilot hole perpendicular to the waterline from inside the hull. If there is a rib, strut, or other hull irregularity near the selected mounting location, this will need to be taken into account in the planning phase and the location adjusted accordingly, or the obstruction safely removed or modified. If the pilot hole is found to be drilled in the wrong location, drill a second hole in a better location and repair first pilot hole.
2. Using the correct sized hole saw (see table below fig 2.1), cut the mounting hole from outside the hull. Be sure to hold the drill plumb, so the hole will be perpendicular to the water surface.

**TIP:** If drilling large Flush-Mount holes, alternate between applying pressure to the drill and relaxing the acceleration to ensure an even cut through the hull and the saw's longevity. If cutting through Kevlar shield or metal, be careful of overheating the drill bit.

3. Sand the area around the hole using a heavy grit sandpaper to remove the previous bottom paint and to ensure that the sealant will adhere properly to the hull. If there is any petroleum residue inside the hull, remove it with acetone before sanding.

### 2.2 Preparing a Cored Fiberglass Hull

The core (wood or foam) must be cut and sealed carefully. The core must be protected from water seepage and we recommend that the hull be reinforced to prevent it from crushing under the locking nut which would allow the housing to become loose. If unsure, please consult your local OceanLED representative.

**TIP:** Always wear safety goggles and a dust mask.



1. Drill a 3mm / 1/8" pilot hole perpendicular to the inside of the hull. If there is a rib, strut, or other hull irregularity near the selected mounting location, this will need to be taken into account in the planning phase and the location adjusted accordingly, or the obstruction safely removed or modified. If the pilot hole is drilled in the wrong location, drill a second hole in a better location and repair first pilot hole.
2. Using the correct sized hole saw cut the hole from outside the hull through the outer skin only. Be sure to hold the drill plumb, so the hole will be perpendicular to the angle of the hull.

**TIP:** Be aware that to seal the core, you will need to reinforce the core by replacing the soft core material with hard epoxy. Reinforcing the core will prevent the hull from crushing when the unit is tightened down and prevent the unit from releasing the seal pressure due to core compaction.

3. The core material can be very soft. Apply only light pressure to the hole saw after cutting through the outer skin to cut through the material. Once you have cut through the core material, you will need to apply more pressure to cut through the liner material on the inside of the hull.
4. Remove the plug of core material so the core of the hull is fully exposed. Using heavy grit sandpaper, sand and clean the inner skin, core, and the outer skin around the hole to remove fiberglass. Then using a Dremel tool, carefully remove around 3/4" of the core material from inside the outer and inner layers of hull. Be careful at this point to not damage the outer hull layers. This process should leave a 3/4" recess.

**TIP:** Completely seal the hull to prevent water seepage into the core. Allow enough preparation time for several layers of epoxy to completely dry. Remember – environmental conditions can accelerate or decelerate curing times which also varies on type of epoxy used. Consult epoxy directions and test cure time before procedure.

5. Using any type of hard epoxy, generously coat the inside core material with the epoxy, making sure to evenly coat the inside surfaces.
6. When dry, gently sand and clean the area around the hole the size of the diameter of the light fixture using a heavy grit sandpaper, inside and outside, to remove excess epoxy buildup and also to remove any paint to the bare hull material to ensure that the sealant will adhere properly to the hull. If there is any petroleum residue inside the hull, remove it with acetone before sanding.

Product Name	Solid and Cored Hull Installation Saw Size		Delrin Sleeve installation Saw Size	
	Metric	Imperial	Metric	Imperial
2010TH HD Gen2	25mm	1"	35mm	1 1/4"
3010TH HD Gen2	25mm	1"	35mm	1 1/4"
COLOURS TH HD Gen2	25mm	1"	35mm	1 1/4"
2010XFM HD Gen2	102mm	4"	105mm	4 1/8"
3010XFM HD Gen2	115mm	4 1/2"	120mm	4 3/4"
COLOURS XFM HD Gen2	102mm	4"	105mm	4 1/8"

Fig.2.1

## Chapter 3: Installation of Thru-Hull *HD Gen2* Models

PRO SERIES THRU-HULL *HD Gen2*



Thru-Hull 2010TH <i>HD Gen2</i>	Thru-Hull 3010TH <i>HD Gen2</i>
------------------------------------	------------------------------------

Kit Includes			
TH <i>HD Gen2</i> Light		Connection Cable (hard wired to the light)	
Driver vDC		Power Pigtail	
Locking Nut Kit		Fuse Kit	

### 3.1 Installing the Light Fixture - Thru-Hull HD Gen2 Models

**IMPORTANT:** All OceanLED HD Gen2 products have a directional collimator design. When installing the light into the hull you have the option of a 60-degree or a 140-degree beam. To install with a 140 degree beam ensure that the arrow on the light fixture is pointing vertically when installed. To install using the 60 degree beam ensure this arrow is parallel to the waters surface. Once the light has been installed, you are not able to change this without removing the light fixture.

**TIP:** OceanLED recommends dry fitting all products. When installing, be sure that the light fits the area and secures to the hull using the appropriate hardware before applying any sealant.

**TIP:** When applying sealant to light fixture, use the OceanLED packaging material as a cushion when placing light on the ground face down to prevent lens damage.

1. Once the hull preparation is complete (See Chapter 1), the light can be inserted into the hole previously prepared. Make sure to take off all of the locking rings and apply generous amounts of the sealant you are using to the back perimeter of the light body and flange to create an unbroken seam of sealant.

**TIP:** Make sure sealant fills in the recess grooves on the reverse of the light head (See Fig.3.1).



Fig.3.1

2. Insert the light body into the hull, feeding the stem through first and seat into place. Press the light hard into the hull and twist slightly to spread the sealant around behind the light to ensure good adhesion. (See Fig.3.2).

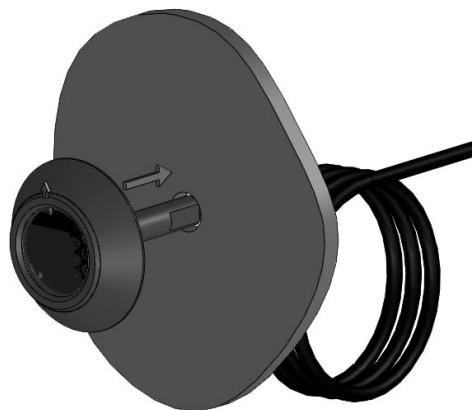

Fig.3.2

**TIP:** Check **red arrow** orientation. For standard wide beam ensure **red arrow** is pointing towards the water surface and the lines on the lens are horizontal. For narrow beam, ensure the **red arrow** is perpendicular to the water surface and the lines on the lens are vertical.

**TIP:** This process is made much easier if a second person is inside the hull to receive the light and install the

locking equipment whilst supporting the light from the outside. Breakages due to lights falling out of the hull are NOT covered under warranty and can cause serious bodily injury as can any falling object.

3. Thread the washer and locking ring onto the stem of the light body. The stainless steel compression washer does not need to be flat to the hull. An undulating surface can be taken up with the washer. The locking ring should also not sit flat against the washer. Depending on the angle of the hull inside the boat the locking bolts will be able to take up an uneven surface.

**TIP:** DO NOT over-tighten locking bolts, you will fracture the light body and this will not be covered under warranty. (See Fig.3.3).

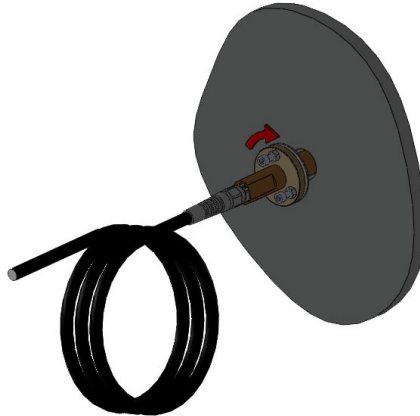

Fig.3.3

**TIP:** Make sure to thread the nylon nuts onto the locking bolts before you get into the lazarette! Early preparation will speed up this process and reduce the chance of losing the small components in dark bilges. It is critical that these components are used; if lost please contact your local OceanLED representative for any part replacements before installation.

4. Tighten the locking bolts using the allen tool in a clockwise motion, adjust to only hand tight. Once you are satisfied that the unit is fully embedded into the hull, you will notice that sealant has squeezed out from around the perimeter of the light. Using a thinner or cleaner, apply to work rag and wipe off excess sealant to leave a clean seal. If you do not see sealant squeeze out from the body, you have not used enough sealant or tightened the unit enough to the hull. Carefully examine the installation to make sure the seal you have installed on the unit is fully water-tight. If in doubt, remove light, re-apply sealant and re-install. (Fig.3.4)

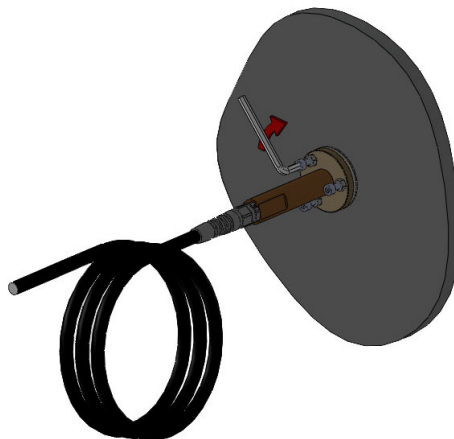

Fig.3.4

**TIP:** When tightening the light fixture, ensure that the **red arrow** orientation does not twist out of position. It is helpful if another person keeps the proper position while tightening .

5. Bonding: Attach the vessels bonding/cathodic protection system to the bolt on the locking ring. Check there is continuity to the front faces.
6. See page 17 for driver installation and page 29 for finalizing the installation of OceanLED Lights.

## Chapter 4: Installation of Xchangeable Flush Mount *HD Gen2*

PRO SERIES XCHANGABLE FLUSH MOUNT *HD Gen2*



Xchangeable Flush Mount 2010XFM <i>HD Gen2</i>	Xchangeable Flush Mount 3010XFM <i>HD Gen2</i>
---	---

Kit Includes			
XFM <i>HD Gen2</i> Light		Connection Cable (hard wired to the light)	
Driver vDC		Power Pigtail	
Locking Nut Kit		Fuse Kit	

## 4.1 Installing the Light Fixture - Xchangeable Flush Mount *HD Gen2*

**IMPORTANT:** All OceanLED Pro Series *HD Gen2* products have a directional collimator design. When installing the light into the hull you have the option of a 60-degree or a 140-degree beam. To install with a 140 degree beam ensure that the arrow on the light fixture is pointing vertically when installed. To install with the 60 degree beam ensure this arrow is parallel to the water surface. Once the light has been installed, you are not able to change this without removing the light fixture.

**TIP:** OceanLED recommends dry fitting all products. When installing, be sure that the light fits the area and secures to the hull using the appropriate hardware before applying any sealant.

**TIP:** When applying sealant to light fixture, use the OceanLED packaging material as a cushion when placing light on the ground face down to prevent lens damage.

1. Once the hull preparation is complete (See Chapter 1), the light can be inserted into the hole previously prepared. Make sure to take off all of the locking rings and apply generous amounts of the sealant you are using to the back perimeter of the light body and flange to create an unbroken seam of sealant.

**TIP:** Make sure sealant fills in the recess grooves on the reverse of the light head (See Fig.4.1).

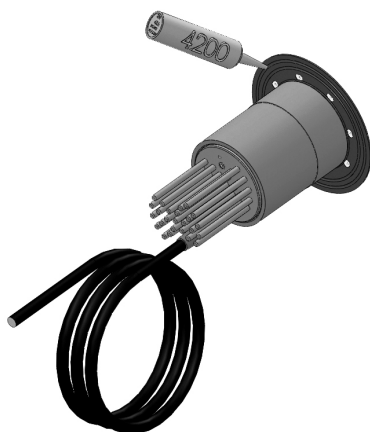

Fig.4.1

2. Insert the light body into the hull, feeding the stem and cable through first and seat into place. Press the light hard into the hull and twist slightly to spread the sealant around behind the light to ensure good adhesion. (See Fig.4.2).

**TIP:** Check **red arrow** orientation. For standard wide beam ensure **red arrow** is pointing towards the water surface and the lines on the lens are horizontal. For narrow beam, ensure the **red arrow** is perpendicular to the water surface and the lines on the lens are vertical.

**TIP:** Cable gland should always run vertically to align with **red arrow**.



Fig.4.2

**TIP:** This process is made much easier if a second person is inside the hull to receive the light and install the locking equipment whilst supporting the light from the outside. Breakages due to lights falling out of the hull are NOT covered under warranty and can cause serious bodily injury as can any falling object.

3. Thread the washer and locking ring onto the stem of the light body. The stainless steel compression washer does not need to be flat to the hull. An undulating surface can be taken up with the washer. The locking ring should also not sit flat against the washer. Depending on the angle of the hull inside the boat the locking bolts will be able to take up an uneven surface. DO NOT over-tighten locking bolts, you will fracture the light body and this will not be covered under warranty. (See Fig.4.3).

**TIP:** Make sure to thread the nylon nuts onto the locking bolts before you get into the lazarette! Early preparation will speed up this process and reduce the chance of losing the small components in dark bilges. It is critical that these components are used; if lost please contact your local OceanLED representative for any part replacements before installation.

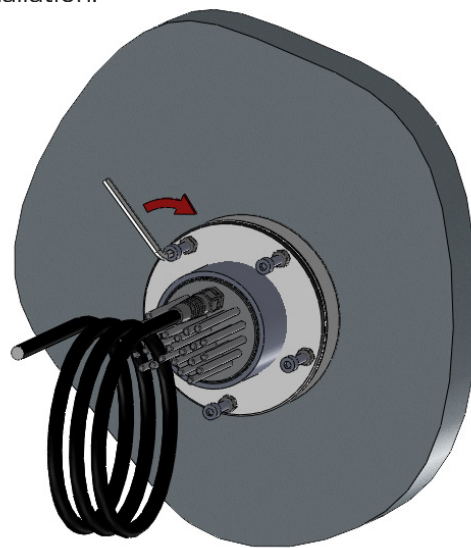

Fig.4.3

4. Tighten the locking bolts using the allen tool in a clockwise motion, adjust to only hand tight. Once you are satisfied that the unit is fully embedded into the hull, you will notice that sealant has squeezed out from around the perimeter of the light. Using a thinner or cleaner, apply to work rag and wipe off excess sealant to leave a clean seal. If you do not see sealant squeeze out from the body, you have not used enough sealant or tightened the unit enough to the hull. Carefully examine the installation to make sure the seal you have installed on the unit is fully water-tight. If in doubt, remove light, re-apply sealant and re-install.

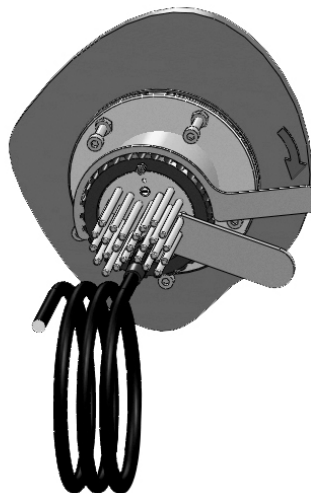

Fig.4.4

5. You will now need to re-install the rear locking ring which is packed separately. This locking ring is simply screwed onto the rear of the housing until it comes to a stop. It is crucial that this ring is screwed down all of the way until this stops. Tools are included in this kit to help with this Installation. The larger style half-spanner tool, marked 'A', will fit into the grooves on this locking ring. Slide the 3-hole tool, marked 'B', down the pins on the rear of the light unit and you will be able to leverage this ring until it is tight against the body of the light unit. (See Fig.4.4)..

**TIP:** When tightening the light fixture, ensure that the **red arrow** on the rear of the light fixture does not twist out of position. It is helpful if another person keeps the proper position while tightening .

6. **Bonding:** Attach the vessels bonding / cathodic protection system using the supplied earth bolt to the locking ring. Ensure the end of the bolt bites in to the anodising of the housing. This is to ensure a good electrical contact to the housing. Also, attach vessel bonding to the earth bolt on the light engine.
7. See page 17 for driver installation and page 29 for finalizing the installation of OceanLED Lights.

## MAINTENANCE

FOR TIPS ON REMOVING THE INSERT, PLEASE REFER TO THE MAINTENANCE AND REPAIR SECTION IN THIS GUIDE.



## **Chapter 5: Installation of vDC Drivers**

**PRO SERIES HD DRIVERS**

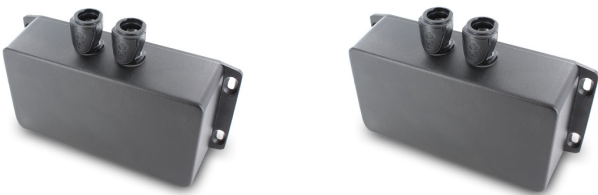

vDC Driver	vDC Driver
2010	3010

In this step you will need the following items to complete the installation  
The driver box

- Connection Cable(s)
- Power Pigtail(s)
- Fuse Kit
- Screws to secure the driver (not provided by OceanLED)
- Suitable screwdriver (not provided by OceanLED)
- Water proof terminal connections (not provided by OceanLED)
- Sufficient cable to run connections to power source. (not provided by OceanLED)
- Optional accessory - Junction Box

## 5.1 Connecting lights to your vDC power source

**WARNING:** Always consult a qualified electrician when connecting OceanLED light fixtures.

**WARNING:** RED=POSITIVE; BLACK=NEGATIVE.

**WARNING:** Standard colour Pro Series *HD Gen2* models are 12-24vDC.

**WARNING:** When connecting light units, please note that all OceanLED lights will operate to within a specific voltage range. Please check the electrical information to ensure cable gauge, fuse recommendations, breaker size etc.

Connectors, 2 pin is for the power pigtail and 10 pin is for the light. Dimensions of the driver 170 x 80 x 50mm ( $6\frac{11}{16} \times 3\frac{5}{32} \times 2$ " )

**TIP:** For complete instructions on vDC / vAC connections, please refer to ABYC codes of practice for vDC / vAC connections.



**TIP:** OceanLED recommends using 12AWG wire for all installations to eliminate any voltage drop and associated issues.

**WARNING:** Never leave the bare cables unprotected. Water deposits in the connectors and cables will corrode the cables causing the light to fail and will NOT be covered under warranty.

- Depending on the model of lights currently installed you will need to pull the correct sized power cable from the breaker to the driver locations to supply constant power to the units. It is imperative that the correct sized tinned boat cable is used. If in doubt, always resort to using the recommended 12AWG wire for all installations.

**TIP:** Incorrect cable gauge will drop voltage along distances. OceanLED recommends using 12AWG wire for all installations to eliminate any voltage drop and associated issues. Decreases in voltage will increase current demand by the driver unit and will lead to blown fuses and tripped breakers. DO NOT compensate for this by adding higher rated fuses and/or breakers. Fuse discrimination is designed to protect the wiring, not the components.

**TIP:** Always use dielectric grease when making the connections and make sure the heat shrink completely encapsulates the wire sheath. Corrosion of wire is NOT covered under warranty.

**TIP:** Mount drivers in a dry location. Drivers should not sit in standing water at any time.

- Connect the plug from the light into the 10 pin port on the driver.
- Using the power pigtail connected into the 2 pin port on the driver, connect the cable end to the boat's power supply using waterproof butt splices. (RED is positive, BLACK is ground)
- If you are not installing a custom fuse panel, it is imperative that the OceanLED supplied fuse is installed on each power line from each driver. Please consult electrical specification on page 4 to select the correct fuse dependant on which model of light you have. (Installation instructions for the fuse are separate from this manual and are included with each fuse).
- Cable tie up wire to finish and test light units BEFORE the boat goes into the water. If you have any issues and need troubleshooting advice, please contact your local OceanLED representative immediately.

- 8. OceanLED recommends a Fused Junction Box for ease of installation.
- 9. See page 29 for finalizing the installation of OceanLED Lights.

**Example of basic unit layout**

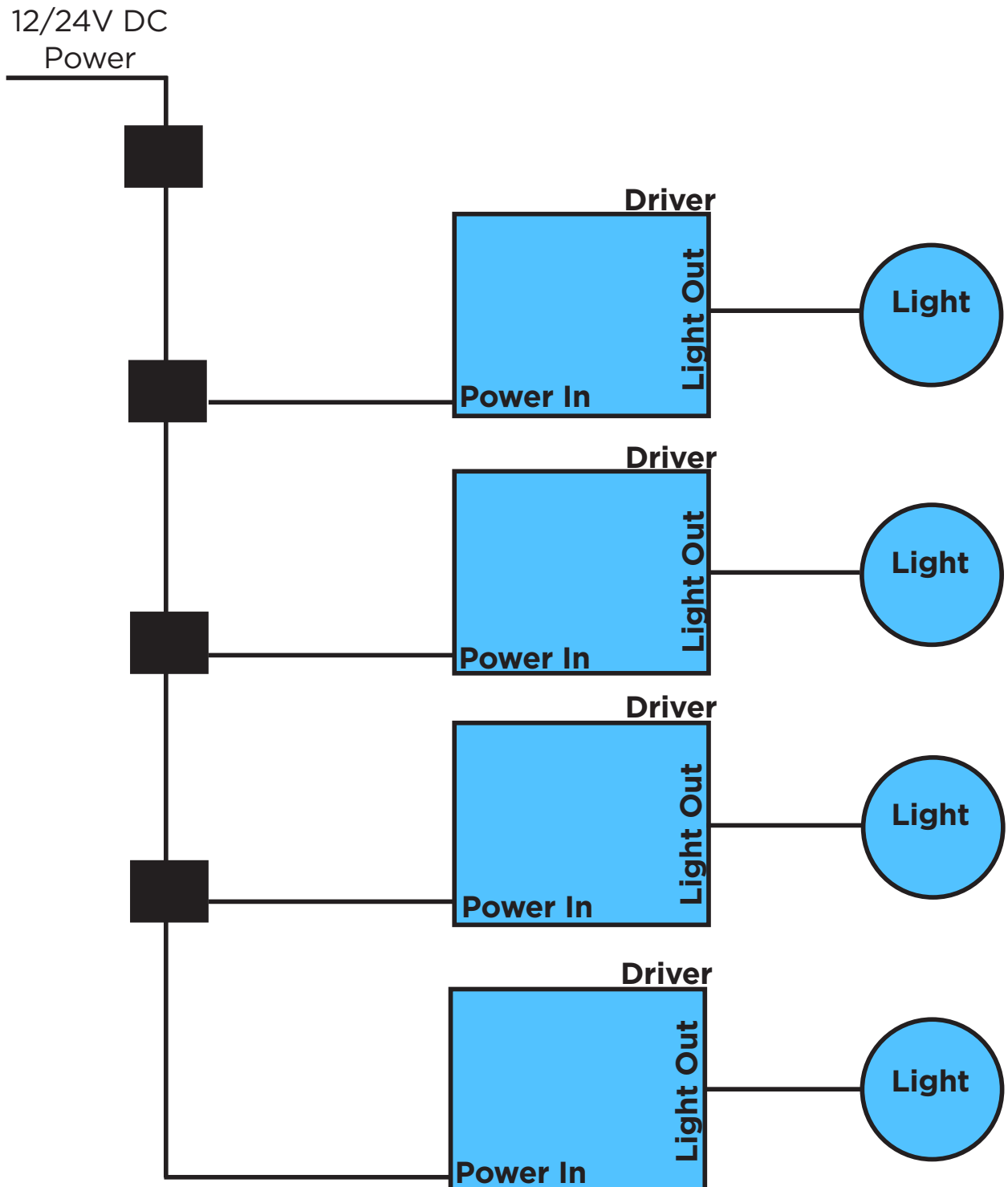

## Chapter 6: Installation of Pro Series COLOURS HD Gen2

PRO SERIES COLOURS HD Gen2



Thru-Hull	Xchangeable Flush Mount
COLOURS TH HD Gen2	COLOURS XFM HD Gen2

**NOTE:** Additional parts are required for the COLOURS system to operate.

- DMX Touch Panel Controller (001-500596) or DMX WIFI Compatible Touch Panel Controller (001-500598) choose one per set up (sold separately)
- Terminator Kit (001-500467) (provided with DMX Controller) one per set up
- Ethernet Colours Connection Cable (001-500594) (provided with the Colours Driver) one less than the number of lights in your set up

COLOURS TH HD Gen2 Kit Includes		COLOURS XFM HD Gen2 Kit Includes	
COLOURS TH HD Gen2 Light		COLOURS XFM HD Gen2 Light	
Connection Cable (hard wired to the light)		Connection Cable (hard wired to the light)	
Locking Nut Kit		Locking Nut Kit	
Driver vAC	These items are provided in a separate box (see Driver Installation pg.26)	Driver vAC	These items are provided in a separate box (see Driver Installation pg.29)
Power Pigtail (hard wired to the driver)		Power Pigtail (hard wired to the driver)	
Ethernet Connection Cable		Ethernet Connection Cable	

## 6.1 Installing the Light Fixture - COLOURS TH HD Gen2

**IMPORTANT:** All OceanLED HD Gen2 products have a directional collimator design. When installing the light into the hull you have the option of a 60-degree or a 140-degree beam. To install with a 140 degree beam ensure that the arrow on the light fixture is pointing vertically when installed. To install using the 60 degree beam ensure this arrow is parallel to the waters surface. Once the light has been installed, you are not able to change this without removing the light fixture.

**TIP:** OceanLED recommends dry fitting all products. When installing, be sure that the light fits the area and secures to the hull using the appropriate hardware before applying any sealant.

**TIP:** When applying sealant to light fixture, use the OceanLED packaging material as a cushion when placing light on the ground face down to prevent lens damage.

1. Once the hull preparation is complete (See Chapter 2), the light can be inserted into the hole previously prepared. Make sure to take off all of the locking rings and apply generous amounts of the sealant you are using to the back perimeter of the light body and flange to create an unbroken seam of sealant.



Fig.6.1

**TIP:** Make sure sealant fills in the recess grooves on the reverse of the light head (See Fig.6.1).

2. Insert the light body into the hull, feeding the stem through first and seat into place. Press the light hard into the hull and twist slightly to spread the sealant around behind the light to ensure good adhesion. (See Fig.6.2).

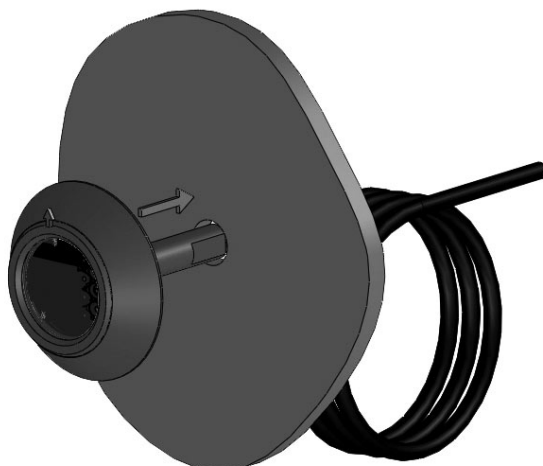

Fig.6.2

**TIP:** Check **red arrow** orientation. For standard wide beam ensure **red arrow** is pointing towards the water surface and the lines on the lens are horizontal. For narrow beam, ensure the **red arrow** is perpendicular to the water surface and the lines on the lens are vertical.

**TIP:** This process is made much easier if a second person is inside the hull to receive the light and install the locking equipment whilst supporting the light from the outside. Breakages due to lights falling out of the hull are NOT covered under warranty and can cause serious bodily injury as can any falling object.

3. Thread the washer and locking ring onto the stem of the light body. The stainless steel compression washer does not need to be flat to the hull. An undulating surface can be taken up with the washer. The locking ring should also not sit flat against the washer. Depending on the angle of the hull inside the boat the locking bolts will be able to take up an uneven surface.

**TIP:** DO NOT over-tighten locking bolts, you will fracture the light body and this will not be covered under warranty. (See Fig.6.3).

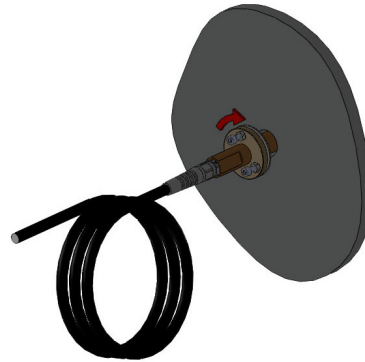

Fig.6.3

**TIP:** Make sure to thread the nylon nuts onto the locking bolts before you get into the lazarette! Early preparation will speed up this process and reduce the chance of losing the small components in dark bilges. It is critical that these components are used; if lost please contact your local OceanLED representative for any part replacements before installation.

4. Tighten the locking bolts using the allen tool in a clockwise motion, adjust to only hand tight. Once you are satisfied that the unit is fully embedded into the hull, you will notice that sealant has squeezed out from around the perimeter of the light. Using a thinner or cleaner, apply to work rag and wipe off excess sealant to leave a clean seal. If you do not see sealant squeeze out from the body, you have not used enough sealant or tightened the unit enough to the hull. Carefully examine the installation to make sure the seal you have installed on the unit is fully water-tight. If in doubt, remove light, re-apply sealant and re-install. (Fig.6.4)

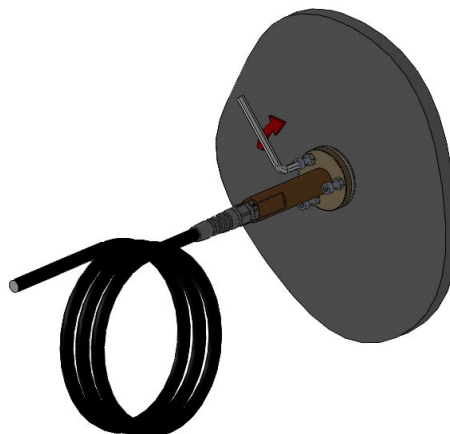

Fig.6.4

**TIP:** When tightening the light fixture, ensure that the **red arrow** orientation does not twist out of position. It is helpful if another person keeps the proper position while tightening.

5. Bonding: Attach the vessels bonding/cathodic protection system to the bolt on the locking ring.

## 6.2 Installing the Light Fixture - COLOURS XCHANGEABLE FLUSH MOUNT MODELS

**IMPORTANT:** All OceanLED *HD Gen2* products have a directional collimator design. When installing the light into the hull you have the option of a 60-degree or a 140-degree beam. To install with a 140 degree beam ensure that the arrow on the light fixture is pointing vertically when installed. To install using the 60 degree beam ensure this arrow is parallel to the waters surface. Once the light has been installed, you are not able to change this without removing the light fixture.

**TIP:** OceanLED recommends dry fitting all products. When installing, be sure that the light fits the area and secures to the hull using the appropriate hardware before applying any sealant.

**TIP:** When applying sealant to light fixture, use the OceanLED packaging material as a cushion when placing light on the ground face down to prevent lens damage.

1. Once the hull preparation is complete (See Chapter 1), the light can be inserted into the hole previously prepared. Make sure to take off all of the locking rings and apply generous amounts of the sealant you are using to the back perimeter of the light body and flange to create an unbroken seam of sealant.

**TIP:** Make sure sealant fills in the recess grooves on the reverse of the light head (See Fig.6.5).

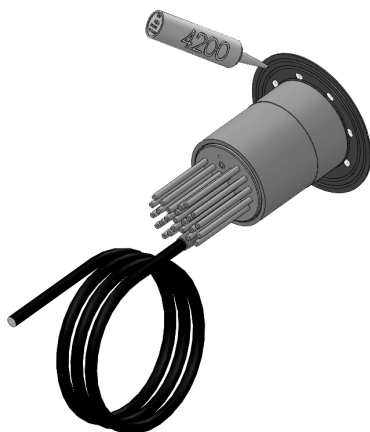

Fig.6.5

2. Insert the light body into the hull, feeding the stem through first and seat into place. Press the light hard into the hull and twist slightly to spread the sealant around behind the light to ensure good adhesion. (See Fig.6.6).

**TIP:** Check **red arrow** orientation. For standard wide beam ensure **red arrow** is pointing towards the water surface and the lines on the lens are horizontal. For narrow beam, ensure the **red arrow** is perpendicular to the water surface and the lines on the lens are vertical.

**TIP:** Cable gland should always run vertically to align with **red arrow**.



Fig.6.6

**TIP:** This process is made much easier if a second person is inside the hull to receive the light and install the locking equipment whilst supporting the light from the outside. Breakages due to lights falling out of the hull are NOT covered under warranty and can cause serious bodily injury as can any falling object.

3. Thread the washer and locking ring onto the stem of the light body. The stainless steel compression washer does not need to be flat to the hull. An undulating surface can be taken up with the washer. The locking ring should also not sit flat against the washer. Depending on the angle of the hull inside the boat the locking bolts will be able to take up an uneven surface. DO NOT over-tighten locking bolts, you will fracture the light body and this will not be covered under warranty. (See Fig.6.7).

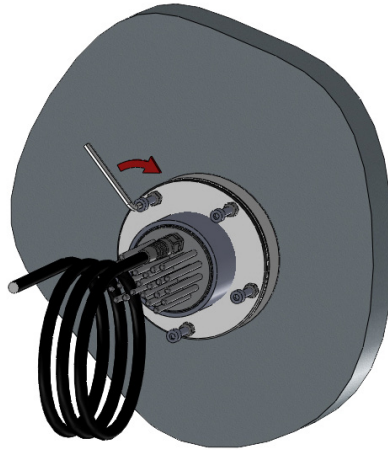

Fig.6.7

**TIP:** Make sure to thread the nylon nuts onto the locking bolts before you get into the lazarette! Early preparation will speed up this process and reduce the chance of losing the small components in dark bilges. It is critical that these components are used; if lost please contact your local OceanLED representative for any part replacements before installation.

4. Tighten the locking bolts using the allen tool in a clockwise motion, adjust to only hand tight. Once you are satisfied that the unit is fully embedded into the hull, you will notice that sealant has squeezed out from around the perimeter of the light. Using a thinner or cleaner, apply to work rag and wipe off excess sealant to leave a clean seal. If you do not see sealant squeeze out from the body, you have not used enough sealant or tightened the unit enough to the hull. Carefully examine the installation to make sure the seal you have installed on the unit is fully water-tight. If in doubt, remove light, re-apply sealant and re-install.



5. You will now need to re-install the rear locking ring which is packed separately. This locking ring is simply screwed onto the rear of the housing until it comes to a stop. It is crucial that this ring is screwed down all of the way until this stops. Tools are included in this kit to help with this Installation. The larger style half-spanner tool, marked 'A', will fit into the grooves on this locking ring. Slide the 3-hole tool, marked 'B', down the pins on the rear of the light unit and you will be able to leverage this ring until it is tight against the body of the light unit. (See Fig.6.8).

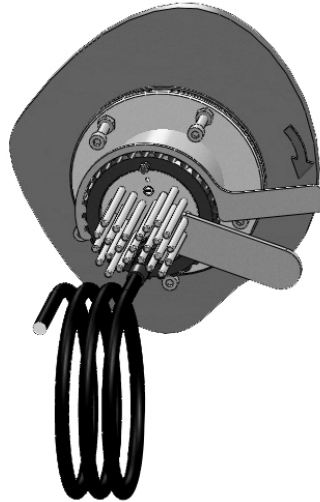

Fig.6.8

**TIP:** When tightening the light fixture, ensure that the **red arrow** on the rear of the light fixture does not twist out of position. It is helpful if another person keeps the proper position while tightening .

- 6 **Bonding:** Attach the vessels bonding / cathodic protection system to the earth bolt on the light engine using the supplied earth bolt to the locking ring. Ensure the end of the bolt bites in to the anodising of the housing. This is to ensure a good electrical contact to the housing. Also, attach vessel bonding to the earth bolt on the light engine.

## MAINTENANCE

FOR TIPS ON REMOVING THE INSERT, PLEASE REFER TO THE MAINTENANCE AND REPAIR SECTION IN THIS GUIDE.

### 6.3 - Connecting the vAC Driver to the light fixture - COLOUR CHANGE

COLOURS TH / XFM HD Gen2 Driver Kit Includes	
Driver vAC	
Power Pigtail	
Ethernet Connection Cable	
COLOURS TH / XFM HD Gen2 Light	These items are provided in a separate box (see Light Installation pg.23)
Connection Cable	
Locking Nut Kit	

**WARNING:** Always consult a qualified electrician when connecting OceanLED light fixtures.

**WARNING:** BROWN=POSITIVE/LIVE/HOT; BLUE=NEGATIVE/NEUTRAL; GREEN=GROUND/EARTH.

**WARNING:** Pro Series COLOUR Change HD Gen2 models are 110vAC / 230vAC.

**WARNING:** When connecting light units, please note that all OceanLED lights will operate to within a specific voltage range. Please check the electrical information to ensure cable gauge, fuse recommendations, breaker size etc.

#### Connecting lights to your vAC power source

**TIP:** For complete instructions on vDC / vAC connections, please refer to ABYC codes of practice for vDC / vAC connections.

**WARNING:** Never leave the bare cables unprotected. Water deposits in the connectors and cables will corrode the cables causing the light to fail and will NOT be covered under warranty.

**WARNING:** Driver box is factory sealed to prevent tampering, if an issue occurs please contact OceanLED

1. Depending on the model of lights currently installed you will need to pull the correct sized power cable from the breaker to the driver locations to supply constant power to the units. It is imperative that the correct sized tinned boat cable is used.

**TIP:** Always use dielectric grease when making the connections and make sure the heat shrink completely encapsulates the wire sheath. Corrosion of wire is NOT covered under warranty.

**TIP:** Mount drivers in a dry location. Drivers should not sit in standing water at any time.

2. Connect the plug from the light into the 10 pin port on the driver.
3. Using the power pigtail cable connect the cable end via a suitable fuse to the boat's mains power supply ensuring connections / cable are fully watertight.
4. Cable tie up wire to finish and test light units BEFORE the boat goes into the water. If you have any issues and need troubleshooting advice, please contact your local OceanLED representative immediately.

## 6.4 Connecting lights to a DMX Controller

**TIP:** It is recommended to mount drivers within 10' / 3m of one another in order to utilise the 3m Ethernet Colours Connection Cable purchased separately from OceanLED 001-500594.

**WARNING:** Never leave the bare cables unprotected. Water deposits in the connectors and cables will corrode the cables causing the light to fail and will NOT be covered under warranty.

1. Using the DMX starter cable (supplied with the DMX Touch Panel Controller 001-500596 and the DMX Wifi Compatible Touch Panel Controller 001-500598), connect the first driver in series into the far left DMX port. If required, the DMX control panel cable can be extended by a competent electronics engineer.
2. Connect each additional driver using the 3 meter Ethernet Colours Connection Cable supplied with the driver, from the second DMX port into the first DMX port on the next driver. And so on until the last driver in chain is connected.
3. Use the Colours Terminator supplied with the DMX controller, in the last ethernet port in the chain. **This is essential for closing the control circuit.**
4. Using either the DMX control panel available from OceanLED or any other DMX compatible device, you can now communicate with all the lights in the system as a complete lighting system.

**TIP:** There is an additional IP68 DMX DIY Cap connector kit 001-500466, purchased separately, which will allow you to create a water tight DMX connection cable for your desired length. (for complete instructions on assembling this item please refer to the manual that is provided with the DIY Cap)

**TIP:** Drivers are preset to DMX channel 1. DMX setting on all units are factory preset :100000000. If you wish to change this please contact OceanLED.

### TO CREATE INDIVIDUAL DMX ADDRESSES

It is also possible to individually address each light as a separate system. For full details on how to do this, contact OceanLED direct for an integrators instruction manual for more complex, custom installations.

## 6.5 Wiring Schematic for Pro Series COLOURS HD Gen2

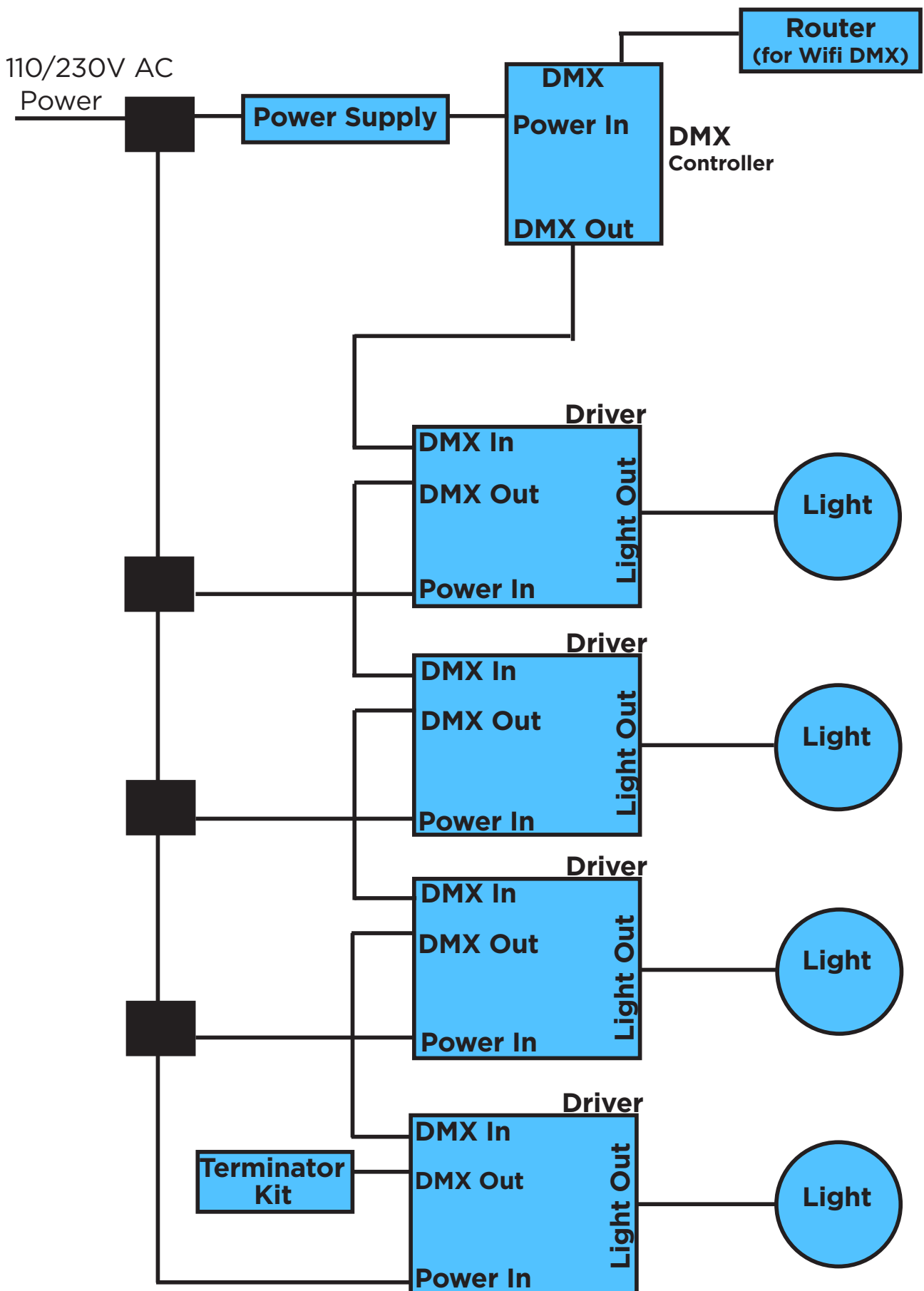

## Chapter 7: Finalizing your OceanLED installation

### 7.1 Bottom paint your lights

**WARNING:** Always test the lights **BEFORE** bottom painting.

**TIP:** Marine growth can accumulate rapidly on the lights surface reducing performance within weeks. Use an anti-foul paint on all metal surfaces and reapply paint every 6 - 12 months or at the beginning of each boating season. Leave the factory installed lens masking disk in place for this procedure and remove the disk when the paint is dry. This will protect the lens from primer and paint. If you've lost your lens disk - you may obtain another from OceanLED.

When bottom painting, remember environmental factors such as temperature when applying coats of paint and primer. Make sure to leave enough drying time in cooler conditions.

1. Using fine grit sandpaper, gently key the metal surfaces in preparation for priming.
2. Using a cleaner solvent, prime the flange area and leave to dry. This will enable the paint to better stick to the surface.

**WARNING:** **Do not sand or prime the lens at ALL!** The lens is fragile and has a Tritonium® coating which allows the lens to be cleaned easily. Sanding or priming this area will cause the lens to become damaged and the coating to be removed.

3. Coat the light flange with several coats of an epoxy primer, allowing drying time in between each coat. (Example Interlux 2000). When dry apply your selected bottom paint to the entire light unit and surrounding hull area with your selected bottom paint.

**TIP:** Leave the lens masking disk in place whilst painting. When complete, remove this disk to leave the lens clear. **DO NOT** paint the glass lens!

4. Allow the paint to dry and reapply second coat. When dry remove the lens masking disk.

### 7.2 Test your lights

Always test the lights **BEFORE** the boat goes back into the water. All non-XFM model OceanLED light installs require the boat to be hauled out of the water to replace light units. At this final stage make sure all of the system is operational. If you have any issues, please contact your local OceanLED representative.

**WARNING:** **Never install a new through the hull fixture then leave the boat in the water unchecked for several days.**

When the boat is placed in the water, immediately check for leaks. Note that very small leaks may not be readily observed. It is best not to leave the boat in the water for more than 3 hours before checking it again. If there is a small leak, there may be considerable bilge water accumulation after 24 hours. If a leak is observed you must take action immediately to prevent damage to the property.

### 8.1 - Cleaning Instructions

1. Sea growth can collect quickly on the light and this can reduce the performance in just a few weeks. To prevent the build-up of sea growth, all OceanLED lights have been coated with a specialized Tritonium® coating which makes the surface of the glass lens a non-stick layer which helps ward off long term barnacle buildup. Lights should be cleaned with a boat brush or similar biweekly or as needed to keep the lens of the light clean. Growth varies greatly around the world and maintenance is imperative to the proper operation and longevity of the product. If heavy fouling occurs, barnacles can be removed from the lens using a plastic scraper and moderate pressure. This can be done in the water using a plastic scraper. If cleaning the lens while the boat is out of the water, apply water to the lens before scraping. Never scrape or try to remove barnacles from a dry lens.
2. Check connections annually for corrosions, if necessary replace connections.

**CAUTION:** Harsh cleaning solvents such as acetone may damage the light. Using a harsh solvent on the light may invalidate your warranty.

### 8.2 - Removing and Replacing your XFM Model

Should you need to remove the XFM insert from the light housing, you will need the tools which came with the light originally or obtain these through your local OceanLED dealer.

#### Removing the insert

**IMPORTANT:** Before attempting to remove the Insert from the housing, be sure to check that the lens on the unit has not cracked and leaked water into the light unit. If the lens or seals have become compromised, do not remove the insert whilst the boat is in the water. Contact your local OceanLED representative for more information.

1. Disconnect the connection cable from the driver.
2. **Remove the air lock screw** which is located on the rear of the insert, directly next to the bonding point. Using an allen key tool, remove this screw from the housing and keep in a safe place. It is critical that this screw is removed and re-inserted when re-installing the insert. If you lose this piece, please contact your local OceanLED representative for a replacement.
3. **If water emerges from the air lock hole immediately replace the air lock screw and call OceanLED for warranty support.**

4. Remove all bonding wires.

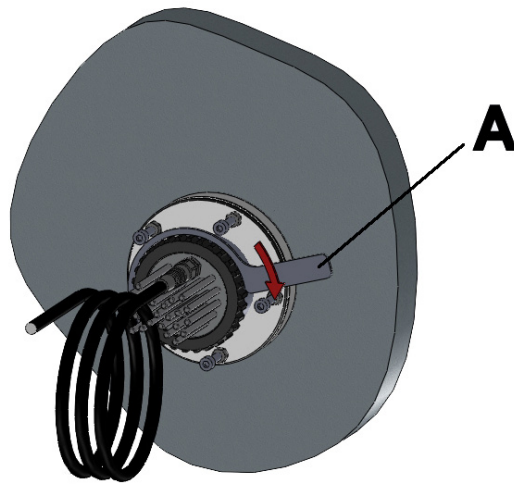

Fig.8.1

5. Remove the rear locking ring housing with the large half spanner tool. This unscrews counter clockwise. Pull the ring off the rear of the housing once removed (Fig.8.1).

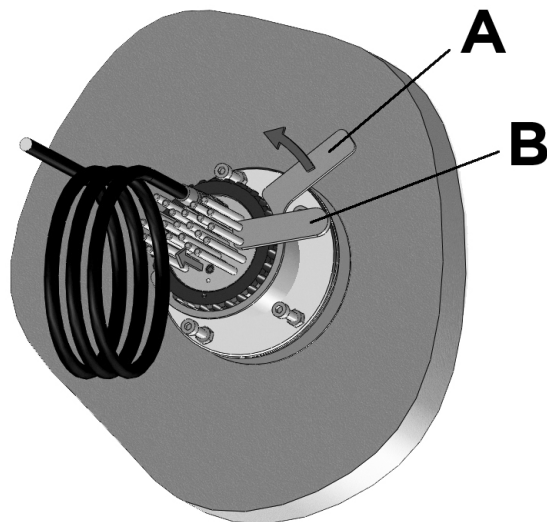

Fig.8.2

6. Slide the 3-hole tool down the rear cooling pins on the light as far as it will go (Fig.8.2).

7. The housing should now be ready for removal. Depending on how long the unit has been installed may determine whether the unit will easily come out of the housing. Using the 3 holed tool still on the pins, rotate the entire insert clockwise and counter clockwise to break any debris that may have become lodged. The insert is coated with a PTFE coating which should enable the insert to be easily removed (Fig.8.3).

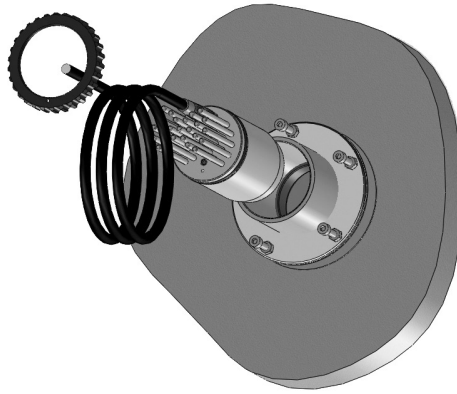

Fig.8.3

8. Once the Insert is loose, you will notice that there are 2 o-ring seals on the insert, which seal the light in place. Do not lose these or attempt to remove.

### **Installing the Insert**

1. When the new insert is ready to install. Please check that you have the o-rings and the air lock screw ready to install with the insert. **NOTE: The air lock screw needs to be removed for the installation.**
2. Insert the light insert into the housing. Make sure you clean any debris or dirt away from inside the housing and inside of the lens. To install with the wide beam, ensure the cable gland is positioned vertically. For a narrow beam, the cable gland needs to be horizontal. (Fig.8.4).

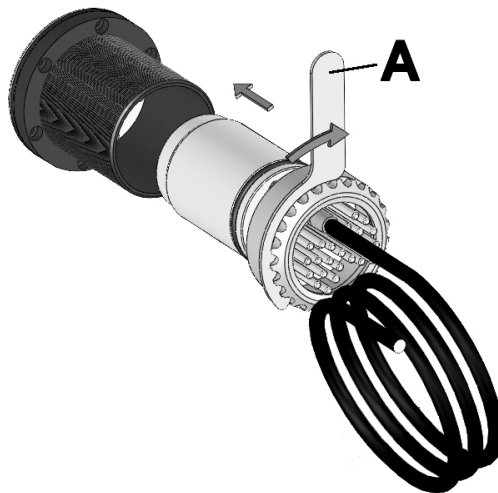

Fig.8.4

3. Slide the insert in completely until it comes to a stop. Gently rock the insert to make sure you have cleared the ledge where the lens sits and the insert is sitting as far forward against the glass as possible. You should hear a suction sound as the gasket is sealed and air is pushed out.



**TIP:** Make sure the cable gland remains vertically or horizontally positioned to maintain even beam spread. This is extremely important to achieve the best effects.

4. Slide the locking ring over the back of the insert and into position over the o-ring. Make sure that the o-ring is sitting evenly and does not have a wave or pocket in it. Once you are happy that the o-ring is seated correctly, screw the ring into place clockwise manually. (See Fig.8.5)

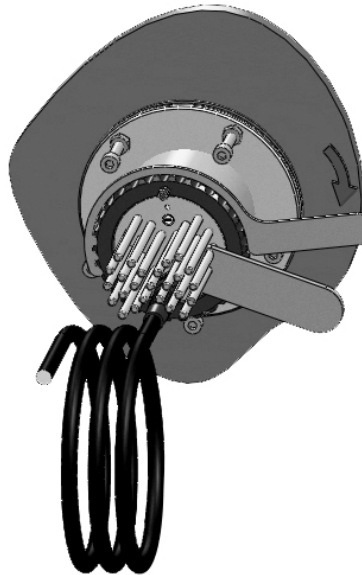

Fig.8.5

5. Once you have this locking ring hand tight, slide the 3-holed tool over the cooling pins as far as it will go. Using the small 1/2 spanner tool on the locking ring groove, tighten the locking ring by using reverse pressure on the 3 holed tool until the ring is tight. This ring will energize the o-ring to seal the light unit.
6. Insert the air lock screw into position. Make sure to carefully install this evenly into the hole as to not strip the threads. Screw this tight into the housing, which will air seal the light into position.
8. Re-install the vessels bonding/cathodic protection system to the unit. Ensure the end of the bolt bites in to the anodising of the housing. This is to ensure a good electrical contact to the housing.

## Replacement Parts

Lost, broken, and worn parts should be replaced immediately and can be obtained through your dealer or from the manufacturer.

If you misplace and need the extraction tools contact your local OceanLED representative.

## Troubleshooting Common Problems and Their Solutions

PRO SERIES - STATIC COLORS			
Problem	Check	Result	Fix
Light does not look bright	Check that there is no marine growth on the lens	Sea life / barnacles present	Clean the lens as per instruction booklet
	Check voltage supply to the light is between 8 volts and 32vDC	Voltage is either too high or too low	Investigate reason for high or low voltage and fix
	Check voltage supply is stable and does not fluctuate	Voltage is fluctuating	Investigate reason for voltage fluctuation and fix
	Check that the electrical connections between the light and the supply cable have been made correctly	Poor electrical connection	Remake connection and seal connection correctly
	Confirm all LEDs are illuminated	1 or more LEDs are not working	Contact your dealer. If the installation instructions have not been followed and as a result the light has been damaged. This is not covered by the warranty.
	Check lights to see if water is present inside the light	Water present	If water is present contact your dealer. If the installation instructions have not been followed and as a result the light has been damaged, this is not covered by the warranty
	Check interlink cable (between light and driver) connections at the light and driver ends for corrosion	If corrosion is present	It is not advised to reuse the cable if water is present inside. Contact your dealer for a replacement. This is NOT covered by the warranty.
Light works and then flickers	Check that the lights are submerged in water. The Pro Series lights have a thermal cut out to prevent over heating and prolong the lifetime of the lights. This system will shut down portions of LEDs until the light has cooled. If the light is out of the water the light may shut down completely until cool	Ensure the light is submerged and cooled sufficiently, power down the lights and re-test	Contact your dealer or OceanLED for further guidance
Light has water inside	Check connections to make sure they are not submerged in water	Light will require replacing	This is not covered by the warranty
	Check cable to make sure there is no damage to the cable	Cable will require replacing	This is not covered by the warranty
	Checked all factors that are above and the light still does not work	Light faulty	Contact your dealer for a replacement light

## Troubleshooting Common Problems and Their Solutions

PRO SERIES - STATIC COLORS			
Problem	Check	Result	Fix
Light does not look bright	Check that there is no marine growth on the lens	Sea life / barnacles present	Clean the lens as per instruction booklet
	Check voltage supply to the light is between 8 volts and 32vDC	Voltage is either too high or too low	Investigate reason for high or low voltage and fix
	Check voltage supply is stable and does not fluctuate	Voltage is fluctuating	Investigate reason for voltage fluctuation and fix
	Check that the electrical connections between the light and the supply cable have been made correctly	Poor electrical connection	Remake connection and seal connection correctly
	Confirm all LEDs are illuminated	1 or more LEDs are not working	Contact your dealer. If the installation instructions have not been followed and as a result the light has been damaged. This is not covered by the warranty.
	Check lights to see if water is present inside the light	Water present	If water is present contact your dealer. If the installation instructions have not been followed and as a result the light has been damaged, this is not covered by the warranty
	Check interlink cable (between light and driver) connections at the light and driver ends for corrosion	If corrosion is present	It is not advised to reuse the cable if water is present inside. Contact your dealer for a replacement. This is NOT covered by the warranty.
Light works and then flickers	Check that the lights are submerged in water. The lights have a thermal cut out to prevent overheating and prolong the lifetime of the lights. This system will shut down portions of LEDs until the light has cooled. If the light is out of the water the light may shut down completely until cool.	Ensure the light is submerged and cooled sufficiently, power down the lights and re-test.	Contact your dealer or Ocean LED for further guidance.
Light has water inside	Check there is no damage to light glass/housing.	Light will require replacing.	This is not covered by the warranty
	Check cable to make sure there is no damage to the cable.	Light will require replacing.	This is not covered by the warranty
Light does not light up	Check that the electrical connections between the light and the driver/cabinet have been made correctly.	Poor electrical connection.	Remake connection.
	Check that the supply wiring to the driver/cabinet.	Incorrectly wired/poor electrical connection.	Correct issue and re-try.
	Check voltage supply to the driver is correct (as specified on the driver/cabinet).	Voltage is either too high or too low, or not present.	Investigate reason for high or low voltage and fix.
	Check the in-line fuse/breaker is intact and not blown/tripped.	Replace fuse / reset breaker.	If fuse keeps blowing/ breaker tripping then there is a short circuit in the light system that must be traced and rectified. If no external short can be located contact your dealer.
	Exchange the interlink cable (between light and driver) with one from a working light.	Light works, faulty cable	Contact your dealer for a replacement.
	Exchange the driver with one from a working light.	Light works, faulty driver	Contact your dealer for a replacement



## Troubleshooting Common Problems and Their Solutions

PRO SERIES - COLOUR CHANGE			
Problem	Check	Result	Fix
The colour change trouble shooting problems and solutions are the same as above three tables for standard colours, with the addition of the below:			
Light does not respond to the controller	Check DMX connections are daisy-chained between controllers	Not daisy-chained	Daisy-chain the DMX connections
	Check all cables are connected correctly	Not connected correctly	Correct cabling connections
		Connections are correctly connected	Contact the Warranty Department