

INSPIRED FISHING

RISING WITH EVERY CHALLENGE

The average person might stumble upon a remote beach and find inspiration in the texture of the sand, curl of the waves and the salty spice of the air. For the community of anglers, however, playing witness to nature is far less satisfying than direct participation.

As we approach every piece of water, our attention inevitably falls to what lies beneath the surface: beneath the waves, off the point, on the edge of structure, at the intersection of currents. It's the fish and their habits, their power and speed that captivate our attention. Through rod and reel we find our connection. Some call it sport. We call it a way of life that's rich with experiences.

At Okuma Fishing Tackle, our goal is to enhance every encounter. Integrating the latest advancements in materials and construction techniques is a means to downplay the presence of the gear. Eliminate weight and increase feel. Enjoy a running fish instead of fearing it. Button down the drag and go toe-to-toe with complete confidence. Your focus is not on the equipment; it's on the fish.

Wherever your travels take you, from the local pond to distant reef, we're proud to be your partner in the discovery of what lies beneath.

OKUMA FISHING TACKLE CORPORATION

okuma
INSPIRED FISHING

1 SPINNING REELS

- 15 Makaira Spinning
- 18 Azores Spinning
- 20 Helios SX Spinning
- 22 Inspira Spinning
- 23 RTX
- 26 Epixor XT
- 27 Epixor LS
- 28 Ceymar
- 29 Ceymar XT
- 30 Avenger
- 31 Skyliner / Tomcat
- 32 Alaris / Altera
- 33 Jaw / C-Fight
- 34 Aria / Fuel Spin
- 35 Azaki / Pink Pearl V2
- 36 Dead Ringer / Fina Pro XP
- 37 Ceymar XT Mach FD / Carbonite V2 Match
- 38 Custom Black Feeder / Carbonite XP Feeder
- 39 Carbonite Match / Carbonite
- 40 Compressa / Revenger Pro
- 41 Revenger / Cascade
- 42 Aventa Baitfeeder
- 43 Coronado CDX / Avenger Baitfeeder
- 44 Longbow XT Baitfeeder / Axeon Baitfeeder
- 45 Barbarian Baitfeeder / Ceymar Baitfeeder
- 46 Pulzar Baitfeeder / Dyna Drag XP Baitfeeder
- 47 Lotus Baitfeeder / AK Baitfeeder
- 48 Carbonite V2 Match Baitfeeder / Carbonite XP Baitfeeder
- 50 LS-6K
- 51 Atomic Carp / Booster II
- 53 8K Baitfeeder
- 56 Surf 8K Baitfeeder / T-Rex
- 57 Custom Black / Distance DTA
- 58 Distance Surf Arena / Big Bomber Spod
- 59 Distance Carp Intr / Rockway
- 61 INC-6000

2 BAITCAST REELS

- 65 Komodo SS
- 67 Ceymar / JAW
- 68 Citrix / Helios SX
- 69 Cerros

3 TROLLING REELS

- 72 Tesoro
- 73 Cortez
- 74 Convector
- 75 Convector Line Counter
- 77 Convector LP Line Counter
- 78 Cold Water Line Counter
- 79 Cold Water Copper line reels
- 80 Magda Air Line Counter
- 81 Magda Pro Line Counter
- 82 Classic Pro XPD
- 83 Classic Pro
- 86 Makaira TDC
- 88 Makaira
- 90 Makaira SEa
- 92 Makaira SEa Silver
- 94 Cavalla
- 96 Solterra SLX

4 RODS

- 102 Helios Air
- 103 ONE.rod
- 104 Inspira
- 105 Helios SX Travel
- 106 Epixor
- 107 Epixor Travel / Command
- 108 Ceymar UFR / Caymar SPR
- 109 Pink Pearl V2 / Azaki
- 110 Alaris

- 112 Altera
- 113 Altera Travel
- 114 Altera Tele Spin / Vsystem G2
- 115 Nememsis
- 116 Competition
- 117 Fuel Spin
- 118 Wave Power
- 119 Baltic Stick
- 120 Tactical
- 121 Red / Red V1
- 122 Psycho Perch Spin
- 123 G-Control
- 124 LRF
- 125 Light Range Fishing
- Light Range Fishing Tele Spin
- 126 Rodster Spin
- 127 Tomcat
- 128 8k Carp / LS-6K Carp
- 129 Custom Black Carp
- 130 C-Fight Carp
- 131 Avenger Carp
- 132 Altera Tele Cast / 8k Feeder
- 133 LS-6K Feeder
- 134 Custom Black Feeder
- 135 Ceymar Feeder / Ceymar Match Feeder
- 136 Makaira
- 138 SLX Boat / SLX
- 139 SLY Tuna Top Class
- 140 Cortez
- 141 Cold Water
- 142 Azores V2 Popping
- 143 Hawaiian Custom Popping
- 144 Metaloid S Popping
- 145 Metaloid Jigging
- 146 Tesoro Jigging / Azores Jigging
- 147 Metaloid Slow Jigging
- 148 Tesoro Slow Jigging
- 149 Azores Slow Jigging
- 150 Magda Air / Komodo Light Jigging
- 151 Epixor EGI / Aria EGI
- 152 Egipro / Flx Tip
- 153 Makaira Surf

- 154 Azores Surf / Azores II
- 155 Master Surf / Trio-Rex arena
- 156 Trio-Rex Surf
- 157 Distance Surf Arena / Surfliner Surf
- 158 Nememsis Surf / Wave Power
- 159 Helios Tele Surf / Makaira Tele Surf
- 160 Azores Tele Surf / Trio-Rex Tele Surf
- 161 Elettra Surf / Ceymar Tele Surf
- 162 Avenger Tele Surf / Revenger Tele Surf
- 163 Fina Pro Tele Surf / Alaris Tele Surf

5 ROD AND REEL COMBOS

- 166 Fuel Spin
- 167 Steeler XP
- 168 Cascade II
- 169 Fin-Chaser X

6 FLY, FLOAT AND MOOCHING

- 172 Raw-II / Aventa
- 173 SLV Fly

7 ACCESSORIES

- 176 Fishing Lines
- 179 Apparel & Accessories

CROSSOVER CONSTRUCTION

Innovation at its freshest...Trio spinning reels from Okuma feature a unique crossover construction. We took the best from aluminum construction and lightweight graphite materials and created a distinctive new concept in reel design. The solid one piece stamped aluminum reel stem and rotor arm are paired with lightweight graphite side plates and a rotor housing which provides strength where needed, and weight savings where possible.



SPINNING REEL DUAL FORCE DRAG

DFD incorporates both surfaces of the spool to maximize high-end drag pressure, efficiency and overall smoothness. Mounted in the top of the spool and protected by the Hydro Block system is a multi-disc felt drag system that works in conjunction with a secondary drag system that is mounted under the spool. Even pressure is applied to both surfaces of the spool for maximum stability.

LEVER DRAG DUAL FORCE DRAG

For extremely smooth and strong drag outputs, Okuma's Makaira lever drags are designed with a patented Dual Force Drag system. This drag system is specifically engineered to be mounted in the right side of the spool, designed around a Pull Bar Drag System which keeps all mechanical workings in precise alignment and places no pressure on the frame. This system works in conjunction with a custom designed thrust bearing, which alleviates side load at heavy drag settings.



C-40X

Okuma's C-40X carbon technology utilizes a specially blended graphite polymer. The carbon fibers in this material are elongated and reinforced, creating a substantially stronger composite than standard graphite materials. At 25% lighter, 1.5 times stronger and 100% anti-corrosive, C-40X translates into an extremely lightweight and durable construction.

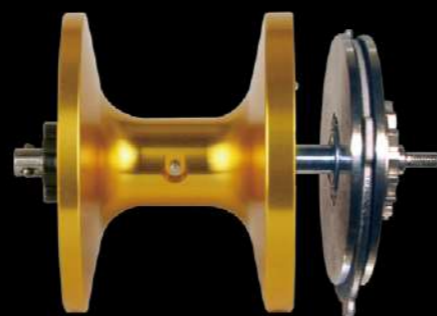

TORSION CONTROL ARMOR

The Torsion Control Armor (TCA) design found on the new Inspria spinning reels is made with Okuma's C-40X long-strand carbon fiber technology. This not only makes the reel lighter, but also makes the reel extremely rigid which reduces twist and torque and keeps the internal parts in perfect alignment.



CENTRIFUGAL DISC BAIL

Okuma's Centrifugal Disc Bail (CDB) is a unique new design that incorporates a heavier brass disc that is perfectly weighted and balanced to create a smoother and easier bail operation, while increasing the strength and stability of the overall bail function.



CYCLONIC FLOW ROTOR

The Cyclonic Flow Rotor (CFR) was designed to create a "cyclonic" airflow, which significantly increases air flow through the ported rotor. This thoroughly tested design allows for a much faster drying time if the reel becomes wet, minimizing corrosion possibilities throughout the reel.



PRECISION ELLIPTICAL GEARING SYSTEM

The Precision Elliptical Gearing System advantage boils down to one thing and one thing only - performance. By regulating the speed of the spindle stroke, reels equipped with this system wind line more consistently and uniformly on the spool, resulting in level line lay. This creates less friction during casting for increased distance, greater accuracy, and longer line life, as well as smoother, more uniform drag pressures. Pick up any Okuma reel equipped with this feature and feel for yourself the balance, smoothness and power that are all characteristics of the Precision Elliptical Gearing System.



MCS

Okuma's Magnetic Control System is a fully-sealed, 100% waterproof cast control system that reduces backlash and improves casting distance by utilizing the magnetic field generated by the high RPM spinning of the spool during casting. The magnetic field is influenced by the adjustable cast control magnet which exerts an opposing force and allows for minute and accurate adjustments.



TECHNOLOGY FOR THE FUTURE

MACHINED RIGID FRAME

Okuma's Machined Rigid Frame construction incorporates a one-piece fully-machined aluminum frame. These rigid bar-stock aluminum frames are the ultimate in precision alignment and tolerances withstanding more pressure and torque than any other material used in our industry for frame materials. Okuma features these anodized frames on fly reels, baitcast reels, lever drag reels and star drag trolling reels.



BODY ARMOR

Okuma's stainless steel Body Armor eliminates the frame flex commonly found in graphite framed trolling reels. This feature incorporates two large stainless steel rings that are mounted to both sides of the frame. The harness lugs are integrated into the body armor design and eliminate the pressure commonly placed on the harness lugs by redistributing the pressure to these large-diameter rings.



SELF LUBRICATING GEAR SYSTEM

The self-lubricating gear system is a feature found on Okuma's higher-end star drag reels. The main gear on this system incorporates a heat-sensitive oil-impregnated brass bushing that is mounted in the center of the gear. This system releases oil if friction increases to keep the main gear and drive shaft running smoothly in all conditions. Okuma is the first company to adopt this technology which originated in the large machine industry where this function has been time tested for many years.



XL GEARING

The XL gearing design found on both lever drag and star drag reels incorporates an oversized gear box that features an enlarged gearing system and enlarged drag system. The drag surface areas on this system are more than 50% larger than a standard gear-box design. For the gear system, the major advantage is that the gear teeth are substantially larger, allowing more strength and cranking power. This is how we are able to offer a high-speed gear ratio reel without sacrificing cranking power. Our XL gearing system essentially turns your reel into a winch.



SPEED LOC PINION GEAR SYSTEM

The SLG technology incorporates a dual-step pinion gear system on star drag reels that allows positive engaging at extreme high speeds. The SLG system allows for instant gear engagement when engaging from freespool to strike at speeds in excess of 50 MPH.



MSS

Strong, Stable, Smooth - Okuma's Mechanical Stabilizing System is a support system that ties the spool shaft, pinion gear, pinion gear bearing, drive shaft and main gear together with a single support system. While other reels on the market offer minimal or no gear stabilization, this patented Okuma design allows all of these critical parts to stay in precise alignment. Designed specifically to hold up to the demands of braided and wire line fishing, the MSS support system stabilizes the spool shaft at 3 key stress points to eliminate flex under pressure - which directly translates into a reel that is more durable, stronger and smoother than the competition.



WIDE MOUTH LEVELWIND

This heavy-duty, stainless steel levelwind is Titanium coated and built to withstand the punishment of braided and wire lines. The guide has been designed with an increased opening to insure proper knot clearance when fishing with double lines. This wide space allows for Albright or similar connection knots, as well as swivels and copper line to pass through the guide easier and be wound directly on the spool.



T-BAR HANDLE

T-Bar Handle: The patented design of the T-Bar handle offers a true ergonomically correct angle to ensure an angler gets maximum power with minimum fatigue. The T-bar takes full advantage of the natural dynamics of the human hand, wrist and forearm to help sustain power and endurance for the angler.

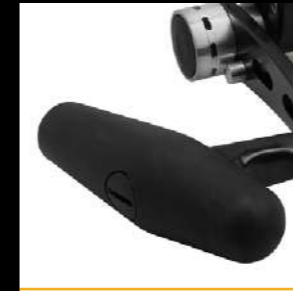

STRIKE ZONE

Okuma's Strike Zone linecounter system incorporates a mechanical counter that precisely measures line based on spool revolutions. These counters measure in feet and are calibrated at the factory to be most accurate with a full spool and monofilament lines.



ERGO GRIP

The Ergo Grip handle knob is an extremely comfortable oversized handle-knob design for both speed and power. This soft-touch knob has been ergonomically designed to fit in the palm of your hand and will be found on certain Okuma lever drag reels, star drag reels and some spinning reel models.



2-SPEED GEARING

Okuma's 2-speed technology incorporates two sets of stainless steel main and pinion gears, allowing anglers the option of a high-speed gear ratio or a powerful low-speed gear ratio for maximum power and torque. To shift gears it is as easy as pushing a button or popping a lever with Okuma's unique shifting design to obtain the appropriate gear ratio you desire.



HIPPO GRIP

The Hippo Grip is a unique reel-clamp design that serves triple duty when fishing offshore. This heavy-duty, forged aluminum reel clamp securely supports your reel to the rod for maximum safety. This clamp also incorporates a small hole that was designed to be used with a safety line for trolling. On the rear of the clamp is a large diameter hole that was designed to be used as a trigger. The large hole should be mounted facing the butt of the rod.

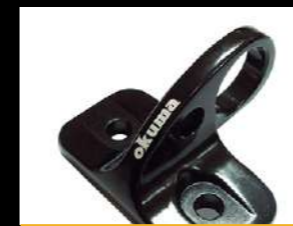

CRC

Corrosion Resistant Coating combines Okuma's proprietary HDG-II gearing system, which offers exceptional anti-corrosive properties compared to standard gears, with a coating of Corrosion X HD to all internal and external parts. The CRC process actually penetrates and bonds to the metal, which helps significantly toward long term protection.



TECHNOLOGY FOR THE FUTURE



BAITFEEDING SYSTEM

Okuma's patented baitfeeding system allows anglers to disengage their spinning reel spool and allow their bait to run freely. The baitfeeding system incorporates a secondary micro-adjustable drag system at the rear of the reel that allows for precise adjustment of the spool for bait control. In order to disengage this system simply turn the handle. The On/Off lever on the rear of the reel will automatically disengage the baitfeeding system so you can fight your fish with the main drag system.

With today's super braided lines and lighter more compact reels, ALG offers anglers lighter weight gears without compromising on strength and durability. Adding to their longevity, ALG gears are anodized to hold up to the elements much better than traditional gearing materials.



HDGII

Okuma's proprietary High Density Gearing II incorporates an extremely strong alloy composition with a special anti-corrosion coating process. The result is high density, corrosion resistant gears that are built to handle the severe elements and brutal strains placed on a reel's internal gear system.



ALUMILITE FRAME CONSTRUCTION

AlumiLite construction incorporates Okuma's rigid aluminum body technology on spinning, trolling and fly reel designs. Aluminum frames are stronger and more rigid and are capable of withstanding more pressure and torque than traditional graphite frames. These lightweight, diecast aluminum frames provide more precise tolerances for precision gear alignment, maximum castability and ultimate durability.

The RES II System stands for Rotor Equalizing System. This second-generation RES System incorporates a computer-balanced weight precisely placed in the rotor. This weight allows for precision balance and eliminates all spool wobble for perfect alignments and smooth cranking.

RES II



ALG



QUICK-SET

This system allows for instant handle engagement and eliminates all handle back play commonly found in many reels. This is accomplished by using a corrosion-resistant stainless steel roller bearing that engages the reel in one direction for rock-solid hook sets.



HYDRO BLOCK

The Hydro Block design features a rubber gasket mounted in the top of a spinning reel spool. This rubber seal blocks water and foreign materials from entering the drag system. The Hydro Block system ensures that your drag washers always perform at optimal levels.



EFR II

The Even Flow Roller System utilizes a ball bearing under the line roller to maximize efficiency. This roller helps reduce line twists by freely rolling over the line roller without friction. Without this system, line will naturally twist when drag is pulled.



HIGH PERFORMANCE BALL BEARINGS

The balls used on the HPB's are constructed from the same high-grade stainless steel material as the bearing housing. These bearings were designed to be more than 10 times more resistant to saltwater than standard stainless steel bearings. These bearings may even outlast the angler himself.



MCS

Okuma's Magnetic Control System reduces backlash and improves casting distance by utilizing the magnetic field generated by the high RPM spinning of the spool during casting. The magnetic field is influenced by the adjustable cast control magnets which exert an opposing force and allows for minute and accurate adjustments.



VELOCITY CONTROL

The Velocity Control System is an adjustable, 6-pin centrifugal braking system for precision spool control. Weights can be adjusted IN or OUT for additional spool control. Positioning the weights toward the spool allows for more freespool, while adjusting the pins out away from the spool allows for more control. Anglers can alternate weights until they find that perfect balance for casting.



SPOOL ACCESS PORT

This unique new design can be found on Okuma's low profile baitcast reels. The Spool Access Port allows for quick access to the spool by simply sliding the lock/unlock lever on the side plate opposite the handle. This system allows for quick spool changes, but more importantly it allows quick access for adjusting the Velocity Control System.





SPINNING REELS

Spinning reels are an opportunity. Worldwide, they're most often the very first reel a beginning angler picks up, and for so many, they're the only reel type that's ever needed. As such, spinning reels define the experience from pond panfish to offshore big game. At every level the Okuma selection is angler-centric, delivering a fantastic fishing experience through better design, materials and construction techniques. Our reels need to inspire participation today, tomorrow and in the future ahead, a responsibility we gladly accept.



MAXGEAR REACH FOR THE MAX

Okuma's Makaira spinning reels are in a class of their own, featuring a forged stainless steel, machined MAXGEAR. While the majority of reels in this category feature bronze, aluminum or simple machine cut stainless steel gears, the Makaira's class leading main gears are machine cut forged stainless steel. We ported the main gear and incorporated other design elements to keep it light weight enough for you to fish all day. No compromises were made in the internal design of MAXGEAR. The pinion gear and heat treated spool shaft are 17-4 grade machine cut stainless steel. They are rust proof and were optimized to work with braided line and the reels high-output drag.





MAKAIRA[®] SPINNING REEL

Derived from the Okuma 4D Concept which focuses on Design, Drive, Drag and Durability as core performance elements, Makaira spinning reels are built from the ground up to be the toughest, most durable spinning reels an angler can own. Constructed from the finest and strongest materials available, Makaira series reels are big game reels developed to pursue everything from Giant Trevally, trophy-sized Yellowtail and Amberjack, to the most formidable adversaries in the ocean, like giant Bluefin Tuna, Marlin, cow Yellowfin Tuna and large sharks.



MAXGEAR

Makaira reels feature a forged, machine cut stainless steel main gear paired with a 17-4 stainless steel pinion gear. This gear system is unmatched in this category.



The Makaira is unmatched in elite level spinning reels with a forged, machine cut aluminum body, sideplate and rotor. There are no die-cast parts on this reel. The Mak is the elite reel in the category, with a complete forged aluminum housing.



BEARINGS

CARBON FIBER

The Makaira drag system utilizes the complete surface area of the carbon fiber drag washers; the system has been engineered to make full contact with the outer edges of our carbon washers, which maximizes efficiency and the ability to deliver high drag outputs. The DFD concept applies pressure to both sides of the spool in order to maximize use of the available surface area, enlarging the working surfaces of our drag system, and dramatically improving heat dissipation.



Makaira spinning reels are engineered to withstand the most brutal conditions the ocean can offer. To accomplish this, we equipped this series with 23 different oil-retaining o-rings and gaskets. Our engineers made this reel impervious to the elements, and by making it water tight, all the internal mechanisms are sealed and protected from salt. The result is the best-of-the-best when it comes to big game fishing reels.

MAKAIRA[®] SPINNING REEL

MAKAIRA SPINNING REELS FEATURE:

- Forged aluminum, machine cut body/sideplate
- Forged aluminum, machine cut Cyclonic Flow rotor
- Forged stainless steel main gear for ultimate power and strength
- Precision machine cut 17-4 grade stainless steel pinion gear
- Oversized 17-4 grade stainless steel spool shaft reduces flex
- Hydro Sealed Body and DFD system for maximum protection
- Carbonite high output drag with Cal's drag grease on full DFD
- Customized pre-set drag system, works like a lever drag reel
- 9HPB + 1RB corrosion resistant stainless steel bearings
- Dual anti-reverse system for maximum strength and reliability
- Quick-Set stainless steel German anti-reverse roller bearing
- CRC: Corrosion-resistant coating process
- Machined aluminum, 2-tone anodized spool with LCS lip
- Machined aluminum screw-in handle arm for added strength
- Right and Left handles are designed differently. Order by Rt/Lt
- Heavy duty, solid aluminum bail wire with manual trip function
- Rotor brake system works in conjunction with manual bail trip
- Machined aluminum handle knob: Custom options available



MK-30000LS
(Left Hand Model)



MK-10000R
(Right Hand Model)



MK-20000LS
(Left Hand Model)

MAKAIRA SPINNING

Model	Gear ratio	Bearings	Weight (g)	Line retrieve (cm)	Max Drag Force (kg)	Monofilament line capacity (diameter in mm.)	Frame	Side plates	Rotor	Spool
Left handed High-speed spinning reels										
MK-10000L	4.9:1	9HPB + 1RB	810	101.6	25	0.35/380, 0.40/300, 0.45/225	AL	AL	AL	AL
MK-20000LS	5.8 : 1	9HPB + 1RB	997	131.1	30	0.45/450, 0.50/370, 0.55/300	AL	AL	AL	AL
MK-30000LS	5.8 : 1	9HPB + 1RB	1107	166.9	30	0.55/530, 0.60/450, 0.65/380	AL	AL	AL	AL
Right handed High-speed spinning reels										
MK-10000R	4.9:1	9HPB + 1RB	810	101.6	25	0.35/380, 0.40/300, 0.45/225	AL	AL	AL	AL
MK-20000RS	5.8:1	9HPB + 1RB	997	131.1	30	0.45/450, 0.50/370, 0.55/300	AL	AL	AL	AL
MK-30000RS	5.8:1	9HPB + 1RB	1107	166.9	30	0.55/530, 0.60/450, 0.65/380	AL	AL	AL	AL





AZORES



ALUMINUM MATERIAL WITH STRONG ANTI-CORROSION FEATURE

The unique feature of its anti-corrosion characteristic performs extraordinarily well and is with resistance of 50% stronger than the general material in the market.

HIGH PERFORMANCE BEARING (HPB)

6 high performance ball bearings provide Azores with outstanding smoothness and reliability in salt water fishing environments. The balls used on the HPB's are constructed from the same high-grade stainless steel material as the bearing housing.

- 1. Standard ball bearings : Sealed ball bearings + 30% grease high-grade stainless steel material as the bearing housing.
- 2. Azores ball bearings : Sealed ball bearings + 80% grease



These bearings were designed to be more than 10 times more resistant to saltwater than standard stainless steel bearings.



Oversize carbon and metal washer system

DUAL FORCE DRAG SYSTEM

DFD incorporates both surfaces of the spool to maximize high end drag pressure, efficiency and overall smoothness. Mounted in the top of the spool and protected by the Hydro Block system is a multi disc felt drag system that works in conjunction with a secondary carbon drag system that is mounted under the spool. Even pressure is applied to both surfaces of the spool for maximum stability and significantly increased drag output compared to traditional single drag systems.

DUAL ANTI-REVERSE SYSTEM

The Azores features Okuma's trusted Quick Set anti-reverse system and a backup multi-stop anti reverse system for increased durability and reliability in all fishing conditions.

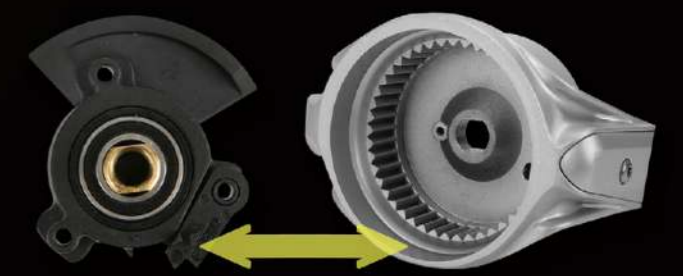

Dual anti-reverse system



AZORES BLUE SALTWATER SPINNING REELS FEATURE:

- DFD: Precision Dual Force Drag system
- Precision click drag adjustment for more precise settings
- Multi-disc, Carbonite and felt drag washers for DFD
- 6HPB + 1RB corrosion resistant stainless steel bearings
- Quick-Set anti-reverse roller bearing plus ratchet system
- Dual anti-reverse system for maximum security
- Azores-40 size only features the Quick-Set anti-reverse function
- Precision machine cut brass pinion gear
- CRC: Corrosion-resistant coating process
- HDGII: Corrosion-resistant, High density gearing
- ALC: Rigid diecast aluminum body, sideplate and rotor
- MSS: carbon Mechanical Stabilizing System
- Machined aluminum, 2-tone anodized spool with LCS lip
- Machined aluminum handle arm for added strength
- Hydro Block water tight drag seal
- Heavy duty, solid aluminum bail wire



AZORES SALTWATER SPINNING REELS FEATURE:

- DFD: Precision Dual Force Drag system
- Precision click drag adjustment for more precise settings
- Multi-disc, Carbonite and felt drag washers for DFD
- 6HPB + 1RB corrosion resistant stainless steel bearings
- Quick-Set anti-reverse roller bearing plus ratchet system
- Dual anti-reverse system for maximum security
- Azores-40 size only features the Quick-Set anti-reverse function
- Precision machine cut brass pinion gear
- CRC: Corrosion-resistant coating process
- HDGII: Corrosion-resistant, High density gearing
- ALC: Rigid diecast aluminum body, sideplate and rotor
- MSS: carbon Mechanical Stabilizing System
- Machined aluminum, 2-tone anodized spool with LCS lip
- Machined aluminum handle arm for added strength
- Hydro Block water tight drag seal
- Heavy duty, solid aluminum bail wire



AZORES-6500



Z-65S



AZORES

Model	Gear ratio	Bearings	Weight (g)	Line retrieve (cm)	Max Drag Force (kg)	Monofilament line capacity (diameter in mm.)	Frame	Sideplates	Rotor	Spool
Azores-4000	5.8:1	6BB + 1RB	341	90.9	13	0.30/180, 0.35/135, 0.40/105	AL	AL	AL	AL
Azores-5500	5.8:1	6BB + 1RB	524	104.6	13	0.35/250, 0.40/190, 0.50/125	AL	AL	AL	AL
Azores-6500	5.4:1	6BB + 1RB	730	110.2	20	0.35/390, 0.40/300, 0.50/185	AL	AL	AL	AL
Azores-8000	5.4:1	6BB + 1RB	748	120.4	20	0.45/310, 0.50/250, 0.55/210	AL	AL	AL	AL
Azores-9000	5.4:1	6BB+1RB	750	120.4	20	0.45/350, 0.50/280, 0.55/240	AL	AL	AL	AL



AZORES

Model	Gear ratio	Bearings	Weight (g)	Line retrieve (cm)	Max Drag Force (kg)	Monofilament line capacity (diameter in mm.)	Frame	Sideplates	Rotor	Spool
High-speed spinning reels										
Z-40S	5.8 : 1	6BB+1RB	341	90.9	13	0.30/180, 0.35/135, 0.40/105	AL	AL	AL	AL
Z-55S	5.8 : 1	6BB+1RB	508	104.6	13	0.35/250, 0.40/190, 0.50/125	AL	AL	AL	AL
Z-65S	5.4 : 1	6BB+1RB	724	110.2	20	0.35/390, 0.40/300, 0.50/185	AL	AL	AL	AL
Z-80S	5.4 : 1	6BB+1RB	748	120.4	20	0.45/310, 0.50/250, 0.55/210	AL	AL	AL	AL
Z-90S	5.4 : 1	6BB+1RB	750	120.4	20	0.45/350, 0.50/280, 0.55/240	AL	AL	AL	AL

Helios SX



Helios SX

HELIOS SX SPINNING REELS FEATURE:

- Light weight C-40X carbon frame and sideplates
- C-40X Cyclonic Flow Rotor for corrosion resistance
- TCA: Torsion Control Armor reduces twisting
- 8HPB + 1RB corrosion resistant stainless steel bearings
- Quick-Set anti-reverse roller bearing
- Precision machine cut brass pinion gear
- ALG: Precision AlumiLite alloy main gear and oscillating gears
- Rigid, machined aluminum, anodized handle
- Light weight, EVA handle knobs for comfort
- Precision Elliptical Gearing system
- Machined aluminum, 2-tone anodized spool
- Heavy duty, solid aluminum bail wire
- RESII: Computer balanced Rotor Equalizing System
- Metal line clip
- LCS line control spool



CYCLONIC FLOW ROTOR

The Cyclonic Flow Rotor (CFR) was designed to create a "cyclonic" airflow, which significantly increases air flow through the ported rotor. This thoroughly tested design allows for a much faster drying



TORSION CONTROL ARMOR

The Torsion Control Armor (TCA) design found on the new Inspria spinning reels is made with Okuma's C-40X long-strand carbon fiber technology. This not only makes the reel lighter, but also makes the reel extremely rigid which reduces twist and torque and keeps the internal parts in perfect alignment.



HELIOS SX SPINNING

Model	Gear ratio	Bearings	Weight (g)	Line retrieve (cm)	Max Drag Force (kg)	Monofilament line capacity (diameter in mm.)	Frame	Sideplates	Rotor	Spool
Standard speed spinning reels										
HSX-30	5.0:1	8HPB + 1RB	202	68.6	6	0.20/300, 0.25/200, 0.30/130	C-40X	C-40X	C-40X	AL
HSX-40	5.0:1	8HPB + 1RB	262	76.2	6	0.25/260, 0.30/180, 0.35/130	C-40X	C-40X	C-40X	AL
High-speed spinning reels										
HSX-40S	5.8:1	8HPB + 1RB	260	91.2	6	0.25/260, 0.30/180, 0.35/130	C-40X	C-40X	C-40X	AL



Inspira

INSPIRA SPINNING REELS FEATURE:

- Light weight C-40X carbon frame and sideplates
- 8BB + 1RB stainless steel bearings
- Quick-Set anti-reverse roller bearing
- Precision machine cut brass pinion gear
- Rigid, forged aluminum, anodized handle
- Light weight, EVA handle knobs for comfort
- Precision Elliptical Gearing system
- Machined aluminum, 2-tone anodized spool
- Heavy duty, solid aluminum bail wire
- CFR: Cyclonic Flow Rotor



INSPIRA

Model	Gear ratio	Bearings	Weight (g)	Line retrieve (cm)	Max Drag Force (kg)	Monofilament line capacity (diameter in mm.)	Frame	Sideplates	Rotor	Spool
Inspira Red version with C-40X finish										
ISX-20R	5.0:1	8BB+1RB	182	60.7	3	0.15/240, 0.20/140, 0.25/90	C-40X	C-40X	GR	AL
ISX-30R	5.0:1	8BB+1RB	213	68.6	6	0.20/300, 0.25/200, 0.30/130	C-40X	C-40X	GR	AL
ISX-40R	5.0:1	8BB+1RB	268	76.2	6	0.25/260, 0.30/180, 0.35/130	C-40X	C-40X	GR	AL
Inspira Blue version with C-40X finish										
ISX-20B	5.0:1	8BB+1RB	182	60.7	3	0.15/240, 0.20/140, 0.25/90	C-40X	C-40X	GR	AL
ISX-30B	5.0:1	8BB+1RB	213	68.6	6	0.20/300, 0.25/200, 0.30/130	C-40X	C-40X	GR	AL
ISX-40B	5.0:1	8BB+1RB	268	76.2	6	0.25/260, 0.30/180, 0.35/130	C-40X	C-40X	GR	AL
Inspira White version										
ISX-20W	5.0:1	8BB+1RB	182	60.7	3	0.15/240, 0.20/140, 0.25/90	C-40X	C-40X	GR	AL
ISX-30W	5.0:1	8BB+1RB	213	68.6	6	0.20/300, 0.25/200, 0.30/130	C-40X	C-40X	GR	AL
ISX-40W	5.0:1	8BB+1RB	268	76.2	6	0.25/260, 0.30/180, 0.35/130	C-40X	C-40X	GR	AL

RTX

RTX SPINNING REELS FEATURE:

- Extremely light weight C-40X carbon frame, sideplate and rotor
- Multi-disc, Japanese oiled felt drag system
- 7BB + 1RB Stainless steel ball bearings
- Quick-Set anti-reverse roller bearing
- ALG: Precision AlumiLite alloy main gear and oscillating gears
- Machined aluminum, 2-tone anodized spool
- Precision Elliptical Gearing system
- Light weight barrel shaped EVA handle knob on 25-40 sizes
- Durable Ergo Grip handle knob on 55-size
- Hydro Block watertight drag seal
- Durable 1-pcs solid aluminum, gun smoke anodized bail wire
- RESII: Computer balanced Rotor Equalizing System



RTX SPINNING

Model	Gear ratio	Bearings	Weight (g)	Line retrieve (cm)	Max Drag Force (kg)	Monofilament line capacity (diameter in mm.)	Frame	Sideplates	Rotor	Spool
High-speed spinning reels										
RTX-30S	6.0:1	7BB+1RB	187	78.2	6	0.20/240, 0.25/155, 0.30/110	C-40X	C-40X	C-40X	AL
RTX-40S	6.0:1	7BB+1RB	232	91.2	6	0.25/300, 0.30/210, 0.35/155	C-40X	C-40X	C-40X	AL



TORSION CONTROL ARMOR DOMINATE WITH POWER

Okuma's Torsion Control Armor (TCA) is a breakthrough in reel design that provides a stronger, more durable, reel construction. TCA technology offers maximum stability by eliminating reel stem twisting and keeping gears aligned; giving the confidence you need in fighting the fish of a lifetime.

Strengthen Against Weak Points

While traditional spinning body designs utilize single-side support, Torsion Control Armor uses a durable double-arm design to help decrease pressure from weak areas and body twisting points.

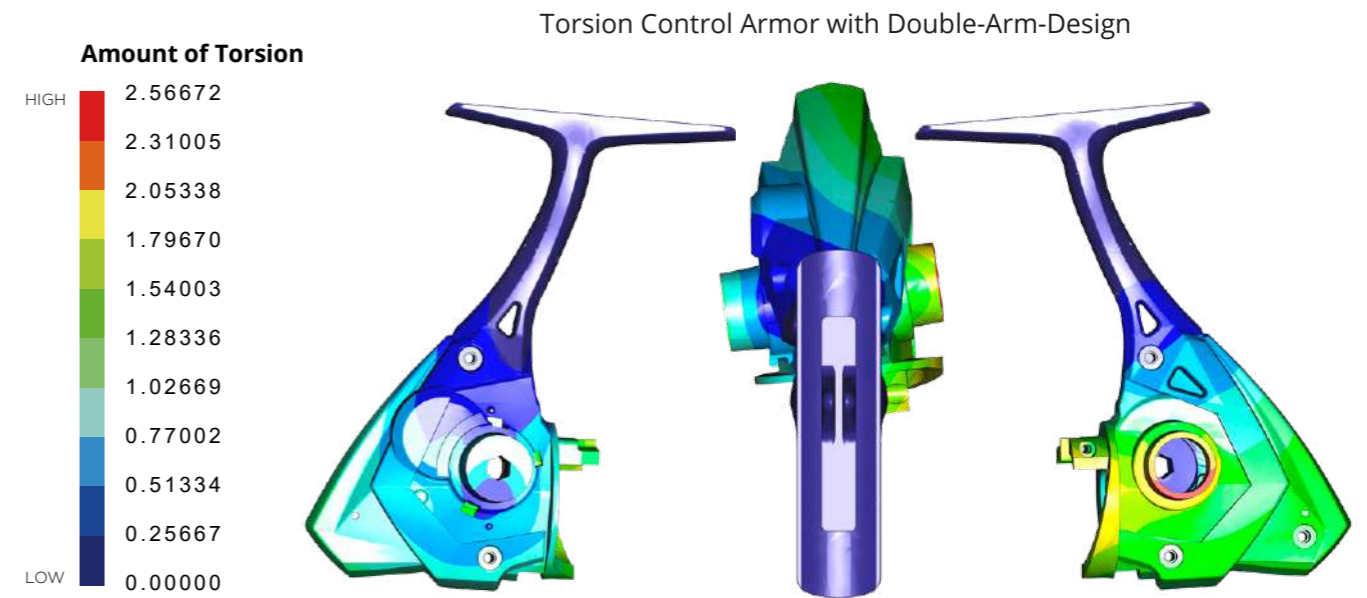
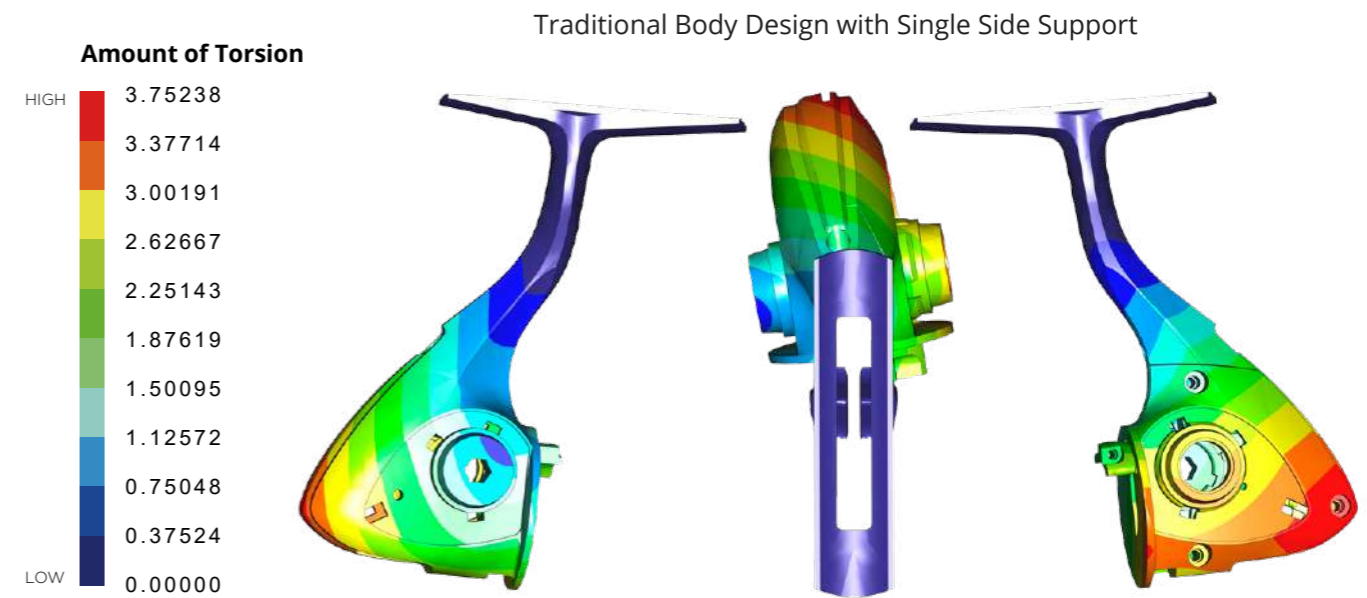

EPIXOR XT

EPIXOR XT SPINNING REELS FEATURE:

- TCA: C40x carbon Torsion Control Armor reduces twisting
- Multi-disc, Japanese oiled felt drag washers
- 7BB+1RB stainless steel bearings
- Quick-Set ant-reverse bearing
- Precision machine cut brass pinion gear
- Slow oscillation system for improved line lay
- Corrosion resistant graphite body and rotor
- CFR: Cyclonic Flow Rotor technology
- Rigid metal handle design for strength
- Machined aluminum, 2-tone anodized spool with LCS lip
- Heavy duty solid aluminum bail wire
- RESII: Computer balanced Rotor Equalizing System



EPXT-30



EPXT-55



(By order-Shallow Spool)

EPIXOR XT SHALLOW SPOOL

Model	PE line capacity (diameter in mm.)
Shallow Spool	
EPXT-20M	PE0.6 (0.128mm) / 150M ; PE0.8 (0.148mm) / 100M ; PE1.0 (0.165mm) / 85M
EPXT-30M	PE0.6 (0.128mm) / 250M ; PE0.8 (0.148mm) / 150M ; PE1.0 (0.165mm) / 130M
EPXT-40M	PE1.0 (0.165mm) / 170M ; PE1.2 (0.185mm) / 150M ; PE1.5 (0.205mm) / 120M
EPXT-55M	PE2.0 (0.235mm) / 210m ; PE2.5 (0.260mm) / 180m ; PE3.0 (0.285mm) / 150m



EPIXOR XT

Model	Gear ratio	Bearings	Weight (g)	Line retrieve(cm)	Max Drag Force (kg)	Monofilament line capacity (diameter in mm.)	Frame	Sideplates	Rotor	Spool
EPXT-20	5.0:1	7BB+1RB	208	61	5	0.15/250,0.20/140,0.25/90	C-40X	GR	GR	AL
EPXT-30	5.0:1	7BB+1RB	249	69	8	0.20/300,0.25/200,0.30/130	C-40X	GR	GR	AL
EPXT-40	5.0:1	7BB+1RB	304	76	10	0.25/260,0.30/180,0.35/130	C-40X	GR	GR	AL
EPXT-55	5.0:1	7BB+1RB	316	87	12	0.30/300, 0.35/220, 0.40/170	C-40X	GR	GR	AL
High-speed spinning reels										
NEW EPXT-30S	6.0:1	7BB+1RB	255	85	8	0.20/300, 0.25/200, 0.30/130	C-40X	GR	GR	AL
NEW EPXT-40S	6.0:1	7BB+1RB	310	94	10	0.25/260, 0.30/180, 0.35/130	C-40X	GR	GR	AL

EPIXOR LS

EPIXOR LS SPINNING REELS FEATURE:

- TCA: C40x carbon Torsion Control Armor reduces twisting
- Multi-disc, Japanese oiled felt drag washers
- 5BB+1RB stainless steel bearings
- Quick-Set ant-reverse bearing
- Precision machine cut brass pinion gear
- Slow oscillation system for improved line lay
- Corrosion resistant graphite body and rotor
- CFR: Cyclonic Flow Rotor technology
- Rigid metal handle design for strength
- Machined aluminum, 2-tone anodized spool with LCS lip
- Heavy duty solid aluminum bail wire
- RESII: Computer balanced Rotor Equalizing System



EPL-30



EPL-55



(By order-Shallow Spool)

EPIXOR LS SHALLOW SPOOL

Model	PE line capacity (diameter in mm.)
Shallow Spool	
EPL-20M	PE0.6 (0.128mm) / 150M ; PE0.8 (0.148mm) / 100M ; PE1.0 (0.165mm) / 85M
EPL-30M	PE0.6 (0.128mm) / 250M ; PE0.8 (0.148mm) / 150M ; PE1.0 (0.165mm) / 130M
EPL-40M	PE1.0 (0.165mm) / 170M ; PE1.2 (0.185mm) / 150M ; PE1.5 (0.205mm) / 120M
EPL-55M	PE2.0 (0.235mm) / 210m ; PE2.5 (0.260mm) / 180m ; PE3.0 (0.285mm) / 150m



EPIXOR LS

Model	Gear ratio	Bearings	Weight (g)	Line retrieve (cm)	Max Drag Force (kg)	Monofilament line capacity (diameter in mm.)	Frame	Sideplates	Rotor	Spool
EPL-20	5.0:1	5BB+1RB	216	61	5	0.15/250,0.20/140,0.25/90	C-40X	GR	GR	AL
EPL-30	5.0:1	5BB+1RB	258	69	8	0.2/300,0.25/200,0.3/130	C-40X	GR	GR	AL
EPL-40	5.0:1	5BB+1RB	315	76	10	0.25/260,0.30/180,0.35/130	C-40X	GR	GR	AL
EPL-55	5.0:1	5BB+1RB	327	87	12	0.30/300, 0.35/220, 0.40/170	C-40X	GR	GR	AL
High-speed spinning reels										
NEW EPL-30S	6.0:1	5BB+1RB	264	85	8	0.20/300, 0.25/200, 0.30/130	C-40X	GR	GR	AL
NEW EPL-40S	6.0:1	5BB+1RB	320	94	10	0.25/260, 0.30/180, 0.35/130	C-40X	GR	GR	AL



Ceymar XT

CETMAR XT REELS FEATURE:

- Multi-disc, Japanese oiled felt drag system
- 7BB+1RB for ultimate smoothness, 6BB+1RB on size 10
- Quick-Set anti-reverse roller bearing
- Precision machine cut brass pinion gear
- Corrosion-resistant graphite body
- Rigid, forged zinc, black anodized handle design
- Light weight, TPE handle knobs for comfort
- Precision Elliptical Gearing system
- Machined aluminum, 2-tone anodized spool
- Heavy duty, solid aluminum bail wire
- RESII: Computer balanced Rotor Equalizing System
- Line control system on the spool for better line casting
- Alum handle with EVA knob
- Plastic line clip
- Spare aluminum spool

Ceymar

CEYMAR SPINNING REELS FEATURE:

- Multi-disc, oiled felt drag system
- 7 BB + 1RB for ultimate smoothness, 6BB+1RB on size 10
- Quick-Set anti-reverse roller bearing
- Precision machine cut brass pinion gear
- Corrosion-resistant graphite body
- Rigid, forged zinc, black anodized handle design
- Light weight, EVA handle knobs for comfort
- C-65 models feature ergo grip handle style
- Precision Elliptical Gearing system
- Machined aluminum, 2-tone anodized spool
- Heavy duty, solid aluminum bail wire
- RESII: Computer balanced Rotor Equalizing System
- Narrow Blade Body Design for reduced fatigue
- Line control system on the spool for better line-lay



C-65



CXT-40



CXTR-40



CEYMAR

Model	Gear ratio	Bearings	Weight (g)	Line retrieve (cm)	Max Drag Force (kg)	Monofilament line capacity (diameter in mm.)	Frame	Sideplates	Rotor	Spool
C-10	5.0:1	6BB+1RB	170	55.4	3	0.10/260, 0.14/150, 0.16/115	GR	GR	GR	AL
NEW C-20	5.0:1	6BB+1RB	190	61	3	0.15/250, 0.20/140, 0.25/90	GR	GR	GR	AL
C-25	5.0:1	7BB+1RB	227	65.5	7	0.15/295, 0.20/170, 0.25/110	GR	GR	GR	AL
C-30	5.0:1	7BB+1RB	232	65.5	7	0.20/200, 0.25/130, 0.30/100	GR	GR	GR	AL
C-35	5.0:1	7BB+1RB	269	76.2	8	0.25/195, 0.30/135, 0.35/100	GR	GR	GR	AL
C-40	5.0:1	7BB+1RB	283	76.2	8	0.25/240, 0.30/170, 0.35/125	GR	GR	GR	AL
C-55	4.5:1	7BB+1RB	403	79.0	15	0.30/325, 0.35/240, 0.40/185	GR	GR	GR	AL
C-65	4.8:1	7BB+1RB	586	97.3	16	0.35/340, 0.40/260, 0.50/160	GR	GR	GR	AL

CEYMAR XT

Model	Gear ratio	Bearings	Weight (g)	Line retrieve (cm)	Max Drag Force (kg)	Monofilament line capacity (diameter in mm.)	Frame	Sideplates	Rotor	Spool	Extra Spool
Ceymar XT -Front Drag											
CXT-10	5.0:1	6BB+1RB	170	55.4	3	0.10/260, 0.14/150, 0.16/115	GR	GR	GR	AL	AL
NEW CXT-20	5.0:1	6BB+1RB	196	61	3	0.15/250, 0.20/140, 0.25/90	GR	GR	GR	AL	AL
CXT-25	5.0:1	7BB+1RB	227	65.5	7	0.15/295, 0.20/170, 0.25/110	GR	GR	GR	AL	AL
CXT-30	5.0:1	7BB+1RB	232	65.5	7	0.20/200, 0.25/130, 0.30/100	GR	GR	GR	AL	AL
CXT-35	5.0:1	7BB+1RB	269	76.2	8	0.25/195, 0.30/135, 0.35/100	GR	GR	GR	AL	AL
CXT-40	5.0:1	7BB+1RB	283	76.2	8	0.25/240, 0.30/170, 0.35/125	GR	GR	GR	AL	AL
CXT-55	4.5:1	7BB+1RB	403	79.0	15	0.30/325, 0.35/240, 0.40/185	GR	GR	GR	AL	AL
CXT-65	4.8:1	7BB+1RB	586	97.3	16	0.35/340, 0.40/265, 0.50/160	GR	GR	GR	AL	AL
Ceymar XT -Rear Drag											
CXTR-30	5.0:1	7BB+1RB	232	65.5	7	0.20/200, 0.25/130, 0.30/100	GR	GR	GR	AL	AL
CXTR-40	5.0:1	7BB+1RB	283	76.2	8	0.25/240, 0.30/170, 0.35/125	GR	GR	GR	AL	AL

AVENGER

AVENGER REELS FEATURE:

- Multi-disc, Japanese oiled felt drag system
- 6BB + 1RB for ultimate smoothness and performance
- Quick-Set anti-reverse roller bearing
- Precision machine cut brass pinion gear
- Corrosion resistant graphite body and rotor
- CFR: Cyclonic Flow Rotor technology
- Precision Elliptical Gearing system



AV-3000LE



AV-3000



AV-8000



AVENGER

Model	Gear ratio	Bearings	Weight (g)	Line retrieve(cm)	Max Drag Force(kg)	Monofilament line capacity (diameter in mm.)	Frame	Sideplates	Rotor	Spool
Avenger Spinning Reels										
NEW AV-500a	5.0:1	6BB+1RB	175	55	3	0.15/145, 0.2/80, 0.25/50	GR	GR	GR	AL
NEW AV-1000a	5.0:1	6BB+1RB	195	61	3	0.15/250, 0.20/140, 0.25/90	GR	GR	GR	AL
AV-2500	5.0:1	6BB+1RB	224	66	7	0.20/230, 0.25/150, 0.30/105	GR	GR	GR	AL
AV-3000	5.0:1	6BB+1RB	220	66	7	0.20/265, 0.25/170, 0.30/115	GR	GR	GR	AL
AV-4000	5.0:1	6BB+1RB	283	76	8	0.25/260, 0.30/180, 0.35/135	GR	GR	GR	AL
AV-6000	4.5:1	6BB+1RB	400	79	15	0.30/275, 0.35/200, 0.40/155	GR	GR	GR	AL
AV-8000	4.8:1	6BB+1RB	572	97	16	0.40/210, 0.45/165, 0.50/135	GR	GR	GR	AL
AV-10000	4.8:1	6BB+1RB	557	97	16	0.40/255, 0.45/200, 0.50/165	GR	GR	GR	AL
NEW AV-14000	4.8:1	6BB+1RB	600	109	16	0.40/370, 0.45/290, 0.50/230	GR	GR	GR	AL
Avenger LE Edition Spinning Reels										
NEW AV-1000-LEa	5.0:1	6BB+1RB	195	61	3	0.15/250, 0.20/140, 0.25/90	GR	GR	GR	AL
AV-3000-LE	5.0:1	6BB+1RB	220	66	7	0.20/265, 0.25/170, 0.30/115	GR	GR	GR	AL
AV-4000-LE	5.0:1	6BB+1RB	283	76	8	0.25/260, 0.30/180, 0.35/135	GR	GR	GR	AL

SKYLINER

SKYLINER REELS FEATURE:

- Corrosion-resistant graphite body
- CFR : Cyclonic Flow Rotor
- 5 ball bearings + 1 roller bearing
- Quick-Set infinite anti-reverse system
- Machine cut brass pinion
- Precision elliptical oscillation
- ESII : Computer balanced Rotor Equalizing System
- Multi-disc, Japanese oiled felt drag washers
- Design rigid handle
- 2 tones aluminum spool
- Metal round line clip
- EVA handle knob on size up to 4000
- TPE handle from size 8000 and up



SKYLINER

Model	Gear ratio	Bearings	Weight (g)	Line retrieve(cm)	Max Drag Force(kg)	Monofilament line capacity (diameter in mm.)	Frame	Sideplates	Rotor	Spool
NEW SKY-500a	5.0:1	5BB+1RB	182	55	3	0.15/145, 0.20/80, 0.25/50	GR	GR	GR	AL
NEW SKY-1000a	5.0:1	5BB+1RB	199	61	3	0.15/250, 0.20/140, 0.25/90	GR	GR	GR	AL
SKY-2500	5.0:1	5BB+1RB	234	66	7	0.20/230, 0.25/150, 0.30/105	GR	GR	GR	AL
SKY-3000	5.0:1	5BB+1RB	231	66	7	0.20/265, 0.25/170, 0.30/115	GR	GR	GR	AL
SKY-4000	5.0:1	5BB+1RB	296	76	8	0.25/260, 0.30/180, 0.35/135	GR	GR	GR	AL
SKY-6000	4.5:1	5BB+1RB	439	79	15	0.30/275, 0.35/200, 0.40/155	GR	GR	GR	AL
SKY-8000	4.8:1	5BB+1RB	635	97	16	0.40/210, 0.45/165, 0.50/135	GR	GR	GR	AL
SKY-10000	4.8:1	5BB+1RB	623	97	16	0.40/255, 0.45/200, 0.50/165	GR	GR	GR	AL
NEW SKY-14000	4.8:1	5BB+1RB	660	109	16	0.40/370, 0.45/290, 0.50/230	GR	GR	GR	AL



SKY-6000

TOMCAT

TOMCAT REELS FEATURE:

- Corrosion-resistant graphite body
- 6 ball bearings + 1 roller bearing
- Quick-Set infinite anti-reverse system
- Machine cut brass pinion
- Precision elliptical oscillation
- Multi-disc, Japanese oiled felt drag washers
- DFD : Dual Force Drag on size 14000
- RES II : Computer balanced Rotor Equalizing System
- Design rigid handle
- TPE Ergo grip handle knob
- 2 tones aluminum spool
- Metal round line clip



TOMCAT

Model	Gear ratio	Bearings	Weight (g)	Line retrieve(cm)	Max Drag Force(kg)	Monofilament line capacity (diameter in mm.)	Frame	Sideplates	Rotor	Spool
NEW TMC-6000	4.5:1	6BB+1RB	445	79	15	0.30/275, 0.35/200, 0.40/155	GR	GR	GR	AL
NEW TMC-8000	4.8:1	6BB+1RB	631	97	16	0.40/210, 0.45/165, 0.50/135	GR	GR	GR	AL
NEW TMC-14000	4.8:1	6BB+1RB	687	109	18 (DFD)	0.40/370, 0.45/290, 0.50/230	GR	GR	GR	AL



TMC-14000

ALARIS

ALARIS REELS FEATURE:

- Multi-disc, Japanese oiled felt drag washers
- 3 ball bearing + 1 roller bearing
- Quick-Set ant-reverse bearing
- Precision machine cut brass pinion gear
- Corrosion resistant graphite body and rotor
- CFR: Cyclonic Flow Rotor technology
- Rigid metal handle design for strength
- Machined aluminum, 2-tone anodized spool with LCS lip
- Corrosion-resistant stainless steel bail wire
- RESII: Computer balanced Rotor Equalizing System



ALS-30

ALARIS

Model	Gear ratio	Bearings	Weight (g)	Line retrieve(cm)	Max Drag Force (kg)	Monofilament line capacity (diameter in mm.)	Frame	Sideplates	Rotor	Spool
Standard speed spinning reels										
ALS-20	4.8:1	3BB+1RB	204	61	5	0.15/250, 0.20/140, 0.25/90	GR	GR	GR	AL
ALS-30	5.0:1	3BB+1RB	237	71	7	0.20/300, 0.25/200, 0.30/130	GR	GR	GR	AL
ALS-40	5.0:1	3BB+1RB	260	85	8	0.25/260, 0.30/180, 0.35/130	GR	GR	GR	AL
NEW ALS-45	5.0:1	3BB+1RB	295	79	9	0.30/240, 0.35/170, 0.40/125	GR	GR	GR	AL
ALS-55	4.5:1	3BB+1RB	422	83	14	0.30/300, 0.35/220, 0.40/170	GR	GR	GR	AL
ALS-65	4.5:1	3BB+1RB	427	87	14	0.40/220, 0.45/170, 0.50/140	GR	GR	GR	AL

Model: ALS-40 Wide Rotor

ALTERA

ALTERA REELS FEATURE:

- Corrosion-resistant graphite body
- CFR : Cyclonic Flow Rotor
- 3 ball bearing + 1 roller bearing
- Quick-Set infinite anti-reverse system
- Machine cut brass pinion gear
- Machine cut 2 tone anodized aluminum spool
- RES II : Computer balanced Rotor Equalizing System
- Rigid metal handle
- TPE handle knob (T-shape on size 55 & 65)
- Multi-disc, Japanese oiled felt drag washers



ATE-40

ATE-65



ALTERA

Model	Gear ratio	Bearings	Weight (g)	Line retrieve(cm)	Max Drag Force (kg)	Monofilament line capacity (diameter in mm.)	Frame	Sideplates	Rotor	Spool
ATE-20	4.8:1	3BB+1RB	203	61	5	0.15/250, 0.20/140, 0.25/90	GR	GR	GR	AL
ATE-30	5.0:1	3BB+1RB	240	71	7	0.20/300, 0.25/200, 0.30/130	GR	GR	GR	AL
ATE-40	5.0:1	3BB+1RB	260	85	8	0.25/260, 0.30/180, 0.35/130	GR	GR	GR	AL
NEW ATE-45	5.0:1	3BB+1RB	295	79	9	0.30/240, 0.35/170, 0.40/125	GR	GR	GR	AL
ATE-55	4.5:1	3BB+1RB	430	83	14	0.30/300, 0.35/220, 0.40/170	GR	GR	GR	AL
ATE-65	4.5:1	3BB+1RB	430	87	14	0.40/220, 0.45/170, 0.50/140	GR	GR	GR	AL

JAW

JAW REELS FEATURE:

- Multi-disc, Japanese oiled felt drag washers
- 3 ball bearing+1 roller bearing
- Precision machine cut brass pinion gear
- Corrosion resistant graphite body and rotor
- CFR: Cyclonic Flow Rotor technology
- Machined aluminum, anodized spool
- Corrosion-resistant stainless steel bail wire
- RESII: Computer balanced Rotor Equalizing System



JAW-30

JAW

Model	Gear ratio	Bearings	Weight (g)	Line retrieve(cm)	Max Drag Force (kg)	Monofilament line capacity (diameter in mm.)	Frame	Sideplates	Rotor	Spool
JAW-20	4.8:1	3BB+1BB	199	61	5	0.15/250, 0.20/140, 0.25/90	GR	GR	GR	AL
JAW-30	5.0:1	3BB+1BB	233	71	7	0.20/300, 0.25/200, 0.30/130	GR	GR	GR	AL
JAW-40	5.0:1	3BB+1BB	259	85	8	0.25/260, 0.30/180, 0.35/130	GR	GR	GR	AL
NEW JAW-45	5.0:1	3BB+1BB	290	79	9	0.30/240, 0.35/170, 0.40/125	GR	GR	GR	AL
JAW-55	4.5:1	3BB+1BB	422	83	14	0.30/300, 0.35/220, 0.40/170	GR	GR	GR	AL

C-FIGHT

C-FIGHT SPINNING REEL FEATURE:

- Corrosion-resistant graphite body and rotor
- Exclusive Okuma black and grey camo covering
- CFR : Cyclonic Flow Rotor
- 3 ball bearing + 1 roller bearing
- Quick-Set infinite anti-reverse system
- Machine cut brass pinion gear
- Machine cut 2 tone anodized aluminum spool
- RES II : Computer balanced Rotor Equalizing System
- Rigid metal handle
- TPE T-shape handle knob
- Multi-disc, Japanese oiled felt drag washers



CF-6000

C-FIGHT

Model	Gear ratio	Bearings	Weight (g)	Line retrieve(cm)	Max Drag Force (kg)	Monofilament line capacity (diameter in mm.)	Frame	Sideplates	Rotor	Spool
NEW CF-6000	4.5:1	3BB+1BB	460	87	14	0.30/320, 0.35/225, 0.40/170	GR	GR	GR	AL

ARIA

ARIA REELS FEATURE:

- Multi-disc, Japanese oiled felt drag washers
- 1 ball bearing drive for smoothness and durability
- Precision machine cut brass pinion gear
- Corrosion resistant graphite body and rotor
- CFR: Cyclonic Flow Rotor technology
- Machined aluminum, anodized spool
- Corrosion-resistant stainless steel bail wire
- RESII: Computer balanced Rotor Equalizing System



ARIA

Model	Gear ratio	Bearings	Weight (g)	Line retrieve(cm)	Max Drag Force (kg)	Monofilament line capacity (diameter in mm.)	Frame	Sideplates	Rotor	Spool
Standard speed spinning reels										
ARIA-20a	4.8:1	1BB	183	61	5	0.15/250, 0.20/140, 0.25/90	GR	GR	GR	AL
ARIA-30a	5.0:1	1BB	220	71	7	0.20/300, 0.25/200, 0.30/130	GR	GR	GR	AL
ARIA-40a	5.0:1	1BB	234	85	8	0.25/260, 0.30/180, 0.35/130	GR	GR	GR	AL
NEW ARIA-45a	5.0:1	1BB	266	79	9	0.30/240, 0.35/170, 0.40/125	GR	GR	GR	AL
ARIA-55a	4.5:1	1BB	375	83	14	0.30/300, 0.35/220, 0.40/170	GR	GR	GR	AL
ARIA-65a	4.5:1	1BB	380	87	14	0.40/220, 0.45/170, 0.50/140	GR	GR	GR	AL

T-shape Handle on size 55 & 65

Fuel Spin

FUEL SPIN REELS FEATURE:

- Multi-disc, Japanese oiled felt drag washers
- 1 ball bearing drive for smoothness and durability
- Precision machine cut brass pinion gear
- Corrosion resistant graphite body and rotor
- Machined aluminum, anodized spool
- CFR: Cyclonic Flow Rotor technology
- Corrosion-resistant stainless steel bail wire
- RESII: Computer balanced Rotor Equalizing System



FUEL SPIN

Model	Gear ratio	Bearings	Weight (g)	Line retrieve(cm)	Max Drag Force (kg)	Monofilament line capacity (diameter in mm.)	Frame	Sideplates	Rotor	Spool
Standard speed spinning reels										
NEW FSP-1000	4.8:1	1BB	199	61	5	0.15/250, 0.20/140, 0.25/90	GR	GR	GR	AL
NEW FSP-3000	5.0:1	1BB	233	71	7	0.20/300, 0.25/200, 0.30/130	GR	GR	GR	AL
NEW FSP-C4000	5.0:1	1BB	259	85	8	0.25/260, 0.30/180, 0.35/130	GR	GR	GR	AL
NEW FSP-5000	5.0:1	1BB	266	79	9	0.30/240, 0.35/170, 0.40/125	GR	GR	GR	AL
NEW FSP-6000	4.5:1	1BB	375	83	14	0.30/300, 0.35/220, 0.40/170	GR	GR	GR	AL
NEW FSP-8000	4.5:1	1BB	380	87	14	0.40/220, 0.45/170, 0.50/140	GR	GR	GR	AL

AZAKI

AZAKI REELS FEATURE:

- Corrosion-resistant graphite body
- 1 ball bearing + 1 roller bearing
- Quick-Set infinite anti-reverse system
- RES II : Computer balanced Rotor Equalizing System
- Design graphite handle
- ABS handle knob (T-shape on size 55 & 65)
- Multi-disc, Japanese oiled felt drag washers
- Machine cut brass pinion
- Aluminum spool
- CFR : Cyclonic Flow Rotor



AZAKI

Model	Gear ratio	Bearings	Weight (g)	Line retrieve(cm)	Max Drag Force (kg)	Monofilament line capacity (diameter in mm.)	Frame	Sideplates	Rotor	Spool
Azaki with Braided Line										
NEW Azaki-20	4.8:1	1BB+1RB	187	61	5	0.15/250, 0.20/140, 0.25/90	GR	GR	GR	AL
Azaki-30	5.0:1	1BB+1RB	216	71	7	0.20/300, 0.25/200, 0.30/130	GR	GR	GR	AL
Azaki-40	5.0:1	1BB+1RB	242	85	8	0.25/260, 0.30/180, 0.35/130	GR	GR	GR	AL
NEW Azaki-45	5.0:1	1BB+1RB	274	79	9	0.30/240, 0.35/170, 0.40/125	GR	GR	GR	AL
Azaki-55	4.5:1	1BB+1RB	404	83	14	0.30/300, 0.35/220, 0.40/170	GR	GR	GR	AL
Azaki-65	4.5:1	1BB+1RB	405	87	14	0.40/220, 0.45/170, 0.50/140	GR	GR	GR	AL
NEW Azaki-30	5.0:1	1BB+1RB	226	71	7	0.20/300, 0.25/200, 0.30/130	GR	GR	GR	AL
NEW Azaki-40	5.0:1	1BB+1RB	257	85	8	0.25/260, 0.30/180, 0.35/130	GR	GR	GR	AL

Pink Pearl V2

PINK PEARL V2 REELS FEATURE:

- Corrosion resistant graphite body and rotor
- 1+1 ball bearing
- Quick-set anti-reverse roller bearing
- Aluminum 2 tones anodized spool
- CFR: Cyclonic Flow Rotor technology
- Multi-disc, Japanese oiled felt drag washers
- RESII: Computer balanced Rotor Equalizing System
- TPE soft touch handle knob



PINK PEARL V2

Model	Gear ratio	Bearings	Weight (g)	Line retrieve(cm)	Max Drag Force (kg)	Monofilament line capacity (diameter in mm.)	Frame	Sideplates	Rotor	Spool
NEW PP2-3000	5.0:1	1BB+1RB	216	71	7	0.20/300, 0.25/200, 0.30/130	GR	GR	GR	AL

DEAD RINGER

DEAD RINGER REELS FEATURE:

- Multi-disc, oiled felt drag washers
- 3BB+1RB bearings drive system, 1BB+1RB on size 10
- Quick-set anti-reverse roller bearing
- Corrosion-resistant graphite body
- Precision Elliptical Gearing System
- Machined aluminum, 2-tone anodized
- RESII: Computer balanced Rotor Equalizing System



DRG-30



DEAD RINGER

Model	Gear ratio	Bearings	Weight (g)	Line retrieve(cm)	Max Drag Force (kg)	Monofilament line capacity (diameter in mm.)	Frame	Sideplates	Rotor	Spool
Dead Ringer -Front Drag										
DRG-10	5.0:1	1BB+1RB	171	53.3	3	0.10/260, 0.14/150, 0.16/115	GR	GR	GR	AL
DRG-25	5.0:1	3BB+1RB	230	68.6	3	0.15/360, 0.20/210, 0.25/140	GR	GR	GR	AL
DRG-30	5.0:1	3BB+1RB	230	68.6	3	0.20/240, 0.25/155, 0.30/110	GR	GR	GR	AL
DRG-40	5.0:1	3BB+1RB	270	71.1	6	0.25/300, 0.30/210, 0.35/155	GR	GR	GR	AL
DRG-55	4.5:1	3BB+1RB	360	88.9	9	0.30/380, 0.35/280, 0.40/215	GR	GR	GR	AL
DRG-65	4.8:1	3BB+1RB	575	91.4	11	0.35/390, 0.40/300, 0.50/185	GR	GR	GR	AL
DRG-80	4.8:1	3BB+1RB	600	101.6	12	0.45/305, 0.50/250, 0.55/205	GR	GR	GR	AL

FINA PRO XP

FINA PRO XP REELS FEATURE:

- Multi-disc, oiled felt drag washers
- 1BB+1RB bearing drive system for smoothness
- Multi-stop anti-reverse system
- Corrosion-resistant graphite body
- Precision Elliptical Gearing System
- Machined aluminum, 2-tone anodized spool
- Durable stainless steel bail wire
- RESII: Computer balanced Rotor Equalizing System



FPX-30



FINA PRO XP

Model	Gear ratio	Bearings	Weight (g)	Line retrieve (cm)	Max Drag Force (kg)	Monofilament line capacity (diameter in mm.)	Frame	Sideplates	Rotor	Spool
Fina Pro XP -Front Drag										
FPX-25	5.0:1	1BB+1RB	227	63.5	3	0.15/360, 0.20/210, 0.25/140	GR	GR	GR	AL
FPX-30	5.0:1	1BB+1RB	232	63.5	3	0.20/240, 0.25/155, 0.30/110	GR	GR	GR	AL
FPX-40	5.0:1	1BB+1RB	283	73.7	6	0.25/300, 0.30/210, 0.35/155	GR	GR	GR	AL
FPX-55	4.5:1	1BB+1RB	403	76.2	6	0.30/380, 0.35/280, 0.40/215	GR	GR	GR	AL
FPX-65	4.8:1	1BB+1RB	584	91.4	11	0.30/390, 0.40/300, 0.50/185	GR	GR	GR	AL
FPX-80	4.8:1	1BB+1RB	607	101.6	11	0.45/305, 0.50/250, 0.55/205	GR	GR	GR	AL

Ceymar XT Match FD

CEYMAR XT MATCH FD REELS FEATURE:

- Corrosion-resistant graphite body
- 7 ball bearing + 1 roller bearing
- Quick Set infinite anti-reverse system
- CFR : Cyclonic Flow Rotor
- Aluminum 2 tone match spool
- Aluminum regular spare spool
- Rigid metal handle, EVA knob
- Precision Elliptical Gearing System
- Hi-speed gear ratio : 6,2:1
- Machined cut brass pinion gear
- Heavy duty, solid aluminum bail wire
- RESII: Computer-balanced rotor system
- Even Flow line roller
- Multi-disc, Japanese oiled felt drag system



CXT-30MS



CEYMAR XT MATCH FD

Model	Gear ratio	Bearings	Weight (g)	Line retrieve(cm)	Max Drag Force (kg)	PE line capacity (diameter in mm.)	Frame	Sideplates	Rotor	Spool	Extra Spool
CXT-30MS	6.2:1	7BB+1RB	241	84	7	PE0.6(0.128mm)-250M PE0.8(0.148mm)-150M PE1.0(0.165mm)-130M	GR	GR	GR	AL	AL
CXT-40MS	6.2:1	7BB+1RB	301	97	8	PE1.0(0.165mm)-170M PE1.2(0.185mm)-150M PE1.5(0.205mm)-120M	GR	GR	GR	AL	AL

Carbonite V2 Match

CARBONITE V2 MATCH BF RD & FD FEATURE:

- Corrosion-resistant graphite body
- CFR : Cyclonic Flow Rotor
- 2 ball bearings + 1 roller bearing
- Quick-Set infinite anti-reverse system
- Aluminum 2 tone match spool
- Round metal line clip
- Regular graphite spare spool
- Rigid metal double handle, EVA knob
- Precision Elliptical Gearing System
- Machined cut brass pinion gear
- RESII: Computer-balanced rotor system
- Even Flow line roller
- Hi-speed gear ratio : 6,2:1



CBV-40MSDH

CBV-40MRS DH



CARBONITE V2 MATCH FD & RD

Model	Gear ratio	Bearings	Weight (g)	Line retrieve(cm)	Max Drag Force (kg)	PE line capacity (diameter in mm.)	Frame	Sideplates	Rotor	Spool	Extra Spool
CBV-40MSDH	6.2:1	2BB+1RB	338	97	8	PE1.0(0.165mm)-170M PE1.2(0.185mm)-150M PE1.5(0.205mm)-120M	GR	GR	GR	AL	GR
CBV-40MRS DH	6.2:1	2BB+1RB	340	97	8	PE1.0(0.165mm)-170M PE1.2(0.185mm)-150M PE1.5(0.205mm)-120M	GR	GR	GR	AL	GR

Custom Black Feeder

CUSTOM BLACK FEEDER FEATURE:

- Corrosion-resistant graphite body
- 7 ball bearing + 1 roller bearing
- Quick Set infinite anti-reverse system
- CFR : Cyclonic Flow Rotor
- Machine cut Aluminum shallow spool
- Aluminum regular spare spool
- Rigid metal handle, EVA knob
- Precision Elliptical Gearing System
- Machined cut brass pinion gear
- Heavy duty, solid aluminum bail wire
- RESII : Computer-balanced rotor system
- Even Flow line roller
- Multi-disc, Japanese oiled felt drag system



CLX-55F

CUSTOM BLACK FEEDER

Model	Gear ratio	Bearings	Weight (g)	Line retrieve(cm)	Max Drag Force (kg)	Monofilament line capacity (diameter in mm.)	Frame	Sideplates	Rotor	Spool	Extra Spool
CLX-40F	5.0:1	7BB+1RB	291	76	8	0.25/180, 0.28/140, 0.30/125	GR	GR	GR	AL	AL
CLX-55F	4.5:1	7BB+1RB	437	79	15	0.30/180, 0.33/150, 0.35/130	GR	GR	GR	AL	AL

Carbonite XP Feeder

CARBONITE XP FEEDER FEATURE:

- Corrosion-resistant graphite body
- CFR : Cyclonic Flow Rotor
- 2 ball bearings + 1 roller bearing
- Quick-Set infinite anti-reverse system
- Aluminum 2 tone shallow spool
- Round metal line clip
- Rigid metal handle, EVA knob
- Precision Elliptical Gearing System
- Machined cut brass pinion gear
- RESII: Computer-balanced rotor system
- Even Flow line roller



CBV-40F

CARBONITE XP FEEDER

Model	Gear ratio	Bearings	Weight (g)	Line retrieve(cm)	Max Drag Force (kg)	Monofilament line capacity (diameter in mm.)	Frame	Sideplates	Rotor	Spool
CBV-40F	5.0:1	2BB+1RB	291	76	8	0.25/180, 0.28/140, 0.30/125	GR	GR	GR	AL
CBV-55F	4.5:1	2BB+1RB	442	79	15	0.30/180, 0.33/150, 0.35/130	GR	GR	GR	AL

Carbonite Match

CARBONITE RD FEATURE:

- Corrosion resistant graphite body and rotor
- 1+1 ball bearing
- Quick-set anti-reverse roller bearing
- Match graphite spool
- Regular extra graphite spool
- CFR: Cyclonic Flow Rotor technology
- RESII: Computer balanced Rotor Equalizing System
- EVA handle knob



CRM-4000S

CARBONITE MATCH

Model	Gear ratio	Bearings	Weight (g)	Line retrieve(cm)	Max Drag Force (kg)	Monofilament line capacity (diameter in mm.)	Frame	Sideplates	Rotor	Spool	Extra Spool
NEW CRM-4000S	5.0:1	1+1BB	264	76	6	PE 0.6 (0.128MM) - 250M PE 0.8 (0.148MM) - 150M PE 1.0 (0.165MM) - 130M	GR	GR	GR	GR	GR

Carbonite

CARBONITE RD FEATURE:

- Corrosion resistant graphite body and rotor
- 1+1 ball bearing
- Quick-set anti-reverse roller bearing
- Graphite spool
- CFR: Cyclonic Flow Rotor technology
- RESII: Computer balanced Rotor Equalizing System
- TPE handle knob



CR-2500

CARBONITE

Model	Gear ratio	Bearings	Weight (g)	Line retrieve(cm)	Max Drag Force (kg)	Monofilament line capacity (diameter in mm.)	Frame	Sideplates	Rotor	Spool
NEW CR-2500	5.0:1	1BB+1RB	218	66	4	0.20/255, 0.25/170, 0.30/110	GR	GR	GR	GR
NEW CR-4000	5.0:1	1BB+1RB	268	76	6	0.25/250, 0.30/170, 0.35/130	GR	GR	GR	GR

COMPRESSA

COMPRESSA REELS FEATURE:

- 3 ball bearings
- Aluminum spool
- Regular handle
- Spare spool



CP-30

COMPRESSA

Model	Gear ratio	Bearings	Weight (g)	Line retrieve (cm)	Max Drag Force (kg)	Monofilament line capacity (diameter in mm.)	Frame	Sideplates	Rotor	Spool	Extra Spool
CP-30	5.0:1	3BB	250	70.6	5	0.20/360, 0.25/230, 0.30/160	GR	GR	GR	AL	GR
CP-40	4.5:1	3BB	340	71.1	7	0.30/270, 0.35/200, 0.40/150	GR	GR	GR	AL	GR
CP-50	4.5:1	3BB	390	78.7	7	0.35/300, 0.40/230, 0.50/140	GR	GR	GR	AL	GR
CP-65	4.5:1	3BB	545	91.4	12	0.35/410, 0.40/320, 0.50/200	GR	GR	GR	AL	GR
CP-80	4.5:1	3BB	585	101.6	12	0.45/320, 0.50/260, 0.55/220	GR	GR	GR	AL	GR

REVENGER

REVENGER REELS FEATURE:

- Multi-disc, oiled felt drag system
- 1 ball bearing for ultimate smoothness
- Multi-stop anti-reverse system
- Graphite spool
- Corrosion-resistant graphite body
- Corrosion-resistant, stainless steel bail wire
- RESII: Computer balanced Rotor Equalizing System



RV-25

REVENGER

Model	Gear ratio	Bearings	Weight (g)	Line retrieve (cm)	Max Drag Force (kg)	Monofilament line capacity (diameter in mm.)	Frame	Sideplates	Rotor	Spool
RV-25	5.0:1	1BB	215	64.5	3	0.15/320, 0.20/190, 0.25/120	GR	GR	GR	GR
RV-30	5.0:1	1BB	215	64.5	5	0.20/220, 0.25/140, 0.30/100	GR	GR	GR	GR
RV-40	5.0:1	1BB	250	76.2	5	0.25/270, 0.30/190, 0.35/140	GR	GR	GR	GR
RV-55	4.5:1	1BB	365	76.2	9	0.30/390, 0.35/285, 0.40/220	GR	GR	GR	GR
RV-65	4.8:1	1BB	560	94.0	11	0.35/360, 0.40/280, 0.50/170	GR	GR	GR	GR
RV-80	4.8:1	1BB	586	104.1	12	0.45/280, 0.50/225, 0.55/190	GR	GR	GR	GR

REVENGER PRO

REVENGER PRO REELS FEATURE:

- Multi-disc, oiled felt drag system
- 1 ball bearing for ultimate smoothness
- Multi-stop anti-reverse system
- Machined aluminum, anodized spool
- Corrosion-resistant graphite body
- Rigid aluminum handle arm for strength
- Corrosion-resistant, stainless steel bail wire
- RESII: Computer balanced Rotor Equalizing System



RVP-30

REVENGER PRO

Model	Gear ratio	Bearings	Weight (g)	Line retrieve (cm)	Max Drag Force (kg)	Monofilament line capacity (diameter in mm.)	Frame	Sideplates	Rotor	Spool
RVP-25	5.0:1	1BB	220	64.5	3	0.15/320, 0.20/190, 0.25/120	GR	GR	GR	AL
RVP-30	5.0:1	1BB	220	64.5	5	0.20/220, 0.25/140, 0.30/100	GR	GR	GR	AL
RVP-40	5.0:1	1BB	260	76.2	5	0.25/270, 0.30/190, 0.35/140	GR	GR	GR	AL
RVP-55	4.5:1	1BB	365	76.2	9	0.30/390, 0.35/285, 0.40/220	GR	GR	GR	AL
RVP-65	4.8:1	1BB	560	94.0	11	0.35/360, 0.40/280, 0.50/170	GR	GR	GR	AL
RVP-80	4.8:1	1BB	586	104.1	12	0.45/280, 0.50/225, 0.55/190	GR	GR	GR	AL

CASCADE

CASCADE REELS FEATURES:

- Multi-disc, oiled felt drag system
- 1 ball bearing for ultimate smoothness
- Multi-stop anti-reverse system
- Silver electroplated ABS spool
- Corrosion-resistant graphite body
- Corrosion-resistant, stainless steel bail wire
- RESII: Computer balanced Rotor Equalizing System



CA-25

CASCADE

Model	Gear ratio	Bearings	Weight (g)	Line retrieve (cm)	Max Drag Force (kg)	Monofilament line capacity (diameter in mm.)	Frame	Sideplates	Rotor	Spool
CA-25	5.0:1	1BB	215	64.5	3	0.15/320, 0.20/190, 0.25/120	GR	GR	GR	GR
CA-30	5.0:1	1BB	215	64.5	5	0.20/220, 0.25/140, 0.30/100	GR	GR	GR	GR
CA-40	5.0:1	1BB	250	76.2	5	0.25/270, 0.30/190, 0.35/140	GR	GR	GR	GR
CA-55	4.5:1	1BB	365	76.2	9	0.30/390, 0.35/285, 0.40/220	GR	GR	GR	GR
CA-65	4.8:1	1BB	560	94.0	11	0.35/360, 0.40/280, 0.50/170	GR	GR	GR	GR
CA-80	4.8:1	1BB	586	104.1	12	0.45/280, 0.50/225, 0.55/190	GR	GR	GR	GR

Aventa

AVENTA BAITFEEDER REELS FEATURE:

- On/Off auto trip bait feeding system
- 6+1RB bearing drive system for smoothness
- Quick set anti-reverse roller bearing
- Precision machine cut brass pinion gear
- Corrosion resistant graphite body
- Slow oscillation precision gearing system
- Machined aluminum spool
- One touch handle with wood knob
- Spare aluminum spool
- Metal line clip
- LCS Line control spool



AB-5000

BAITFEEDING SYSTEM:

Okuma's baitfeeding system allows anglers to disengage their spinning reel spool and allow their bait to run freely. The baitfeeding system incorporates a secondary micro-adjustable drag system at the rear of the reel that allows for precise adjustment of the spool for bait control. In order to disengage this system simply turn the handle. The On/Off lever on the rear of the reel will automatically disengage the baitfeeding system so you can fight your fish with the main drag system.



AVENTA BF

Model	Gear ratio	Bearings	Weight (g)	Line retrieve (cm)	Max Drag Force (kg)	Monofilament line capacity (diameter in mm.)	Frame	Sideplates	Rotor	Spool	Extra Spool
AB-5000	4.8:1	6BB+1RB	527	68.6	12	0.35/235, 0.40/180, 0.50/110	GR	GR	GR	AL	AL
AB-6000	4.8:1	6BB+1RB	533	71.1	12	0.35/280, 0.40/215, 0.50/135	GR	GR	GR	AL	AL
AB-8000	4.8:1	6BB+1RB	763	78.7	15	0.35/405, 0.40/311, 0.50/190	GR	GR	GR	AL	AL
AB-10000	4.8:1	6BB+1RB	778	86.4	15	0.45/310, 0.50/250, 0.55/210	GR	GR	GR	AL	AL

Coronado CDX

CORONADO CDX BAITFEEDER REELS FEATURE:

- On/Off auto trip bait feeding system
- DFD: Precision Dual Force Drag system
- Carbonite drag washers on Dual Force Drag
- Heavy duty, brass DFD and spool shaft stabilizer
- 4HPB+1RB corrosion resistant stainless steel bearings
- Quick-Set anti-reverse bearing allows for zero back play in handle
- CRC: Corrosion-Resistant Coating process
- Machined aluminum, screw in handle system
- Slow oscillation system for improved line lay



CORONADO CDX

Model	Gear ratio	Bearings	Weight (g)	Line retrieve (cm)	Max Drag Force (kg)	Monofilament line capacity (diameter in mm.)	Braided line rating (Tuf line)	Frame	Sideplates	Rotor	Spool
Standard speed spinning reels											
CDX-55	4.4 : 1	4HPB+1RB	550	82.6	12.7	0.30/320,0.35/230,0.40/180	245/50	GR	GR	GR	AL
CDX-60	4.4 : 1	4HPB+1RB	563	86.7	12.2	0.30/375,0.35/275,0.40/210	290/50	GR	GR	GR	AL
CDX-65	4.9 : 1	4HPB+1RB	822	106.0	15.3	0.40/300,0.45/235,0.50/190	315/65	GR	GR	GR	AL
CDX-80	4.9 : 1	4HPB+1RB	855	115.3	17	0.40/380,0.45/300,0.50/240	235/80	GR	GR	GR	AL



CDX-60

AVENGER ABF

AVENGER ABF REELS FEATURE:

- On/Off auto trip bait feeding system
- Multi-disc, Japanese oiled felt drag system
- 6BB + 1RB stainless steel bearing system
- Corrosion resistant frame, sideplate and rotor
- Rigid metal handle design to reduce flex
- RESII: Computer balanced Rotor Equalizing System
- Machined aluminum, 2-tone anodized spool
- Quick-Set anti-reverse roller bearing
- CFR: Cyclonic Flow Rotor technology
- Precision machine cut brass pinion gear



AVENGER BF

Model	Gear ratio	Bearings	Weight (g)	Line retrieve (cm)	Max Drag Force (kg)	Monofilament line capacity (diameter in mm.)	Frame	Sideplates	Rotor	Spool
NEW ABF-500	5.0:1	6+1BB	218	56	3	0.15/145, 0.20/80, 0.25/50	GR	GR	GR	AL
NEW ABF-1000	5.0:1	6+1BB	234	61	3	0.15/250, 0.20/140, 0.25/90	GR	GR	GR	AL
NEW ABF-4000	5.0:1	6+1BB	331	79	10	0.25/285, 0.3/190, 0.35/130	GR	GR	GR	AL
NEW ABF-6000	4.5:1	6+1BB	483	80	12	0.30/320, 0.35/225, 0.40/170	GR	GR	GR	AL
NEW ABF-8000	4.5:1	6+1BB	503	87	12	0.40/230, 0.45/180, 0.50/140	GR	GR	GR	AL



ABF-1000

Longbow XT

Longbow XT Baitfeeder Reels Feature:

- On/Off auto trip bait feeding system
- Multi-disc, oiled felt drag system
- 5+1BB bearing drive system for smoothness
- Multi-stop anti-reverse system
- Corrosion-resistant graphite body
- Precision Elliptical Gearing system
- Machined aluminum anodized spool
- RESII: Computer balanced Rotor Equalizing System
- Metal line clip
- Spare graphite spool
- LCS line control spool



LBXT-630



Longbow XT BF

Model	Gear ratio	Bearings	Weight (g)	Line retrieve (cm)	Max Drag Force (kg)	Monofilament line capacity (diameter in mm.)	Frame	Sideplates	Rotor	Spool	Extra Spool
LBXT-630	5.0:1	5BB+1RB	232	63.5	3	0.20/240, 0.25/155, 0.30/110	GR	GR	GR	AL	GR
LBXT-640	5.0:1	5BB+1RB	283	73.7	6	0.25/300, 0.30/210, 0.35/155	GR	GR	GR	AL	GR
LBXT-655	4.5:1	5BB+1RB	406	76.2	9	0.30/380, 0.35/280, 0.40/215	GR	GR	GR	AL	GR
LBXT-665	4.8:1	5BB+1RB	586	91.4	11	0.35/390, 0.40/300, 0.50/185	GR	GR	GR	AL	GR

Axeon

Axeon Baitfeeder Reels Feature:

- On/Off auto trip bait feeding system
- Multi-disc, oiled felt drag system
- 4+1BB bearing drive system for smoothness
- Multi-stop anti-reverse system
- Corrosion-resistant graphite body
- Precision Elliptical Gearing system
- Machined aluminum, anodized spool
- Durable stainless steel bail wire
- RESII: Computer balanced Rotor Equalizing System
- Metal line clip
- Spare graphite spool



AXB-560



Axeon BF

Model	Gear ratio	Bearings	Weight (g)	Line retrieve (cm)	Max Drag Force (kg)	Monofilament line capacity (diameter in mm.)	Frame	Sideplates	Rotor	Spool	Extra Spool
AXB-560	4.5:1	4BB+1RB	476	101.6	9	0.35/310, 0.40/240, 0.50/140	GR	GR	GR	AL	GR
AXB-565	4.5:1	4BB+1RB	651	104.6	9	0.35/430, 0.40/330, 0.50/200	GR	GR	GR	AL	GR

Barbarian

Barbarian Baitfeeder Reels Feature:

- ON/OFF auto trip bait feeder system
- Multi-disc, Japanese oiled felt drag washers
- 2 ball bearing + 1 roller bearing
- Quick-Set ant-reverse bearing
- Precision machine cut brass pinion gear
- Corrosion resistant graphite body and rotor
- Machined aluminum, spool
- RESII: Computer balanced Rotor Equalizing System
- Zinc diecast double handle



BN-40



Barbarian BF

Model	Gear ratio	Bearings	Weight (g)	Line retrieve (cm)	Max Drag Force (kg)	Monofilament line capacity (diameter in mm.)	Frame	Sideplates	Rotor	Spool	Extra Spool
BN-40	5.0:1	2BB+1RB	351	76.3	6.8	0.25/290, 0.30/200, 0.35/150	GR	GR	GR	AL	GR
BN-55	4.5:1	2BB+1RB	464	79.1	13.4	0.30/300, 0.35/220, 0.40/170	GR	GR	GR	AL	GR

Ceymar

Ceymar Baitfeeder Reels Feature:

- Baitfeeder quick release Aluminum spool
- Multi-disc, oiled felt drag system
- RESII: Computer balanced Rotor Equalizing System
- 2+1BB bearing drive system
- Quick-Set anti-reverse roller bearing
- Precision machine cut brass pinion gear
- Corrosion-resistant graphite body
- Light weight, ABS handle knobs
- Precision Elliptical Gearing system
- Machined aluminum, anodized spool
- Metal line clip
- LCS line control spool
- Extra graphite spool



CMBF-355



Ceymar BF

Model	Gear ratio	Bearings	Weight (g)	Line retrieve (cm)	Max Drag Force (kg)	Monofilament line capacity (diameter in mm.)	Frame	Sideplates	Rotor	Spool	Extra Spool
CMBF-330	5.0:1	2BB+1RB	232	63.5	3	0.20/240, 0.25/155, 0.30/110	GR	GR	GR	AL	GR
CMBF-340	5.0:1	2BB+1RB	283	73.7	6	0.25/300, 0.30/210, 0.35/155	GR	GR	GR	AL	GR
CMBF-355	4.5:1	2BB+1RB	403	76.2	9	0.30/380, 0.35/280, 0.40/215	GR	GR	GR	AL	GR
CMBF-365	4.8:1	2BB+1RB	586	91.4	11	0.35/390, 0.40/300, 0.50/185	GR	GR	GR	AL	GR

Pulzar

PULZAR BAITFEEDER REELS FEATURE:

- Auto-switch freespool system
- Corrosion-resistant graphite body
- 5 ball bearing + 1 roller bearing
- Quick Set infinite anti-reverse system
- CFR : Cyclonic Flow Rotor
- Machine cut aluminum spool
- Round metal line clip
- Graphite spare spool
- Easy folding aluminum handle
- Wooden handle knob
- S-curve oscillation system
- Machined cut brass pinion gear
- Heavy duty, solid aluminum bail wire
- RESII: Computer-balanced rotor system
- Even Flow line roller



PZB-6000



PULZAR BF

Model	Gear ratio	Bearings	Weight (g)	Line retrieve (cm)	Max Drag Force (kg)	Monofilament line capacity (diameter in mm.)	Frame	Sideplates	Rotor	Spool	Extra Spool
PZB-4000	5.0:1	5BB+1RB	333	79	10	0.25/260, 0.30/180, 0.35/130	GR	GR	GR	AL	GR
PZB-6000	4.5:1	5BB+1RB	493	80	12	0.30/300, 0.35/220, 0.40/170	GR	GR	GR	AL	GR
PZB-7000	4.5:1	5BB+1RB	523	87	12	0.40/195, 0.45/150, 0.50/125	GR	GR	GR	AL	GR

Lotus Baitfeeder

LOTUS BAITFEEDER REELS FEATURE:

- Auto-switch freespool system
- Corrosion-resistant graphite body
- 3 ball bearing + 1 roller bearing
- Quick-Set anti-reverse roller bearing
- CFR : Cyclonic Flow Rotor
- Machine cut aluminum spool
- Round metal line clip
- Graphite spare spool
- Rigid metal handle
- T-shape TPE handle knob
- S-curve oscillation system
- Machined cut brass pinion gear
- RESII: Computer-balanced rotor system
- Even Flow line roller



LTB-6000



LOTUS BAITFEEDER

Model	Gear ratio	Bearings	Weight (g)	Line retrieve (cm)	Max Drag Force (kg)	Monofilament line capacity (diameter in mm.)	Frame	Sideplates	Rotor	Spool	Extra Spool
NEW LTB-6000	4.5:1	3BB+1RB	480	80	12	0.30/300, 0.35/220, 0.40/170	GR	GR	GR	AL	GR

DYNA DRAG XP

DYNA DRAG XP BAITFEEDER REELS FEATURE:

- Auto-switch freespool system
- Corrosion-resistant graphite body
- 3 ball bearing + 1 roller bearing
- Quick Set infinite anti-reverse system
- CFR : Cyclonic Flow Rotor
- Machine cut aluminum spool
- S-curve oscillation system
- Machined cut brass pinion gear
- RESII: Computer-balanced rotor system
- Graphite spare spool from size 4000 and up
- Even Flow line roller
- Round metal line clip
- Rigid metal handle
- T-shape TPE knob



DAXP-4000



DYNA DRAG XP FB

Model	Gear ratio	Bearings	Weight (g)	Line retrieve (cm)	Max Drag Force (kg)	Monofilament line capacity (diameter in mm.)	Frame	Sideplates	Rotor	Spool	Extra Spool
NEW DAXP-1000	5.0:1	3BB+1RB	228	61	3	0.15/250, 0.20/140, 0.25/90	GR	GR	GR	AL	
DAXP-4000	5.0:1	3BB+1RB	331	79	10	0.25/260, 0.30/180, 0.35/130	GR	GR	GR	AL	
DAXP-6000	4.5:1	3BB+1RB	482	80	12	0.30/300, 0.35/220, 0.40/170	GR	GR	GR	AL	
DAXP-7000	4.5:1	3BB+1RB	509	87	12	0.40/195, 0.45/150, 0.50/125	GR	GR	GR	AL	

AK

AK BAITFEEDER REELS FEATURE:

- Auto-switch freespool system
- Corrosion-resistant graphite body
- 1 ball bearing + 1 roller bearing
- Quick Set infinite anti-reverse system
- CFR : Cyclonic Flow Rotor
- Aluminum spool
- Design graphite handle
- ABS knob
- S-curve oscillation system
- Machined cut brass pinion gear
- RESII: Computer-balanced rotor system
- Even Flow line roller
- Graphite spare spool



AK-4000



AK BF

Model	Gear ratio	Bearings	Weight (g)	Line retrieve (cm)	Max Drag Force (kg)	Monofilament line capacity (diameter in mm.)	Frame	Sideplates	Rotor	Spool	Extra Spool
AK-4000	5.0:1	1BB+1RB	304	79	10	0.25/260, 0.30/180, 0.35/130	GR	GR	GR	AL	GR
AK-5000	4.5:1	1BB+1RB	458	80	12	0.30/230, 0.35/170, 0.40/130	GR	GR	GR	AL	GR
With mono Line											
NEW AK-6000	4.5:1	1BB+1RB	445	80	12	0.30/300, 0.35/220, 0.40/170	GR	GR	GR	AL	GR

Carbonite V2 Match Baitfeeder

CARBONITE V2 MATCH BAITFEEDER REELS FEATURE:

- Corrosion-resistant graphite body
- Auto-switch freespool system
- CFR : Cyclonic Flow Rotor
- 2 ball bearings + 1 roller bearing
- Quick-Set infinite anti-reverse system
- Shallow Aluminum spool
- Round metal line clip
- Regular graphite spare spool
- Precision Elliptical Gearing System
- Machined cut brass pinion gear
- RESII: Computer-balanced rotor system
- Graphite spare spool



CBV-40MBF



CARBONITE V2 MATCH BF

Model	Gear ratio	Bearings	Weight (g)	Line retrieve (cm)	Max Drag Force (kg)	PE line capacity (diameter in mm.)	Frame	Sideplates	Rotor	Spool	Extra Spool
CBV-40MBF	5.0:1	2BB+1RB	325	76	7	PE1.0(0.165mm)-170M PE1.2(0.185mm)-150M PE1.5(0.205mm)-120M	GR	GR	GR	AL	GR

CARBONITE XP

CARBONITE XP BAITFEEDER REELS FEATURE:

- Baitfeeder quick release graphite spool
- Graphite spool
- With green line
- 1 BB bearing drive system
- Precision Elliptical Gearing System
- Plastic line clip
- Spare graphite spool
- Machined cut brass pinion gear
- RESII: Computer balanced Rotor System
- Even flow roller



CBF-155a



CARBONITE XP

Model	Gear ratio	Bearings	Weight (g)	Line retrieve (cm)	Max Drag Force (kg)	Monofilament line capacity (diameter in mm.)	Frame	Sideplates	Rotor	Spool	Extra Spool
CBF-140a	5.0:1	1 BB	280	71.6	6	0.30/170, 0.35/130, 0.40/100	GR	GR	GR	GR	GR
CBF-155a	4.5:1	1 BB	400	75.7	9	0.35/260, 0.40/200, 0.50/120	GR	GR	GR	GR	GR

LS-6K



FULL COMPACT

LS-6K

LS-6K REELS FEATURE:

- Auto-switch freespool system
- Long Stroke spool trip 30mm
- Corrosion-resistant graphite body
- 5 ball bearing + 1 roller bearing
- Quick Set infinite anti-reverse system
- CFR : Cyclonic Flow Rotor
- Machine cut aluminum spool
- Worm shaft oscillation system
- Machined cut brass pinion gear
- Heavy duty, solid aluminum bail wire
- Precision zinc handle arm with wooden handle knob
- RESII: Computer-balanced rotor system
- Slow oscillation system for improved line lay
- 2 round metal line clips
- Rotor brake system
- Fast progressive drag
- Metal air bail nut



LS-6K



LS-6K

Model	Gear ratio	Bearings	Weight (g)	Line retrieve (cm)	Max Drag Force (kg)	Monofilament line capacity (diameter in mm.)	Frame	Sideplates	Rotor	Spool
LS-6K	5.3:1	5BB+1RB	530	104	12	0.30/370, 0.33/300, 0.35/270	GR	GR	GR	AL

OVERSIZE GEAR

Okuma has redesigned the main transmission gear. Larger diameter + 15% and deeper teeth+15% for maximum power retrieve+30%
Allows now high speed gear ratio for big line retrieve: 103cm

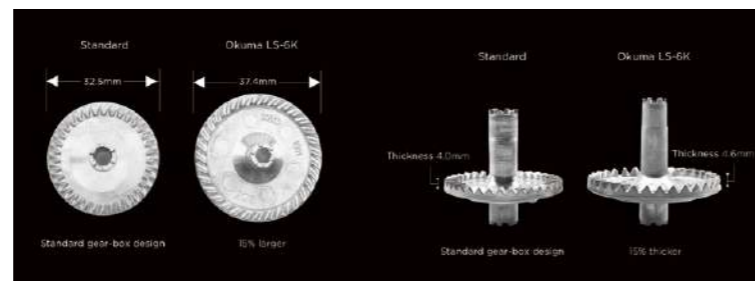

DOUBLE BALL BEARINGS PINION SUPPORT

Ultimate pinion stability for perfect main gear adjustment : super smooth gearing feeling and high durability.



ATOMIC CARP

ATOMIC CARP REELS FEATURE:

- Corrosion resistant graphite body and rotor
- Multi-stop anti-reverse system
- Aluminum anodized spool
- Multi-disc, Japanese oiled felt drag washers
- RESII: Computer balanced Rotor Equalizing System
- EFR II : Even Flow Line Roller
- ABS T-shape handle knob



ATC-7000



ATOMIC CARP

Model	Gear ratio	Bearings	Weight (g)	Line retrieve (cm)	Max Drag Force (kg)	Monofilament line capacity (diameter in mm.)	Frame	Sideplates	Rotor	Spool
NEW ATC-7000	4.5:1	3BB	590	103	15	0.33/370, 0.35/325, 0.38/270	GR	GR	GR	AL

BOOSTER II

BOOSTER II REELS FEATURE:

- Corrosion resistant graphite body and rotor
- Multi-stop anti-reverse system
- Aluminum anodized spool
- Multi-disc, Japanese oiled felt drag washers
- RESII: Computer balanced Rotor Equalizing System
- EFR II : Even Flow Line Roller
- ABS T-shape handle knob



BT-II 7000



BOOSTER II

Model	Gear ratio	Bearings	Weight (g)	Line retrieve (cm)	Max Drag Force (kg)	Monofilament line capacity (diameter in mm.)	Frame	Sideplates	Rotor	Spool
NEW BT II-7000	4.5:1	3BB	587	103	15	0.33/370, 0.35/325, 0.38/270	GR	GR	GR	AL

8K



INSPIRED BY DESIGN

Super Slow Oscillation
Long Stroke Spool : 45mm



8K

8K REELS FEATURE:

- Quick set anti reverse roller bearing
- CFR cyclonic flow rotor
- Slow oscillation system
- 5 ball bearing+1 roller bearing
- Fast drag system
- Double stainless steel line clickers
- Precision worm shaft transmission system
- Rotor brake system
- Hydro block water tight drag seal
- With carbon washers
- Precision zinc handle arm with wooden knob



8K

Model	Gear ratio	Bearings	Weight (g)	Line retrieve(cm)	Max Drag Force (kg)	Monofilament line capacity (diameter in mm.)	Frame	Sideplates	Rotor	Spool
8K	4.7:1	5BB+1RB	743	108	18	0.33/620, 0.35/550, 0.38/470	GR	GR	GR	AL

SLOW OSCILLATION SYSTEM

Makes the line wind more straight and tight, reduce the friction when casting. Uper Long Stroke Spool 45mm.



SUPER LONG STROKE SPOOL 45MM



WORM SHAFT TRANSMISSION SYSTEM

8K equips upgraded worm shaft transmission system, strengthens the construction, let the reel more rigid, makes the line wind more straight and tight, working more smoothly.

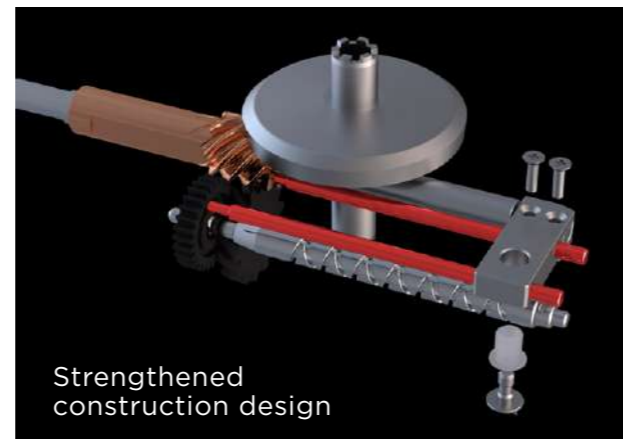

SPARE ALUMINUM SHALLOW SPOOL (ON OPTION)



FAST PROGRESSIVE DRAG

This fast progressive drag allows a setting from low drag power to almost full drag power in less than 360° rotation



ROTOR WITH BRUSH GUARDS

Prevent line twist between rotor and main shaft effectively.

ROTOR BRAKE SYSTEM

Prevent rotor to turn around and reverse when casting.

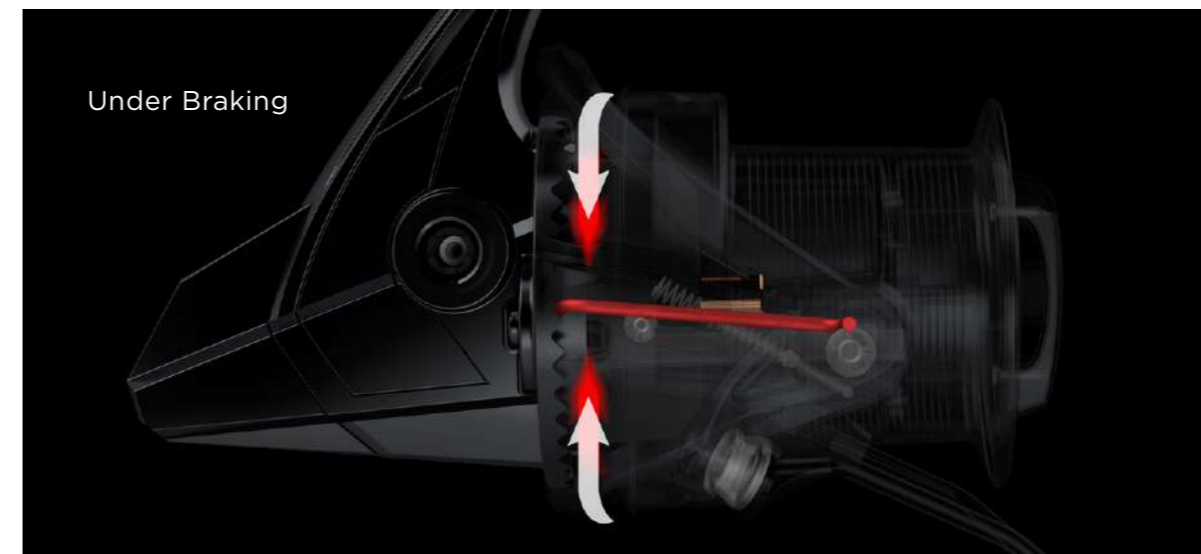

SURF-8K

SURF 8K REELS FEATURE:

- Quick set anti reverse roller bearing
- CFR cyclonic flow rotor
- Slow oscillation system
- Fast drag system
- Double stainless steel line clickers
- Precision worm shaft transmission system
- Rotor brake system
- Hydro block water tight drag seal
- With carbon washers
- Precision zinc handle arm with TPE ergo grip



SURF-8K



SURF 8K

Model	Gear ratio	Bearings	Weight (g)	Line retrieve (cm)	Max Drag Force (kg)	Monofilament line capacity (diameter in mm.)	Frame	Sideplates	Rotor	Spool
SURF-8K	4.7:1	5BB+1RB	763	108	18	0.33/620, 0.35/550, 0.38/470	GR	GR	GR	AL

CUSTOM BLACK

CUSTOM BLACK REELS FEATURE:

- 3 +1 stainless steel bearings
- Quick-Set anti-reverse roller bearing
- Machine cut anodizing alum spool
- Aluminum regular handle
- Hydro block system
- Even flow roller
- Worm shaft transmission system
- LCS line control spool
- Metal line clip
- Spare graphite spool



CB-60



CUSTOM BLACK

Model	Gear ratio	Bearings	Weight (g)	Line retrieve (cm)	Max Drag Force (kg)	Monofilament line capacity (diameter in mm.)	Frame	Sideplates	Rotor	Spool	Extra Spool
CB-60	4.5:1	3BB+1RB	570	102.9	12	0.25/515, 0.30/360, 0.35/270, 0.40/210	GR	GR	GR	AL	GR
CB-80	3.8:1	3BB+1RB	690	92.5	15	0.40/265, 0.45/210, 0.50/170, 0.55/135	GR	GR	GR	AL	GR

T-REX

T-REX SPINNING REELS FEATURE:

- SRS : Solid Reel System
- Crossover Construction design
- Quick-Set anti-reverse roller bearing
- Worm shaft transmission system
- Precision machine cut brass pinion gear
- LCS : Line Control Spool for longer casting distance
- Fast Progressive Drag System
- Multi disc, Japanese oiled felt drag system
- Forged aluminum handle with wooden knob
- Hydro Block water tight drag seal
- Heavy duty, solid aluminum, anodized bail wire
- RESII: Computer balanced Rotor Equalizing System
- Aluminum spool
- Round metal line clip



TR-7000



T-REX

Model	Gear ratio	Bearings	Weight (g)	Line retrieve (cm)	Max Drag Force (kg)	Monofilament line capacity (diameter in mm.)	Frame	Sideplates	Rotor	Spool
TR-7000	4.5:1	6BB+1RB	616	102	12	0.33/370, 0.35/325, 0.38/270	AL/GR	GR	AL/GR	AL

DISTANCE DTA

DISTANCE DTA REELS FEATURE:

- 3 +1RB stainless steel bearings
- Quick-Set anti-reverse roller bearing
- Machine cut anodizing alum spool
- Aluminum regular handle
- Hydro block system
- Even flow roller
- Worm shaft transmission system
- Metal line clip
- LCS line control spool



DTA-60



DISTANCE DTA

Model	Gear ratio	Bearings	Weight (g)	Line retrieve (cm)	Max Drag Force (kg)	Monofilament line capacity (diameter in mm.)	Frame	Sideplates	Rotor	Spool
DTA-60	4.5:1	3BB+1RB	570	100.3	12	0.25/600, 0.30/420, 0.35/310, 0.40/240	GR	GR	GR	AL

DISTANCE SURF ARENA

DISTANCE SURF ARENA REELS FEATURE:

- Slim Blade corrosion-resistant graphite body
- 3 ball bearing + 1 roller bearing
- Quick Set infinite anti-reverse system
- Machine cut aluminum spool
- LCS : round metal line clip
- FPD : Fast Progressive Drag
- Rigid metal handle
- TPE T-Shape handle knob
- Worm Shaft transmission system
- Even Flow line roller
- Hydro block drag system



DSA-60

DISTANCE SURF ARENA

Model	Gear ratio	Bearings	Weight (g)	Line retrieve(cm)	Max Drag Force (kg)	Monofilament line capacity (diameter in mm.)	Frame	Sideplates	Rotor	Spool
DSA-60	4.5:1	3BB+1RB	578	103	16	0.33/320, 0.35/280, 0.38/240	GR	GR	GR	AL
DSA-80	3.8:1	3BB+1RB	673	92	16	0.33/390, 0.35/345, 0.38/295	GR	GR	GR	AL

DISTANCE CARP INTR

DISTANCE CARP INTR REELS FEATURE:

- 9 sealed ball bearings
- Quick-Set anti-reverse one way bearing
- Rotor Equalizing System
- Even flow roller
- Aluminum spool
- Extra spool
- Aluminum handle
- Carbon washer



DCI-60

DISTANCE CARP INTR

Model	Gear ratio	Bearings	Weight (g)	Line retrieve(cm)	Max Drag Force (kg)	Monofilament line capacity (diameter in mm.)	Frame	Sideplates	Rotor	Spool
DCI-60	4.5:1	9BB+1RB	570	100.3	12	0.25/600, 0.30/420, 0.35/310, 0.40/240	GR	GR	GR	AL
DCI-80	3.8:1	9BB+1RB	670	92.5	13	0.25/820, 0.30/575, 0.35/430, 0.40/330	GR	GR	GR	AL

BIG BOMBER SPOD

BIG BOMBER SPOD REELS FEATURE:

- Graphite body construction
- BBD : body blade design
- 3+1 ball bearings
- Quick-Set anti reverse roller bearing
- Machine cut anodized aluminum spool
- 2 round metal line-clips
- Hard metal handle
- TPE Ergo grip handle knob
- XXL Even flow roller
- Worm shaft transmission system
- FPD : Fast Progressive Drag System
- Heavy duty, solid aluminum, anodized bail wire
- RESII: Computer balanced Rotor Equalizing System



BBS-8000S

BIG BOMBER SPOD

Model	Gear ratio	Bearings	Weight (g)	Line retrieve (cm)	Max Drag Force (kg)	Monofilament line capacity (diameter in mm.)	Frame	Sideplates	Rotor	Spool
NEW BBS-8000S	5.1:1	3BB+1RB	720	128	16	0.20/410, 0.22/340, 0.25/270	GR	GR	GR	AL

ROCKAWAY

ROCKAWAY REELS FEATURES:

- 4BB + 1RB stainless steel bearing system
- Quick-Set anti-reverse roller bearing
- 5.3:1 gear ratio with 104cm of line pickup
- Precision machine cut brass pinion gear
- CFR: Cyclonic Flow Rotor technology
- Corrosion resistant frame, sideplate and rotor
- Rigid metal handle design to reduce flex
- Long cast, 2-tone anodized aluminum spool



RA-6000

ROCKAWAY

Model	Gear ratio	Bearings	Weight (g)	Line retrieve(cm)	Max Drag Force (kg)	Monofilament line capacity (diameter in mm.)	Frame	Sideplates	Rotor	Spool
NEW RA-6000	5.3:1	4BB+1RB	486	104	12	0.30/370, 0.33/300, 0.35/270	GR	GR	GR	AL

INC-6000



FULL COMPACT



INC-6000

INC-6000 REELS FEATURES:

- Compact body
- Long Stroke spool 30mm
- Corrosion-resistant graphite body
- 3 ball bearing + 1 roller bearing
- Quick Set infinite anti-reverse system
- CFR : Cyclonic Flow Rotor
- Machine cut aluminum spool
- 2 round metal line clips
- Rigid metal handle with wooden knob
- Worm shaft oscillation system
- Machined cut brass pinion gear
- Heavy duty, solid aluminum bail wire
- RESII: Computer-balanced rotor system
- Even Flow line roller
- Rotor brake system
- Fast progressive drag



INC-6000



INC-6000

Model	Gear ratio	Bearings	Weight (g)	Line retrieve(cm)	Max Drag Force (kg)	Monofilament line capacity (diameter in mm.)	Frame	Sideplates	Rotor	Spool
INC-6000	5.3:1	3BB+1RB	460	104	12	0.30/370, 0.33/300, 0.35/270	GR	GR	GR	AL



BAITCAST REELS

At Okuma Fishing Tackle we deliver more than fishing gear. We deliver the motivation to hit the water, the energy to maintain focus and the excitement that injects every cast with high expectations. From avid recreational angler to touring professional, Okuma baitcast reels are a step above. Find premium features like Japanese ABEC-5 spool bearings and aluminum gears as standard features in tournament models instead of aftermarket upgrades. Our selection is not simply a platform upon which to begin customization, but the best a reel can be at every price.

INSPIRED BY POWER AND STRENGTH



KOMODO SS LOW PROFILE BAITCAST REELS FEATURE:

- Stainless steel main gear for ultimate power and strength
- Precision machine cut stainless steel pinion gear
- Heavy duty stainless steel drive and spool shafts
- ALC: Rigid diecast aluminum frame and sideplates
- CRC: Corrosion-Resistant Coating process
- A6061-T6 machined aluminum, anodized spool
- Multi-disc high output Carbonite drag system
- Micro-click drag star for precise drag settings
- 350 size: 6HPB+1RB corrosion resistant stainless steel bearings
- 450 size: 7HPB+1RB corrosion resistant stainless steel bearings
- Precision Japanese ABEC-5 spool bearings
- Dual anti-reverse for maximum reliability
- Quick-Set anti-reverse roller bearing
- 6-pin Velocity Control casting system
- Synchronized levelwind optimized for braided line
- Zirconium line guide inserts for use with braided line
- Available in both right and left hand retrieve
- On/Off clicker for trolling, chunking or bait fishing



KOMODO SS LOWPROFILES

Model	Gear ratio	Bearings	Weight (g)	Line retrieve (cm)	Max Drag Force (kg)	Monofilament line capacity (diameter in mm.)	Frame	Right Sideplate	Left Sideplate	Spool
Komodo SS Right hand retrieve with twin paddle handle										
KDS-273	7.3:1	6HPB+1RB	238	80	9	0.29/205, 0.33/160, 0.37/125	AL	AL	AL	AL
KDS-364	6.4:1	6HPB+1RB	310	78.7	11	0.33/250, 0.37/230, 0.41/150	AL	AL	AL	AL
KDS-463	6.3:1	7HPB + 1RB	453	85.1	14	0.37/265, 0.42/200, 0.55/115	AL	AL	AL	AL
Komodo SS Right hand retrieve with power handle										
KDS-364P	6.4:1	6HPB+1RB	329	78.7	11	0.33/250, 0.37/230, 0.41/150	AL	AL	AL	AL
Komodo left hand retrieve models with twin paddle handle										
KDS-273LX	7.3:1	6HPB+1RB	238	80	9	0.29/205, 0.33/160, 0.37/125	AL	AL	AL	AL
KDS-364LX	6.4:1	6HPB+1RB	310	78.7	11	0.33/250, 0.37/230, 0.41/150	AL	AL	AL	AL
KDS-463LX	6.3:1	7HPB + 1RB	453	85.1	14	0.37/265, 0.42/200, 0.55/115	AL	AL	AL	AL

JAW



INSPIRED BY DESIGN

Ceymar

CEYMAR LOWPROFILE BAITCAST REELS FEATURE:

- Corrosion-resistant graphite frame and side plates
- A6061-T6 machined aluminum, anodized U-shaped spool
- Multi-disc composite drag system
- 6BB+1RB bearing drive system
- External adjustable magnetic cast control system
- Quick-Set anti-reverse roller bearing
- Side plate access port for quick spool changes
- Ergonomic handle design allows cranking closer to body
- Available gear ratio: 6.6:1



C-266W



CEYMAR LOWPROFILES

Model	Gear ratio	Bearings	Weight (g)	Line retrieve (cm)	Max Drag Force (kg)	Monofilament line capacity (diameter in mm.)	Frame	Right Sideplate	Left Sideplate	Spool
C-266W	6.6:1	6BB+1RB	215	72.4	5	0.29/145, 0.33/115, 0.37/85	GR	GR	GR	AL
C-266WLX	6.6:1	6BB+1RB	215	72.4	5	0.29/145, 0.33/115, 0.37/85	GR	GR	GR	AL

JAW

JAW LOWPROFILE BAITCAST REELS FEATURE:

- Corrosion-resistant graphite frame and side plates
- A6061-T6 machined aluminum, anodized U-shaped spool
- Multi-disc composite drag system
- 6BB+1RB bearing drive system
- External adjustable magnetic cast control system
- Quick-Set anti-reverse roller bearing
- Side plate access port for quick spool changes
- Aluminum handle with EVA handle knobs



J-266WLX



JAW LOWPROFILES

	Model	Gear ratio	Bearings	Weight (g)	Line retrieve (cm)	Max Drag Force (kg)	Monofilament line capacity (diameter in mm.)	Frame	Right Sideplate	Left Sideplate	Spool
NEW	J-266W	6.6:1	6BB+1RB	212	72.4	5	0.29/145, 0.33/115, 0.37/85	GR	GR	GR	AL
NEW	J-266WLX	6.6:1	6BB+1RB	212	72.4	5	0.29/145, 0.33/115, 0.37/85	GR	GR	GR	AL

CITRIX

CITRIX 350-SIZE REELS FEATURE:

- ALC: Rigid diecast aluminum frame and handle side plate
- A6061-T6 machined aluminum, anodized V-shaped spool
- Multi-disc Carbonite drag system
- 7BB+1RB bearings drive system
- Micro-click drag star for precise drag settings
- External adjustable centrifugal cast control system
- Quick-Set anti-reverse roller bearing
- Zirconium line guide inserts for use with braided line
- Easy change palm side plate access port
- Ergonomic handle design allows cranking closer to body
- 6.4:1 gear ratio available in left hand retrieve



Ci-364a



CITRIX LOWPROFILES

Model	Gear ratio	Bearings	Weight (g)	Line retrieve(cm)	Max Drag Force (kg)	Monofilament line capacity (diameter in mm.)	Frame	Right Sideplate	Left Sideplate	Spool
Citrix 350										
Ci-364a	6.4:1	7BB+1RB	312	78.7	11	0.33/250, 0.37/230, 0.41/150	AL	AL	GR	AL
Ci-364LXa	6.4:1	7BB+1RB	312	78.7	11	0.33/250, 0.37/230, 0.41/150	AL	GR	AL	AL

Helios SX

HELIOS SX LOW PROFILE BAITCAST REELS FEATURE:

- ALC: Rigid diecast aluminum frame and sideplates
- CRC: Corrosion Resistant Coating process
- Machined aluminum, ported spool for reduced weight
- Aluminum gears for tournament feel and reduced weight
- Multi-disc Carbonite drag system for power and smoothness
- Micro-click static drag star for Precision drag settings
- Friction free shaft system allows for longer casts
- 10BB + 1RB stainless steel bearings for ultimate smoothness
- Precision Japanese ABEC-5 spool bearings, maximize freespool
- Quick-Set anti-reverse roller bearing
- New generation 12-point adjustable Velocity Control System
- Oversized carbon fiber 100mm length handle for max cranking power



HSX-273V



HELIOS SX LOWPROFILES

Model	Gear ratio	Bearings	Weight (g)	Line retrieve(cm)	Max Drag Force (kg)	Monofilament line capacity (diameter in mm.)	Frame	Right Sideplate	Left Sideplate	Spool
Right handed lowprofile baitcast reels										
HSX-273V	7.3:1	10BB+1RB	179	80	6.4	0.29/145, 0.33/120, 0.37/85	AL	GR	AL	AL
Left handed lowprofile baitcast reels										
HSX-273VLX	7.3:1	10BB+1RB	179	80	6.4	0.29/145, 0.33/120, 0.37/85	AL	GR	AL	AL



CERROS®

CERROS LOW PROFILE BAITCAST REELS FEATURE:

- ALC: Rigid diecast aluminum frame
- A6061-T6 machined aluminum, anodized V-shaped spool
- Multi-disc composite drag system
- 9BB + 1RB bearings drive system
- Micro-click drag star for precise drag settings
- External adjustable magnetic cast control system
- 24-point adjustment on cast control for precise settings
- Quick-Set anti-reverse roller bearing
- Corrosion resistant graphite side plates
- Side plate access port for quick spool changes
- Light weight and comfortable EVA handle knobs
- Available in both right and left hand retrieve



CR-266V



CERROS LOWPROFILES

Model	Gear ratio	Bearings	Weight (g)	Line retrieve(cm)	Max Drag Force (kg)	Monofilament line capacity (diameter in mm.)	Frame	Right Sideplate	Left Sideplate	Spool
Right handed lowprofile baitcast reels										
CR-266V	6.6:1	9BB+1RB	238	80.3	5	0.29/145, 0.33/118, 0.37/86	AL	GR	GR	AL



CONVENTIONAL REELS

Leadership, innovation, and value are not simply concepts for board rooms and Powerpoint presentations. At Okuma Fishing Tackle, these guiding principles are embodied and evident in each and every product.

Our engineering embraces modern fishing lines and the latest in fishing rod construction to develop reels that deliver the most power with minimal weight. We're redefining the relationship between size of reel and size of fish, and taking larger trophies on smaller reels than ever before. Our reels don't intrude on the experience, they enhance it.

TESORO

TESORO STAR DRAG REELS FEATURE:

- 6061-T6 machined aluminum frame, sideplate and spool
- 17-4 grade stainless steel helical cut gearing
- Multi-disc Carbonite drag system with Cal's drag grease
- CRC: Corrosion-Resistant Coating Process
- Swept aluminum star for increased ergonomics
- Anodized aluminum swept handle reduces wobble while cranking
- 4BB+1RB corrosion resistant bearings, spool bearing with TSI oil
- Ergo grip handle knob with anodized aluminum handle arm
- Dual anti-reverse (mechanical and roller bearing)
- XL Gearing: Drop down gear box
- Quick-Set ant-reverse bearing allows for zero back play in handle
- MSS: Mechanical Stabilizing System for increased durability
- Self-lubricating gear system, all models
- High Speed 6.2:1 gear ratio



TSR-5S



TSR-10S



TSR-12S



(Additional purchase)



TESORO STAR DRAG REELS

Model	Gear ratio	Bearings	Weight (g)	Line retrieve(cm)	Max Drag Forcr (kg)	Monofilament line capacity (diameter in mm.)	Frame	Sideplates	Spool
NEW TSR-5NS	6.2:1	4BB+1RB	447	99.1	9	0.32/330, 0.37/230, 0.42/190	AL	AL	AL
TSR-5S	6.2:1	4BB+1RB	472	99.1	9	0.35/325, 0.40/255, 0.45/190	AL	AL	AL
TSR-10S	6.2:1	4BB+1RB	540	116.8	10	0.35/390, 0.40/290, 0.45/225	AL	AL	AL
TSR-12S	6.2:1	4BB+1RB	550	116.8	10	0.40/375, 0.45/270, 0.54/170	AL	AL	AL

Additional Purchase: 120mm Jiggling Handle Assy with T-Bar Handle Knob with Color Box

TSRH-J



CZ-55Wa



CZ-10CSa

CORTEZ

CORTEZ STAR DRAG REELS FEATURE:

- Corrosion resistant graphite frame and sideplates
- CZ-55W features aluminum frame and graphite sideplates
- Machined aluminum, anodized spool
- Multi-disc Carbonite drag system
- Forged aluminum, anodized star
- Anodized aluminum swept handle reduces wobble while cranking
- 4BB+1RB stainless steel bearings
- MCS: External magnetic cast control system on 5CS, 10CS and 12CS sizes
- Ergo grip handle knob
- Dual anti-reverse system (mechanical & roller bearing)
- XL Gearing: Drop down gear box
- Quick-Set anti-reverse roller bearing
- MSS: Mechanical Stabilizing System for increased durability
- Self-lubricating gear system, all models



MCS

Okuma's Magnetic Control System is a fully-sealed, 100% waterproof cast control system that reduces backlash and improves casting distance by utilizing the magnetic field generated by the high RPM spinning of the spool during casting. The magnetic field is influenced by the adjustable cast control magnet which exerts an opposing force and allows for minute and accurate adjustments.



CORTEZ STAR DRAG

Model	Gear ratio	Bearings	Weight (g)	Line retrieve(cm)	Max Drag Force (kg)	Monofilament line capacity (diameter in mm.)	Frame	Side plates	Spool
CZ-5CSa	6.2:1	4BB+1RB	396	96.5	7	0.35/370, 0.40/275, 0.45/200	GR	GR	AL
CZ-10CSa	6.2:1	4BB+1RB	499	109.2	8	0.40/360, 0.45/270, 0.50/220	GR	GR	AL
CZ-12CSa	6.2:1	4BB+1RB	522	109.2	8	0.45/410, 0.50/340, 0.55/280	GR	GR	AL

CONVECTOR

CONVECTOR REELS FEATURE:

- Lightweight corrosion resistant frame and sideplates
- Machined aluminum, gun smoke anodized spool
- Stainless steel reinforcing sideplate rings
- Multi-disc Carbonite drag system
- Ratcheting drag star for precise drag settings
- 2BB+1RB Stainless steel bearing drive system
- Quick-Set anti-reverse roller bearing
- Dual anti-reverse system. (Mechanical & roller bearing)
- Speed Lock pinion gear system
- Durable high-grade brass main and pinion gear system
- XL gearing: Drop down gear box 20, 30, 45 sizes
- Self lubricating gear system, all models
- Wide Mouth levelwind ("L" models): Clearance for copper line
- Ergo grip handle knobs featured on all models
- Stainless steel Body Armor on CV-55L
- MSS: Mechanical Stabilizing System for increased durability



CV-55L



CONVECTOR

Model	Gear ratio	Bearings	Weight (g)	Line retrieve (cm)	Max Drag Force (kg)	Monofilament line capacity (diameter in mm.)	Frame	Sideplates	Spool
Right handed Levelwind reels									
CV-20L	5.1:1	2BB+1RB	454	58.4	8	0.35/270, 0.40/210, 0.45/150	GR	GR	AL
CV-30L	4.0:1	2BB+1RB	593	61.0	9	0.40/420, 0.45/320, 0.50/260	GR	GR	AL
CV-45L	4.0:1	2BB+1RB	635	66.0	9	0.45/450, 0.50/360, 0.55/300	GR	GR	AL
CV-55L	4.0:1	2BB+1RB	984	86.4	10	0.50/570, 0.55/470, 0.60/400	GR	GR	AL

CONVECTOR

LINE COUNTERS

CONVECTOR LINE COUNTER REELS FEATURE:

- Lightweight corrosion resistant frame and sideplates
- Machined aluminum, gun smoke anodized spool
- Stainless steel reinforcing sideplate rings
- Mechanical line counter function measures in feet
- Multi-disc Carbonite drag system
- Ratcheting drag star for precise drag settings
- 2BB+1RB Stainless steel bearing drive system
- Quick-Set anti-reverse roller bearing
- Dual anti-reverse system. (Mechanical & roller bearing)
- Speed Lock pinion gear system
- Durable high-grade brass main and pinion gear system
- XL gearing: Drop down gear box on all models
- Self lubricating gear system, all models
- Wide Mouth levelwind: Clearance for copper line
- Spool stabilizing system for increased durability
- Ergo grip handle knobs featured on all models
- DLX represents left hand crank line counter models
- MSS: Mechanical Stabilizing System for increased durability



CV-30D



CV-20DLX



CONVECTOR LINE COUNTERS

Model	Gear ratio	Bearings	Weight (g)	Line retrieve (cm)	Max Drag Force (kg)	Monofilament line capacity (diameter in mm.)	Frame	Sideplates	Spool
Right handed Linecounter reels									
CV-15D	5.1:1	2BB+1RB	448	58.4	6	0.35/220, 0.40/170, 0.45/130	GR	GR	AL
CV-20D	5.1:1	2BB+1RB	468	58.4	6	0.35/270, 0.40/210, 0.45/150	GR	GR	AL
CV-30D	4.0:1	2BB+1RB	610	61.0	7	0.40/420, 0.45/320, 0.50/260	GR	GR	AL
CV-45D	4.0:1	2BB+1RB	649	66.0	7	0.45/450, 0.50/360, 0.55/300	GR	GR	AL
Right Handed High Speed Linecounters									
CV-30DS	6.2:1	2BB + 1RB	584	94.2	7	0.40/420, 0.45/320, 0.50/260	GR	GR	AL
CV-45DS	6.2:1	2BB + 1RB	638	104.9	7	0.45/450, 0.50/360, 0.55/300	GR	GR	AL
Left handed Linecounter reels									
CV-20DLX	5.1:1	2BB+1RB	468	58.4	6	0.35/270, 0.40/210, 0.45/150	GR	GR	AL
CV-30DLX	4.0:1	2BB+1RB	610	61.0	7	0.40/420, 0.45/320, 0.50/260	GR	GR	AL

CONVECTOR



**INSPIRA BY
PRECISION**

CVT SYSTEM

Clear View Technology anti-fogging line counter



**QUICK
DROP**

QUICK DROP SYSTEM

Quick Drop, switch for precision lure/bait placement



CONVECTOR

CONVECTOR LOWPROFILE LINECOUNTER FEATURE:

- Precision machine cut brass main and pinion gears
- Mechanical line counter function measures in feet
- CVT: Clear View Technology anti-fogging line counter
- 2BB + 1RB stainless steel bearings for long last performance
- Automatic trip, spool engagement mechanism
- A6061-T6 machined aluminum, anodized spool
- Multi-disc high output Carbonite drag system
- Dual anti-reverse for maximum reliability
- Synchronized levelwind optimized for braided line
- Quick Drop, switch for precision lure/bait placement
- Available in both right and left hand retrieve
- On/Off clicker perfect for all trolling applications



CV-354D



CONVECTOR LOWPROFILE LINECOUNTER

Model	Gear ratio	Bearings	Weight (g)	Line retrieve (cm)	Max Drag Force (kg)	Monofilament line capacity (diameter in mm.)	Frame	Left Sideplate	Right Sideplates	Spool
Convector Right hand crank version										
NEW CV-354D	5.4:1	2BB+1RB	332	66	10	0.33/240, 0.37/180, 0.41/145	GR	GR	GR	AL
Convector Left hand crank version										
NEW CV-354DLX	5.4:1	2BB+1RB	332	66	10	0.33/240, 0.37/180, 0.41/145	GR	GR	GR	AL

Cold Water

COLD WATER LINE COUNTER REELS FEATURE:

- Lightweight corrosion resistant frame & sideplates
- Multi-disc, Carbonite drag system
- Aluminum handle arm with Ergo grip handle knobs
- 2BB + 1RB Stainless steel ball bearings
- Quick-set anti-reverse roller bearing
- Oversized machine cut brass XL drive and pinion gears
- Self-lubricating gearing system, all models
- Speed Lock pinion gear system, all models
- Machined aluminum, two tone anodized spool
- Dual anti-reverse system. (Mechanical and roller bearing)
- Mechanical line counter function measures in feet
- CVT: Clear View Technology anti-fogging line counter
- Aluminum ratcheting drag star for precision drag settings
- Wide Mouth levelwind: Clearance for copper lines
- Automatic trip spool engaging mechanism
- MSS: Mechanical Stabilizing System for increased durability
- DLX represent left hand crank line counter models



CW-303D



CW-203D-LE



COLD WATER LINE COUNTERS

Model	Gear ratio	Bearings	Weight (g)	Line retrieve (cm)	Max Drag Force (kg)	Monofilament line capacity (diameter in mm.)	Frame	Sideplates	Spool
Right handed Linecounter reels									
CW-153D	5.1:1	2BB+1RB	414	58.4	6	0.35/220, 0.40/170, 0.45/130	GR	GR	AL
CW-203D	5.1:1	2BB+1RB	425	58.4	6	0.35/270, 0.40/210, 0.45/150	GR	GR	AL
CW-303D	4.2:1	2BB+1RB	567	61.0	7	0.40/420, 0.45/320, 0.50/260	GR	GR	AL
CW-453D	4.2:1	2BB+1RB	618	66.0	7	0.45/450, 0.50/360, 0.55/300	GR	GR	AL
Left handed Linecounter reels									
CW-153DLX	5.1:1	2BB+1RB	414	58.4	6	0.35/220, 0.40/170, 0.45/130	GR	GR	AL
CW-203DLX	5.1:1	2BB+1RB	425	58.4	6	0.35/270, 0.40/210, 0.45/150	GR	GR	AL
CW-303DLX	4.2:1	2BB+1RB	567	61.0	7	0.40/420, 0.45/320, 0.50/260	GR	GR	AL
Ladies Edition reels									
CW-203D-LE	5.1:1	2BB+1RB	425	58.4	6	0.35/270, 0.40/210, 0.45/150	GR	GR	AL
CW-203DLX-LE	5.1:1	2BB+1RB	425	58.4	6	0.35/270, 0.40/210, 0.45/150	GR	GR	AL

Cold Water

COLDWATER COPPER/WIRE LINE REELS



COLDWATER WIRE LINE REELS FEATURE:

- Designed with high speed gear ratios for increased line pickup
- 303/453DS models are high speed line counter reels
- 553LS is a large diameter high speed levelwind reel (no counter)
- Oversized brass XL gearing system
- Multi-disc Carbonite drag washers for maximum efficiency
- 2HPB + 1RB corrosion resistant stainless steel bearings
- Dual anti-reverse system for maximum strength and reliability
- Quick-Set stainless steel anti-reverse roller bearing
- Machined aluminum, anodized spool
- Speed Lock pinion gear system for instant engagement
- Ergo grip handle knob for increased comfort
- Wide Mouth levelwind: Increased knots clearance
- Silent retrieve system for increased smoothness
- MSS: Mechanical Stabilizing System for precise alignment
- XL gearing: Drop down gear box for maximum gear sizing
- Self-lubricating gear system for maximum heat dissipation



CW-553LS



CW-553LS



COLD WATER WIRELINE AND HIGH SPEED LINECOUNTERS

Model	Gear ratio	Bearings	Weight (g)	Line retrieve (cm)	Max Drag Force (kg)	Monofilament line capacity (diameter in mm.)	Frame	Sideplates	Spool
Right handed High-Speed Linecounter reels									
CW-303DS	6.2:1	2BB + 1RB	570	94.2	9	0.40/420, 0.45/320, 0.50/260	GR	GR	AL
CW-453DS	6.2:1	2BB + 1RB	624	104.9	9	0.45/450, 0.50/360, 0.55/300	GR	GR	AL
Right handed High-Speed Levelwind reels									
CW-553LS	4.7:1	2BB + 1RB	870	103.4	9	0.50/570, 0.55/470, 0.60/400	GR	GR	AL

MAGDA AIR *Line Counter*

MAGDA AIR LINE COUNTER REELS FEATURE:

- Frame/sideplate integration offers a stronger option
- Okuma's inverted levelwind system offers dependability by reducing the ability for water and debris to sit on the worm shaft
- Magda Air's new line guide system offers more stability while packing line onto the reel
- Multi disc carbonite drag system
- Ratcheting & static cast control knob for precise setting & security
- 2 stainless steel ball bearings
- Quick set anti reverse system
- Dual anti reverse system
- Durable machine brass main and pinion gear system
- Self lubricating gear system.
- Rigid alum handle arm with Ergo grip handle knob
- MSS: mechanical stabilizing system for increased durability
- Integrated recessed reel foot design for low profile rod fit



MAA-30

Integrated reel foot design:

Allows the reel foot to sit lower on the reel seat similar to a low profile baitcast reel. This design allows the overall frame size of the reel to be a smaller diameter while maximizing the spool diameter and line capacity.

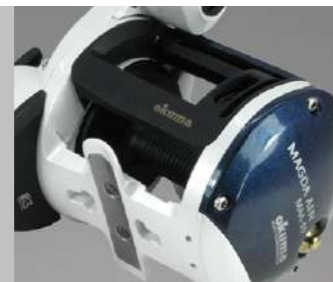

Magda Air's new **Line Guide System** offers more stability while packing line onto the reel, making this a great feature for targeting big fish as well as using with both braided and wire lines which require more strength.



MAGDA AIR

Model	Gear ratio	Bearings	Weight (g)	Line retrieve(cm)	Max Drag Force (kg)	Monofilament line capacity (diameter in mm.)	Frame	Sideplates	Spool
MAA-30	4.1:1	2BB+1RB	511	61.0	7	0.35/490, 0.40/420, 0.45/320	GR	GR	GR

MAGDA PRO *Line Counter*



MAGDA PRO LINE COUNTER REELS FEATURE:

- Lightweight, corrosion-resistant frame and side plates
- Corrosion-resistant graphite spools
- Mechanical line counter function measures in feet
- Multi-disc Carbonite drag system
- 2 Stainless steel ball bearing
- 16-point anti-reverse for improved hookups
- Line counter screw port for improved air access
- Durable Machine cut brass gearing
- Self-Lubricating Gear System, all models
- 20 - 45 sizes with Ergo grip handle knob design
- 15-size features a twin paddle handle configuration
- Automatic trip spool engaging mechanism
- Stainless steel levelwind line guide system
- DLXT represents left hand crank models
- MA-15DXT-T features a twin paddle handle design



MA-45DXT



MAGDA PRO DXT LINECOUNTERS

Model	Gear ratio	Bearings	Weight (g)	Line retrieve (cm)	Max Drag Force (kg)	Monofilament line capacity (diameter in mm.)	Frame	Sideplates	Spool
Right handed Linecounter reels									
MA-15DXT-T	5.1:1	2BB	357	58.4	6	0.35/220, 0.40/170, 0.45/120	GR	GR	GR
MA-20DXT	5.1:1	2BB	366	58.4	6	0.35/270, 0.40/210, 0.45/150	GR	GR	GR
MA-30DXT	4.0:1	2BB	457	61.0	7	0.40/420, 0.45/320, 0.50/260	GR	GR	GR
MA-45DXT	4.0:1	2BB	493	66.0	8	0.45/450, 0.50/360, 0.55/300	GR	GR	GR
Left handed Linecounter reels									
MA-20DLXT	5.1:1	2BB	366	58.4	6	0.35/270, 0.40/210, 0.45/150	GR	GR	GR
MA-30DLXT	4.0:1	2BB	457	61.0	7	0.40/420, 0.45/320, 0.50/260	GR	GR	GR
MAGDA DT									
Right handed Linecounter reels									
MA-15DT-T	5.1:1	0BB	365	58.4	6	0.35/220, 0.40/170, 0.45/130	GR	GR	GR
MA-20DT	5.1:1	0BB	370	58.4	6	0.35/270, 0.40/210, 0.45/150	GR	GR	GR
MA-30DT	4.0:1	0BB	460	61.0	7	0.40/420, 0.45/320, 0.50/260	GR	GR	GR
Left handed Linecounter reels									
MA-20DLT	5.1:1	0BB	370	58.4	6	0.35/270, 0.40/210, 0.45/150	GR	GR	GR

CLASSIC PRO XPD

CLASSIC PRO XPD REELS FEATURE:

- Lightweight corrosion resistant frame and sideplates
- Machined aluminum, anodized spool
- Stainless steel reinforcing sideplate rings
- Mechanical line counter function measures in feet
- Multi-disc Carbonite drag system
- 2 Stainless steel ball bearings
- Durable machine-cut brass gearing
- Ergo Grip handle knob with anodized aluminum handle arm
- Self lubricating gear system, all models
- Stainless steel level-wind line guide system



XPD-30DLXa



XPD-30Da



CLASSIC PRO XPD

Model	Gear ratio	Ball Bearings	Weight (g)	Line retrieve (cm)	Max Drag Force	Monofilament line capacity (diameter in mm.)	Frame	Sideplates	Spool
Right handed Linecounter reels									
XPD-20Da	5.1:1	2BB	390	58.4	6 kg	0.35/270, 0.40/210, 0.45/150	GR	GR	AL
XPD-30Da	4.0:1	2BB	500	61.0	7 kg	0.40/420, 0.45/320, 0.50/260	GR	GR	AL
Left handed Linecounter reels									
XPD-20DLXa	5.1:1	2BB	390	58.4	6 kg	0.35/270, 0.40/210, 0.45/150	GR	GR	AL
XPD-30DLXa	4.0:1	2BB	500	61.0	7 kg	0.40/420, 0.45/320, 0.50/260	GR	GR	AL

CLASSIC PRO

CLASSIC PRO XP REELS FEATURE:

- Lightweight corrosion resistant frame and sideplates
- Machined aluminum, anodized spool
- Ported graphite frame design
- Stainless steel reel foot for strength
- Dependable multi-disc Rulidium drag system
- Classic Pro XP features 2 ball bearings
- Machine cut brass and stainless steel gearing
- Aluminum power handle with T-style knobs
- Self lubricating gear system
- Stainless steel levelwind line guide system



XP-302La



CLX-452La



CLX-200La

CLX REELS FEATURE:

- Lightweight corrosion resistant frame and sideplates
- Corrosion resistant graphite spools
- Ported graphite frame design
- Stainless steel reel foot for strength
- Dependable multi-disc Rulidium drag system
- CLX features a bushing drive
- Aluminum power handle with T-style knobs
- Self lubricating gear system
- Stainless steel levelwind line guide system



CLASSIC PRO XP AND CLASSIC CLX

Model	Gear ratio	Bearings	Weight (g)	Line retrieve (cm)	Max Drag Force	Monofilament line capacity (diameter in mm.)	Frame	Sideplates	Spool
Classic Pro XP levelwind star drag reels									
XP-302La	3.8:1	2BB	441	61.0	6 kg	0.40/420, 0.45/320, 0.50/260	GR	GR	AL
XP-452La	3.8:1	2BB	472	63.5	6 kg	0.45/450, 0.50/360, 0.55/300	GR	GR	AL
Classic CLX Right handed levelwind star drag reels									
CLX-200L a	5.1:1	Bushing	333	58.4	5 kg	0.35/270, 0.40/210, 0.45/150	GR	GR	GR
CLX-300La	3.8:1	Bushing	414	61.0	6 kg	0.40/420, 0.45/320, 0.50/260	GR	GR	GR
CLX-450La	3.8:1	Bushing	441	63.5	6 kg	0.45/450, 0.50/360, 0.55/300	GR	GR	GR
Classic CLX Left handed levelwind star drag reels									
CLX-300LXa	3.8:1	Bushing	414	61.0	6 kg	0.40/420, 0.45/320, 0.50/260	GR	GR	GR
Classic Pro CLX Right handed levelwind star drag reels									
CLX-302La	3.8:1	2BB	438	61.0	6 kg	0.40/420, 0.45/320, 0.50/260	GR	GR	GR
CLX-452La	3.8:1	2BB	474	63.5	6 kg	0.45/450, 0.50/360, 0.55/300	GR	GR	GR
Classic Pro CLX Left handed levelwind star drag reels									
CLX-302Lxa	3.8:1	2BB	438	61.0	6 kg	0.40/420, 0.45/320, 0.50/260	GR	GR	GR

MAKAIRA REELS WITH TDC DRAG CAMS

MAKAIRA®



DUAL FORCE DRAG SYSTEM

The specialized carbon DFD or Dual Force Drag system used on all Makaira reels was specifically engineered to be mounted in the right side of the spool in order to bring all the mechanical workings closer together to maximize alignment and durability. The farther mechanical parts are separated the more opportunity there is for tolerance error and flexing which causes parts alignment issues. The DFD principal was specifically designed around the "Pull Bar Drag System". The major advantage to a "Pull Bar Drag System" is that the drag is being pulled rather than pushed. The most common type of lever drag in the industry is the "Push Bar Drag System". The Push Bar System places heavy pressure on the left side plate and utilizes the frame for overall stability

which is a fatal flaw in this type of design. This pressure creates frame flex, reducing drag pressure and causing tolerance alignment issues. This problem is further exaggerated on open top designs from other companies. One of the major benefits to the pull bar design is that there is no pressure placed on the frame. Therefore, our open top frame designs will not suffer frame flex found in our competitors reels.

This highly efficient drag system was designed and engineered by Tiburon Engineering USA to increase maximum drag pressure, reduce side load pressure on ball bearings and improve heat dissipation for long term smoothness over extended periods. This Okuma DFD is considered a wet drag system comprised of two carbon fiber drag washers that are sandwiched together and bonded with a fiber glass core. Pure carbon washers are coated with a thin layer of Cal Sheet's Universal drag grease for virtually zero start up inertia. These washers are compressed by two precision ground 17-4 grade stainless steel drag plates that have been ground flat then polished for maximum smoothness. These stainless steel friction drag plates have a minimum 32 Rockwell hardness allowing for high-end drag settings and consistently smooth drag performance at all ranges. The drag system is secured to the right side of the spool by a 6061-T6 grade aluminum cover that features Type-II anodizing for maximum alignment, strength and corrosion resistance.



MK-8II/10II/15II/15TII

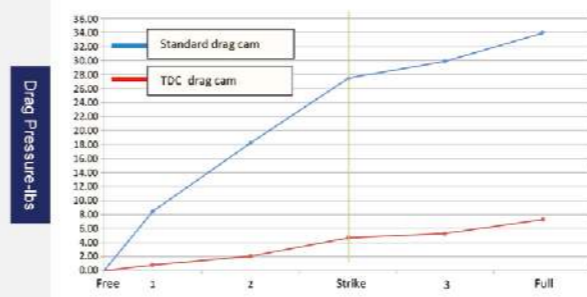

MK8II/10II/15II-Line class 15 lbs

Drag Lever Position	1	2	Strike	3	Full
Standard drag cam	8.6	18.6	27.3	30.2	34.1
TDC drag cam	0.9	2.1	4.7	5.5	7.0



MK-16II/20II



MK-30II

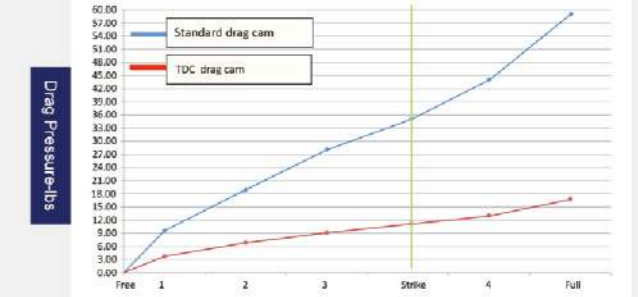

MK16II/20II/30II-Line class 30 lbs

Drag Lever Position	1	2	3	Strike	4	Full
Standard drag cam	10.5	19.2	28.3	38.2	44.6	59.3
TDC drag cam	4.2	7.0	9.1	11.4	13.7	17.5



MK-50II/MK-50WII

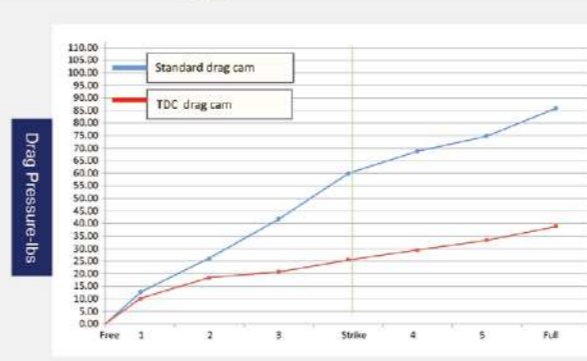

MK50II/50WII-Line class 50 lbs

Drag Lever Position	1	2	3	Strike	4	5	Full
Standard drag cam	12.0	26.1	42.7	59.6	67.6	75.8	86.7
TDC drag cam	10.3	17.7	21.4	26.2	29.1	33.2	38.9



MK-80WII / 130II

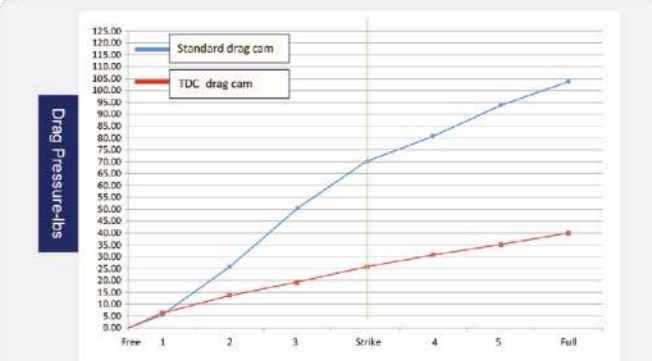

MK80WII/130II-Line class 80 lbs

Drag Lever Position	1	2	3	Strike	4	5	Full
Standard drag cam	4.8	26.5	51.1	69.7	81.0	93.1	103.4
TDC drag cam	5.5	13.6	19.3	26.1	31.0	35.3	39.4

MAKAIRA®

**TOURNAMENT DRAG CAM
IGFA LINE CLASSES FOR MAKAIRA**



TDC-80WII/130II



TDC-50II/50WII



TDC-16II/20II/30II



TDC-8II/10II/15II/15TII

TROLLING REELS



Okuma's TDC or "Tournament Drag Cam" is designed with a more gradual ramp in the cam system that is intended for anglers fishing light line and tournament IGFA line classes. The standard cam that is installed in the Makaira reels is engineered to be compatible with braided line and offers aggressive drag ramps in order to output heavy drag ratings. The Makaira reels are engineered to output extreme drag pressure, but this is not required by all anglers. These reels have been designed to offer customization and with the TDC cam system, Okuma is offering anglers a reel that is versatile for a wide range of fishing applications, allowing anglers the ability to achieve a more gradual increase in drag settings.

Model	Description
TDC-8II/10II/15II/15TII	Makaira Tournament Drag Cam
TDC-16II/20II/30II	Makaira Tournament Drag Cam
TDC-50II/50WII	Makaira Tournament Drag Cam
TDC-80WII/130II	Makaira Tournament Drag Cam

SILENT ANTI-REVERSE:

The Makaira's proprietary anti-reverse system allows for a smoother and quieter feeling. We equate this feeling to that of a Lexus, when compared to other reels in the market. Most reels in the market hide their rough gear quality by the noise and vibration caused by the engagement and clacking of the anti-reverse pawls. The Okuma silent system is unlike any other 2-speed reel in the industry for smoothness. This anti-reverse system is supported by a 12 point double dog anti-reverse pawl system. The Makaira system is very simple in principal but the performance is extremely advanced. As you turn the reel forward the anti-reverse pawls slide open allowing a friction free and quiet retrieve. As soon as the handle is stopped or pulled backwards the anti-reverse pawls are engaged into place by their drive shaft actuated sliding system. The strength of this anti-reverse system does not solely rely on a dog spring like found on most of our competitors reels. The sliding function does not rely heavily on a dog spring system and is mainly controlled by the forward and reverse movement applied to the drive shaft through the movement of the angler turning the handle.



HELICAL CUT GEARING:

Makaira lever drag reels utilize helical cut main and pinion gears. This process allows for improved gear meshing which equates to improved gear smoothness. The angled teeth found in helical cut gears engage more gradually than straight cut or spur gear teeth. This allows helical gears to run smoother and quieter compared to spur gears. Spur gears cause impact stress and noise, because of the hard meshing and can not take as much torque as helical gears because their teeth are receiving impact blows as they mesh together.



GREASE AND OIL:

To further enhance the corrosion resistance of Makaira reels, Okuma applies our CRC or Corrosion Resistant Coating process to all internal and external parts for maximum protection. Our CRC process utilizes a coating process of Corrosion X HD formula that actually penetrates and bonds to the aluminum parts for long term protection. The extra steps taken in the assembly of the Makaira allows this reel to be a leader in the fishing tackle industry for long term use and performance. To further enhance the Makaira's function and performance, Okuma applies Cal's Universal drag grease to our carbon fiber drag washers for the smoothest wet drag system. The addition of Cal's drag grease allows for virtually zero start up inertia and smooth performance at all settings. Cal's Universal grease is also used for coating moving parts such as the main and pinion gears for improved performance.



MAKAIRA

Model	Type of braid	Braided Line Length	Top shot length
Braid Line Capacity for Makaira Reels			
MK-10II	Solid	300-yds of 50-lbs	75 to 100-yds of 20 to 40-lbs
MK-15II	Solid	300-yds of 65-lbs	80 to 100-yds of 30 to 50-lbs
MK-15TII	Solid	450-yds of 80-lbs	15-yds top shot
MK-16II	Hollow Core	600-yds of 100-lbs	50 ft. wind on leader
MK-20II	Hollow Core	700-yds of 100-lbs	50 ft. wind on leader
MK-30II	Hollow Core	800-yds of 100-lbs (HC)	80-yds of 80-lbs
MK-50II	Hollow Core	600-yds of 130-lbs (HC)	50 to 80-yds of 80 to 100-lbs
MK-50WII	Hollow Core	800-yds of 130-lbs (HC)	50 to 80-yds of 80 to 100-lbs
MK-80WII	Hollow Core	1000-yds of 80-lbs (HC)	80 to 100-yds of 130-lbs

TROLLING REELS

MAKAIRA®

MAKAIRA REELS FEATURE:

- 6061-T6 machined aluminum frame with forged side plates
- 17-4 grade stainless steel gearing
- Helical cut gears for increased torque, smoothness and improved gear meshing
- Makaira reels all feature two-speed gearing systems
- Gold anodized two-speed gear shifter housing
- Cold forged, Type-II anodized, machined aluminum spool
- CRC: Corrosion Resistant Coating process
- Patented spool pin system for use with braided or mono lines
- Carbonite Dual Force drag system featuring Cal's universal drag grease
- Custom designed thrust bearing: Alleviates side load on heavy drag settings
- 4-pcs ABEC-5 precision Sapporo stainless steel ball bearings
- MK-80WII features 6-pcs of Sapporo ball bearings
- Double-dog, proprietary silent anti-reverse system
- Ratcheting drag lever and pre-set knob for precise drag setting
- Patented T-Bar handle with Easy Roll graphite insert on all models
- Heavy duty stainless steel ratcheting clicker system
- Heavy duty, 17-4 grade stainless steel drive and spool shafts
- Type-II gold anodized frame, sideplates, spool, drag lever and handle
- Open top frame design on 10II, 15II, 16II, 20II, and 50II
- Lug and plug system on all open top reel models
- Machined thumb rest on rear cross bar for improved ergonomics
- Forged aluminum full hard anodized reel foot and reel clamp
- Machine-etched marlin logo on left side plate
- Precision placement of drain holes maximizes water removal from reel
- Special screw ports around side plate screws reduces water/corrosion buildup



MAKAIRA

Model	Gear ratios	Bearings	Weight (g)	Line retrieve(cm)	Monofilament line capacity (diameter in mm.)	Max Drag @ Strike with Freespool	Max Drag @ Full with Freespool	Frame style	Frame	Sideplates	Spool
Two-Speed Lever Drag Reels											
MK-10II	4.7:1 & 2.1:1	4BB + 1TB	740	85.1 & 38.1	0.37/420, 0.42/350, 0.48/260	12.3 kg	15.4 kg	Topless	AL	AL	AL
MK-15II	4.7:1 & 2.1:1	4BB + 1TB	780	85.1 & 38.1	0.42/500, 0.48/370, 0.55/280	12.3 kg	15.4 kg	Topless	AL	AL	AL
MK-16II	4.3:1 & 1.3:1	4BB + 1TB	1160	99.6 & 30.0	0.42/800, 0.48/600, 0.55/450	15.4 kg	21.7 kg	Topless	AL	AL	AL
MK-20II	3.8:1 & 1.7:1	4BB + 1TB	1298	100.1 & 44.5	0.48/800, 0.55/600, 0.60/480	16.8 kg	25.0 kg	Topless	AL	AL	AL
MK-30II	3.8:1 & 1.7:1	4BB + 1TB	1417	100.1 & 44.5	0.55/700, 0.60/640, 0.70/500	16.8 kg	25.0 kg	Crossbar	AL	AL	AL
MK-50II	3.2:1 & 1.3:1	4BB + 1TB	1741	96.0 & 38.9	0.55/910, 0.70/590, 0.90/360	27.2 kg	39.0 kg	Topless	AL	AL	AL
MK-50WII	3.2:1 & 1.3:1	4BB + 1TB	1843	96.0 & 38.9	0.70/820, 0.75/710, 0.90/510	27.2 kg	39.0 kg	Crossbar	AL	AL	AL
MK-80WII	3.1:1 & 1.2:1	6BB + 1TB	3289	116.1 & 52.9	0.90/910, 1.00/770, 1.12/600	32.1 kg	45.4 kg	Crossbar	AL	AL	AL
MK-130II	2.2:1 & 1.2:1	6BB + 1TB	4750	100.8 & 55.1	0.90/1450, 1.00/1170, 1.12/920	34.1 kg	45.4 kg	Crossbar	AL	AL	AL

MAKAIRA[®]

SPECIAL EDITION

MAKAIRA SEa REELS FEATURE:

- Open spool bearings with TSI-301 oil. Increases freespool 2-1/2 times.
- MK80WIISEa and MK-130IIESEa feature grease-packed spool bearings
- All non-spool bearings feature full grease pack for maximum longevity.
- Features Special Edition Gun Smoke and Black anodizing.
- SEa reels feature a yellowfin tuna etched into the sideplate.
- Frames have been machined out for increased clearance between spool and cross bars.
- MK-10/15 feature MK-20 size handle knobs.
- MK-20/30 feature the MK-50 handle arm and knobs
- Lower speed 1.3:1 gear ratio featured in 20/30 sizes.
- Lower speed 1.0:1 gear ratio featured in 50 size.
- Type-II gun smoke anodized frame, side plates and drag lever



MK-10IIESEa



MK-15IIESEa



MK-50WIISEa



MK-15TIIESEa



MK-130WIISEa



MK-80WIISEa



MAKAIRA SEa

Model	Gear ratios	Bearings	Weight (g)	Line retrieve(cm)	Monofilament line capacity (dia. in mm.)	Max-Drag		Frame style	Frame	Sideplates	Spool
						Strike with Freespool	@ Full with Freespool				
Two-Speed Lever Drag Reels											
MK-10IIESEa	4.7:1 & 2.1:1	4BB + 1TB	740	85.1 & 38.1	0.37/420, 0.42/350, 0.48/260	12.3 kg	15.4 kg	Topless	AL	AL	AL
MK-15IIESEa	4.7:1 & 2.1:1	4BB + 1TB	760	85.1 & 38.1	0.42/500, 0.48/370, 0.55/280	12.3 kg	15.4 kg	Topless	AL	AL	AL
MK-15TIIESEa	4.7:1 & 2.1:1	4BB + 1TB	822	98.8 & 43.4	0.45/525, 0.48/385, 0.55/295	14.5 kg	18.2 kg	Topless	AL	AL	AL
MK-16IIESEa	4.3:1 & 1.3:1	4BB + 1TB	1134	99.6 & 30.0	0.42/800, 0.48/600, 0.55/450	15.4kg	21.7kg	Topless	AL	AL	AL
MK-20IIESEa	3.8:1 & 1.3:1	4BB + 1TB	1298	100.1 & 33.5	0.48/800, 0.55/600, 0.60/480	16.8 kg	25.0 kg	Topless	AL	AL	AL
MK-30IIESEa	3.8:1 & 1.3:1	4BB + 1TB	1417	100.1 & 33.5	0.55/770, 0.60/640, 0.70/500	16.8 kg	25.0 kg	Topless	AL	AL	AL
MK-50IIESEa	3.2:1 & 1.0:1	4BB + 1TB	1707	96.0 & 30.2	0.55/910, 0.70/590, 0.90/360	27.2 kg	39.0 kg	Topless	AL	AL	AL
MK-50WIISEa	3.2:1 & 1.0:1	4BB + 1TB	1843	96.0 & 30.2	0.70/820, 0.75/710, 0.90/510	27.2 kg	39.0 kg	Crossbar	AL	AL	AL
MK-80WIISEa	3.1:1 & 1.2:1	6BB + 1TB	3289	116.1 & 52.1	0.90/910, 1.00/770, 1.12/600	32.1 kg	45.4 kg	Crossbar	AL	AL	AL
MK-130IIESEa	2.2:1 & 1.2:1	6BB + 1TB	4750	100.8 & 55.1	0.90/1450, 1.00/1170, 1.12/920	34.1 kg	45.4 kg	Crossbar	AL	AL	AL

MAKAIRA®

MAKAIRA SEa SILVER REELS FEATURE:

- Open spool bearings with TSI-301 oil. Increases freespool 2-1/2 times.
- MK80WII SEa Silver and MK-130II SEa Silver feature grease-packed spool bearings
- All non-spool bearings feature full grease pack for maximum longevity.
- Features Special Edition Silver and Black anodizing.
- SEa reels feature a yellowfin tuna etched into the sideplate.
- Frames have been machined out for increased clearance between spool and cross bars.
- MK-10 feature MK-20 size handle knobs.
- MK-20/30 feature the MK-50 handle arm and knobs
- Lower speed 1.3:1 gear ratio featured in 20/30 sizes.
- Lower speed 1.0:1 gear ratio featured in 50 size.
- Type-II silver anodized frame, side plates and drag lever



MK10II-SEa



MK15TII-SEa



MK30II-SEa



MK16II-SEa



MK20II-SEa

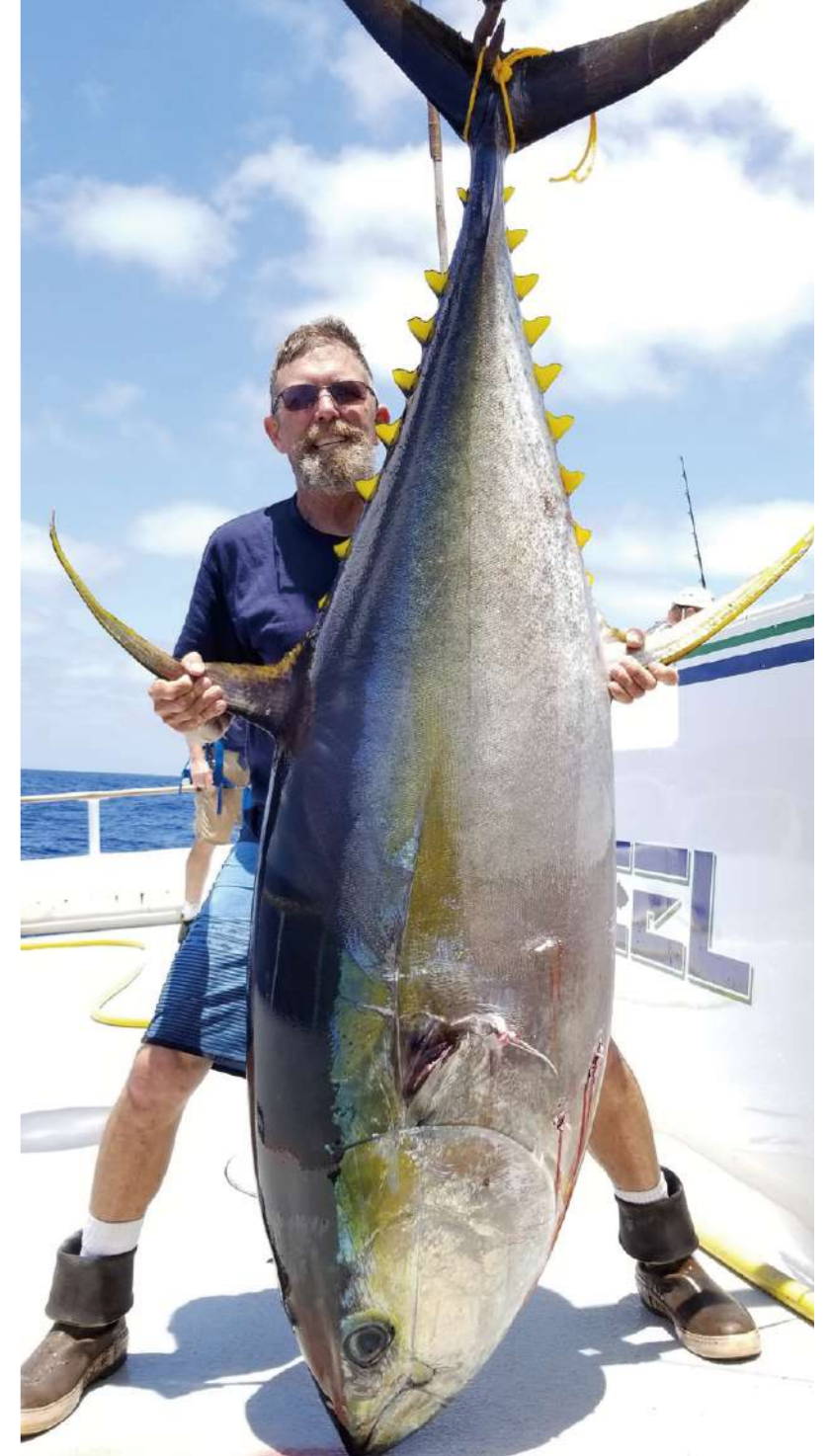

MAKAIRA SEa SILVER

Model	Gear ratios	Bearings	Weight (g)	Line retrieve(cm)	Monofilament line capacity (diameter in mm.)	Max Drag @ Strike with Freespool	Max Drag @ Full with Freespool	Frame style	Frame	Sideplates	Spool
Two-Speed Lever Drag Reels											
MK-10IISEa-Silver	4.7:1 & 2.1:1	4BB + 1TB	740	85.1 & 38.1	0.37/420, 0.42/350, 0.48/260	12.3 kg	15.4 kg	Topless	AL	AL	AL
MK-15TIISEa-Silver	4.7:1 & 2.1:1	4BB + 1TB	822	98.8 & 43.4	0.45/525, 0.48/385, 0.55/295	14.5 kg	18.2 kg	Topless	AL	AL	AL
MK-16IISEa-Silver	4.3:1 & 1.3:1	4BB + 1TB	1134	99.6 & 30	0.42/800, 0.48/600, 0.55/450	15.4 kg	21.7 kg	Topless	AL	AL	AL
MK-20IISEa-Silver	3.8:1 & 1.3:1	4BB + 1TB	1298	100 & 33.5	0.48/800, 0.55/600, 0.60/480	16.8 kg	25 kg	Topless	AL	AL	AL
MK-30IISEa-Silver	3.8:1 & 1.3:1	4BB + 1TB	1417	100 & 33.5	0.55/770, 0.60/640, 0.70/500	16.8 kg	25 kg	Topless	AL	AL	AL
MK-50IISEa-Silver	3.2:1 & 1.0:1	4BB + 1TB	1707	96 & 30.2	0.55/910, 0.70/590, 0.90/360	27.2 kg	39.0 kg	Topless	AL	AL	AL
MK-50WIISEa-Silver	3.2:1 & 1.0:1	4BB + 1TB	1843	96 & 30.2	0.70/820, 0.75/710, 0.90/510	27.2 kg	39.0 kg	Crossbar	AL	AL	AL
MK-80WIISEa-Silver	3.1:1 & 1.2:1	6BB + 1TB	3289	116.1 & 52.1	0.90/910, 1.00/770, 1.12/600	32.1 kg	45.4 kg	Crossbar	AL	AL	AL
MK-130IISEa-Silver	2.2:1 & 1.2:1	6BB + 1TB	4750	100.8 & 55.1	0.90/1450, 1.00/1170, 1.12/920	34.1 kg	45.4 kg	Crossbar	AL	AL	AL

CAVALLA

CAVALLA LEVER DRAG REELS FEATURE:

- Rigid 1-pcs frame and left sideplate construction
- 6061-T6 Machined aluminum frame and sideplates
- 17-4 grade stainless steel main and pinion gears
- Carbonite drag system with Cal's drag grease
- Cold forged, Type-II anodized, machined aluminum spool
- CRC: Corrosion Resistant Coating process
- 4 BB corrosion resistant stainless steel bearings
- Ergo Grip handle knob with anodized aluminum handle arm
- Silent retrieve system for cranking smoothness
- On/Off bait clicker for all lever drag models



CAV-12NII

CAV-12II



CAV-5NS

CAV-5NII

CAV-5II

CAV-5IILX



CAVALLA

Model	Gear ratios	Bearings	Weight (g)	Line retrieve (cm)	Max Drag Pressure(kg)	Monofilament line capacity (diameter in mm.)	Frame	Left Sideplate	Right Sideplate	Spool
Cavalla 2-Speed Reels										
NEW CAV-5NII	6.4:1 & 3.8:1	4BB	460	107 & 63	7 & 11	0.32/385, 0.37/275, 0.42/225	AL	AL	AL	AL
NEW CAV-5II	6.4:1 & 3.8:1	4BB	485	107 & 63	7 & 11	0.32/570, 0.37/400, 0.42/320	AL	AL	AL	AL
NEW CAV-12NII	4.7:1 & 2.1:1	4BB	675	90 & 40	12.2 & 15.4	0.42/300, 0.48/200, 0.55/150	AL	AL	AL	AL
NEW CAV-12II	4.7:1 & 2.1:1	4BB	705	90 & 40	12.2 & 15.4	0.42/510, 0.48/380, 0.55/290	AL	AL	AL	AL
Cavalla 2-Speed Left Hand Retrieve										
NEW CAV-5IILX	6.4:1 & 3.8:1	4BB	485	107 & 63	7 & 11	0.32/570, 0.37/400, 0.42/320	AL	AL	AL	AL
NEW CAV-12IILX	4.7:1 & 2.1:1	4BB	705	90 & 40	12.2 & 15.4	0.42/510, 0.48/380, 0.55/290	AL	AL	AL	AL
Cavalla Single-Speed Reels										
NEW CAV-5S	6.4:1	4BB	465	107	7 & 11	0.32/570, 0.37/400, 0.42/320	AL	AL	AL	AL
NEW CAV-5NS	6.4:1	4BB	440	107	7 & 11	0.32/385, 0.37/275, 0.42/225	AL	AL	AL	AL

MACHINED RIGID FRAME CONSTRUCTION

Okuma's Machined Rigid Frame construction incorporates a one-piece fully-machined aluminum frame. These rigid bar-stock aluminum frames are the ultimate in precision alignment and tolerances withstanding more pressure and torque than any other material used in our industry for frame materials.



17-4 GRADE STAINLESS STEEL MAIN AND PINION GEARS



ERGONOMIC DESIGN

The Ergo Grip handle knob is an extremely comfortable oversized handle-knob design for both speed and power. This soft-touch knob has been ergonomically designed to fit in the palm of your hand.





SOLTERRA SLX

SOLTERRA SLX REELS FEATURE:

- Stainless steel main gears, pinion gears and shafts
- Single speed, High-speed and Two-speed models
- Durable corrosion-resistant frame & side plates
- Stainless steel reinforcing side plate rings
- Forged aluminum spool with line indicator rings
- Carbonite drag system with Cal's universal drag grease
- 2 thrust bearings reduce handle turning force be over 50%.
- 5BB+2TB stainless steel shielded bearings 20-50W models
- 5BB+2TB+RB stainless steel shielded bearings 10/15 models
- Double dog, silent anti-reverse on all models
- Dual anti-reverse system on all 10/15 sizes
- Ratcheting drag lever for precise drag setting
- Stainless Steel Body Armor reduces frame flex 20-50W models
- T-Bar handle design on 50W-size
- Ergo Grip comfort handle on all 10 through 30 sizes
- Low profile On/Off clicker with stainless steel wishbone
- Wide-mouth levelwind: Stainless steel with Ti coating "L" models
- High Speed 6.2:1 gear ratios on SLX-10CS and SLX-15CS
- Open top frame design on SLX-10CS and SLX-15CS



SOLTERRA SLX GRAPHITE LEVER DRAGS

Model	Gear ratios	Bearings	Weight (g)	Line retrieve (cm)	Monofilament line capacity (diameter in mm.)	Max Drag @ Strike with Freespool	Max Drag @ Full with Freespool	Frame	Sideplates	Spool
High speed open top frame reels										
SLX-10CS	6.0:1	5BB+2TB+1RB	660	106.7	0.40//380, 0.45/290, 0.50/230	6.8 kg	10 kg	GR	GR	AL
SLX-15CS	6.0:1	5BB+2TB+1RB	697	106.7	0.45/420, 0.50/340, 0.55/280	6.8 kg	10 kg	GR	GR	AL
Standard Single speed Lever Drags (Features closed frame with top cross bar and harness lugs)										
SLX-20	3.5:1	5BB+2TB	984	81.3	0.50/330, 0.55/440, 0.60/370	11.8 kg	15 kg	GR	GR	AL
SLX-30	3.5:1	5BB+2TB	1017	81.3	0.50/700, 0.55/580, 0.60/490	11.8 kg	15 kg	GR	GR	AL
SLX-50W	3.1:1	5BB+2TB	1487	81.3	0.70/640, 0.90/380, 1.00/310	14.5 kg	18 kg	GR	GR	AL
Two-Speed Lever Drags (Features closed frame with top cross bar and harness lugs)										
SLX-20II	3.8:1 & 1.7:1	5BB+2TB	991	88.9 & 38.1	0.50/530, 0.55/440, 0.60/370	11.8 kg	15 kg	GR	GR	AL
SLX-30II	3.8:1 & 1.7:1	5BB+2TB	1017	88.9 & 38.1	0.50/700, 0.55/580, 0.60/490	11.8 kg	15 kg	GR	GR	AL
SLX-50WII	3.1:1 & 1.3:1	5BB+2TB	1510	81.3 & 38.1	0.70/640, 0.90/380, 1.00/310	14.5 kg	18 kg	GR	GR	AL
Levelwind reels										
SLX-10L	4.2:1	5BB+2TB+1RB	596	73.7	0.40/380, 0.45/290, 0.50/230	6.8 kg	10 kg	GR	GR	AL
SLX-15L	4.2:1	5BB+2TB+1RB	644	73.7	0.45/420, 0.50/340, 0.55/280	6.8 kg	10 kg	GR	GR	AL
SLX-20L	3.5:1	5-BB+2TB	1034	81.3	0.50/330, 0.55/440, 0.60/370	11.8 kg	15 kg	GR	GR	AL



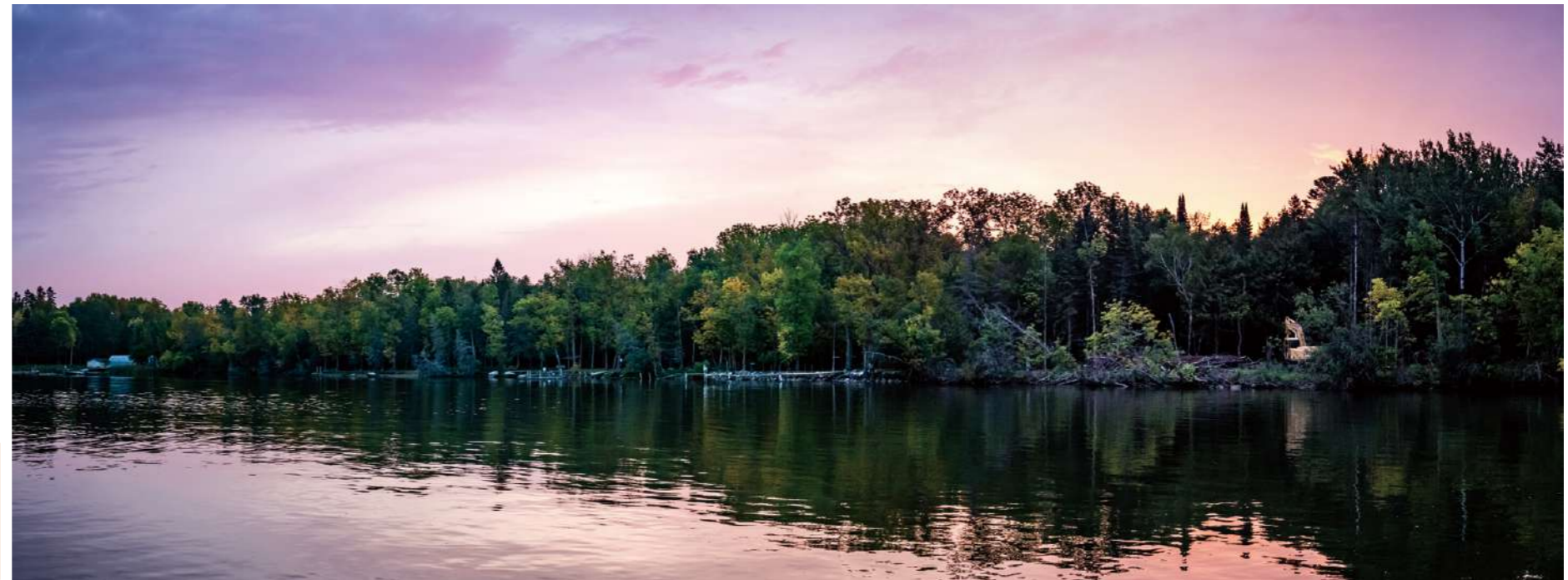

RODS

Nothing inspires the soul like a finely-crafted fishing rod. Upon picking it up, flexing the action and feeling the balance, an angler can immediately visualize the experience- working a bait, feeling the strike, the deep flex under the load of a heavy fish. While the needs of each fishery can be dramatically different, the goal is universally the same: to actively connect with nature as a participant instead of a spectator. With many hundreds of unique rod models covering unique territories, species and techniques, our development process is highly collaborative. We work with the finest anglers in a given discipline to define the performance attributes. Then we bring them to life within our cutting-edge manufacturing facility.



TECHNOLOGY

UFR

Freeing anglers from the choice between power and sensitivity

When choosing a rod, anglers often face the trade-off between a powerful but bulky rod that can catch big-sized fish, or a sensitive but weaker rod that can sense the bite of the smallest fish. We address this challenge with a revolutionary tip: Ultimate Flex Reinforcement (UFR), which redefines the future generation of rods.

Developed using a patented manufacturing process, the UFR tip combines strength and agility like never before, marking a breakthrough. Our UFR technology endows our rods with a 300% increase in lifting capability and an ability to bend up to 360°. With longitudinal fibers around the rod blanks, our rods are more powerful, yet lighter and more flexible than traditional ones. As a result, our anglers no longer need to choose between power and sensitivity.



HELIOS *Air*

HELIOS AIR RODS FEATURE:

- 40T+46T Toray carbon, ultra-light and responsive blank construction
- New exclusive psychedelic blank artwork
- Seaguide ONE GUIDE design, SS316 stainless steel and tangle-free frame guides with zirconium inserts
- Okuma unique tooling skeleton reel seat, Japan carbon injection
- Durable Winn grip design
- Split grip butt design for reduced weight and improved balance
- High quality rod bag



HELIOS AIR

	Model	Rod Power	Length	Sections	Lure Wt. (g)	Foregrip length	Reargrip Length	Number of Guide	Weight (g)
NEW	HSA-S-742MH	MH	2.23m	2-pcs	20-50	40mm	305mm	8+Tip	107
NEW	HSA-S-802MH	MH	2.43m	2-pcs	20-50	40mm	305mm	8+Tip	121
NEW	HSA-S-802H	H	2.43m	2-pcs	30-70	40mm	305mm	8+Tip	128
NEW	HSA-S-902H	H	2.74m	2-pcs	30-70	40mm	305mm	8+Tip	148



ONE.rod

ONE RODS FEATURE:

- Ultra light 40T carbon blank construction
- Fuji anti-tangle stainless steel guides frame
- Fuji Alconite guide inserts reduce friction
- Fuji mini split reel seat
- Okuma carbon cone handle design
- High quality cloth bag package



ONE ROD

	Model	Rod Power	Length	Sections	Casting Wt. (g)	Foregrip length	Reargrip Length	Number of Guide	Handle Style	Weight (g)
Casting Rods										
	OR-C-661ML	ML	6'6"	1-pcs	7-20	N/A	300mm	9+TIP	B	86
	OR-C-661M	M	6'6"	1-pcs	10-30	N/A	300mm	9+TIP	B	92
Spinning Rods										
	OR-S-661ML	ML	6'6"	1-pcs	7-20	N/A	280mm	7+TIP	A	82
	OR-S-661M	M	6'6"	1-pcs	10-30	N/A	280mm	7+TIP	A	89
	OR-S-661MH	MH	6'6"	1-pcs	15-45	N/A	280mm	7+TIP	A	95



INSPIRA

INSPIRA RODS FEATURE:

- 30-Ton ultra-light carbon black construction
- Fuji stainless steel top with Alconite inserts
- Seaguide XO anti-tangle 316-stainless steel guides
- Okuma tooling reel seat with Fuji cushioned stainless steel Hood
- Okuma carbon cone concept handle
- Durable EVA with flat aluminum end cap improved balance
- High quality cloth bag packake



INSPIRA

Model	Rod Power	Length	Sections	Casting Wt. (g)	Foregrip length	Reargrip Length	Number of Guide	Weight (g)
ISP-S-662UL	UL	6'6"	2-pcs	0-7	N/A	260mm	7+TIP	128
ISP-S-702UL	UL	7'0"	2-pcs	0-10	N/A	260mm	8+TIP	134
ISP-S-762UL	UL	7'6"	2-pcs	2-12	N/A	290mm	8+TIP	142
ISP-S-802UL	UL	8'0"	2-pcs	2-12	N/A	300mm	8+TIP	149
ISP-S-902UL	UL	9'0"	2-pcs	2-12	N/A	340mm	9+TIP	163



Helios SX

HELIOS SX RODS FEATURE:

- 30T carbon construction
- Slim blanks with fast action
- Japanese split EVA handles
- Ergonomic touch blank screw up reel seat
- CCS SIC gunsmoke guides
- Customized Okuma butt cap
- Delivered in cloth bag



Award winning Helios SX rod comes in 16 different spin models and one trigger model covering all your spinning needs from 2-8 gr 165 cm ultra light fishing to 20-60 gr 300cm jiggging rod.



HELIOS SX

Model	Rod Power	Length	Sections	Lure Wt. (kg)	Foregrip length	Reargrip Length	Number of Guide	Handle Style	Weight (g)
Spinning Rods									
HSX-S-562L	L	1.65m	2-pcs	2-8	35mm	230mm	6+Tip	A	88
HSX-S-602L	L	1.80m	2-pcs	2-10	35mm	230mm	6+Tip	A	90
HSX-S-662ML	ML	1.95m	2-pcs	7-18	35mm	260mm	6+Tip	A	95
HSX-S-702L	L	2.10m	2-pcs	4-15	35mm	260mm	7+Tip	A	95
HSX-S-702ML	ML	2.10m	2-pcs	8-20	35mm	260mm	7+Tip	A	104
HSX-S-702M	M	2.10m	2-pcs	10-30	35mm	260mm	7+Tip	A	118
HSX-S-742ML	ML	2.28m	2-pcs	8-25	35mm	260mm	7+Tip	A	105
HSX-S-742M	M	2.28m	2-pcs	12-35	35mm	280mm	7+Tip	A	116
HSX-S-742MH	MH	2.28m	2-pcs	20-50	35mm	280mm	7+Tip	A	124
HSX-S-802ML	ML	2.40m	2-pcs	8-25	35mm	280mm	8+Tip	A	113
HSX-S-802M	M	2.40m	2-pcs	15-40	35mm	280mm	8+Tip	A	123
HSX-S-802MH	MH	2.40m	2-pcs	20-50	35mm	280mm	8+Tip	A	135
HSX-S-902ML	ML	2.70m	2-pcs	8-25	35mm	280mm	8+Tip	A	128
HSX-S-902M	M	2.70m	2-pcs	15-45	35mm	280mm	8+Tip	A	144
HSX-S-902MH	MH	2.70m	2-pcs	20-60	35mm	310mm	8+Tip	A	154
HSX-S-1002M	M	3.00m	2-pcs	20-50	35mm	370mm	9+Tip	A	162
Casting Rods									
HSX-C-662ML	ML	1.95m	2-pcs	7-18	40mm	275mm	9+Tip	B	99
Travel Spin Rods									
NEW HSX-S-704ML	ML	2.13m	2-pcs	5-20g	35mm	260mm	7+Tip	A	107
NEW HSX-S-704M	M	2.13m	2-pcs	10-30g	35mm	260mm	7+Tip	A	115
NEW HSX-S-704MH	MH	2.13m	2-pcs	15-40g	35mm	260mm	7+Tip	A	124
NEW HSX-S-804MH	MH	2.44m	2-pcs	15-50g	35mm	280mm	8+Tip	A	137
NEW HSX-S-804H	H	2.44m	2-pcs	20-80g	35mm	280mm	8+Tip	A	150
Travel Casting Rods									
NEW HSX-C-704H	H	2.13m	2-pcs	20-60g	45mm	305mm	10+Tip	B	135



EPIXOR

EPIXOR RODS FEATURE:

- Unique use of Bopp (Biaxially Oriented Polypropylene) Blank protect Film
- Bopp are a 2 way stretch film, which protect the carbon blank from damage, during use and transportation
- Bopp can be recycled
- 30/36-Ton carbon, ultra-light, slim and balanced blanks
- Seaguide XO anti-tangle 316-stainless steel guides
- Zirconium guides inserts reduce friction from braided lines
- Unique light weight ergonomic touch blank reel seats
- AAA cork quality handles
- Durable rubber cork end cap for the balance
- Luxury velvet rod bag

EPIXOR

Model	Rod Power	Length (mm)	Sections	Casting Wt.(g)	Foregrip length	Reargrip Length	Number of Guide	Weight (g)
Spinning Rods								
EPI-S-662L-1	L	198	2-pcs	2-12	40mm	250mm	6+TIP	97
EPI-S-702L-1	L	210	2-pcs	3-18	40mm	250mm	7+TIP	104
EPI-S-742M-1	M	228	2-pcs	10-32	40mm	250mm	7+TIP	121
EPI-S-802L-1	L	240	2-pcs	5-20	40mm	250mm	7+TIP	123
EPI-S-802ML-1	ML	249	2-pcs	10-32	40mm	250mm	7+TIP	133
EPI-S-862M-1	M	258	2-pcs	15-40	40mm	250mm	8+TIP	154
EPI-S-902L-1	L	270	2-pcs	5-25	40mm	250mm	8+TIP	137
EPI-S-922ML-1	ML	276	2-pcs	10-32	40mm	250mm	8+TIP	158
EPI-S-962M-1	M	288	2-pcs	15-50	40mm	250mm	8+TIP	188
EPI-S-1002ML-1	ML	300	2-pcs	10-40	40mm	250mm	8+TIP	187
EPI-S-1153M-1	M	345	3-pcs	20-50	40mm	250mm	9+TIP	236

EPIXOR Travel rods

EPIXOR TRAVEL RODS FEATURE:

- Unique use of Bopp (Biaxially Oriented Polypropylene) Blank protection Film
- Bopp is a 2 way stretch film, that protect the carbon blank from damage, during use and transportation
- Bopp can be recycled
- Slim, Light and Balanced blanks
- 30 and 36T Korean carbon material
- Unique Light wieht ergonomic touch blank reel seats
- AAA grade cork handles
- Coil control guide system

EPIXOR TRAVEL ROD

Model	Rod Power	Length	Sections	Lure Wt. (g)	Foregrip length	Reargrip Length	Number of Guide	Weight (g)
EPI-S-904L	L	2.70m	4-pcs	7-24	40mm	340mm	8+Tip	143
EPI-S-924ML	ML	2.76m	4-pcs	8-28	40mm	340mm	8+Tip	152
EPI-S-964ML	ML	2.88m	4-pcs	10-32	40mm	350mm	8+Tip	170
EPI-S-1004ML	ML	3.00m	4-pcs	10-36	40mm	380mm	8+Tip	199
EPI-S-1154ML	ML	3.45m	4-pcs	10-35	40mm	455mm	10+Tip	229

COMMAND

COMMAND RODS FEATURE:

- 30-Ton ultra-light carbon blank construction
- Army Camou layer special for "COMMAND" rods
- Seaguide XO anti-tangle 316-stainless steel guides
- High quality cork combined with the C40X technology
- Fore grip specifically designed so reel seat threads are not exposed
- Quality C40X reel seat
- Luxury velvet rod bag

COMMAND

Model	Rod Power	Length	Sections	Casting Wt. (g)	Foregrip length	Reargrip Length	Number of Guide	Weight (g)
COD-S-702ML	ML	7'0"	2 pcs	5-20	40mm	310mm	7+Tip	128
COD-S-862MH	MH	8'6"	2 pcs	15-45	40mm	360mm	7+Tip	179



Ceymar

CEYMAR UFR FEATURE:

- High modulus ultra-responsive carbon blank with UFR TIP
- Seaguide XO anti-tangle 316-stainless steel guides
- Zirconium guides inserts reduce friction
- Quality light weight ergonomic touch blank reel seats
- EVA split grip and EVA fore grip for reduced weight and feel
- Durable EVA end cap
- High quality PVC tube with carrying belt



CEYMAR

Model	Rod Power	Length	Sections	Casting Wt. (g)	Foregrip length	Reargrip Length	Number of Guide	Weight (g)
C-S-802ML-2	ML	8'0"	2-pcs	10-30	40mm	350mm	7+TIP	137
C-S-902ML-2	ML	9'0"	2-pcs	10-40	40mm	380mm	8+TIP	154
C-S-1002ML-2	ML	10'0"	2-pcs	15-45	40mm	410mm	9+TIP	172

Ceymar SPR

CEYMAR SPR FEATURE:

- Ultra-sensitive and responsive carbon blank construction
- Spiral Carbon technology improves strength and durability
- Quality stainless steel frame guides with Polished Titanium Oxide inserts
- Okuma graphite reel seat with cushioned stainless steel hood
- Ergonomic shaped, split EVA handles
- Durable rubber cork end cap for the rods balance
- Supplied with a quality rod bag



CEYMAR SPR

Model	Rod Power	Length	Sections	Lure Wt. (g)	Foregrip length	Reargrip Length	Number of Guide	Weight (g)
CSPR-S-702H	H	2.10m	2-pcs	30-120	40mm	300mm	6+Tip	167
CSPR-S-802H	H	2.40m	2-pcs	30-120	40mm	350mm	6+Tip	182
CSPR-S-902H	H	2.70m	2-pcs	30-120	40mm	380mm	6+Tip	204
CSPR-S-1002H	H	3.00m	2-pcs	30-120	40mm	410mm	7+Tip	231



Pink Pearl V2

PINK PEARL V2 FEATURE:

- 24T carbon construction
- SIC guides silver frame
- Modern graphite screw reel seat
- Okuma butt cap logo
- Designed to match to Pink Pear V2 reels
- Supplied with a quality rod bag



PINK PEARL V2

	Model	Rod Power	Length	Sections	Lure Wt. (g)	Foregrip length	Reargrip Length	Number of Guide	Weight (g)
NEW	PP-S-712ML V2	ML	2.13m	2-pcs	5-20	35mm	260mm	6+Tip	124
NEW	PP-S-822M V2	M	2.49m	2-pcs	10-32	35mm	280mm	7+Tip	168



AZAKI

AZAKI FEATURE:

- 2 4T Carbon EPC process
- Same blank as Altera
- 3 split handle EVA & Cork
- SIC guides silver frame
- Graphite screw down reel seat with cushions
- Designed to match Azaki spinning reels
- Supplied with a quality rod bag



AZAKI

	Model	Rod Power	Length	Sections	Lure Wt. (g)	Foregrip length	Reargrip Length	Number of Guide	Weight (g)
NEW	AZK-S-602ML	ML	1.83m	2-pcs	4-12g	40mm	235mm	5+Tip	88
NEW	AZK-S-602M	M	1.83m	2-pcs	5-20g	40mm	235mm	5+Tip	90
NEW	AZK-S-662L	L	1.98m	2-pcs	7-22g	40mm	255mm	5+Tip	94
NEW	AZK-S-702ML	ML	2.13m	2-pcs	5-20g	40mm	270mm	6+Tip	104
NEW	AZK-S-702M	M	2.13m	2-pcs	10-30g	40mm	270mm	6+Tip	108
NEW	AZK-S-762ML	ML	2.28m	2-pcs	8-25g	40mm	270mm	6+Tip	112
NEW	AZK-S-762M	M	2.28m	2-pcs	12-35g	40mm	270mm	6+Tip	118
NEW	AZK-S-802ML	ML	2.44m	2-pcs	7-28g	40mm	290mm	7+Tip	121
NEW	AZK-S-802M	M	2.44m	2-pcs	12-35g	40mm	290mm	7+Tip	124
NEW	AZK-S-902ML	ML	2.74m	2-pcs	7-28g	40mm	290mm	7+Tip	130
NEW	AZK-S-902M	M	2.74m	2-pcs	12-35g	40mm	290mm	7+Tip	138
NEW	AZK-S-902H	H	2.74m	2-pcs	20-60g	40mm	290mm	7+Tip	165



ALARIS

ALARIS RODS FEATURE:

- 24T Korean carbon blank construction.
- Light weight SIC guide system
- Ergonomic, touch blank reel seat
- FC-Full cork handles
- Japanese split handle style
- Supplied in rod bag



ALARIS

Model	Rod Power	Length	Sections	Casting Wt. (g)	Foregrip length	Reargrip Length	Number of Guide	Handle Style	Weight (g)
Casting									
ALA-C-632ML	ML	6'3"	2-pcs	5-22	50mm	300mm	8+TIP	A	121
ALA-C-632M	M	6'3"	2-pcs	10-32	50mm	300mm	8+TIP	A	123
Spinning									
ALA-S-602L	L	6'0"	2-pcs	2-7	40mm	240mm	4+TIP	B	102
ALA-S-612ML	ML	6'1"	2-pcs	5-15	40mm	260mm	4+TIP	B	103
ALA-S-632M	M	6'3"	2-pcs	10-32	40mm	290mm	4+TIP	B	119
ALA-S-712M	M	7'1"	2-pcs	10-32	40mm	290mm	4+TIP	B	118
ALA-S-712ML	ML	7'1"	2-pcs	5-22	40mm	290mm	4+TIP	B	147
ALA-S-742M	M	7'4"	2-pcs	10-32	40mm	310mm	4+TIP	B	133
ALA-S-742MH	MH	7'4"	2-pcs	15-40	40mm	330mm	4+TIP	B	146
ALA-S-822ML	ML	8'2"	2-pcs	10-32	40mm	330mm	5+TIP	B	183
ALA-S-862MH	MH	8'6"	2-pcs	20-60	40mm	380mm	5+TIP	B	221
ALA-S-902ML	ML	9'0"	2-pcs	7-28	40mm	380mm	5+TIP	B	182
ALA-S-1012M	M	10'1"	2-pcs	15-45	40mm	410mm	5+TIP	B	216



ALARIS

ALARIS ROD FEATURE:

- 24T carbon construction
- Slim blanks with fast action
- SCT Solid Carbon Tip on Light Jig versions
- Rubber cork butt
- Ergonomic touch reel seat
- CCS SIC gunsmoke guides
- Delivered in cloth bag



ALARIS

Model	Rod Power	Length	Sections	Lure Wt. (g)	Foregrip length	Reargrip Length	Number of Guide	Weight (g)
Light Jig Spin								
ALS-S-802UL	UL	2.40m	2-pcs	up to 12	40mm	240mm	7+Tip	131
ALS-S-902UL	UL	2.70m	2-pcs	up to 15	40mm	250mm	8+Tip	151
Soft Lure Spin								
ALS-S-802L	L	2.40m	2-pcs	5-15	40mm	240mm	7+Tip	134
ALS-S-902L	L	2.70m	2-pcs	5-15	40mm	250mm	8+Tip	154
ALS-S-802ML	ML	2.40m	2-pcs	7-25	40mm	240mm	7+Tip	138
ALS-S-902ML	ML	2.70m	2-pcs	7-28	40mm	300mm	8+Tip	160
Zander Spin								
ALS-S-802M	M	2.40m	2-pcs	10-35	40mm	260mm	7+Tip	148
ALS-S-902M	M	2.70m	2-pcs	10-35	40mm	300mm	8+Tip	173

ALTERA

ALTERA RODS FEATURE:

- 24T carbon construction
- Slim blanks with fast action
- Japanese split EVA handles
- Ergonomic touch blanks reel seat
- Quality SIC gunsmoke frame guides
- Delivered in cloth bag



ALTERA

Model	Rod Power	Length	Sections	Lure Wt. (g)	Foregrip length	Reargrip Length	Number of Guide	Weight (g)
Spin								
ALT-S-502UL	UL	1.50m	2-pcs	2-7	33mm	205mm	5+Tip	82
ALT-S-562L	L	1.65m	2-pcs	3-8	33mm	235mm	5+Tip	87
ALT-S-602UL	UL	1.80m	2-pcs	2-7	33mm	245mm	5+Tip	93
ALT-S-602L	L	1.80m	2-pcs	4-12	33mm	245mm	5+Tip	96
ALT-S-602ML	ML	1.80m	2-pcs	5-20	33mm	245mm	5+Tip	98
ALT-S-662ML	ML	1.95m	2-pcs	7-22	33mm	260mm	5+Tip	107
ALT-S-662M	M	1.95m	2-pcs	10-30	33mm	260mm	5+Tip	110
ALT-S-662MH	MH	1.95m	2-pcs	15-40	33mm	260mm	5+Tip	115
ALT-S-662H	H	1.95m	2-pcs	25-70	33mm	260mm	6+Tip	130
ALT-S-702ML	ML	2.10m	2-pcs	5-20	33mm	265mm	6+Tip	116
ALT-S-702M	M	2.10m	2-pcs	10-30	33mm	265mm	6+Tip	118
ALT-S-702MH	MH	2.10m	2-pcs	15-40	33mm	265mm	6+Tip	127
ALT-S-702H	H	2.10m	2-pcs	20-60	33mm	275mm	6+Tip	135
ALT-S-742ML	ML	2.28m	2-pcs	8-25	33mm	275mm	6+Tip	116
ALT-S-742M	M	2.28m	2-pcs	12-35	33mm	275mm	6+Tip	119
ALT-S-742MH	MH	2.28m	2-pcs	20-40	33mm	275mm	6+Tip	130
ALT-S-802ML	ML	2.40m	2-pcs	7-28	33mm	285mm	7+Tip	129
ALT-S-802M	M	2.40m	2-pcs	15-40	33mm	285mm	7+Tip	135
ALT-S-802MH	MH	2.40m	2-pcs	20-45	33mm	285mm	7+Tip	144
ALT-S-802H	H	2.40m	2-pcs	30-80	33mm	340mm	7+Tip	152
ALT-S-902ML	ML	2.70m	2-pcs	5-25	33mm	285mm	7+Tip	147
ALT-S-902M	M	2.70m	2-pcs	15-40	33mm	285mm	7+Tip	149
ALT-S-902MH	MH	2.70m	2-pcs	20-80	33mm	360mm	7+Tip	164
ALT-S-902H	H	2.70m	2-pcs	30-100	33mm	360mm	7+Tip	176
ALT-S-1002MH	MH	3.00m	2-pcs	25-70	33mm	415mm	8+Tip	187
Casting								
ALT-C-662M	M	1.95m	2-pcs	10-30	33mm	300mm	8+Tip	114
ALT-C-662H	H	1.95m	2-pcs	20-50	33mm	300mm	8+Tip	129



ALTERA

ALTERA TRAVEL RODS FEATURE:

- 24T carbon blank construction
- 4-pc travel rod concept
- Fast action
- Matt gunsmoke frame SIC K-type guides
- Japanese Split EVA handle
- Modern Ergonomic touch blanks reel seat
- Supplied with a quality rod bag



ALTERA

Model	Rod Power	Length	Sections	Lure Wt. (g)	Foregrip length	Reargrip Length	Number of Guide	Handle Style	Weight (g)
Travel Spin									
NEW ALT-S-704MH	MH	2.13m	4-pcs	15-40	35mm	275mm	6+Tip	A	129
NEW ALT-S-704H	H	2.13m	4-pcs	20-60	35mm	285mm	6+Tip	A	138
NEW ALT-S-704XH	XH	2.13m	4-pcs	30-80	35mm	285mm	6+Tip	A	145
NEW ALT-S-804H	H	2.44m	4-pcs	40-80	35mm	350mm	7+Tip	A	167
Travel Casting									
NEW ALT-C-704H	H	2.13m	4-pcs	20-60	35mm	300mm	8+Tip	B	145
NEW ALT-C-704XH	XH	2.13m	4-pcs	30-80	35mm	300mm	8+Tip	B	151

ALTERA TELE SPIN

ALTERA TELE SPIN RODS FEATURE:

- 24T ultra-light carbon blank construction.
- Slim blanks with fast action.
- Matt gunsmoke frame SIC guides.
- Okuma graphite reel seat.
- Aluminum screw end cap with non-skid rubber.
- Quality guide cover and cloth bag included.



ALTERA

Model	Rod Power	Length	Sections	Lure Wt. (g)	Foregrip length	Reargrip Length	Number of Guide	Weight (g)
Tele Spin								
NEW ATE-S-605M-T	M	1.83m	5-pcs	10-30g	35mm	235mm	3+Tip	102
NEW ATE-S-705M-T	M	2.13m	6-pcs	10-30g	35mm	250mm	4+Tip	116
NEW ATE-S-806M-T	M	2.44m	7-pcs	15-40g	35mm	265mm	5+Tip	133
NEW ATE-S-907M-T	M	2.74m	7-pcs	15-40g	35mm	310mm	6+Tip	147
NEW ATE-S-1007M-T	M	3.05m	7-pcs	15-40g	35mm	345mm	6+Tip	182
NEW ATE-S-1107M-T	M	3.30m	7-pcs	20-50g	35mm	360mm	6+Tip	211

NEMESIS

NEMESIS RODS FEATURE:

- High modulus ultra-light carbon blank construction
- Quality stainless steel frame guides
- Okuma graphite reel seat
- EVA split grip and EVA fore grip for reduced weight and feel
- Aluminum end cap with Okuma epoxy logo
- Travel Cast available in 6'0"



NEMESIS

Model	Rod Power	Length	Sections	Casting Wt. (g)	Line Wt. (lbs)	Foregrip length	Reargrip Length	Number of Guide	Handle Style	Weight (g)
Casting										
NE-C-562L	L	5'6"	2-pcs	5-10	4-10	50mm	220mm	7+TIP	A	107
NE-C-602UL	UL	6'0"	2-pcs	2-10	2-6	50mm	245mm	8+TIP	A	108
NE-C-602ML	ML	6'0"	2-pcs	7-15	6-12	50mm	245mm	8+TIP	A	115
NE-C-602M	M	6'0"	2-pcs	7-28	8-17	50mm	270mm	8+TIP	A	118
NE-C-662M	M	6'6"	2-pcs	7-28	8-17	50mm	290mm	8+TIP	A	124
NE-C-702MH	MH	7'0"	2-pcs	10-35	10-20	50mm	290mm	9+TIP	A	141
Spinning										
NE-S-562L	L	5'6"	2-pcs	5-10	4-10	50mm	205mm	6+TIP	B	102
NE-S-602UL	UL	6'0"	2-pcs	2-10	2-6	50mm	245mm	6+TIP	B	103
NE-S-602ML	ML	6'0"	2-pcs	7-15	6-12	50mm	245mm	6+TIP	B	107
NE-S-662M	M	6'6"	2-pcs	7-28	8-17	50mm	290mm	7+TIP	B	121
NE-S-702MH	MH	7'0"	2-pcs	10-35	10-20	50mm	290mm	7+TIP	B	137
Travel										
NE-C-604ML	ML	6'0"	2-pcs	7-15	6-12	50mm	200mm	9+TIP	A	129

VSystem G2

VSYSTEM G2 RODS FEATURE:

- Ultra-light high modulus carbon blank construction
- Quality anti tangle stainless steel frame guides
- Okuma graphite reel seat
- Ergonomic shaped, hard EVA handles
- EVA split grip and EVA fore grip for reduced weight and feel
- Aluminum screw end cap with non-skid rubber
- Quality guide cover and cloth bag included



VSYSTEM G2

Model	Rod Power	Length	Sections	Casting Wt. (g)	Foregrip length	Reargrip Length	Number of Guide	Weight (g)
VST-S-806M-T	M	2.40m	6-Tele	10-40	40mm	305mm	5+TIP	163
VST-S-907M-T	M	2.70m	7-Tele	10-40	40mm	360mm	6+TIP	179
VST-S-1007M-T	M	3.00m	7-Tele	10-40	50mm	425mm	6+TIP	186

COMPETITION

- 24T carbon blank construction
- Stainless steel guide frames
- Durable titanium oxide guide inserts
- Stainless steel hooded reel seat with Okuma tooling logo
- Split grip butt design for reduced weight and improved balance
- Comfortable EVA fore and rear grips
- Stainless steel hook keeper



COMPETITION

Model	Rod Power	Length	Sections	Casting Wt. (g)	Foregrip length	Reargrip Length	Number of Guide	Handle Style	Weight (g)
Casting Rods									
CM-C-562L	L	5'6"	2-pcs	2-8	35mm	250mm	7+TIP	B	90
CM-C-602UL	UL	6'0"	2-pcs	2-8	35mm	275mm	8+TIP	B	95
CM-C-602ML	ML	6'0"	2-pcs	5-17	35mm	275mm	8+TIP	B	102
CM-C-601M	M	6'0"	1-pcs	8-25	35mm	275mm	8+TIP	B	106
CM-C-662ML	ML	6'6"	2-pcs	7-18	35mm	275mm	9+TIP	B	110
CM-C-661M	M	6'6"	1-pcs	10-30	35mm	275mm	9+TIP	B	115
CM-C-701M	M	7'0"	1-pcs	10-30	35mm	275mm	9+TIP	B	126
CM-C-702M	M	7'0"	2-pcs	10-30	35mm	275mm	9+TIP	B	129
Spinning Rods									
CM-S-562UL	UL	5'6"	2-pcs	0-7	35mm	200mm	5+TIP	A	89
CM-S-562L	L	5'6"	2-pcs	2-8	35mm	200mm	5+TIP	A	92
CM-S-562ML	ML	5'6"	2-pcs	4-15	35mm	200mm	5+TIP	A	96
CM-S-602UL	UL	6'0"	2-pcs	2-8	35mm	200mm	5+TIP	A	98
CM-S-602L	L	6'0"	2-pcs	2-10	35mm	200mm	5+TIP	A	102
CM-S-602ML	ML	6'0"	2-pcs	5-17	35mm	200mm	5+TIP	A	106
CM-S-601M	M	6'0"	1-pcs	8-25	35mm	200mm	5+TIP	A	109
CM-S-602M	M	6'0"	2-pcs	8-25	35mm	200mm	5+TIP	A	112
CM-S-662L	L	6'6"	2-pcs	3-15	35mm	225mm	5+TIP	A	116
CM-S-662ML	ML	6'6"	2-pcs	7-18	35mm	225mm	5+TIP	A	121
CM-S-661M	M	6'6"	1-pcs	10-30	35mm	225mm	5+TIP	A	120
CM-S-662M	M	6'6"	2-pcs	10-30	35mm	225mm	5+TIP	A	123
CM-S-662MH	MH	6'6"	2-pcs	10-40	35mm	225mm	5+TIP	A	126
CM-S-702L	L	7'0"	2-pcs	4-15	35mm	240mm	6+TIP	A	125
CM-S-702ML	ML	7'0"	2-pcs	8-20	35mm	240mm	6+TIP	A	130
CM-S-701M	M	7'0"	1-pcs	10-30	35mm	240mm	6+TIP	A	135
CM-S-702M	M	7'0"	2-pcs	10-30	35mm	240mm	6+TIP	A	136
CM-S-702MH	MH	7'0"	2-pcs	15-40	35mm	240mm	6+TIP	A	139
CM-S-702H	H	7'0"	2-pcs	20-60	35mm	240mm	6+TIP	A	142
CM-S-762ML	ML	7'6"	2-pcs	8-25	35mm	260mm	7+TIP	A	140
CM-S-762M	M	7'6"	2-pcs	12-35	35mm	260mm	7+TIP	A	145
CM-S-762MH	MH	7'6"	2-pcs	10-20	35mm	260mm	7+TIP	A	150
CM-S-802ML	ML	8'0"	2-pcs	10-30	50mm	310mm	7+TIP	A	152
CM-S-802M	M	8'0"	2-pcs	15-40	50mm	310mm	7+TIP	A	157
CM-S-802MH	MH	8'0"	2-pcs	20-45	50mm	310mm	7+TIP	A	167
CM-S-802H	H	8'0"	2-pcs	30-80	50mm	310mm	7+TIP	A	178
CM-S-902M	M	9'0"	2-pcs	20-50	50mm	360mm	8+TIP	A	179
CM-S-902MH	MH	9'0"	2-pcs	20-80	50mm	360mm	8+TIP	A	186
CM-S-902H	H	9'0"	2-pcs	30-100	50mm	360mm	8+TIP	A	198
CM-S-1002MH	MH	10'0"	2-pcs	20-80	50mm	400mm	8+TIP	A	212
CM-S-1002H	H	10'0"	2-pcs	40-120	50mm	400mm	8+TIP	A	228



Fuel Spin

FUEL SPIN RODS FEATURE:

- 24T GT blank construction
- Fast action
- Complete range with 16 lengths and CW possible
- Motor sports design inspiration
- Pure energy for fishing
- 3 Split EVA handle to reduce the weight and good balance
- Stainless steel frame SIC guides
- Graphite cushions reel seat
- Designed to match Okuma Fuel Spin reels



FUEL SPIN

	Model	Rod Power	Length	Sections	Casting Wt. (g)	Foregrip length	Reargrip Length	Number of Guide	Weight (g)
NEW	FSP-S-602L	L	1.83m	2-pcs	2-10	35mm	220mm	5+Tip	99
NEW	FSP-S-602M	M	1.83m	2-pcs	5-20	35mm	230mm	5+Tip	100
NEW	FSP-S-602H	H	1.83m	2-pcs	15-40	35mm	250mm	5+Tip	114
NEW	FSP-S-662L	L	1.97m	2-pcs	3-15	35mm	235mm	5+Tip	105
NEW	FSP-S-662ML	ML	1.97m	2-pcs	7-22	35mm	245mm	5+Tip	107
NEW	FSP-S-662M	M	1.97m	2-pcs	10-30	35mm	255mm	5+Tip	113
NEW	FSP-S-662H	H	1.97m	2-pcs	20-50	35mm	265mm	5+Tip	126
NEW	FSP-S-702L	L	2.13m	2-pcs	4-15	35mm	265mm	5+Tip	111
NEW	FSP-S-702M	M	2.13m	2-pcs	10-30	35mm	270mm	6+Tip	125
NEW	FSP-S-702H	H	2.13m	2-pcs	20-60	35mm	280mm	6+Tip	138
NEW	FSP-S-802L	L	2.43m	2-pcs	5-25	35mm	295mm	7+Tip	140
NEW	FSP-S-802M	M	2.43m	2-pcs	15-40	35mm	310mm	7+Tip	149
NEW	FSP-S-802H	H	2.43m	2-pcs	30-80	35mm	340mm	7+Tip	173
NEW	FSP-S-902L	L	2.74m	2-pcs	7-30	35mm	300mm	7+Tip	165
NEW	FSP-S-902M	M	2.74m	2-pcs	20-50	35mm	310mm	7+Tip	179
NEW	FSP-S-902H	H	2.74m	2-pcs	30-100	35mm	360mm	7+Tip	209

Wave Power

WAVE POWER RODS FEATURE:

- 24T GT blank construction
- Fast action
- Stainless steel frame SIC guides
- 3 Split EVA handle to reduce the weight and good balance
- Graphite cushions reel seat
- Telescopic version available
- Designed to match Okuma Aria spin reels



WAVE POWER

	Model	Rod Power	Length	Sections	Casting Wt. (g)	Foregrip length	Reargrip Length	Number of Guide	Weight (g)
NEW	WP-S-602L	L	1.83m	2-pcs	2-10	35mm	220mm	5+Tip	100
NEW	WP-S-602M	M	1.83m	2-pcs	5-20	35mm	230mm	5+Tip	102
NEW	WP-S-602H	H	1.83m	2-pcs	15-40	35mm	250mm	5+Tip	112
NEW	WP-S-662L	L	1.97m	2-pcs	3-15	35mm	245mm	5+Tip	104
NEW	WP-S-662M	M	1.97m	2-pcs	10-30	35mm	255mm	5+Tip	108
NEW	WP-S-662H	H	1.97m	2-pcs	20-50	35mm	265mm	5+Tip	120
NEW	WP-S-702L	L	2.13m	2-pcs	4-15	35mm	240mm	6+Tip	112
NEW	WP-S-702M	M	2.13m	2-pcs	10-30	35mm	270mm	6+Tip	120
NEW	WP-S-702H	H	2.13m	2-pcs	20-60	35mm	280mm	6+Tip	132
NEW	WP-S-802L	L	2.44m	2-pcs	5-25	35mm	295mm	7+Tip	136
NEW	WP-S-802M	M	2.44m	2-pcs	15-40	35mm	310mm	7+Tip	147
NEW	WP-S-802H	H	2.44m	2-pcs	30-80	35mm	310mm	7+Tip	170
NEW	WP-S-902L	L	2.74m	2-pcs	7-30	35mm	300mm	7+Tip	163
NEW	WP-S-902M	M	2.74m	2-pcs	20-50	35mm	310mm	7+Tip	173
NEW	WP-S-902H	H	2.74m	2-pcs	30-100	35mm	310mm	7+Tip	201
Tele Spin									
NEW	WP-S-605M-T	M	1.83m	5-pcs	5-20	35mm	235mm	4+Tip	101
NEW	WP-S-705M-T	M	2.13m	5-pcs	10-30	35mm	250mm	4+Tip	108
NEW	WP-S-806M-T	M	2.44m	6-pcs	15-40	35mm	265mm	5+Tip	143
NEW	WP-S-907M-T	M	2.74m	7-pcs	20-50	35mm	300mm	5+Tip	192
NEW	WP-S-1007M-T	M	2.74m	7-pcs	25-60	35mm	345mm	6+Tip	223



BALTIC STICK

BALTIC STICK RODS FEATURE:

- High modulus ultra-responsive carbon blank construction.
- Double foot, stainless steel guide frames.
- Zirconium guides inserts reduce friction.
- Quality Okuma graphite reel seat.
- EVA fore and rear grips for maximum durability.
- Rubber end cap.
- Supplied in quality rod bag



BALTIC STICK

	Model	Rod Power	Length	Casting Wt. (g)	Sections	Foregrip length	Reargrip Length	Number of Guide	Weight (g)
	BAL-S-802MH	MH	8'0"	180g	2-pcs	120mm	325mm	7+TIP	244
	BAL-S-802H	H	8'0"	100-250	2-pcs	120mm	325mm	7+TIP	263
	BAL-S-902MH	MH	9'0"	180	2-pcs	120mm	325mm	7+TIP	263
	BAL-S-902H	H	9'0"	100-250	2-pcs	120mm	325mm	7+TIP	296
	BAL-S-1002MH	MH	10'0"	180	2-pcs	120mm	370mm	7+TIP	310

TACTICAL

TACTICAL RODS FEATURE:

- High modulus ultra-sensitive and responsive carbon blank construction
- Fast tape with UFR TIP design
- Anti-tangle stainless steel guides frame
- Double footed guides with polished titanium oxide guide inserts
- Okuma tooling split trigger reel seat
- Hard EVA split handle design
- Quality cloth bag package



TACTICAL

Model	Rod Power	Length	Sections	Casting Wt. (oz)	Line Wt. (lbs)	Reargrip Length	Number of Guide	Handle Style	Weight (g)
TT-C-661M	M	6'6"	1-pcs	1/8-5/8	8-14	240mm	9+TIP	A	105
TT-C-6101MH	MH	6'10"	1-pcs	1/4-1	10-20	240mm	9+TIP	A	109
TT-C-702MH	MH	7'0"	2-pcs	1/4-1 1/2	10-20	265mm	9+TIP	A	123
TT-C-701MH	MH	7'0"	1-pcs	1/4-3/4	10-20	265mm	9+TIP	A	113
TT-C-701H	H	7'0"	1-pcs	1/4-1/2	12-30	265mm	9+TIP	A	131
TT-C-741MH	MH	7'4"	1-pcs	1/4-1 1/2	10-20	285mm	9+TIP	A	114
TT-C-741H	H	7'4"	1-pcs	1/4-3/4	14-30	285mm	9+TIP	A	126
TT-S-562UL	UL	5'6"	2-pcs	1/32-3/16	4-8	20mm	6+Tip	B	75
TT-S-702MH	MH	7'0"	2-pcs	1/4-3/4	10-20	265mm	7+Tip	B	122
TT-S-701MH	MH	7'0"	1-pcs	1/4-3/4	10-20	265mm	7+Tip	B	118

RED

RED RODS FEATURE:

- High modulus ultra-sensitive and responsive carbon blank construction
- Fast tape design special for RED rods on application
- Okuma tooling split reel seat with cushioned stainless steel hood
- Camou EVA split grip and zero fore grip for reduced weight and feel
- Quality cloth bag package
- Quality stainless steel guides frame
- Polished titanium oxide guide inserts



RED

Model	Rod Power	Length	Sections	Line Wt. (lbs)	Casting Wt. (oz)	Reargrip Length	Number of Guide	Handle Style	Weight (g)
Spinninh									
NEW R-S-662MH	MH	6'6"	2-pcs	10-18	3/16-5/8	275mm	8+Tip	A	126
R-S-702MH	MH	7'0"	2-pcs	8-14	4-18	250mm	7+TIP	A	136
Casting									
NEW R-C-662MH	MH	6'6"	2-pcs	10-18	3/16-5/8	275mm	8+Tip	B	126
R-C-702MH	MH	7'0"	2-pcs	10-20	7-21	275mm	9+TIP	B	142
R-C-701MH	MH	7'0"	1-pcs	10-20	7-21	275mm	9+TIP	B	134

RED V1

RED V1 RODS FEATURE:

- High modulus ultra-sensitive and responsive carbon blank construction
- Fast tape blank special design for bass rods series
- Okuma tooling skeleton reel seat with cushioned stainless steel hood
- Durable Polymer and EVA split grip to reduce the weight and keep the balance
- Quality stainless steel guides frame
- Polished titanium oxide guide inserts
- Supplied with a quality rod bag



RED V1

Model	Rod Power	Length	Sections	Line Wt. (lbs)	Lure Wt. (oz)	Reargrip Length	Number of Guide	Handle Style	Weight (g)
Casting									
NEW REV1-C-662MH	MH	6'6"	2-pcs	10-18	3/16-5/8	275mm	8+Tip	B	128
NEW REV1-C-702MH	MH	7'0"	2-pcs	10-20	1/4-3/4	275mm	9+Tip	B	145
Spinning									
NEW REV1-S-702MH	MH	7'0"	2-pcs	10-20	1/4-3/4	260mm	7+Tip	A	139

PSYCHO-PERCH SPIN

PSYCHO PERCH RODS FEATURE:

- Ultra-light high modulus carbon blank construction
- UFR: Ultimate Flex Reinforced rod tip technology
- New exclusive psychedelic blank artwork
- CCS Seaguide, 316 stainless steel frame SIC guide
- View blank screw down reel seat
- 3 split EVA handle with rubber cork inserts
- Covering all European styles of perch fishing
- High quality cloth bag



PSYCHO PERCH

	Model	Rod Power	Length	Sections	Casting Wt. (g)	Foregrip length	Reargrip Length	Number of Guide	Handle Style	Weight (g)	
	UFR SPIN										
NEW	PSY-S-632UL	UL	1.90m	2-pcs	1-8	25mm	235mm	7+Tip	A	78	
NEW	PSY-S-632L	L	1.90m	2-pcs	2-12	25mm	235mm	7+Tip	A	81	
NEW	PSY-S-632ML	ML	1.90m	2-pcs	3-18	25mm	235mm	7+Tip	A	84	
NEW	PSY-S-732L	L	2.20m	2-pcs	3-18	25mm	235mm	8+Tip	A	90	
NEW	PSY-S-732ML	ML	2.20m	2-pcs	4-24	25mm	235mm	8+Tip	A	96	
NEW	PSY-S-732M	M	2.20m	2-pcs	7-32	25mm	235mm	8+Tip	A	102	
NEW	PSY-S-772UL	UL	2.30m	2-pcs	1-8	25mm	235mm	9+Tip	A	93	
NEW	PSY-S-772L	L	2.30m	2-pcs	2-12	25mm	235mm	9+Tip	A	99	
NEW	PSY-S-772ML	ML	2.30m	2-pcs	3-18	25mm	235mm	9+Tip	A	105	
NEW	PSY-S-892UL	UL	2.67m	2-pcs	1-8	25mm	290mm	10+Tip	A	109	
NEW	PSY-S-892L	L	2.67m	2-pcs	2-12	25mm	290mm	10+Tip	A	112	
NEW	PSY-S-892ML	ML	2.67m	2-pcs	3-18	25mm	290mm	10+Tip	A	115	
	UFR CASTING										
NEW	PSY-C-732ML	ML	2.30m	2-pcs	4-24	25mm	275mm	10+Tip	B	106	
NEW	PSY-C-732M	M	2.30m	2-pcs	7-32	25mm	275mm	10+Tip	B	115	



G-Control

G-CONTROL RODS FEATURE:

- Ultra-light high modulus carbon blank construction
- UFR sensitive tip and crossed carbon thread improve lifting power and maximum strength
- All rods have been designed for specific trout fishing
- Seaguide XO anti-tangle 316-stainless steel guides
- Zirconium guides inserts reduce friction
- Light weight ergonomic touch blank reel seats
- Ergonomic shaped, hard EVA handles
- EVA split grip and EVA fore grip for reduced weight and feel.
- High quality cloth bag package



G-CONTROL

	Model	Rod Power	Length	Sections	Casting Wt. (g)	Foregrip length	Reargrip Length	Number of Guide	Weight (g)
	GCT-S-622UL	UL	6'2"	2-pcs	0.6-3	35mm	175mm	7+TIP	78
	GCT-S-622L	L	6'2"	2-pcs	1-4	35mm	175mm	7+TIP	80
	GCT-S-702L	L	7'0"	2-pcs	1-8	35mm	225mm	8+TIP	86
	GCT-S-802L	L	8'0"	2-pcs	1-8	35mm	245mm	9+TIP	97

LRF

LRF RODS FEATURE:

- OKUMA Patent UFR Technology on the Tip blank, increased rod's sensitive tip, lifting power and maximum strength
- Seaguide unique XO guides, SS316 frame and SIC inserts
- Line Flow Tapered Micro Guide system
- Deluxe Okuma gold label reel seat
- Spiral Carbon tape design on the Butt section, improved strength, durability, and highlighted the whole rod
- Split grip butt design for reduced weight and improved balance



LRF

Model	Rod Power	Length	Sections	Casting Wt. (g)	Foregrip length	Reargrip Length	Number of Guide	Handle Style	Weight (g)
LRF-S-602L	L	6'0"	2-pcs	1-7	35mm	235mm	7+TIP	A	78
LRF-S-662L	L	6'6"	2-pcs	2-8	35mm	235mm	7+TIP	A	80
LRF-S-702L	L	7'0"	2-pcs	2-8	35mm	235mm	8+TIP	A	92
LRF-S-762L	L	7'6"	2-pcs	3-9	35mm	235mm	8+TIP	A	95
LRF-S-803L	L	8'0"	3-pcs	2-12	35mm	305mm	9+Tip	A	99
Dropshop									
LRF-S-802M	M	8'0"	2-pcs	5-25	35mm	290mm	9+TIP	A	107
LRF-S-702MH	MH	7'0"	2-pcs	10-50	35mm	250mm	8+TIP	A	113
TELE SPIN									
LRF-S-605UL-T	UL	6'0"	5-Tele	1-7	35mm	215mm	4+TIP	B	90
LRF-S-665UL-T	UL	6'6"	5-Tele	1-8	35mm	215mm	4+TIP	B	96
LRF-S-706UL-T	UL	7'0"	6-Tele	1-8	35mm	215mm	5+TIP	B	99
LRF-S-766UL-T	UL	7'6"	6-Tele	1-9	35mm	215mm	5+TIP	B	103

Light Range Fishing

Okuma have patented the UFR technology – that truly gives an amazing performance on the light range fishing rods.

LIGHT RANGE FISHING RODS FEATURE:

- Light weight 24T carbon material.
- Japanese EVA split handle construction.
- Okuma quality reel seat.
- CCS SIN shooting guides.
- Okuma UFR tip strength
- Cloth bag included.



LIGHT RANGE FISHING

Model	Rod Power	Length	Sections	Casting Wt. (g)	Foregrip length	Reargrip Length	Number of Guide	Weight (g)
LRF-S-612L-1	L	6'1"	2-pcs	1-7	35mm	245mm	7+TIP	80
LRF-S-712ML-1	ML	7'1"	2-pcs	3-12	35mm	245mm	8+TIP	98
LRF-S-812ML-1	ML	8'1"	2-pcs	8-22	35mm	295mm	9+TIP	129
LRF-S-862M-1	M	8'6"	2-pcs	12-32	35mm	295mm	9+TIP	146

Light Range Fishing TELE SPIN



LIGHT RANGE FISHING TELE SPIN

Model	Rod Power	Length	Sections	Casting Wt. (g)	Foregrip length	Reargrip Length	Number of Guide	Weight (g)
LRF-T-605UL-1	UL	6'0"	5-Tele	1-7	35mm	215mm	4+TIP	94
LRF-T-706L-1	L	7'0"	6-Tele	3-12	35mm	215mm	5+TIP	103
LRF-T-766ML-1	ML	7'6"	6-Tele	8-22	35mm	215mm	5+TIP	113

RODSTER SPIN

RODSTER RODS FEATURE:

- Super strong composite & graphite blank construction
- UFR: Ultimate Flex Reinforced rod tip technology
- 15% lighter than Classic UFR rods
- Double leg SIC guides
- Full EVA handle with Rubber cork top ring
- Strong graphite reel seat with cushions and hoods
- ABS butt cap on spin models
- Soft ABS gimbal on boat models



RODSTER

	Model	Rod Power	Length	Sections	Lure Wt. (g)	Foregrip length	Reargrip Length	Number of Guide	Handle Style	Weight (g)
	Spinning									
NEW	RST-S-562L	L	1.67m	2-pcs	5-15	55mm	175mm	5+Tip	A	118
NEW	RST-S-562M	M	1.67m	2-pcs	10-30	55mm	175mm	5+Tip	A	123
NEW	RST-S-662L	L	1.97m	2-pcs	7-15				A	154
NEW	RST-S-702L	L	2.13m	2-pcs	4-15	70mm	225mm	5+Tip	A	166
NEW	RST-S-702M	M	2.13m	2-pcs	10-30	70mm	225mm	5+Tip	A	181
NEW	RST-S-702H	H	2.13m	2-pcs	20-60	70mm	225mm	5+Tip	A	212
NEW	RST-S-802L	L	2.44m	2-pcs	5-20	80mm	285mm	5+Tip	A	197
NEW	RST-S-802M	M	2.44m	2-pcs	10-30	80mm	285mm	5+Tip	A	225
NEW	RST-S-802H	H	2.44m	2-pcs	20-60	80mm	285mm	5+Tip	A	256
NEW	RST-S-902MH	MH	2.74m	2-pcs	20-60	80mm	405mm	5+Tip	A	288
NEW	RST-S-902H	H	2.75m	2-pcs	40-80	80mm	405mm	5+Tip	A	306
NEW	RST-S-1002H	H	3.04m	2-pcs	40-80	90mm	465mm	6+Tip	A	328
	Boat									
	RST-C-602M Boat	M	1.82m	2-pcs	20-30lbs	120mm	405mm	6+Tip	B	246
	RST-C-702M Boat	M	2.13m	2-pcs	20-30lbs	140mm	425mm	6+Tip	B	301

TOMCAT

TOMCAT RODS FEATURE:

- Responsive and durable 24T carbon blank construction
- Heavy duty matt gunsmoke SIC guides
- CCS Seaguide for Vertical item
- Strong graphite reel seat with cushions
- Rubber round butt cap
- 4 series covering all type of carfish disciplines
- Supplied in quality cloth bag



TOMCAT

	Model	Rod Power	Length	Sections	Lure Wt. (g)	Foregrip length	Reargrip Length	Number of Guide	Weight (g)	
	SPIN									
NEW	TMC-S-702MH	MH	2.13m	2-pcs	60-160	120mm	380mm	6+Tip	300	
NEW	TMC-S-802MH	MH	2.44m	2-pcs	60-160	120mm	410mm	6+Tip	350	
NEW	TMC-S-902MH	MH	2.74m	2-pcs	60-160	120mm	460mm	6+Tip	394	
	X-STRONG									
NEW	TMC-S-802XH	XH	2.44m	2-pcs	200-300	135mm	465mm	5+Tip	388	
NEW	TMC-S-902XH	XH	2.74m	2-pcs	200-300	135mm	485mm	6+Tip	445	
NEW	TMC-S-992XH	XH	2.98m	2-pcs	200-300	135mm	485mm	7+Tip	528	
	EXPERT									
NEW	TMC-S-1062H	H	3.20m	2-pcs	100-250	200mm	465mm	7+Tip	198	
	VERTICAL									
NEW	TMC-S-602MH	MH	1.83m	2-pcs	150	130mm	390mm	6+Tip	264	

8K Carp

8K CARP RODS FEATURE:

- 40T Toray carbon material, slim, light and powerful blank construction
- Black stainless steel frame guides with SIC inserts
- Fuji DPS pate reel seat
- Okuma carbon line clip
- Slim and Ergonomic shape EVA with durable shrink tube butt handle
- Engraved aluminum butt cap
- High quality cloth bag



8K CARP

	Model	Rod Power	Length	Sections	Lure Wt. (lbs)	Foregrip length	Reargrip Length	Number of Guide	Weight (g)
NEW	8K-CA-1002MH	MH	10'0"	2-pcs	3.0	20mm	560mm	5+Tip	213
NEW	8K-CA-1202MH	MH	12'0"	2-pcs	3.0	20mm	560mm	5+Tip	252
NEW	8K-CA-1202H	H	12'0"	2-pcs	3.5	20mm	560mm	5+Tip	290
NEW	8K-CA-1302H	H	13'0"	2-pcs	3.5	20mm	560mm	5+Tip	319

LS-6K carp

LS-6K CARP RODS FEATURE:

- Slim and light weight 30T carbon Blank
- Exclusive Okuma BOPP blank covering
- Okuma DPS reel seat
- Okuma carbon line clip
- Ergonomic shape EVA with durable shrink tube butt handle
- Engraved aluminum butt cap
- High quality cloth bag



LS-6K CARP

	Model	Rod Power	Length	Sections	Lure Wt. (g)	Foregrip length	Reargrip Length	Number of Guide	Weight (g)
NEW	LS-CA-1002MH	MH	10'0"	2-pcs	3.0lbs	20mm	560mm	5+Tip	261
NEW	LS-CA-1202MH	MH	12'0"	2-pcs	3.0lbs	20mm	560mm	5+Tip	296
NEW	LS-CA-1202H	H	12'0"	2-pcs	3.5lbs	20mm	560mm	5+Tip	341
NEW	LS-CA-1302H	H	13'0"	2-pcs	3.5lbs	20mm	560mm	5+Tip	378



Custom Black carp

CUSTOM BLACK RODS FEATURE:

- Slim and light weight 24T carbon blank
- SIC Guides
- Heavy Duty Okuma graphite reel seat
- Ergonomic shaped EVA with durable shrink tube handle
- Supplied in a quality rod bag



CUSTOM BLACK CARP

	Model	Rod Power	Length	Sections	Lure Wt. (lbs)	Foregrip length	Reargrip Length	Number of Guide	Weight (g)
	CB-CA-1202MH	MH	12'0"	2-pcs	3.0	20mm	590mm	5+Tip	324
	CB-CA-1202H	H	12'0"	2-pcs	1.6	20mm	590mm	5+Tip	360
	CB-CA-1203H	H	12'0"	3-pcs	1.6	20mm	590mm	5+Tip	367
	CB-CA-1302H	H	13'0"	2-pcs	1.6	20mm	590mm	5+Tip	418
	CB-CA-1303H	H	13'0"	3-pcs	1.6	20mm	590mm	5+Tip	388
	CB-CA-1202XXH	XXH	12'0"	2-pcs	2.3	20mm	590mm	5+Tip	390



C-FIGHT Carp

C-FIGHT CARP RODS FEATURE:

- Light weight 24T carbon blank
- Exclusive camouflage blank covering
- Minimalistic artwork matching UK codes
- Semi matt frame SIC guides
- Starting guide 50mm on 12'0"
- Slim EVA butt handle
- Engraved aluminum butt cap
- Graphite reel seat with cushions
- Telescopic version available



C-FIGHT CARP

	Model	Rod Power	Length	Sections	Lure Wt. (lbs)	Foregrip length	Reargrip Length	Number of Guide	Weight (g)
NEW	CF-CA-802M	M	8'0"	2-pcs	2.50lbs	N/A	380mm	5+Tip	168
NEW	CF-CA-902M	M	9'0"	2-pcs	2.75lbs	N/A	450mm	5+Tip	208
NEW	CF-CA-1002MH	MH	10'0"	2-pcs	3.00lbs	N/A	500mm	5+Tip	273
NEW	CF-CA-1202H	H	12'0"	2-pcs	3.25lbs	N/A	550mm	5+Tip	354
NEW	CF-CA-1206H-T	H	12'0"	6-Tele	3.25lbs	N/A	570mm	5+Tip	295



AVENGER Carp

AVENGER CARP RODS FEATURE:

- Light weight carbon blanks
- Quality stainless steel guides
- Heavy Duty Okuma graphite reel seat
- Supplied in rod bag



AVENGER CARP

	Model	Rod Power	Length	Sections	Lure Wt. (lbs)	Foregrip length	Reargrip Length	Number of Guide	Weight (g)
	AV-CA-1002MH	MH	10'0"	2-pcs	3.0	20mm	500mm	5+Tip	268
	AV-CA-1202MH	MH	12'0"	2-pcs	3.0	20mm	560mm	5+Tip	324
	AV-CA-1202H	H	12'0"	2-pcs	3.5	20mm	560mm	5+Tip	344
	AV-CA-1203H	H	12'0"	3-pcs	3.5	20mm	560mm	5+Tip	367
	AV-CA-1302H	H	13'0"	2-pcs	3.5	20mm	560mm	6+Tip	420
	AV-CA-1206H-T	H	12'0"	6-Tele	3.5	20mm	560mm	5+Tip	319

ALTERA

ALTERA TELE CAST RODS FEATURE:

- Light weight 24T carbon blank
- Matt gunsmoke frame SIC guides
- Okuma graphite reel seat
- Slim EVA butt handle
- Aluminum screw end cap with non-skid rubber
- Supplied in quality cloth bag



ALTERA TELECAST

	Model	Rod Power	Length	Sections	Lure Wt. (g)	Foregrip length	Reargrip Length	Number of Guide	Weight (g)
NEW	ALT-S-1206MH-T	MH	12'0"	6-Tele	40-80g	N/A	510mm	5+Tip	278
NEW	ALT-S-1206H-T	H	12'0"	6-Tele	50-100g	N/A	510mm	5+Tip	296
NEW	ALT-S-1306H-T	H	13'0"	6-Tele	60-120g	N/A	540mm	5+Tip	364

8K

8K FEEDER RODS FEATURE:

- Ultra light 40T carbon blank construction
- Faster action with 2 different power tips
- Black frame SIC guides
- Fuji DPS plate reel seat
- AAA cork quality full handle
- High quality rods bags



8K FEEDER

	Model	Rod Power	Length	Sections	Casting Wt. (g)	Foregrip length	Reargrip Length	Number of Guide	Weight (g)
NEW	8K-F-1203H	H	12'0"	3-pcs	60-120g	65mm	450mm	13+Tip	202
NEW	8K-F-1303H	H	13'0"	3-pcs	60-120g	65mm	450mm	14+Tip	208

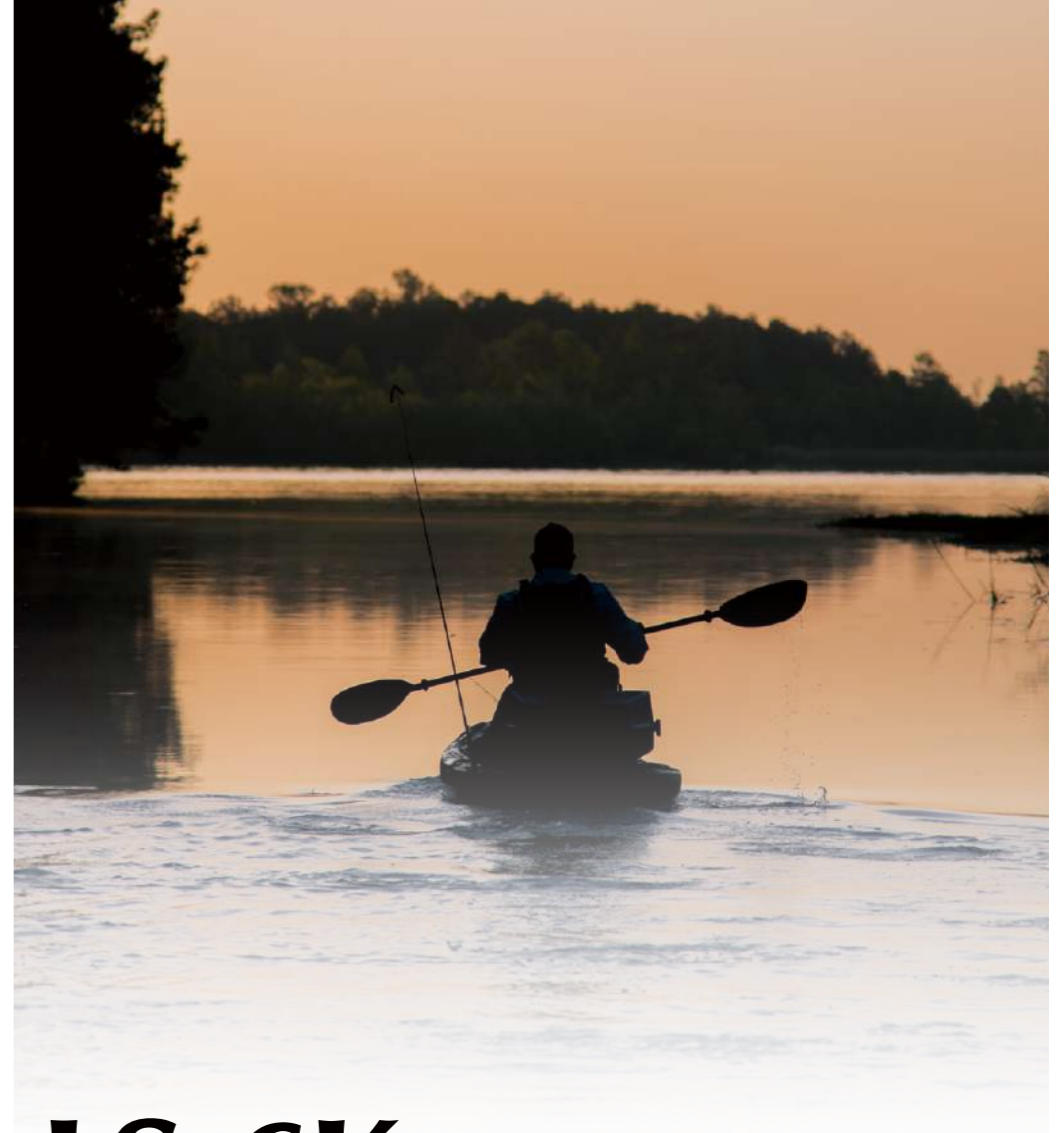

LS-6K

LS-6K FEEDER RODS FEATURE:

- Slim and light weight 30T carbon blanks
- Faster action with 2 different power tips
- Exclusive Okuma BOPP blank covering
- Black frame SIC guides
- Okuma DPS reel seat
- Quality cork quality full handle
- Supplied in quality rods bags



LS-6K

	Model	Rod Power	Length	Sections	Lure Wt. (g)	Foregrip length	Reargrip Length	Number of Guide	Weight (g)
NEW	LS-F-1203MH	MH	12'0"	3-pcs	40-80g	65mm	450mm	13+Tip	
NEW	LS-F-1203H	H	12'0"	3-pcs	60-120g	65mm	450mm	13+Tip	220
NEW	LS-F-1303H	H	13'0"	3-pcs	60-120g	65mm	450mm	14+Tip	235
NEW	LS-F-1303XH	XH	13'0"	3-pcs	150g	65mm	470mm	14+Tip	261
NEW	LS-F-1403XH	XH	14'0"	3-pcs	150g	65mm	470mm	15+Tip	305

Custom Black Feeder

CUSTOM BLACK FEEDER RODS FEATURE:

- Slim and light weight 30T carbon blanks
- Fast action with 3 different power tips
- Unique use of Bopp Blank protect film
- Quality stainless steel guides
- Okuma graphite reel seat
- Supplied in quality rod bag



CUSTOM BLACK FEEDER

Model	Rod Power	Length	Sections	Lure Wt. (g)	Foregrip length	Reargrip Length	Number of Guide	Weight (g)
CB-F-1003MH	MH	10'0"	3-pcs	up to 80	65mm	450mm	12+Tip	172
CB-F-1203MH	MH	12'0"	3-pcs	40-80	65mm	450mm	13+Tip	219
CB-F-1203H	H	12'0"	3-pcs	60-120	65mm	450mm	13+Tip	248
CB-F-1303MH	MH	13'0"	3-pcs	40-80	65mm	450mm	14+Tip	249
CB-F-1303H	H	13'0"	3-pcs	60-120	65mm	450mm	14+Tip	294
CB-F-1103MH	MH	11'0"	3-pcs	60	65mm	430mm	12+Tip	197
CB-F-1203MH	MH	12'0"	3-pcs	60	65mm	450mm	13+Tip	213
CB-F-1303XH	XH	13'0"	3-pcs	150	65mm	470mm	14+Tip	299
CB-F-1403XH	XH	14'0"	3-pcs	150	65mm	490mm	15+Tip	327

Ceymar



CEYMAR FEEDER

Model	Rod Power	Length	Sections	Lure Wt. (g)	Foregrip length	Reargrip Length	Number of Guide	Weight (g)
Feeder								
C-F-1203M	M	3.60m	3-pcs	40-80	65mm	450mm	13+Tip	261
C-F-1203H	H	3.60m	3-pcs	60-120	65mm	450mm	13+Tip	282
C-F-1303M	M	3.90m	3-pcs	40-80	65mm	450mm	14+Tip	295
C-F-1303H	H	3.90m	3-pcs	60-120	65mm	450mm	14+Tip	334
Method Feeder								
C-F-1103M-1	M	3.30m	3-pcs	601	65mm	450mm	14+Tip	232
C-F-1203M-1	M	3.60m	3-pcs	60	65mm	430mm	12+Tip	254
River Feeder								
C-F-1303XH-1	XH	3.90m	3-pcs	150	65mm	450mm	14+Tip	369
C-F-1403XH-1	XH	4.20m	3-pcs	150	65mm	470mm	15+Tip	386



Ceymar

CEYMAR MATCH / FEEDER RODS FEATURE:

- Slim and balanced carbon blanks
- Progressive action
- Supplied with 3 tips in tube for all feeder rods
- Quality stainless steel frame guides
- Polished Titanium Oxide guide inserts
- Okuma quality graphite reel seat
- Quality cork and EVA handles
- Supplied in quality rod bag



CEYMAR MATCH

Model	Rod Power	Length	Sections	Lure Wt. (g)	Foregrip length	Reargrip Length	Number of Guide	Weight (g)
C-M-1303M	M	3.90m	3-pcs	5-25	65mm	430mm	12+Tip	237
C-M-1403M	M	4.20m	3-pcs	5-25	65mm	430mm	13+Tip	257

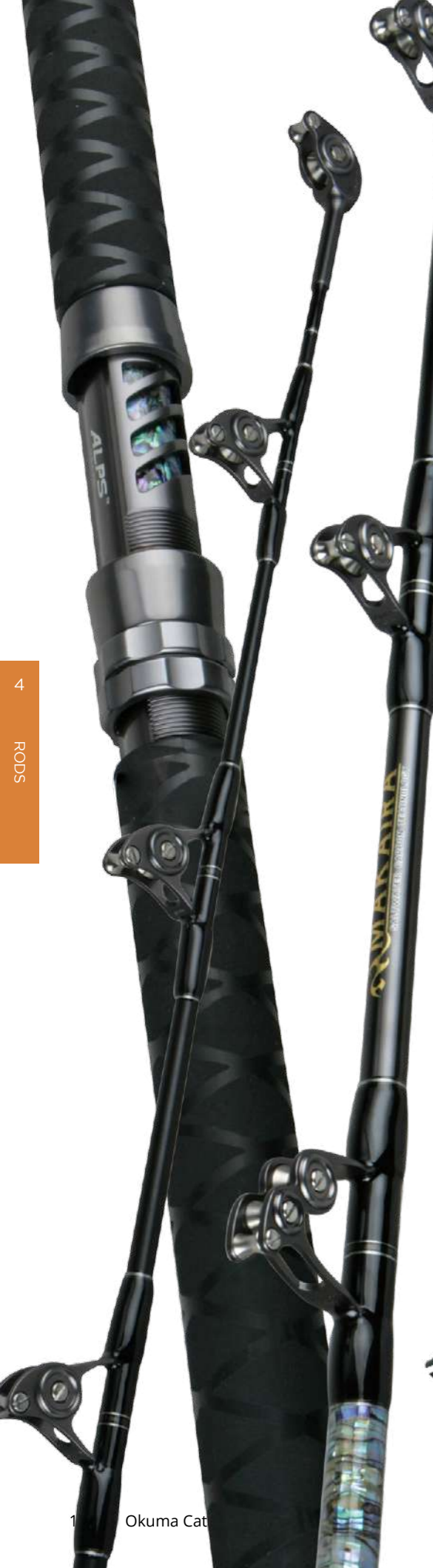

MAKAIRA

SALTWATER CARBON TECHNOLOGY

MAKAIRA RODS FEATURE:

- Carbon composite rod blank technology
- ALPS deep press 316 stainless guide frames
- Hard Zirconium guide inserts for compatibility with braided lines
- Custom ALPS aluminum reel seats with Abalone under lay
- IGFA tournament rods with full straight or bent aluminum rod butts
- Shrink tube grips for ultimate durability
- ALPS roller guides on trolling rods with large knot clearance
- Aluminum gimbals on trolling and popping rods
- Integrated rubber butt cap/gimbal design on all casting and spinning rods
- Custom abalone decoration above fore grip
- Custom leather wrapped fore grip on IGFA Stand Up rods



C ALPS aluminum butt section



D Bent butt section



NEW ALPS RX PREMIUM ROLLER GUIDES

- * Tournament IGFA series rods feature black and gold RX roller guides
- * All Roller Trolling rods feature gunsmoke RX roller guides

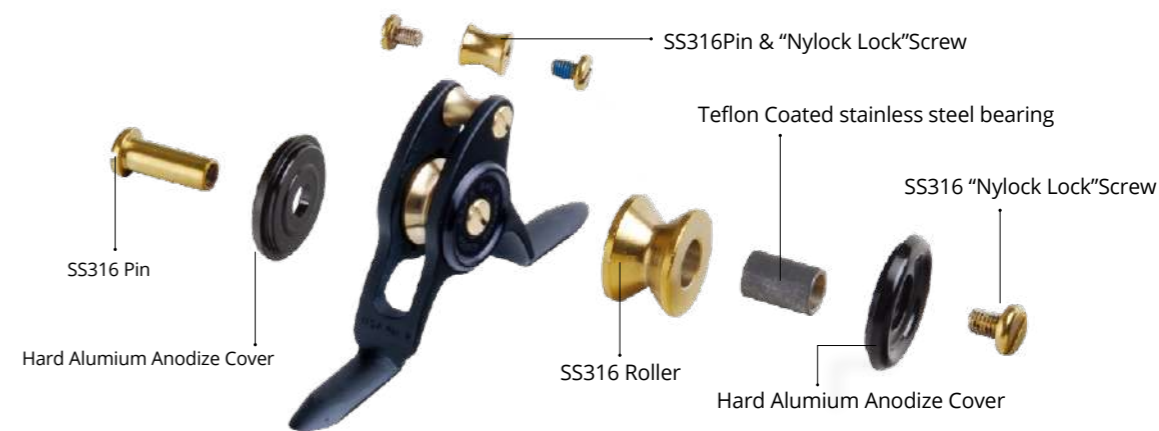

MAKAIRA SALTWATER RODS

Model	Rod Power	Rod Taper	Rod Length	Line Weight (lbs)	Lure Weight	Sections	Foregrip length	Reargrip length	Number of Guides	Handle Style	Weight (g)
Makaira IGFA Straight butt Stand-up Rods											
MAK-TR-581-30S	H	M/MF	5' 8"	30	N/A	1-pcs	330mm	300mm	4 + Tip	C	1012
MAK-TR-581-50S	XH	M/MF	5' 8"	50	N/A	1-pcs	330mm	300mm	4 + Tip	C	1055
MAK-TR-5101-80S	XXXH	M/MF	5'10"	80	N/A	1-pcs	330mm	360mm	4 + Tip	C	1165
Makaira IGFA Bent butt Stand-up Rods											
MAK-TR-5101-50B	XH	M/MF	5'8"	50	N/A	1-pcs	330mm	380mm	4 + Tip	D	1311
MAK-TR-5101-80B	XXH	M/MF	5' 10"	80	N/A	2-pcs	330mm	380mm	4 + Tip	D	1342



SLX BOAT

SLX BOAT RODS FEATURE:

- E-glass blank construction for maximum durability
- Heavy duty double foot guide frame
- Polished titanium oxide guide inserts
- Aluminum reel seat with extra locking nut
- EVA fore and rear grips for maximum durability
- Special cutting flat design on fore grip on application
- Machined aluminum gimbal with EVA cap
- High strength quality cloth bag package



SLX BOAT

Model	Rod Power	Length	Sections	Line Wt. (kg)	Foregrip length	Reargrip Length	Number of Guide	Weight (g)
SLX-C-701MH	MH	7'0"	1-pcs	10-15	350mm	275mm	8+TIP	467
SLX-C-561MH-15	MH	5'6"	1-pcs	15	390mm	345mm	6+TIP	598
SLX-C-561H-24	H	5'6"	1-pcs	24	390mm	345mm	6+TIP	649
SLX-C-561H-24R	H	5'6"	1-pcs	24	390mm	345mm	6+R TIP	667

Remark : R=Roller Tip

SLX

SLX TROLLING RODS FEATURE:

- Responsive and durable 24-ton carbon blank construction
- Split handle ferrule connection, for natural bending and easy transportation
- Anti-tangle stainless steel guides frames
- Zirconium guides inserts reduce friction from braided lines
- Machined aluminum reel seat with extra locking nut



SLX

Model	Rod Power	Length	Sections	Line Wt. (lbs)	Foregrip length	Reargrip Length	Number of Guide	Weight (g)
SLX-C-682ML	ML	6'8"	2-pcs	4-6	220mm	375mm	7+TIP	283
SLX-C-682M	M	6'8"	2-pcs	8-12	220mm	375mm	7+TIP	295
SLX-C-682MH	MH	6'8"	2-pcs	16-20	220mm	375mm	7+TIP	320



SLY

SLY RODS FEATURE:

- Durable E-glass blank construction
- Fuji K-concept tangle free guides with Alconite inserts
- Special spiral guides design for all trolling and tuna rods
- ALPS Aluminum reel seat with large knot clearance
- Alps Aluminum gimbal



SLY

Model	Rod Power	Length	Sections	Line Wt. (kg)	Foregrip length	Reargrip Length	Number of Guide	Weight (g)
Trollong								
NEW SLY-C-661ML	ML	1.95m	2-pcs	6-8lbs	270mm	300mm	9+Tip	442
NEW SLY-C-621M	M	1.85m	2-pcs	12-20lbs	270mm	300mm	8+Tip	458
Tuna								
NEW SLY-C-621MH	MH	1.85m	2-pcs	20-30lbs	270mm	300mm	8+Tip	534
NEW SLY-C-621H	H	1.85m	2-pcs	30-50lbs	270mm	300mm	8+Tip	562



CORTEZ

CORTEZ RODS FEATURE:

A super series of rods for modern sea fishing with both lures and Rigs/bait. Strong put-in 1/3 handle section and progressive, relatively tipped 2/3 blank section, with perfectly balanced action to play big fish like Cod, coalfish, halibut and big turbot.

- Light weight, high modulus carbon fiber blanks
- Stainless steel highrise guide frames with SIC rings
- Deluxe Okuma silver label reel seats
- Hard, durable EVA handle
- Okuma rubber gimbal for sea fishing
- High quality cloth bag package
- 3-sec rods supplied in deluxe travel bag



CORTEZ BOAT

Model	Rod Power	Length	Sections	Line Weight (lbs)	Foregrip length	Reargrip Length	Number of Guide	Weight (g)
Casting								
CZ-C-742L	L	2.23m	2-pcs	6-12	200mm	300mm	9+TIP	293
CZ-C-742ML	ML	2.23m	2-pcs	12-20	200mm	300mm	9+TIP	298
CZ-C-742M	M	2.23m	2-pcs	20-30	200mm	300mm	9+TIP	302
CZ-C-742MH	MH	2.23m	2-pcs	30-50	200mm	300mm	9+TIP	306
Travel Cast								
CZ-C-663M	M	1.98m	3-pcs	20-30	230mm	340mm	8+TIP	309
CZ-C-663MH	MH	1.98m	3-pcs	30-50	230mm	340mm	8+TIP	320



Cold Water

COLD WATER RODS FEATURE:

- Responsive and durable 24-ton carbon blank construction
- Okuma Stronger DPS reel seat
- EVA fore grips and Durable shrink tube rear grips
- Okuma rubber gimbal on all models
- High quality guide lines special for inline rods



A Pipe reel seat with EVA fore and rear grips and rubber gimbal

COLD WATER INLINE BOAT

Model	Rod Power	Length	Sections	Line Weight (lbs)	Foregrip length	Reargrip Length	Number of Guide	Handle Style	Weight (g)
CW-C-742M	M	2.20m	2-pcs	30	290mm	315mm	1+Tip	A	325
CW-C-742MH	MH	2.20m	2-pcs	50	290mm	315mm	1+Tip	A	332
CW-C-742H	H	2.20m	2-pcs	70	290mm	315mm	1+Tip	A	347





AZORES V2

AZORES V2 BLUE RODS FEATURE:

- Korean Quality high modulus carbon material
- Split handle ferrule connection design on popping rods
- ALPS deep press 316 stainless steel frames
- Zirconium guides inserts reduce friction from braided lines
- Hard, durable EVA handles
- Integrated rubber butt cap/gimbal
- 2-tone anodized metal parts
- Better quality cloth bag package



AZORES V2 POPPING

Model	Rod Power	Length	Sections	Line Wt.	Casting Wt. (g)	Foregrip length	Reargrip Length	Number of Guide	Weight (g)
Popping									
AZ-S-792MH	MH	7'9"	2-pcs	PE 4-6	45-150	180mm	425mm	6+TIP	366
AZ-S-792H	H	7'9"	2-pcs	PE 6-8	60-190	180mm	425mm	6+TIP	443
AZ-S-793MH	MH	7'9"	3-pcs	PE 4-6	45-150	180mm	385mm	6+TIP	378



Hawaiian Custom

HAWAIIAN CUSTOM POPPING RODS FEATURES:

- Light and responsive 24/30-Ton, low resin carbon rod blanks
- 70/30 rod blank design, 2-pcs construction butted in foregrip
- Premium Fuji reel seat for maximum reliability
- Fuji K-concept double foot guide frames, help reduce tangles
- Fuji Alconite guide inserts for abrasion resistance
- Oversized guide sizing allows for improved knot clearance while casting
- 2-pcs blank aides in transportation, but offers max power, based on ferrule location
- Tapered TPE foregrip with TPE rear split grips for reduced weight and balance



A TPE/Compressed cork rear spllit grip with Fuji pipe reel seat

HAWAIIAN CUSTOM POPPING

Model	Rod Power	Length	Sections	Line Wt.	Lure Wt. (g)	Foregrip length	Reargrip Length	Number of Guide	Handle Style	Weight (g)
NEW HWP-S-832Ma	M	8'3"	2-pcs	30-60lbs	30-160	140mm	490mm	6+Tip	A	378
NEW HWP-S-832MHa	MH	8'3"	2-pcs	50-100lbs	90-200	165mm	520mm	6+Tip	A	396



METALOID S

The metalloids rods are made to handle the toughest saltwater fishing, only using the best materials and components available. These rods will cast the big lures and poppers, and fight the torpedoes of the ocean.

METALOID S RODS FEATURE:

- KOREAN Quality carbon material
- OC-9 carbon outer wrap to improve blank strength
- Deep press tangle free frame SIC guides
- Fuji black reel seat with LO/AN double lock
- Hard black EVA handles with slim dark grey design
- Extended front handle for fight gripping
- Pac bay graphite gimbal
- Fast dry mesh rod bag



METALOID S POPPING

	Model	Rod Power	Length	Sections	Line Wt.	Lure Wt. (g)	Foregrip length	Reargrip Length	Number of Guide	Weight (g)
NEW	MTL-S-762Ma	M	7'6"	2-pcs	30-65lbs	30-160	165mm	455mm	6+Tip	320
NEW	MTL-S-792Ma	M	7'9"	2-pcs	50lbs	50-150	195mm	455mm	6+Tip	343
NEW	MTL-S-792MHa	MH	7'9"	2-pcs	80lbs	80-200	195mm	455mm	6+Tip	361



METALOID

METALOID JIGGING RODS FEATURE:

- Extremely light weight and responsive 24T carbon rods blanks
- Okuma special blanks design to improve hoop strength
- Crossed carbon design to highlight METALIOD jigging and reinforce the whole rod
- ALPS deep press 316 stainless steel guides frame for saltwater fishing
- Zirconium guides inserts reduce friction from braided lines
- Fuji reel seat on casting and spinning models
- 2-ton anodized metal parts
- Fast dry mesh rod bag
- 4 new modes with new cosmetic



METALOID JIGGING

	Model	Rod Power	Length	Sections	Line Wt.	Casting Wt. (g)	Foregrip length	Reargrip Length	Number of Guide	Handle Style	Weight (g)
Spinning Rod											
	MTL-S-531L	L	5'3"	1-pcs	PE 1.5-4	100-200	150mm	410mm	5+TIP	A	220
	MTL-S-501M	M	5'0"	1-pcs	PE 3-6	200-350	150mm	410mm	5+TIP	A	287
Casting Rod											
	MTL-C-531L	L	5'3"	1-pcs	PE 1.5-4	100-200	150mm	410mm	6+TIP	B	237
	MTL-C-501M	M	5'0"	1-pcs	PE 3-6	200-350	150mm	410mm	6+TIP	B	298
	M-C-531ML	ML	5'3"	1-pcs	PE 2-4	<200	150mm	410mm	6+TIP	C	291
	M-C-531M	M	5'3"	1-pcs	PE 3-5	<300	150mm	410mm	6+TIP	C	313
	M-C-521MH	MH	5'2"	1-pcs	PE 4-6	<400	150mm	410mm	6+TIP	C	326

TESORO

TESORO JIGGING RODS FEATURE:

- Extremely light weight and responsive 24T carbon rod blanks
- UFR: Ultimate Flex Reinforcement technology increases
- ALPS high-rise 316 stainless steel frame SIC guides
- ALPS Aluminum anodized gimbal with rubber cover
- Fuji heavy duty reel seat with LO/AN double lock
- Special camou BOPP blank covering
- High quality rods bag



TESORO JIGGING

Model	Rod Power	Length	Sections	Line Wt.	Lure Wt.(g)	Foregrip length	Reargrip Length	Number of Guide	Handle Style	Weight (g)
Casting Rods										
TSR-C-491XH	XH	4'9"	1-PCS	PE5-8	>500g	150mm	400mm	6+Tip	A	282
TSR-C-501H	H	5'0"	1-PCS	PE4-6	350-500g	150mm	400mm	6+Tip	A	278
TSR-C-511M	M	5'1"	1-PCS	PE3-5	250g-350g	150mm	400mm	6+Tip	A	273
Spinning Rods										
TSR-S-491XH	XH	4'9"	1-PCS	PE5-8	>500g	150mm	390mm	5+Tip	B	276
TSR-S-501H	H	5'0"	1-PCS	PE4-6	350-500g	150mm	390mm	5+Tip	B	268
TSR-S-511M	M	5'1"	1-PCS	PE3-5	250g-350g	150mm	390mm	5+Tip	B	263

AZORES

AZORES RODS FEATURE:

- Slim high modulus carbon blank, with power carbon wrap
- Split handle ferrule connection, for natural bending and easy transportation
- Guides from Fuji KWAG Alconite, anti-tangle and saltwater resistant
- Fuji stronger reel seat for sea fishing
- Ergonomic shaped, hard EVA handles
- Integrated rubber butt cap/gimbal
- Delivered in Quality cloth bag



AZORES JIGGING

Model	Rod Power	Length	Sections	Casting Wt. (g)	Line Weight (lbs)	Foregrip length (mm)	Reargrip Length	Number of Guide	Weight (g)
Jigging									
AZ-S-521MH	MH	5'2"	1-pcs	150-250	24kg	140mm	385mm	5+TIP	280
AZ-S-521H	H	5'2"	1-pcs	250-350	37kg	140mm	385mm	5+TIP	298
AZ-S-602ML	ML	6'0"	2-pcs	70-180	20-80	190mm	370mm	5+TIP	331
AZ-S-602M	M	6'0"	2-pcs	100-225	40-100	190mm	370mm	5+TIP	346
AZ-S-602MH	MH	6'0"	2-pcs	130-270	60-120	190mm	370mm	5+TIP	360

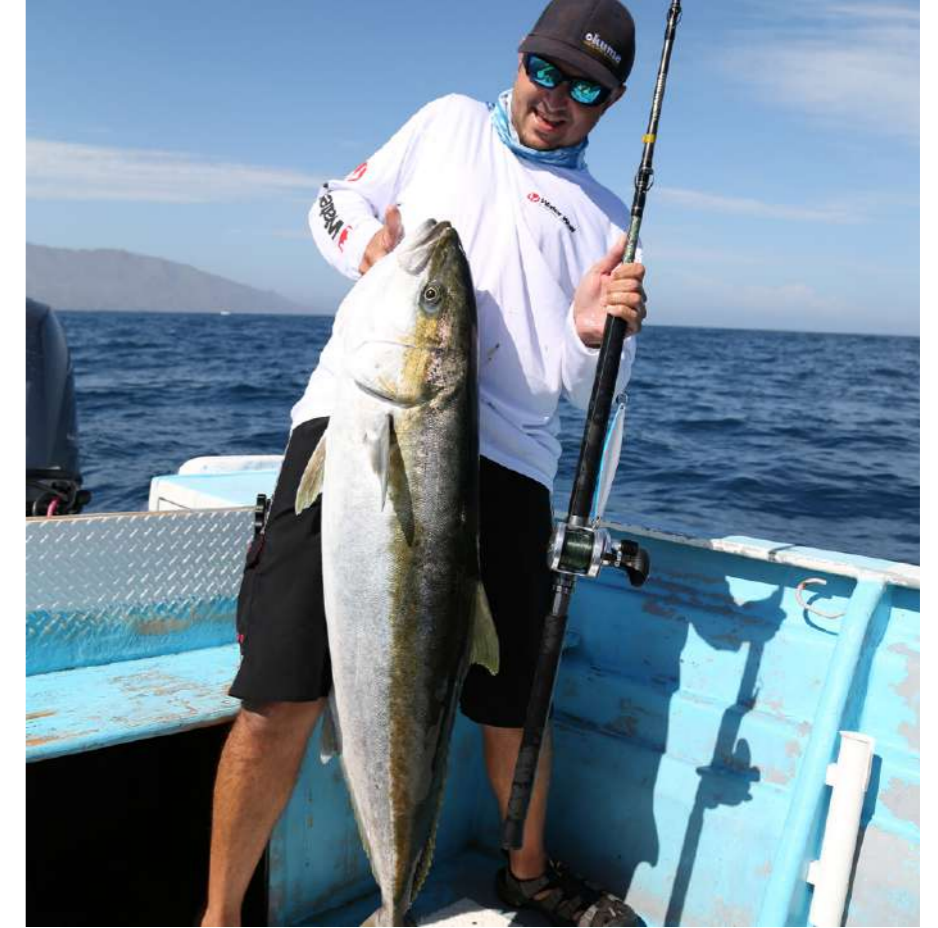

METALOID

METALOID SLOW JIGGING RODS FEATURE:

- Slim high modulus carbon blank, with power carbon wrap
- Handle Ferrule connection allows for natural bend of the rod and 1-pc feeling
- Ergonomic shaped, Hard EVA handles
- Strong trigger and pipe Fuji reel seat for casting and spinning models
- Split handle design for reduced weight and add comfort
- Guides from Fuji KWAG Alconite, anti-tangle and saltwater resistant
- Delivered in quality cloth bag



METALOID SLOW JIGGING

Model	Rod Power	Length	Sections	Casting Wt. (g)	Foregrip length	Reargrip Length	Number of Guide	Handle Style	Weight (g)
Casting Rods									
MTL-C-682M	M	6'8"	2-pcs	20-90	N/A	405mm	9+TIP	A	161
MTL-C-682MH	MH	6'8"	2-pcs	60-140	N/A	405mm	9+TIP	A	159
Spining Rods									
MTL-S-682M	M	6'8"	2-pcs	20-90	N/A	405mm	6+TIP	B	148
MTL-S-682MH	MH	6'8"	2-pcs	60-140	N/A	405mm	6+TIP	B	172

TESORO SLOW JIGGING

TESORO SLOW JIGGING RODS FEATURE:

- Extremely light weight and responsive 24T carbon rod blanks
- Special camou BOPP blank covering
- 1-pc and 1+1 blank design for perfect bending action
- Fuji K-concept tangle free frame Alconite guides
- Fuji DPS and TCS reel seat
- High quality rods bag



TESORO

Model	Rod Power	Length	Sections	Lure Wt. (g)	Foregrip length	Reargrip Length	Number of Guide	Handle Style	Weight (g)
Spinning Rods									
TSR-S-661ML	ML	6'6"	1-PCS	20-90	35mm	410mm	7+Tip	A	137
TSR-S-661M	M	6'6"	1-PCS	40-150	35mm	410mm	7+Tip	A	146
TSR-S-661MH	MH	6'6"	1-PCS	60-200	35mm	410mm	7+Tip	A	157
TSR-S-661H	H	6'6"	1-PCS	80-240	35mm	410mm	7+Tip	A	167
TSR-S-662M	M	6'6"	1-PCS	40-150	35mm	410mm	7+Tip	A	147
TSR-S-662MH	MH	6'6"	2-PCS	60-200	35mm	410mm	7+Tip	A	159
Casting Rods									
TSR-C-661ML	ML	6'6"	2-PCS	20-90	35mm	410mm	9+Tip	B	135
TSR-C-661M	M	6'6"	1-PCS	40-150	35mm	410mm	9+Tip	B	146
TSR-C-661MH	MH	6'6"	1-PCS	60-200	35mm	410mm	9+Tip	B	156
TSR-C-661H	H	6'6"	1-PCS	80-240	35mm	410mm	9+Tip	B	166
TSR-C-662M	M	6'6"	2-PCS	40-150	35mm	410mm	9+Tip	B	148
TSR-C-662MH	MH	6'6"	2-PCS	60-200	3500	410mm	9+Tip	B	158



AZORES

AZORES RODS FEATURE:

- Slim high modulus carbon blank, with power carbon wrap
- Split handle ferrule connection, for natural bending and easy transportation
- Guides from Fuji KWAG Alconite, anti-tangle and saltwater resistant
- Fuji stronger reel seat for sea fishing
- Ergonomic shaped, hard EVA handles
- Integrated rubber butt cap/gimbal
- Delivered in Quality cloth bag



AZORES SLOW JIGGING

Model	Rod Power	Length	Sections	Casting Wt. (g)	Line Weight (lbs)	Foregrip length (mm)	Reargrip Length	Number of Guide	Weight (g)
Slow Jigging									
AZ-S-682M	M	6'8"	2-pcs	20-90	N/A	N/A	405mm	6+TIP	162
AZ-S-682MH	MH	6'8"	2-pcs	60-140	N/A	N/A	405mm	6+TIP	187
AZ-S-702MH	MH	7'0"	2-pcs	60-140	N/A	N/A	355mm	6+TIP	194



MAGDA AIR

MAGDA AIR RODS FEATURE:

- Slim high modulus carbon blank, with crossed carbon wrap reinforcement
- Okuma patent UFR TIP technology design on Light jig rods
- All 1-pcs design for perfect bending action
- Fuji K-concept tangle free guides with Alconite inserts
- Spiral guides design for all slow jig rods
- Fuji reel seat
- Ergonomic shaped, hard EVA handles
- High quality cloth bag package



MAGDA AIR

Model	Rod Power	Length	Sections	Line Weight	Casting Wt. (g)	Foregrip length	Reargrip Length	Number of Guide	Handle	Weight (g)
Slow Jig										
MA-C-661ML	ML	6'6"	1-pcs	PE 1	120	N/A	410mm	9+TIP	B	138
MA-C-661M	M	6'6"	1-pcs	PE 2	160	N/A	410mm	9+TIP	B	151
MA-C-661MH	MH	6'6"	1-pcs	PE 3	220	N/A	410mm	9+TIP	B	163
MA-C-661H	H	6'6"	1-pcs	PE 4	300	N/A	410mm	9+TIP	B	173
Light Jig										
MA-LJS601M	M	6'0"	1-pcs	PE 1-3	90-150	115mm	350mm	7+TIP	A	127
MA-LJC601M	M	6'0"	1-pcs	PE 1-3	90-150	25mm	375mm	8+TIP	C	125

KOMODO®

KOMODO LIGHT JIG RODS FEATURE:

- Slim high modulus carbon blank, with crossed carbon wrap reinforcement
- Okuma patent UFR TIP technology design on Light jig rods
- All 1-pcs design for perfect bending action
- Fuji K-concept tangle free guides with Alconite inserts
- Spiral guides design for all slow jig rods
- Fuji reel seat
- Ergonomic shaped, hard EVA handles
- High quality cloth bag package



KOMODO

Model	Rod Power	Length	Sections	Line Weight	Casting Wt. (g)	Foregrip length	Reargrip Length	Number of Guide	Weight (g)
Light Jig									
NEW KD-S-601UL	UL	6'0"	1-PCS	PE0.6-1	40-80	110mm	345mm	7+Tip	
NEW KD-S-601L	L	6'0"	1-PCS	PE0.8-1.5	50-100	110mm	345mm	7+Tip	
NEW KD-S-601ML	ML	6'0"	1-PCS	PE1-2	60-120	110mm	345mm	7+Tip	
NEW KD-S-601M	M	6'0"	1-PCS	PE1.5-3	70-150	110mm	345mm	7+Tip	
NEW KD-S-601MH	MH	6'0"	1-PCS	PE2-4	90-180	110mm	345mm	7+Tip	



EPIXOR

EPIXOR EGI RODS FEATURE:

- 40+46T Toray ultra-light carbon blank construction
- Fuji K-concept tangle free stainless steel guides
- Fuji Alconite inserts reduce friction
- Fuji VSS reel seat
- Ergonomic shaped, split EVA handle design to reduce weight
- Durable rubber cork end cap for good balance
- High quality cloth bag package



EPIXOR EGI

Model	Rod Power	Length	Sections	Line Weight	Casting Wt. (g)	Foregrip length	Reargrip Length	Number of Guide	Weight (g)
NEW EPI-S-762M	M	7'6"	2-PCS	PE0.6-1.2	Egi2.5-4	100mm	250mm	8+Tip	89
NEW EPI-S-832M	M	8'3"	2-PCS	PE0.6-1.2	Egi2.5-4	100mm	250mm	8+Tip	100



ARIA EGI

ARIA EGI RODS FEATURE:

- 40T Toray ultra-light carbon blank construction.
- Fuji KR stainless steel frame guides.
- Fuji Alconite inserts reduce friction.
- Fuji VSS reel seat, Fuji slidable hook keeper
- Ergonomic shaped, split EVA handle design for reduced weight and feel.
- Durable rubber cork end cap for good balance.
- High quality cloth bag package



ARIA EGI

Model	Rod Power	Length	Sections	Line Weight	Casting Wt. (g)	Foregrip length	Reargrip Length	Number of Guide	Weight (g)
ARA-842M	M	2.5m	2-PCS	PE0.6-1.2	Egi2.0-4.0	950mm	265mm	8+Tip	111



Egi Pro Superlative Carbon Competition

The Egi pro are designed to handle the light lures and delicate handling of squids and other light range species.

EGIPRO RODS FEATURE:

- Extremely light weight blank under 30T quality carbon construction
- Fuji micro guide set up and SIC top.
- Japanese split handle construction.
- Hard EVA + rubber cork handles
- Quality reel seat
- Supplied in quality rod bag.



EGIPRO

Model	Rod Power	Length	Sections	Casting Weight	Line Weight	Foregrip length	Reargrip Length	Number of Guide	Weight (g)
EGI-S-822M	M	2.45m	2 pcs	Egi 2.0-3.5	PE 0.8-1.5	115mm	245mm	7+TIP	120

FLX TIP

FLX TIP RODS FEATURE:

- Low resin and responsive 24T+30T carbon rod blanks
- Okuma patent UFR technology blank
- UFR: Ultimate Flex Reinforcement rod tip technology
- X-wrap carbon reinforcement on the Butt section
- CCS Seaguide, 316 stainless steel tangle free frame SIC guides
- TVS touch blank pipe reel seat
- Ergonomic shaped, split EVA handle design to reduce weight
- Supplied in quality rods bag



FLX TIP

	Model	Rod Power	Length	Sections	Line Weight	Lure Weight	Foregrip length	Reargrip Length	Number of Guide	Weight (g)
NEW	FLX-S-762M	M	7'6"	2-PCS	PE0.6-1.2	Egi2.5-4	40mm	260mm	8+Tip	109
NEW	FLX-S-832M	M	8'3"	2-PCS	PE0.6-1.5	Egi2.5-4	40mm	280mm	8+Tip	126

MAKAIRA SURF

MAKAIRA SURF RODS FEATURE:

- 40T Toray high modulus carbon material, slim, light and ultra-sensitive blanks construction
- Fuji KW anti tangle guides improves casting distance
- Fuji Alconite guides inserts reduce friction
- Fuji dual reel seat with spiral carbon tube body
- Durable and comfortable special handle design
- Anti-slip grip for easy put in/take off
- High quality handbag package



MAKAIRA SURF

	Model	Rod Power	Length	Sections	Casting Wt. (g)	Reargrip Length	Number of Guide	Weight (g)
	MK-S-1443H	H	4.30m	3-pcs	100-250	670mm	5+TIP	493
	MK-S-1503H	H	4.50m	3-pcs	100-250	670mm	5+TIP	505

AZORES SURF

AZORES SURF RODS FEATURE:

- 40T high modulus Toray carbon blank construction.
- OC-9 carbon outer wrap and solid carbon tip on tele surf rod.
- Fuji deep press resistant guide frames.
- Fuji Alconite insert for braided line friction.
- Fuji DPS pipe reel seat
- Anti slip handle design.
- High quality travel bag package



AZORES SURF

Model	Rod Powers	Length	Sections	Casting Wt. (g)	Reargrip Length	Number of Guide	Weight (g)
AZ-S-1443H	H	4.30m	3-pcs	100-250	670mm	5+Tip	460

MASTER Surf

MASTER SURF RODS FEATURE:

- 30T Japanese carbon material and faster action blank construction
- Seaguide deep-press guide frames with SIC inserts.
- ALPS Deluxe Reel seat.
- Shrink wrap Non slip handle.
- High quality handbag package.



MASTER SURF

Model	Rod Power	Length	Sections	Casting Wt. (g)	Foregrip length	Reargrip Length	Number of Guide	Weight (g)
MST-S-1503M	M	4.50m	3-pcs	120	N/A	690mm	7+TIP	462
MST-S-1503MH	MH	4.50m	3-pcs	160	N/A	690mm	7+TIP	546
MST-S-1503H	H	4.50m	3-pcs	200	N/A	690mm	7+TIP	617



AZORES II

AZORES II RODS FEATURE:

- AZORE SURF upgraded version, lighter and better balance
- 40T high modulus Toray carbon blank construction
- OC-9 carbon outer wrap and solid carbon tip
- Fuji or Local deep press resistant guide frames
- Fuji DPS pipe reel seat
- Anti slip handle design
- High quality rods bag



AZORES II

	Model	Rod Power	Length	Sections	Lure Wt. (g)	Reargrip Length	Number of Guide	Weight (g)
NEW	AZII-S-1403H	H	4.20m	3-pcs	100-200	670mm	5+Tip	368
NEW	AZII-S-1403XH	XH	4.20m	3-pcs	120-250	670mm	5+Tip	398
NEW	AZII-S-1503H	H	4.50m	3-pcs	100-200	670mm	5+Tip	393
NEW	AZII-S-1503XH	XH	4.50m	3-pcs	120-250	670mm	5+Tip	433



TRIO- REX ARENA

TRIO-REX ARENA RODS FEATURE:

- 30T Korean carbon blank with HYBRID TIP
- Saltwater resistant deep press guides
- Okuma Branded quality reel seat
- Anti-slip handle design
- Supplied in a quality rod bag



TRIO-REX ARENA BEACH

Model	Rod Power	Length	Sections	Casting Wt. (g)	Foregrip length	Reargrip Length	Number of Guide	Weight (g)
TXA-S-1403M	M	4.20m	3-pcs	60-100	N/A	685mm	7+TIP	415
TXA-S-1503M	M	4.50m	3-pcs	60-100	N/A	685mm	7+TIP	454





TRIO- REX SURF

The trio res surf rods are built on fast and strong Korean high quality carbon materials, using saltwater resistant components to ensure maximum performance.

TRIO-REX SURF RODS FEATURE:

- 30T Korean Carbon material construction
- Saltwater resistant High rise guides
- Okuma Branded quality reel seat
- Anti slip handle
- Easy grip connection construction
- Supplied in a quality rod bag

TRIO-REX SURF

	Model	Rod Power	Length	Sections	Lure Wt. (g)	Foregrip length	Reargrip Length	Number of Guide	Weight (g)
NEW	TX-S-1002H	H	3.00m	2-pcs	100-200g	N/A	550mm	5+Tip	281
NEW	TX-S-1103H	H	3.30m	3-pcs	100-200g	N/A	580mm	5+Tip	314
NEW	TX-S-1203H	H	3.60m	3-pcs	100-200g	N/A	600mm	5+Tip	360
NEW	TX-S-1303H	H	3.90m	3-pcs	100-200g	N/A	600mm	5+Tip	412
NEW	TX-S-1403H	H				N/A			
	TX-S-1403XH	XH	4,2m	3-pcs	120-250g	N/A	660mm	5+Tip	555
NEW	TX-S-1503H	H				N/A			
	TX-S-1503XH	XH	4.5m	3-pcs	120-250g	N/A	660mm	6+Tip	581

DISTANCE SURF ARENA

DISTANCE SURF ARENA RODS FEATURE:

- Light weight and responsive HM carbon construction
- UFR: Ultimate Flex Reinforcement rod tip technology
- Visual Orange tip section
- Lowrider SIC guides
- Anti-slip grip for easy put in/take off
- Okuma graphite cushion reel seat
- ALPS rubber end cap for anti-slip
- Delivered in cloth bag

DISTANCE SURF ARENA

	Model	Rod Power	Length	Sections	Lure Wt. (g)	Foregrip length	Reargrip Length	Number of Guide	Weight (g)
	DSA-S-1403H	H	4,2m	3-pcs	100-200	N/A	660mm	5+Tip	461
	DSA-S-1403XH	XH	4,2m	3-pcs	120-250	N/A	660mm	6+Tip	478
	DSA-S-1503H	H	4.5m	3-pcs	100-200	N/A	660mm	5+Tip	481
	DSA-S-1503XH	XH	4.5m	3-pcs	120-250	N/A	660mm	6+Tip	538



SURFLINER SURF

SURFLINER SURF RODS FEATURE:

- Light weight and responsive HM carbon construction
- Quality stainless steel guides
- Anti-slip grip for easy put in / take off
- Okuma graphite cushion reel seat
- ALPS rubber end cap for anti-slip
- Delivered in cloth bag

SURFLINER SURF

	Model	Rod Power	Length	Sections	Lure Wt. (g)	Foregrip length	Reargrip Length	Number of Guide	Weight (g)
NEW	SFL-S-1002H	H	3.00m	2-pcs	100-200	N/A	550mm	5+Tip	290
NEW	SFL-S-1103H	H	3.30m	3-pcs	100-200	N/A	580mm	5+Tip	331
NEW	SFL-S-1203H	H	3.60m	3-pcs	100-200	N/A	600mm	5+Tip	378
NEW	SFL-S-1303H	H	3.90m	3-pcs	100-200	N/A	600mm	5+Tip	413
	SFL-S-1403H	H	4,2m	3-pcs	100-200	N/A	660mm	5+Tip	470
	SFL-S-1403XH	XH	4,2m	3-pcs	120-250	N/A	660mm	6+Tip	506
	SFL-S-1503H	H	4.5m	3-pcs	100-200	N/A	660mm	5+Tip	507
	SFL-S-1503XH	XH	4.5m	3-pcs	120-250	N/A	660mm	6+Tip	560



NEMESIS SURF

NEMESIS SURF RODS FEATURE:

- Ultra-responsive 24-carbon blank construction
- Quality stainless steel frame guides with saltwater treatment
- Strong graphite reel seats
- Anti-slip grip for easy put in/take off
- Alu screw end cap with Rubber cushion for anti-slip



NEMESIS SURF

Model	Rod Power	Length	Sections	Casting Wt. (g)	Foregrip length	Reargrip Length	Number of Guide	Weight (g)
NE-S-1403MH	MH	14'0"	3-pcs	150-300	N/A	670mm	5+TIP	528
NE-S-1503MH	MH	15'0"	3-pcs	150-300	N/A	710mm	6+TIP	596
NE-S-1603MH	MH	16'0"	3-pcs	150-300	N/A	710mm	6+TIP	683

Wave Power

WAVE POWER RODS FEATURE:

- 24T GT blank construction
- Saltwater resistant deep press guides
- Okuma DPS plate reel seat
- Anti slip handle design



WAVE POWER

	Model	Rod Power	Length	Sections	Lure Wt. (g)	Foregrip length	Reargrip Length	Number of Guide	Weight (g)
NEW	WP-S-1403H	H	4,2m	3-pcs	100-200	N/A	670mm	5+Tip	585
NEW	WP-S-1403XH	XH	4,2m	3-pcs	120-250	N/A	670mm	5+Tip	601
NEW	WP-S-1503H	H	4,5m	3-pcs	100-200	N/A	670mm	5+Tip	617
NEW	WP-S-1503XH	XH	4,5m	3-pcs	120-250	N/A	670mm	5+Tip	634



HELIOS TELE SURF

HELIOS TELE SURF RODS FEATURE:

- Fuji K-concept and Titanium guide frames
- Fuji SIC insert for braided line
- Protected in a quality guide cover
- Fuji Split reel seat with 1K woven tube
- Anti split handle design
- Screw end cap
- High quality travel bag
- Build on Toray 46T carbon material, slim, light and ultra-sensitive blanks construction



HELIOS TELE SURF

Model	Rod Power	Length	Casting Wt. (g)	Sections	Foregrip length	Reargrip Length	Number of Guide	Weight (g)
HE-S-1486MH-T	MH	4.40m	100-200	6-Tele	N/A	670mm	4+TIP	388



MAKAIRA TELE SURF

MAKAIRA TELE SURF RODS FEATURE:

- 46T Toray high modulus carbon material, slim, light and ultra-sensitive blanks construction
- Dual helix carbon tape wrap configuration improved strength and durability
- Fuji KW anti tangle guides improves casting distance
- Fuji Alconite guides inserts reduce friction
- Fuji dual reel seat with spiral carbon tube body
- Durable and comfortable special handle design
- Anti-slip grip for easy put in/take off
- High quality handbag package



MAKAIRA TELE SURF

Model	Rod Power	Length	Sections	Casting Wt.(g)	Reargrip Length	Number of Guide	Weight (g)
MK-S-1486H-T	H	4.40m	6-Tele	100-200	670mm	4+TIP	498



AZORES TELE SURF

AZORES RODS FEATURE:

- 40T high modulus Toray carbon blank construction.
- OC-9 carbon outer wrap and solid carbon tip on tele surf rod.
- Fuji deep press resistant guide frames.
- Fuji Alconite insert for braided line friction.
- Fuji DPS pipe reel seat
- Anti slip handle design.
- High quality travel bag package



AZORES TELE SURF

Model	Rod Powers	Length	Sections	Casting Wt. (g)	Reargrip Length	Number of Guide	Weight (g)
AZ-S-1446H-T	H	4.30m	6-Tele	100-250	670mm	4+Tip	473

ELETTA Surf Performance

ELETTA RODS FEATURE:

- 24T and 30T carbon blank construction with solid carbon tip
- Fuji resistant guides
- Protected in a quality guide cover
- Fuji DPS pipe reel seat
- Durable shrink tube handle
- Screw end cap
- High quality travel bag



ELETTA SURF

Model	Rod Power	Length	Sections	Casting Wt. (g)	Foregrip length	Reargrip Length	Number of Guide	Weight (g)
ELT-S-1446ML-T	ML	4.30m	6-Tele	80	N/A	660mm	4+TIP	394
ELT-S-1446M-T	M	4.30m	6-Tele	100	N/A	660mm	4+TIP	402
ELT-S-1446MH-T	MH	4.30m	6-Tele	120	N/A	660mm	4+TIP	410
ELT-S-1446H-T	H	4.30m	6-Tele	150	N/A	660mm	4+TIP	448
ELT-S-1446XH-T	XH	4.30m	6-Tele	170	N/A	660mm	4+TIP	483
ELT-S-1446XXH-T	XXH	4.30m	6-Tele	200	N/A	660mm	4+TIP	498



TRIO- REX TELE SURF

TRIO-REX RODS FEATURE:

Powerful 30T carbon blank, Fuji MN frame with O-ring guide, Fuji DPS reel seat, durable and comfortable special handle design, high quality velvet cloth bag



TRIO-REX TELE

Model	Rod Power	Length	Sections	Casting Wt. (g)	Foregrip length	Reargrip Length	Number of Guide	Weight (g)
TRX-S-1426H-T	H	4.25m	6-Tele	100-250	N/A	675mm	4+TIP	532



Ceymar TELE SURF

CEYMAR TELE SURF RODS FEATURE:

- Extremely light weight and responsive 30-ton carbon blanks
- Solid carbon tip for the tele rods
- Quality deep press stainless steel frame guides
- Fuji DPS reel seat
- Non-slip handle design
- Aluminum screw end cap
- High quality cloth bag package



CEYMAR TELE SURF

Model	Rod Power	Length	Sections	Casting Wt. (g)	Foregrip Length	Reargrip Length	Number of Guide	Weight (g)
C-S-1446H-T	H	4.30m	6-Tele	100-250	N/A	670mm	4+TIP	446



AVENGER TELE SURF

Powerful 24T carbon blank, Strong guide frame with super hard titanium oxide insert, FUJI reel seat, comfortable handle design, with high quality velvet cloth bag package



AVENGER TELE SURF

Model	Rod Power	Length	Sections	Casting Wt. (g)	Foregrip length	Reargrip Length	Number of Guide	Weight (g)
AV-S-1306H-T	H	3.90m	6-Tele	100-200	N/A	680mm	4+Tip	424
AV-S-1406H-T	H	4.20m	6-Tele	100-250	N/A	680mm	4+Tip	498

FINA PRO TELE SURF

FINA PRO RODS FEATURE:

- 24T carbon ultra-responsive blank construction
- Stainless steel deep-drawn frame protect the inserts
- Polished Titanium Oxide insert for friction
- Okuma graphite reel seat
- Aluminum screw end cap with non-skid rubber
- Supplied in rod bag



FINA PRO TELE SURF

Model	Rod Power	Length	Sections	Casting Wt. (g)	Foregrip length	Reargrip Length	Number of Guide	Weight (g)
FP-S-1304H-T	H	3.90m	4-Tele	100-200	N/A	660mm	3+TIP	434
FP-S-1404H-T	H	4.20m	4-Tele	100-250	N/A	660mm	3+TIP	494



REVENGER TELE SURF

REVENGER RODS FEATURE:

- High modulus carbon blank construction
- Deep press guide frames with Titanium Oxide inserts
- Protected in a quality guide cover
- Okuma branded quality reel seat
- Aluminum Screw end cap
- Supplied in quality handbag package



REVENGER TELE SURF

Model	Rod Power	Length	Sections	Casting Wt. (g)	Foregrip length	Reargrip Length	Number of Guide	Weight (g)
RV-S-1304H-T	H	3.90m	4-Tele	100-200	N/A	660mm	3+TIP	456
RV-S-1404XH-T	XH	4.20m	4-Tele	150-250	N/A	660mm	3+TIP	471
RV-S-1505XH-T	XH	4.50m	5-Tele	150-250	N/A	660mm	4+TIP	499



ALARIS TELE SURF

ALARIS TELE SURF RODS FEATURE:

- Carbon construction
- Telescopic 5 sections for fast action
- Visual white tip section
- Double legged SIC guides with rubber shock absorbers
- Okuma graphite and Alu reel seat with cushions
- Aluminum screw butt cap
- Delivered in cloth bag



ALARIS TELE SURF

Model	Rod Power	Length	Sections	Lure Wt. (g)	Reargrip Length	Number of Guide	Weight (g)
ALS-S-1305H-T	H	3.9m	5-Tele	100-200	640mm	4+Tip	422
ALS-S-1405H-T	H	4.2m	5-Tele	100-200	640mm	4+Tip	499



ROD AND REEL COMBOS

A key component of our mission at Okuma Fishing Tackle is to maintain fishing as accessible to all interested people. Part of that effort includes our involvement in numerous conservation and fishing organizations. On the product side, it's our rod and reel combos that receive the focus. Our selection is backed by our commitment to make that first step into fishing an incredibly positive experience. We fill these products with color and excitement in addition to value and performance, because catching the eye is the first step in creating an angler.

Fuel Spin

FUEL SPIN COMBOS FEATURE:

- 24T GT blank construction
- Fast action
- 3 Split EVA handle to reduce the weight and good balance
- Stainless steel frame SIC guides
- Graphite cushions reel seat
- Multi-disc, Japanese oiled felt drag washers
- 1 ball bearing drive for smoothness and durability
- Precision machine cut brass pinion gear
- Corrosion resistant graphite body and rotor
- CFR: Cyclonic Flow Rotor technology
- Machined aluminum, anodized spool
- Corrosion-resistant stainless steel bail wire
- RESII: Computer balanced Rotor Equalizing System



FUEL SPIN RODS

	Model	Rod Power	Line	Casting Wt. (g)	Sections	Reel Model	Bearings	Line Capacity(diameter in mm.)	Number of Guide
NEW	FSP-702L-3000	L	2.13m	5-20	2-pcs	FSP-3000	1BB	0.20/300, 0.25/200, 0.30/130	5+Tip
NEW	FSP-902L-C4000	L	2.74m	7-30	2-pcs	FSP-C4000	1BB	0.20/300, 0.25/200, 0.30/130	7+Tip

STEELER *XP*

STEELER XP COMBOS FEATURE:

- Durable glass fiber rod blank construction
- Feature comfortable EVA fore and rear split grip
- Multi-disc front drag washer system
- All models feature a 1 ball bearing drive system
- Reels are pre-spooled with monofilament line
- All Steeler rods are 2-pcs for easy transportation



STEELER XP COMBOS

	Model	Rod Power	Rod Length	Line Weight	Lure Weight	Sections	Reel Model	Bearings	Reel Color	With Line	Line Capacity
	SLXP-562-20BO	M	5' 6"	N/A	1/8-3/8oz	2-pcs	SLXP-20	1BB	Orange	Yes	265/3, 220/4, 180/6
	SLXP-562-20GR	M	5' 6"	N/A	1/8-3/8oz	2-pcs	SLXP-20	1BB	Green	Yes	265/3, 220/4, 180/6
	SLXP-562-20PK	M	5' 6"	N/A	1/8-3/8oz	2-pcs	SLXP-20	1BB	Pink	Yes	265/3, 220/4, 180/6
	SLXP-602-20BO	M	6' 0"	N/A	1/8-3/8oz	2-pcs	SLXP-20	1BB	Orange	Yes	265/3, 220/4, 180/6
	SLXP-602-20GR	M	6' 0"	N/A	1/8-3/8oz	2-pcs	SLXP-20	1BB	Green	Yes	265/3, 220/4, 180/6
	SLXP-602-20PK	M	6' 0"	N/A	1/8-3/8oz	2-pcs	SLXP-20	1BB	Pink	Yes	265/3, 220/4, 180/6
	SLXP-662-20BO	M	6' 6"	N/A	1/8-1/2oz	2-pcs	SLXP-20	1BB	Orange	Yes	265/3, 220/4, 180/6
	SLXP-662-20GR	M	6' 6"	N/A	1/8-1/2oz	2-pcs	SLXP-20	1BB	Green	Yes	265/3, 220/4, 180/6
	SLXP-662-20PK	M	6' 6"	N/A	1/8-1/2oz	2-pcs	SLXP-20	1BB	Pink	Yes	265/3, 220/4, 180/6



CASCADE II

CASCADE II COMBOS FEATURE:

- Durable glass fiber rod blank construction
- Features comfortable EVA fore grips
- Rear grip is split configuration EVA and cork
- Multi-disc front drag washer system
- All models feature a 1 ball bearing drive system
- Reels are pre-spooled with monofilament line
- All Cascade rods are 2-pcs for easy transportation

CASCADE II SPINNING COMBOS

Model	Rod Power	Rod Length	Line Weight	Lure Weight	Sections	Reel Model	Bearings	Reel Color	With Line	Line Capacity
CSII-502L-20	L	5' 0"	N/A	N/A	2-pcs	CSII-20	1BB	N/A	Yes	265/3, 220/4, 180/6
CSII-562ML-20	ML	5' 6"	N/A	N/A	2-pcs	CSII-20	1BB	N/A	Yes	265/3, 220/4, 180/6
CSII-602ML-20	ML	6' 0"	N/A	N/A	2-pcs	CSII-20	1BB	N/A	Yes	265/3, 220/4, 180/6

FIN-CHASER X

FIN CHASER "X" SERIES COMBOS FEATURE:

- Durable glass fiber rod blank construction
- All models feature a comfortable EVA fore grip
- Rear grip on 6'-7' combos feature split cork
- Rear grips on 8' and larger combos is full EVA
- Multi-disc oil felt drag washers
- All models feature a 1 ball bearing drive system
- Machined aluminum, anodized spool
- Fin Chaser 8' and larger feature double foot guide construction
- All Fin Chaser rods feature 2-pcs blanks for transportation



FIN CHASER " X " SERIES COMBOS

Model	Rod Power	Rod Length	Line Weight	Lure Weight	Sections	Reel Model	Bearings	Reel Color	With Line	Line Capacity
FNX-602-30PK	ML	6' 0"	N/A	1/8-3/8oz	2-pcs	FNX-30	1BB	Pink	Yes	310/3, 250/4, 165/6
FNX-662-30BL	M	6' 6"	N/A	1/8-1/2oz	2-pcs	FNX-30	1BB	Blue	Yes	310/3, 250/4, 165/6
FNX-662-30YL	M	6' 6"	N/A	1/8-1/2oz	2-pcs	FNX-30	1BB	Yellow	Yes	310/3, 250/4, 165/6
FNX-662-30PK	M	6' 6"	N/A	1/8-1/2oz	2-pcs	FNX-30	1BB	Pink	Yes	310/3, 250/4, 165/6
FNX-70-40BL	MH	7' 0"	N/A	1/4-3/4oz	2-pcs	FNX-40	1BB	Blue	Yes	190/10, 140/12, 110/15
FNX-70-40YL	MH	7' 0"	N/A	1/4-3/4oz	2-pcs	FNX-40	1BB	Yellow	Yes	190/10, 140/12, 110/15
FNX-80-40BL	MH	8' 0"	N/A	1/2-1 1/2oz	2-pcs	FNX-40	1BB	Blue	Yes	190/10, 140/12, 110/15
FNX-80-40YL	MH	8' 0"	N/A	1/2-1 1/2oz	2-pcs	FNX-40	1BB	Yellow	Yes	190/10, 140/12, 110/15
FNX-90-60BL	MH	9' 0"	N/A	3/4-2 1/2oz	2-pcs	FNX-60	1BB	Blue	Yes	155/18, 125/20, 90/30
FNX-90-60YL	MH	9' 0"	N/A	3/4-2 1/2oz	2-pcs	FNX-60	1BB	Yellow	Yes	155/18, 125/20, 90/30
FNX-100-65BL	MH	10' 0"	N/A	1-3oz	2-pcs	FNX-65	1BB	Blue	Yes	300/15, 190/20, 130/35
FNX-100-65YL	MH	10' 0"	N/A	1-3oz	2-pcs	FNX-65	1BB	Yellow	Yes	300/15, 190/20, 130/35



FLY/FLOAT/

United by single action, 1:1 retrieve ratios, our Fly, Float and Moolching products highlight two very distinct strengths of Okuma Fishing Tackle. The first is the ability of our advanced CNC machining facility in Taiwan. From the same precision factory that makes Makaira offshore reels, comes our machined float and moolching reels. The second is our commitment to value in our die-cast aluminum product lines. The Sierra fly reel changed the industry that used words like "traditional" to sell consumers grossly overpriced reels. Sierra redefined value in the fly fishing market, and SLV and Integrity products built upon that foundation. In both areas of strength, you can find bigger names, but not better product.

RAW-II 1002

RAW-1002 FLOAT REELS FEATURE:

- Precision 6061-T6 machined aluminum frame and spool
- Durable Type-II, two-tone anodized frame and spool
- 2 premium stainless steel Japanese ball bearings
- Machine cut stainless steel spool shaft
- 1-pcs Machined Rigid Frame construction
- On/Off click ratchet for added spool tension
- Ported spool with exposed rim for easy spool control
- Includes Okuma's protective neoprene reel shield
- RAWII is backed by a one year limited warranty



RAW-1002

RAW II

Model	Bearings	Weight (g)	Line Retrieve	Line capacity (yds/lbs)	Frame	Spool	Spool Width	Spool Diam.
Centerpin Float Reel								
RAW-1002	2 BB	233	13"	275/-yds / 8-lbs	AL	AL	18.5mm	114mm

AVENTA

AVENTA FLOAT REELS FEATURE:

- Precision machined stainless steel spool shafts
- 1-piece Machined Rigid Frame construction
- Machined aluminum anodized spools
- On/Off click ratchet for added spool tension
- Ported spool with exposed rim for easy control
- 2 stainless steel Japanese ball bearings



VT-1002

Float fishing is a unique and specific technique. The center-pin crowd is dedicated, knowledgeable and passionate about their sport. They are also extremely discerning about their tackle. The introduction of the Aventa center-pin sets a new standard for what can be expected in a fully-machined float reel.

The Aventa series is made from solid aluminum bar stock, for precision spool alignment and maximum freespool. The VT-1002, with two stainless steel ball bearings, is excellent for casting directly from the reel or for drag-free drifts.

AVENTA

Model	Bearings	Weight (g)	Line Retrieve	Line capacity (yds/lbs)	Frame	Spool	Spool Width	Spool Diam.
Centerpin Float Reel								
VT-1002	2 BB	233	13"	275/-yds / 8-lbs	AL	AL	18.5mm	114mm

SLV

SLV FLY REELS FEATURE:

- Lightweight graphite construction
- 4-piece rod design
- Titanium Oxide stripper guide
- Stainless steel snake guides
- Aluminum pipe reel seat with aluminum hoods
- Through-blank carbon fiber construction
- Okuma rod bag



SLV 56

SLV

Model	Line Weight	Bearings	Weight (g)	Line Retrieve	Fly line capacity	Frame	Spool	Spool Width	Spool Diam.
SLV 23	2,3 wt.	1RB	128	8"	WF-2, 50yds/12lbs	AL	AL	22mm	66mm
SLV 45	4,5 wt.	1RB	136	9"	WF-4, 95yds/12lbs	AL	AL	24mm	75mm
SLV 56	5,6 wt.	1RB	150	10"	WF-5, 140yds/20lbs	AL	AL	28mm	82mm
SLV 78	7,8 wt.	1RB	156	11"	WF-7, 145yds/20lbs	AL	AL	31mm	88mm
SLV 89	8,9 wt.	1RB	173	12"	WF-8, 150yds/30lbs	AL	AL	34mm	95mm
SLV-1011	10,11 wt.	1RB	275	13"	WF-10, 520yds/30lbs	AL	AL	40mm	114mm
Spare spools									
SLV 23 Spool	2,3 wt.	1RB	57	8"	WF-2, 50yds/12lbs	N/A	AL	22mm	66mm
SLV 45 Spool	4,5 wt.	1RB	60	9"	WF-4, 95yds/12lbs	N/A	AL	24mm	75mm
SLV 56 Spool	5,6 wt.	1RB	65	10"	WF-5, 140yds/20lbs	N/A	AL	28mm	82mm
SLV 78 Spool	7,8 wt.	1RB	71	11"	WF-7, 145yds/20lbs	N/A	AL	31mm	88mm
SLV 89 Spool	8,9 wt.	1RB	82	12"	WF-8, 150yds/30lbs	N/A	AL	34mm	95mm
SLV-1011 Spool	10,11 wt.	1RB	139	13"	WF-10, 520yds/30lbs	N/A	AL	40mm	114mm

SIERRA



SIERRA FLY COMBOS FEATURE:

- Light weight graphite construction
- Medium fast action
- Custom made aluminum pipe reel seat
- High quality Portuguese cork handles
- Stainless steel snake guides
- Saltwater resistant stripping guides
- Luxury velvet rod bag with a PVC tube

SIERRA FLY RODS

Model	Bearings	Line Weight	Sections	Reel Seat Description	Rod Blank	Number of Guides	Weight (g)
SRF-904-5	9'0"	5 Wt.	4-pcs	Special Alu Fly reel seat	24T Carbon	8+Tip	116
SRF-904-6	9'0"	6 Wt.	4-pcs	Special Alu Fly reel seat	24T Carbon	8+Tip	118



ACCESSORIES

The ultimate companion pieces to Okuma fishing rods and reels, Nomad and Okuma accessories add quality to the details of the experience. Universally, our fabrics and construction elements are top-of-the-line. The specific features are the culmination of experience and the understanding that you cannot catch fish if your gear is not in the water. Organization and accessibility are paramount. All of our accessories are built to fish hard, offering the most hard-core enthusiast a product delivers extensive pride of ownership and long-lasting durability.

BRAIDED LINE



NEW

Braided Line

Japan Size	Dia/mm	LB	Test Tensile (LB)	Test Strength (kg)
0.8	0.15	9	6	4.9
1.0	0.17	12	8	6.5
1.5	0.21	15	8	8.0
2.0	0.24	20	8	10
2.5	0.26	25	8	12.5
3.0	0.29	30	8	15.0

■ 3 Color: 20CM Blue+20CM Orange +60CM Green



NEW

X-PE Braided Line

Japan Size	Diameter	Test Tensile (LB)	Test Tensile (kg)
0.4	0.1	17.31	7.87
0.5	0.12	24.71	11.23
0.8	0.15	34.54	15.7
1.2	0.18	38.94	17.7
1.5	0.20	44.57	20.26
2.5	0.25	58.54	26.61
3.5	0.30	62.90	28.59
4	0.33	80.43	36.56
5	0.38	89.04	45.02
7	0.43	122.91	55.87
8	0.47	135.94	61.79
10	0.50	148.35	67.43



NEW

LEADCORE Braided Line

Meter	Test Tensile (LB)	Test Tensile (kg)
10M	55	25
10M	77	35
10M	99	45



SAFINA Braided Line

Japan Size	Diameter	Test Tensile (LB)	Test Tensile (kg)
1	0.17	18	8.2
1.2	0.19	20	9.0
1.5	0.21	22	10.0
2	0.24	26	11.8
2.5	0.27	31	14.0
3.0	0.29	35	15.9
4.0	0.34	44	20.0
5.0	0.37	43	19.5
6.0	0.41	62	28.1

- Will not weaken from long sunlight exposure
- Exceptional strength to diameter ratio
- Phenomenal sensitivity from near zero stretch
- Maximum strength
- Ultimate lure control

NEW

FT-BRAID-X4- Braided Line



Japan Size	Dia/mm	LB	Test Tensile (LB)	Test Strength (kg)
0.5	0.115	4	9	4.0
0.6	0.13	4	10	4.5
0.8	0.15	4	12	5.1
1	0.165	4	13	5.9
1.5	0.205	4	18	8.2
2	0.235	4	20	9.1
2.5	0.26	4	25	11.4
3	0.285	4	27	12.3
4	0.33	4	30	13.6
5	0.37	4	40	17.5
6	0.41	4	50	23.4
7	0.44	4	55	25.8
8	0.47	4	65	31.2
10	0.52	4	75	35.6
12	0.57	4	85	40.2

■ Gray Color, Yellow Color, Green Color, Multi Color

■ Meters that can be produced:

100M & 100M*10PCS & 150M&300M&500M&600M&1000M



NEW

FT-BRAID-X8- Braided Line

Japan Size	Dia/mm	LB	Test Tensile (LB)	Test Strength (kg)
0.5	0.115	4	9	4.0
0.6	0.13	4	10	4.5
0.8	0.15	4	12	5.1
1	0.165	4	13	5.9
1.5	0.205	4	18	8.2
2	0.235	4	20	9.1
2.5	0.26	4	25	11.4
3	0.285	4	27	12.3
4	0.33	4	30	13.6
5	0.37	4	40	17.5
6	0.41	4	50	23.4
7	0.44	4	55	25.8
8	0.47	4	65	31.2
10	0.52	4	75	35.6
12	0.57	4	85	40.2

■ Gray Color, Yellow Color, Green Color, Multi Color

■ Meters that can be produced:

100M & 100M*10PCS & 150M&300M&500M&600M&1000M

NYLON LINE

NEW

Nylon Line



Japan Size	Dia/mm	Length	LB	Test Tensile (LB)	Test Strength (kg)
1.7	0.22	150M	8	8.1	3.7
2.0	0.235		9	9.0	4.1
2.5	0.26		11	11.4	5.2
3.0	0.285		13	13.4	6.1
3.5	0.31		16	15.6	7.1
4.0	0.34		17	17.4	7.9
5.0	0.37		21	21.3	9.7
6.0	0.41		25	25.3	11.5
7.0	0.44		29	29.3	13.3
8.0	0.47		33	32.8	14.9

■ 4 Color: 30CM Purple+30CM Blue +30CM Transparent +30CM Black



NEW

Nylon Line

Japan Size	Dia/mm	LB	Test Tensile (LB)	Test Strength (kg)
1.5	0.2	7	6.8	3.1
1.7	0.21	8	7.7	3.5
2.0	0.235	9	8.8	4.0
2.5	0.26	11	10.8	4.9
3.0	0.285	13	12.5	5.7
3.5	0.31	15	14.5	6.6
4.0	0.34	17	16.5	7.5
5.0	0.37	20	20.0	9.1
6.0	0.41	24	23.8	10.8
8.0	0.47	31	31.0	14.1

■ 2 Color: 30cm Black + 150cm Orange

■ 2 Color: 30cm Black + 150cm White

■ 2 Color: 30cm Black + 150cm Pink

NEW

Magist Shrimp (Fire Line)



Japan Size	Dia/mm	LB	Test Tensile (LB)	Test Strength (kg)
0.2	0.074	5	5.1	2.3
0.3	0.091	7	6.8	3.1
0.4	0.105	8	7.7	3.5
0.5	0.116	8	8.4	3.8
0.6	0.128	9	9.0	4.1
0.8	0.148	10	10.1	4.6
1	0.165	13	12.8	5.8
1.2	0.185	15	15.2	6.9
1.5	0.205	18	17.8	8.1
2	0.235	20	20.2	9.2
2.5	0.26	23	22.9	10.4



Ceymar X4 Braided Line

Japan Size	Dia/mm	Filaments	LB	Test Tensile (LB)	Test Strength (kg)
1	0.165	4	13	13	5.9
1.5	0.205	4	18	18	8.2
2	0.235	4	20	20	9.1
2.5	0.26	4	25	25	11.4
3	0.285	4	27	27	12.3
4	0.33	4	30	30	13.6
5	0.37	4	40	40	18.2
6	0.41	4	55	55	25.0
7	0.44	4	65	65	29.5
8	0.47	4	80	80	36.4
10	0.52	4	85	85	39.6
12	0.57	4	100	100	45.5

■ Multi Color/Gray Color/Yellow Color/Light Green Color/Black Color



NEW

Carp Nylon Line

Japan Size	Dia/mm	Test Tensile (LB)	Test Strength (kg)	Length
3	0.285	5.5	12	300M
3.5	0.31	6.4	14	
4	0.34	7.7	17	
5.0	0.37	10.0	22	
6.0	0.405	11.4	25	
7.0	0.43	12.7	28	
8	0.47	13.6	30	

■ 2color : Green+Black



NEW

Sea Bass Nylon Line

Japan Size	Dia/mm	Test Tensile (LB)	Test Strength (kg)	Length
2	0.24	9.97	4.53	300M
2.5	0.26	12.52	5.69	
3	0.29	14.37	6.53	
3.5	0.31	16.98	7.72	
4	0.34	19.12	8.69	
5	0.37	21.76	9.89	
6	0.41	24.11	10.96	

■ Color : Moss green

Ceymar X8 Braided Line



Japan Size	Dia/mm	Filaments	Test Tensile (LB)	Test Strength (kg)
1	0.165	8	18	8.2
1.5	0.205	8	20	9.1
2	0.235	8	25	11.4
2.5	0.26	8	30	13.6
3	0.285	8	35	15.9
4	0.33	8	45	20.5
5	0.37	8	60	27.3
6	0.41	8	70	31.8
7	0.44	8	80	36.4
8	0.47	8	90	40.9
10	0.52	8	110	50.0
12	0.57	8	130	59.1

■ Multi Color/Red/Black/Green



船 X HG fluorocarbon Line

Item	Dia/mm	Test Tensile (kg)	Item	Dia/mm	Test Tensile (kg)
HG 100M #1.5	0.203	2.97	HG 100M #10	0.518	16.21
HG 100M #1.75	0.218	3.30	HG 100M #12	0.567	19.42
HG 100M #2	0.232	3.67	HG 100M #14	0.612	21.67
HG 100M #2.5	0.256	4.55	HG 100M #16	0.653	25.76
HG 100M #3	0.285	5.74	HG 100M #18	0.694	27.86
HG 100M #3.5	0.305	6.22	HG 100M #20	0.736	29.94
HG 100M #4	0.333	7.56	HG 50M #22	0.772	32.18
HG 100M #5	0.367	8.31	HG 50M #24	0.804	35.73
HG 100M #6	0.400	9.87	HG 50M #26	0.835	37.64
HG 100M #7	0.432	11.28	HG 50M #28	0.868	38.74
HG 100M #8	0.471	13.40	HG 50M #30	0.911	44.81



NEW

Spinning Nylon Line

Japan Size	Dia/mm	Test Tensile (LB)	Test Strength (kg)	Length
2	0.24	9.97	4.53	300M
2.5	0.26	12.52	5.69	
3	0.29	14.37	6.53	
3.5	0.31	16.98	7.72	
4	0.34	19.12	8.69	
5	0.37	21.76	9.89	
6	0.41	24.11	10.96	

■ Color : Clear



Feeder NYLON LINE

Japan Size	Diameter	Test Tensile (LB)	Test Tensile (kg)
1.0	0.17	4.8	2.16
1.2	0.19	5.7	2.59
1.5	0.21	7.0	3.20
2.0	0.24	9.0	4.09
2.5	0.26	11.2	5.12
3.0	0.29	13.2	6.01
3.5	0.31	15.4	7.01
4.0	0.34	17.2	7.83
5.0	0.37	21.3	9.68
6.0	0.41	25.3	11.48
7.0	0.44	29.2	13.29
8.0	0.47	33.0	14.99
10	0.52	40.7	18.47



MAX POWER Nylon Line

Japan Size	Diameter	Test Tensile (LB)	Test Tensile (kg)
0.8	0.15	3.96	2.40
1.0	0.18	5.12	3.10
1.5	0.21	6.11	3.70
2.0	0.24	7.43	4.50
2.5	0.26	9.24	5.60
3.0	0.28	11.55	7.00
3.5	0.31	16.01	9.70
4.0	0.34	17.82	10.80
5.0	0.37	21.45	13.00
6.0	0.40	25.58	15.50
7.0	0.44	30.03	18.20
8.0	0.46	33.00	20.00
10	0.50	37.65	23.00



challenger Nylon Line

Japan Size	Diameter	Test Tensile (LB)	Test Tensile (kg)
1.2	0.185	3.30	4.40
1.5	0.205	4.09	5.46
2.0	0.235	6.38	8.51
2.5	0.260	7.48	10.67
3.0	0.285	8.58	12.25
3.5	0.31	10.38	14.83
4.0	0.34	11.68	16.68
5.0	0.37	13.77	19.67
6.0	0.405	16.94	24.20
7.0	0.43	18.55	26.49
8.0	0.47	21.10	30.14

■ Color : White / Neon Yellow / Neon Yellow+Orange

ULTRA CARP NYLON LINE

Japan Size	Diameter	Test Tensile (LB)	Test Tensile (kg)
3.0	0.28	13.31	6.05
3.5	0.3	15.71	7.14
4.0	0.34	17.71	8.05
5.0	0.37	20.09	9.13
6.0	0.41	23.98	10.9
7.0	0.44	28.16	12.8
8.0	0.47	33.22	15.1
10	0.52	38.50	17.5
12	0.57	47.30	21.5



PLATINUM NYLON LINE

Diameter	Test Tensile (LB)	Test Strength (kg)
0.2	9	4
0.25	11	5.6
0.3	15	7.6
0.35	20	9.8
0.4	26.5	12.5
0.45	35	16.2
0.5	41.8	19.6
0.6	46	21
0.7	57	26.5
0.8	68	31.4
1	99	45



Okuma Backpack (Including 4 tackle boxes)
Model: PA247A



Azul Nylon Line

No	Dia./mm	Test Tensile (LB)	Test Tensile (kg)
2	0.235	7.0	3.2
2.5	0.26	9.5	4.3
3	0.285	11.2	5.1
3.5	0.31	12.5	5.7
4	0.34	14.3	6.5
5	0.37	17.8	8.1
6	0.405	20.7	9.4
7	0.44	24.2	11
8	0.47	27.1	12.3
10	0.52	33.2	15.1



GRAND GEAR NYLON LINE

Japan Size	Diameter	Test Tensile (LB)	Test Tensile (kg)
0.6	0.13	1.58	2.27
0.8	0.15	2.29	3.28
1.0	0.17	2.99	4.29
1.2	0.19	3.81	5.43
1.5	0.21	4.47	6.38
2.0	0.24	6.97	9.97
2.5	0.26	8.76	12.52
3.0	0.29	10.05	14.15
3.5	0.31	11.04	16.98
4.0	0.34	12.43	19.12
5.0	0.37	14.15	21.96
6.0	0.41	15.66	24.11
7.0	0.44	18.11	27.85
8.0	0.47	21.23	21.67
10	0.52	27.90	42.90

■ Color : Clear Green+Black / Golden



Okuma Motif Cotton Cap
Model: PA01C017B



Okuma Motif Mesh Cap
Model: PA01C018B



Okuma Pink Cotton Cap
Model: PA01C011P



Okuma Full Back Camouflage Hat
Model: PA01C006G

FLUOROCARBON LINE



SHOTAI FLUOROCARBON LINE

Japan Size	Diameter	Test Tensile (LB)	Test Tensile (kg)
0.6	0.128	3.30	1.50
0.8	0.148	4.42	2.01
1.0	0.165	5.24	2.38
1.2	0.185	5.72	2.60
1.5	0.21	7.74	3.52
1.8	0.218	9.68	4.40
2.0	0.24	10.38	4.72
2.5	0.26	12.30	5.59
3.0	0.29	14.12	6.42
4.0	0.33	16.50	7.50
5.0	0.37	20.68	9.40



NEW

SHOTAI FLUOROCARBON LINE

Japan Size	Diameter	Test Tensile (LB)	Test Tensile (kg)	LB	Meter
7	0.460	10.7	23.5	25	35M
8	0.492	13.2	29.0	30	35M
12	0.602	18.9	41.6	41	20M
16	0.696	22.4	49.3	50	20M
18	0.740	24.6	54.1	55	15M
24	0.850	31.8	70.0	70	15M
28	0.920	35.6	78.3	80	15M
35	1.020	44.9	98.8	100	15M



Okuma Full Back Two Tone Blue Patch Hat
Model: PA01C007B



Okuma Gray Cotton Cap
Model: PA01C004G



Okuma White Cotton Cap
Model: PA01C003W



FULL BRIM HAT
Model: PA01C014B

UPF 50+



Okuma Motif Long Sleeve Shirt

Siza	S	M	L
Model	PA01T031BS	PA01T031BM	PA01T031BL

Siza	XL	2L	3L
Model	PA01T031BXL	PA01T031B2L	PA01T031B3L

UPF 50+



Okuma Motif Short Sleeve Shirt

Siza	S	M	L
Model	PA01T032BS	PA01T032BM	PA01T032BL

Siza	XL	2L	3L
Model	PA01T032BXL	PA01T032B2L	PA01T032B3L

UPF 50+



Okuma Motif Tournament Jersey

Siza	S	M	L
Model	PA01T030BS	PA01T030BM	PA01T030BL

Siza	XL	2L	3L
Model	PA01T030BXL	PA01T030B2L	PA01T030B3L

Okuma Motif Hoodie

Siza	S	M	L
Model	PA01T034BS	PA01T034BM	PA01T034BL

Siza	XL	2L	3L
Model	PA01T034BXL	PA01T034B2L	PA01T034B3L



NEW

Okuma Dorado Long Sleeve Shirt

Siza	M	L	XL
Model	PA01T036WM	PA01T036WL	PA01T036WXL

Siza	2L	3L
Model	PA01T036W2L	PA01T036W3L



NEW

Okuma Dorado Long Sleeve Shirt

Siza	M	L	XL
Model	PA01T037WM	PA01T037WL	PA01T037WXL

Siza	2L	3L
Model	PA01T037W2L	PA01T037W3L



Okuma Motif Cotton Short Sleeve Shirt

Siza	S	M	L
Model	PA01T033BS	PA01T033BM	PA01T033BL

Siza	XL	2L	3L
Model	PA01T033BXL	PA01T033B2L	PA01T033B3L



NEW

Water-resistant, breathable, seam-sealed, 2-layer stretch shell
100% windproof fabric
Attached, fully adjustable hood
Water-resistant zip
Adjustable cuff tabs
Hem cinch-cord
Reflection printing

Okuma Water-resistant Jacket

Siza	S	M	L
Model	PA01J004BS	PA01J004BM	PA01J004BL

Siza	XL	2L	3L
Model	PA01J004BXL	PA01J004B2L	PA01J004B3L



NEW

Okuma black motif sun shield

Model: PA01C019K



NEW

Okuma blue motif sun shield

Model: PA01C020B

NEW

Okuma motif design
Lightweight and breathable woven material
Anti-vibration EVA outsole



Okuma sport shoes

Size UA	6	7	8	9	10	11	12
Size CM	24	25	26	27	28	29	30
Model	PA01H001K06	PA01H001K07	PA01H001K08	PA01H001K09	PA01H001K10	PA01H001K11	PA01H001K12



NEW

Long Nose Pliers

NEW

Split Ring Pliers

NEW

Mini Nose Pliers

Type name	Long Nose Pliers 6"	Long Nose Pliers 7"	Split Ring Pliers 6"	Split Ring Pliers 9"	Mini Nose Pliers 6"
Length	6"	7"	6"	9"	6"
Model	PA09028	PA09029	PA09030	PA09031	PA09032



Okuma Motif Single Finger Casting Glove

Model: PA01F002B

Okuma Motif Jigging Gloves

Size	XS	S	M	L	XL
Model	PA01F001WXS	PA01F001WS	PA01F001WM	PA01F001WL	PA01F001WXL

Measure hand circumference at area indicated.

XS	20-21cm	M	24-25cm
S	22-23cm	L	26-27cm
		XL	28-29cm



Okuma Sun glasses

Lens Color	Green Mirror	Brown	Gray
Model	PA01G001B	PA01G002B	PA01G003B



Okuma Sun glasses

Lens Color	Green Mirror	Brown	Gray
Model	PA01G004W	PA01G005W	PA01G006W



Okuma Sun glasses

Lens Color	Green Mirror	Brown	Gray
Model	PA01G007B	PA01G008B	PA01G009B

Okuma Reel Cover

Protect your reels from unwanted dings, harsh exposure to the elements, as well as the more simple intrusions of dust and dirt. Custom Okuma neoprene reel covers are cut for a perfect fit to most star drag and lever drag reels.



PAOKM0504-1

PAOKM0503-1

PAOKM0502-1

PAOKM0505-1

Reel Shield-Neoprene Reel Cover

50/50W Lever Drag reels
Model: PAOKM0504-1

Reel Shield-Neoprene Reel Cover

20/30 size Lever Drags and 55/55W Star Drag Reels
Model: PAOKM0503-1

Reel Shield-Neoprene Reel Cover

10/15 Lever Drags and 30/40/300/450 Star Drag Reels
Model: PAOKM0502-1

Reel Shield-Neoprene Reel Cover

150/250/400 Baitcast and 15/20/200 Star Drags
Model: PAOKM0505-1

Reel Shield-Neoprene Reel Cover

40/55 Spinning Reels
Model: PA409A
65/80 Spinning Reels
Model: PA410A



Okuma Rod Straps(L),36cm

Model: PAOKM0701-1



Okuma SPOOL BAND

Model: KSCPD07019 / S
Model: KSCPD07017 / L

Universal Reel Grease

- Maximum corrosion protection
- Fortified with teflon and polymers
- Little or no drag acceleration
- Exceptionally smooth drag performance
- Superior heat and wear resistance
- Safe on all metals and common plastics
- Reduces gear train friction for easier cranking



PA1140

PA1139

Accessories

Model	Dimensions
PA1139	Cal's universal drag and gear grease 30grams
PA1140	Cal's universal drag and gear grease 100grams
PA1141	Cal's universal grease 30grams with 10ML of Corrosion-X HD oil



Spinning Reel Holder

Model: PA02009
(Not Including Reel)



Trolling Reel Holder

Model: PA02017
(Not Including Reel)



Okuma Lip Gripper

Model: PAFGA0201-1



Reel Display

Model: PA02007
Capacity: 28 spinning reels

Reel Display (with security wire)

Model: PA02016



Metal Rod Rack

Model: PA02013
Capacity:30 rods



Bamboo Rack

Capacity:28 rods
Model: PA02014



Cardboard Combo Display

Model: PA02010



Okuma ABS Rod Rack

Model: PAOKM1000

Simple, functional, easy to set up and easy to use. The Okuma ABS rod rack holds 8 rod and reel combos or a full 16 rods with reels removed. Connect multiple racks together to make a complete system for the largest collections.



Okuma ABS Rod Rack

Model: PA342A