

Aluminum Sacrificial Anodes

***High Performance
Aluminum Anodes***



CORROSION CONTROL • NAVALLOY ANODES • RED SPOT WEAR INDICATOR • SECURECORE

ALUMINUM ANODES

A better solution for every application...

Longer Lasting...

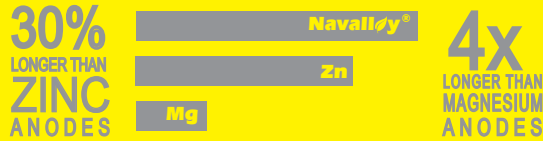

Navalloy® anodes will work longer than Zinc because they have more capacity for the same overall size:

Capacity per unit weight is:

Zinc	368 Ampere Hours/lb
Magnesium	500 Ampere Hours/lb
Navalloy®	1150 Ampere Hours/lb

But density is:

Zinc	0.25 lb/cu in
Magnesium	0.06 lb/cu in
Navalloy®	0.10 lb/cu

Therefore the relative life expressed in A Hours/ cu inch is:

Zinc	92 Ampere Hours/cu inch
Magnesium	30 Ampere Hours/cu inch
Navalloy®	115 Ampere Hours/cu inch

So Navalloy® anodes will last up to 30% longer than Zinc and up to 4x longer than Magnesium!

Any Hull...

	Aluminum	Steel	Fibreglass	Wood
Navalloy®	✓	✓	✓	✓

All Water Types...

	Salt	Brackish	Fresh
Zinc	✓		
Magnesium			✓
Navalloy®	✓	✓	✓



Most outboard and sterndrive manufacturers now install Aluminum anodes as standard because they are safe and offer the best overall protection in any type of water.

Better Protection...

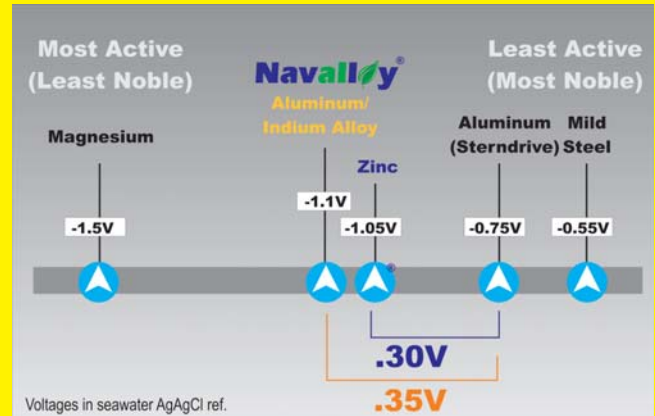

Navalloy® anodes work better than Zinc in saltwater because they generate a more negative voltage therefore providing increased protection. In freshwater Magnesium anodes can sometimes over-protect Aluminum hulls or outdrives. Navalloy® Mil. Spec. MIL-DTL-24779.

Any Kind of Use...

- Re-activates after exposure to air
- Works immediately on re-immersion
- No cleaning required

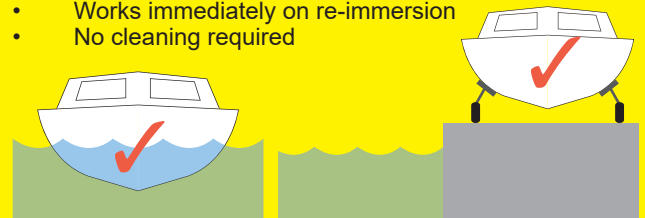

Navalloy® anodes can be left permanently immersed or can be used on boats that are regularly lifted in and out of the water (such as trailered boats, boats on lifts or boats left on the hard over winter). Zinc anodes will coat over if exposed to air and need to be burnished before re-immersion.

Exclusive RED SPOT Wear Indicator...

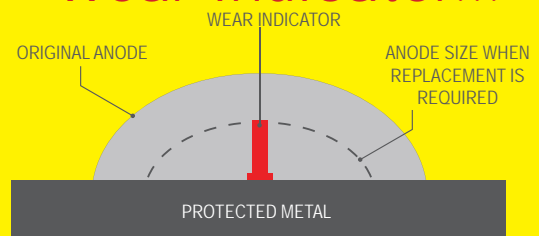

The patented red spot wear indicator is exclusive to Performance Metals Products. When the red spot appears it's time to change!

ALUMINUM ANODES

A better solution for every application...

Eco-Friendly...

Why Use Navalloy?

Zinc anodes have 20 times more toxic elements



REDUCE POLLUTION!

Cadmium FREE

Mercury FREE

Navalloy® anodes are 20 times more eco-friendly than Zinc anodes. The EPA (Environmental Protection Agency) has identified Zinc anodes as a major cause of pollution in marinas and so now recommend the use of Aluminum anodes.

Navalloy in Saltwater

Key benefits over Zinc

- ✓ **Up to 30% longer lasting**
- ✓ **Increased protection**
- ✓ **20 times more eco-friendly**
- ✓ **Lighter weight**
- ✓ **Auto reactivating**

Lighter than Zinc...



Navalloy® anodes are lighter than Zinc which is 2 ½ times more dense than Aluminum.

Navalloy in Freshwater

Key benefits over Zinc

- ✓ **Up to 4 x longer lasting**
- ✓ **No risk of overprotection**

Zinc density	0.25 lb/cu in(6.6gm/cc)
Aluminum density	0.10 lb/cu (2.8gm/cc)

Attractive Packaging...

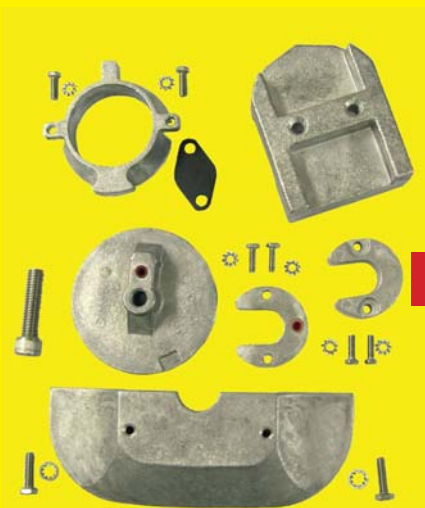

Navalloy® anodes are packaged attractively with printed text in multiple languages including installation instructions. In many cases they are available in complete kits for maximum convenience.











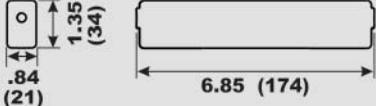

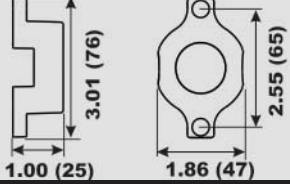

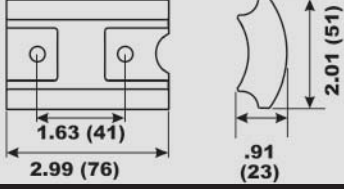
BOMBARDIER ANODE KITS

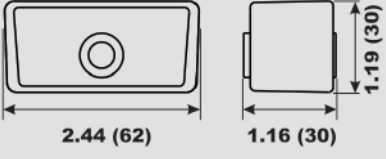
10188A			<p>OMC Cobra Kit</p> <p>Weight: 2.3 lbs (1.05 Kg) Pack Size: 5 ½ x 11 x 2 ¾ (140 x 279 x 70)</p>
10189A			<p>Johnson/Evinrude 50-225 hp (1991-1995)</p> <p>Weight: 2.2 lbs (1.0 Kg) Pack Size: 5 ½ x 11 x 2 ¾ (140 x 279 x 70)</p>
10190A			<p>Johnson/Evinrude 90-225 hp (1985-1986)</p> <p>Weight: 2.2 lbs (1.0 Kg) Pack Size: 5 ½ x 11 x 2 ¾ (140 x 279 x 70)</p>
10221A			<p>Johnson/Evinrude 50-225 hp (1991-1995)</p> <p>Weight: 2.2 lbs (1.0 Kg) Pack Size: 5 ¼ x 9 x 1 ¾ (133 x 229 x 44)</p>

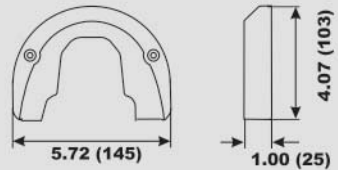
BOMBARDIER ANODES

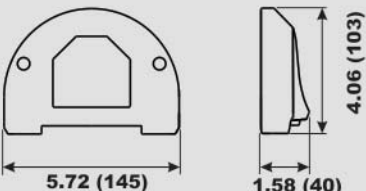
00141A			<p>Side Mounted</p> <p>Weight: 0.1 lbs (0.05 Kg)</p> <p>Replaces J/E #s 123009/327606/173029</p>
00142A			<p>Transom</p> <p>Weight: 0.7 lbs (0.3 Kg)</p> <p>Replaces J/E # 392462</p>

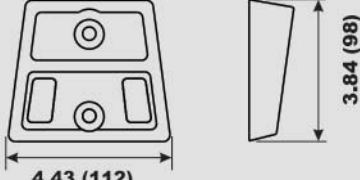
BOMBARDIER ANODES

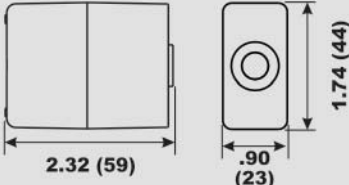
<p>00143A</p> 		<p>Transom</p> <p>Weight: 0.7 lbs (0.3 Kg)</p> <p>Replaces J/E # 433580</p>
<p>00144A</p> 		<p>Front Gearcase</p> <p>Weight: 0.15 lbs (0.07 Kg)</p> <p>Replaces J/E # 398873</p>
<p>00145A</p> 		<p>Prop Shaft</p> <p>Weight: 0.2 lbs (0.08 Kg)</p> <p>Replaces J/E # 431708</p>
<p>00151A</p> 		<p>Block</p> <p>Weight: 0.3 lbs (0.15 Kg)</p> <p>Replaces J/E # 397768</p>
<p>00152A</p> 		<p>Front Gearcase Anode</p> <p>Weight: 0.6 lbs (0.28 Kg)</p> <p>Replaces J/E # 983494</p>
<p>00153A</p> 		<p>Front Gearcase Anode</p> <p>Weight: 0.9 lbs (0.4 Kg)</p> <p>Replaces J/E #s 3853818/984513</p>
<p>00154A</p> 		<p>Transom Mount</p> <p>Weight: 0.7 lbs (0.32 Kg)</p> <p>Replaces J/E # 984547</p>
<p>00155A</p> 		<p>Block - Rear Gearcase</p> <p>Weight: 0.3 lbs (0.15 Kg)</p> <p>Replaces J/E #s 433458/398331</p>

BOMBARDIER ANODES

00192A

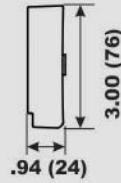
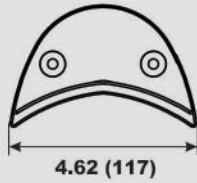

Front Gearcase

Weight: 0.7 lbs (0.3 Kg)

Replaces J/E # 392123

00201A

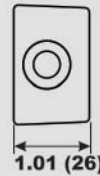
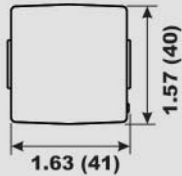

Cobra Rear Gear Case

Weight: 0.2 lbs (0.1 Kg)

Replaces J/E #s 436745/393023

HONDA ANODES

00027A

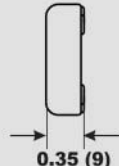
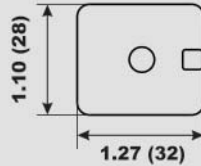

Small Plate Anode (2 per)

Weight: 0.04 lbs (0.02 Kg)

Replaces Honda # 41106-ZW9-000

00044A ●

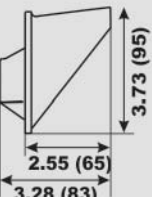

Trim Tab Anode

Weight: 0.4 lbs (0.17 Kg)

Replaces Honda # 41107-ZW1-003ZA

00051A ●

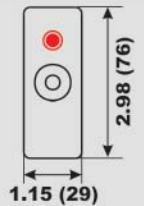

Side Pocket Anode

Weight: 0.18 lbs (0.08 Kg)

Replaces Honda # 41109-ZW1-003

00119A ●

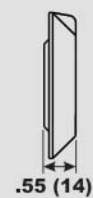
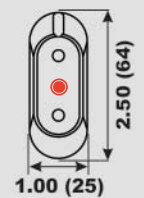

Side Mounted

Weight: 0.1 lbs (0.05 Kg)

Replaces Honda # 41106-935-812

00120A

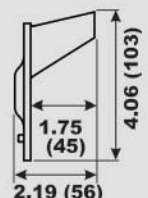
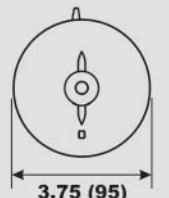

Trim Tab

Weight: 0.3 lbs (0.12 Kg)

Replaces Honda # 41107-ZV5-000





HONDA ANODES

<p>00197A</p>		<p>Stern Bracket</p> <p>Weight: 0.7 lbs (0.3 Kg)</p> <p>Replaces Honda # 6411-ZW1-000/020</p>
<p>00198A</p>		<p>Side Pocket Anode Thin (2 per)</p> <p>Weight: 0.4 lbs (0.2 Kg)</p> <p>Replaces Honda # 41109-ZW1-B00</p>



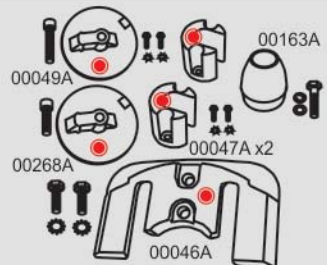

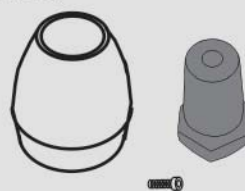

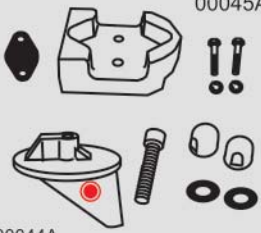
MERCUISER STERNDRIIVE KITS

<p>10108A</p>		<p>Alpha One Generation 1</p> <p>Weight: 2.0 lbs (0.9 Kg)</p> <p>Pack Size: 5 ½ x 11 x 2 ¾ (140 x 279 x 70)</p>
<p>10059A</p>		<p>Alpha One Generation 2</p> <p>Weight: 2.1 lbs (1.0 Kg)</p> <p>Replaces Mercury # 888756Q03</p> <p>Pack Size: 5 ½ x 11 x 2 ¾ (140 x 279 x 70)</p>
<p>10060A</p>		<p>Bravo 1</p> <p>Weight: 2.0 lbs (0.9 Kg)</p> <p>Replaces Mercury # 888758Q02</p> <p>Pack Size: 5 ½ x 11 x 2 ¾ (140 x 279 x 70)</p>
<p>10061A</p>		<p>Bravo 2/3</p> <p>Weight: 1.9 lbs (0.85 Kg)</p> <p>Replaces Mercury # 888761Q03</p> <p>Pack Size: 5 ½ x 11 x 2 ¾ (140 x 279 x 70)</p>



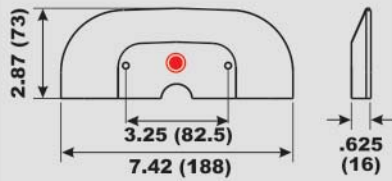

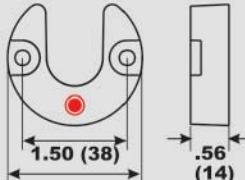

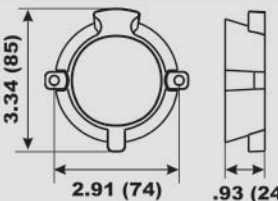





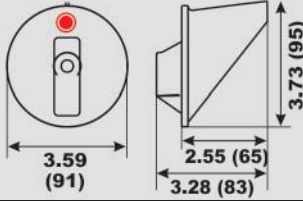

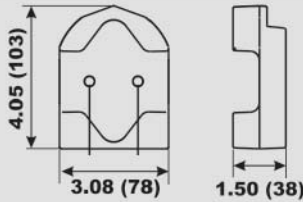
MERCUISER STERNDRIVE KITS

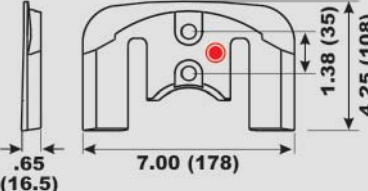
<p>10165A</p> 		<p>Bravo 3 (2004+)</p> <p>Weight: 2.7 lbs (1.2 Kg) Replaces Mercury # 888761Q04 Pack Size: 5 1/2 x 11 x 2 3/4 (140 x 279 x 70)</p>
<p>10195A</p> 	<p>00196A</p> 	<p>Bravo 3 Prop Retrofit</p> <p>Weight: 1.25 lbs (0.6 Kg) Pack Size: 4 3/4 x 8 x 2 1/2 (121 x 203 x 64)</p>
<p>10205A</p> 	<p>00045A</p> 	<p>Alpha 1 Gen 1 Kit (No Power Steering)</p> <p>Weight: 1.6 lbs (0.7 Kg) Replaces Mercury # 888756Q04 Pack Size: 5 1/2 x 11 x 2 3/4 (140 x 279 x 70)</p>

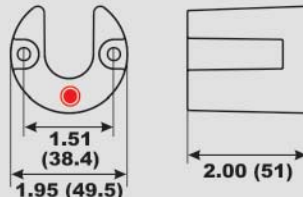

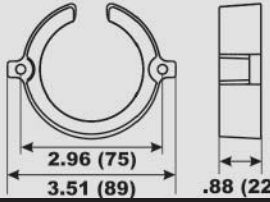

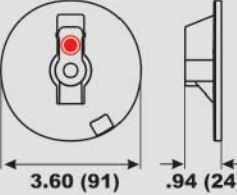
MERCUISER STERNDRIVE ANODES

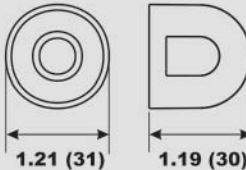
<p>00041A </p> 		<p>Alpha Cavitation Plate</p> <p>Weight: 0.55 lbs (0.24 Kg) Replaces Mercury # 821629T 1</p>
<p>00042A </p> 		<p>Alpha Trim Cylinder Anode</p> <p>Weight: 0.07 lbs (0.03 Kg) Replaces Mercury # 806189T 1</p>
<p>00043A</p> 		<p>Alpha Bearing Carrier</p> <p>Weight: 0.17 lbs (0.08 Kg) Replaces Mercury # 806105T 1</p>

MERCUISER STERNDRIVE KITS

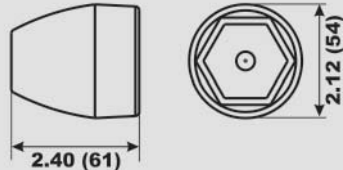

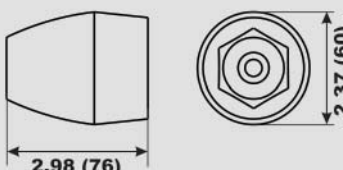
<p>00044A </p> 		<p>Trim Tab Anode</p> <p>Weight: 0.4 lbs (0.17 Kg)</p> <p>Replaces Mercury # 31640T 4</p>
<p>00045A</p> 		<p>Gimbal Housing Block</p> <p>Weight: 0.7 lbs (0.3 Kg)</p> <p>Replaces Mercury # 821631T 1</p>
<p>00046A</p> 		<p>Bravo Cavitation Plate</p> <p>Weight: 0.8 lbs (0.35 Kg)</p> <p>Replaces Mercury # 821630T 1</p>
<p>00047A </p> 		<p>Bravo Trim Cylinder Anode</p> <p>Weight: 0.27 lbs (0.12 Kg)</p> <p>Replaces Mercury # 806190T 1</p>
<p>00048A</p> 		<p>Bravo Bearing Carrier</p> <p>Weight: 0.16 lbs (0.07 Kg)</p> <p>Replaces Mercury # 806188A 1</p>
<p>00049A </p> 		<p>Trim Tab Anode Flat</p> <p>Weight: 0.25 lbs (0.1 Kg)</p> <p>Replaces Mercury # 76214T 5</p>
<p>00050A</p> 		<p>Gimbal Housing Bolt Headnut (Qty 2)</p> <p>Weight: 0.15 lbs (0.07 Kg)</p> <p>Replaces Mercury # 55989T 9</p>

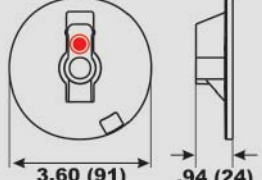
MERCUISER STERNDRIVE ANODES





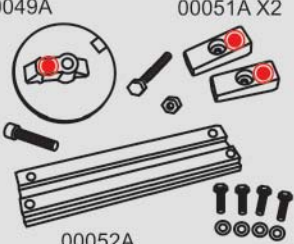

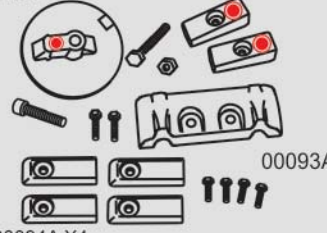





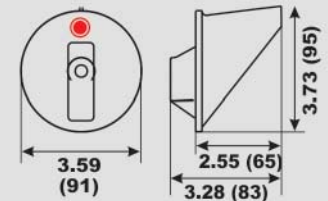

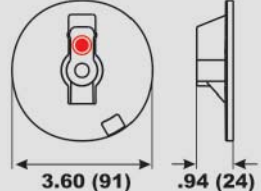

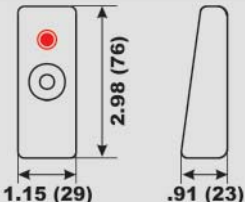
<p>00163A</p> 		<p>Prop Anode Bravo 3 (2004) Weight: 0.4 lbs (0.18 Kg) Replaces Mercury # 865182A 1</p>
<p>00196A</p> 		<p>Prop Anode Bravo 3 (2003 and Older) Weight: 0.6 lbs (0.28 Kg)</p>
<p>00268A ●</p> 		<p>Trim Anode Flat (No Thread) Weight: 0.6 lbs (0.28 Kg) Replaces Mercury # 76214 4</p>

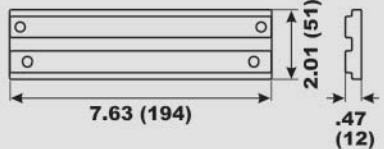

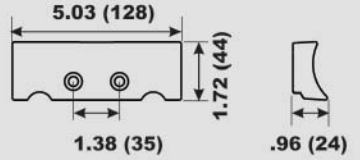

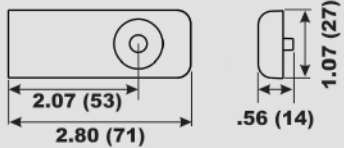
MERCURY OUTBOARD KITS

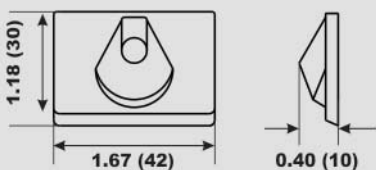
<p>10202A</p> 	<p>00049A 00051A X2</p>  <p>00052A</p>	<p>Verado 4 & Optimax Kit Weight: 1.6 lbs (0.7 Kg) Pack Size: 5 ½ x 11 x 2 ¾ (140 x 279 x 70)</p>
<p>10203A</p> 	<p>00049A 00051A X2</p>  <p>00093A 00094A X4</p>	<p>Verado 6 Kit Weight: 1.6 lbs (0.7 Kg) Pack Size: 5 ½ x 11 x 2 ¾ (140 x 279 x 70)</p>

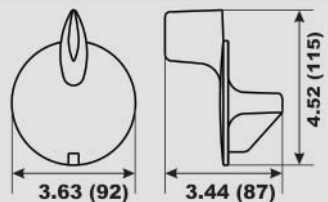



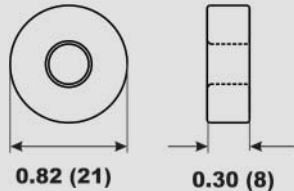

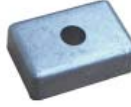
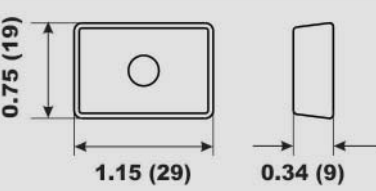

MERCURY OUTBOARD ANODES

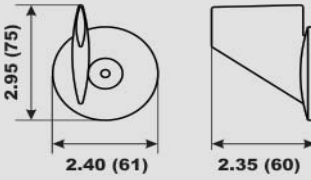
<p>00044A </p> 		<p>Trim Tab Anode Weight: 0.4 lbs (0.17 Kg) Replaces Mercury # 31640T 4</p>
<p>00049A </p> 		<p>Trim Tab Anode Flat Weight: 0.25 lbs (0.1 Kg) Replaces Mercury # 76214T 5</p>
<p>00051A </p> 		<p>Side Pocket Anode Weight: 0.18 lbs (0.08 Kg) Replaces Mercury # 826134T</p>
<p>00052A</p> 		<p>Outboard Power Trim Anode Weight: 0.5 lbs (0.23 Kg) Replaces Mercury # 818298T 1</p>
<p>00093A</p> 		<p>Manifold Anode Weight: 0.5 lbs (0.23 Kg) Replaces Mercury # 880653</p>
<p>00094A</p> 		<p>Trim Cylinder Verado Weight: 0.1 lbs (0.04 Kg) Replaces Mercury # 893404</p>
<p>00222A</p> 		<p>Gear Housing Anode 6-15hp Weight: 0.03 lbs (0.01 Kg) Replaces Mercury # 42121Q02</p>
<p>00223A</p> 		<p>Trim Tab 9.9-25hp Weight: 0.4 lbs (0.18 Kg) Replaces Mercury # 98432Q6</p>

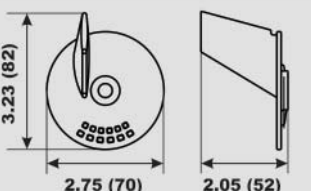
MERCURY OUTBOARD ANODES

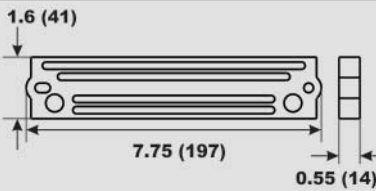
<p>00224A</p> 		<p>Round Anode 4-30hp Weight: 0.04 lbs (0.02 Kg) Replaces Mercury # 823912</p>
<p>00225A</p> 		<p>Bar Anode 25-40hp Weight: 0.24 lbs (0.11 Kg) Replaces Mercury # 825271 1</p>
<p>00226A</p> 		<p>Square Block 4-9.9hp Weight: 0.06 lbs (0.03 Kg) Replaces Mercury # 875208</p>

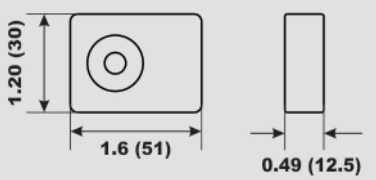
SUZUKI ANODES

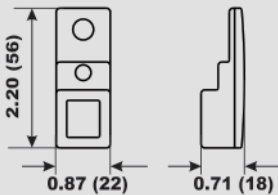
<p>00351A</p> 		<p>Trim Tab - 40-85hp Weight: 0.16 lbs (0.07 Kg) Anode for Suzuki # 55125-95500</p>
<p>00352A</p> 		<p>Trim Tab - 25-30hp Weight: 0.1 lbs (0.05 Kg) Anode for Suzuki # 55125-96310</p>
<p>00353A</p> 		<p>Outboard Bar Anode - 40-300hp Weight: 0.4 lbs (0.18 Kg) Anode for Suzuki # 55320-94900</p>
<p>00354A</p> 		<p>Small Block Anode - 4-300hp Weight: 0.07 lbs (0.03 Kg) Anode for Suzuki # 55320-95311</p>
<p>00355A</p> 		<p>Gear Case Anode - 60-140hp Weight: 0.07 lbs (0.03 Kg) Anode for Suzuki # 55321-90J01</p>

SUZUKI ANODES

00356A

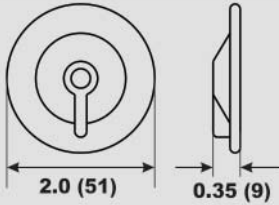

**Outboard Anode -
9.9-15hp**

Weight: 0.05 lbs (0.02 Kg)

Replaces Suzuki # 55321-939900

VOLVO PENTA ANODE KITS

10274A

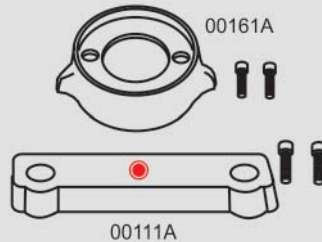

Volvo 280

Weight: 1.6 lbs (0.7 Kg)

Pack Size: 5 ½ x 11 x 2 ¾
(140 x 279 x 70)

10275A

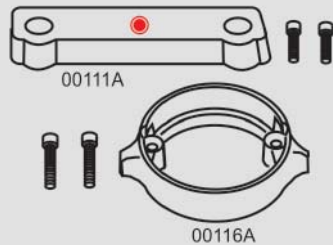

Volvo 280 Dual Prop

Weight: 1.3 lbs (0.6 Kg)

Pack Size: 5 ½ x 11 x 2 ¾
(140 x 279 x 70)

10276A

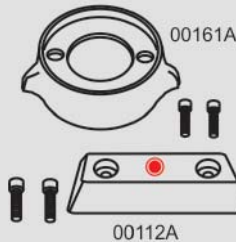

Volvo 290

Weight: 1.6 lbs (0.7 Kg)

Pack Size: 5 ½ x 11 x 2 ¾
(140 x 279 x 70)

10277A

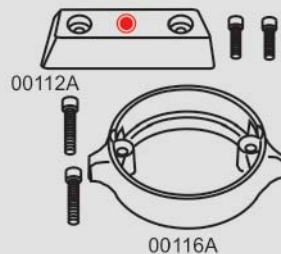

Volvo 290 Dual Prop

Weight: 1.3 lbs (0.6 Kg)

Pack Size: 5 ½ x 11 x 2 ¾
(140 x 279 x 70)

10278A









Volvo SX

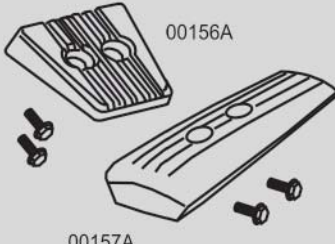

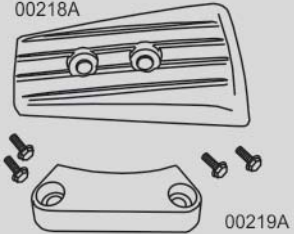
Weight: 2.1 lbs (1.0 Kg)

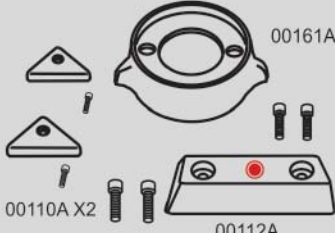
Pack Size: 5 ½ x 11 x 2 ¾
(140 x 279 x 70)

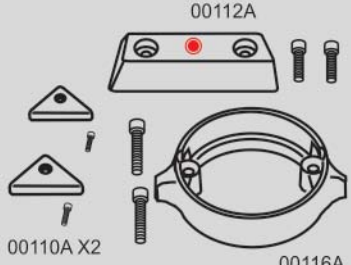



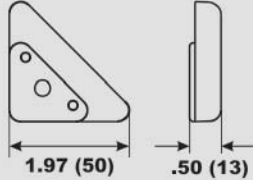

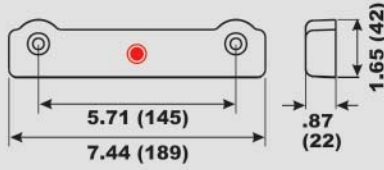





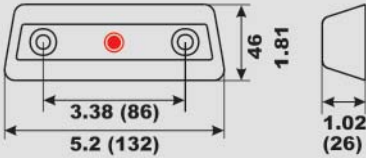

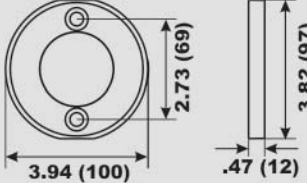

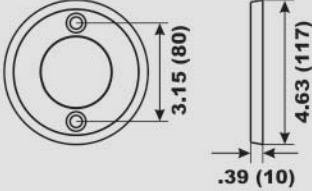
VOLVO PENTA ANODE KITS

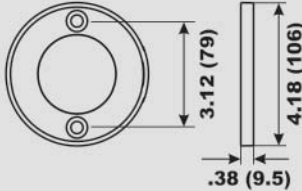
<p>10289A</p> 		<p>Volvo DP-S/SX-A</p> <p>Weight: 1.6 lbs (0.7 Kg) Pack Size: 5 ½ x 11 x 2 ¾ (140 x 279 x 70)</p>
<p>10303A</p> 		<p>Volvo DPH/DPR</p> <p>Weight: 1.6 lbs (0.7 Kg) Pack Size: 5 ½ x 11 x 2 ¾ (140 x 279 x 70)</p>
<p>10276AE</p> 		<p>Volvo 290 Export</p> <p>Weight: 1.8 lbs (0.8 Kg) Pack Size: 5 ½ x 11 x 2 ¾ (140 x 279 x 70)</p>
<p>10277AE</p> 		<p>Volvo 290 Dual Prop Export</p> <p>Weight: 1.5 lbs (0.7 Kg) Pack Size: 5 ½ x 11 x 2 ¾ (140 x 279 x 70)</p>

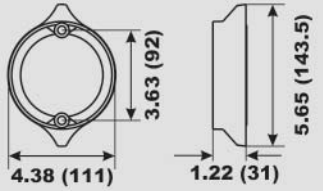

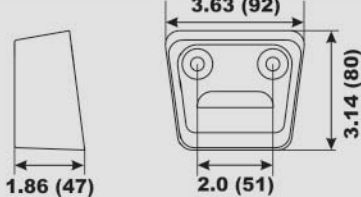

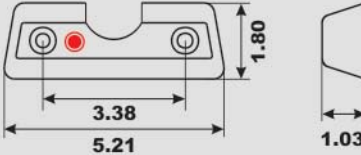

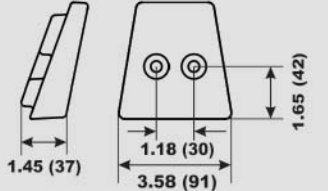



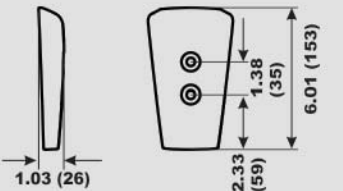

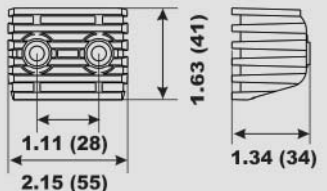

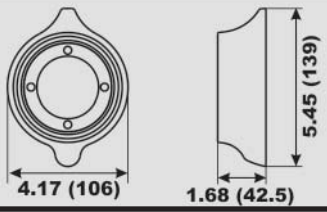
VOLVO PENTA ANODES

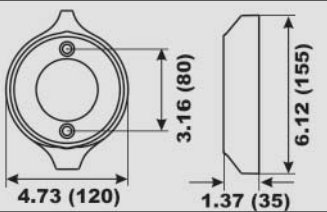
<p>00110A</p> 		<p>Side Mounted Anode - SX, DP-X</p> <p>Weight: 0.1 lbs (0.04 Kg)</p> <p>Replaces Volvo # 872793</p>
<p>00111A ●</p> 		<p>Anodic Bar</p> <p>Weight: 0.8 lbs (0.36 Kg)</p> <p>Replaces Volvo # 832598</p>

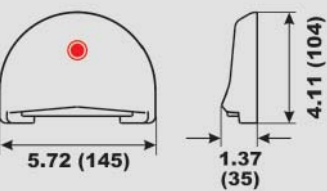

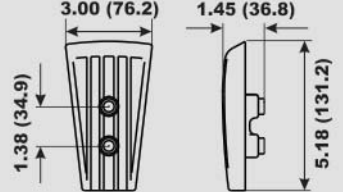

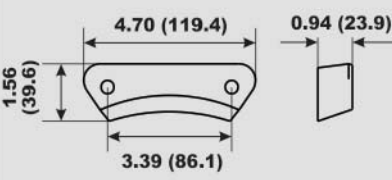

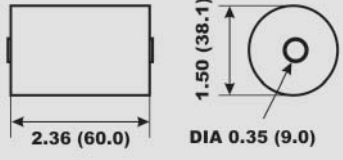

VOLVO PENTA ANODES

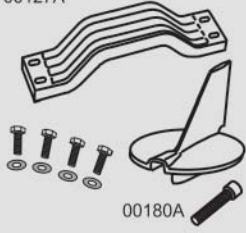
<p>00112A </p> 		<p>Anodic Bar</p> <p>Weight: 0.7 lbs (0.3 Kg)</p> <p>Replaces Volvo # 852835</p>
<p>00113A</p> 		<p>Prop Ring - V15</p> <p>Weight: 0.15 lbs (0.07 Kg)</p> <p>Replaces Volvo # 875810</p>
<p>00114A</p> 		<p>Prop Ring - V17</p> <p>Weight: 0.25 lbs (0.1 Kg)</p> <p>Replaces Volvo # 875805</p>
<p>00115A</p> 		<p>Prop Ring - V16</p> <p>Weight: 0.2 lbs (0.07 Kg)</p> <p>Replaces Volvo # 875809</p>
<p>00116A</p> 		<p>Prop Ring - Duo Prop</p> <p>Weight: 0.5 lbs (0.23 Kg)</p> <p>Replaces Volvo # 875821</p>
<p>00117A</p> 		<p>Gimbal Plate - SX</p> <p>Weight: 0.9 lbs (0.4 Kg)</p> <p>Replaces Volvo # 3854130</p>
<p>00118A </p> 		<p>Anodic Bar</p> <p>Weight: 0.6 lbs (0.25 Kg)</p> <p>Replaces Volvo # 872139</p>
<p>00156A</p> 		<p>Transom DPS-A/SX-A</p> <p>Weight: 1.1 lbs (0.5 Kg)</p> <p>Replaces Volvo #s 3841427/3888816</p>

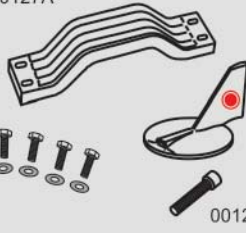

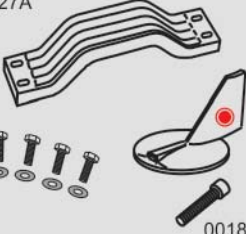
VOLVO PENTA ANODES

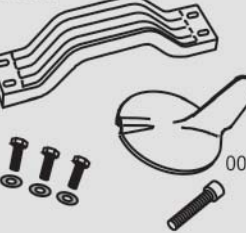
<p>00157A</p> 		<p>Gearhouse DPS-A/SX-A</p> <p>Weight: 1.5 lbs (0.7 Kg)</p> <p>Replaces Volvo #s 3883728/3888813</p>
<p>00158A</p> 		<p>DPX Outdrive Cube</p> <p>Weight: 0.3 lbs (0.15 Kg)</p> <p>Replaces Volvo # 873395</p>
<p>00160A</p> 		<p>Prop Ring - 110 Sail Drive</p> <p>Weight: 0.8 lbs (0.35 Kg)</p> <p>Replaces Volvo # 875812</p>
<p>00161A</p> 		<p>Prop Ring - V18</p> <p>Weight: 0.6 lbs (0.26 Kg)</p> <p>Replaces Volvo # 875815</p>
<p>00162A ●</p> 		<p>Transom Plate - SX</p> <p>Weight: 0.9 lbs (0.4 Kg)</p> <p>Replaces Volvo # 3855411</p>
<p>00218A</p> 		<p>Cavitation Plate - DPH/DPR</p> <p>Weight: 0.8 lbs (0.35 Kg)</p> <p>Replaces Volvo # 3588748</p>
<p>00219A</p> 		<p>Transon Shield - DPH/DPR</p> <p>Weight: 0.5 lbs (0.23 Kg)</p> <p>Replaces Volvo # 3588745</p>
<p>00349A</p> 		<p>Volvo D4/D6 Exhaust Anode</p> <p>Weight: 0.4 lbs (0.18 Kg)</p> <p>Anode for Volvo #218680/1/2</p>

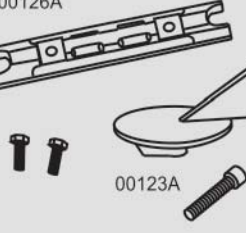





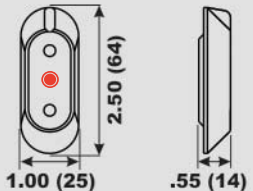

YAMAHA ANODE KITS

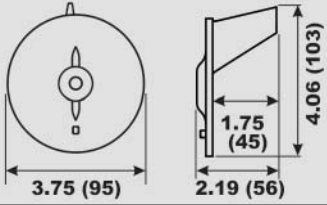
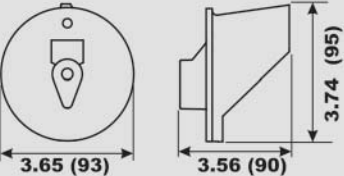
<p>10182A</p> 	<p>00127A</p>  <p>00180A</p>	<p>Yamaha Kit 200 hp-250hp 4 Stroke</p> <p>Weight: 2.3 lbs (1.05 Kg) Pack Size: 5 ½ x 11 x 2 ¾ (140 x 279 x 70)</p>
<p>10183A</p> 	<p>00127A</p>  <p>00125A</p>	<p>Yamaha Kit 150 hp</p> <p>Weight: 2.2 lbs (1.0 Kg) Pack Size: 5 ½ x 11 x 2 ¾ (140 x 279 x 70)</p>
<p>10184A</p> 	<p>00127A</p>  <p>00181A</p>	<p>Yamaha Kit 150 hp Counter Rotation</p> <p>Weight: 2.2 lbs (1.0 Kg) Pack Size: 5 ½ x 11 x 2 ¾ (140 x 279 x 70)</p>
<p>10186A</p> 	<p>00127A</p>  <p>00185A</p>	<p>Yamaha Kit 200-300 hp 2 Stroke</p> <p>Weight: 2.2 lbs (1.0 Kg) Pack Size: 5 ½ x 11 x 2 ¾ (140 x 279 x 70)</p>
<p>10187A</p> 	<p>00126A</p>  <p>00123A</p>	<p>Yamaha Kit 60-90 hp</p> <p>Weight: 1.1 lbs (0.5 Kg) Pack Size: 5 ½ x 11 x 2 ¾ (140 x 279 x 70)</p>

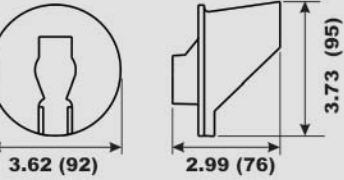

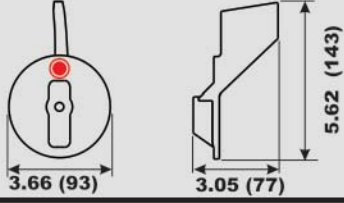
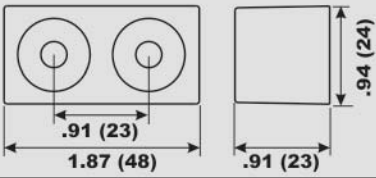

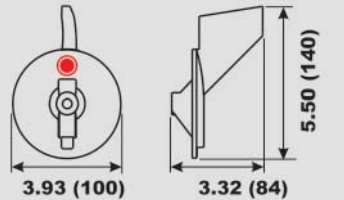

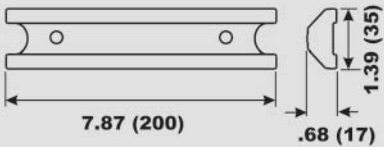
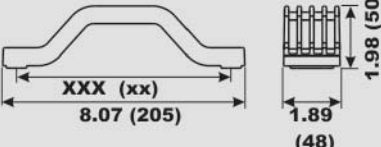



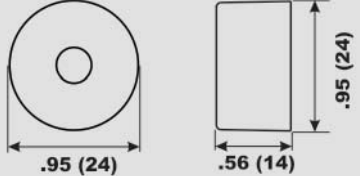

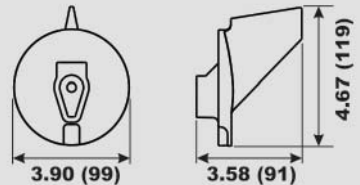

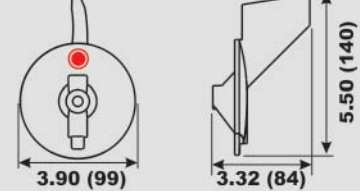
YAMAHA ANODES

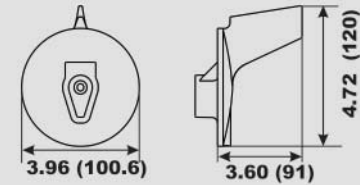
<p>00119A </p> 	 <p>1.00 (25) 2.50 (64) .55 (14)</p>	<p>Side Mounted</p> <p>Weight: 0.1 lbs (0.05 Kg)</p> <p>Replaces Yamaha # 6E0-45251-11</p>
---	---	---

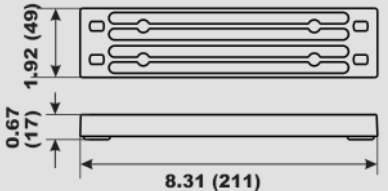

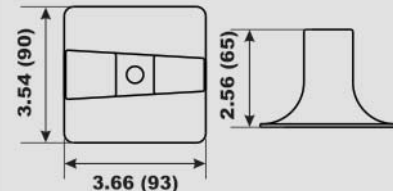

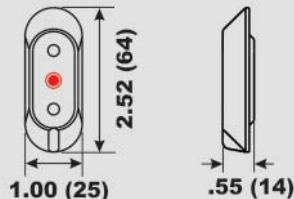

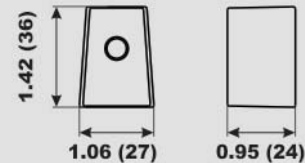





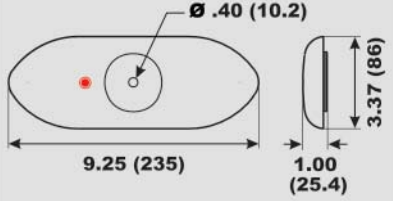

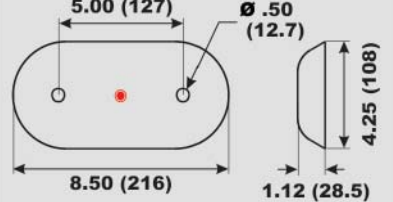

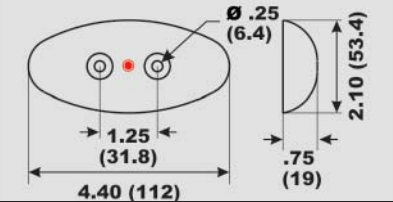
YAMAHA ANODES

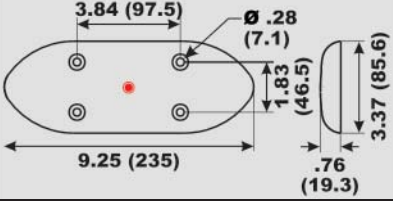
<p>00120A</p> 		<p>Trim Tab</p> <p>Weight: 0.3 lbs (0.12 Kg)</p> <p>Replaces Yamaha # 664-45371-01</p>
<p>00121A</p> 		<p>Trim Tab Counter Rotating</p> <p>Weight: 0.4 lbs (0.2 Kg)</p> <p>Replaces Yamaha # 6K1-45371-00</p>
<p>00122A</p> 		<p>Trim Tab</p> <p>Weight: 0.4 lbs (0.2 Kg)</p> <p>Replaces Yamaha # 6E5-45371-01</p>
<p>00123A ●</p> 		<p>Trim Tab 60 - 90 hp</p> <p>Weight: 0.4 lbs (0.2 Kg)</p> <p>Replaces Yamaha # 688-45371-02</p>
<p>00124A</p> 		<p>Block</p> <p>Weight: 0.15 lbs (0.07 Kg)</p> <p>Replaces Yamaha # 6E5-45251-00</p>
<p>00125A ●</p> 		<p>Trim Tab 150, 175 HP</p> <p>Weight: 0.6 lbs (0.3 Kg)</p> <p>Replaces Yamaha # 6J9-45371-01</p>
<p>00126A</p> 		<p>Transom Anode</p> <p>Weight: 0.45 lbs (0.2 Kg)</p> <p>Replaces Yamaha # 6H1-45251-02</p>
<p>00127A</p> 		<p>Transom Anode</p> <p>Weight: 0.8 lbs (0.4 Kg)</p> <p>Replaces Yamaha # 6G5-45251-02</p>

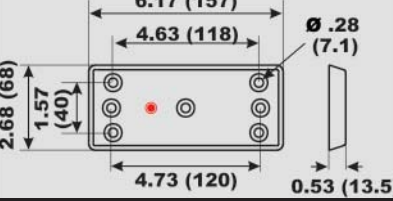

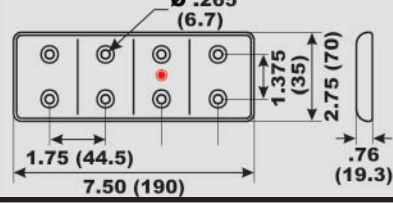

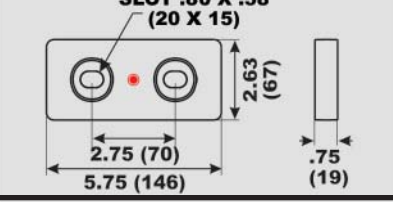

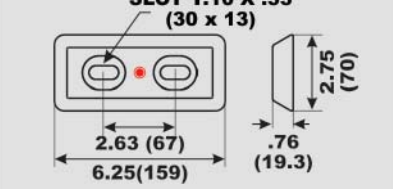





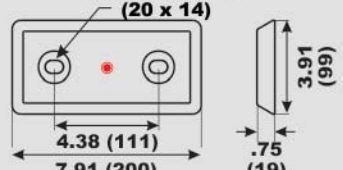

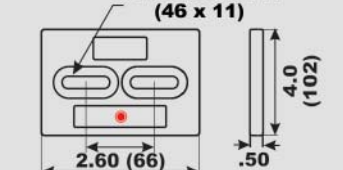

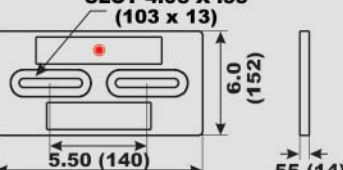
YAMAHA ANODES

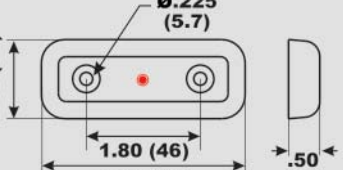
<p>00128A</p> 		<p>Block</p> <p>Weight: 0.04 lbs (0.02 Kg)</p> <p>Replaces Yamaha # 688-45251-01</p>
<p>00180A</p> 		<p>Trim Tab 200-250 HP 4-Stroke</p> <p>Weight: 0.6 lbs (0.3 Kg)</p> <p>Replaces Yamaha # 61A-45371-00</p>
<p>00181A </p> 		<p>Trim Tab 150, 175 HP Counter Rotating</p> <p>Weight: 0.6 lbs (0.3 Kg)</p> <p>Replaces Yamaha # 6K1-45371-02</p>
<p>00185A</p> 		<p>Trim Tab 200 - 300hp 2 stroke</p> <p>Weight: 0.8 lbs (0.4 Kg)</p> <p>Replaces Yamaha # 69L-45371-00</p>
<p>00357A</p> 		<p>Outboard Bracket Anode</p> <p>Weight: 0.58 lbs (0.26 Kg)</p> <p>Replaces Yamaha # 6AW-45251-00</p>
<p>00358A</p> 		<p>Lower Unit Anode</p> <p>Weight: 0.9 lbs (0.4 Kg)</p> <p>Replaces Yamaha # 6AW-45373-00</p>
<p>00359A </p> 		<p>Clamp Bracket Anode 8-250hp</p> <p>Weight: 0.12 lbs (0.05 Kg)</p> <p>Replaces Yamaha # 65W-45251-00</p>
<p>00360A</p> 		<p>Outboard Cube Anode 25-60hp</p> <p>Weight: 0.07 lbs (0.03 Kg)</p> <p>Replaces Yamaha # 67C-45251-00</p>

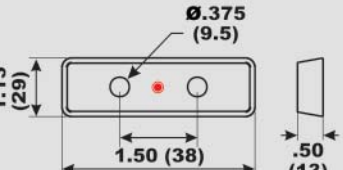
HULL ANODES

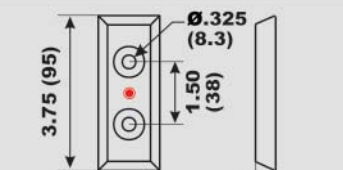
<p>H404A </p>			<p>Hull Plate (Pacemaker)</p>
<p>H406A </p>			<p>Hull Plate</p>
<p>HM24A </p>			<p>Hull Plate</p>
<p>HM25A </p>			<p>Hull Plate</p>
<p>HM30A </p>			<p>Hull Plate</p>
<p>HM40A </p>			<p>Hull Plate</p>
<p>HC2A </p>			<p>Hull Plate</p>
<p>HC3A </p>			<p>Hull Plate</p>

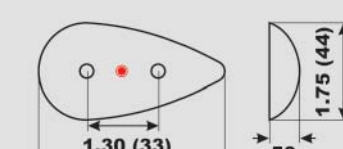
HULL ANODES

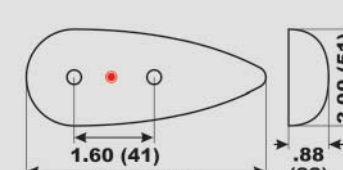
<p>HC5A </p> 	<p>SLOT .78 X .53 (20 x 14)</p> 	<p>Hull Plate</p> <p>Weight: 1.9 lbs (0.9 Kg)</p>
<p>HMDDA </p> 	<p>SLOT 1.80 X .44 (46 x 11)</p> 	<p>Hull Plate - Mini Diver's Anode</p> <p>Weight: 1.1 lbs (0.5 Kg)</p>
<p>HDDRA </p> 	<p>SLOT 4.06 X .53 (103 x 13)</p> 	<p>Hull Plate - Diver's Anode</p> <p>Weight: 3.5 lbs (1.6 Kg)</p>
<p>HDOKA </p> 	<p>Ø.225 (5.7)</p> 	<p>Doka Strainer Anode</p> <p>Weight: 0.2 lbs (0.1 Kg)</p>
<p>HBNTA </p> 	<p>Ø.375 (9.5)</p> 	<p>Bennett Trim Tab Anode (2 per)</p> <p>Weight: 0.4 lbs (0.2 Kg)</p>
<p>HBSLA </p> 	<p>Ø.325 (8.3)</p> 	<p>Bosler Strainer Anode</p> <p>Weight: 0.2 lbs (0.1 Kg)</p>
<p>T20A </p> 		<p>Small Teardrop Anode</p> <p>Weight: 0.2 lbs (0.1 Kg)</p>
<p>T21A </p> 		<p>Large Teardrop Anode</p> <p>Weight: 0.3 lbs (0.15 Kg)</p>

HULL ANODES

HYAA 

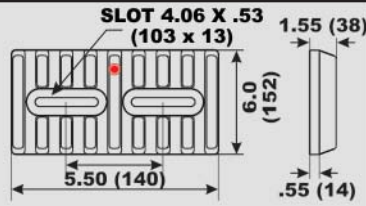

Boater's Dream Yacht Anode

Weight: 5.7 lbs (2.6 Kg)

EUROPEAN HULL ANODES

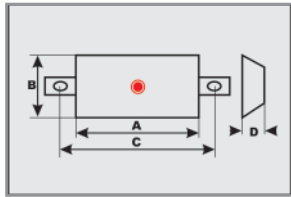

HE035A



Part #	A	B	C	D	Weight
HE002A	100mm (3.9")	34mm (1.3")	116mm (4.6")	17mm (0.7")	0.23 lbs (0.1Kg)
HE005A	118mm (4.6")	45mm (1.8")	140mm (5.5")	24mm (1")	0.5 lbs (0.21Kg)
HE010A	144mm (5.7")	60mm (2.4")	185mm (7.3")	28mm (1.1")	0.9 lbs (0.42Kg)
HE020A	165mm (6.5")	88mm (3.5")	185mm (7.3")	30mm (1.2")	1.8 lbs (0.83Kg)
HE035A	210mm (8.3")	95mm (3.7")	260mm (10.2")	30mm (1.2")	3.2 lbs (1.5Kg)
HE055A	265mm (10.4")	115mm (4.5")	310mm (12.2")	35mm (1.2")	5 lbs (2.2Kg)

COMMERCIAL ANODES

HD56A

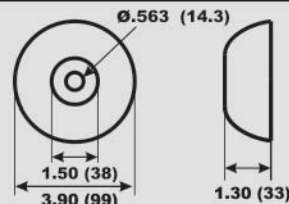

0.4 Kg Disc Anode

Weight: 1.0 lbs (0.45 Kg)

Replaces ZD56, AD56

HD77A 

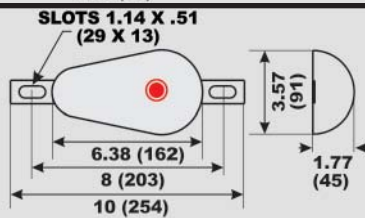

0.9 Kg Pear Strap Anode

Weight: 1.8 lbs (0.8 Kg)

Replaces ZD77

HD72BMA 

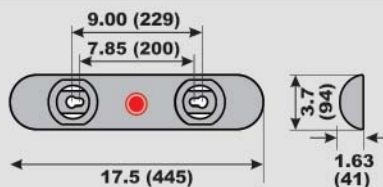









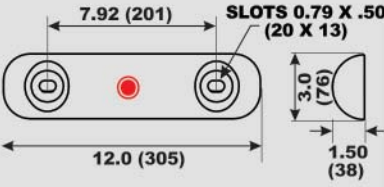

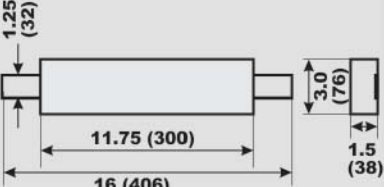

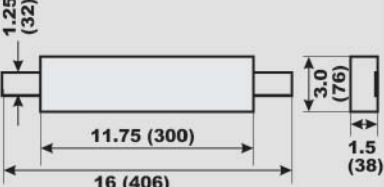

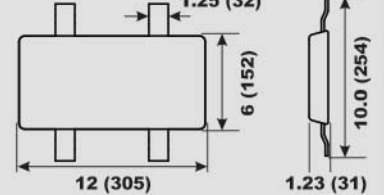
2.5 Kg Hull Anode

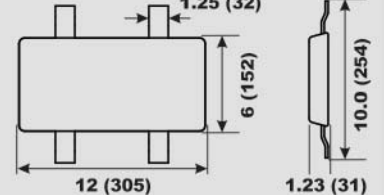
Weight: 4.5 lbs (2.5 Kg)

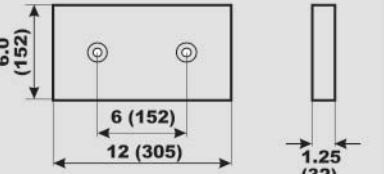
Replaces ZD72B

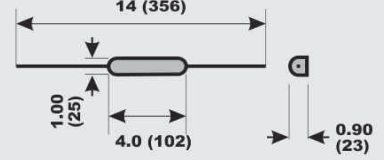
COMMERCIAL ANODES

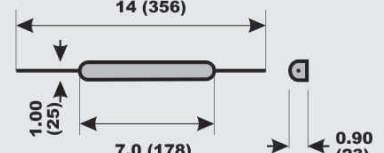
<p>HD78BA </p> 		<p>1.5 Kg Hull Anode Weight: 3.3 lbs (1.5 Kg) Replaces ZD78B</p>
<p>HA3A-S</p> 		<p>5 lb Strap Anode - Steel Strap Weight: 4.5 lbs (2 Kg) Replaces GA12, ZSS-12</p>
<p>HA3A-A</p> 		<p>5 lb Strap Anode - Aluminum Strap Weight: 4.5 lbs (2 Kg) Replaces GA12, ZSS-12</p>
<p>HS23A-S (AHS-10)</p> 		<p>10 lb Strap Anode - Steel Strap Weight: 8.7 lbs (4 Kg) Replaces GA23, ZHS-23, AZHS-23</p>
<p>HS23A-A</p> 		<p>10 lb Strap Anode - Aluminum Strap Weight: 8.7 lbs (4 Kg) Replaces GA23, ZHS-23, AZHS-23</p>
<p>HC23A (AHC-10)</p> 		<p>10 lb Hull Anode - w/ Bolt Holes Weight: 8.7 lbs (4 Kg) Replaces GA23C, ZHC-23, AZHC-23</p>
<p>CP1A</p> 		<p>Small Crab Pot Anode Weight: 0.3 lbs (0.15 Kg)</p>
<p>CP2A</p> 		<p>Large Crab Pot Anode Weight: 0.55 lbs (0.25 Kg)</p>

SHAFT ANODES - REDUCED CLEARANCE

IMPERIAL SIZES



Part #	A	B	C	Weight
RC0750A (C1)	3/4" (19mm)	2 1/8" (54mm)	1" (25.4mm)	0.26 lbs (0.12Kg)
RC0875A (C2)	7/8" (22mm)	2 1/8" (54mm)	1" (25.4mm)	0.26 lbs (0.12Kg)
RC1000A (C3)	1" (25.4mm)	2 1/2" (64mm)	1 1/4" (32mm)	0.44 lbs (0.2Kg)
RC1125A (C4)	1 1/8" (29mm)	2 1/2" (64mm)	1 1/4" (32mm)	0.39 lbs (0.18Kg)
RC1250A (C5)	1 1/4" (32mm)	2 1/2" (64mm)	1 1/4" (32mm)	0.38 lbs (0.17Kg)
RC1375A (C6)	1 3/8" (35mm)	3" (76mm)	1 1/4" (32mm)	0.58 lbs (0.26Kg)
RC1500A (C7)	1 1/2" (38mm)	3" (76mm)	1 1/4" (32mm)	0.52 lbs (0.24Kg)
RC1750A (C8)	1 3/4" (44mm)	3 1/2" (89mm)	1 3/8" (35mm)	0.82 lbs (0.37Kg)
RC2000A (C9)	2" (51mm)	3 1/2" (89mm)	1 3/8" (35mm)	0.7 lbs (0.32Kg)
RC2250A (C11)	2 1/4" (57mm)	3 1/2" (89mm)	1 3/8" (35mm)	0.64 lbs (0.3Kg)

METRIC SIZES

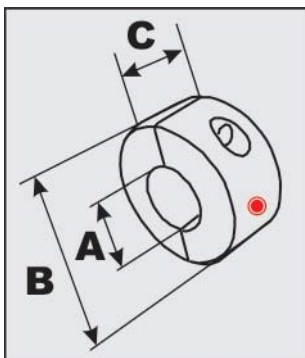

Part #	A	B	C	Weight
RCM20A	20mm (0.79")	2 1/8" (54mm)	1" (25.4mm)	0.26 lbs (0.12Kg)
RCM25A	25mm (0.98")	2 1/2" (64mm)	1 1/4" (32mm)	0.44 lbs (0.2Kg)
RCM30A	30mm (1.18")	2 1/2" (64mm)	1 1/4" (32mm)	0.37 lbs (0.17Kg)
RCM35A	35mm (1.37")	3" (76mm)	1 1/4" (32mm)	0.58 lbs (0.26Kg)
RCM40A	40mm (1.57")	3" (76mm)	1 1/4" (32mm)	0.52 lbs (0.24Kg)
RCM45A	45mm (1.77")	3 1/2" (89mm)	1 3/8" (35mm)	0.81 lbs (0.37Kg)
RCM50A	50mm (1.97")	3 1/2" (89mm)	1 3/8" (35mm)	0.7 lbs (0.32Kg)
RCM60A	60mm (2.36")	3 1/2" (89mm)	1 3/8" (35mm)	0.64 lbs (0.3Kg)

SHAFT ANODES - STREAMLINED COLLAR

IMPERIAL SIZES

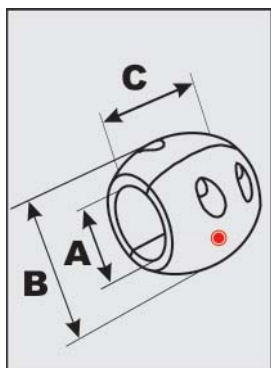

Part #	A	B	C	Weight
C0500A	½" (13mm)	2 1/8" (54mm)	2 1/8" (54mm)	0.49 lbs (0.22Kg)
C0625A	5/8" (16mm)	2 1/8" (54mm)	2 1/8" (54mm)	0.47 lbs (0.21Kg)
C0750A (X1)	¾" (19mm)	2 1/8" (54mm)	2 1/8" (54mm)	0.45 lbs (0.2Kg)
C0875A (X2)	7/8" (22mm)	2 1/8" (54mm)	2 1/8" (54mm)	0.43 lbs (0.2Kg)
C1000A (X3)	1" (25.4mm)	2 1/8" (54mm)	2 1/8" (54mm)	0.4 lbs (0.18Kg)
C1125A (X4)	1 1/8" (29mm)	2 1/8" (54mm)	2 1/8" (54mm)	0.36 lbs (0.16Kg)
C1250A (X5)	1 1/4" (32mm)	2 1/4" (57mm)	2 ½" (64mm)	0.46 lbs (0.21Kg)
C1250AA (Large)	1 1/4" (32mm)	2 ½" (64mm)	2 ½" (64mm)	0.66 lbs (0.3Kg)
C1375A (X6)	1 3/8" (35mm)	2 ½" (64mm)	2 ½" (64mm)	0.6 lbs (0.27Kg)
C1500A (X7)	1 ½" (38mm)	2 ½" (64mm)	2 ½" (64mm)	0.53 lbs (0.24Kg)
C1750A (X8)	1 3/4" (44mm)	3 1/4" (83mm)	2 7/8" (73mm)	1.15 lbs (0.52Kg)
C2000A (X9)	2" (51mm)	3 1/4" (83mm)	2 7/8" (73mm)	0.93 lbs (0.42Kg)
C2250A (X10)	2 1/4" (57mm)	4 1/4" (108mm)	3 3/4" (95mm)	2.47 lbs (1.1Kg)
C2500A (X11)	2 ½" (64mm)	4 1/4" (108mm)	3 3/4" (95mm)	2.23 lbs (1.0Kg)
C2750A (X12)	2 3/4" (70mm)	4 3/4" (121mm)	3 5/8" (92mm)	2.75 lbs (1.2Kg)
C3000A (X13)	3" (76mm)	4 3/4" (121mm)	3 5/8" (92mm)	2.4 lbs (1.1Kg)

SHAFT ANODES - REDUCED CLEARANCE

METRIC SIZES

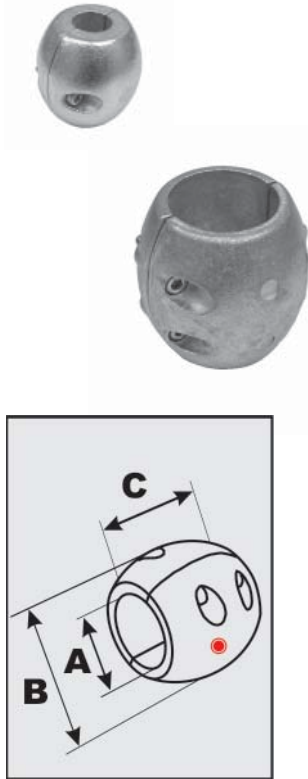

Part #	A	B	C	Weight
CM20A	20mm (0.79")	2 1/8" (54mm)	2 1/8" (54mm)	0.44 lbs (0.2Kg)
CM25A	25mm (0.98")	2 1/8" (54mm)	2 1/8" (54mm)	0.4 lbs (0.18Kg)
CM30A	30mm (1.18")	2 1/8" (54mm)	2 1/8" (54mm)	0.35 lbs (0.16Kg)
CM35A	35mm (1.37")	2 1/2" (64mm)	2 1/2" (64mm)	0.6 lbs (0.27Kg)
CM40A	40mm (1.57")	3 1/4" (83mm)	2 7/8" (73mm)	1.28 lbs (0.58Kg)
CM45A	45mm (1.77")	3 1/4" (83mm)	2 7/8" (73mm)	1.15 lbs (0.52Kg)
CM50A	50mm (1.97")	3 1/4" (83mm)	2 7/8" (73mm)	0.93 lbs (0.42Kg)
CM60A	60mm (2.36")	4 1/4" (108mm)	3 3/4" (95mm)	2.23 lbs (1.0Kg)
CM70A	70mm (2.76")	4 3/4" (121mm)	3 3/4" (95mm)	2.7 lbs (1.2Kg)

SHAFT ANODES - REDUCED CLEARANCE

RUDDER/TRIM TAB - DOUBLE and SINGLE

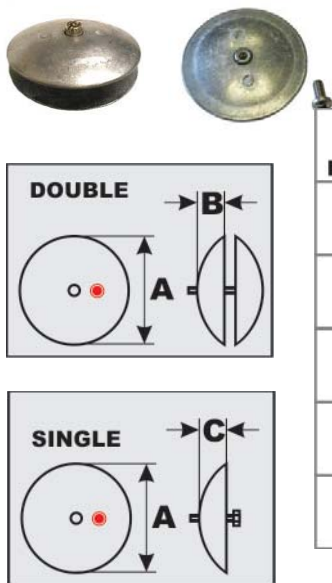

Part # DOUBLE	Part # SINGLE	A	B	Weight DOUBLE SINGLE
R1875A (R1)	RH1875A (R1)	1 7/8" (48mm)	1/4" (7mm)	0.1 lbs (0.03Kg) 0.05 lbs (0.02Kg)
R2813A (R2)	RH2813A (R2)	2 13/16" (72mm)	1/2" (13mm)	0.33 lbs (0.15Kg) 0.17 lbs (0.08Kg)
R3750A (R3)	RH3750A (R3)	3 3/4" (95mm)	1/2" (13mm)	0.6 lbs (0.27Kg) 0.3 lbs (0.14Kg)
R5000A (R4)	RH5000A (R4)	5" (127mm)	5/8" (16mm)	1.82 lbs (0.83Kg) 0.9 lbs (0.41Kg)
R6500A (R7)	RH6500A (R7)	6 1/2" (165mm)	7/8" (22mm)	3.6 lbs (1.63Kg) 1.8 lbs (0.82Kg)

NOTE: PART # R1875A HAS NO WEAR INDICATOR

BULK ALUMINUM ANODES



“Bulk” aluminum anodes are supplied without packaging, hardware or wear indicators as a low cost alternative to competitors’ zinc anodes. They are made to the same high quality and military spec. as our regular Navalloy® anodes.

Part #	Description	Weight
BOMBARDIER BULK ALUMINUM		
B-00141A	Side Mounted (123009/327606/173029)	0.10 lbs (0.05 Kg)
B-00142A	Transom (392462)	0.70 lbs (0.32 Kg)
B-00143A	Transom (433580)	0.70 lbs (0.32 Kg)
B-00144A	Front Gearcase (398873)	0.15 lbs (0.07 Kg)
B-00145A	Prop Shaft (431708)	0.20 lbs (0.09 Kg)
B-00151A	Rear Gearcase (397768)	0.30 lbs (0.14 Kg)
B-00152A	Front Gearcase (983494)	0.65 lbs (0.30 Kg)
B-00153A	Front Gearcase (984513/3853818)	0.90 lbs (0.41 Kg)
B-00154A	Transom Mount (984547)	0.75 lbs (0.34 Kg)
B-00155A	Rear Gearcase (398331)	0.30 lbs (0.14 Kg)
B-00192A	Front Gearcase (392123)	0.70 lbs (0.32 Kg)
B-00201A	Cobra Rear Gear Case (436745/393023)	0.20 lbs (0.09 Kg)
HONDA BULK ALUMINUM		
B-00044A	Trim Tab (41107-ZW1-003ZA)	0.40 lbs (0.18Kg)
B-00051A	Side Pocket Anode (41109-ZW1-003)	0.18 lbs (0.08 Kg)
B-00119A	Side Mounted (41106-935-812)	0.10 lbs (0.05 Kg)
B-00120A	Trim Tab (41107-ZV5-000)	0.30 lbs (0.14 Kg)

Part #	Description	Weight
MERCURY BULK ALUMINUM		
B-00041A	Cavitation Plate Alpha (821629T 1)	0.55 lbs (0.25 Kg)
B-00042A	Drive Trim Cylinder Alpha (806189T 1)	0.07 lbs (0.03 Kg)
B-00043A	Bearing Carrier Alpha (806105T 1)	0.17 lbs (0.08 Kg)
B-00044A	Trim Tab Anode (31640T 4)	0.40 lbs (0.18 Kg)
B-00045A	Gimbal Housing Block (821631T 1)	0.70 lbs (0.32 Kg)
B-00046A	Cavitation Plate Bravo (821630T 1)	0.80 lbs (0.36 Kg)
B-00047A	Drive Trim Cylinder Bravo (806190T 1)	0.27 lbs (0.12 Kg)
B-00048A	Bearing Carrier Bravo (806188A 1)	0.16 lbs (0.07 Kg)
B-00049A	Trim Tab Anode Flat (76214T 5)	0.25 lbs (0.11 Kg)
B-00050A	Gimbal Hsg Bolt Headnut (55989T 9)	0.15 lbs (0.07 Kg)
B-00051A	Side Pocket Anode (826134T)	0.18 lbs (0.08 Kg)
B-00052A	Power Trim Anode (818298T 1)	0.50 lbs (0.23 Kg)
B-00093A	Manifold Anode (880653)	0.48 lbs (0.22 Kg)
B-00094A	Trim Cylinder Verado (893404)	0.10 lbs (0.05 Kg)
B-00163A	Prop Anode (865182A 1)	0.40 lbs (0.18 Kg)
B-00196A	Prop Anode Retrofit	0.60 lbs (0.27 Kg)
B-00268A	Trim Tab Flat Recessed (76214 4)	0.25 lbs (0.11 Kg)

BULK ALUMINUM ANODES



Part #	Description	Weight
VOLVO BULK ALUMINUM		
B-00110A	Side Mounted - SX, DP-X (872793-5)	0.10 lbs (0.05 Kg)
B-00111A	Anodic Bar (832598-7)	0.80 lbs (0.36 Kg)
B-00112A	Anodic Bar (852835-8)	0.70 lbs (0.32 Kg)
B-00113A	Prop Ring - V15 (875810-4)	0.20 lbs (0.09 Kg)
B-00114A	Prop Ring - V17 (875806-4)	0.30 lbs (0.14 Kg)
B-00115A	Prop Ring - V16 (875810-4)	0.20 lbs (0.09 Kg)
B-00116A	Prop Ring - Duo Prop	0.50 lbs (0.23 Kg)
B-00117A	Gimbal Plate - SX (3854130)	1.00 lbs (0.45 Kg)
B-00118A	Anodic Bar (872139)	0.60 lbs (0.27 Kg)
B-00156A	Transom DPS-A/SX-A (3841427/3888816)	1.10 lbs (0.50 Kg)
B-00157A	Gearhouse DPS-A/SX-A (3883728/3888813)	1.50 lbs (0.70 Kg)
B-00158A	DPX Outdrive Cube (873395)	0.30 lbs (0.15 Kg)
B-00160A	Prop Ring - 110 Sail Drive (875812)	0.80 lbs (0.36 Kg)
B-00161A	Prop Ring - V18 (875815)	0.60 lbs (0.27 Kg)
B-00162A	Transom Plate - SX (3855411)	0.90 lbs (0.41 Kg)
B-00218A	Cavitation Plate - DPH/DPR	0.90 lbs (0.41 Kg)
B-00219A	Transom Shield - SX (3855411)	0.90 lbs (0.41 Kg)

Part #	Description	Weight
YAMAHA BULK ALUMINUM		
B-00119A	Side Mounted (6E0-45251-11)	0.10 lbs (0.05 Kg)
B-00120A	Trim Tab (664-45371-01)	0.30 lbs (0.14 Kg)
B-00121A	Trim Tab (6K1-45371-00)	0.40 lbs (0.18 Kg)
B-00122A	Trim Tab (6E5-45371-01)	0.40 lbs (0.18 Kg)
B-00123A	Trim Tab (688-45371-02)	0.40 lbs (0.18 Kg)
B-00124A	Block (6E5-45251-00)	0.15 lbs (0.07 Kg)
B-00125A	Trim Tab (6J9-45371-01)	0.60 lbs (0.27 Kg)
B-00126A	Transom (6H1-45251-02)	0.45 lbs (0.20 Kg)
B-00127A	Transom (6G5-45251-02)	0.80 lbs (0.36 Kg)
B-00128A	Block (688-45251-01)	0.04 lbs (0.02 Kg)
B-00180A	Trim Tab 200, 225, 250 4 stroke (61A-45371-00)	0.60 lbs (0.27 Kg)
B-00181A	Trim Tab 150 HP ctr rot (6K1-45371-02)	0.60 lbs (0.27 Kg)
B-00185A	Trim Tab 200-300hp 2 Stroke (69L-45371-00)	0.80 lbs (0.36 Kg)

ENGINE COOLING PENCIL ANODES

SecureCore®

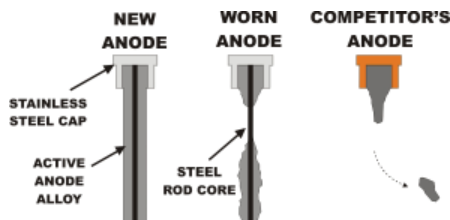

SecureCore anodes have a central core which prevents a wasted end from falling off and blocking water-ways etc.



ANODE ONLY

Part #		Dia.	Length	Thread UNC
AE-0	in	3/8	1 3/4	5/16-18
	mm	9.5	44.5	
AE-0A	in	3/8	2 1/2	5/16-18
	mm	9.5	63.5	
AE-0B	in	3/8	3/4	5/16-18
	mm	9.5	19.1	
AE-1	in	1/2	2	3/8-16
	mm	12.7	50.8	
AE-1D	in	1/2	1 3/4	3/8-16
	mm	12.7	44.5	
AE-1E	in	1/2	1 1/2	3/8-16
	mm	12.7	38.1	
AE-1F	in	1/2	1 1/4	3/8-16
	mm	12.7	31.8	
AE-1G	in	1/2	1	3/8-16
	mm	12.7	25.4	
AE-1H	in	1/2	1 5/8	3/8-16
	mm	12.7	41.3	
AE-1J	in	1/2	5/8	3/8-16
	mm	12.7	15.9	
AE-2	in	5/8	2	7/16-14
	mm	15.9	50.8	
AE-2A	in	5/8	1 1/4	7/16-14
	mm	15.9	31.8	
AE-2B	in	5/8	3	7/16-14
	mm	15.9	76.2	
AE-2D	in	5/8	1 3/4	7/16-14
	mm	15.9	44.5	
AE-3	in	3/4	2	1/2-13
	mm	19.1	50.8	
AE-3A	in	3/4	3/4	1/2-13
	mm	19.1	19.1	
AE-4	in	3/4	3 3/8	1/2-13
	mm	19.1	85.8	
AE-5	in	3/4	3 5/8	1/2-13
	mm	19.1	92.1	
AE-6	in	3/4	4 3/4	1/2-13
	mm	19.1	120.7	

Part #		Dia.	Length	Thread UNC
AE-6A	in	13/16	7	1/2-13
	mm	20.6	177.9	
AE-7	in	1 1/16	5	3/4-10
	mm	27.0	127.1	
AE-7A	in	1 1/16	10	3/4-10
	mm	27.0	254.1	
AE-7B	in	1	14	3/4-10
	mm	25.4	355.7	
AE-7D	in	1	16	3/4-10
	mm	25.4	406.6	
AE-8	in	1 1/4	2 5/16	3/4-10
	mm	31.8	58.8	
AE-8A	in	1 1/16	6	3/4-10
	mm	27.0	152.5	
AE-8B	in	1 1/16	10	3/4-10
	mm	27.0	254.1	
AE-8D	in	1 1/4	2 1/8	3/4-10
	mm	31.8	54.0	
AE-8E	in	1	14	3/4-10
	mm	25.4	355.7	
AE-8F	in	1	16	3/4-10
	mm	25.4	406.6	
A 6L2016	in	3/4	3/4	1/2-13
	mm	19.1	19.1	
A 6L2280	in	1/2	1 5/8	3/8-16
	mm	12.7	41.3	
A 6L2283	in	3/8	2 1/2	5/16-18
	mm	9.5	63.5	
A 6L2284	in	1 1/4	2 1/8	3/4-10
	mm	31.8	54.0	
A 6L2285	in	1 1/4	2 1/3	3/4-10
	mm	31.8	58.8	
A 6L2288	in	5/8	2 1/2	3/8-16
	mm	15.9	63.5	
A 6L2289	in	5/8	3	7/16-14
	mm	15.9	76.2	
A 6L3104 (AE-0C)	in	3/8	1 1/2	1/4-20
	mm	9.5	38.1	

ENGINE COOLING PENCIL ANODES

SecureCore®



SecureCore® anodes are made from aluminum alloy which is more active and longer lasting than zinc. It is suitable for use in all types of water. It is a better alloy in hot water than zinc. The plugs are made from 304

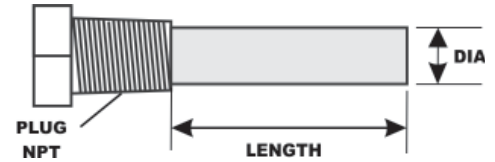

COMPLETE ANODE WITH PLUG

Part #		Dia.	Length	Plug NPT
CE-0	in	3/8	1 3/4	1/4
	mm	9.5	44.5	
CE-0A	in	3/8	2 1/2	1/4
	mm	9.5	63.5	
CE-0B	in	3/8	3/4	1/4
	mm	9.5	19.1	
CE-1	in	1/2	2	3/8
	mm	12.7	50.8	
CE-1D	in	1/2	1 3/4	3/8
	mm	12.7	44.5	
CE-1E	in	1/2	1 1/2	3/8
	mm	12.7	38.1	
CE-1F	in	1/2	1 1/4	3/8
	mm	12.7	31.8	
CE-1G	in	1/2	1	3/8
	mm	12.7	25.4	
CE-1H	in	1/2	1 5/8	3/8
	mm	12.7	41.3	
CE-1J	in	1/2	5/8	3/8
	mm	12.7	15.9	
CE-2	in	5/8	2	1/2
	mm	15.9	50.8	
CE-2A	in	5/8	1 1/4	1/2
	mm	15.9	31.8	
CE-2B	in	5/8	3	1/2
	mm	15.9	76.2	
CE-2D	in	5/8	1 3/4	1/2
	mm	15.9	44.5	
CE-3	in	3/4	2	3/4
	mm	19.1	50.8	
CE-3A	in	3/4	3/4	3/4
	mm	19.1	19.1	
CE-4	in	3/4	3 3/8	3/4
	mm	19.1	85.8	
CE-5	in	3/4	3 5/8	3/4
	mm	19.1	92.1	
CE-6	in	3/4	4 3/4	3/4
	mm	19.1	120.7	

Part #		Dia.	Length	Plug NPT
CE-6A	in	13/16	7	3/4
	mm	20.6	177.9	
CE-7	in	1 1/16	5	1
	mm	27.0	127.1	
CE-7A	in	1 1/16	10	1
	mm	27.0	254.1	
CE-7B	in	1	14	1
	mm	25.4	355.7	
CE-7D	in	1	16	1
	mm	25.4	406.6	
CE-8	in	1 1/4	2 5/16	1 1/4
	mm	31.8	58.8	
CE-8A	in	1 1/16	6	1 1/4
	mm	27.0	152.5	
CE-8B	in	1 1/16	10	1 1/4
	mm	27.0	254.1	
CE-8D	in	1 1/4	2 1/8	1 1/4
	mm	31.8	54.0	
CE-8E	in	1	14	1 1/4
	mm	25.4	355.7	
CE-8F	in	1	16	1 1/4
	mm	25.4	406.6	
C 6L2016	in	3/4	3/4	3/4
	mm	19.1	19.1	
C 6L2280	in	1/2	1 5/8	3/8
	mm	12.7	41.3	
C 6L2283	in	3/8	2 1/2	1/4
	mm	9.5	63.5	
C 6L2284	in	1 1/4	2 1/8	1 1/4
	mm	31.8	54.0	
C 6L2285	in	1 1/4	2 1/3	1 1/4
	mm	31.8	58.8	
C 6L2288	in	5/8	2 1/2	1/2
	mm	15.9	63.5	
C 6L2289	in	5/8	3	1/2
	mm	15.9	76.2	
C 6L3104 (CE-0C)	in	3/8	1 1/2	1/4
	mm	9.5	38.1	