



QUALITY MARINE
EQUIPMENT SINCE 1981

PACKLESS SEALING SYSTEM SHAFT SEAL



MARINE APPLICATIONS

MILITARY



SAILBOATS



WORK BOATS



FERRIES



SKI & WAKEBOARD



POWER BOATS



INDUSTRIAL APPLICATIONS

LARGE COOLING PUMPS



MIXING TANKS



PUMPS



TABLE OF CONTENTS

Overview	1 - 2
Type A Seals	3
Shafts $\frac{3}{4}$ " - $3\frac{3}{4}$ " (20mm - 95mm)	
PRO Seals	4
Shafts $1\frac{1}{4}$ " - $3\frac{3}{4}$ " (32mm - 95mm)	
Type B Seals	5
Shafts 4" - 6" (100mm - 150mm)	
Rudder Seals	6
Flange & Bladder System	7 - 8
Accessories	9
Installation Examples	10
Industrial Applications	11
FAQ's	12

OVERVIEW |



The Packless Sealing System (PSS) Shaft Seal is a mechanical face seal created between a rotating stainless steel rotor and a stationary carbon stator. The carbon stator is attached to a convoluted rubber bellow and the back of the bellow is attached to the shaft log (stern-tube) of the boat with hose clamps. During installation, the stainless steel rotor is used to compress the convoluted bellow. The rotor is then secured to the shaft. The compression of the bellow allows the seal faces to remain in constant contact while compensating for the fore-and-aft movement of the shaft caused by the propellers thrust pushing on the engine mounts. The carbon stator is bored slightly larger than the shaft diameter, allowing it to "float" around the shaft and compensate for most misalignment and vibration problems. The stainless steel rotor is sealed to the shaft with o-rings. These o-rings rotate with the shaft and rotor and do not experience any wear during operation. This static o-ring seal enables the PSS Shaft Seal to be fit on shafts that have some wear or pitting, unlike lip seal designs which require a clean area for the lip seal to ride on. This type of carbon face seal is not as sensitive to interruption of water flow or operation in silty water, when compared to other sealing options.

TYPE A

For shafts 3/4" - 3 3/4"

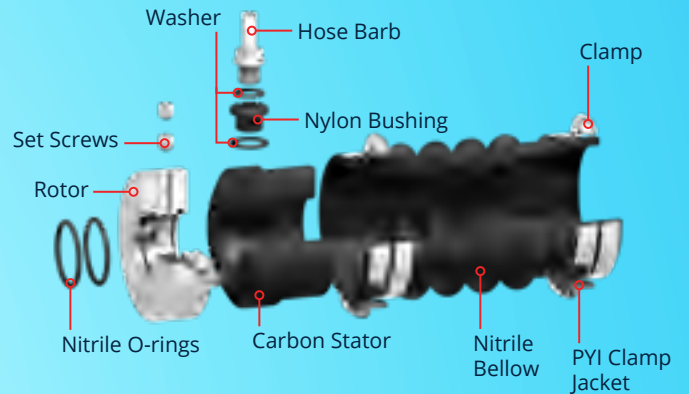

PRO SEAL

For shafts 1 1/4" - 3 3/4"

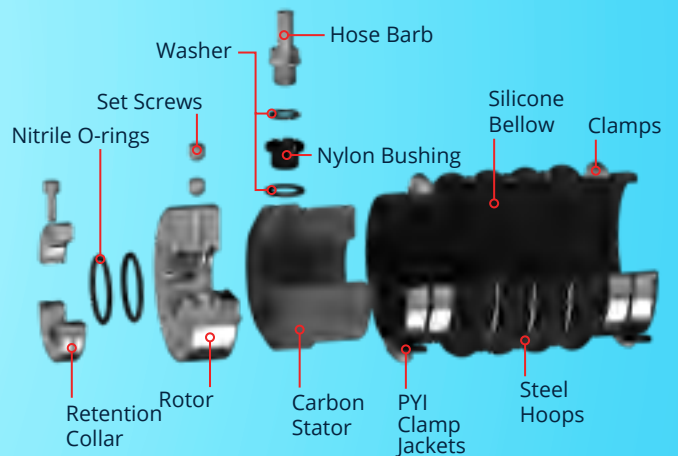

CERTIFICATIONS



The PSS Shaft Seal is Bureau Veritas, ABS & RINA certified.

TYPE B

For shafts 4" - 6"

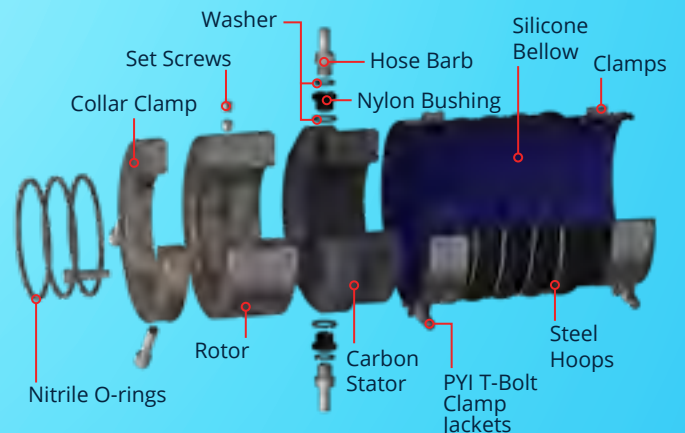

COMPONENTS

Main components of a PSS Shaft Seal



TYPE A SEAL



STAINLESS STEEL ROTOR

The rotor is manufactured out of 316L stainless steel and machined to a 9Ra finish on precision CNC lathes. It is secured on the shaft using 2 pairs of set screws positioned at 90 degrees angle for maximum holding power. The carbon stator further polishes the rotor during the initial hours of operations. This rotor does not need replacement or maintenance under normal operating conditions.



CARBON STATOR

The high density, resin impregnated carbon stator is manufactured from a space age composite which is first mixed and molded, then formed under pressure. The blank parts are then baked, machined and lapped to a measured flatness of 4 helium light bands (measured at 0.000044" of variation over its entire lapped surface). The grade of carbon composite used in the PSS Shaft Seal has a maximum operating temperature of 50° F (+260° C) and cannot melt if the seal runs dry for a short period of time unlike a lip seal or a plastic face seal. The high density of the carbon greatly increases the longevity and wear resistance. Several commercial vessels have recorded over 40,000 (over 4-1/2 years of continuous operation) engine hours on the same, original components. The carbon should not need to be replaced under normal operating conditions.



BELLOW

The bellow on the Type A seal is molded out of a Nitrile compound. Nitrile is known for its good resistance to petroleum products. It provides the best combination of durability, strength and elasticity necessary in this application.

PRO SEAL



STAINLESS STEEL ROTOR

The rotor on the PRO seal is manufactured out of 316L stainless steel and machined to a 9Ra finish on precision CNC lathes. It is secured on the shaft using 2 pairs of set screws positioned at 90 degrees angle in addition, a locking collar is placed in front of the rotor and further retains the propeller or rudder shaft in case of catastrophic failure of the coupling or if the shaft comes free from the coupling. As on the Type A seal the carbon stator further polishes the rotor during the initial hours of operations. This rotor does not need replacement under normal operating conditions.



BELLOW

The bellow on both the PRO and Type B PSS seal is constructed out of high temp silicone laminated with either 4 or 5 plies of polyester fabric (aramid in larger sizes) and covered with a layer of fluorosilicone. In addition both ends of the bellow are sealed so no water can get in the polyester/Aramid fabric. The 4 or 5 fabric inlay provides excellent strength to abrasion and resistance to pressure without loading the silicone. On the larger models, the strength is greatly increased by the use of stainless steel hoops laid into the convolutions of the bellow.

TYPE B SEAL



STAINLESS STEEL ROTOR

The rotor on the Type B seal is manufactured out of Nitronic 50 stainless alloy machined to a 9Ra finish on precision CNC lathes. It is secured on the shaft with large locking collar placed in front of the rotor. This collar (clamp) has a dual purpose: It secures the rotor in place on the shaft and is used as a tool during installation. As on all the PSS seal family, the carbon stator further polishes the rotor during the initial hours of operations. The Nitronic 50 material is a very high grade of stainless steel which is almost totally corrosion resistant. This rotor does not need replacement under normal operating conditions.



TYPE A SEAL

For shafts
3/4" to 3 3/4" (20mm - 95mm) diameters



- For power and sailboats, for shafts up to 3 3/4" (95mm).
- The Type A Seal is our most common product, with over 200,000 units in operation all over the world. This seal will satisfy most applications for pleasure boats and smaller commercial boats.

BEFORE ORDERING ANY PSS SHAFT SEAL

1. You will need to know your shaft diameter.
2. You will need to know your stern tube (shaft log) diameter.
3. Check fore and aft pace availability.



* A Hose Barb is recommended for vessels exceeding 10 knots.

TECHNICAL SPECIFICATIONS

Temperature Limits	5 to 225°F (-15 to 107°C)
Pressure Limits	15 PSI (1 BAR)
Shaft RPM Limits	10,000 RPM
Carbon Graphite	Lapped to 4 HLB (0.000044" tolerance)
316 SS / Nitronic 50	Faced to 9 Ra
Bellow Material	Molded Nitrile - PVC

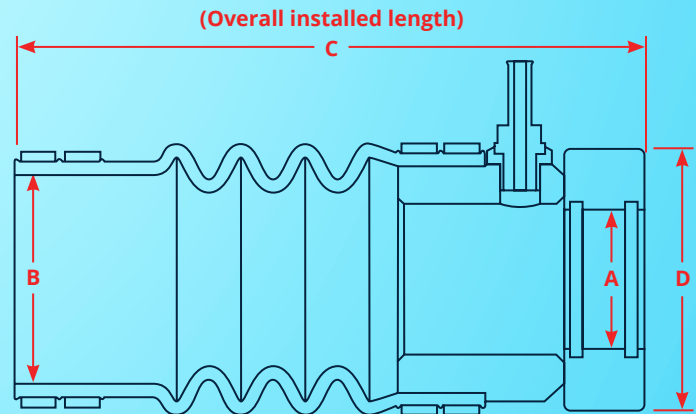

IMPERIAL SIZES

SHAFT DIAMETER (A)	STERN TUBE DIAMETER (B)	APPROX. COMPRESSED LENGTH (C)	D
3/4", 7/8", 1", 1 1/8"	1 1/4", 1 1/2", 1 3/4", 2", 2 1/4"	6.00" - 6.125"	2.375"
	2 1/2"	6.625"	2.375"
1 1/4", 1 3/8"	1 3/4", 2", 2 1/4", 2 1/2"	6.625" - 6.75"	2.875"
	2 3/4", 3", 3 1/4", 3 1/2"	8.125" - 8.313"	2.875"
1 1/2", 1 5/8", 1 3/4", 2"	2", 2 1/4", 2 1/2", 2 3/4", 3", 3 1/4", 3 1/2"	8.00" - 8.218"	3.75"
	3 3/4", 4"	8.405"	3.75"
2 1/4", 2 1/2"	3 1/4", 3 1/2", 3 3/4", 4"	8.625"	4.20"
	4 1/4", 4 1/2", 4 3/4", 5"	9.25"	4.20"
2 3/4", 3"	4", 4 1/4", 4 1/2", 4 3/4", 5"	9.125" - 9.313"	5.00"
	5 1/4", 5 1/2", 5 3/4", 6"	9.25" - 9.438"	5.00"
3 1/4", 3 1/2", 3 5/8", 3 3/4"	4 1/2", 4 3/4", 5", 5 1/4", 5 1/2", 5 3/4", 6"	9.675" - 9.863"	6.00"

METRIC SIZES (mm)

SHAFT DIAMETER (A)	STERN TUBE DIAMETER (B)	APPROX. COMPRESSED LENGTH (C)	D
20, 22, 25, 28, 30	30, 40, 45, 50, 60	152 - 156	61
	65	168	61
32, 35	45, 50, 60, 65	168 - 172	73
	70, 80, 85, 90	206 - 211	73
38, 40, 45, 50, 55	50, 60, 65, 70, 75, 80, 85, 90	203 - 209	96
	95, 100	213	96
60, 65	85, 90, 95, 100	219 - 224	107
	110, 115, 120, 125	235	107
70, 75, 80	100, 110, 115, 120, 125	231 - 237	127
	135, 140, 145, 150	235 - 240	127
85, 90, 95	115, 120, 125, 130, 135, 140, 145, 150	245 - 250	153

DETERMINE YOUR PSS TYPE A SHAFT SEAL PART

EXAMPLES ▼

Imperial Sizes

If Shaft diameter: 3/4"

If Stern Tube diameter: 1 1/2"

02-____-____

└─── Shaft diameter

Then: 02-034-112 ← Stern tube diameter

Metric Sizes

If Shaft diameter: 115mm

If Stern Tube diameter: 140mm

02-____M-____

└─── Shaft diameter

Then: 02-115M-512 ← Stern tube diameter

Converting mm to inches

Divide by 25.4 to convert to inches.

(Round up or down to the closest 1/4")

Example: 140 ÷ 25.4 = 5.511 = 5 1/2" stern tube

PRO SEAL

For shafts
1¼" to 3¾" (32mm - 95mm) diameters



- For commercial boats, for shafts 1¼" to 3¾" (32mm to 95mm).
- The "PRO" model, is manufactured with commercial applications in mind.



* Steel hoops come standard on 2¼" shaft diameters and up.

** PRO Seals use 316SS hose clamps with rolled edges and non-perforated band.

TECHNICAL SPECIFICATIONS

Temperature Limits	-13 to 425°F (-25 to 220°C)
Pressure Limits	40 PSI (2.75 BAR)
Shaft RPM Limits	10,000 RPM
Carbon Graphite	Lapped to 4 HLB (0.000044" tolerance)
316 SS / Nitronic 50	Faced to 9 Ra
Bellow Material	Mandrel formed silicone / fabric

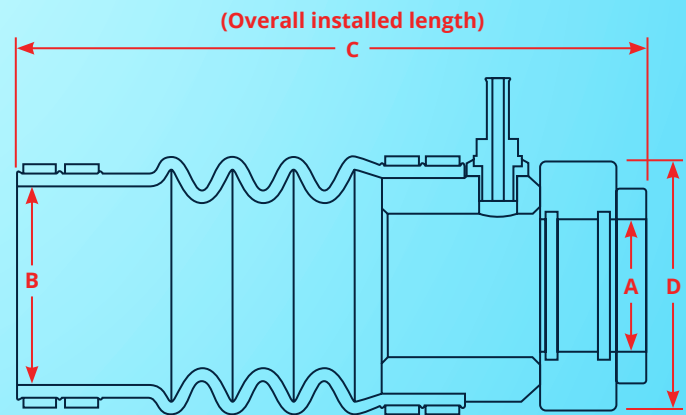

IMPERIAL SIZES

SHAFT DIAMETER (A)	STERN TUBE DIAMETER (B)	APPROX. COMPRESSED LENGTH (C)	D
1¼", 1¾"	1¾", 2", 2¼", 2½"	8.055" - 8.180"	2.875"
	2¾", 3", 3¼", 3½"	9.555" - 9.743"	2.875"
1½", 1¾", 1¾", 2"	2", 2¼", 2½", 2¾", 3", 3¼", 3½"	7.842" - 8.3305"	3.75"
	3¾", 4"	7.842" - 8.3305"	3.75"
2¼", 2½"	3¼", 3½", 3¾", 4"	8.675"	4.20"
	4¼", 4½", 4¾", 5"	8.800" - 9.670"	4.20"
2¾", 3"	4", 4¼", 4½", 4¾", 5"	8.800" - 9.988"	5.00"
	5¼", 5½", 5¾", 6"	8.800" - 9.988"	5.00"
3¼", 3½", 3¾", 3¾"	4½", 4¾", 5", 5¼", 5½", 5¾", 6"	9.350" - 11.300"	6.00"

METRIC SIZES (mm)

SHAFT DIAMETER (A)	STERN TUBE DIAMETER (B)	APPROX. COMPRESSED LENGTH (C)	D
32, 35	45, 50, 60, 65	8.055" - 8.180"	73
	70, 80, 85, 90	9.555" - 9.743"	73
38, 40, 45, 50, 55	50, 60, 65, 70, 75, 80, 85, 90	7.842" - 8.3305"	96
	95, 100	7.842" - 8.3305"	96
60, 65	85, 90, 95, 100	8.675"	107
	110, 115, 120, 125	8.800" - 9.670"	107
70, 75, 80	100, 110, 115, 120, 125	8.800" - 9.988"	127
	135, 140, 145, 150	8.800" - 9.988"	127
85, 90, 95	115, 120, 125, 130, 135, 140, 145, 150	9.350" - 11.300"	153

DETERMINE YOUR PSS PRO SHAFT SEAL PART

EXAMPLES ▼

Imperial Sizes

If Shaft diameter: ¾"

If Stern Tube diameter: 1½"

03-____-____

← Shaft diameter

Then: 03-034-112 ← Stern tube diameter

Metric Sizes

If Shaft diameter: 115mm

If Stern Tube diameter: 140mm

03-__M-__

← Shaft diameter

Then: 03-115M-512 ← Stern tube diameter

Converting mm to inches

Divide by 25.4 to convert to inches.

(Round up or down to the closest ¼")

Example: 140 ÷ 25.4 = 5.511 = 5½" stern tube

TYPE B SEAL

For shafts
4" to 6" (100mm - 150mm) diameters



- For large commercial boats, for shafts 4" to 6" (100mm to 150mm).
- Proven for over 20 years, the Type B Seal is a work horse for the commercial boat industry.



TECHNICAL SPECIFICATIONS

Temperature Limits	-13 to 425°F (-25 to 220°C)
Pressure Limits	50 PSI (3.5 BAR)
Shaft RPM Limits	7,000 RPM
Carbon Graphite	Lapped to 4 HLB (0.000044" tolerance)
316 SS / Nitronic 50	Faced to 9 Ra
Bellow Material	Mandrel formed silicone / fabric

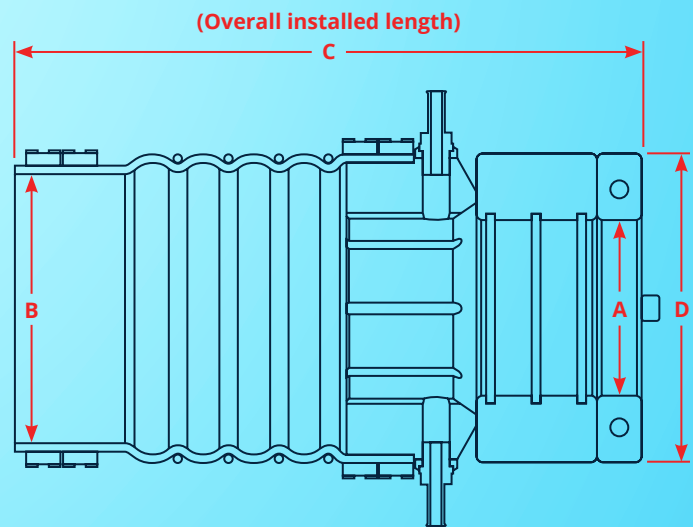

IMPERIAL SIZES

SHAFT DIAMETER (A)	STERN TUBE DIAMETER (B)	APPROX. COMPRESSED LENGTH (C)	D
4", 4¼"	5½", 5¾", 6", 6¼", 6½", 6¾", 7"	12.189"	7"
4½"	5½", 5¾", 6", 6¼", 6½", 6¾", 7"	12.189"	7.875"
4¾", 5", 5½"	6½", 6¾", 7", 7¼", 7½", 7¾", 8", 8⅝"	12.920" - 12.742"	7.875"
6"	6½", 6¾", 7", 7¼", 7½", 7¾", 8", 8⅝"	12.920" - 13.250"	8.875"

METRIC SIZES (mm)

SHAFT DIAMETER (A)	STERN TUBE DIAMETER (B)	APPROX. COMPRESSED LENGTH (C)	D
100, 105, 110	140, 145, 150, 160, 165, 170, 180	310	178
115	140, 145, 150, 160, 165, 170, 180	310	201
120, 130, 140	165, 170, 180, 185, 190, 195, 205, 220	315 - 324	201
150	165, 170, 180, 185, 190, 195, 205, 220	328 - 337	226

DETERMINE YOUR PSS TYPE B SHAFT SEAL PART

EXAMPLES ▼

Imperial Sizes

If Shaft diameter: ¾"

If Stern Tube diameter: 1½"

02-____-____

← Shaft diameter

Then: 02-034-112 ← Stern tube diameter

Metric Sizes

If Shaft diameter: 115mm

If Stern Tube diameter: 140mm

02-____M-____

← Shaft diameter

Then: 02-115M-512 ← Stern tube diameter

Converting mm to inches

Divide by 25.4 to convert to inches.

(Round up or down to the closest ¼")

Example: 140 ÷ 25.4 = 5.511 = 5½" stern tube

RUDDER SEAL

For shafts
1¼" to 6" (32mm - 150mm) diameters



- For commercial and pleasure boats, for shafts ¾" to 6" (20mm to 150mm).

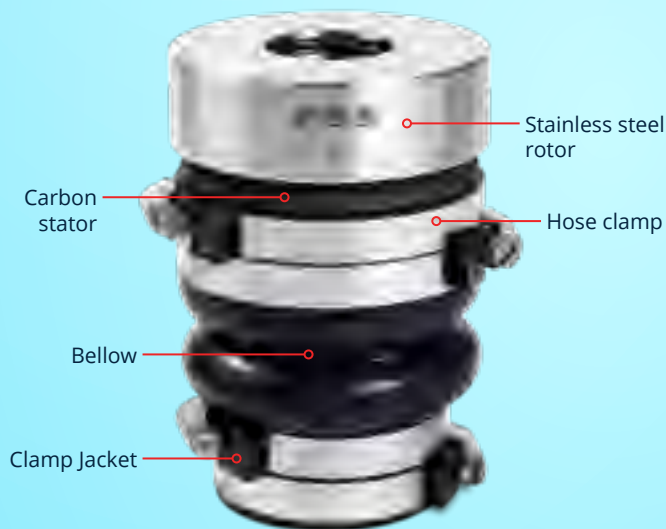

TECHNICAL SPECIFICATIONS

Temperature Limits	5 to 225°F (-15 to 107°C)
Pressure Limits	15 PSI (1 BAR)
Shaft RPM Limits	10,000 RPM
Carbon Graphite	Lapped to 4 HLB (0.000044" tolerance)
316 SS / Nitronic 50	Faced to 9 Ra
Bellow Material	Molded Nitrile - PVC

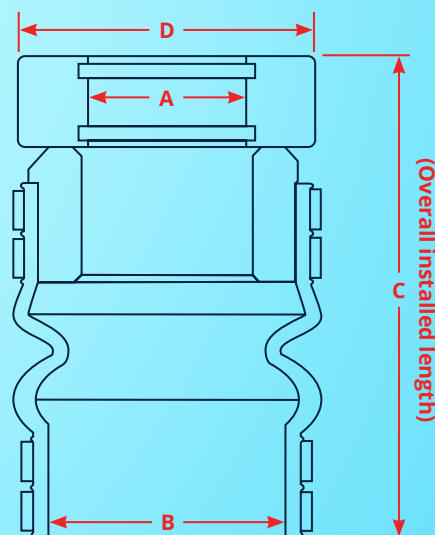

IMPERIAL SIZES

SHAFT DIAMETER (A)	STERN TUBE DIAMETER (B)	APPROX. COMPRESSED LENGTH (C)	D
1¼", 1¾"	1¾", 2", 2¼", 2½"	6.625" - 6.75"	2.875"
	2¾", 3", 3¼", 3½"	8.125" - 8.313"	2.875"
1½", 1⅞", 1¾", 2"	2", 2¼", 2½", 2¾", 3", 3¼", 3½"	8.00" - 8.218"	3.75"
	3¾", 4"	8.405"	3.75"
2¼", 2½"	3¼", 3½", 3¾", 4"	8.625"	4.20"
	4¼", 4½", 4¾", 5"	9.25"	4.20"
2¾", 3"	4", 4¼", 4½", 4¾", 5"	9.125" - 9.313"	5.00"
	5¼", 5½", 5¾", 6"	9.25" - 9.438"	5.00"
3¼", 3½", 3⅞", 3¾"	4½", 4¾", 5", 5¼", 5½", 5¾", 6"	9.675" - 9.863"	6.00"
4", 4¼"	5½", 5¾", 6", 6¼", 6½", 6¾", 7"	12.189"	7"
4½"	5½", 5¾", 6", 6¼", 6½", 6¾", 7"	12.189"	7.875"
4¾", 5", 5½"	6½", 6¾", 7", 7¼", 7½", 7¾", 8", 8⅝"	12.920" - 12.742"	7.875"
6"	6½", 6¾", 7", 7¼", 7½", 7¾", 8", 8⅝"	12.920" - 13.250"	8.875"

METRIC SIZES (mm)

SHAFT DIAMETER (A)	STERN TUBE DIAMETER (B)	APPROX. COMPRESSED LENGTH (C)	D
32, 35	45, 50, 60, 65	168 - 172	73
	70, 80, 85, 90	206 - 211	73
38, 40, 45, 50, 55	50, 60, 65, 70, 75, 80, 85, 90	203 - 209	96
	95, 100	213	96
60, 65	85, 90, 95, 100	219 - 224	107
	110, 115, 120, 125	235	107
70, 75, 80	100, 110, 115, 120, 125	231 - 237	127
	135, 140, 145, 150	235 - 240	127
85, 90, 95	115, 120, 125, 130, 135, 140, 145, 150	245 - 250	153
100, 105, 110	140, 145, 150, 160, 165, 170, 180	310	178
115	140, 145, 150, 160, 165, 170, 180	310	201
120, 130, 140	165, 170, 180, 185, 190, 195, 205, 220	315 - 324	201
150	165, 170, 180, 185, 190, 195, 205, 220	328 - 337	226

FLANGE & BLADDER SYSTEM |

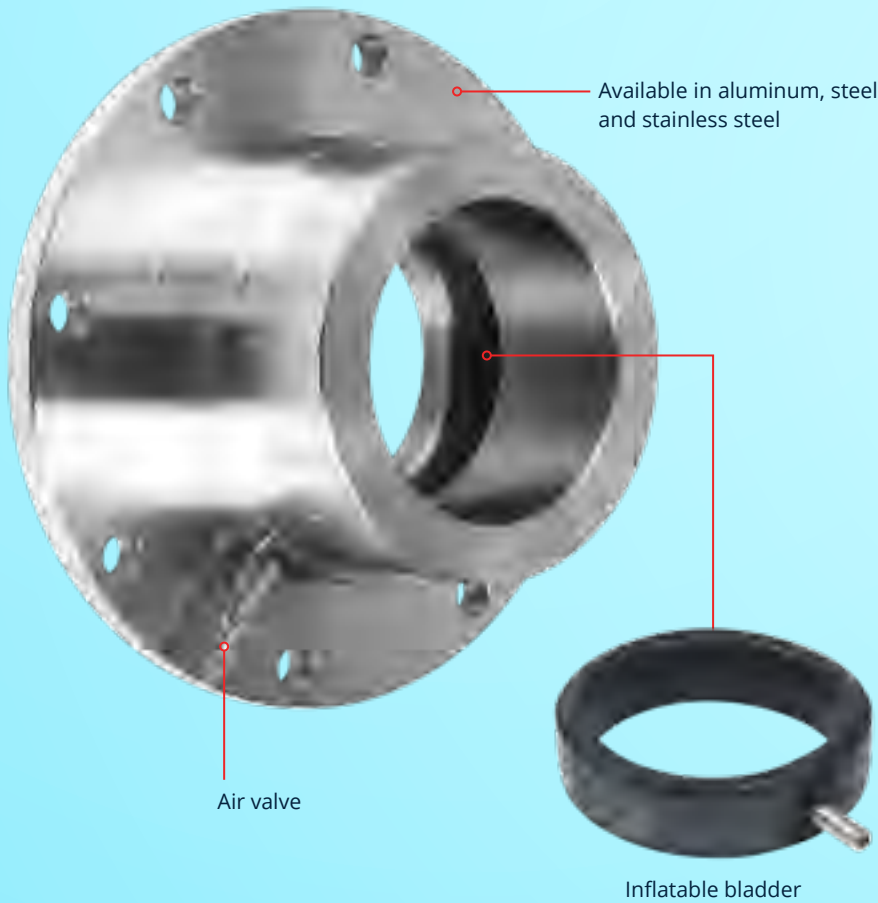

A large number of commercial vessels are manufactured with a multi bolt flange in lieu of a stern tube. Often, these flanges have a standard bolt pattern. In order to facilitate the installation of the PSS Shaft Seals on boats with these type of flanges, PYI manufactures an array of flanges which fit the "standard" bolt patterns and transform the flange into a stern tube ready to accept the PSS Shaft Seal. These adapters can be ordered as a "standard unit" or as a "inflatable bladder unit". The inflatable bladder option allows the operator to seal the stern tube, while the shaft is not rotating, in order to inspect or clean the seal. In addition, if the uncoupling of the shaft is needed, this operation can be done in the water as the shaft can be moved aft with the bladder inflated with no water intrusion occurring. This inflatable bladder can also be used in case of an emergency.

CROSS SECTION OF FLANGE & BLADDER SYSTEM

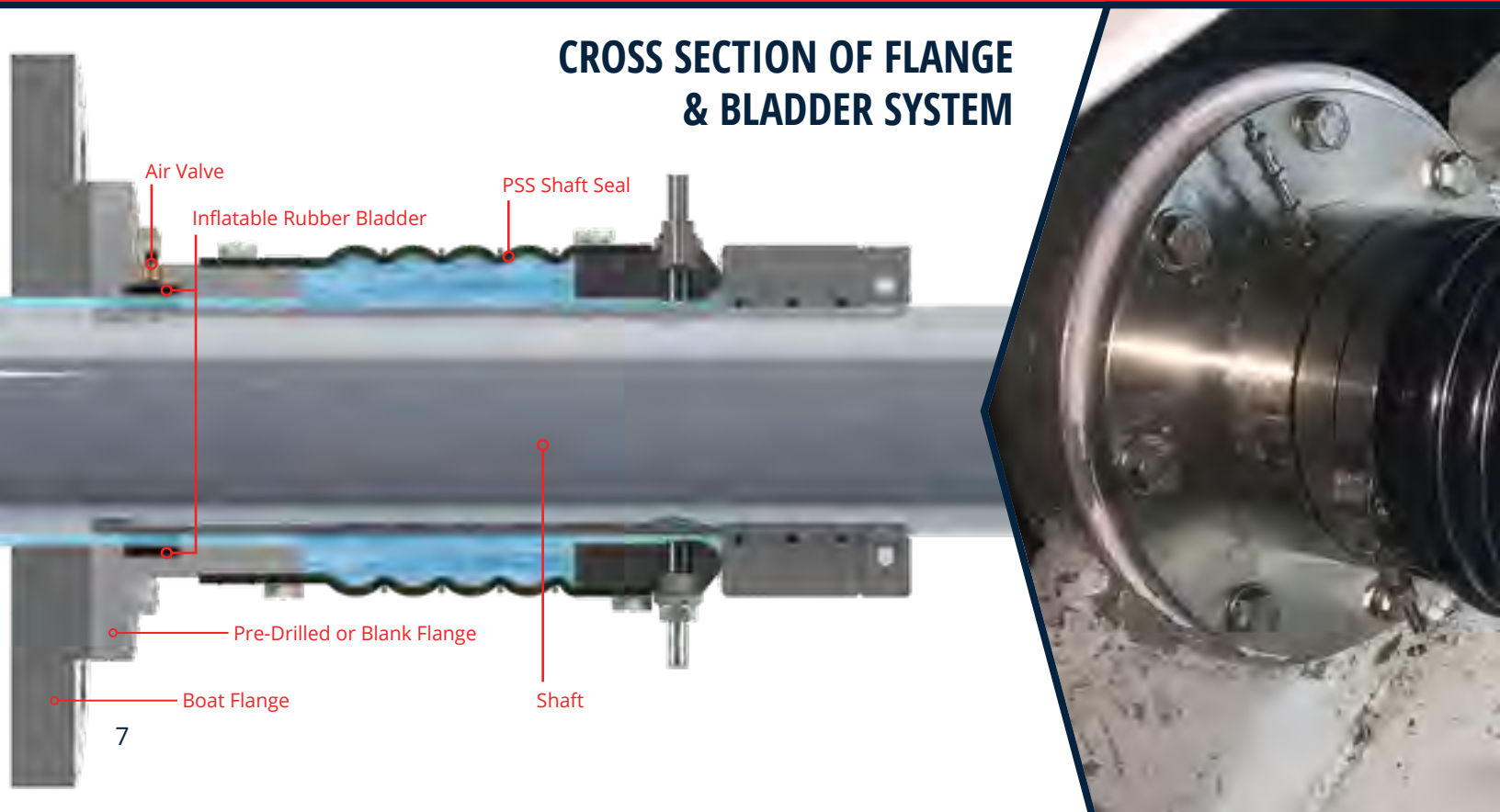

STANDARD FLANGES |



Not all vessels require a flange and bladder system, but most require a flange. To that effect PSS is offering flanges in all common materials (316 stainless steel, mild steel and aluminum). As all flanges are manufactured to order on our CNC lathes and mills, we can accommodate all patterns and shapes.

HOW DOES IT WORK?

An inflatable rubber bladder (made of Nitrile rubber) is nested in the flange. Once inflated to approximately 10 - 15 PSI the bladder will come into contact with the shaft creating a water tight seal. Deflate the rubber bladder to retract the bladder from the shaft allowing water back through (No damage is done to the shaft during this process). Bladder replacement recommended every 10 years under normal use and varies dependant on water condition. The bladder can only be used with a stationary shaft.

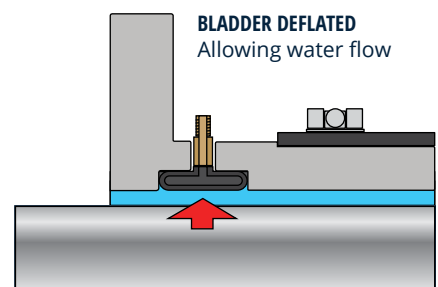
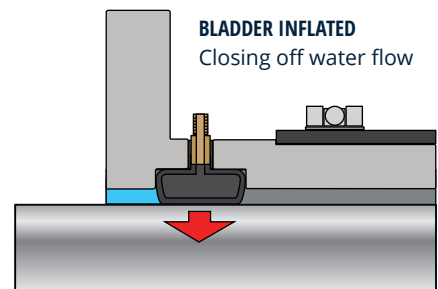

ACCESSORIES

For All
PSS Shaft Seal Types



MAINTENANCE KIT

To ensure longevity and proper function of the PSS Shaft Seal, PYI provides a PSS Maintenance Kit to follow the PYI's recommended maintenance schedule. As with any rubber / silicone hose below the waterline, the PSS bellow must be inspected on a regular basis for any sign of wear, aging or chemical deterioration. PYI recommends that the bellow be replaced once every 6 years (For Type A Seals) and 8-10 years (For Type B or PRO Seals). During the bellow replacement it is also recommended that the o-rings and set screws in the stainless steel rotor are replaced, as well as the hose clamps. PYI includes all of the necessary replacement parts in the PSS Maintenance Kit.

TYPE A SEAL MAINTENANCE KIT INCLUDES

- Bellow
- Set screws
- O-rings
- Stainless steel hose clamps
- Clamp Jackets (Hose clamp tail covers)
- Medium strength thread lock
- Wrench
- Instructions

TYPE B & PRO SEAL MAINTENANCE KIT INCLUDES

- Silicone bellow
- Set screws
- O-rings
- Bellow rings (Standard on sizes 2¼" (60mm) to 3¾" (95mm) and optional for smaller sizes)
- 316SS hose clamps
- Clamp Jackets (Hose clamp tail covers)
- Medium strength thread lock
- Wrench
- Instructions

TYPE A SEAL MAINTENANCE KIT



TYPE B & PRO SEAL MAINTENANCE KIT



Bellow rings
(Standard on PRO seal shaft sizes 2¼" to 3¾", and optional for smaller sizes)

SHAFT RETENTION COLLAR

The Shaft Retention Collar (SRC) is designed to protect propeller and rudder shafts. Assists in keeping the shaft and rudder in the boat in the event of a coupling failure. Due to its simple design the SRC is very easy to install with the shaft or rudder in place. Available in sizes to fit shafts from 1" to 3" or 25 to 80mm.



T-KIT

PYI offers T-Kits to help facilitate the installation of the PSS Shaft Seal. These T-Kits enable the installer to tee into the raw water discharge hose and plumb water to the hose barb fitting of the PSS Shaft Seal. Some examples of water pick-up points are: between the heat exchanger and riser, between oil cooler and heat exchanger and between the water pump and oil cooler.



Correct T-Kit installation

INSIDE HOSE Ø	T-KIT PART #
½"	07-KIT-012
¾"	07-KIT-034
1"	07-KIT-100
1¼"	07-KIT-114
1½"	07-KIT-112

BEFORE ORDERING

Measure the inside diameter of the cooling hose which you intend to tee off from before ordering.



INCLUDES

- T-fitting
- 6' of 3/8" hose
- Hose clamps

INSTALLATION EXAMPLES |

REPLACEMENT OF CLASSIC STUFFING BOX

Classic Stuffing Box... Before

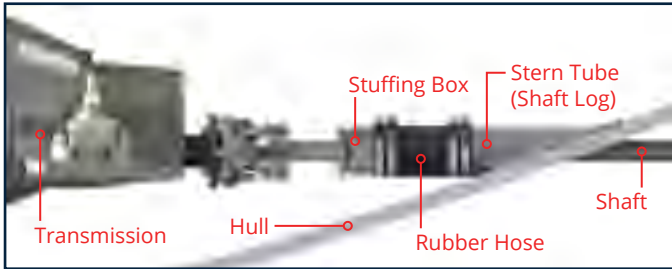

PSS Shaft Seal... After

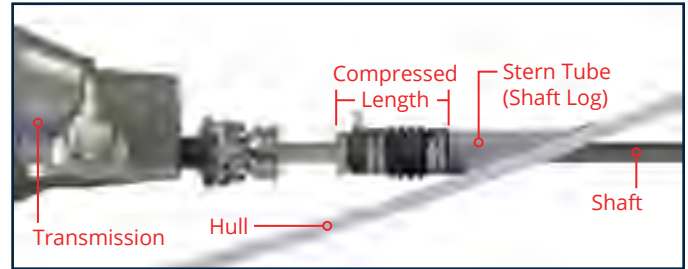

EXAMPLE OF POWERBOAT INSTALLATION

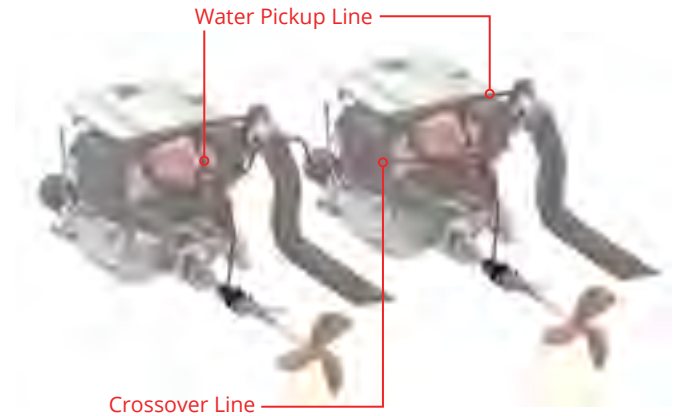
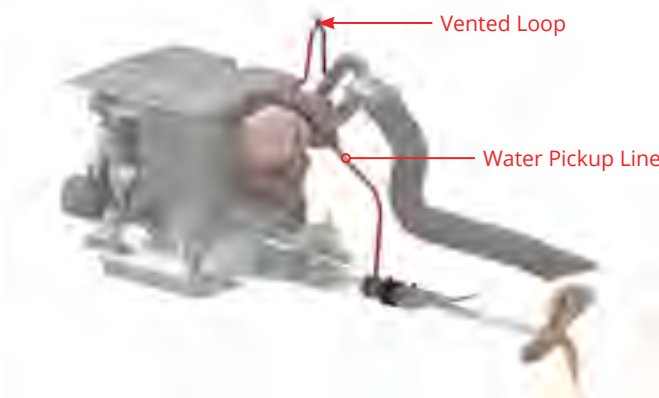

SAILBOAT INSTALLATION

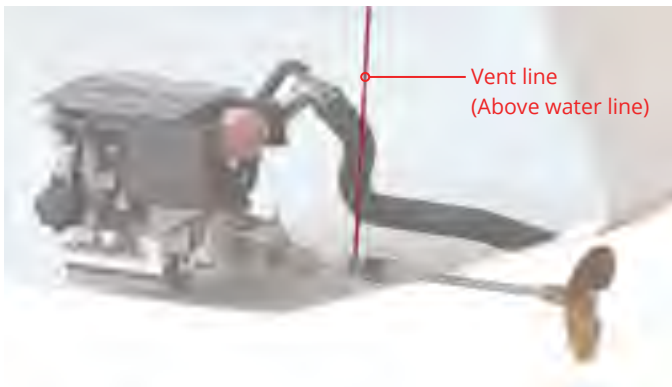

POWERBOAT INSTALLATION

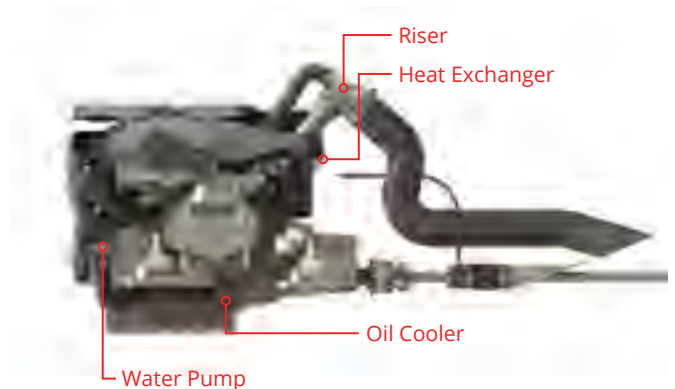

1. Tee into line after heat exchanges.
2. Tee into line after oil cooler.
3. Tee into line after water pump.
4. Hose barb into heat exchanger or oil cooler.

CAUTION

When the pick up point is located below the waterline an anti-siphon might be required to prevent back flooding of water through the exhaust system and into the engine. Standard boat plumbing practices should be followed.

OTHER APPLICATIONS |



WATER UTILITY, MIXING TANKS & WATER FILTRATION SYSTEMS

Specifically developed for surface water production plants, PSS Shaft Seals are installed on many horizontal mixer applications used in flocculation basins for rapid sand filtration plants and corrugated box / sheet production facilities.



PUMPS & FLOW TANKS WITH SPACE SENSITIVE INSTALLATIONS

PYI's ability to customize solutions allow PSS Shaft Seals to be integrated into space sensitive installations on specific pumps and flow tanks.



THERAPY & EXERCISE POOLS

PYI Inc. has developed and supplies mechanical seals at the OEM level for industry leading manufacturers of therapy and exercise pools used in healthcare and sport specific applications.



VERTICAL PUMPS, IRRIGATION & MINING

The ability of the PSS Shaft Seal to function in a dirty / silty environment, as well as its tolerance for radial movement makes it an ideal solution for the irrigation and mining industry. PYI's ability to customize sealing solutions has paved our way into this industry.

PSS SHAFT SEAL FAQ'S |



What general maintenance should I be considering for a PSS Shaft Seal that is working with no apparent issues?

Answer: PYI recommends that the bellows be replaced once every 6 years on our PSS Type A, and every 8 to 10 years on our Type B and PSS PRO Seals. During bellows replacement it is also recommended that the o-rings & set screws in the stainless steel rotor are replaced, as well as the hose clamps. Under most circumstances the carbon stator and the stainless steel rotor will not need replaced.

Can I re-use my set screws when making an adjustment or removing the PSS Shaft Seal?

Answer: No. The set screws provided with the PSS Shaft Seal are cup-point set screws, which compress onto the shaft when tightened. Any re-use of the set screws will not allow for the cup point to properly lock onto the shaft. The PSS Maintenance Kit comes with five new set screws included.



I'm hearing a high pitched "squealing" sound that seem to be coming from the shaft seal, what should I do?

Answer: The first step is to determine with high degree of certainty that the sound is coming from the shaft seal. If so, this is most likely the result of the shaft seal running dry and you will want to correct the plumbing to the seal. Fortunately the PSS Shaft Seal uses high quality carbon and stainless steel sealing components that will not melt as a result of water loss as you see with many other available sealing options.

Does the PSS Shaft Seal have a "break-in" period?

Answer: On average, the PSS Shaft Seal requires approximately one hour of break-in time, which allows the carbon flange to polish the mating face of the stainless steel rotor. During the break-in period you may experience a very fine mist, sometimes associated with a black dust coming from the PSS Shaft Seal. Under normal conditions, this will stop after an average of one hour running time.

It appears my shaft seal is leaking at rest, what can I do?

Answer: If the PSS Shaft Seal is leaking at rest it is likely that some foreign material is on the face of the seal between the stainless steel rotor and carbon flange. To clean this material from the seal, carefully insert a clean rag between the sealing faces and work the rag around the seal. As you do this, the incoming water will flush the sealing faces and the leak should stop once the rag is removed and the sealing faces are back in contact.

My seal is beyond the one hour break in period, does not leak at rest, but continues to mist during operation?

Answer: In most cases, a PSS Shaft Seal that does not leak at rest but only underway and / or at high RPMs is due to a lack of compression. Please note that the compression guide in the installation instructions are average figures and are provided as a guide. Exact compression amounts can vary from boat to boat. If the seal continues to spray underway following the break-in period, you will want to verify that the seal has been properly compressed. If it appears that additional compression is needed, add compression in 1/8" to 1/4" increments until the spray or mist stops.

I have a slow speed boat that will never exceed 12 knots under power, do I need positive water feed to my PSS Shaft Seal?

Answer: In most cases a slow speed boat that does not have a bearing, the PSS Shaft Seal does not require positive water feed and can simply be "vented". Ideally the vent line will be run at least 2-3 feet above the water line and is close to the center line as possible to ensure the vent hose is never below the water line, even if the boat heels. Review the PSS Shaft Seal Installation Instructions for more details on venting the seal.

I have a high speed boat that will exceed 12 knots under power, do I need positive water feed to my PSS Shaft Seal?

Answer: Yes, for high speed vessels it is required that a positive water supply be plumbed to the PSS Shaft Seal for the purpose of lubricating and cooling the seal faces. There are many sources of water supply, review the PSS Shaft Seal Installation Instructions for more information and note all plumbing must follow the standards and practices of proper boat plumbing.