

qualitymark

Trusted professionals & superiority in innovation

H₂OTM

PERFORMANCE PARTS



- Breakthrough Technology
- Rigorous Testing
- Unrivaled Quality



Welcome to Quality Mark products.

We put purpose before profit and strive to be an extraordinary business to partner with and to work for. Always improving performance, delivering quality and achieving sustainable business excellence.

***Highest quality material**



***Excellent surface finish**



***CNC machining**



***100% leak tested**

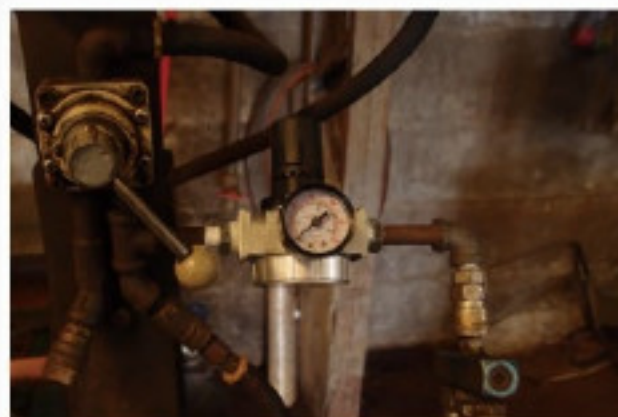

***In house painting**



***Well packaged**



Table of contents

Mercruiser	1 - 23
Crusader	24 - 36
Chrysler	37 - 42
Universal	43 - 48
Indmar	- 47
Pleasurecraft	48 - 51
Volvo	52 - 54
OMC/VP	55 - 56
OMC	57 - 60
OMC, Volvo	- 59
Gasket	61 - 62
Installation Procedure	- 63
Warranty	- 64
H2O Part Number Index	65 - 67
OEM Interchange Guide	68 - 69
Barr Interchange Guide	70 - 71
Sierra Interchange Guide	72 - 74

Legal Notices

Ford, GM, MercCruiser, and the other trademarks and trade names mentioned in this catalog are the property of their respective owners. We have no affiliation with these companies and this catalog is not endorsed by any of them. Quality Mark is a separate corporate entity with absolutely no ties to these companies and the use of other company part numbers is supplied as strictly informational use to our customers.

The products offered for sale in this catalog are produced by Quality Mark and sold under its trademark, H2O Performance Parts, and have no approval or connection to any companies mentioned.



GM V6 262 cu.in

All GM V-6 models 2004 and up

GM Small Block V8 305-350 cu.in

All Small Block GM V-8 models 2002 and up



T-20591 Dry Joint Riser

14° down angle



Cross Reference

Barr # MC-20-864591

MerCruiser # 864591T02

Sierra # 18-1845



**Mounting kit is coming soon*

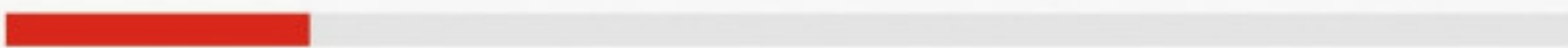

T-20735 Dry Joint Manifold



T-20735 Dry Joint Manifold



Cross Reference

Barr # MC-1-865735
MerCruiser # 865735A02
Sierra # 18-1843



**Mounting kit is coming soon*

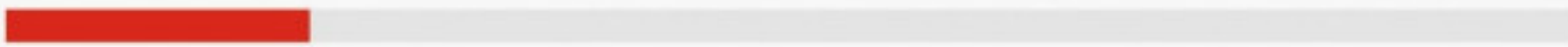

T-20591 Dry Joint Riser

NEW



T-20956 Manifold

**Mounting kit is included*



Cross Reference

Barr # MC-1-860235
MerCruiser # 860235A04
Marine Power # 600333
Sierra # 18-1956-2



20956-MK
Mounting kit, Manifold
Includes gasket and mounting hardware



T-20975 Elbow

GM L4 153 and 181 cu.in.

Models 120, 140, 2.5L, 3.0L

NEW



T-20966 Manifold

**Mounting kit is included*



Cross Reference

MerCruiser # 860235A03

Sierra # 18-1966



20966-MK

Mounting kit, Manifold

Includes gasket and mounting hardware



T-20975 Elbow

GM V6 229 and 262 cu.in.

GM Small Block V8 305-350 cu. in.

GM Big Block V8 454 cu.in.

Models 185 and 205

200, 228, 230 260 and 898

330, 340 and 7.4L

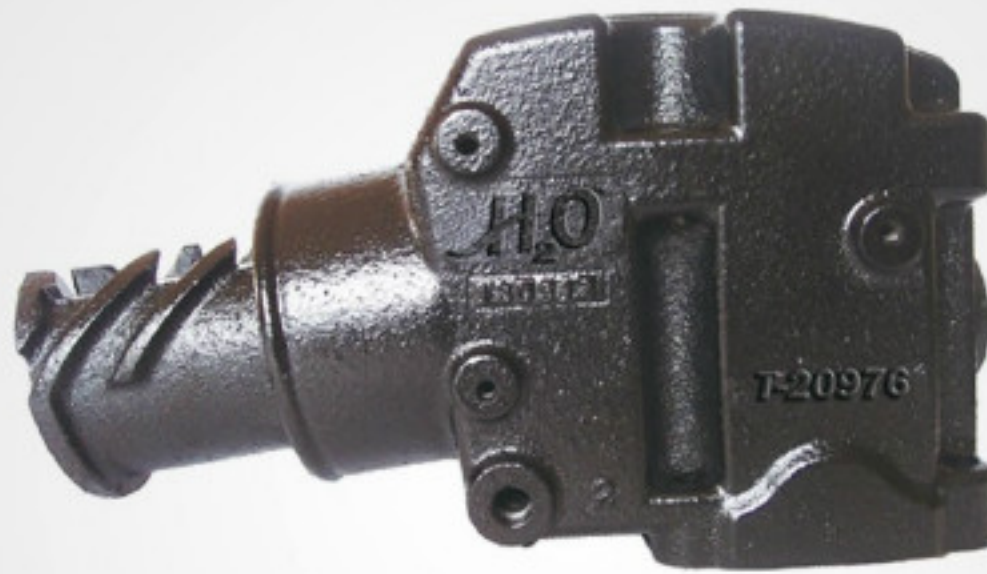

T-20976 Riser

4" exhaust outlet, 7° down angle



Cross Reference

Barr # MC-20-44354

Marine Power # 0992-400

MerCruiser # 44354 / 807914 / 807988

Sierra # 18-1976-1



* 80897 Gasket



20976-MK

Mounting kit, Riser

Includes gasket and mounting hardware



T-20952 Manifold



T-20953 Manifold



T-20957 Manifold



T-20950 Manifold, port, log style manifold



Cross Reference

Barr # MC-1-77234
 MerCruiser # 77234B
 Sierra # 18-1950-1



*80872 Gasket



27214-MK
Mounting kit, Manifold
 Includes gasket and mounting hardware

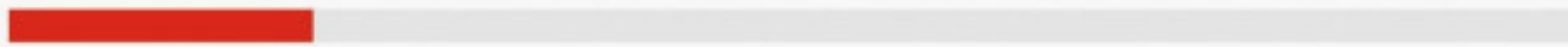

T-20971
Riser



T-20978
Riser



T-20951 Manifold, starboard, log style manifold



Cross Reference

Barr # MC-1-77235
 MerCruiser # 77235B
 Sierra # 18-1951-1



*80872 Gasket



27214-MK
Mounting kit, Manifold
 Includes gasket and mounting hardware



T-20971
Riser



T-20978
Riser



T-20957 Manifold, fits both sides of engine



Cross Reference

Barr # MC-1-89011
MerCruiser # 89011
Sierra # 18-1957-1



*80418 Gasket



20957-MK
Mounting kit, Manifold
Includes gasket and mounting hardware



T-20970
Riser



T-20976
Riser

GM V6 229 and 262 cu.in.

GM Small Block V8 305-350 cu. in.

GM Big Block V8 454 cu.in.

Models 185 and 205

200, 228, 230 260 and 898

330, 340 and 7.4L



T-20908 Spacer

3" center riser

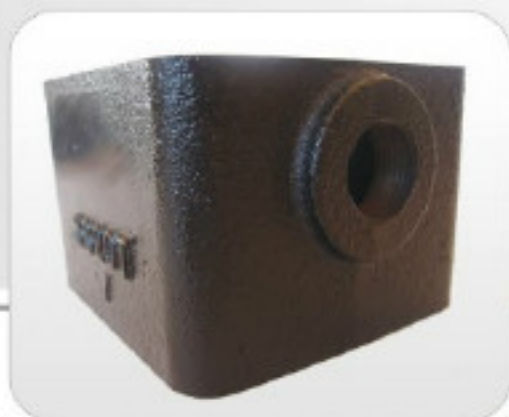

Cross Reference

Barr # MC-20-93320A3

MerCruiser # 93320

Sierra # 18-1908

*80897 Gasket



20908-MK-X (with T-20976)
Mounting kit, Spacer
Includes gasket and mounting hardware



*82849 Gasket

*80897 Gasket



20908-MK (with T-20970)
Mounting kit, Spacer
Includes gasket and mounting hardware



*82849 Gasket



T-20976
Riser



T-20970
Riser

GM V6 229 and 262 cu.in.

GM Small Block V8 305-350 cu. in.

GM Big Block V8 454 cu.in.

Models 185 and 205

200, 228, 230 260 and 898

330, 340 and 7.4L



T-20985 Spacer

6" center riser

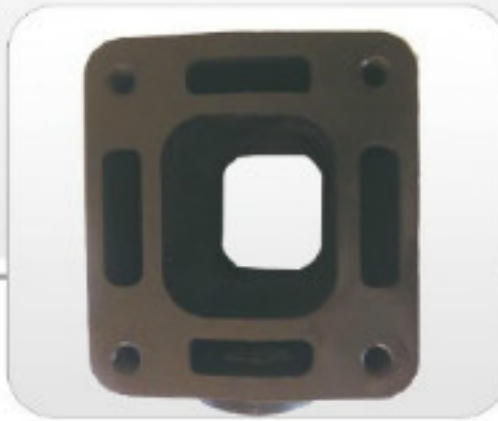

Cross Reference

Barr # MC-20-93322A3
MerCruiser # 93322
Sierra # 18-1985



20908-MK (to mount spacer to manifold)
Mounting kit, Spacer

Includes gasket and mounting hardware



Riser T-20970 or T-20976 will require their own mounting kit.



T-20952 Manifold



T-20953 Manifold



T-20957 Manifold

Mercruiser 3.7L / 224 cu.in.



T-20937 Elbow/Reservoir

*Fits Mercruiser aluminum manifold # 93174
Cap included. Fitting not included.*



Cross Reference

MerCruiser # 98562A6

Sierra # 18-1937



20937-MK
Mounting kit, Elbow/Reservoir
Includes gasket and mounting hardware

*80881 Gasket



Ford Small Block V8 302-351 cu.in.

Model 215, 225, 223, 255 and 888



T-20962

Manifold, starboard, log style manifold



Cross Reference

Bar # MC-1-65603

MerCruiser # 54099 and 65603

Sierra # 18-1962-1

*80183 Gasket



20560-MK

Mounting kit, Manifold

Includes gasket and mounting hardware



T-20971
Riser



T-20978
Riser



Ford Small Block V8 302-351 cu.in.

Model 215, 225, 223, 255 and 888



T-20958
Manifold, port, log style manifold



Cross Reference

Bar # MC-1-65604
 MerCruiser # 54100 and 65604
 Sierra # 18-1958-1

*80183 Gasket



20560-MK
Mounting kit, Manifold
 Includes gasket and mounting hardware



T-20971
Riser



T-20978
Riser

GM In-Line Six Cylinder 250 cu.in

GM In-Line Six Cylinder 250, 292 cu.in.

GM small block V8 305-350 cu.n.

165 Equipped with Mercruiser riser

165 and 200

198, 228 and 898

#s 76351, 76325, 60426, 49964,
76771 or 60427



T-20978 Riser

3" exhaust outlet, 0° down angle,
for use in most inboard applications



Cross Reference

Barr # MC-20-76771

MerCruiser # 76771 / 60427

Sierra # 18-1978



*82833 Gasket



26371-MK

Mounting kit, Riser

Includes gasket and mounting hardware



T-20953 Manifold, fits both sides of engine



Cross Reference

Barr # MC-1-87114
Marine Power # 0994-100
MerCruiser # 87114 / 860246
Sierra # 18-1953-1

*80872 Gasket



27214-MK
Mounting kit, Manifold
Includes gasket and mounting hardware



T-20976
Riser

GM V6 229 and 262 cu.in.

GM Small Block V8 305-350 cu. in.

GM Big Block V8 454 cu.in.

Models 185 and 205

200, 228, 230 260 and 898

330, 340 and 7.4L



T-20970 Riser

3" exhaust outlet, 15° down angle. For early model inboard/outboards.

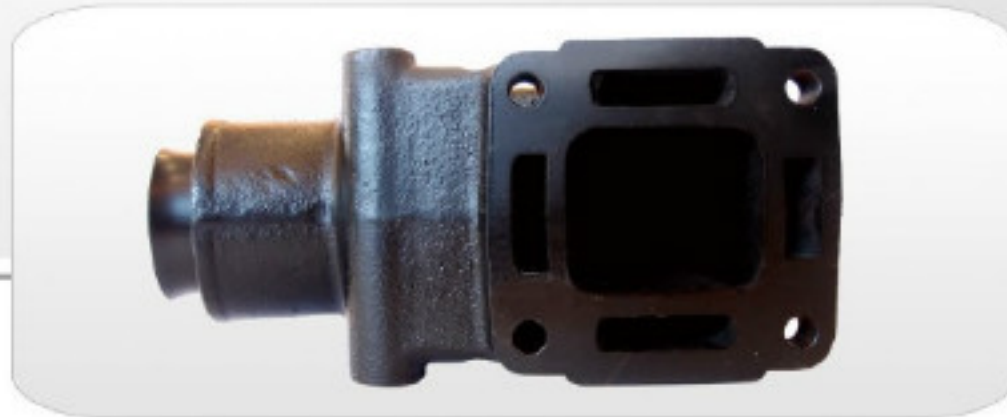

Cross Reference

Barr # MC-20-98504

MerCruiser # 98503 / 98504

Sierra # 18-1970-1



*80897 Gasket



28503-MK Mounting kit, Riser

Includes gasket and mounting hardware



T-20952 Manifold



T-20953 Manifold



T-20957 Manifold

GM In-Line Six Cylinder 250 and 292 cu.in.

165 and 200

GM Small Block V8 305-350 cu.in.

198, 228 and 898



T-20971 Riser

3" exhaust outlet, 90° down angle. For use in most inboard / outboard applications



Cross Reference

Barr # MC-20-60426 / MC-20-76351
 MerCruiser # 76351 / 60426 / 49964
 Sierra # 18-1971



*82833 Gasket



26371-MK
Mounting kit, Riser
 Includes gasket and mounting hardware

GM V6 229 and 262 cu.in.

Models 185 and 205



T-20952 Manifold



Cross Reference

Barr # MC-1-99746
 Marine Power # 0996-000
 MerCruiser # 99745 / 99746
 Sierra # 18-1952-1

*82909 Gasket



20952-MK
Mounting kit, Manifold
 Includes gasket and mounting hardware



T-20976
Riser



T-20970
Riser

GM Four Cylinder 181 cu.in

Models 120/140/2.5L/3.2L

GM In-Line Six Cylinder 250 and 292 cu.in.

165 and 200

Ford Small Block V8 302-351 cu.in.

215, 225, 233, 255 and 888

*GM Small Block V8 305-350 cu.in. / Models 198, 228 and 898

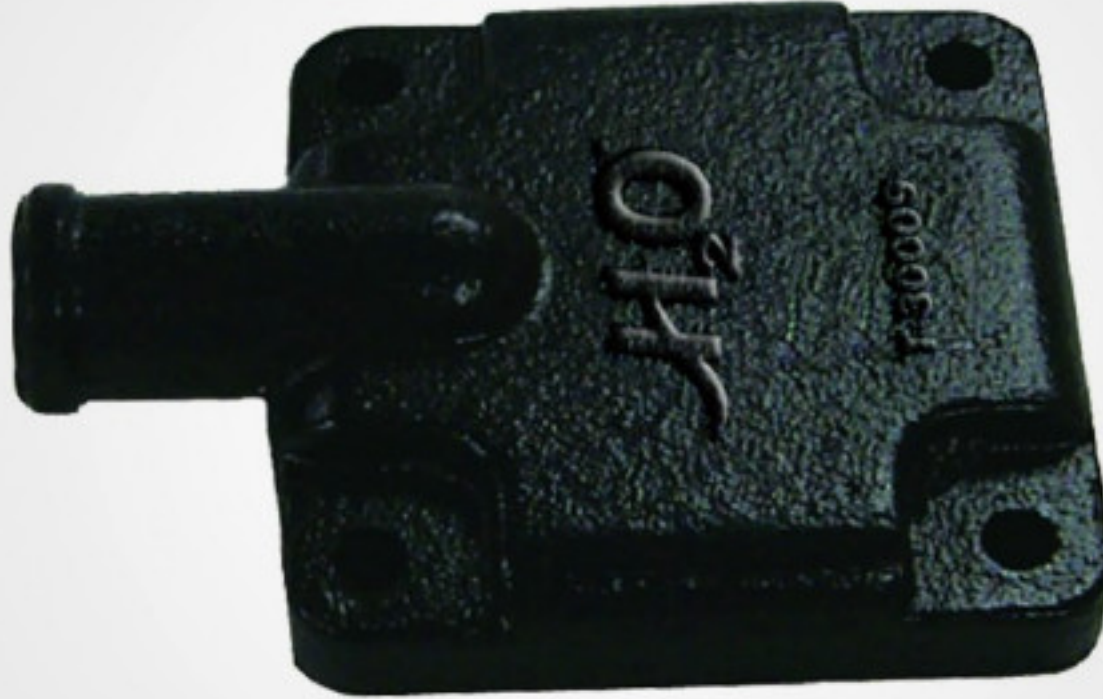

T-30009 End Plate

Cross Reference

MerCruiser # 60252

Sierra # 18-4009



*82832 Gasket



30009-MK

Mounting kit, End Plate

Includes gasket and mounting hardware



**T-20950
Manifold**



**T-20951
Manifold**



**T-20958
Manifold**



**T-20962
Manifold**



T-20906 Spacer, 3" rear riser.

Cross Reference

Barr # MC-20-61851A2
MerCruiser # 61851
Sierra # 18-1906



*82833 Gasket

20906-MK
Mounting kit, Spacer
Includes gasket and mounting hardware

*Fit T-20950 and T-20951 manifolds with T-20971 or T-20978 risers



T-20905 Elbow

Cross Reference

Barr # MC-20-90880
MerCruiser # 90880
Sierra # 18-1905



*80113 Gasket



20905-MK
Mounting kit, Elbow/Reservoir
Includes gasket and mounting hardware



GM V6 229 and 262 cu.in.

Models 185 and 205

GM Small Block V8 305-350 cu. in.

200, 228, 230 260 and 898

GM Big Block V8 454 cu.in.

330, 340 and 7.4L



T-20974 Riser, 3" 0° (3" O.D. Riser)

Cross Reference

MerCruiser # 98502A2

Sierra # 18-1974-1



*80897 Gasket



28503-MK

Mounting kit, Riser

Includes gasket and mounting hardware



GM Four Cylinder 181 cu.in.

Models 120 / 140 / 2.5L / 3.0L

* T-20975 riser replaces the early Mercruiser 2-piece riser setup from Mercruiser using # 76325 riser with an off-set adapter #95863.



T-20975 Riser

4" exhaust outlet, 90° down angle



Cross Reference

MerCruiser # 12076
Sierra # 18-1975-1



*82833 Gasket

20975-MK
Mounting kit, Riser
Includes gasket and mounting hardware



T-20918 Elbow

Jacked upper for swivel



Cross Reference

Crusader # 97386
Sierra # 18-1918



*80309 Gasket



26562-MK
Mounting kit, Elbow
Includes gasket and mounting hardware



T-20927
Riser



T-20916
Riser



T-20925 Manifold, starboard



Cross Reference

Barr # CR-1-97752

Crusader # 97752 AND 96120

Sierra # 18-1925



*80872 Gasket



20775-MK
Mounting kit, Manifold
Includes gasket and mounting hardware



T-20927
Riser



T-20916
Riser



T-20926 Manifold, port



Cross Reference

Barr # CR-1-97753

Crusader # 97753 AND 96121

Sierra # 18-1926

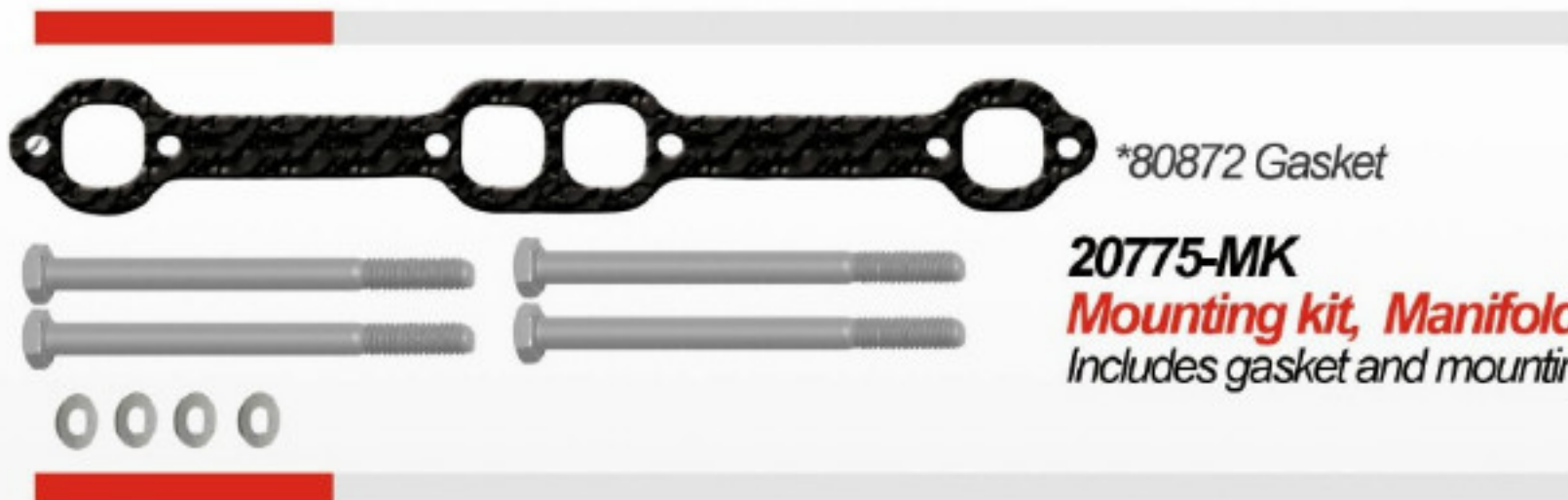

*80872 Gasket

20775-MK
Mounting kit, Manifold
Includes gasket and mounting hardware



T-20927
Riser



T-20916
Riser

GM Small Block V8 305-350 cu.in.

Models 220 and 270

GM Big Block V8 454 cu.in.

CH350 AND 454XL



T-20927 Riser, 4"



Cross Reference

Barr # CR-20-97924

Crusader # 97772

Sierra # 18-1927



*80305 Gasket



20927-MK
Mounting kit, Manifold
 Includes gasket and mounting hardware



T-20925
Manifold



T-20926
Manifold



T-20928 Elbow, 4" outlet

Cross Reference

Crusader # 97924
Sierra # 18-1928



*80309 Gasket

26562-MK
Mounting kit, Manifold
Includes gasket and mounting hardware



T-20916
Riser, 8"



T-20927
Riser, 4"



T-20929 Manifold, starboard
Fits both sides of engine



Cross Reference

Barr # CR-1-97992
Crusader # 97992 and 97114
 Sierra # 18-1929

*80418 Gasket



20799-MK
Mounting kit, Manifold
Includes gasket and mounting hardware



T-20916
Riser, 8"



T-20927
Riser, 4"



T-20933 Manifold, port



Cross Reference

Barr # CR-1-97993
 Crusader # 97993 and 97115
 Sierra # 18-1933

*80418 Gasket



20799-MK
Mounting kit, Manifold
 Includes gasket and mounting hardware



T-20916
Riser, 8"



T-20927
Riser, 4"

GM Small Block V8 305-350 cu.in.

Models 220 and 270

GM Big Block V8 454 cu.in.

CH350 AND 454XL



T-20934 Elbow, 4" outlet



Cross Reference

Barr # CR-20-98068

Crusader # 98068

Sierra # 18-1934



*80309 Gasket

26562-MK
Mounting kit, Manifold
Includes gasket and mounting hardware



T-20916
Riser, 8"



T-20927
Riser, 4"

GM Big Block V8 454 cu.in.

Models 454XL and 502XL

MP8.1L engines



T-20982 Manifold

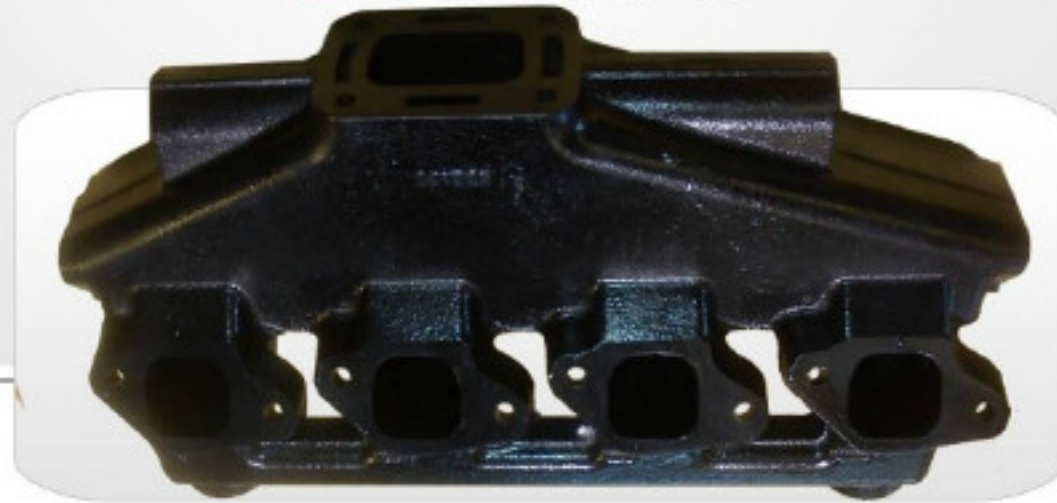

Cross Reference

Crusader # 98125 / R0208021A
Sierra # 18-1982

*80418 Gasket



20982-MK
Mounting kit, Manifold
Includes gasket and mounting hardware



T-20938
Riser

GM Small Block V8 305-350 cu.in.

Models 220 and 270

GM Big Block V8 454 cu.in.

CH350 AND 454XL



T-30984 Spacer, 4"



Cross Reference

Crusader # 98128
Sierra # 18-1984



30984-MK
Mounting kit, Manifold
Includes gasket and mounting hardware

*80475 Gasket



T-20938
Riser, 4"



T-20938 Riser, 4"



Cross Reference

Crusader # RO29015 and 98126
Sierra # 18-1938

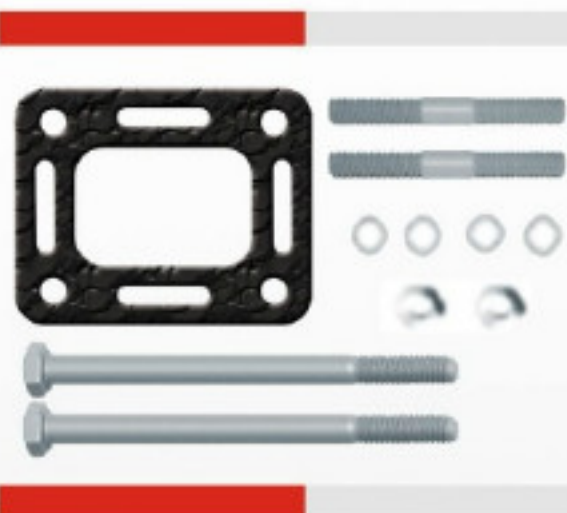

20938-MK
Mounting kit, Manifold
Includes gasket and mounting hardware

*80475 Gasket



T-30984
Spacer, 4"

GM Small Block V8 305-350 cu.in.

Models 220 and 270

GM Big Block V8 454 cu.in.

CH350 AND 454XL



T-20296 Stainless plate, Block off.
Separates fresh water from raw water

Cross Reference

Crusader # 97296
Sierra # 18-1917

GM Small Block V8 305-350 cu.in.

Models 220 and 270

GM Big Block V8 454 cu.in.

CH350 AND 454XL



T-20916 Riser

Cross Reference

Crusader # 97169
Sierra # 18-1916



*80305 Gasket



20916-MK
Mounting kit, Riser
Includes gasket and mounting hardware



T-20925
Manifold



T-20926
Manifold

Chrysler Small Block

All models 1966 and up with swivel / fixed exhaust

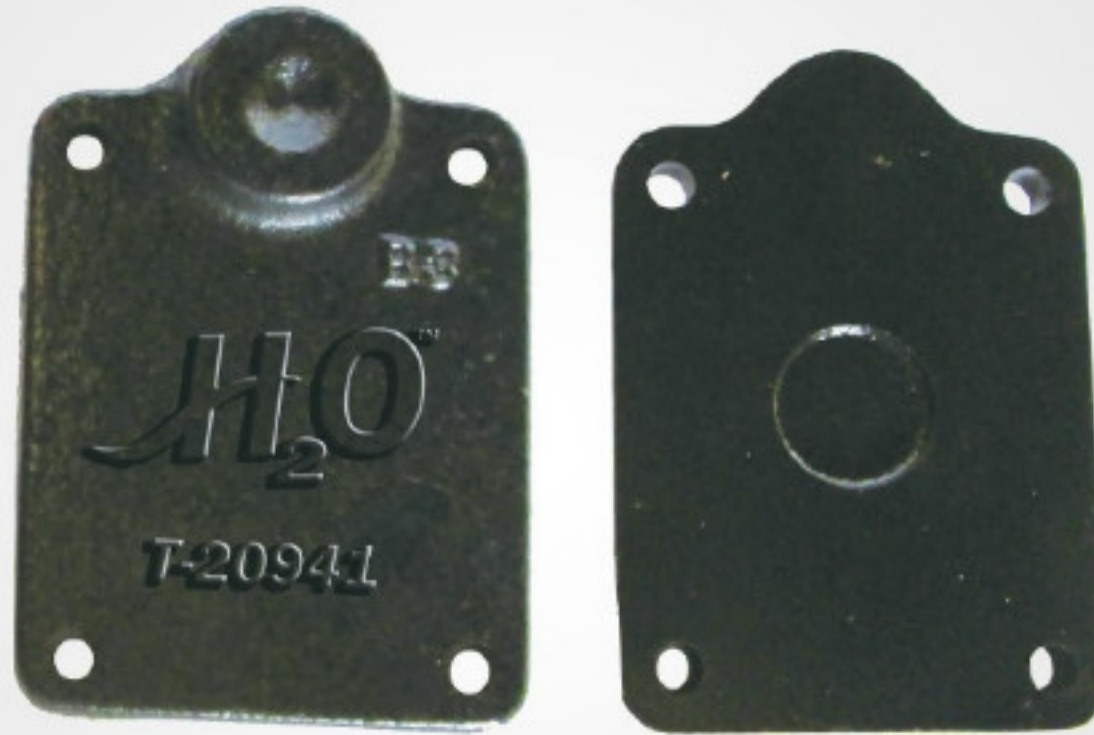

T-20941 Front plate, no hole for water fitting

Cross Reference

Barr # cm-16672-B

Chrysler # 2846104

Sierra # 18-1941



*80472 Gasket



20480-MK-FW (Fits T-20913/T-20941/T-20945/T-20946)

Mounting kit

Includes gasket and mounting hardware

or **T-20941-MK Mounting kit**



T-20940
Manifold

Chrysler Small Block

All models 1966 and up with fixed exhaust



T-20945 Riser, used with T-20913 and T-20946 elbow



Cross Reference

Chrysler # 2846689
Sierra # 18-1945



*80472 Gasket



20480-MK-FW (Fits T-20913/T-20941/T-20945/T-20946)
Mounting kit

Includes gasket and mounting hardware

or **20480-MK Mounting kit**



T-20913
Elbow



T-20946
Elbow

Chrysler Small Block

All models 1966 and up with swivel / fixed exhaust



T-20942 Front plate, with 3/4" IPT hole for water fitting

Cross Reference

Barr # CM-16672-H
Chrysler # 3527896
Sierra # 18-1942



*82941 Gasket



20480-MK
Mounting kit, Manifold
Includes gasket and mounting hardware



T-20940
Manifold

Chrysler Small Block

All models 1966 and up with fixed exhaust



T-20946 Elbow, 3" exhaust outlet, 20° down angle.
Used for inboard applications.



Cross Reference

Barr # CM-20-6672
Chrysler # 3527794
Sierra # 18-1946



*80472 Gasket



20480-MK-FW (Fits T-20913/T-20941/T-20945/T-20946)
Mounting kit

Includes gasket and mounting hardware

or **20480-MK Mounting kit**



T-20940
Manifold



T-20945
Riser

Chrysler Small Block

All models 1966 and up with swivel / fixed exhaust



T-20940 Manifold



Cross Reference

Barr # CM-1-6677-A

Chrysler # 24695566 AND 3675826

Sierra # 18-1940



**20940-MK
Mounting kit, Manifold**

Includes gasket and mounting hardware

*80826 Gasket



**T-20945
Riser**

Chrysler Small Block

All models 1966 and up with fixed exhaust



T-20913 Elbow, 3" exhaust outlet, 90° down angle.
Used for inboard / outboard applications.

Cross Reference

Chrysler # 2469639 and 2847405
Sierra # 18-1913



*80472 Gasket



20480-MK-FW (Fits T-20913/T-20941/T-20945/T-20946)
Mounting kit

Includes gasket and mounting hardware

or **20480-MK Mounting kit**



T-20940
Manifold



T-20945
Riser



**T-20999 Riser, 3" Outlet,
10° down angle.**



Cross Reference

Barr # 20-0082

Marine power # 0992-000

Sierra # 18-1999



*82854 Gasket

20992-MK
Mounting kit, Riser and Spacer
Includes gasket and mounting hardware
(fits T-20907 / T-20939 / T-20999)



*80476 Gasket

20992-MK-FW
Mounting kit, Riser. Blocked.
Includes gasket and mounting hardware
(Fits T-20907 / T-20939 / T-20999)



T-20898
Manifold



T-20997
Manifold



T-20998
Manifold

Ford small block V8 302-351 cu.in. / GM Small block V8 305-350 cu.in. / Gm Big Block V8 454 cu.in.



T-20939 Riser, 4" Outlet,

4" outlet, 10° down angle



Cross Reference

Barr # 20-0100

Marine power # 0992-593

Sierra # 18-1939



*82854 Gasket

20992-MK
Mounting kit, Riser and Spacer
 Includes gasket and mounting hardware
 (fits T-20907 / T-20939 / T-20999)



*80476 Gasket

20992-MK-FW
Mounting kit, Riser. Blocked.
 Includes gasket and mounting hardware
 (Fits T-20907 / T-20939 / T-20999)



T-20898
Manifold



T-20997
Manifold



T-20998
Manifold

GM Small Block V8 305-350 cu.in.



T-20997 Manifold



Cross Reference

Barr # CHV-1-8

Marine power # 0994-000

Sierra # 18-1997-1

*80872 Gasket



20997-MK
Mounting kit, Manifold
 Includes gasket and mounting hardware

GM Small Block V8 454 cu.in.



T-20898 Manifold



Cross Reference

Barr # CHVA-1-84

Marine power # 0991-110

Sierra # 18-1898

*80418 Gasket



20898-MK
Mounting kit, Manifold
Includes gasket and mounting hardware

GM Small Block V8 305-350 cu.in.

Ford Small Block V8 302-351



T-20907 Riser
3" outlet, 30° down angle



Cross Reference

Bar # 20-0102

Indmar # 53-2009 and 53-2018

Sierra # 18-1907



*82854 Gasket

20992-MK
Mounting kit, Riser and Spacer
Includes gasket and mounting hardware
(fits T-20907 / T-20939 / T-20999)



*80476 Gasket

20992-MK-FW
Mounting kit, Riser. Blocked.
Includes gasket and mounting hardware
(Fits T-20907 / T-20939 / T-20999)



T-20997
Manifold



T-20998
Manifold

Ford Small Block V8 302-351 cu.in.



T-20998 Manifold



Cross Reference

Barr # CHVA-1-83

Indmar # 53-2800

Sierra # 18-1998-1



*80183 Gasket



20998-MK
Mounting kit, Manifold
Includes gasket and mounting hardware



T-20907
Riser



T-20939
Riser



T-20999
Riser

Ford Small Block V8 302-351 cu.in.



T-20996 Manifold, fits both side of engine.



Cross Reference

Pleasurecraft # RO28001

Sierra # 18-1996



20996-MK

Mounting kit, Manifold

Includes gasket and mounting hardware

*80183 Gasket



T-20899

Riser

Ford Small Block V8 302-351 cu.in.



T-20899 Riser, 3" outlet



Cross Reference

Pleasurecraft # RO29001

Sierra # 18-1899



*80677 Gasket

20899-MK
Mounting kit, Riser
Includes gasket and mounting hardware



T-20996
Manifold

Ford Small Block V8 302-351 cu.in.



T-20011 Riser, 3.5" outlet

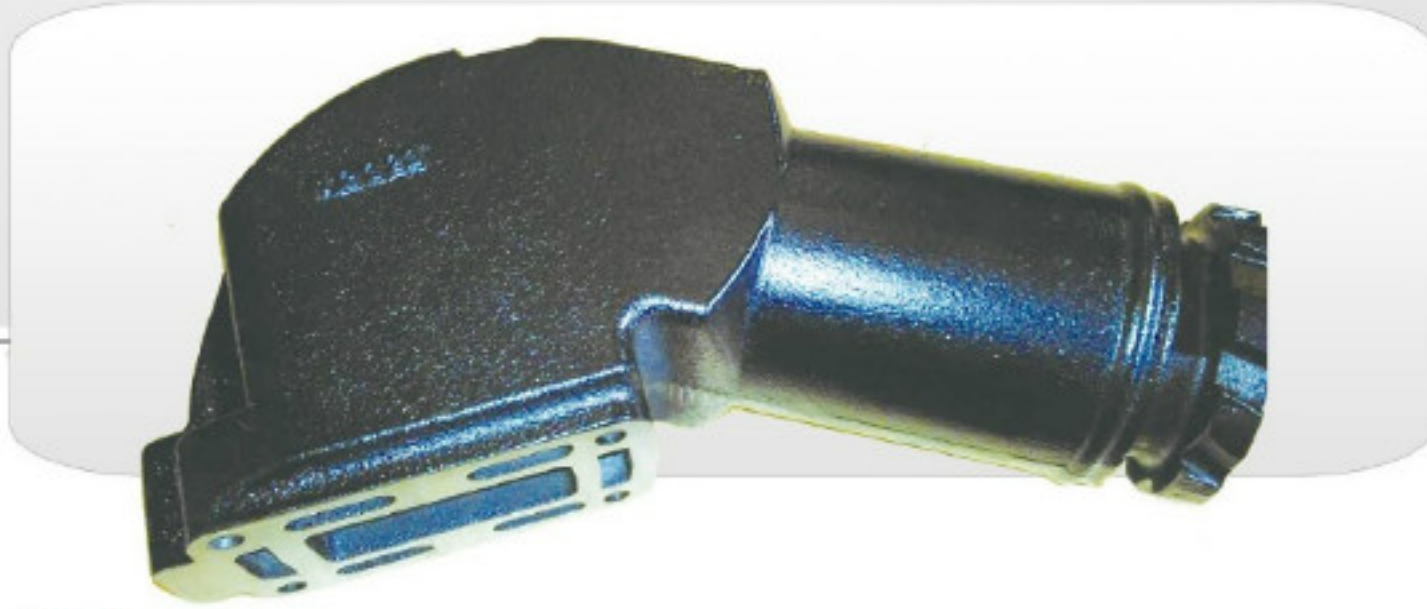

Cross Reference

Pleasurecraft # RO29011



*80677 Gasket



20899-MK
Mounting kit, Riser
Includes gasket and mounting hardware



T-20996 Manifold

GM Small Block V8 305-350 cu.in.

Models AQ and BB 200, 205, 211, 231, 225, 260, 271, 290, 311, 500, 501, 570, 571, and 572



T-20931 Manifold



Cross Reference

Barr # VO-1-835804

Volvo # 835804, 835805, 835806 and 856883

Sierra # 18-1931-1



20931- MK

Mounting kit, Manifold

Includes gasket and mounting hardware

*80872 Gasket



T-20935

Riser

GM Small Block V8 305-350 cu.in.

Models AQ and BB 200, 205, 211, 231, 225, 260, 271, 290, 311, 500, 501, 570, 571, and 572



T-20935 Riser



Cross Reference

Barr # VO-20-855384

Volvo # 855380, 855384, 856891 and 856879

Sierra # 18-1935-1



*82971 Gasket



20935- MK
Mounting kit, Riser

Includes gasket and mounting hardware



T-20931
Manifold

Volvo Four Cylinder B20 2.3 and 2.5 liter

Models AQ 120, 125 131, 140, 145, and 151
BB 140, 145, 230 and 250



T-20930 Manifold



Cross Reference

Volvo # 855837-7 and 834438-4
Sierra # 18-1930-1



20930- MK
Mounting kit, Manifold
Includes gasket and mounting hardware
*82991 Gasket

GM Small Block V8 305-350 cu.in.

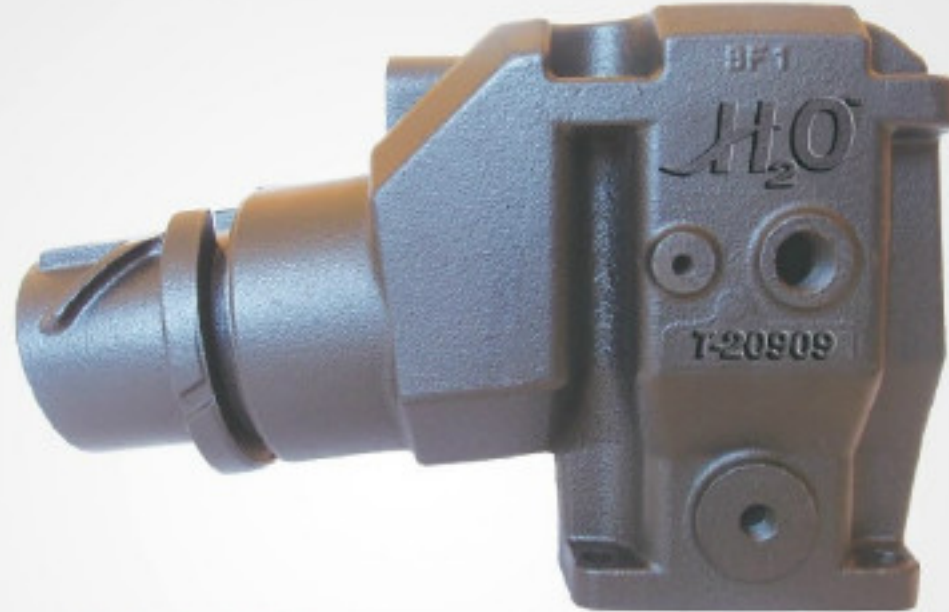

T-20909 Riser, 4" exhaust outlet



Cross Reference

Barr # VO-20-913784

Volvo # 3855270-9

OMC # 913784, 3855270, 3850456

Sierra # 18-1909-1



*80942 Gasket



20909- MK Mounting kit, Riser

Includes gasket and mounting hardware



**T-20986
Manifold**

GM Small Block V8 305-350 cu.in.



T-20986 Manifold, fit both side of engine



Cross Reference

Volvo # 3852374-2

OMC # 914035, 3852374

Sierra # 18-1986-1



20244- MK
Mounting kit, Riser

Includes gasket and mounting hardware

*80872 Gasket



T-20909 Riser



T-20902 Manifold, starboard



Cross Reference

Barr # OMC-1-912441
 OMC # 909280 and 912441
 Sierra # 18-1902



20244- MK
Mounting kit, Riser
 Includes gasket and mounting hardware

*80872 Gasket



T-20921
Riser

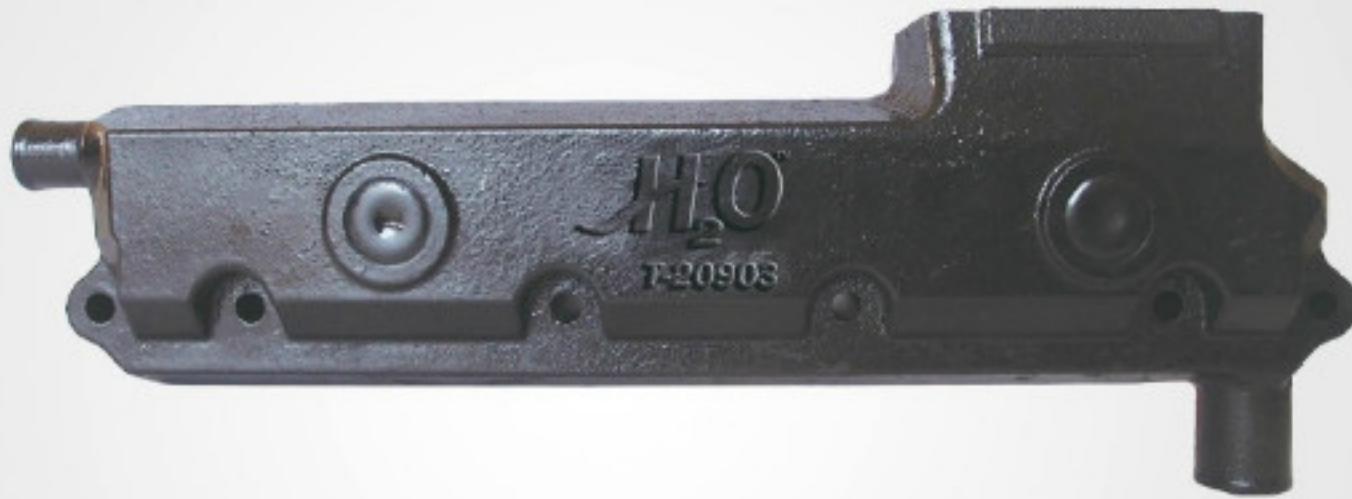

T-20903 Manifold, port



Cross Reference

Barr # OMC-1-912442
 OMC # 909312 and 908488
 Sierra # 18-1903



20244- MK
Mounting kit, Riser
 Includes gasket and mounting hardware

*80872 Gasket



T-20921
Riser

GM Small Block V8 305-350 cu.in.

Models 1976 to 1989

Riser used on multiple applications. Ford and GM.



T-20921 Riser
 3-1/2" exhaust outlet, 60° down angle,
 and tapped to accept 3/4" MPT hose barb.

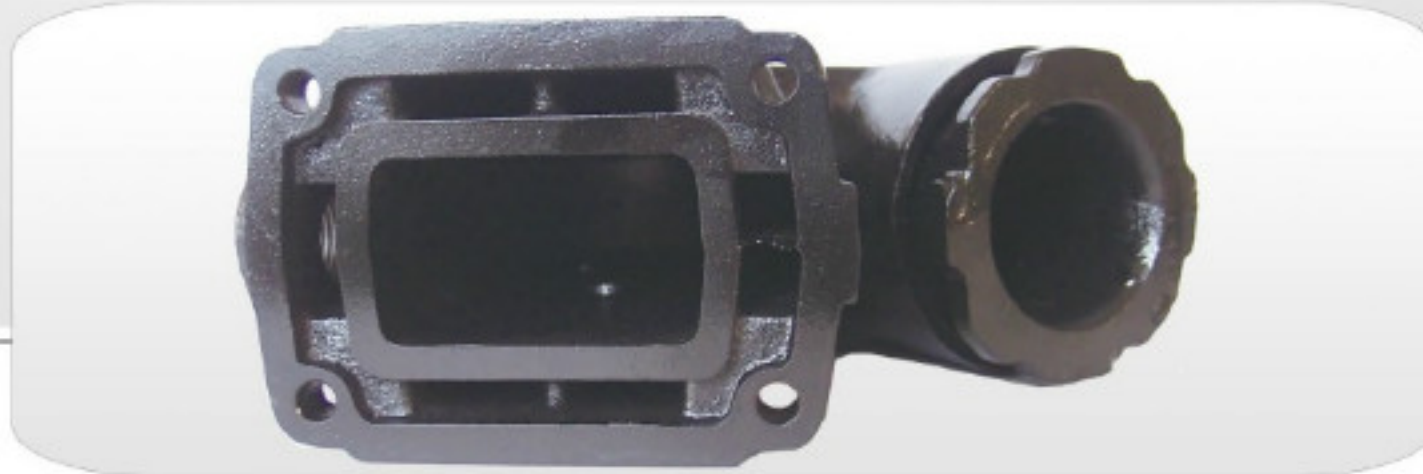

Cross Reference

Barr # OMC-20-982680
 OMC # 909863
 Sierra # 18-1921



20921- MK
Mounting kit, Riser
 Includes gasket and mounting hardware

*80943 Gasket



T-20902
Manifold



T-20903
Manifold



T-20986
Manifold

GM V6 262 cu.in

Models 1986 to 1990

OMC 4.3L with one-piece designs

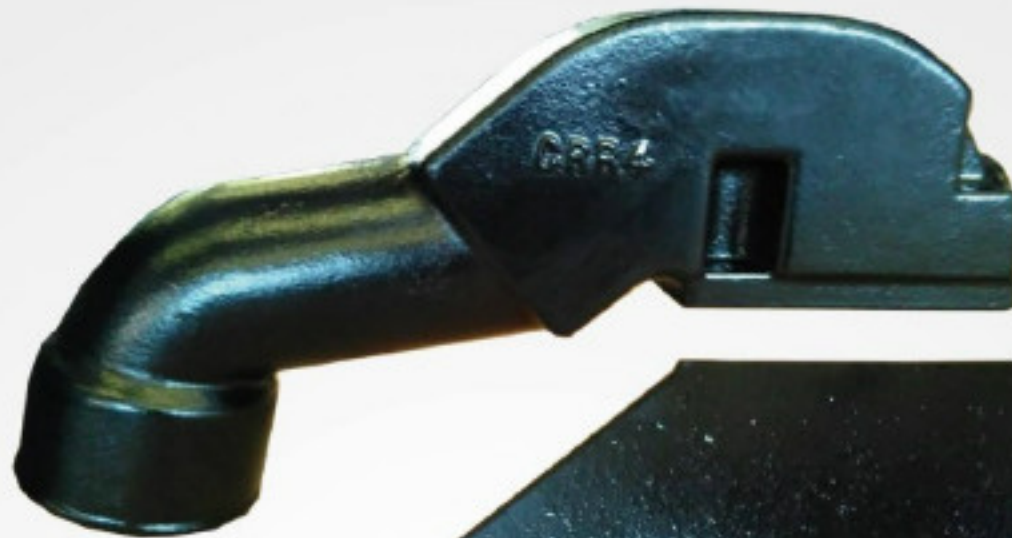
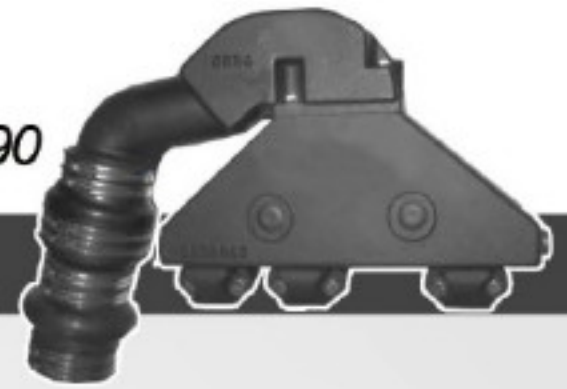

T-20374 Riser
3.5" outlet

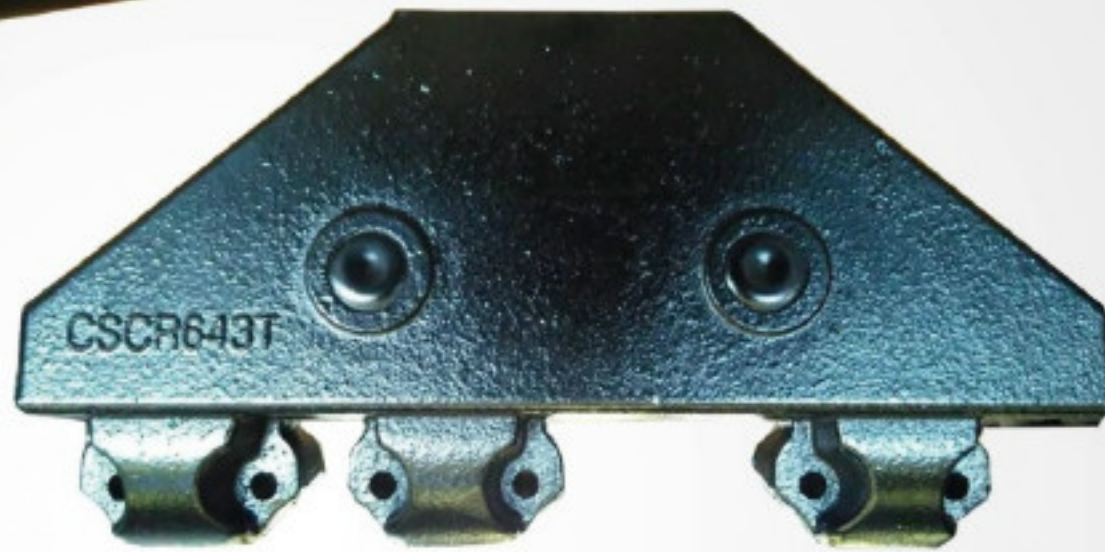

T-20643 Manifold
Replaces OMC # 984221 and 984222

T-20354 Hose Adapter, 3.5" - 4.5"



- * Small Stainless Clamp *6 pcs per side
- * Big Stainless Clamp *2 pcs per side
- * Bellows, Reducer. OMC # 912328
- * Bellows, Hump. OMC # 3852741



20643-MK
Mounting kit, Manifold
Includes gasket and mounting hardware

*82909 Gasket



20374-MK
Mounting kit, Riser
Includes gasket and mounting hardware

*82882 Gasket

Graphite w/ SS304 Gasket

Chrysler



82941
Riser/Elbow gasket

Chrysler



80472
Riser/Elbow gasket

Chrysler



80826
Manifold Gasket (Small Block V8 318-360)

Crusader



80305
Riser gasket

Crusader



80309
Elbow gasket

Crusader



80475
Riser gasket

Marine Power, Barr, Indmar



82854
Riser gasket



80476
Riser gasket

Mercuriser



82832
End Plate gasket

Mercuriser



82833
Riser gasket

Mercuriser



80113
Elbow/Reservoir gasket

Mercuriser



80897
Riser gasket (Open)

Mercuriser



82849
Riser gasket (Restrictor)

Mercuriser



80881
Elbow/Reservoir gasket

OMC



80942
Riser gasket

OMC



80943
Riser gasket

PleasureCraft



80677
Riser gasket

Volvo



82971
Riser gasket

Volvo



82991
Manifold gasket



Graphite w/ SS304 Gasket



Ford

80183

Manifold gasket (Small Block V8)



GM

82909

Manifold gasket (V6)



GM

80872

Manifold gasket (Small Block V8)



GM

80418

Manifold gasket (Big Block V8)



GM

82896

Manifold gasket (4 Cylinder)

Installation Procedure

PLEASE READ BEFORE EXHAUST COMPONENT INSTALLATION

External Paint/ Coatings: All QMI exhaust components have been painted for corrosion protection and to allow immediate installation out of the box. The black paint utilized will accept additional enamel top coats if the desire is to match the current OEM paint color.

Gasket/ Gasket Surfaces: During installation, it is recommended to remove the paint from any gasket surfaces. This provides the best seal as the exhaust gaskets are designed to be installed dry, without the use of any gasket sealants. The addition of sealants can result in gasket failure and subsequent water intrusion, either internally or externally. **DO NOT** remove the paint from the gasket mounting surfaces with any type of power tools or power assisted devices such as high speed rotary gasket removers, wire wheels, or sand paper flappers. Any type of mechanical or power paint removal could result in an uneven deck surface and improper sealing between components. The use of acetone or lacquer thinner will remove the paint without damaging the deck surface.

Pipe Plugs and Fittings: The pipe plugs and fittings for the exhaust components are tapered and should be installed to a snug fit and not-overtightened. Do not attempt to screw the plugs flush with the casting, this could result in an over-tightened situation. Over-tightened fittings can crack the casting, resulting in an unusable product.

Mounting Hardware: All mounting hardware supplied is of a grade 5 or higher, unless otherwise specified by the OE manufacturer. Lower grade bolts or stainless steel components are too soft and will not hold the proper torque setting if used in applications that are not designed for these materials. For proper sealing, torque settings should be reset after initial start and warm-up. Please refer to the original manufacturers service manual for specific torque setting. **STUD** installation requires the use of red thread locking compound to prevent studs from backing out or loosening during normal engine operation. **DO NOT** use any type of anti-seize on any mounting hardware as the lubricating properties will result in the hardware backing out.



Warranty

THREE YEAR LIMITED WARRANTY QUALITY MARK, INC.

QUALITY MARK, INC., a Minnesota Corporation (the "Company") and its authorized exclusive suppliers manufacture exhaust manifolds, risers and exhaust connectors for use in marine engines (the "Product"), among other things. The Company warrants these Products against defects in workmanship and/or material to the Original Purchaser for a period of three years from the date of purchase. For purposes of this warranty, the Original Purchaser must have purchased the Product for non-commercial use, from an authorized seller within the Company's intended chain of sales and/or distribution for the Product's intended use.



This warranty is subject to the following limitations:

The Company must be notified of any warranted defect within three years of purchase by the Original Purchaser. This warranty does not extend to anyone other than the Original Purchaser. The Company will not be responsible for the cost of shipping, removal or installation of the Product. Any Product that the Company determines is defective will be repaired or replaced as appropriate, at the Company's sole option.

Any implied warranties such as merchantability or fitness are also hereby limited to the three-year period of this warranty except where otherwise prohibited. Similarly, the Company shall not be liable for any incidental, consequential or special damages except to the extent otherwise prohibited.

This warranty does not cover defects that are caused by ordinary wear and tear, modification, excessive use, misuse, improper installation and/or improper handling.

H2O PART NUMBER INDEX

QMI Number	Description	OEM	OEM #	Page
80113	Gasket	Mercury	27-97542, 27-856705	21
80183	Gasket	Multiple		12.13.48.49
80305	Gasket	Crusader	96108	27.36
80309	Gasket	Crusader	96562	24.28.31
80418	Gasket	Multiple		8.29.30.32.46
80472	Gasket	Chrysler	2847480, 2469559	37.38.40.42
80475	Gasket	Crusader	98127	33.34
80476	Gasket	Barr	01-0105	43.44.47
80677	Gasket	Pleasurecraft	RM0002	50.51
80826	Gasket	Chrysler		41
80872	Gasket	Multiple		6.7.15.25.26.45.52.56.57.58
80881	Gasket	Mercury	27-18272, 27-97863	11
80897	Gasket	Mercury	27-41813	5.9.10.16.22
80942	Gasket			55
80943	Gasket	OMC, Volvo	909786, 3850496	59
82832	Gasket	Mercury	27-480431	19
82833	Gasket	Mercury	27-997772	14.17.20.23
82849	Gasket	Mercury	27-818832, 27-87105-1, 27-863726	9.10
82854	Gasket	Barr	01-0107	43.44.47
82882	Gasket			60
82896	Gasket	Multiple		62
82909	Gasket	Multiple		18.60
82941	Gasket	Chrysler	N/A	39
82971	Gasket	Volvo	835908-5, 856039-3	53
82991	Gasket	Volvo	855383, 855967	54
20244-MK	Mounting kit			56.57.58
20374-MK	Mounting kit			60
20480-MK	Mounting kit			39
20480-MK-FW	Mounting kit			37.38.40.42
20560-MK	Mounting kit			12.13
20643-MK	Mounting kit			60
20775-MK	Mounting kit			25.26
20799-MK	Mounting kit			29.30
20898-MK	Mounting kit			46
20899-MK	Mounting kit			50.51
20905-MK	Mounting kit			21
20906-MK	Mounting kit			20
20908-MK	Mounting kit			9.10
20908-MK-FW	Mounting kit			9
20909-MK	Mounting kit			55
20916-MK	Mounting kit			36
20921-MK	Mounting kit			59
20927-MK	Mounting kit			27
20930-MK	Mounting kit			54
20931-MK	Mounting kit			52
20935-MK	Mounting kit			63
20937-MK	Mounting kit			11
20938-MK	Mounting kit			34

H2O PART NUMBER INDEX

QMI Number	Description	OEM	OEM #	Page
20940-MK	Mounting kit			41
20952-MK	Mounting kit			18
20956-MK	Mounting kit			3
20957-MK	Mounting kit			8
20966-MK	Mounting kit			4
20975-MK	Mounting kit			23
20976-MK	Mounting kit			5
20982-MK	Mounting kit			32
20992-MK	Mounting kit			43.44.47
20992-MK-FW	Mounting kit			43.44.47
20996-MK	Mounting kit			49
20997-MK	Mounting kit			45
20998-MK	Mounting kit			48
26371-MK	Mounting kit			14.17
26562-MK	Mounting kit			24.28.31
27214-MK	Mounting kit			6.7
28503-MK	Mounting kit			16.22
30009-MK	Mounting kit			19
30984-MK	Mounting kit			33
T-20011	Riser, Elbow	PCM	R029011	51
T-20296	Plate, Block Off	Crusader	97296	35
T-20354	Hose Adapter	OSCO	3545HA	60
T-20374	Riser	OMC	984221, 984222	60
T-20591	Dry joint riser	Mercuriser	864591T02	1
T-20643	Manifold	OMC	984221, 984222	60
T-20735	Dry joint manifold V-8	Mercuriser	865735A02	2
T-20898	Manifold	Universal	Big Block GM	46
T-20899	Riser, Elbow	PCM	R029001	50
T-20902	Manifold, strbd V-8	OMC	912441	57
T-20903	Manifold, port V-8	OMC	912442	58
T-20905	Riser, Elbow	Mercuriser	90880	21
T-20906	Spacer, Manifold	Mercuriser	61851A1	20
T-20907	Riser, Elbow	Indmar	53-2009, 53-2018	47
T-20908	Spacer, Manifold	Mercuriser	93320	9
T-20909	Riser, Exhaust 4	OMC/VP	3855270-9	55
T-20913	Riser, Elbow	Chrysler	2469639, 2847405	42
T-20916	Riser, Elbow	Crusader	97169	36
T-20918	Riser, Elbow	Crusader	97386	24
T-20921	Riser, Elbow	OMC	909863	59
T-20925	Riser, Elbow	Crusader	96120, 97752	25
T-20926	Manifold	Crusader	96121, 97753	26
T-20927	Manifold	Crusader	97772	27
T-20928	Riser, Elbow	Crusader	97924	28
T-20929	Riser, Elbow	Crusader	97114, 97992	29
T-20930	Manifold, 4 cyl	Volvo	834438-4, 855387-7	54
T-20931	Manifold, V-8 ctr riser	Volvo	835804	52
T-20933	Manifold	Crusader	97115, 97993	30
T-20934	Riser, Elbow	Crusader	98068	31
T-20935	Riser, Elbow	VP	856891, 855384-4	53

H2O PART NUMBER INDEX

QMI Number	Description	OEM	OEM #	Page
T-20937	Riser, Elbow	Mercruiser	98562A6	11
T-20938	Riser, Elbow	Crusader	98126	34
T-20939	Riser, Elbow	Universal	Use with Universal Manifolds	44
T-20940	Manifold, Exhaust	Chrysler	3675826, 4142322	41
T-20941	Manifold End Plate	Chrysler	2846106, 2469556, 367826	38
T-20942	Manifold End Plate	Chrysler	3675826	39
T-20945	Riser, Elbow	Chrysler	2846689	38
T-20946	Riser, Elbow	Chrysler	3527784	40
T-20950	Manifold	Mercruiser	77234A2	6
T-20951	Manifold	Mercruiser	77235A8	8
T-20952	Manifold, V-6 ctr riser	Mercruiser	99746A17	18
T-20953	Manifold, V-8 ctr riser	Mercruiser	87114, 860246A15	15
T-20956	Manifold	Mercruiser	860235A04	3
T-20957	Manifold, V-8 BB ctr riser	Mercruiser	89011A8, 807078T10	8
T-20958	Manifold (Port Only)	Mercruiser	65604A12	13
T-20962	Manifold	Mercruiser	65603A12, 54099A5	12
T-20966	Manifold	Mercruiser	860235A03	4
T-20970	Riser, Elbow 3	Mercruiser	98504A3	16
T-20971	Riser, Elbow 3	Mercruiser	76351A04	17
T-20974	Riser, Elbow	Mercruiser	98502A2	22
T-20975	Riser, Elbow	Mercruiser	12076A2	23
T-20976	Riser, Elbow 4	Mercruiser	44354A3, 807914A1, 807988	5
T-20978	Riser, Elbow	Mercruiser	76771A3	14
T-20982	Manifold	Crusader	98125	32
T-20985	Spacer, Manifold	Mercruiser	93322	10
T-20986	Manifold, V-8 ctr riser	OMC/VP	3852374-2	56
T-20996	Manifold	PCM	R028001	49
T-20997	Riser, Elbow	Universal	Small Block GM	45
T-20998	Riser, Elbow	Universal	Small Block Ford	48
T-20999	Manifold	Universal	Big Block GM	43
T-30009	Plate, End	Mercruiser	60252A2	19
T-30984	Spacer, Manifold	Crusader	98128	33

OEM Interchange Guide

OEM	OEM #	QMI Number	Description	Page
Barr	01-0105	80476	Gasket	43.44.47
Barr	01-0107	82854	Gasket	43.44.47
Chrysler	2847480, 2469559	80472	Gasket	37.38.40.42
Chrysler		80826	Gasket	41
Chrysler	N/A	82941	Gasket	39
Chrysler	2469639, 2847405	T-20913	Riser, Elbow	42
Chrysler	3675826, 4142322	T-20940	Manifold, Exhaust	41
Chrysler	2846106, 2469556, 367826	T-20941	Manifold End Plate	38
Chrysler	3675826	T-20942	Manifold End Plate	39
Chrysler	2846689	T-20945	Riser, Elbow	38
Chrysler	3527784	T-20946	Riser, Elbow	40
Crusader	96108	80305	Gasket	27.36
Crusader	96562	80309	Gasket	24.28.31
Crusader	98127	80475	Gasket	33.34
Crusader	97296	T-20296	Plate, Block Off	35
Crusader	97169	T-20916	Riser, Elbow	36
Crusader	97386	T-20918	Riser, Elbow	24
Crusader	96120, 97752	T-20925	Riser, Elbow	25
Crusader	96121, 97753	T-20926	Manifold	26
Crusader	97772	T-20927	Manifold	27
Crusader	97924	T-20928	Riser, Elbow	28
Crusader	97114, 97992	T-20929	Riser, Elbow	29
Crusader	97115, 97993	T-20933	Manifold	30
Crusader	98068	T-20934	Riser, Elbow	31
Crusader	98126	T-20938	Riser, Elbow	34
Crusader	98125	T-20982	Manifold	32
Crusader	98128	T-30984	Spacer, Manifold	33
Indmar	53-2009, 53-2018	T-20907	Riser, Elbow	47
Mercury	27-97542, 27-856705	80113	Gasket	21
Mercury	27-18272, 27-97863	80881	Gasket	11
Mercury	27-41813	80897	Gasket	5.9.10.16.22
Mercury	27-480431	82832	Gasket	19
Mercury	27-997772	82833	Gasket	14.17.20.23
Mercury	27-818832, 27-87105-1, 27-863726	82849	Gasket	9.10
Mercury	864591T02	T-20591	Dry joint riser	1
Mercury	865735A02	T-20735	Dry joint manifold V-8	2
Mercury	90880	T-20905	Riser, Elbow	21
Mercury	61851A1	T-20906	Spacer, Manifold	20
Mercury	93320	T-20908	Spacer, Manifold	9
Mercury	98562A6	T-20937	Riser, Elbow	11
Mercury	77234A2	T-20950	Manifold	6
Mercury	77235A8	T-20951	Manifold	8
Mercury	99746A17	T-20952	Manifold, V-6 ctr riser	18
Mercury	87114, 860246A15	T-20953	Manifold, V-8 ctr riser	15

OEM Interchange Guide

OEM	OEM #	QMI Number	Description	Page
MerCruiser	860235A04	T-20956	Manifold	3
MerCruiser	89011A8, 807078T10	T-20957	Manifold, V-8 BB ctr riser	8
MerCruiser	65604A12	T-20958	Manifold (Port Only)	13
MerCruiser	65603A12, 54099A5	T-20962	Manifold	12
MerCruiser	860235A03	T-20966	Manifold	4
MerCruiser	98504A3	T-20970	Riser, Elbow 3	16
MerCruiser	76351A04	T-20971	Riser, Elbow 3	17
MerCruiser	98502A2	T-20974	Riser, Elbow	22
MerCruiser	12076A2	T-20975	Riser, Elbow	23
MerCruiser	44354A3, 807914A1, 807988	T-20976	Riser, Elbow 4	5
MerCruiser	76771A3	T-20978	Riser, Elbow	14
MerCruiser	93322	T-20985	Spacer, Manifold	10
MerCruiser	60252A2	T-30009	Plate, End	19
Multiple		80183	Gasket	12.13.48.49
Multiple		80418	Gasket	8.29.30.32.46
Multiple		80872	Gasket	15.25.26.45.52.56.57.58
Multiple		82896	Gasket	62
Multiple		82909	Gasket	18.60
OMC	984221, 984222	T-20374	Riser	60
OMC	984221, 984222	T-20643	Manifold	60
OMC	912441	T-20902	Manifold, strbd V-8	57
OMC	912442	T-20903	Manifold, port V-8	58
OMC	909863	T-20921	Riser, Elbow	59
OMC, Volvo	909786, 3850496	80943	Gasket	59
OMC/VP	3855270-9	T-20909	Riser, Exhaust 4	55
OMC/VP	3852374-2	T-20986	Manifold, V-8 ctr riser	56
PCM	R029011	T-20011	Riser, Elbow	51
PCM	R029001	T-20899	Riser, Elbow	50
PCM	R028001	T-20996	Manifold	49
Pleasurecraft	RM0002	80677	Gasket	50.51
Universal	Big Block GM	T-20898	Manifold	46
Universal	Use with Universal Manifolds	T-20939	Riser, Elbow	44
Universal	Small Block GM	T-20997	Riser, Elbow	45
Universal	Small Block Ford	T-20998	Riser, Elbow	48
Universal	Big Block GM	T-20999	Manifold	43
Volvo	834438-4, 855387-7	T-20930	Manifold, 4 cyl	54
Volvo	835804	T-20931	Manifold, V-8 ctr riser	52
Volvo	835908-5, 856039-3	82971	Gasket	53
Volvo	855383, 855967	82991	Gasket	54
VP	856891, 855384-4	T-20935	Riser, Elbow	53

Barr Interchange Guide

Brand	Barr Number	QMI Number	Description	Page
Barr	01-0105	80476	Gasket	43.44.47
Barr	01-0107	82854	Gasket	43.44.47
Barr	1-60252	T-30009	Plate, End	19
Barr	20-0082	T-20999	Manifold	43
Barr	20-0082P	20992-MK	Mounting kit	43.44.47
Barr	20-0100	T-20939	Riser, Elbow	44
Barr	20-0102	T-20907	Riser, Elbow	47
Barr	CHV-1-83	T-20997	Riser, Elbow	45
Barr	CHVA-1-84	T-20898	Manifold	46
Barr	CM-1-6672-B	T-20941	Manifold End Plate	38
Barr	CM-1-6672H	T-20942	Manifold End Plate	39
Barr	CM-1-6677A	T-20940	Manifold, Exhaust	41
Barr	CM-20-2847405	T-20913	Riser, Elbow	42
Barr	CM-20-6672	T-20946	Riser, Elbow	40
Barr	CM-206672JP	20480-MK	Mounting kit	39
Barr	CM-20-6674	T-20945	Riser, Elbow	38
Barr	CM-20-6674JP	20480-MK-FW	Mounting kit	37.38.40.42
Barr	CR-1-97752	T-20925	Riser, Elbow	25
Barr	CR-1-97753	T-20926	Manifold	26
Barr	CR-1-97992	T-20929	Riser, Elbow	29
Barr	CR-1-97993	T-20933	Manifold	30
Barr	CR-20-97169	T-20916	Riser, Elbow	36
Barr	CR-20-97296	T-20296	Plate, Block Off	35
Barr	CR-20-97772	T-20927	Manifold	27
Barr	CR-20-9786	T-20918	Riser, Elbow	24
Barr	CR-20-97924	T-20928	Riser, Elbow	28
Barr	CR-20-98068	T-20934	Riser, Elbow	31
Barr	CR-20-98128	T-30984	Spacer, Manifold	33
Barr	CR-98126	T-20938	Riser, Elbow	34
Barr	FM-1-83	T-20998	Riser, Elbow	48
Barr	MC-1-65603	T-20962	Manifold	12
Barr	MC-1-65604	T-20958	Manifold (Port Only)	13
Barr	MC-1-77234	T-20950	Manifold	6
Barr	MC-1-77235	T-20951	Manifold	8
Barr	MC-1-865735	T-20735	Dry joint manifold V-8	2
Barr	MC-1-87114	T-20953	Manifold, V-8 ctr riser	15
Barr	MC-1-89011	T-20957	Manifold, V-8 BB ctr riser	8
Barr	MC-1-99746	T-20952	Manifold, V-6 ctr riser	18
Barr	MC-20-12076	T-20975	Riser, Elbow	23
Barr	MC-20-44354	T-20976	Riser, Elbow 4	5
Barr	MC-20-60426P	26371-MK	Mounting kit	14.17
Barr	MC-20-61851A2	T-20906	Spacer, Manifold	20
Barr	MC-20-76351	T-20971	Riser, Elbow 3	17

Barr Interchange Guide

Brand	Barr Number	QMI Number	Description	Page
Barr	MC-20-76771	T-20978	Riser, Elbow	14
Barr	MC-20-864591	T-20591	Dry joint riser	1
Barr	MC-20-90880	T-20905	Riser, Elbow	21
Barr	MC-20-93320A3	T-20908	Spacer, Manifold	9
Barr	MC-20-93322A3	T-20985	Spacer, Manifold	10
Barr	MC-20-98502	T-20974	Riser, Elbow	22
Barr	MC-20-98504	T-20970	Riser, Elbow 3	16
Barr	MC-47-27-33395	80872	Gasket	6.7.15.25.26.45.52.56.57.58
Barr	MC-47-27-41813	80897	Gasket	5.9.10.16.22
Barr	MC-47-27-46820	80418	Gasket	8.29.30.32.46
Barr	MC-47-27-48043	82832	Gasket	19
Barr	MC-47-2752546	82896	Gasket	62
Barr	MC-47-27-73866	80183	Gasket	12.13.48.49
Barr	MC-47-27-87105	82849	Gasket	9.10
Barr	MC-47-27-97542	80113	Gasket	21
Barr	MC-47-27-99757	82909	Gasket	18.60
Barr	MC-47-27-99777	82833	Gasket	14.17.20.23
Barr	OMC-120-913784	T-20909	Riser, Exhaust 4	55
Barr	OMC-1-912441	T-20902	Manifold, strbd V-8	57
Barr	OMC-1-912442	T-20903	Manifold, port V-8	58
Barr	OMC-1-914035	T-20986	Manifold, V-8 ctr riser	56
Barr	OMC-20-982680	T-20921	Riser, Elbow	59
Barr	OMC-47-909786	80943	Gasket	59
Barr	VO-1-835804	T-20931	Manifold, V-8 ctr riser	52
Barr	VO-1-855387	T-20930	Manifold, 4 cyl	54
Barr	VO-20-855384	T-20935	Riser, Elbow	53
Barr	VO-47-835908	82971	Gasket	53
Barr	VO-47-855383	82991	Gasket	54

Sierra Interchange Guide

Brand	Sierra Number	QMI Number	Description	Page
Sierra	18-0113	80113	Gasket	21
Sierra	18-0183	80183	Gasket	12.13.48.49
Sierra	18-0305	80305	Gasket	27.36
Sierra	18-0309	80309	Gasket	24.28.31
Sierra	18-0418	80418	Gasket	8.29.30.32.46
Sierra	18-0475	80475	Gasket	33.34
Sierra	18-0476-1	80476	Gasket	43.44.47
Sierra	18-0677	80677	Gasket	50.51
Sierra	18-0872	80872	Gasket	6.7.15.25.26.45.52.56.57.58
Sierra	18-0881	80881	Gasket	11
Sierra	18-0897	80897	Gasket	5.9.10.16.22
Sierra	18-0943	80943	Gasket	59
Sierra	18-1843	T-20735	Dry joint manifold V-8	2
Sierra	18-1845	T-20591	Dry joint riser	1
Sierra	18-1898	T-20898	Manifold	46
Sierra	18-1902	T-20902	Manifold, strbd V-8	57
Sierra	18-1903	T-20903	Manifold, port V-8	58
Sierra	18-1905	T-20905	Riser, Elbow	21
Sierra	18-1906	T-20906	Spacer, Manifold	20
Sierra	18-1907	T-20907	Riser, Elbow	47
Sierra	18-1908	T-20908	Spacer, Manifold	9
Sierra	18-1909-1	T-20909	Riser, Exhaust 4	55
Sierra	18-1913	T-20913	Riser, Elbow	42
Sierra	18-1916	T-20916	Riser, Elbow	36
Sierra	18-1917	T-20296	Plate, Block Off	35
Sierra	18-1918	T-20918	Riser, Elbow	24
Sierra	18-1921	T-20921	Riser, Elbow	59
Sierra	18-1925	T-20925	Riser, Elbow	25
Sierra	18-1926	T-20926	Manifold	26
Sierra	18-1927	T-20927	Manifold	27
Sierra	18-1928	T-20928	Riser, Elbow	28
Sierra	18-1929	T-20929	Riser, Elbow	29
Sierra	18-1930-1	T-20930	Manifold, 4 cyl	54
Sierra	18-1931-1	T-20931	Manifold, V-8 ctr riser	52
Sierra	18-1933	T-20933	Manifold	30
Sierra	18-1934	T-20934	Riser, Elbow	31
Sierra	18-1935-1	T-20935	Riser, Elbow	53
Sierra	18-1937	T-20937	Riser, Elbow	11
Sierra	18-1938	T-20938	Riser, Elbow	34
Sierra	18-1939	T-20939	Riser, Elbow	44
Sierra	18-1940	T-20940	Manifold, Exhaust	41
Sierra	18-1941	T-20941	Manifold End Plate	38
Sierra	18-1942	T-20942	Manifold End Plate	39
Sierra	18-1945	T-20945	Riser, Elbow	38
Sierra	18-1946	T-20946	Riser, Elbow	40
Sierra	18-1950-1	T-20950	Manifold	6

Sierra Interchange Guide

Brand	Sierra Number	QMI Number	Description	Page
Sierra	18-1951-1	T-20951	Manifold	8
Sierra	18-1952-1	T-20952	Manifold, V-6 ctr riser	18
Sierra	18-1953-2	T-20953	Manifold, V-8 ctr riser	15
Sierra	18-1956-2	T-20956	Manifold	3
Sierra	18-1957-1	T-20957	Manifold, V-8 BB ctr riser	8
Sierra	18-1958-1	T-20958	Manifold (Port Only)	13
Sierra	18-1962-1	T-20962	Manifold	12
Sierra	18-1966	T-20966	Manifold	4
Sierra	18-1970-1	T-20970	Riser, Elbow 3	16
Sierra	18-1971	T-20971	Riser, Elbow 3	17
Sierra	18-1974-1	T-20974	Riser, Elbow	22
Sierra	18-1975-1	T-20975	Riser, Elbow	23
Sierra	18-1976-2	T-20976	Riser, Elbow 4	5
Sierra	18-1978	T-20978	Riser, Elbow	14
Sierra	18-1982	T-20982	Manifold	32
Sierra	18-1984	T-30984	Spacer, Manifold	33
Sierra	18-1985	T-20985	Spacer, Manifold	10
Sierra	18-1986-1	T-20986	Manifold, V-8 ctr riser	56
Sierra	18-1996	T-20996	Manifold	49
Sierra	18-1997-1	T-20997	Riser, Elbow	45
Sierra	18-1998-1	T-20998	Riser, Elbow	48
Sierra	18-1999	T-20999	Manifold	43
Sierra	18-2832	82832	Gasket	19
Sierra	18-2833	82833	Gasket	14.17.20.23
Sierra	18-2849	82849	Gasket	9.10
Sierra	18-2854	82854	Gasket	43.44.47
Sierra	18-2896	82896	Gasket	62
Sierra	18-2909	82909	Gasket	18.60
Sierra	18-2941	80472	Gasket	37.38.40.42
Sierra	18-2971-1	82971	Gasket	53
Sierra	18-2991-1	82991	Gasket	54
Sierra	18-4009	T-30009	Plate, End	19
Sierra	18-4360	20480-MK	Mounting kit	39
Sierra	18-4362	26371-MK	Mounting kit	14.17
Sierra	18-4364	20992-MK	Mounting kit	43.44.47
Sierra	18-4526	20940-MK	Mounting kit	41
Sierra	18-4536	20997-MK	Mounting kit	45
Sierra	18-8500	20905-MK	Mounting kit	21
Sierra	18-8502	20244-MK	Mounting kit	56.57.58
Sierra	18-8503	20996-MK	Mounting kit	49
Sierra	18-8504	20899-MK	Mounting kit	50.51
Sierra	18-8505	20976-MK	Mounting kit	5
Sierra	18-8506	20480-MK-FW	Mounting kit	37.38.40.42
Sierra	18-8507	20909-MK	Mounting kit	55
Sierra	18-8509	20560-MK	Mounting kit	12.13

Sierra Interchange Guide

Brand	Sierra Number	QMI Number	Description	Page
Sierra	188510	20935-MK	Mounting kit	63
Sierra	188511	20931-MK	Mounting kit	52
Sierra	188512	30009-MK	Mounting kit	19
Sierra	188515	26562-MK	Mounting kit	24.28.31
Sierra	18-8519	20916-MK	Mounting kit	36
Sierra	18-8521	20775-MK	Mounting kit	25.26
Sierra	18-8523	20927-MK	Mounting kit	27
Sierra	18-8524	20799-MK	Mounting kit	29.30
Sierra	18-8529	28503-MK	Mounting kit	16.22
Sierra	18-8530	20937-MK	Mounting kit	11
Sierra	18-8532	20957-MK	Mounting kit	8
Sierra	188533	20952-MK	Mounting kit	18
Sierra	188534	20921-MK	Mounting kit	59
Sierra	188538	20998-MK	Mounting kit	48
Sierra	188539	20930-MK	Mounting kit	54
Sierra	188544	20982-MK	Mounting kit	32
Sierra	188546	30984-MK	Mounting kit	33
Sierra	188547	20938-MK	Mounting kit	34
Sierra	188551	20975-MK	Mounting kit	23
Sierra	18-8554	20908-MK	Mounting kit	9.10