

# i50

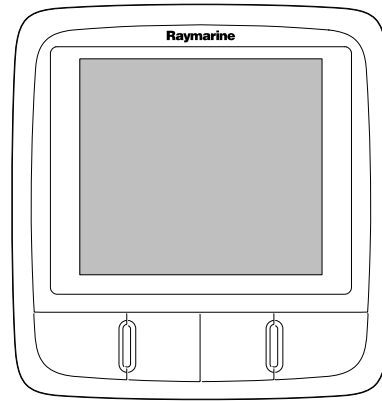

## Installation and operation instructions

English

**Trademark and patents notice**

Autohelm, hsb<sup>2</sup>, RayTech Navigator, Sail Pilot, SeaTalk, SeaTalk<sup>NG</sup>, SeaTalk<sup>HS</sup> and Sportpilot are registered trademarks of Raymarine UK Limited. RayTalk, Seahawk, Smartpilot, Pathfinder and Raymarine are registered trademarks of Raymarine Holdings Limited.

FLIR is a registered trademark of FLIR Systems, Inc. and/or its subsidiaries.

All other trademarks, trade names, or company names referenced herein are used for identification only and are the property of their respective owners.

This product is protected by patents, design patents, patents pending, or design patents pending.

**Fair Use Statement**

You may print no more than three copies of this manual for your own use. You may not make any further copies or distribute or use the manual in any other way including without limitation exploiting the manual commercially or giving or selling copies to third parties.

# Contents

## Chapter 1 Important information

- Safety notices
- Water ingress
- Disclaimer
- EMC installation guidelines
- Suppression ferrites
- Connections to other equipment
- Declaration of conformity
- Product disposal
- Warranty registration
- IMO and SOLAS
- Technical accuracy

## Chapter 2 Handbook information

- 2.1 Handbook information

## Chapter 3 Planning the installation

- 3.1 Installation checklist
- 3.2 System integration
- 3.3 Typical systems
- 3.4 System protocols
- 3.5 Parts supplied
- 3.6 Tools required

## Chapter 4 Cables and connections

- 4.1 General cabling guidance
- 4.2 Connections overview

## Chapter 5 Location and mounting

- 5.1 Selecting a display location
- 5.2 Mounting
- 5.3 Front bezel
- 5.4 Selecting a transducer location

## Chapter 6 Getting started

- 6.1 Controls
- 6.2 Power
- 6.3 Data master
- 6.4 Illumination
- 6.5 Calibration

## Chapter 7 Using your display

- 7.1 Pages
- 7.2 i50 Depth operation
- 7.3 i50 Speed operation
- 7.4 i50 Tridata operation
- 7.5 Group illumination

## Chapter 8 Using alarms

- 8.1 Alarms

## Chapter 9 Maintaining your display

- 9.1 Service and maintenance
- 9.2 Condensation
- 9.3 Routine equipment checks

- 9.4 Cleaning
- 9.5 Cleaning the display case
- 9.6 Cleaning the display screen

## Chapter 10 Troubleshooting

- 10.1 Troubleshooting
- 10.2 Instrument troubleshooting
- 10.3 Power up troubleshooting
- 10.4 Miscellaneous troubleshooting
- 10.5 Self-test

## Chapter 11 Technical support

- 11.1 Raymarine customer support
- 11.2 Checking the software version

## Chapter 12 Technical specification

- 12.1 Technical specification

## Chapter 13 Spares and accessories

- 13.1 i50 transducers
- 13.2 Spares
- 13.3 SeaTalk<sup>ng</sup> cables and accessories
- 13.4 Converters

## Appendix A NMEA 2000 sentences

# Chapter 1: Important information

## Safety notices



### Warning: Product installation and operation

This product must be installed and operated in accordance with the instructions provided. Failure to do so could result in personal injury, damage to your vessel and/or poor product performance.



### Warning: Potential ignition source

This product is NOT approved for use in hazardous/flammable atmospheres. Do NOT install in a hazardous/flammable atmosphere (such as in an engine room or near fuel tanks).



### Warning: High voltage

This product contains high voltage. Adjustments require specialized service procedures and tools only available to qualified service technicians. There are no user serviceable parts or adjustments. The operator should never remove the cover or attempt to service the product.



### Warning: Positive ground systems

Do not connect this unit to a system which has positive grounding.



### Warning: Switch off power supply

Ensure the vessel's power supply is switched OFF before starting to install this product. Do NOT connect or disconnect equipment with the power switched on, unless instructed in this document.

### Caution: Transducer cable

Do NOT cut, shorten, splice the transducer cable or remove the connector. If the cable is cut, it cannot be repaired. Cutting the cable will also void the warranty.

### Caution: Power supply protection

When installing this product ensure the power source is adequately protected by means of a suitably-rated fuse or automatic circuit breaker.

### Caution: Service and maintenance

This product contains no user serviceable components. Please refer all maintenance and repair to authorized Raymarine dealers. Unauthorized repair may affect your warranty.

### Caution: Cleaning

When cleaning this product:

- Do NOT wipe the display screen with a dry cloth, as this could scratch the screen coating.
- Do NOT use abrasive, or acid or ammonia based products.
- Do NOT use a jet wash.

## Caution: Condensation

Certain atmospheric conditions may cause a small amount of condensation to form on the unit's window. This will not damage the unit and will clear after the unit has been switched on for a short period.

## Water ingress

Water ingress disclaimer

Although the waterproof rating capacity of this product meets the IPX6 standard, water intrusion and subsequent equipment failure may occur if the product is subjected to commercial high-pressure washing. Raymarine will not warrant products subjected to high-pressure washing.

## Disclaimer

Raymarine does not warrant that this product is error-free or that it is compatible with products manufactured by any person or entity other than Raymarine.

Raymarine is not responsible for damages or injuries caused by your use or inability to use the product, by the interaction of the product with products manufactured by others, or by errors in information utilized by the product supplied by third parties.

## EMC installation guidelines

Raymarine equipment and accessories conform to the appropriate Electromagnetic Compatibility (EMC) regulations, to minimize electromagnetic interference between equipment and minimize the effect such interference could have on the performance of your system

Correct installation is required to ensure that EMC performance is not compromised.

For **optimum** EMC performance we recommend that wherever possible:

- Raymarine equipment and cables connected to it are:
  - At least 1 m (3 ft) from any equipment transmitting or cables carrying radio signals e.g. VHF radios, cables and antennas. In the case of SSB radios, the distance should be increased to 7 ft (2 m).
  - More than 2 m (7 ft) from the path of a radar beam. A radar beam can normally be assumed to spread 20 degrees above and below the radiating element.
- The product is supplied from a separate battery from that used for engine start. This is important to prevent erratic behavior and data loss which can occur if the engine start does not have a separate battery.
- Raymarine specified cables are used.
- Cables are not cut or extended, unless doing so is detailed in the installation manual.

**Note: Where constraints on the installation prevent any of the above recommendations**, always ensure the maximum possible separation between different items of electrical equipment, to provide the best conditions for EMC performance throughout the installation

## Suppression ferrites

Raymarine cables may be fitted with suppression ferrites. These are important for correct EMC performance. If a ferrite has to be removed for any purpose (e.g. installation or maintenance), it must be replaced in the original position before the product is used.

Use only ferrites of the correct type, supplied by Raymarine authorized dealers.

## Connections to other equipment

Requirement for ferrites on non-Raymarine cables

If your Raymarine equipment is to be connected to other equipment using a cable not supplied by Raymarine, a suppression ferrite **MUST** always be attached to the cable near the Raymarine unit.

## Declaration of conformity

Raymarine UK Ltd. declares that this product is compliant with the essential requirements of EMC directive 2004/108/EC.

## Product disposal

Dispose of this product in accordance with the WEEE Directive.



■ The Waste Electrical and Electronic Equipment (WEEE) Directive requires the recycling of waste electrical and electronic equipment. Whilst the WEEE Directive does not apply to some Raymarine products, we support its policy and ask you to be aware of how to dispose of this product.

## Warranty registration

It is important that you register your product to receive full warranty benefits. Your unit package includes a bar code label indicating the serial number of the unit. You will need this serial number when registering your product online. You should retain the label for future reference.

## IMO and SOLAS

The equipment described within this document is intended for use on leisure marine boats and workboats not covered by International Maritime Organization (IMO) and Safety of Life at Sea (SOLAS) Carriage Regulations.

## Technical accuracy

To the best of our knowledge, the information in this document was correct at the time it was produced. However, Raymarine cannot accept liability for any inaccuracies or omissions it may contain. In addition, our policy of continuous product improvement may change specifications without notice.

# Chapter 2: Handbook information

## Chapter contents

- [2.1 Handbook information](#)

## 2.1 Handbook information

This handbook contains important information regarding your Raymarine instrument display.

### i50 Handbooks

The following handbooks are applicable to your product:

#### Handbooks

Description	Part number
Mounting and getting started	88009
Installation and operation instructions	81341
Mounting template	87130

### i50 instrument range

Raymarine's i50 instrument range consists of the following variants:

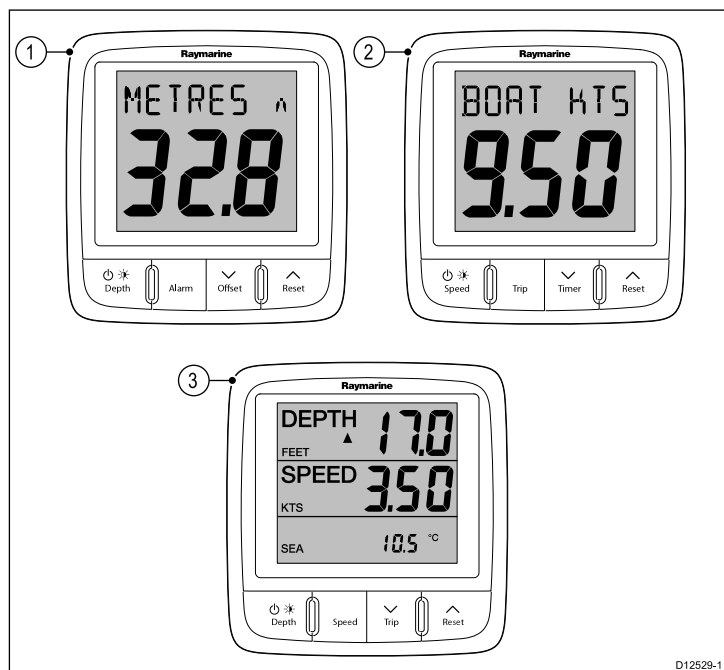

D12529-1

Item	Description	Part number
1	i50 Depth	E70058
2	i50 Speed	E70059
3	i50 Tridata	E70060

# Chapter 3: Planning the installation

## Chapter contents

- [3.1 Installation checklist](#)
- [3.2 System integration](#)
- [3.3 Typical systems](#)
- [3.4 System protocols](#)
- [3.5 Parts supplied](#)
- [3.6 Tools required](#)



### 3.1 Installation checklist

Installation includes the following activities:

Installation Task	
1	Plan your system.
2	Obtain all required equipment and tools.
3	Site all equipment.
4	Route all cables.
5	Drill cable and mounting holes.
6	Make all connections into equipment.
7	Secure all equipment in place.
8	Power on and test the system.

## 3.2 System integration

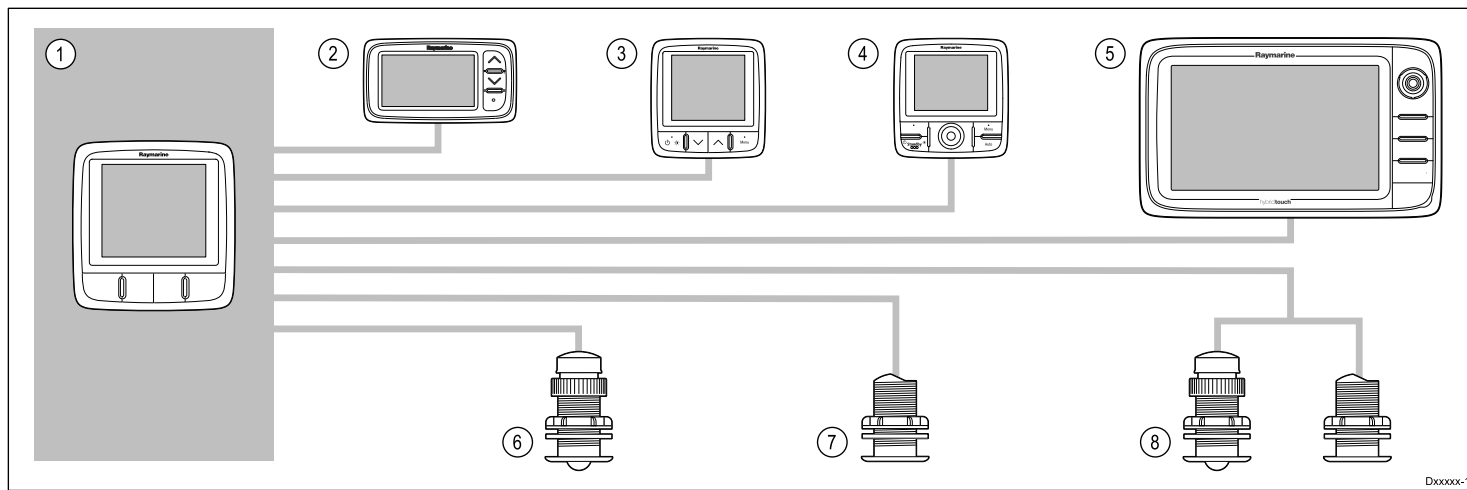

Dxxxxx-1

Item	Device type	Maximum Quantity	Suitable Devices	Connections
1	i50 Depth, Speed or Tridata instrument.	As determined by the SeaTalk <sup>ng</sup> bus bandwidth and power loading.	<ul style="list-style-type: none"> <li>i50 Depth</li> <li>i50 Speed</li> <li>i50 Tridata</li> </ul>	<ul style="list-style-type: none"> <li>SeaTalk<sup>ng</sup></li> </ul>
2	SeaTalk instrument displays.	As determined by the SeaTalk bus bandwidth and power loading.	<ul style="list-style-type: none"> <li>i40</li> <li>ST40</li> <li>ST60+</li> </ul>	<ul style="list-style-type: none"> <li>SeaTalk<sup>ng</sup> via the optional SeaTalk1 to SeaTalk<sup>ng</sup> converter</li> </ul>
3	SeaTalk <sup>ng</sup> Instrument displays.	As determined by the SeaTalk <sup>ng</sup> bus bandwidth and power loading.	<ul style="list-style-type: none"> <li>i50</li> <li>i60</li> <li>i70</li> <li>ST70</li> <li>ST70+</li> </ul>	<ul style="list-style-type: none"> <li>SeaTalk<sup>ng</sup></li> </ul>
4	SeaTalk <sup>ng</sup> pilot controller.	As determined by the SeaTalk <sup>ng</sup> bus bandwidth and power loading.	<ul style="list-style-type: none"> <li>ST70</li> <li>ST70 +</li> <li>p70</li> <li>p70R</li> </ul>	<ul style="list-style-type: none"> <li>SeaTalk<sup>ng</sup></li> </ul>
5	SeaTalk <sup>ng</sup> Multifunction displays.	6	<ul style="list-style-type: none"> <li>Raymarine multifunction displays.</li> </ul>	<ul style="list-style-type: none"> <li>SeaTalk<sup>ng</sup></li> </ul>
6	Raymarine speed and temperature transducer (i50 Speed).	1	<ul style="list-style-type: none"> <li>P120 Low profile through hull speed/temp transducer</li> <li>Other compatible transducers — Please contact your local Raymarine dealer for details.</li> </ul>	Raymarine transducer connection.
7	Raymarine depth transducer (i50 Depth).	1	<ul style="list-style-type: none"> <li>P19 Through hull depth transducer</li> <li>Other compatible transducers — Please contact your local Raymarine dealer for details.</li> </ul>	Raymarine transducer connection.
8	Raymarine speed and depth transducers (i50 Tridata).	<ul style="list-style-type: none"> <li>1 x depth and 1 x Speed/Temp transducers, or</li> <li>1 x depth, speed and temperature (DST) transducer.</li> </ul>	<ul style="list-style-type: none"> <li>P120 Low profile through hull speed/temp transducer</li> <li>P19 Through hull depth transducer</li> <li>Other compatible transducers — Please contact your local Raymarine dealer for details.</li> </ul>	Raymarine transducer connections.

### 3.3 Typical systems

The instrument range can be connected directly to a SeaTalk<sup>ng</sup> network. The instrument range can also be connected to a SeaTalk system using the SeaTalk to SeaTalk<sup>ng</sup> adaptor cable.

#### Basic SeaTalk<sup>ng</sup> system example

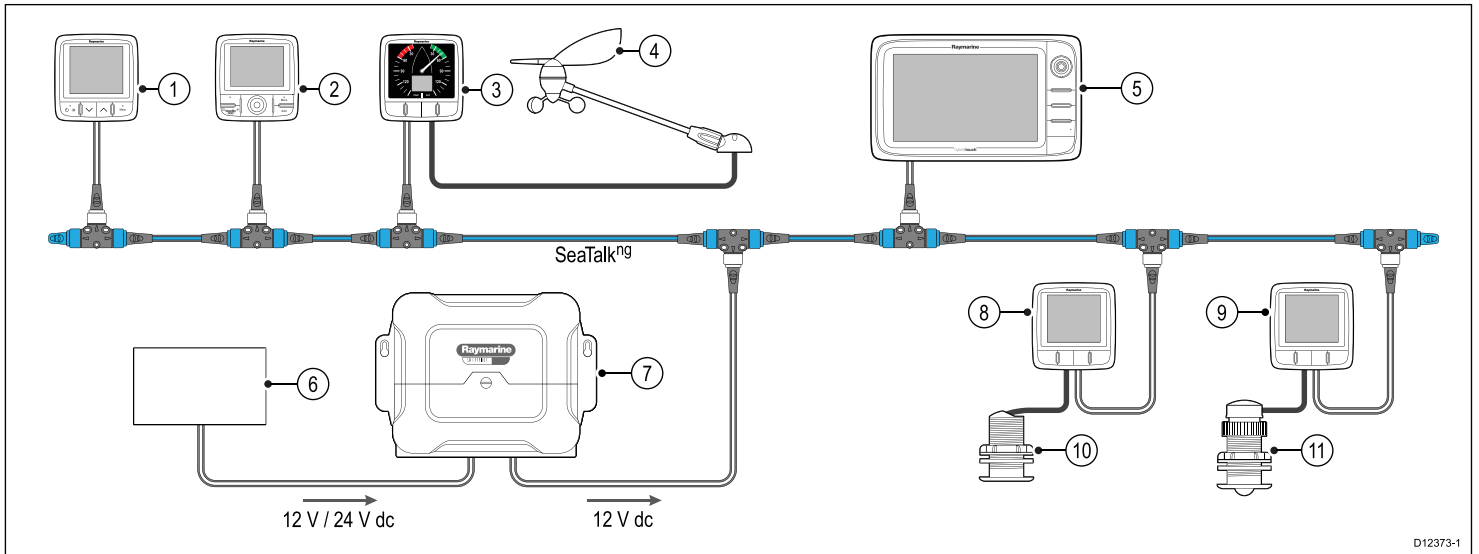

D12373-1

1	SeaTalk <sup>ng</sup> instrument display
2	SeaTalk <sup>ng</sup> pilot controller
3	i60 Wind instrument
4	Raymarine wind vane transducer
5	Raymarine multifunction display
6	12 / 24 V dc power supply
7	Raymarine course computer (providing 12 V dc power supply to the SeaTalk <sup>ng</sup> network.)
8	i50 Speed instrument
9	i50 Depth instrument
10	Speed transducer
11	Depth transducer

## Extended SeaTalk<sup>ng</sup> system example

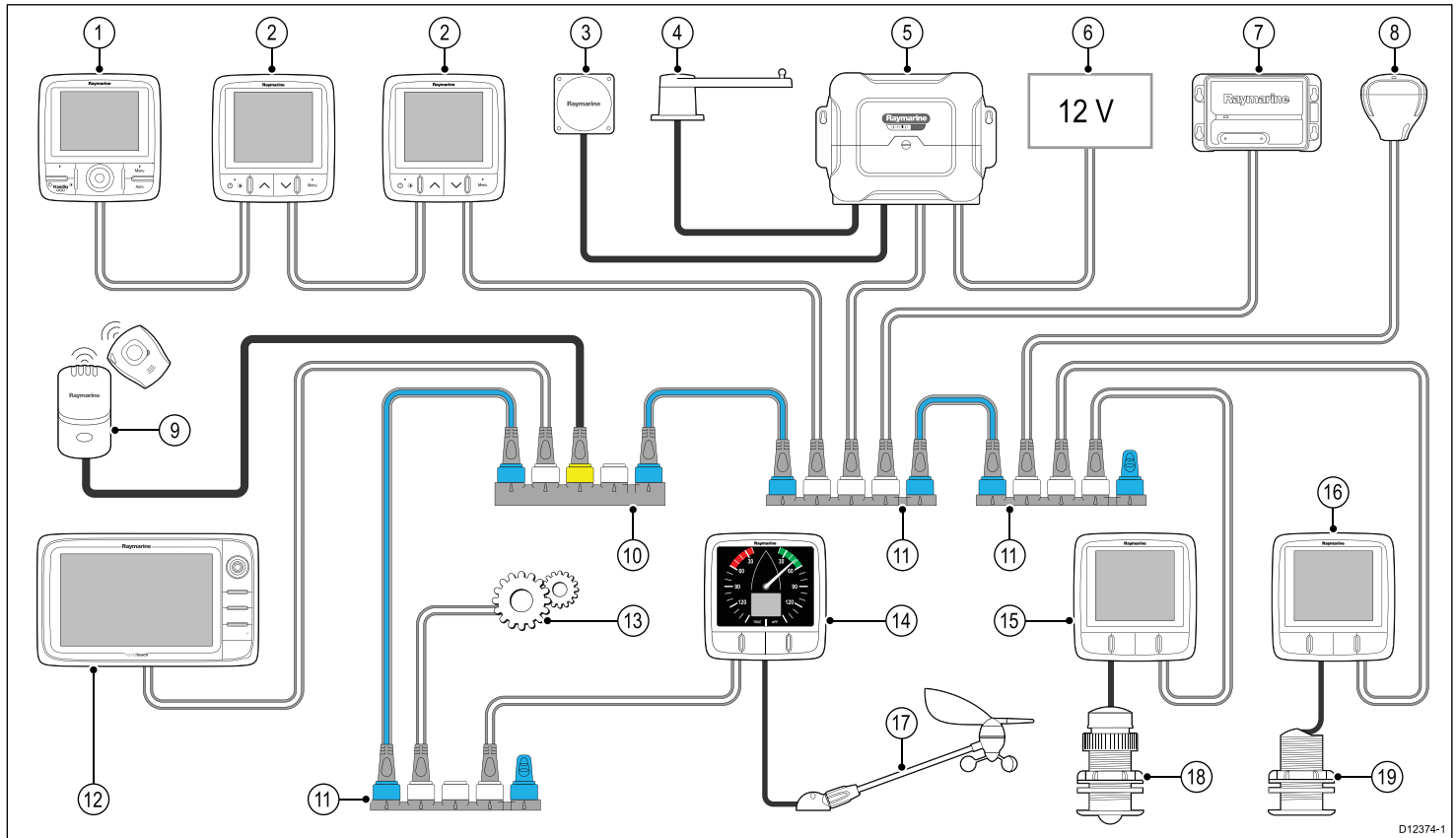

D12374-1

1	SeaTalk <sup>ng</sup> pilot controller
2	SeaTalk <sup>ng</sup> instrument displays
3	Fluxgate compass
4	Rudder reference
5	Raymarine course computer (providing 12 V dc power supply to SeaTalk <sup>ng</sup> network.)
6	12 / 24 V dc power supply
7	Raymarine AIS transceiver
8	Raymarine SeaTalk <sup>ng</sup> GPS
9	Man over board
10	SeaTalk to SeaTalk <sup>ng</sup> converter
11	SeaTalk <sup>ng</sup> 5 way blocks
12	Raymarine multifunction display
13	Engine data (via devicenet adaptor cable.)
14	i60 Wind instrument
15	i50 Depth instrument
16	i50 Speed instrument
17	Raymarine wind vane transducer
18	Depth transducer
19	Speed transducer

### 3.4 System protocols

Your product can be connected to various products and systems to share information and so improve the functionality of the overall system. These connections may be made using a number of different protocols. Fast and accurate data collection and transfer is achieved by using a combination of the following data protocols:

- SeaTalk<sup>ng</sup>
- NMEA 2000
- SeaTalk

**Note:** You may find that your system does not use all of the connection types or instrumentation described in this section.

#### Seataalk<sup>ng</sup>

SeaTalk<sup>ng</sup> (Next Generation) is an enhanced protocol for connection of compatible marine instruments and equipment. It replaces the older SeaTalk and SeaTalk<sup>2</sup> protocols.

SeaTalk<sup>ng</sup> utilizes a single backbone to which compatible instruments connect using a spur. Data and power are carried within the backbone. Devices that have a low draw can be powered from the network, although high current equipment will need to have a separate power connection.

SeaTalk<sup>ng</sup> is a proprietary extension to NMEA 2000 and the proven CAN bus technology. Compatible NMEA 2000 and SeaTalk / SeaTalk<sup>2</sup> devices can also be connected using the appropriate interfaces or adaptor cables as required.

#### NMEA 2000

NMEA 2000 offers significant improvements over NMEA 0183, most notably in speed and connectivity. Up to 50 units can simultaneously transmit and receive on a single physical bus at any one time, with each node being physically addressable. The standard was specifically intended to allow for a whole network of marine electronics from any manufacturer to communicate on a common bus via standardized message types and formats.

#### SeaTalk

SeaTalk is a protocol which enables compatible instruments to connect to each other and share data.

The SeaTalk cable system is used to connect compatible instruments and equipment. The cable carries power and data and enables connection without the need for a central processor.

Additional instruments and functions can be added to a SeaTalk system, simply by plugging them into the network. SeaTalk equipment can also communicate with other non-SeaTalk equipment via the NMEA 0183 standard, provided a suitable interface is used.

### 3.5 Parts supplied

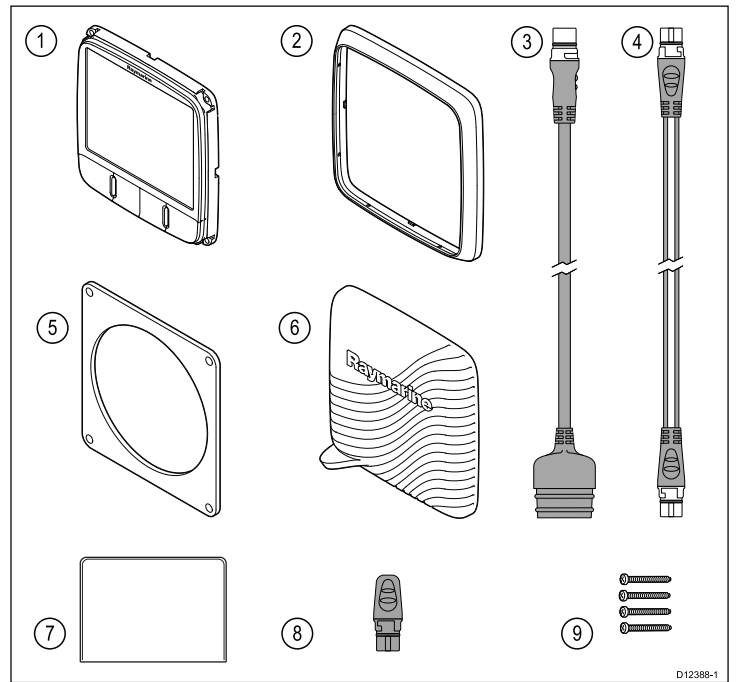

1	i50 instrument
2	Front bezel
3	SeaTalk to SeaTalk <sup>ng</sup> adaptor cable
4	SeaTalk <sup>ng</sup> spur cable
5	Gasket
6	Sun cover
7	Documentation pack
8	SeaTalk <sup>ng</sup> blanking plug
9	4 x fixing screws

## 3.6 Tools required

### Tools required for installation

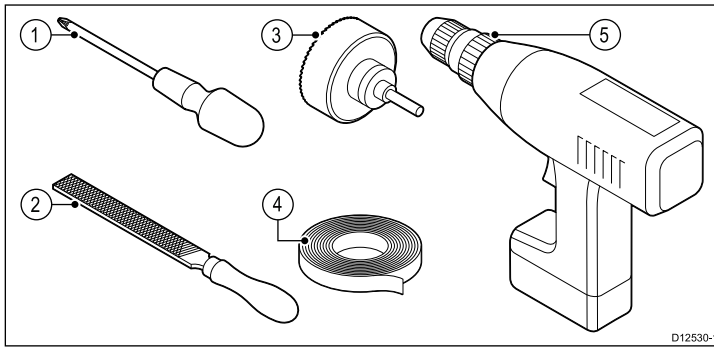

1	Pozi-drive screwdriver
2	File
3	92 mm (3.62 in) hole cutter
4	Adhesive tape
5	Power drill

# Chapter 4: Cables and connections

## Chapter contents

- [4.1 General cabling guidance](#)
- [4.2 Connections overview](#)

## 4.1 General cabling guidance

### Cable types and length

It is important to use cables of the appropriate type and length

- Unless otherwise stated use only standard cables of the correct type, supplied by Raymarine.
- Ensure that any non-Raymarine cables are of the correct quality and gauge. For example, longer power cable runs may require larger wire gauges to minimize voltage drop along the run.

### Routing cables

Cables must be routed correctly, to maximize performance and prolong cable life.

- Do NOT bend cables excessively. Wherever possible, ensure a minimum bend diameter of 200 mm (8 in) / minimum bend radius of 100 mm (4 in).

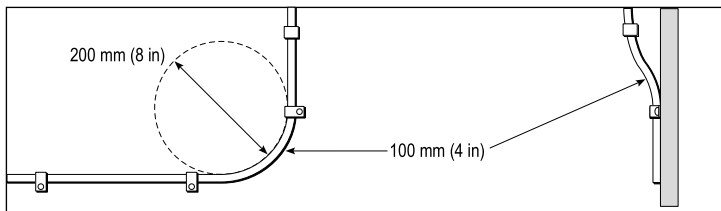

- Protect all cables from physical damage and exposure to heat. Use trunking or conduit where possible. Do NOT run cables through bilges or doorways, or close to moving or hot objects.
- Secure cables in place using tie-wraps or lacing twine. Coil any extra cable and tie it out of the way.
- Where a cable passes through an exposed bulkhead or deckhead, use a suitable watertight feed-through.
- Do NOT run cables near to engines or fluorescent lights.

Always route data cables as far away as possible from:

- other equipment and cables,
- high current carrying ac and dc power lines,
- antennae.

### Strain relief

Ensure adequate strain relief is provided. Protect connectors from strain and ensure they will not pull out under extreme sea conditions.

### Cable shielding

Ensure that all data cables are properly shielded that the cable shielding is intact (e.g. hasn't been scraped off by being squeezed through a tight area).

## 4.2 Connections overview

Connections are made using the provided SeaTalk<sup>ng</sup> and transducer cable connectors on the rear of the unit.

### SeaTalk<sup>ng</sup> connections

The unit has 2 x SeaTalk<sup>ng</sup> connectors on the rear for connecting to a SeaTalk<sup>ng</sup> network.

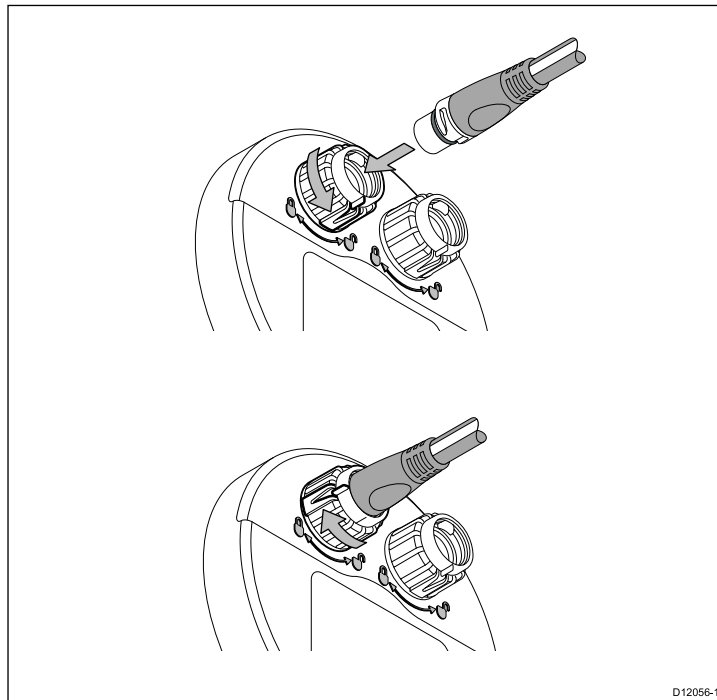

#### Connecting SeaTalk<sup>ng</sup> cables

1. Rotate the locking collar on the back of the unit to the UNLOCKED position.
2. Ensure the spur cable end connector is correctly oriented.
3. Fully insert the cable connector.
4. Rotate locking collar clockwise (2 clicks) until it snaps into the LOCKED position.

### Transducer connections

#### i50 Depth connection

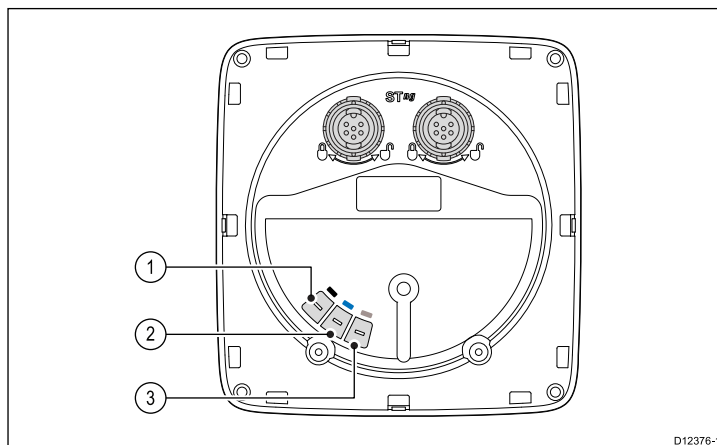

Item	Cable color	Signal name
1	Black	Piezoceramic -
2	Blue	Piezoceramic +
3	Screen	0 V (shield)



## i50 Speed connection

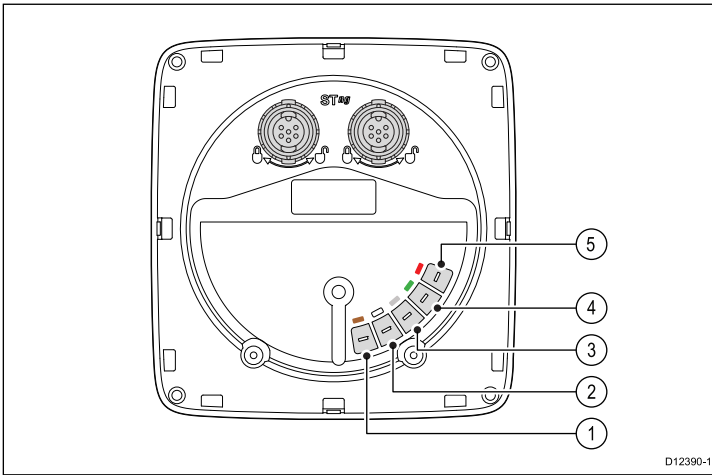

Item	Cable color	Signal name
1	Brown	Temperature 0 V
2	White	Temperature (signal)
3	Screen	Speed 0 V (shield)
4	Green	Speed (signal)
5	Red	Speed V+

## i50 Tridata connection

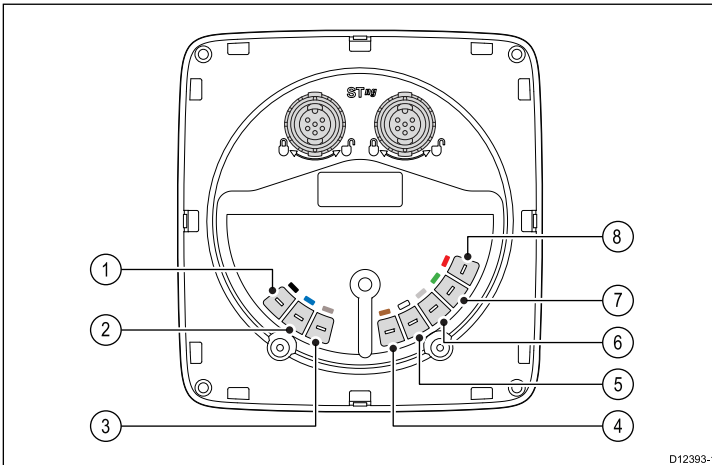

Item	Cable color	Signal name
1	Black (Depth)	Piezoceramic -
2	Blue (Depth)	Piezoceramic +
3	Screen (Depth)	0 V (shield)
4	Brown (Speed)	Temperature 0 V
5	White (Speed)	Temperature (signal)
6	Screen (Speed)	Speed 0 V (shield)
7	Green (Speed)	Speed (signal)
8	Red (Speed)	Speed V+

### Making transducer connections

Although the transducer cable is fitted with spade connectors for direct connection to the rear of the unit, it may be necessary to remove these to facilitate installation, e.g. if the cable has to be

routed through narrow apertures. 1/8th spade terminals will be required (not supplied), to replace those removed. When fitting the new spade connectors, prepare the cables as detailed below:

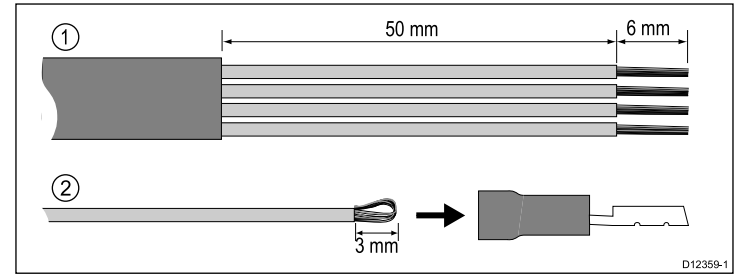

1. Prepare the cable as shown in 1 above.
2. Fold back the wire strands and insert into the new spade connector as shown in 2 above.
3. Ensure the wire strands do not extend beyond the rear of the spade connector insulation.
4. Crimp the connector to the wire.

## iTC-5 connection

Transducers can be connected to a SeaTalk<sup>ng</sup> network using Raymarine's Instrument transducer converter (iTC-5) and an i70 instrument, the data can then be repeated on an i50 / i60 unit.

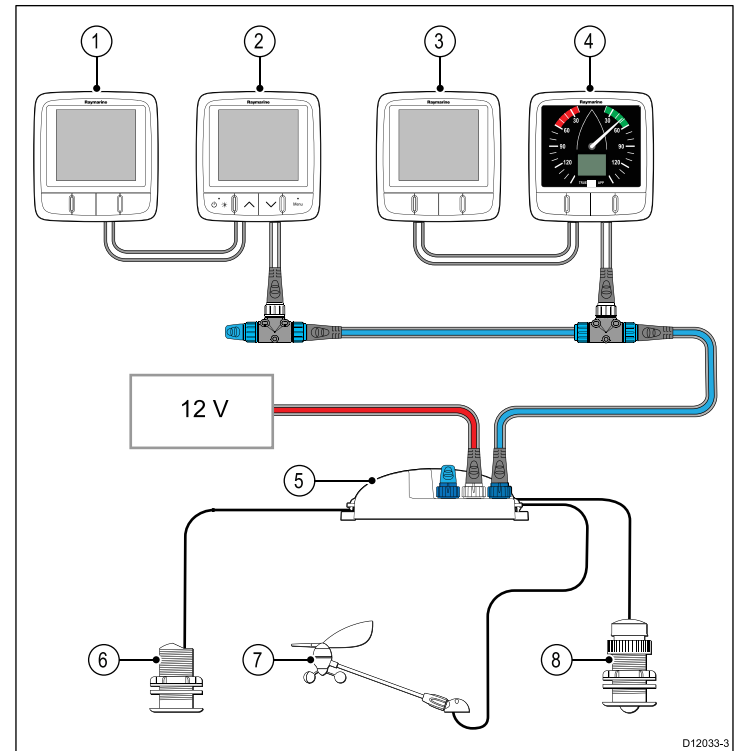

1	i50 Depth (Repeater)
2	i70 Instrument (Master)
3	i50 Speed (Repeater)
4	i60 Wind (Repeater)
5	iTC-5
6	Depth transducer
7	Wind vane transducer
8	Speed transducer

**Note:** Transducers connected to the iTC-5 must be calibrated using an i70 (master) unit. Transducers connected to the iTC-5 cannot be calibrated using an i50 / i60.

### Making iTC-5 transducer connections

For instructions on connecting transducers to your iTC-5 refer to the iTC-5 handbook.

## Power connection

Power is supplied to the product over the SeaTalk<sup>ng</sup> network.

A SeaTalk<sup>ng</sup> system requires one 12 V dc supply, connected to the SeaTalk<sup>ng</sup> backbone. This can be provided:

- By a battery via the distribution panel, or
- From a Raymarine course computer, via a SeaTalk or a SeaTalk<sup>ng</sup> system.

### Power connection example

#### SeaTalk<sup>ng</sup> power connection

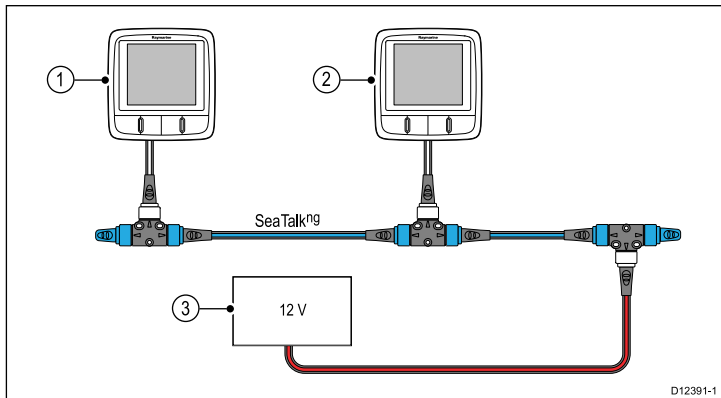

D12391-1

1	SeaTalk <sup>ng</sup> instrument.
2	SeaTalk <sup>ng</sup> instrument.
3	12 V dc vessel power supply.



#### Warning: Grounding not required

This product is fully insulated and does NOT require separate grounding.



#### Warning: Positive ground systems

Do not connect this unit to a system which has positive grounding.

### SeaTalk power protection

The power supply must be protected by a 5 A fuse or a circuit breaker providing equivalent protection.

Raymarine recommends that the power is connected to a SeaTalk system in such a way that the current drawn on each side of the power connection point is equal.

#### SeaTalk power cables

Part number	Description
D229	SeaTalk power cable.

### SeaTalk<sup>ng</sup> power protection

The power supply must be protected by a 5 A fuse or a circuit breaker providing equivalent protection.

Raymarine recommends that the power is connected to a SeaTalk<sup>ng</sup> system in such a way that the current drawn on each side of the power connection point is equal.

#### SeaTalk<sup>ng</sup> power cables

Part number	Description
A06049	SeaTalk <sup>ng</sup> power cable

## SeaTalk<sup>ng</sup> connection

The unit can be connected as part of a SeaTalk<sup>ng</sup> network.

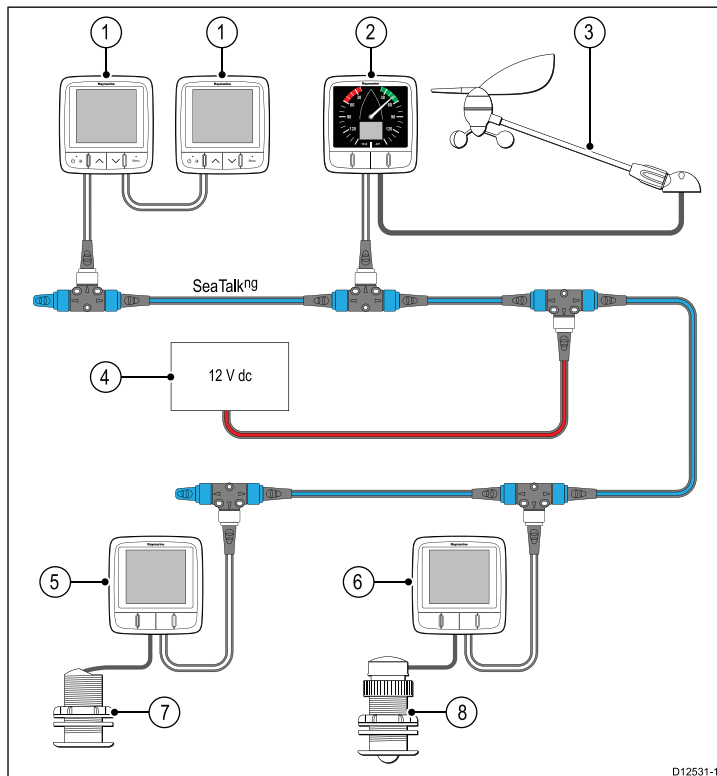

D12531-1

1	i70 instrument displays (SeaTalk <sup>ng</sup> )
2	i60 Wind instrument (SeaTalk <sup>ng</sup> )
3	Raymarine wind vane transducer
4	12 V dc power supply
5	i50 Speed instrument (SeaTalk <sup>ng</sup> )
6	i50 Depth instrument (SeaTalk <sup>ng</sup> )
7	Speed transducer
8	Depth transducer

### SeaTalk<sup>ng</sup> cabling

#### SeaTalk<sup>ng</sup> cables and connectors

Connection / Cable	Notes
Backbone cables (various lengths)	The main cable carrying data. Spurs from the backbone are used to connect SeaTalk <sup>ng</sup> devices.
T-piece connectors	Used to make junctions in the backbone to which devices can then be connected.
Terminators	Required at either end of the backbone.
Spur cables	Used to connect devices. Devices may be daisy chained or connected directly to the T-pieces
SeaTalk <sup>ng</sup> 5-way connector	Used to branch, split, or make additional connections in SeaTalk <sup>ng</sup> networks.

### SeaTalk<sup>ng</sup> power

The SeaTalk<sup>ng</sup> bus requires a 12 V power supply. This may be provided from:

- Raymarine SPX course computer, or
- Other separate regulated 12 V supply.

**Note:** SeaTalk<sup>ng</sup> does NOT supply power to multifunction displays and other equipment with a dedicated power supply input.

## SeaTalk connection

Connections to an existing SeaTalk system must be made using a SeaTalk to SeaTalk<sup>ng</sup> adaptor cable.

### Basic SeaTalk system example

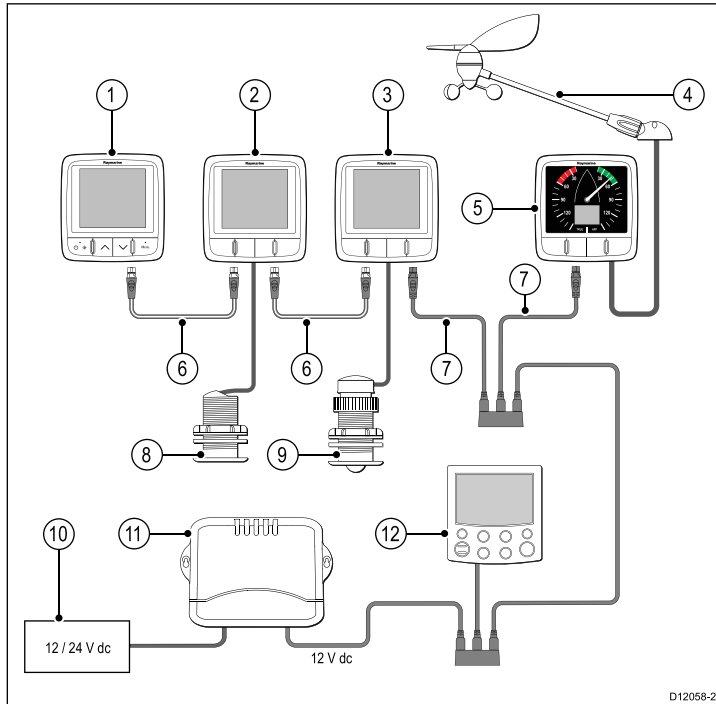

1	i70 Instrument display (SeaTalk <sup>ng</sup> )
2	i50 Speed instrument (SeaTalk <sup>ng</sup> )
3	i50 Depth instrument (SeaTalk <sup>ng</sup> )
4	Raymarine wind vane transducer
5	i60 Wind instrument (SeaTalk <sup>ng</sup> )
6	SeaTalk <sup>ng</sup> cables
7	SeaTalk to SeaTalk <sup>ng</sup> adaptor cables
8	Speed transducer
9	Depth transducer
10	12 / 24 V dc power supply
11	SeaTalk Course computer (providing 12 V dc power to SeaTalk network.)
12	ST6002 pilot controller (SeaTalk)

### SeaTalk accessories

SeaTalk cables and accessories for use with compatible products.

Description	Part No	Notes
3-way SeaTalk junction box	D244	
1 m (3.28 ft) SeaTalk extension cable	D284	
3 m (9.8 ft) SeaTalk extension cable	D285	
5 m (16.4 ft) SeaTalk extension cable	D286	
9 m (29.5 ft) SeaTalk extension cable	D287	
12 m (39.4 ft) SeaTalk extension cable	E25051	
20 m (65.6 ft) SeaTalk extension cable	D288	

## NMEA2000 connection

You can either:

- Use your SeaTalk<sup>ng</sup> backbone and connect each NMEA2000 device on a spur, OR
- connect the instrument display on a spur into an existing NMEA2000 backbone.

**Important:** You cannot have any 2 terminated backbones connected together, unless you have an isolation gateway between the two backbones.

### Connecting NMEA2000 equipment to the SeaTalk<sup>ng</sup> backbone

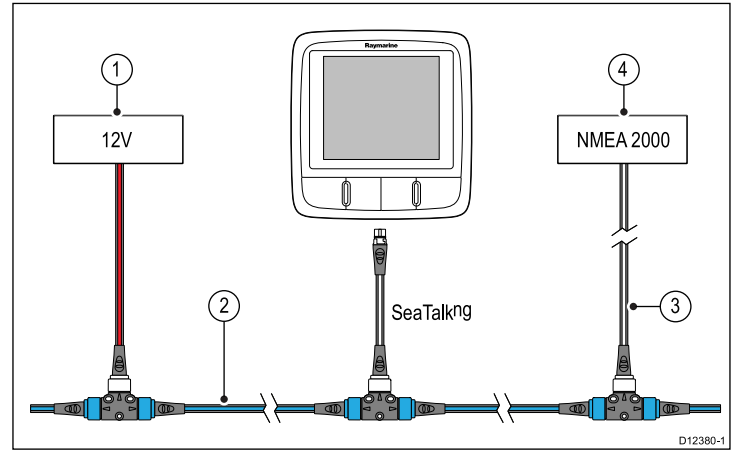

1. 12 V dc power supply into backbone.
2. SeaTalk<sup>ng</sup> backbone.
3. SeaTalk<sup>ng</sup> to DeviceNet adaptor cable.
4. NMEA2000 equipment.

### Connecting the unit to an existing NMEA2000 (DeviceNet) backbone

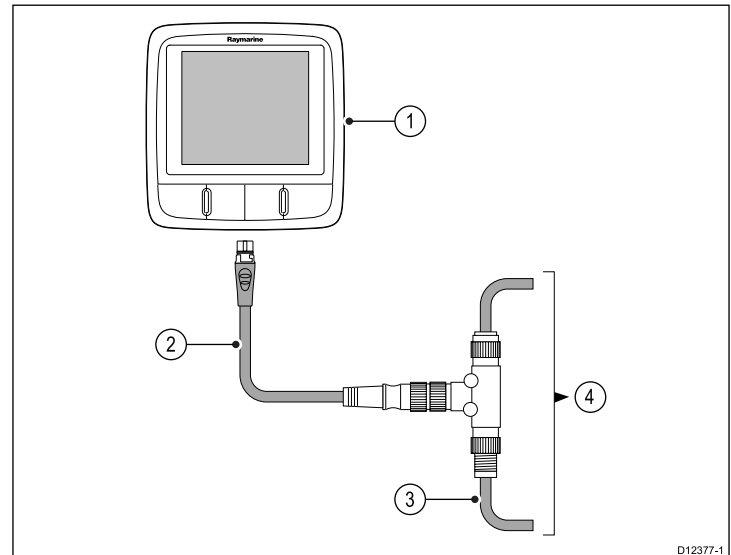

1. SeaTalk<sup>ng</sup> instrument display
2. SeaTalk<sup>ng</sup> to DeviceNet adaptor cable.
3. DeviceNet backbone.
4. NMEA2000 equipment.

# Chapter 5: Location and mounting

## Chapter contents

- [5.1 Selecting a display location](#)
- [5.2 Mounting](#)
- [5.3 Front bezel](#)
- [5.4 Selecting a transducer location](#)

## 5.1 Selecting a display location



### Warning: Potential ignition source

This product is NOT approved for use in hazardous/flammable atmospheres. Do NOT install in a hazardous/flammable atmosphere (such as in an engine room or near fuel tanks).

### General location requirements

When selecting a location for the unit it is important to consider a number of factors.

#### Ventilation requirements

To provide adequate airflow:

- Ensure that equipment is mounted in a compartment of suitable size.
- Ensure that ventilation holes are not obstructed.
- Ensure adequate separation of equipment.

#### Mounting surface requirements

Ensure units are adequately supported on a secure surface. Do NOT mount units or cut holes in places which may damage the structure of the vessel.

#### Cable routing requirements

Ensure the unit is mounted in a location which allows proper routing and connection of cables:

- Minimum cable bend radius of 100 mm (3.94 in) is required unless otherwise stated.
- Use cable supports to prevent stress on connectors.

#### Water ingress

This unit is suitable for mounting both above and below decks. It is waterproof to IPX6 standard. Although the unit is waterproof, it is good practice to locate it in a protected area away from prolonged and direct exposure to rain and salt spray.

#### Electrical interference

Select a location that is far enough away from devices that may cause interference, such as motors, generators and radio transmitters/receivers.

#### Magnetic compass

When choosing a suitable location you should aim to maintain the maximum possible distance between the unit and any compasses.

To prevent potential interference with the vessel's magnetic compasses, ensure that a minimum distance of 230 mm (9 in) between the unit and any installed compasses is maintained.

#### Viewing angle considerations

As display contrast, color and night mode performance are all affected by the viewing angle, Raymarine recommends you temporarily power up the display when planning the installation, to enable you to best judge which location gives the optimum viewing angle.

#### Viewing angle

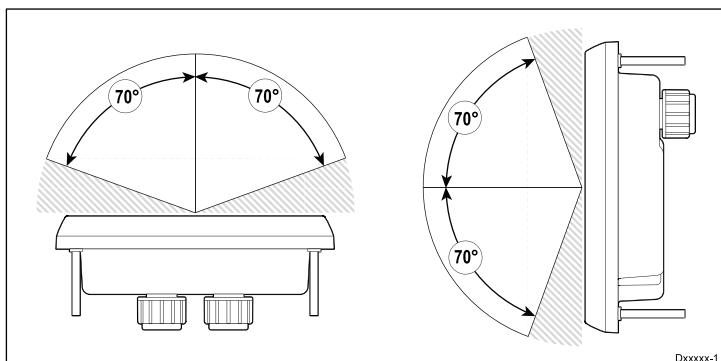

## Product dimensions

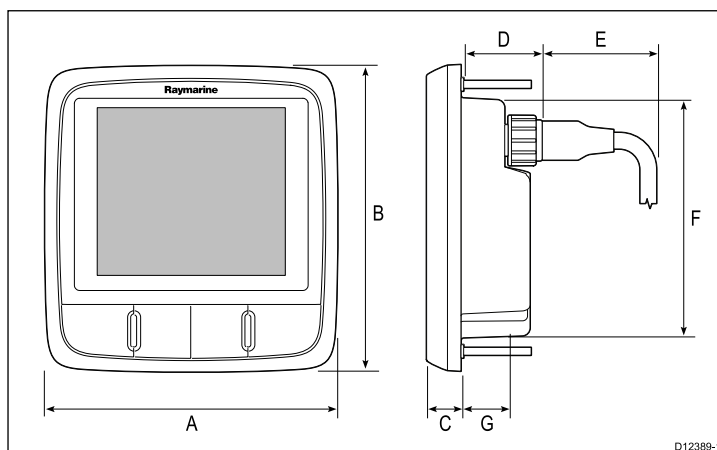

A	110 mm (4.22")
B	115 mm (4.52")
C	14 mm (0.55")
D	30 mm (1.18")
E	35 mm (1.38")
F	90 mm (3.54")
G	17 mm (0.67")

## 5.2 Mounting

### Pre-mounting check

The product is designed to be surface mounted. Before mounting the unit, ensure you have:

- Selected a suitable location.
- Identified the cable connections and route that the cables will take.
- Detached the front bezel.
- Remove the keypad mat.

### Mounting diagram

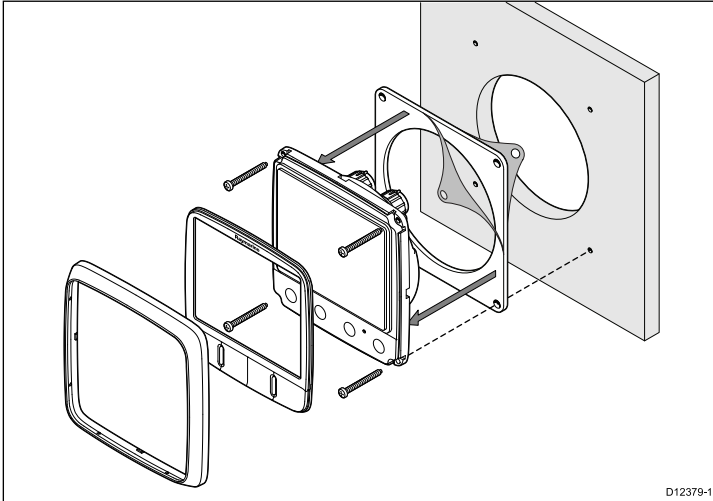

### Mounting instructions

1. Check the selected location for the unit, a clear, flat area with suitable clearance behind the panel is required.
2. Fix the mounting template supplied with the product, to the selected location, using masking or self adhesive tape.
3. If possible use an appropriate size hole cutting saw and cut out the centre hole cut out area as indicated on the mounting template, or
4. Using a suitable hole cutting saw, make pilot holes in each corner of the cut out area and using a jigsaw cut along the inside edge of the cut out line.
5. Ensure that the unit fits into the removed area and then file around the cut edge until smooth.
6. Drill any required holes as indicated on the mounting template for the securing screws.
7. Connect the relevant cables to the unit.
8. Peel the backing off of the supplied gasket and place the adhesive side of the gasket onto the display unit and press firmly onto the flange.
9. Slide the unit into place and secure using the screws provided.
10. Refit keypad mat and front bezel.

**Note:** Drill, tap size and tightening torques are dependant upon the material type and thickness of the mounting surface.

**Note:** The supplied gasket provides a seal between the unit and a suitably flat and stiff mounting surface or binnacle. The gasket should be used in all installations. It may also be necessary to use a marine-grade sealant if the mounting surface or binnacle is not entirely flat and stiff or has a rough surface finish.

## 5.3 Front bezel

### Removing the front bezel

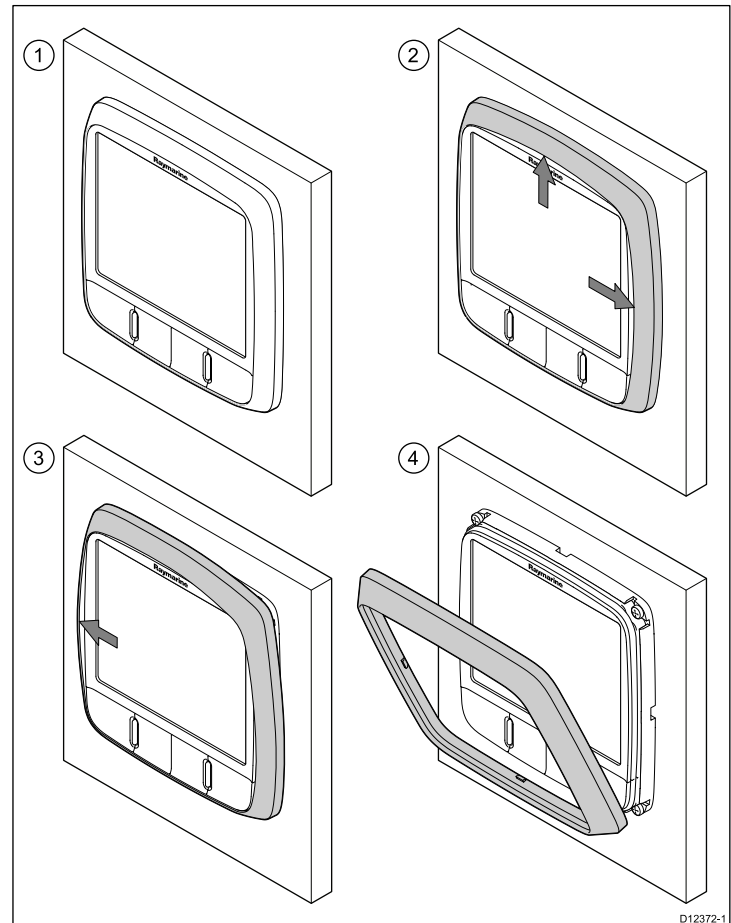

**Note:** Use care when removing the bezel. Do not use any tools to lever the bezel, doing so may cause damage.

1. Using your fingers pull the bezel away from the unit at the top and side, as shown in 2. The bezel will start to come away from the unit at the top and side.
2. Now pull the bezel away from the unit on the opposite side, as shown in 3. The bezel will now come free from the unit, as shown in 4.

## 5.4 Selecting a transducer location

### General speed and depth transducer location requirements

When selecting a location for your transducer it is important to consider a number of factors.

The transducer should be mounted within the clear water flow areas indicated by the shaded areas in the image below.

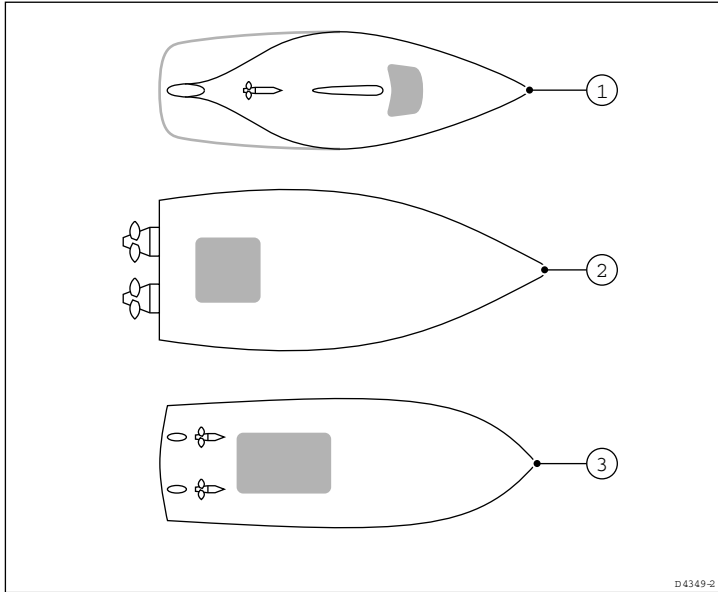

1	Sailing vessel
2	Planing power vessel
3	Displacement power vessel

Each transducer should also:

- Be ahead of the propellers (by a minimum of 10% of the water line length).
- Be at least 150 mm (6 in) away from the keel (ideally ahead of the keel on a sailing yacht).
- Be as near as possible to the center line of the vessel.
- Be clear of other through-hull fittings or projections.
- Have sufficient clearance inside the hull to fit the nut.
- Have 100 mm (4 in) of headroom to allow for withdrawal.

**Note:** In addition to the above requirements, the depth transducer must be mounted within 10° of the vertical.

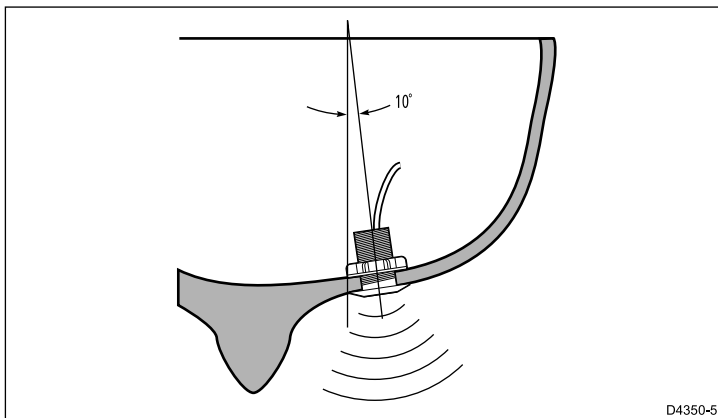

### Speed and depth transducer mounting

Ensure transducers are installed in accordance with the instructions supplied with the transducer.

# Chapter 6: Getting started

## Chapter contents

- [6.1 Controls](#)
- [6.2 Power](#)
- [6.3 Data master](#)
- [6.4 Illumination](#)
- [6.5 Calibration](#)



## 6.1 Controls

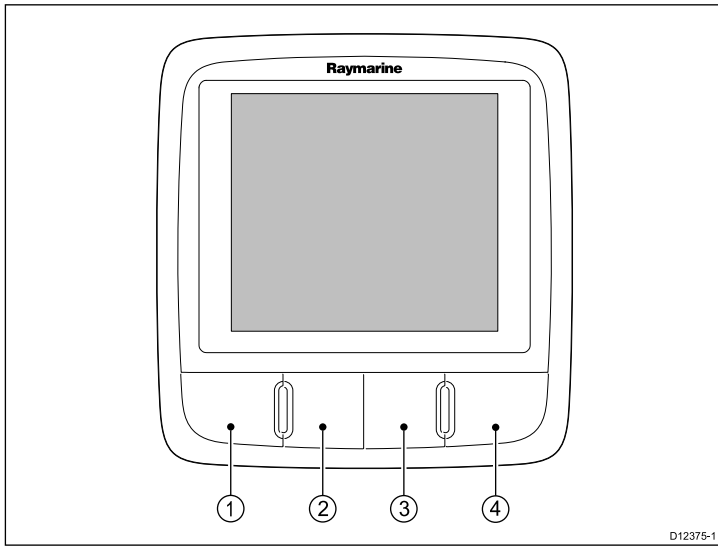

D12375-1

	i50 Depth	i50 Speed	i50 Tridata
1	<b>Depth (Power)</b> — Select to access depth information, backlight adjust, contrast adjust and power on/off modes.	<b>Speed (Power)</b> — Select to access speed information, backlight adjust, contrast adjust and power on/off modes.	<b>Depth (Power)</b> — Select to access depth information, backlight adjust, contrast adjust and power on/off modes.
2	<b>Alarm</b> — Select to access alarm levels and alarm settings.	<b>Trip</b> — Select to access log, trip and water temperature information.	<b>Speed</b> — Select to access speed and VMG information.
3	<b>Offset</b> — Select to access depth offset settings.	<b>Timer</b> — Select to access count up and start timers.	<b>Trip</b> — Select to access log, trip and water temperature information.
4	<b>Reset</b> — Select and hold down for 3 seconds to reset data to current values.	<b>Reset</b> — Select and hold down for 3 seconds to reset data to current values.	<b>Reset</b> — Select and hold down for 3 seconds to reset data to current values.

## 6.2 Power

### Powering on the unit

With power to the unit turned on but the unit switched off:

1. Press and hold the **Power** button until the unit powers on and data is displayed (approximately 2 seconds).

**Note:** When power to the unit is turned on the unit will switch on automatically.

### Powering off the unit

1. Press and hold the **Power** button until the power count down timer is displayed and reaches zero (approximately 6 to 8 seconds).

## 6.3 Data master

Where a system contains more than one unit capable of displaying a data type, the unit physically connected to the transducer must be set as the data master and any other units set as a repeater.

### Setting a unit as data master

1. Refer to the *Intermediate calibration* section for details on how to set your unit as data master.

## 6.4 Illumination

### Adjusting the backlight level

The backlighting level can be accessed using the power button.

During normal operation:

1. Press and hold the **Power** button for approximately 1 second to display the backlight page.
2. Depending on your display variant follow the steps below to adjust the backlight level:
  - i. **i50 Depth** — Use the **Offset** or **Reset** buttons to adjust the backlight level to the required setting.
  - ii. **i50 Speed** — Use the **Timer** or **Reset** buttons to adjust the backlight level to the required setting.
  - iii. **i50 Tridata** — Use the **Trip** or **Reset** buttons to adjust the backlight level to the required setting.

**Note:** The backlight page will time-out after 8 seconds of inactivity.

### Adjusting the contrast

The contrast level can be accessed using the power button.

During normal operation:

1. Press and hold the **Power** button for approximately 3 seconds to display the contrast page.
2. Depending on your display variant follow the steps below to adjust the contrast level:
  - i. **i50 Depth** — Use the **Offset** or **Reset** buttons to adjust the contrast level to the required setting.
  - ii. **i50 Speed** — Use the **Timer** or **Reset** buttons to adjust the contrast level to the required setting.
  - iii. **i50 Tridata** — Use the **Trip** or **Reset** buttons to adjust the contrast level to the required setting.
3. Selecting the **Power** button with the contrast page displayed will cycle through the available contrast settings.

**Note:** The contrast page will time-out after 8 seconds of inactivity.

## 6.5 Calibration

Before first use calibration procedures must be carried out to ensure optimum performance of the instrument with the vessel.

The calibration procedures are:

- User calibration
- Intermediate calibration
- Group setup
- Dealer calibration

**Note:** Group setup is for group illumination and is not part of the calibration process.

### User calibration

Calibration procedures are dependant on instrument display variant.

User calibration options include:

i50 Depth	i50 Speed	i50 Tridata
Setting required units for depth readings.	Setting required units for speed readings.	Setting required units for depth readings.
Setting the required depth offset.	Setting required speed resolution.	Setting the required depth offset.
Locking shallow alarm.	Set required log distance units.	Locking shallow alarm.
	Setting correct speed readings.	Setting required units for speed readings.
	Setting required temperature units.	Setting required speed resolution.
	Setting required temperature readings.	Set required log distance units.
	Setting timer buzzer on or off.	Setting correct speed readings.
		Setting required temperature units.
		Setting required temperature readings
		Setting timer buzzer on or off

### Calibrating i50 Depth

During normal operation:

1. Press and hold down the **Depth** and **Alarm** buttons simultaneously for approximately 2 seconds to display the user calibration entry page.

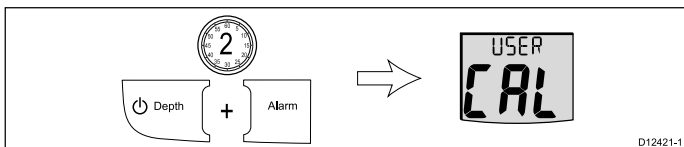

**Note:** The user calibration entry screen will time-out after 8 seconds of inactivity.

2. Press the **Depth** button to display the depth units page.

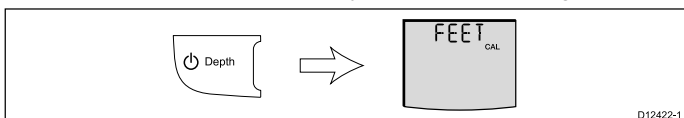

3. Use the **Offset** or **Reset** buttons to select the required depth units.
4. Press the **Depth** button to display the depth offset page.

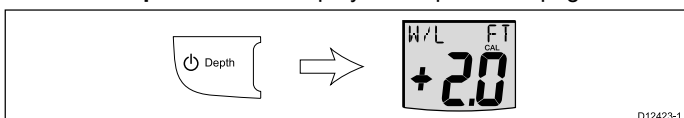

5. Use the **Offset** or **Reset** buttons to set the required depth offset.

6. Press the **Depth** button to display the shallow alarm lock page.

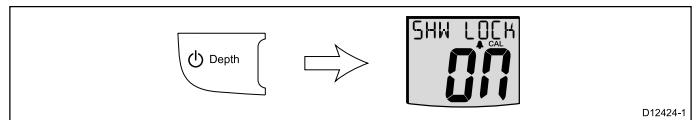

7. Use the **Offset** or **Reset** buttons to turn the shallow alarm lock on and off.
8. To exit the user calibration pages at any time, press and hold the **Depth** and **Alarm** buttons simultaneously for 2 seconds.

### Depth Offset

Depths are measured from the transducer to the sea bed, but you can apply an offset value to the depth data, so that the displayed depth reading represents the depth to the sea bed from either the keel or the water-line.

Before attempting to set a waterline or keel offset, find out the vertical separation between the transducer and either the waterline or the bottom of the keel on your vessel, as appropriate. Then set the appropriate depth offset value.

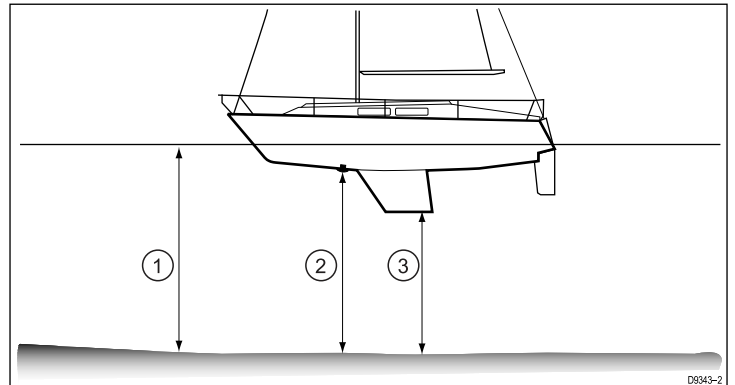

1	Waterline offset
2	Transducer / Zero offset
3	Keel offset

If an offset is not applied, displayed depth readings represent the distance from the transducer to the sea bed.

### Calibrating i50 Speed

During normal operation:

1. Press and hold down the **Speed** and **Trip** buttons simultaneously for approximately 2 seconds to display the user cal entry page.

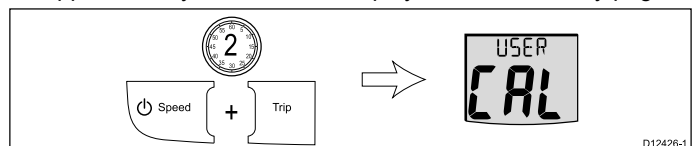

**Note:** The user calibration entry screen will time-out after 8 seconds of inactivity.

2. Press the **Speed** button to display the speed units page.

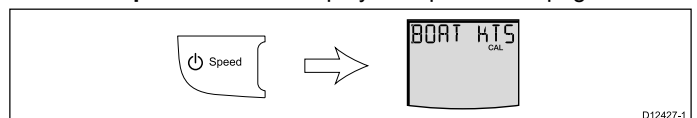

3. Use the **Timer** or **Reset** buttons to select the required speed units.
4. Press the **Speed** button to display the speed resolution page.

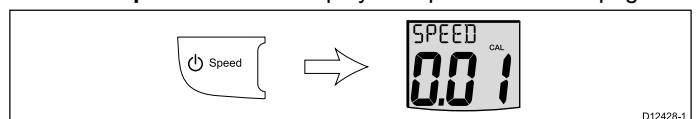

5. Use the **Timer** or **Reset** buttons to set the required speed resolution.
6. Press the **Speed** button to display the speed log units page.

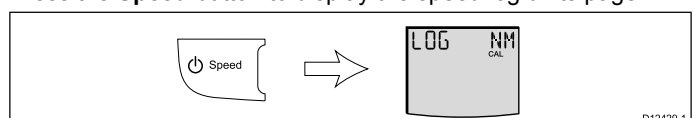

- Use the **Timer** or **Reset** buttons to select the required speed log units.
- Press the **Speed** button to display one of the current speed pages, if SOG data is available over SeaTalk then the SOG page is displayed, if SOG data is not available then the cal factor page is displayed.

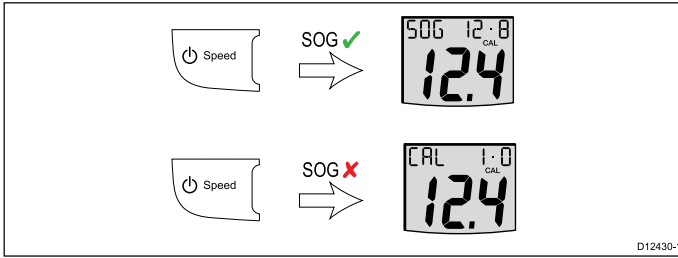

- Press the **Timer** and **Reset** buttons simultaneously to switch between the cal factor and SOG pages.

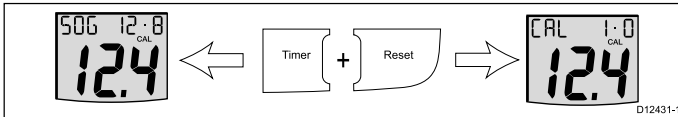

- If the SOG page is displayed and the tide conditions are slack, press and hold the **Reset** button for 3 seconds to accept SOG as the current speed.

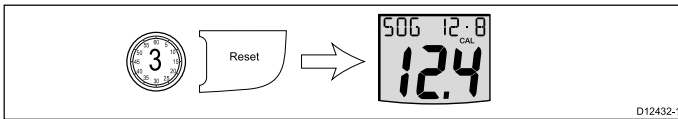

- Alternatively, with the cal factor page displayed use the **Timer** or **Reset** buttons to set the cal factor to your vessel's estimated current speed.

- Press the **Speed** button to display the temperature units page.

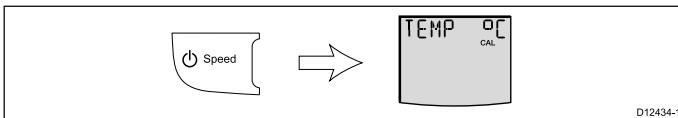

- Use the **Timer** or **Reset** buttons to select the required temperature units.

- Press the **Speed** button to display the temperature calibration page.

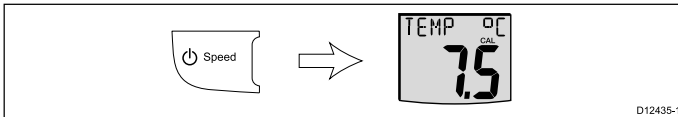

- Use the **Timer** or **Reset** buttons to set the unit to show the current water temperature.

- Press the **Speed** button to display the Timer buzzer page.

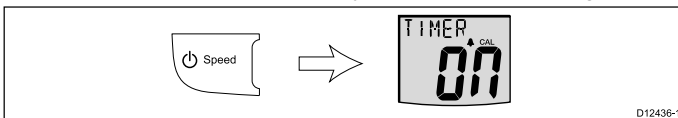

- Use the **Timer** or **Reset** buttons to switch the count-up and race start timer buzzers on and off.

- To exit the user calibration pages at any time, press and hold the **Speed** and **Trip** buttons simultaneously for 2 seconds.

### Calibrating i50 Tridata

- Press and hold down the **Depth** and **Speed** buttons simultaneously for approximately 2 seconds to display the user calibration entry page.

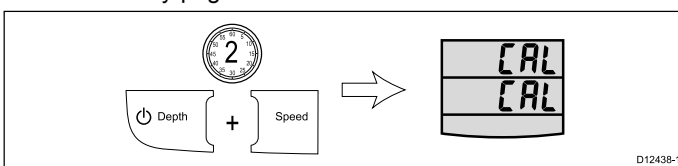

**Note:** The user calibration entry screen will time-out after 8 seconds of inactivity.

### Calibrating i50 Tridata depth

From the User calibration entry page:

Getting started

- Press the **Depth** button to display the depth units page.

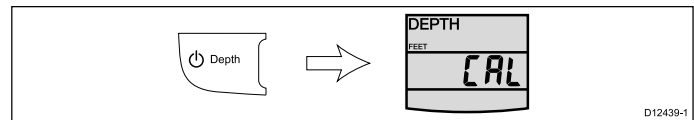

- Use the **Trip** or **Reset** buttons to select the required depth units.

- Press the **Depth** button to display the depth offset page.

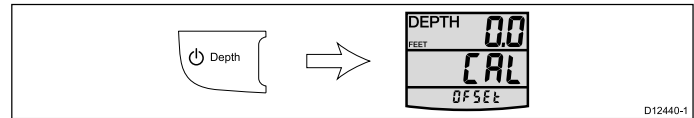

- Use the **Trip** or **Reset** buttons to set the required depth offset.

- Press the **Depth** button to display the shallow alarm lock page.

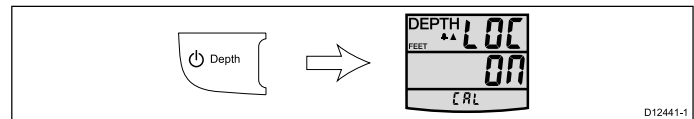

- Use the **Trip** or **Reset** buttons to switch the shallow alarm lock on and off.

- To exit the user calibration pages at any time, press and hold the **Depth** and **Speed** buttons simultaneously for 2 seconds.

### Calibrating i50 Tridata speed

During normal operation:

- Press the **Speed** button to display the speed units page.

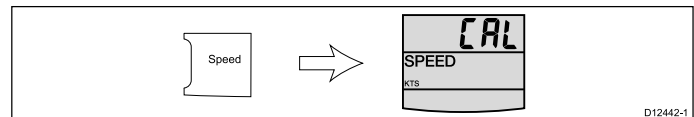

- Use the **Trip** or **Reset** buttons to set the required speed units.

- Press the **Speed** button to display the speed resolution page.

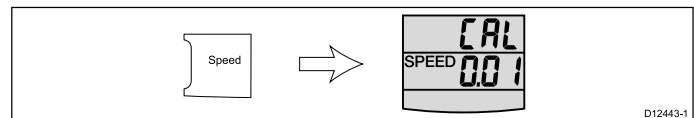

- Use the **Trip** or **Reset** buttons to set the required speed resolution.

- Press the **Speed** button to display the speed log units page.

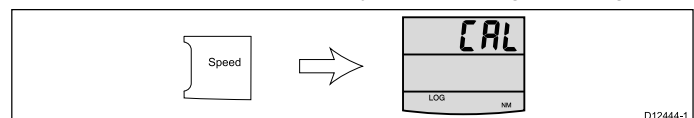

- Use the **Trip** or **Reset** buttons to select the required speed log units.

- Press the **Speed** button to display one of the current speed pages, if SOG data is available over SeaTalk then the SOG page is displayed, if SOG data is not available then the cal factor page is displayed.

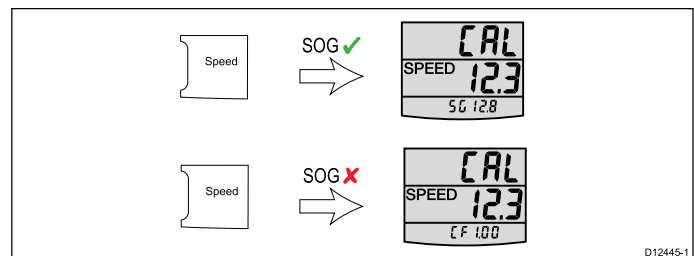

- Press and hold down the **Trip** and **Reset** buttons simultaneously to switch between the cal factor and SOG pages.

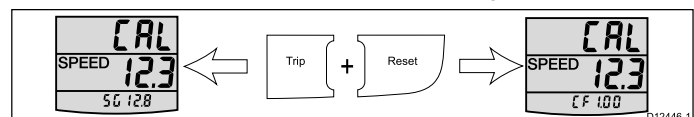

- If the SOG page is displayed and the tide conditions are slack, press and hold the **Reset** button for 3 seconds to accept SOG as the current speed.

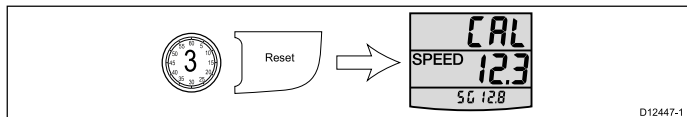

- Alternatively, with the cal factor page displayed use the **Trip** or **Reset** buttons to set the cal factor to your vessel's estimated current speed.
- Press the **Speed** button to display the temperature units page.

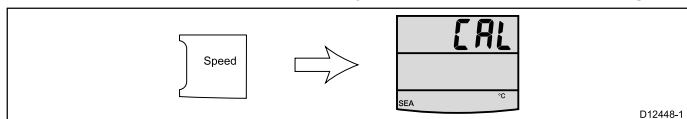

- Press the **Speed** button to display the temperature calibration page.

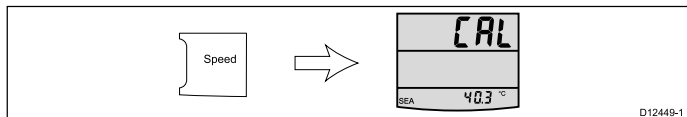

- Use the **Trip** or **Reset** buttons to set the unit to show the current water temperature.
- Press the **Speed** button to display the Timer buzzer page.

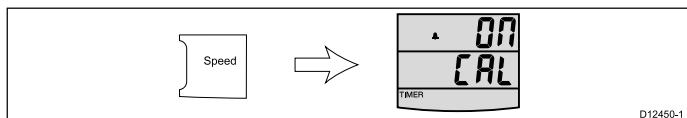

- Use the **Trip** or **Reset** buttons to switch the count-up and race start timer buzzers on and off.
- To exit the user calibration pages at any time, press and hold the **Depth** and **Speed** buttons simultaneously for 2 seconds.

## Intermediate calibration

Intermediate calibration allows you to:

i50 Depth	i50 Speed	i50 Tridata
Check instrument software version.	Check instrument software version.	Check instrument software version.
Check and if necessary change the instrument status (either master or repeater).	Check the instrument status (either master or repeater).	Check and if necessary change the instrument status (either master or repeater).
	Carry out a calibration run over a measured distance to ensure accurate speed readings.	Carry out a calibration run over a measured distance to ensure accurate speed readings.

### Checking i50 Depth software version and status

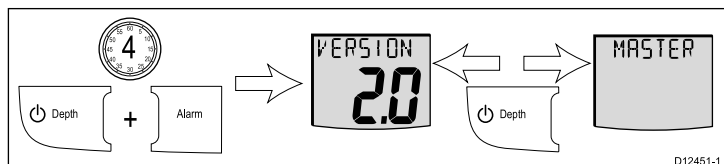

During normal operation:

- Press and hold the **Depth** and **Alarm** buttons simultaneously for 4 seconds:  
The software version is displayed.
- Press the **Depth** button to display the instrument status.  
Master (transducer connected) or Repeater (No transducer connected).
- To change the status:
  - Press the **Offset** and **Reset** buttons simultaneously to enter adjust mode.  
The status flashes when in adjust mode.
  - Press either **Offset** or **Reset** to switch the status between Master or Repeater.

- To exit the Intermediate calibration settings at any time, press and hold the **Depth** and **Alarm** buttons simultaneously for 4 seconds.

### Checking i50 Speed software version and status

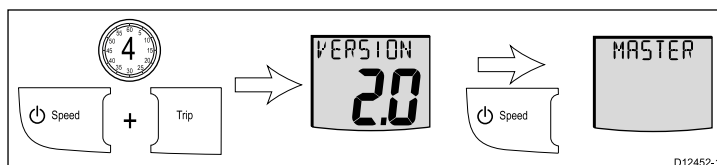

During normal operation:

- Press and hold the **Speed** and **Trip** buttons simultaneously for 4 seconds:  
The software version is displayed.
- Press the **Speed** button to display the instrument status.  
Master (transducer connected) or Repeater (No transducer connected).
- Press the **Speed** button again to begin speed run calibration.
- To exit the Intermediate calibration settings at any time, press and hold the **Speed** and **Trip** buttons simultaneously for 4 seconds.

### Performing speed run calibration – i50 Speed

This speed calibration involves carrying out up to 2 runs over a measured distance, to enable a calibration factor to be determined and applied to your unit. Each run consists of an outward and a return leg, to minimize the effect of tidal drift when the calibration factor is determined.

From the Intermediate calibration page:

**Note:** This procedure is not required if current speed is set to SOG.

- Press the **Speed** button until you reach the Calibration run length page.

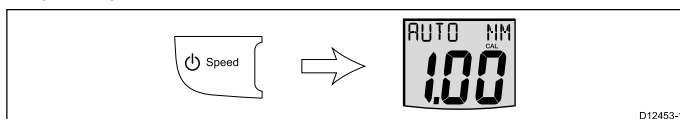

- Press the **Timer** and **Reset** buttons simultaneously to enter adjust mode.

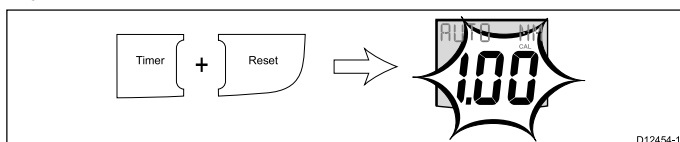

In adjust mode the run length flashes.

- Use the **Timer** or **Reset** button to set the run length to the required value (between 0.25 and 2.50).
- Press the **Timer** and **Reset** buttons simultaneously to commence the speed run calibration

The calibration status page is displayed. The text at the top of the page alternates between START 1 and the calibration factor currently applied.

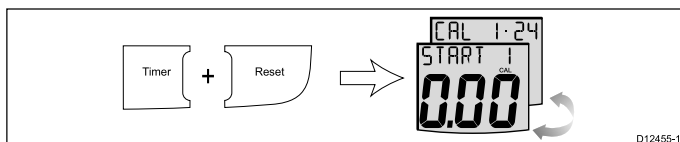

- Start the outward leg of the calibration run and as you pass the start point, press the **Trip** button, so the page shows OUTWARD at the top. As the calibration run proceeds, the displayed value will change.

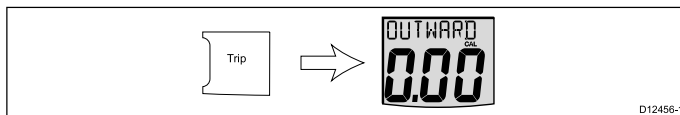

6. At the end of the outward leg press **Trip** again.

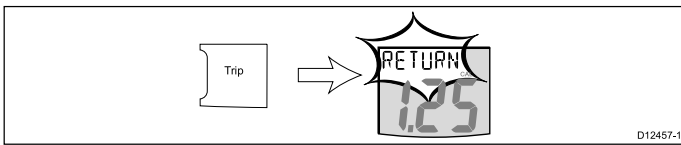

The text RETURN will flash at the top of the page and the displayed distance freezes.

**Note:** The displayed distance value may not be the same as the measured distance, due to errors introduced by tidal flow.

7. Turn your vessel round, start the return leg and as you do so, press the **Trip** button so RETURN stops flashing and the displayed value increments.

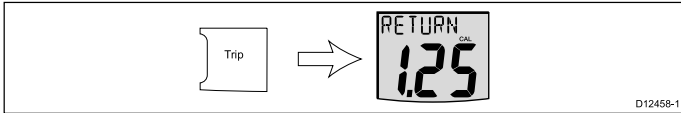

8. At the end of the return leg, press the **Trip** button.  
At this point:

- The text START 2 alternating with the new calibration factor is displayed at the top of the page.
- The displayed distance freezes

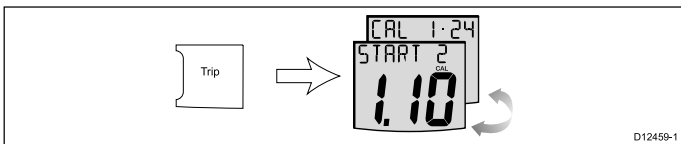

**Note:** The displayed distance should be very close to the actual (measured) distance of the calibration run.

- If you are satisfied with the results of the first calibration run, press the **Speed** and **Trip** buttons simultaneously to save the new calibration factor and exit speed calibration.
- If you want to carry out a second calibration run, press the **Trip** button.
- Follow steps 5 to 7 above again to complete a second calibration run.
- At the end of the return leg press the **Trip** button

- At this point:
- The text END alternating with the new calibration factor is displayed at the top of the page.
  - The displayed distance freezes

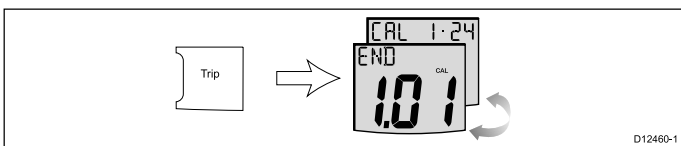

13. To exit the speed calibration run at any time, press and hold the **Speed** and **Trip** buttons simultaneously for 4 seconds.

### Checking i50 Tridata software version and status

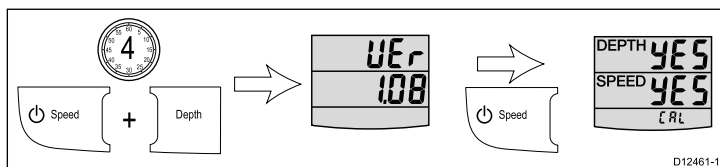

During normal operation:

- Press and hold the **Depth** and **Speed** buttons simultaneously for 4 seconds:  
The software version is displayed.
- Press the **Speed** button to display the instrument status.  
Master (transducer connected) or Repeater (No transducer connected).
- To change the depth status:
  - Press the **Trip** and **Reset** buttons simultaneously to enter adjust mode.  
The status flashes when in adjust mode.

ii. Press either **Trip** or **Reset** to switch the status between Master or Repeater.

- Press the **Speed** button again to begin speed run calibration.
- To exit the Intermediate calibration settings at any time, press and hold the **Depth** and **Speed** buttons simultaneously for 4 seconds:

### Performing speed run calibration – i50 Tridata

This speed calibration involves carrying out up to 2 runs over a measured distance, to enable a calibration factor to be determined and applied to your unit. Each run consists of an outward and a return leg, to minimize the effect of tidal drift when the calibration factor is determined.

From the Intermediate calibration page:

**Note:** This procedure is not required if current speed is set to SOG.

- Press the **Speed** button until you reach the Calibration run length page.

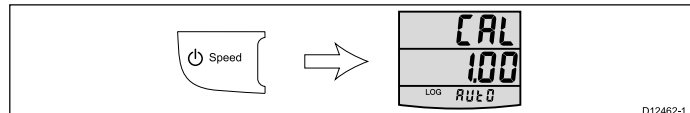

- Press the **Trip** and **Reset** buttons simultaneously to enter adjust mode.

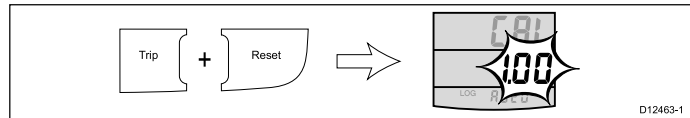

In adjust mode the run length flashes.

- Use the **Trip** or **Reset** button to set the run length to the required value (between 0.25 and 2.50).
- Press the **Trip** and **Reset** buttons simultaneously to commence the speed run calibration

The calibration status page is displayed. The text at the top of the page alternates between START 1 and the calibration factor currently applied.

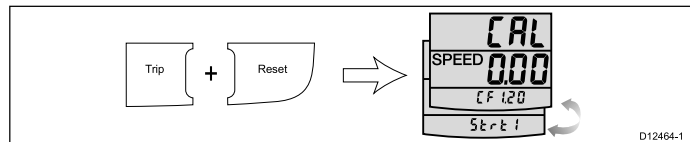

- Start the outward leg of the calibration run and as you pass the start point, press the **Speed** button, so the page shows OUTWARD at the top. As the calibration run proceeds, the displayed value will change.

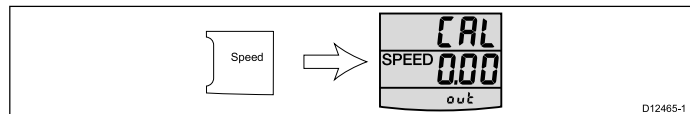

- At the end of the outward leg press **Speed** again.

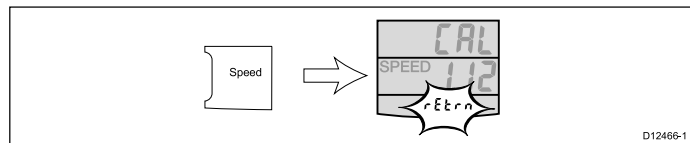

The text RETURN will flash at the top of the page and the displayed distance freezes.

**Note:** The displayed distance value may not be the same as the measured distance, due to errors introduced by tidal flow.

- Turn your vessel round, start the return leg and as you do so, press the **Speed** button so RETURN stops flashing and the displayed value increments.

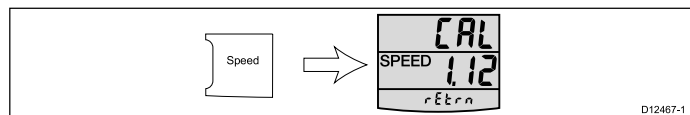

- At the end of the return leg, press the **Speed** button.  
At this point:



- The text START 2 alternating with the new calibration factor is displayed at the top of the page.
- The displayed distance freezes

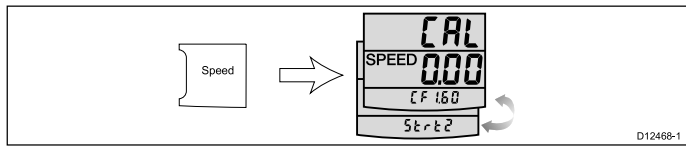

**Note:** The displayed distance should be very close to the actual (measured) distance of the calibration run.

9. If you are satisfied with the results of the first calibration run, press the **Depth** and **Speed** buttons simultaneously to save the new calibration factor, exit speed calibration and return to the status page.
10. If you want to carry out a second calibration run, press the **Speed** button.
11. Follow steps 5 to 7 above again to complete a second calibration run.
12. At the end of the return leg press the **Speed** button  
At this point:
  - The text END alternating with the new calibration factor is displayed at the top of the page.
  - The displayed distance freezes.

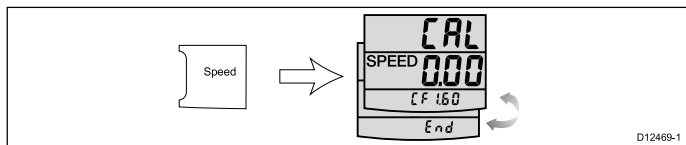

13. To exit the speed calibration run at any time, press and hold the **Depth** and **Speed** buttons simultaneously for 4 seconds.

## Dealer calibration

The dealer calibration procedures include:

i50 Depth	i50 Speed	i50 Tridata
Setting User calibration options on or off.	Setting User calibration options on or off.	Setting User calibration options on or off.
Setting required depth response.	Setting required speed response.	Setting data source for speed information.
Setting boat show mode on or off.	Setting required VMG response.	Setting required speed response.
Restore factory default	Setting boat show mode on or off.	Setting required depth response.
	Restore factory default	Setting boat show mode on or off.
		Restore factory default

### Setting dealer calibration options – i50 Depth

During normal operation:

1. Press and hold the **Depth** and **Alarm** buttons simultaneously for approximately 14 seconds to display the dealer calibration entry page.

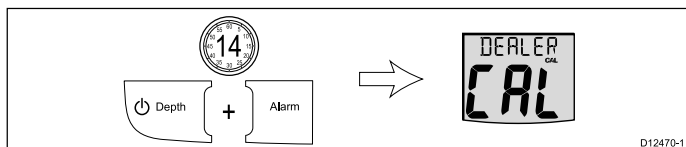

2. Press the **Offset** and **Reset** buttons simultaneously to display the user calibration access page.

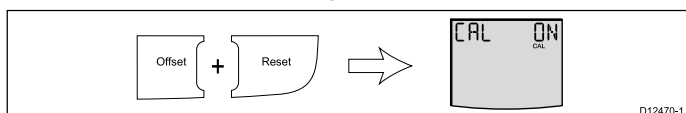

3. Use the **Offset** or **Reset** buttons to switch the user calibration on and off.

4. Press the **Depth** button to display the depth response page.

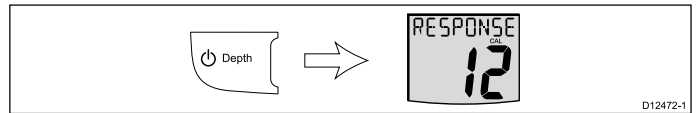

5. Use the **Offset** or **Reset** buttons to set the required depth response setting.

6. Press the **Depth** button to display the boat show mode page.

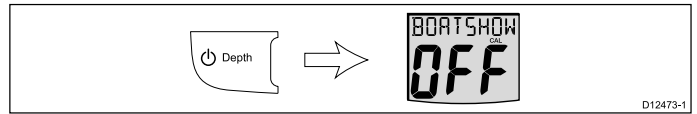

7. Press the **Depth** button to display the factory reset page.

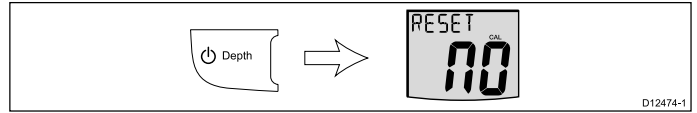

8. Use the **Offset** or **Reset** buttons to reset the units settings to factory default values.

9. To exit the dealer calibration pages at any time, press and hold the **Depth** and **Alarm** buttons simultaneously for approximately 2 seconds.

### Setting dealer calibration options - i50 Speed

During normal operation:

1. Press and hold the **Speed** and **Trip** buttons simultaneously for approximately 14 seconds to display the dealer calibration entry page.

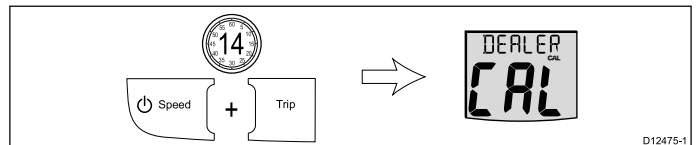

2. Press the **Timer** and **Reset** buttons simultaneously to display the user calibration access page.

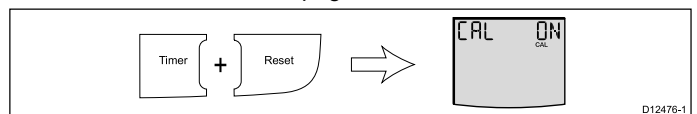

3. Press the **Speed** button to display the speed response page.

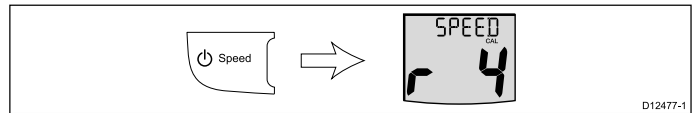

4. Use the **Timer** or **Reset** buttons to set the required speed response value.

5. Press the **Speed** button to display the speed VMG response page.

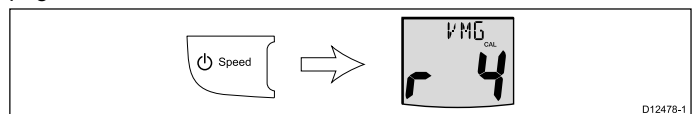

6. Use the **Timer** or **Reset** buttons to set the required VMG response value.

7. Press the **Speed** button to display the boat show mode page.

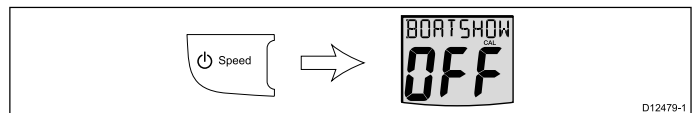

8. Use the **Timer** or **Reset** buttons to switch boat show mode on and off.

9. Press the **Speed** button to display the factory reset page.

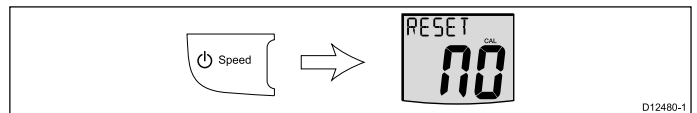

10. Use the **Timer** or **Reset** buttons to reset the units settings to factory default values

11. To exit the dealer calibration pages at any time, press and hold the **Speed** and **Trip** buttons simultaneously for approximately 2 seconds.

## Setting dealer calibration options - i50 Tridata

During normal operation:

1. Press and hold the **Depth** and **Speed** buttons simultaneously for approximately 14 seconds to display the dealer calibration entry page.

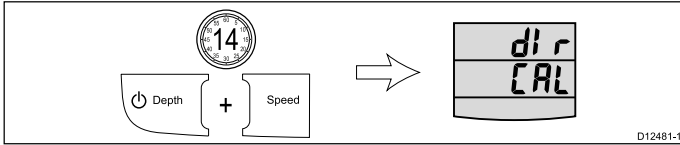

2. Press the **Trip** and **Reset** buttons simultaneously to display the user calibration access page.

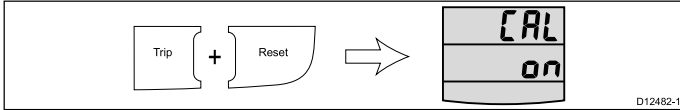

3. Press the **Depth** button to display the speed select page.

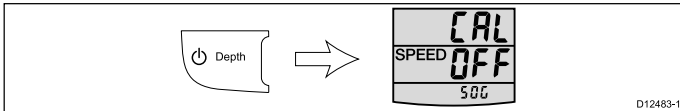

4. Use the **Trip** or **Reset** buttons to switch the speed data source on and off.

5. Press the **Depth** button to display the speed response page.

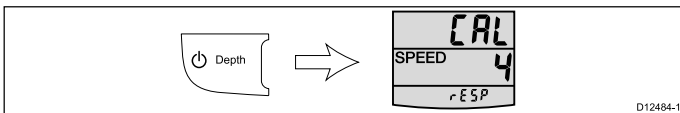

6. Use the **Trip** or **Reset** buttons to set the required speed response value.

7. Press the **Depth** button to display the depth response page.

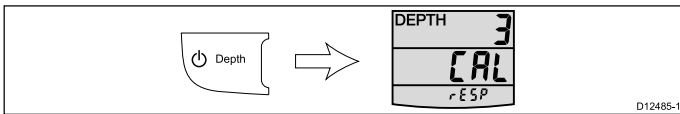

8. Use the **Trip** or **Reset** buttons to set the required depth response value.

9. Press the **Depth** button to display the boat show mode page.

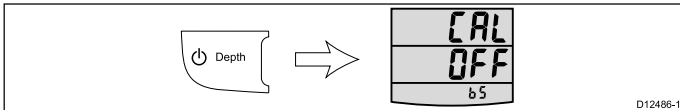

10. Use the **Trip** or **Reset** buttons to switch boat show mode on and off.

11. Press the **Depth** button to display the factory reset page.

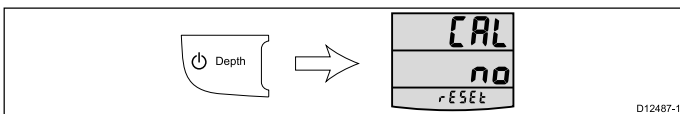

12. Use the **Trip** or **Reset** buttons to reset the units settings to factory default values

13. To exit the Dealer calibration pages at any time, press and hold the **Depth** and **Speed** buttons simultaneously for approximately 2 seconds.



# Chapter 7: Using your display

## Chapter contents

- [7.1 Pages](#)
- [7.2 i50 Depth operation](#)
- [7.3 i50 Speed operation](#)
- [7.4 i50 Tridata operation](#)
- [7.5 Group illumination](#)

## 7.1 Pages

The pages available depend on the display variant and are shown in the table below:

i50 Depth	i50 Speed	i50 Tridata
Current depth	Boat speed	Current depth
*Maximum depth	Speed over ground (SOG)	Shallow alarm threshold
*Minimum depth	Velocity made good (VMG)	Deep alarm threshold
Shallow alarm	*Average speed	Anchor shallow alarm threshold
Deep anchor alarm	*Maximum speed	Anchor deep alarm threshold
Shallow anchor alarm	Boat log	Boat speed Maximum speed
Deep alarm	Water temperature	*Average speed
	Trip distance	VMG to windward
	Count up timer	Water temperature
	Race start timer 1	Count up timer
	Race start timer 2	Race start timer 1
		Race start timer 2
		Boat log
		Trip distance

**Note:** These pages are temporary pages and will time-out to the previous permanent page after 5 seconds of inactivity.

## Changing pages

During normal operation:

- Depending on unit variant press either the **Depth**, **Speed**, **Timer** or **Trip** buttons to cycle through the pages.

## 7.2 i50 Depth operation

When connected to the relevant depth transducer, your i50 depth instrument:

- Provides current depth information, in either feet (ft), metres (M) or fathoms (FA).
- Records the minimum and maximum depth encountered during the period the unit is switched on.
- Enables you to define alarm thresholds for shallow alarm, deep alarm, shallow anchor alarm and deep anchor alarm.
- Enables you to see what offset has been applied to the depth reading.

**Note:** Depth information is obtained from the depth transducer connected to the unit. However, when the instrument is connected to a SeaTalk network, which contains a compatible sonar module (fishfinder) the depth information is provided by the sonar module, whilst it is switched on.

It should be noted that:

- The required depth units are selected during User calibration.
- Up / Down depth-trend arrows are displayed, if the seabed is rising or falling.
- If for any reason depth information is lost, the depth title will flash and the displayed value will be the last known depth reading.

## Using the depth pages

To cycle through the depth pages follow the steps below.

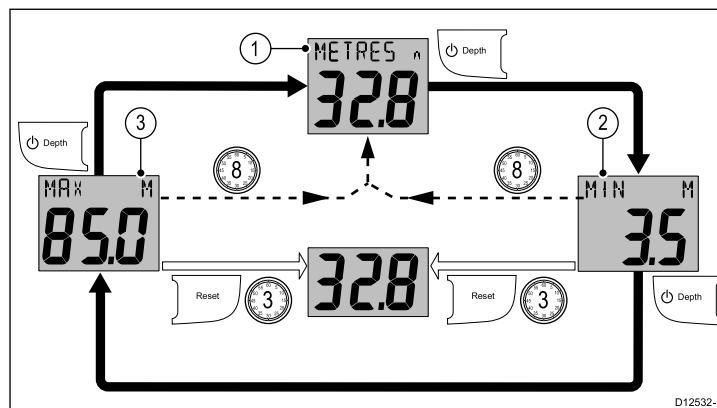

With the **Current depth** page display:

- Press the **Depth** button to display the **Minimum depth** page.
- From the **Minimum depth** page:
  - Press the **Depth** button to display the **Maximum depth** page, or
  - Press and hold the **Reset** button for 3 seconds to reset the minimum depth to the current depth reading.
- From the **Maximum depth** page:
  - Press the **Depth** button to display the **Current depth** page, or
  - Press and hold the **Reset** button for 3 seconds to reset the maximum depth to the current depth reading.

**Note:** Only the **Current depth** page is a permanent page, all other pages will time-out after 8 seconds and revert back to the **Current depth** page.

## Viewing the depth offset

To view the offset value currently applied to your instrument follow the steps below.

During normal operation:

- Press the **Offset** button to display the **Depth offset** page.

The display shows the value of the offset applied and identifies:

  - If a positive offset value is applied **W/L** is displayed to denote a waterline offset.
  - If a negative offset value is applied **KEEL** is displayed to denote a keel offset.
  - If a zero offset value is applied **OFFSET** is displayed to denote that there is a zero offset from the transducer.

**Note:** Depth offset information is only available on units set as data masters (see *Data master* section for details).

## 7.3 i50 Speed operation

When connected to the relevant speed or speed and temperature transducer, your i50 Speed instrument provides:

- Current, maximum and average speed information, in either knots (KTS), mile per hour (MPH) or kilometers per hour (KPH).
- Log and trip information, in either nautical miles (NM), statute miles (M) or kilometers (KM).
- Water temperature information, in either degrees celsius (°C) or fahrenheit (°F).
- Velocity made good (VMG) information, VMG is only available when connected to SeaTalk or SeaTalk<sup>ng</sup> network which also contains a compatible wind transducer.
- Speed over ground (SOG) information, SOG is only available when connected to SeaTalk or SeaTalk<sup>ng</sup> network which also contains a suitable GPS.
- Count-up and race start timers

**Note:** The required speed, distance and temperature units are selected during User calibration.

It should be noted that:

- The maximum speed, average speed and trip reading are reset to zero at power up.
- The log screen shows the total distance covered by the vessel since the unit was fitted.

### Using the speed pages

To cycle through the speed pages follow the steps below:

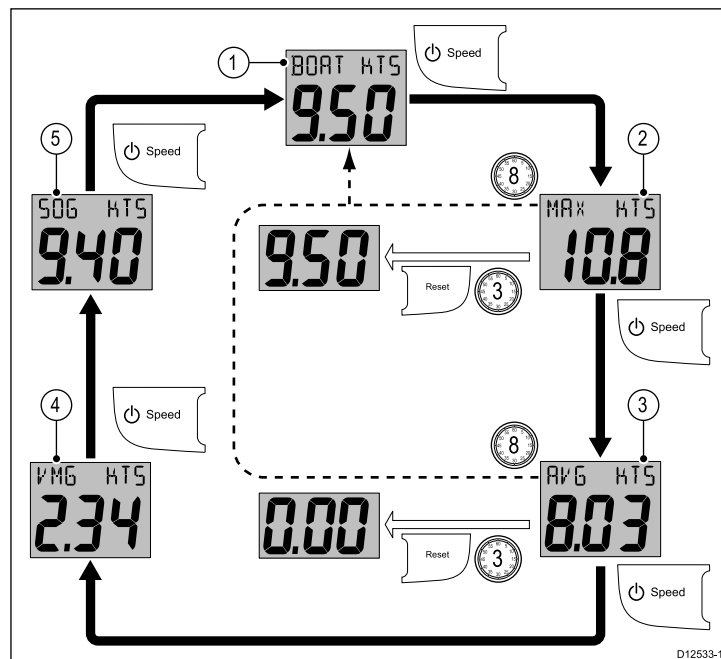

With the **Current speed** page displayed:

1. Press the **Speed** button to display the **Maximum speed** page.
2. From the **Maximum speed** page:
  - i. Press the **Speed** button to display the **Average speed** page, or
  - ii. Press and hold the **Reset** button for 3 seconds to set the maximum speed value to the vessel's current speed.
3. From the **Average speed** page:
  - i. Press the **Speed** button to display the **VMG** page, or

**Note:** The VMG information is only available if your unit is part of a SeaTalk or SeaTalk<sup>ng</sup> network which has a compatible wind instrument connected.

- ii. Press and hold the **Reset** button for 3 seconds to set the average speed value to zero.

- From the **VMG** page, press the **Speed** button to display the **SOG** page:

**Note:** SOG information is only available if your unit is part of a SeaTalk or SeaTalk<sup>ng</sup> network which has a suitable GPS connected.

- From the **SOG** page, press the **Speed** button to display the **Current speed** page.

**Note:** The **Maximum speed** and **Average speed** pages are temporary pages and will time-out after 8 seconds and revert back to the **Current speed** page.

## Using the log, trip and temperature pages

To cycle through the available log, trip and water temperature pages follow the steps below.

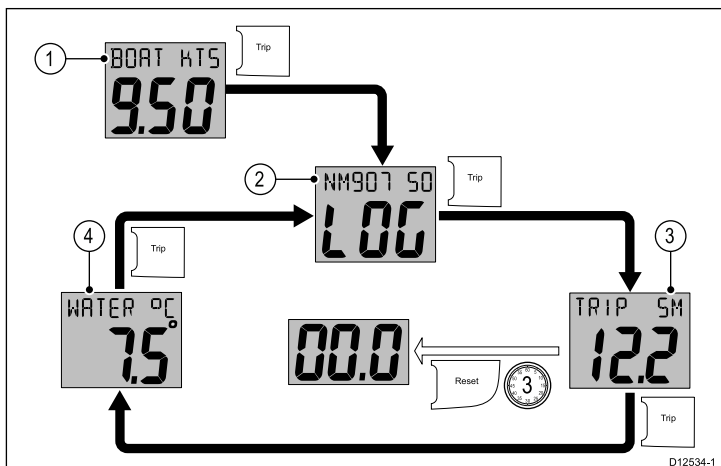

During normal operation:

- Press the **Trip** button to display the **Log** page.
- Press the **Trip** button to display the **Trip** page.
- From the **Trip** page:
  - Press the **Trip** button to display the **Water temperature** page, or
  - Press and hold the **Reset** button for 3 seconds to reset the trip reading to zero.
- Press the **Trip** button to display the **Log** page.

## Using the timers

To cycle through and use the count-up and race timer pages follow the steps below.

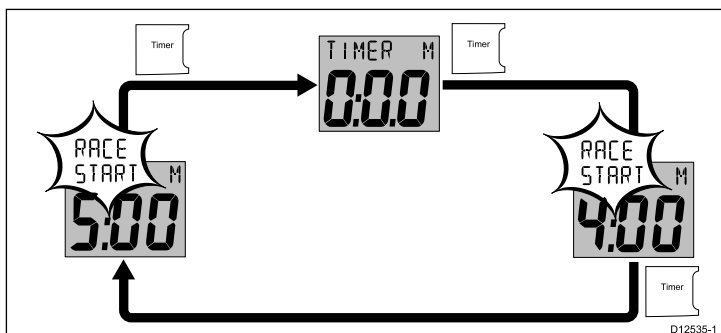

During normal operation:

- Press the **Timer** button to cycle through the available timers.
- Press the **Reset** button to start the timer.
- With the timer running, press the **Reset** button to pause the timer.
- With the timer running, press and hold the **Reset** button for 1 second to reset the timer.

**Note:** After a race start timer has counted down to zero it will then start to count up.

## Setting the race start timer

The race start timers can be set from 1 to 15 minutes.

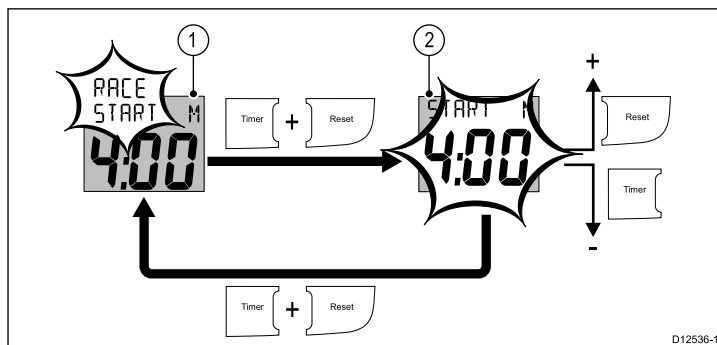

With a **race timer** displayed

- Press and hold the **Timer** and **Reset** buttons simultaneously to enter adjust mode.
- In adjust mode:
  - Use the **Reset** button to increment the race timer start value, or
  - Use the **Timer** button to decrease the race timer start value.
  - Press and hold the **Timer** and **Reset** buttons simultaneously to exit adjust mode.

## Timer buzzer

The Timer buzzer is enabled or disabled during calibration see the *User calibration* section.

When using a race timer with the timer buzzer enabled, the buzzer will:

- Double beep every minute.
- Beep 3 times at the start of the last 30 seconds.
- Beep once for each of the last 10 seconds.
- Beep for 2 seconds at zero.

## 7.4 i50 Tridata operation

When connected to the relevant transducer(s) your i50 Tridata instrument:

- Provides depth information in either feet (FT) or metres (M).
- Enables you to define alarm thresholds for shallow alarm, deep alarm, shallow anchor alarm and deep anchor alarm.
- Provides speed information (current, maximum and average), in either knots (KTS), miles per hour (MPH) or kilometers per hour (KPH).
- Velocity made good (VMG) information, VMG is only available when connected to SeaTalk or SeaTalk<sup>ng</sup> network which also contains a compatible wind transducer.
- Provides log and trip information. These are given in either nautical miles (NM), statute miles (M) or kilometers (KM).
- Provides water temperature information. This is given in either degrees celsius (°C) or degrees fahrenheit (°F).
- Provides count up and race start timer functions.

**Note:** Depth information is obtained from the depth transducer connected to the unit. However, when the instrument is connected to a SeaTalk network, which contains a compatible sonar module (fishfinder) the depth information is provided by the sonar module whilst it is switched on.

It should be noted that:

- The required units of measurement are set during User calibration.
- Up / Down depth-trend arrows are displayed, if the seabed is rising or falling at a significant rate.
- The log screen shows the total distance covered by the vessel since the unit was fitted.
- Maximum speed, average speed and trip reading are reset to zero at power up.
- If for any reason depth information is lost, the depth title will flash and the displayed value will be the last known depth reading.

### i50 Tridata display layout

The i50 Tridata display is divided into 3 separate areas, each of which displays a separate type of information, as shown below.

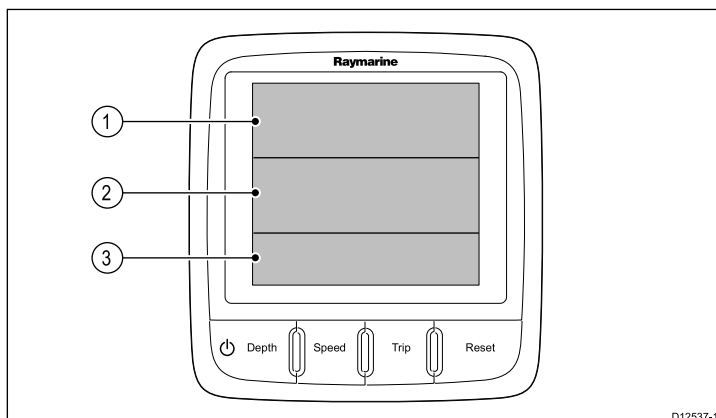

1	Depth information
2	Speed information
3	Trip, log, water temperature and timer

### Using the Tridata pages

1. Use the **Depth** button to access depth information.
2. Use the **Speed** button to access speed information.
3. Use the **Trip** button to access the log, trip, water temperature and timer information.

### Using Tridata depth pages

To cycle through the depth pages follow the steps below.

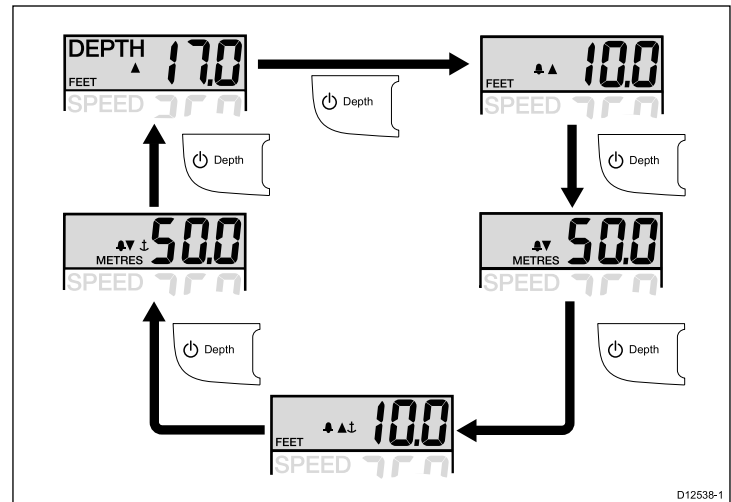

1. Use the **Depth** button to cycle through the available depth pages.

Available depth pages are:

- Current depth
- Shallow depth alarm
- Deep depth alarm
- Shallow anchor alarm
- Deep anchor alarm

**Note:** Alarm pages are temporary pages will time-out after 8 seconds and revert to the **Current depth** page.

To enable / disable alarms or to adjust alarm thresholds please refer to the *Alarms* section.

### Using Tridata speed pages.

To cycle through the speed pages follow the steps below.

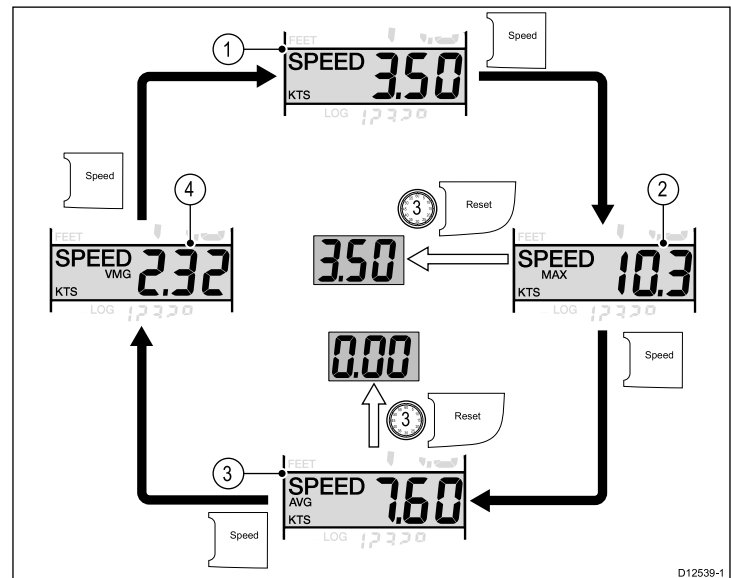

With the **Current speed** page displayed:

1. Press the **Speed** button to display the **Maximum speed** page.
2. With the **Maximum speed** page displayed:
  - i. Press the **Speed** button to display the **Average speed** page, or
  - ii. Press and hold the **Reset** button for 3 seconds to reset the maximum speed reading to the vessel's current speed.
3. With the **Average speed** page displayed:
  - i. Press the **Speed** button to display the **VMG** page, or
  - ii. Press and hold the **Reset** button for 3 seconds to reset the average speed to zero.
4. From the **VMG** page, press the **Speed** button to display the **Current speed** page.



# Chapter 8: Using alarms

## Chapter contents

- [8.1 Alarms](#)

## 8.1 Alarms

Alarms alert you to a situation or hazard requiring your attention.

You can set up alarms to alert you to certain conditions.

Alarms are raised by system functions, and also external equipment connected to your display.

When an alarm event occurs an audible and visual alarm is activated which indicates the alarm state.

Alarm thresholds can be configured from the relevant alarm page / menu.

### Instrument alarms

The alarms available for the i50 Depth and i50 Tridata are listed below.

- Shallow depth alarm
- Deep depth alarm
- Shallow anchor alarm
- Deep anchor alarm

### Alarm indications

An alarm event is indicated by both audible and visual warnings.

#### Shallow alarm



#### Deep alarm

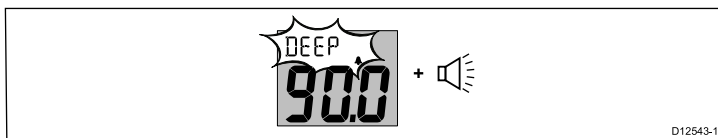

#### Shallow anchor alarm



#### Deep anchor alarm

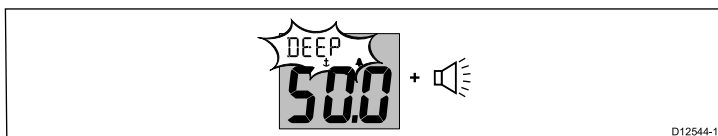

Alarms are sounded when the set alarm threshold value is crossed. Alarms will sound until silenced.

### Silencing alarms

1. Press any button to silence an active alarm.

### Enabling / Disabling alarms

Alarms can be enabled or disabled at any time.

With the relevant alarm page displayed:

1. Press and hold the **Reset** button for 1 second to switch the alarm on or off.

### Setting alarm thresholds — i50 Depth

You can adjust the threshold at which alarms are triggered by following the steps below.

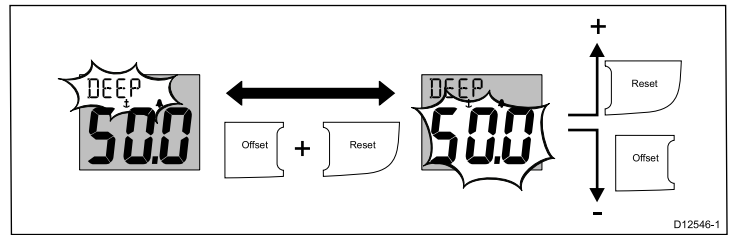

With the relevant alarm page displayed:

1. Press the **Offset** and **Reset** buttons simultaneously to enter adjust mode.  
The current threshold will start to flash.
2. Use the **Reset** button to increase the alarm threshold.
3. Use the **Offset** button to decrease the alarm threshold.
4. Press the **Offset** and **Reset** buttons simultaneously to save the new alarm threshold and exit adjust mode.

**Note:** The illustration above is an example depicting setting the Deep anchor alarm threshold.

### Setting alarm thresholds — i50 Tridata

You can adjust the threshold at which alarms are triggered by following the steps below.

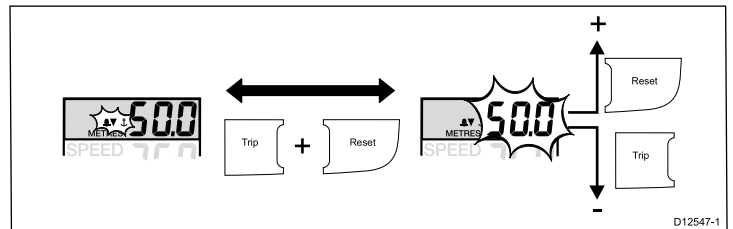

With the relevant alarm page displayed:

1. Press the **Trip** and **Reset** buttons simultaneously to enter adjust mode.  
The current threshold will start to flash.
2. Use the **Reset** button to increase the alarm threshold.
3. Use the **Trip** button to decrease the alarm threshold.
4. Press the **Trip** and **Reset** buttons simultaneously to save the new alarm threshold and exit adjust mode.

**Note:** The illustration above is an example depicting setting the Deep anchor alarm threshold.



# Chapter 9: Maintaining your display

## Chapter contents

- [9.1 Service and maintenance](#)
- [9.2 Condensation](#)
- [9.3 Routine equipment checks](#)
- [9.4 Cleaning](#)
- [9.5 Cleaning the display case](#)
- [9.6 Cleaning the display screen](#)

## 9.1 Service and maintenance

This product contains no user serviceable components. Please refer all maintenance and repair to authorized Raymarine dealers. Unauthorized repair may affect your warranty.

## 9.3 Routine equipment checks

Raymarine strongly recommends that you complete a number of routine checks to ensure the correct and reliable operation of your equipment.

Complete the following checks on a regular basis:

- Examine all cables for signs of damage or wear and tear.
- Check that all cables are securely connected.

## 9.5 Cleaning the display case

The display unit is a sealed unit and does not require regular cleaning. If it is necessary to clean the unit, follow this basic procedure:

1. Switch off the power to the display.
2. Wipe the display with a clean, soft cloth (a microfibre cloth is ideal).
3. If necessary, use isopropyl alcohol (IPA) or a mild detergent to remove grease marks.

**Note:** Do NOT use IPA or any other solvent or detergent on the screen itself.

**Note:** In certain conditions, condensation may appear inside the display screen. This will not harm the unit, and can be cleared by powering on the display for a short time.

## 9.2 Condensation

Certain atmospheric conditions may cause a small amount of condensation to form on the unit's window. This will not damage the unit and will clear after the unit has been switched on for a short period.

## 9.4 Cleaning

Best cleaning practices.

When cleaning this product:

- Do NOT wipe the display screen with a dry cloth, as this could scratch the screen coating.
- Do NOT use abrasive, or acid or ammonia based products.
- Do NOT use a jet wash.

## 9.6 Cleaning the display screen

A coating is applied to the display screen. This makes it water repellent, and prevents glare. To avoid damaging this coating, follow this procedure:

1. Switch off the power to the display.
2. Rinse the screen with fresh water to remove all dirt particles and salt deposits.
3. Allow the screen to dry naturally.
4. If any smears remain, very gently wipe the screen with a clean microfibre cleaning cloth (available from an opticians).

# Chapter 10: Troubleshooting

## Chapter contents

- [10.1 Troubleshooting](#)
- [10.2 Instrument troubleshooting](#)
- [10.3 Power up troubleshooting](#)
- [10.4 Miscellaneous troubleshooting](#)
- [10.5 Self-test](#)

## 10.1 Troubleshooting

The troubleshooting information provides possible causes and corrective action required for common problems associated with marine electronics installations.

All Raymarine products are, prior to packing and shipping, subjected to comprehensive test and quality assurance programs. However, if you experience problems with the operation of your product this section will help you to diagnose and correct problems in order to restore normal operation.

If after referring to this section you are still having problems with your unit, please contact Raymarine Technical Support for further advice.

## 10.2 Instrument troubleshooting

Fault	Cause	Action
Blank display.	No power supply.	<ul style="list-style-type: none"> <li>• Check fuse / circuit breaker.</li> <li>• Check power supply.</li> <li>• Check SeaTalk / SeaTalk<sup>ng</sup> cabling and connector security.</li> </ul>
SeaTalk / SeaTalk <sup>ng</sup> information not being transferred between instruments.	SeaTalk / SeaTalk <sup>ng</sup> cabling or connector fault.	<ul style="list-style-type: none"> <li>• Check security of SeaTalk / SeaTalk<sup>ng</sup> connections between units.</li> <li>• Check condition of SeaTalk / SeaTalk<sup>ng</sup> cables.</li> <li>• Isolate faulty unit by disconnecting units one by one.</li> </ul>
A group of SeaTalk / SeaTalk <sup>ng</sup> units not working.	SeaTalk / SeaTalk <sup>ng</sup> cabling or connector fault.	<ul style="list-style-type: none"> <li>• Check the security of SeaTalk / SeaTalk<sup>ng</sup> connectors between functioning and non-functioning units.</li> <li>• Check the condition of SeaTalk / SeaTalk<sup>ng</sup> cable between functioning and non-functioning units.</li> </ul>
<b>LAST</b> flashing or dashes displayed continuously (depth greater than 3 feet).	Transducer cable or connector fault.	<ul style="list-style-type: none"> <li>• Check condition of the transducer cable(s) and the security of the connections.</li> </ul>
<b>LAST</b> flashes when under way.	Aerated water due to vessel wakes, propeller wash etc.	<ul style="list-style-type: none"> <li>• Ensure reading stabilizes when clear of disturbed water.</li> </ul>

## 10.3 Power up troubleshooting

Problems at power up and their possible causes and solutions are described here.

Problem	Possible causes	Possible solutions
The system (or part of it) does not start up.	Power supply problem.	Check relevant fuses and breakers.
		Check that the power supply cable is sound and that all connections are tight and free from corrosion.
		Check that the power source is of the correct voltage and sufficient current.

## 10.4 Miscellaneous troubleshooting

Miscellaneous problems and their possible causes and solutions are described here.

Problem	Possible causes	Possible solutions
Display behaves erratically: <ul style="list-style-type: none"> <li>• Frequent unexpected resets.</li> <li>• System crashes or other erratic behavior.</li> </ul>	Intermittent problem with power to the display.	Check relevant fuses and breakers.
		Check that the power supply cable is sound and that all connections are tight and free from corrosion.
		Check that the power source is of the correct voltage and sufficient current.
	Software mismatch on system (upgrade required).	Go to raymarine and click on support for the latest software downloads.
	Corrupt data / other unknown issue.	Perform a factory reset. <div style="border: 1px solid black; padding: 5px; margin-top: 5px;"> <p><b>Important:</b> This will result in the loss of any settings and data (such as waypoints) stored on the product. Save any important data to a memory card before resetting.</p> </div>



# Chapter 11: Technical support

## Chapter contents

- [11.1 Raymarine customer support](#)
- [11.2 Checking the software version](#)



## 11.1 Raymarine customer support

Raymarine provides a comprehensive customer support service. You can contact customer support through the Raymarine website, telephone and email. If you are unable to resolve a problem, please use any of these facilities to obtain additional help.

### Web support

This contains Frequently Asked Questions, servicing information, e-mail access to the Raymarine Technical Support Department and details of worldwide Raymarine agents.

### Product information

If you need to request service, please have the following information to hand:

- Product name.
- Product identity.
- Serial number.
- Software application version.

You can obtain this product information using the menus within your product.

## 11.2 Checking the software version

Depending on the instrument display variant follow the steps below to identify the software version of your unit.

During normal operation:

1. **i50 Depth** — Press and hold the **Depth** and **Alarm** buttons simultaneously for 4 seconds.
2. **i50 Speed** — Press and hold the **Speed** and **Trip** buttons simultaneously for 4 seconds.
3. **i50 Tridata** — Press and hold the **Depth** and **Speed** buttons simultaneously for 4 seconds.

The software version will be displayed on the screen.

# Chapter 12: Technical specification

## Chapter contents

- [12.1 Technical specification](#)

## 12.1 Technical specification

Nominal supply voltage	12 V dc
Operating voltage range	10 V dc to 16 V dc
Power consumption	<ul style="list-style-type: none"><li>• &lt; 1 W Typical (Display only)</li><li>• 2.4 W Maximum (Transducer connected)</li></ul>
Current	<ul style="list-style-type: none"><li>• 45 to 65 mA Typical (Display only)</li><li>• 200 mA Maximum (Transducer connected)</li></ul>
LEN (Refer to SeaTalk <sup>ng</sup> reference manual for further information.)	4
Environmental	Operating temperature: -20°C to +55°C Storage temperature: -30°C to +70°C Relative humidity: 93% Water proofing: IPX6
Connections	<ul style="list-style-type: none"><li>• 2 x SeaTalk<sup>ng</sup> connections (compliant with SeaTalk)</li><li>• Transducer connections</li></ul>
Conformance	Europe 2004/108/EC

# Chapter 13: Spares and accessories

## Chapter contents

- [13.1 i50 transducers](#)
- [13.2 Spares](#)
- [13.3 SeaTalk<sup>ng</sup> cables and accessories](#)
- [13.4 Converters](#)

## 13.1 i50 transducers

The following transducers are available for the i50 range:

Description	Part number	Notes
Depth transducer	M78713-PZ	
Speed transducer	E26031	

**Note:** Other transducers are available please check with your local Raymarine dealer.

## 13.2 Spares

The table below lists the spare parts available for i50 instrument displays

Description	Part number	Note
i50 / i60 / i70 front bezel	R22168	
i50 / i60 / i70 Sun cover	R22169	
i50 Depth keypad	R70131	
i50 Speed keypad	R70130	
i50 Tridata keypad	R70132	

## 13.3 SeaTalk<sup>ng</sup> cables and accessories

SeaTalk<sup>ng</sup> cables and accessories for use with compatible products.

Description	Part No	Notes
Backbone Kit	A25062	Includes: <ul style="list-style-type: none"> <li>• 2 x 5 m (16.4 ft) Backbone cable</li> <li>• 1 x 20 m (65.6 ft) Backbone cable</li> <li>• 4 x T-piece</li> <li>• 2 x Backbone terminator</li> <li>• 1 x Power cable</li> </ul>
SeaTalk <sup>ng</sup> 0.4 m (1.3 ft) spur	A06038	
SeaTalk <sup>ng</sup> 1 m (3.3 ft) spur	A06039	
SeaTalk <sup>ng</sup> 3 m (9.8 ft) spur	A06040	
SeaTalk <sup>ng</sup> 5 m (16.4 ft) spur	A06041	
SeaTalk <sup>ng</sup> 0.4 m (1.3 ft) backbone	A06033	
SeaTalk <sup>ng</sup> 1 m (3.3 ft) backbone	A06034	
SeaTalk <sup>ng</sup> 3 m (9.8 ft) backbone	A06035	
SeaTalk <sup>ng</sup> 5 m (16.4 ft) backbone	A06036	
SeaTalk <sup>ng</sup> 9 m (29.5 ft) backbone	A06068	
SeaTalk <sup>ng</sup> 20 m (65.6 ft) backbone	A06037	
SeaTalk <sup>ng</sup> to bare ends 1 m (3.3 ft) spur	A06043	
SeaTalk <sup>ng</sup> to bare ends 3 m (9.8 ft) spur	A06044	
SeaTalk <sup>ng</sup> Power cable	A06049	
SeaTalk <sup>ng</sup> Terminator	A06031	
SeaTalk <sup>ng</sup> T-piece	A06028	Provides 1 x spur connection
SeaTalk <sup>ng</sup> 5-way connector	A06064	Provides 3 x spur connections
SeaTalk to SeaTalk <sup>ng</sup> converter	E22158	Allows the connection of SeaTalk devices to a SeaTalk <sup>ng</sup> system.
SeaTalk <sup>ng</sup> Inline terminator	A80001	Provides direct connection of a spur cable to the end of a backbone cable. No T-piece required.
SeaTalk <sup>ng</sup> Blanking plug	A06032	
SeaTalk (3 pin) to SeaTalk <sup>ng</sup> adaptor cable 0.4 m (1.3 ft)	A06047	
SeaTalk2 (5 pin) to SeaTalk <sup>ng</sup> adaptor cable 0.4 m (1.3 ft)	A06048	
DeviceNet adaptor cable (Female)	A06045	Allows the connection of NMEA 2000 devices to a SeaTalk <sup>ng</sup> system.

Description	Part No	Notes
DeviceNet adaptor cable (Male)	A06046	Allows the connection of NMEA 2000 devices to a SeaTalk <sup>ng</sup> system.
DeviceNet adaptor cable (Female) to bare ends.	E05026	Allows the connection of NMEA 2000 devices to a SeaTalk <sup>ng</sup> system.
DeviceNet adaptor cable (Male) to bare ends.	E52027	Allows the connection of NMEA 2000 devices to a SeaTalk <sup>ng</sup> system.

## 13.4 Converters

Part number	Description
E22158	SeaTalk to SeaTalk <sup>ng</sup> Converter

## Appendix A NMEA 2000 sentences

The i50 instrument range supports the following NMEA 2000 Parameter Group Number (PGN) sentences.

PG name	PGN	i50 Depth Transmit	i50 Depth Receive	i50 Speed Transmit	i50 Speed Receive	i50 Tridata Transmit	i50 Tridata Receive
ISO Acknowledgement	59392	•		•		•	
ISO Request	59904		•		•		•
ISO Address claim	60928	•	•	•	•	•	•
ISO Commanded address	65240		•		•		•
NMEA Request group function	126208		•		•		•
NMEA Command group function	126208		•	•	•	•	•
NMEA Acknowledge group function	126208	•		•	•	•	•
PGN list — Transmit PGN's group function	126464	•		•		•	
PGN list — Received PGN's groupfunction	126464	•		•		•	
Product information	126996	•	•	•	•	•	•
Speed	128259			•	•	•	•
Water depth	128267	•	•			•	•
Distance log	128275			•	•	•	•
COG & SOG rapid update	129026				•		•
GNSS Position data	129029				•		•
Wind data	130306				•		•
Environmental parameters	130310			•	•	•	•
Environmental parameters	130311				•		•
Temperature	130312			•	•	•	•