

LIVE.  
WORK.  
PLAY.



**2021**

---

RETAIL





Horizon Global is the #1 designer, manufacturer and distributor of a wide variety of high-quality, custom engineered towing, trailering, cargo management and other related accessory products in North America, Australia and Europe.

## REESE®

REESE brand has become a household name in the **heavy-duty towing** industry. From heavy duty fifth wheels and pin boxes to weight distribution systems to control sway, REESE's proven designs exceed industry standards, making it the brand of choice when performance is the expectation.

## DRAW-TITE®

Draw-Tite was born out of a passion for outstanding performance and has come to represent **one of the best custom-fit vehicle products** available today. Each hitch designed must pass rigorous tests to become Tested Tough™. Draw-Tite is the brand of choice for years of dependable service.

## FULTON®

Fulton performs best when the weather is at its worst. When innovative design is combined with quality and value, the result is a brand that is the obvious choice for recreational and marine applications everywhere. The Fulton line of trailer jacks, winches, and couplers has become the **industry standard for light and medium-duty trailering**.

## BULLDOG®

The BULLDOG line is characterized by unmatched strength, reliability, safety and value; count on BULLDOG to be Tough and Tested™. Gooseneck hitches, gooseneck couplers, jacks, trailer couplers and Wedge-Latch™ elements feature a high-strength, heavy-duty design that makes them the **toughest trailer components** available today.

## TEKONSHA®

Tekonsha has evolved to become a **trusted name in towing safety**. The core product line consists of brake controllers, electrical wiring, trailer brakes, ModuLite® Modules and T-One® T-Connectors. Smooth, predictable stopping at all speeds has made the Tekonsha Prodigy®, Primus® and Voyager® trailer brake controls the best in class and most popular on the market.

LIVE.  
WORK.  
PLAY.

**LIVE.  
WORK.  
PLAY.**

# TABLE OF CONTENTS | 2021

## RECEIVER HITCHES.....A

Class I and II Receivers.....	A-4
Class III and IV Receivers.....	A-4
Class V Receivers.....	A-5
Multi-fit.....	A-5
ATV Hitch.....	A-6
Front Mounted Accessories.....	A-6
Front Mounted Receivers.....	A-7 - A-19
Application Guide.....	A-11 - A-81
Electrical Positions.....	A-82

## HITCH ACCESSORIES .....B

Hitch Balls.....	B-3 - B-4
Ball Mounts.....	B-5 - B-10
Accessories.....	B-11 - B-26
Specialty Ball Mounts.....	B-13 - B-18

## ELECTRICAL WIRING.....C

T-Connectors.....	C-3
Power Modules.....	C-4
Converters.....	C-5
Wire Harnesses.....	C-7 - C-13
Breakaway Systems.....	C-14
Electrical Accessories.....	C-15 - C-19
T-Connector Application Guide.....	A-11 - A-82

## BRAKE CONTROLS.....D

Proportional Brake Controls.....	D-2 - D-3
Timed Brake Controls.....	D-4 - D-5
Brake Control Wiring.....	D-5 - D-6
Wiring Harness Application Guide.....	D-7 - D-9

## CARGO MANAGEMENT .....E

Roof Racks.....	E-3
Rooftop Cargo Carriers.....	E-3
Cargo Bags.....	E-4 - E-6
Hitch Mounted Cargo Carriers.....	E-5
Cargo Nets.....	E-6
Bike Carriers.....	E-7
Watercraft Carriers.....	E-8
Truck and Van Racks.....	E-9
Loading Ramps.....	E-9 - E-14
Loading Ramp Accessories.....	E-15
Cargo Accessories.....	E-16

## JACKS, COUPLERS, WINCHES .....F

Trailer Jacks.....	F-2 - F-4
Trailer Couplers.....	F-5
Trailer Winches.....	F-6

## TRAILER LIGHTING .....G

Tail Lights.....	G-2 - G-6
Pedestal Mount Tail Lights.....	G-7
Clearance / Side Marker Lights.....	G-8 - G-13
Light Bars.....	G-14
Auxiliary Lights.....	G-15 - G-16
Reflectors.....	G-18
Specialty Lights.....	G-16 - G-20

## TRAILER & VEHICLE ACCESSORIES ....H

Breakaway Systems.....	H-2
Trailer Accessories.....	H-3 - H-6
Towing Accessories.....	H-3
Wheel Protection.....	H-4 - H-5
Vehicle Accessories.....	H-4 - H-5
Marine Trailer Accessories.....	H-6 - H-8

## WARRANTIES .....I

Warranties.....	I-2
-----------------	-----

## INDEX.....I

Receiver Hitches.....	I-3 - I-20
Front Mount Receiver Hitches.....	I-20 - I-22
Brake Control Harnesses.....	I-22 - I-24
T-Connectors.....	I-24 - I-30
Tow Harnesses.....	I-30 - I-32
6-Way / 7-Way Connectors.....	I-32 - I-33
Product Index.....	I-35 - I-40



# FEATURED PRODUCTS | 2021

## REESE TOWPOWER ADJUSTABLE TRI-BALL MOUNT



The adjustable mount only takes a pull of the pin and a turn to get ready for towing with the most common hitch ball sizes. Just like you, it's always ready to get the job done. Height adjusts easily and securely with pins included. Fits 2 in. receivers and rated up to 14,000 lbs. gross total weight.

- Ideal for those with multiple trailers

**i** See page B-10 for complete information

## TRAILER JACKS



REESE Towpower offers a complete line of jacks, couplers and winches that will keep your customers coming back for all their trailering and towing needs. Jacks are offered in a variety of mounting options including, retaining ring swivel, tubular swivel and the popular A-frame, with lift capacities ranging from 2,000 lbs. to 5,000 lbs. Crank handles are available in both topwind and sidewind models.

- Designed for use with recreational and utility trailers

**i** See page F-3 for complete information

## T-CONNECTORS



With more than 460 products covering 8,700 vehicle applications, REESE Towpower is pleased to offer the widest coverage of T-Connectors in the industry. Benefits of our REESE Towpower T-Connectors include: "Factory" appearance, quick and easy installation, solid construction and no cutting, splicing or taping of vehicle wires.

- New 2020 vehicle applications

**i** See page C-3 for complete information

## MODULITE® ZCI™ - (ZERO CONTACT INTERFACE)



Our ZCI™ sensors easily snap over wires to detect an electrical current and engage trailer lights - crucial for high-end vehicles with complex wiring in which snipping, cutting, or splicing voids the vehicle's electrical system warranty. Have a leased vehicle? The ZCI™ is easy to remove without leaving any permanent damage. Take to your next vehicle with the same easy installation.

- Snap, Don't Snip™ – No cutting or splicing vehicle wiring!

**i** See page C-6 for complete information

LIVE. WORK. PLAY.

# NEW PRODUCTS | 2021

## REESE TOWPOWER PRODIGY® ID



Take complete control with the Prodigy® ID, the latest in brake control technology. The in-dash rotary knob seamlessly integrates into your vehicle and features a digital diagnostic readout so you can adjust settings at your fingertips. The Tekonsha® EDGE™ mobile app provides even more customization, letting you store settings for multiple trailers and drivers switch between proportional or timed braking, receive real-time diagnostics and alerts and more!

- Suitable for any trailer with up to 4 braking axles

 See page D-2 for complete information

## PRODIGY® RF



The perfect shared-trailer solution. Utilize for rental businesses, fleet ownerships or multiple tow vehicles. Wireless communication between the remote handheld unit and trailer mounted power module eliminates the need to under dash wiring. No leveling required. Suitable for use on any trailer with up to 3 braking axles.

- Now with Bluetooth wireless communication

 See page D-2 for complete information

## SOLID SHANK TRI-BALL MOUNT



REESE Towpower Tri-Ball ball mount provides the greatest convenience and versatility for ease of use to customers who have various towing requirements. Simply adjust the ball mount and rotate to the desired hitch ball. Engineered and tested to exceed towing standards.

- Perfect for multiple trailer owners

 See page B-9 for complete information

## HITCH BALLS



For over 65 years REESE Towpower has been the number one manufacturer of towing products. This position has been achieved and sustained through market innovation and a commitment to the highest quality standards.

All REESE Towpower hitch balls are solid steel and engineered to meet all safety requirements. Rest assured your peace of mind is our business.

No other towing company in the industry can compare.

- New 25,000 lbs. capacity

 See page B-3 for complete information



# RECEIVER HITCHES

Whether you need to transport trailers heavy with livestock or haul supplies to a job site, the last thing you need to worry about is whether your receiver hitch is up to the task. REESE® Towpower manufactures many classes of receiver hitches to meet your every towing need. With solid all-welded construction, our hitches are tested tough to meet and exceed the highest standards for maximum strength and safety. And our receiver hitches feature exclusive paint finishes that fight rust and corrosion, so they not only look sleek; they're made to last. That's why every hitch comes with a nationwide limited lifetime warranty.

REESE® Towpower custom-fit hitches are built according to manufacturer vehicle weight specifications and model year to ensure a perfect fit and top towing performance. Featuring solid all-welded construction for maximum strength and safety, every hitch meets and exceeds industry standards set by the Society of Automotive Engineers and the Federal Motor Carrier Safety Administration. Whatever the job or your lifestyle, REESE® Towpower makes custom fit trailer hitches to get you where you're going

## RECEIVER HITCHES

Hitch Selection Chart.....	A-2
Class I and II .....	A-4
Class III and IV .....	A-4
Multi-Fit.....	A-5
Class V .....	A-5
Class V Heavy Duty .....	A-5
Step Bumper .....	A-5
ATV Hitch .....	A-6
Front Mounted.....	A-7

## FRONT MOUNTED HITCH ACCESSORIES

License Plate Holder .....	A-6
Spare Tire Carrier.....	A-6
Work Step.....	A-6
Skid Plate.....	A-6
Winch Mounting Plate.....	A-6

## APPLICATION GUIDES

Front Mounted Receiver Hitches.....	A-7 - A-9
All-In-One Hitch and Electrical .....	A-11 - A-81
Electrical Positions.....	A-82



# NEW

## CUSTOM BUILT RECEIVER HITCHES

REESE Towpower® begins with Computer Aided Design (CAD) matched to manufacturer and model year for a perfect fit and top towing performance. REESE Towpower® combines this with solid, all-welded construction for maximum performance and safety under the toughest conditions. The E-Coat base with black powder coat finish keeps your hitch looking good and resists corrosion for many years of service.

- Limited lifetime warranty
- See application guide on page A-11 for additional information
- New applications are engineering and released throughout the year

When choosing a REESE Towpower® trailer hitch consider the following questions to keep in mind:

- How much combined weight (trailer and payload) will I need to carry?
- Is my truck or automobile rated to carry the combined weight I am considering?
- What style(s) will fit my vehicle?
- Which designs are engineered specifically for my vehicle?
- Is appearance a major consideration; what will the installed trailer hitch look like?
- How easy will it be to install on my vehicle?
- Will any vehicle modifications be necessary?



Make/Model	Year	Receiver Type	Receiver Size	Part Number	No Drill	Footnotes	Weight Carrying (lbs.)	Weight Distribution (lbs.)	Install Time
<b>CHEVROLET</b>									
Silverado 1500, All styles	19-20	Square 3	2	84326	Ø	CP	900/6,000	1,000/10,000	60 min
<b>FORD</b>									
Escape, except Hybrid	2020	Square 2	1-1/4	06195	Ø	HM, JR	350/3,500		30 min
<b>GMC</b>									
Sierra 1500, All styles	19-20	Square 3	2	84326	Ø	CP	900/6,000	1,000/10,000	60 min
<b>HYUNDAI</b>									
Sonata, All styles	2020	Square 1	1-1/4	77993	Ø	HM, JR	200/2,000		30 min
Palisade, All styles	2020	Square 3	2	84420	Ø	JR, X	500/5,000	750/6,000	30 min
<b>KIA</b>									
Telluride, All styles	2020	Square 3	2	84420	Ø	JR, X	500/5,000	750/6,000	30 min
<b>LEXUS</b>									
RX350L	18-20	Square 3	2	84336		†, HM, SV	500/5,000		30 min
<b>MAZDA</b>									
CX-30, All styles	2020	Square 1	1-1/4	77995		GP, JR, KH	200/2,000		45 min
<b>RAM</b>									
1500, All styles	19-20	Square 3	2	84328		CP	600/6,000		15 min
<b>SUBARU</b>									
Outback, Wagon	2020	Square 3	2	84333	Ø	HM, JR, KH	525/3,500		40 min
Legacy, Sedan	2020	Round 3	2	84332	Ø	HM, JR, KH	675/4,500		40 min
Outback, Wagon	2020	Round 3	2	84332	Ø	HM, JR, KH	675/4,500		40 min
<b>TOYOTA</b>									
Highlander, All styles	14-20	Square 3	2	84336		†, EP, JR, X	500/5,000		45 min
<b>VOLKSWAGEN</b>									
Passat	2020	Square 1	1-1/4	77994		DU, EP, GP	200/2,000		40 min

## CUSTOM FIT RECEIVER HITCHES

### CUSTOM BUILT RECEIVER HITCHES



- Top quality in every hitch and receiver we make
- Solid all-welded construction for maximum strength and safety
- Custom built according to manufacturer vehicle weight specifications and model year to ensure perfect fit and top towing performance
- All REESE Towpower® hitches meet and exceed V-5 and SAE J684 standards and are inspected for quality and workmanship
- Computer-aided design and fatigue stress testing ensure a strong design that will withstand road abuse within specified capacities
- Finish is black powder coat over E-coat (industry leading corrosion resistance)
- Backed by a nationwide Lifetime Limited Warranty

### SELECTING THE RIGHT HITCH

- Determine the Gross Trailer Weight and Gross Tongue Weight of the trailer that you would like to tow. Check with the trailer manufacturer or if you are not sure, have it towed to a government inspection scale. Remember that the GTW should reflect a fully loaded trailer
- Consult your vehicle's owner's manual to determine if your vehicle is rated to safely tow your trailer
- Use the chart below to figure out the minimum Class of hitch that is required
- Consult a REESE Towpower® dealer to find out which hitches are available for your vehicle

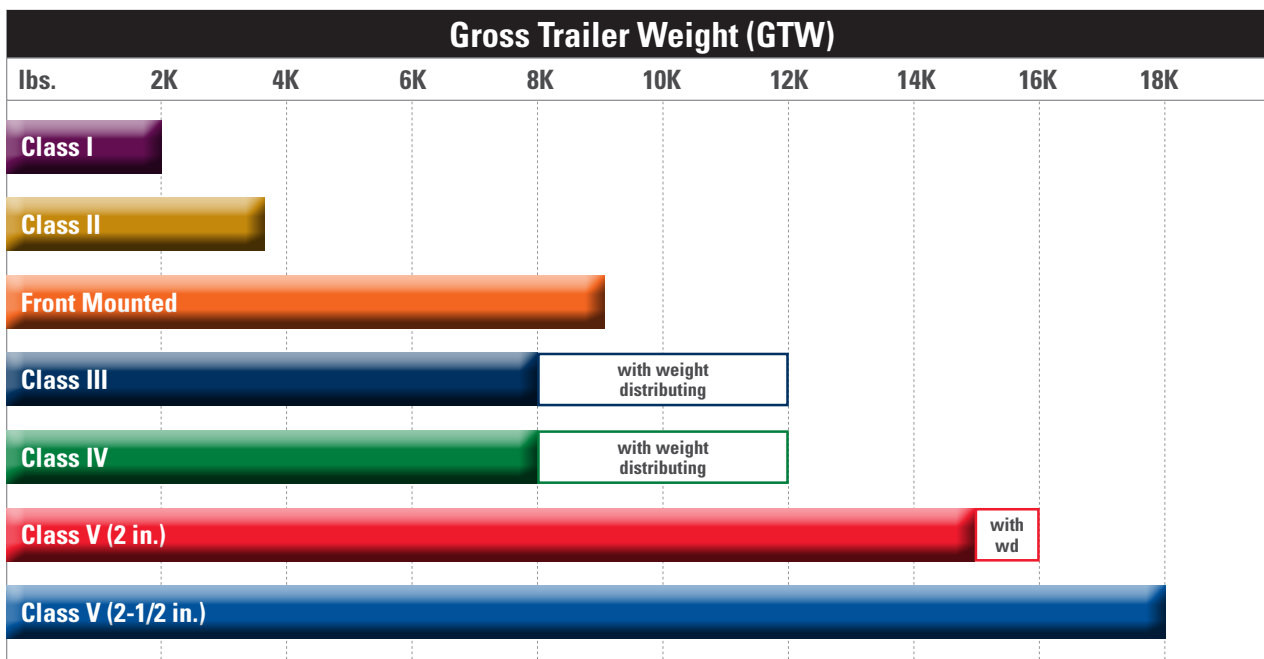

### QUICK DEFINITIONS

- GTW = Gross Trailer Weight ... Weight of the trailer fully loaded
- TW = Tongue Weight ... Weight exerted by the trailer coupler on the hitch ball
- WC = Weight Carrying ... Tow rating capacity of a hitch without a weight distributing system
- WD = Weight Distributing ... Tow rating capacity of a hitch when using a weight distributing system

77 Series  
1-1/4 in. Square Receiver Tube Opening



**CLASS I INSTA-HITCH™**

- 1-1/4 in. square receiver tube opening
- Economical Class I receiver tube hitch
- Attaches to vehicle frame and/or bumper
- Resists rust and corrosion
- 2,000 lbs. max gross trailer weight, 200 lbs. max tongue weight



Part Number	Description	Gross Trailer Weight (lbs.)	Tongue Weight (lbs.)	Packaging	Master Carton
77 Series	Weight Carrying	Up to 2,000	Up to 200	Boxed	1
51 Series	Weight Carrying	Up to 2,000	Up to 200	Boxed	1
97 Series	Weight Carrying	Up to 2,000	Up to 200	Boxed	1

51 Series and 97 Series  
1-1/4 in. Square Receiver Tube Opening



**CLASS II INSTA-HITCH™**

- 1-1/4 in. square receiver tube opening
- Economical Class II receiver tube hitch
- Attaches to vehicle frame and/or bumper
- Resists rust and corrosion
- 3,000 lbs. max gross trailer weight, 350 lbs. max tongue weight



Part Number	Description	Gross Trailer Weight (lbs.)	Tongue Weight (lbs.)	Packaging	Master Carton
06 Series	Weight Carrying	Up to 3,500	Up to 350	Boxed	1
51 Series	Weight Carrying	Up to 3,500	Up to 350	Boxed	1
97 Series	Weight Carrying	Up to 3,500	Up to 350	Boxed	1

06 Series  
1-1/4 in. Square Receiver Tube Opening



**CLASS III/IV HITCHES**

- 2 in. square receiver tube opening
- Round tubes available on some models
- Ball mount, pin and clip sold separately
- Attaches to vehicle frame and/or bumper
- Most include distinctive collar and plug



33 Series  
2 in. Square Receiver Tube Opening



Part Number	Description	Gross Trailer Weight (lbs.)	Tongue Weight (lbs.)	Packaging	Master Carton
33 Series	Weight Carrying	Up to 8,000	Up to 800	Boxed	1
33 Series	Weight Distributing	Up to 12,000	Up to 1,200	Boxed	1
35 Series	Weight Carrying	Up to 5,000	Up to 500	Boxed	1
35 Series	Weight Distributing	Up to 10,000	Up to 1,000	Boxed	1
36 Series	Weight Carrying	Up to 5,000	Up to 500	Boxed	1
36 Series	Weight Distributing	Up to 10,000	Up to 1,000	Boxed	1
37 Series	Weight Carrying	Up to 7,500	Up to 750	Boxed	1
37 Series	Weight Distributing	Up to 12,000	Up to 1,200	Boxed	1
44 Series	Weight Carrying	Up to 8,000	Up to 800	Boxed	1
44 Series	Weight Distributing	Up to 12,000	Up to 1,200	Boxed	1
84 Series	Weight Carrying	Up to 8,000	Up to 800	Boxed	1
84 Series	Weight Distributing	Up to 12,000	Up to 1,200	Boxed	1
51 Series	Weight Carrying	Up to 6,000	Up to 600	Boxed	1
51 Series	Weight Distributing	Up to 10,500	Up to 1,050	Boxed	1
97 Series	Weight Carrying	Up to 6,000	Up to 600	Boxed	1
97 Series	Weight Distributing	Up to 10,500	Up to 1,050	Boxed	1

44 Series  
2 in. Square Receiver Tube Opening



NOTE: See application guide on page I-15 for vehicle specific applications



## MULTI-FIT AND CLASS V RECEIVER HITCHES

Multi-Fit  
2 in. Round Receiver Tube Opening



96 Series  
2 in. Square Receiver Tube Opening



45 Series  
2-1/2 in. Square Receiver Tube Opening



457 Series  
2-1/2 in. Square Receiver Tube Opening



81378  
2 in. Square Receiver Tube Opening



NOTE: See application guide on page A-11 for vehicle specific applications

### CLASS III/IV MULTI-FIT HITCHES

- 2 in. square receiver tube opening
- Passenger car, SUV, van and light truck applications
- Metal Shield® resists rust and corrosion



Part Number	Description	Gross Trailer Weight (lbs.)	Tongue Weight (lbs.)	Packaging	Master Carton
37041	Weight Carrying	Up to 5,000	Up to 500	Boxed	1
37042	Weight Carrying	Up to 5,000	Up to 500	Boxed	1
37096	Weight Carrying	Up to 5,000	Up to 500	Boxed	1
37094	Weight Carrying	Up to 7,000	Up to 700	Boxed	1

### CLASS V HITCH

- 2 in. square receiver tube opening
- Designed for full-sized long wheelbase trucks, vans and utility vehicles with full frames and heavy-duty suspensions
- Ideal for high tongue-weight applications
- Strong, secure heavy-duty side bracket design
- All frame attachments, J-pin® ready
- Black powder coat finish over E-coat



Part Number	Description	Gross Trailer Weight (lbs.)	Tongue Weight (lbs.)	Packaging	Master Carton
96 Series	Weight Carrying	Up to 15,000	Up to 1,500	Boxed	1
96 Series	Weight Distributing	Up to 16,000	Up to 1,600	Boxed	1

### CLASS V HEAVY DUTY HITCHES

- 2-1/2 in. square receiver tube opening
- Designed for full-sized long wheelbase trucks, vans and utility vehicles with full frames and heavy-duty suspensions
- Ideal for high tongue-weight applications
- Strong, secure heavy-duty side bracket design
- All frame attachments, J-pin® ready
- Black powder coat finish over E-coat



Part Number	Description	Gross Trailer Weight (lbs.)	Tongue Weight (lbs.)	Packaging	Master Carton
45 Series	Weight Carrying	Up to 18,000	Up to 2,000	Boxed	1
45 Series	Weight Distributing	Up to 18,000	Up to 2,500	Boxed	1
457 Series	Weight Carrying	Up to 18,000	Up to 2,000	Boxed	1
457 Series	Weight Distributing	Up to 18,000	Up to 2,500	Boxed	1

### STEP BUMPER HITCH

- 2 in. square receiver tube opening
- Do not exceed maximum GTW of bumper or hitch
- Not to be used with weight distributing systems
- May require modification or additional spacers for installation on late model pickups
- Hardware included



Part Number	Description	Gross Trailer Weight (lbs.)	Tongue Weight (lbs.)	Packaging	Master Carton
81378	Step Bumper	Up to 3,500	Up to 350	Boxed	1

7065000  
ATV Receiver Hitch



### 3-WAY ATV HITCH

- Fits most ATVs
- Use a hitch ball, 5/8 in. clevis pin or tow hook
- 3/4 in. diameter ball shank hole
- Mounting hardware included
- Hitch ball sold separately



Part Number	Description	Gross Trailer Weight (lbs.)	Tongue Weight (lbs.)	Packaging	Master Carton
7065000	3-Way ATV Hitch	Up to 2,000	Up to 200	Litho Box	1
7065100	3-Way ATV Hitch	Up to 3,500	Up to 350	Litho Box	1

5443



### LICENSE PLATE HOLDERS

- Some states and provinces require a front license plate
- Offers a simple solution where the front hitch interferes with the plate

Part Number	Description	Packaging	Master Carton
5443	License Plate Adapter	Boxed	1
49802	Fold Down License Plate Holder	Boxed	1

49802

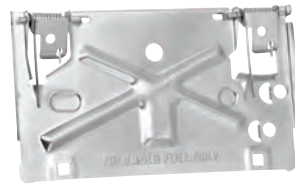

6715



### SPARE TIRE CARRIER

- Ideal for relocating spare tires to the front of the vehicle using a front mounted receiver
- Universal bolt pattern for mounting a variety of tire sizes

Part Number	Description	Packaging	Master Carton
6715	Spare Tire Carrier, Universal Bolt Pattern	Boxed	1

6758

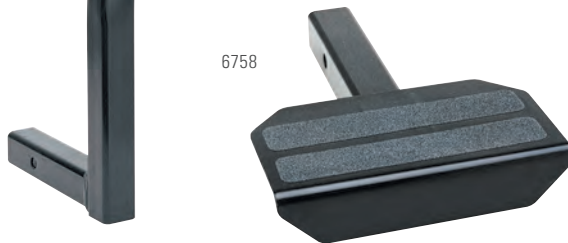

### WORK STEP

- Useful for gaining access to engine compartment, particularly with 4 x 4 pick-ups
- Can also be used on rear Class III/IV hitches

Part Number	Description	Packaging	Master Carton
6758	Work Step	Boxed	1

6771



### RECEIVER TUBE SKID PLATE

- Recommended for use with hitches that are mounted below the bumper

Part Number	Description	Packaging	Master Carton
6771	Receiver Tube Skid Plate	Boxed	1

6495



### WINCH MOUNTING PLATE

- Rated for 9,000 lbs. line pull
- Ideal for use with BULLDOG™ winches
- Accepts most models of Superwinch, Ramsey and Warn
- Will not fit with S4500 Superwinch

Part Number	Description	Packaging	Master Carton
6495	Winch Mounting Plate	Boxed	1

## FRONT MOUNTED RECEIVER HITCHES

65 Series  
2 in. Square Receiver Tube Opening



## FRONT MOUNTED HITCHES

- 2 in. square receiver tube opening
- Front-mounted receivers offer a secure and useful attachment point
- All frame attachments, J-pin® ready
- Ideal for use with winches and snow plows
- Black powder coat finish over E-coat
- 9,000 lbs. max line pull, 500 lbs. max tongue weight



Part Number	Description	Gross Trailer Weight (lbs.)	Tongue Weight (lbs.)	Packaging	Master Carton
65 Series	Weight Carrying	Up to 9,000	Up to 500	Boxed	1

## FRONT MOUNTED RECEIVER HITCH APPLICATION GUIDE

Make/Model	Years	Part No.	Footnotes	Vert Load	Line Pull	In
<b>CHEVROLET</b>						
Avalanche Except Z71	07-13	65052	Ø,GP,X	500	9,000	25
Blazer Full Size	92-94	65005	JU,JV	500	9,000	40
Blazer Downsize	95-05	65004	JW,JX,X	300	9,000	30
Blazer Trailblazer	99-01	65004	JW,JX,X	300	9,000	30
C1500 2 Dr. Regular & Extended Cabs	88-99	65005 65021†	JU,JV,KC JV,KD,KE	500 500	9,000 9,000	40 30
C1500 4 Dr. Crew Cab	92-99	65021†	JV,KD,KE	500	9,000	30
C2500 2 Dr. Regular & Extended Cabs	88-99	65005 65021†	JU,JV,KC JV,KD,KE	500 500	9,000 9,000	40 30
C2500 4 Dr. Crew Cab	92-00	65021†	JV,KD,KE	500	9,000	30
C3500 2 Dr. Regular & Extended Cabs	88-00	65005 65021†	JU,JV,KC JV,KD,KE	500 500	9,000 9,000	40 30
C3500 4 Dr. Crew Cab	92-00	65021†	JV,KD,KE	500	9,000	30
Colorado	15-21	65071	Ø,X	500	9,000	30
Express 1500 Inc. RV Cutaway	96-03	65016	X	500	9,000	35
Express 2500 Inc. RV Cutaway	96-03	65016	X	500	9,000	35
Express 3500 Inc. RV Cutaway	96-03	65016	X	500	9,000	35
K1500 2 Dr. Regular & Extended Cabs	88-99	65005	JU,JV,KC	500	9,000	40
K2500 2 Dr. Regular & Extended Cabs	88-99	65005	JU,JV,KC	500	9,000	40
K2500 4 Dr. Crew Cab	92-00	65005	JU,JV,KC	500	9,000	40
K3500 2 Dr. Regular & Extended Cabs	88-00	65005	JU,JV,KC	500	9,000	40
K3500 4 Dr. Crew Cab	92-00	65005	JU,JV,KC	500	9,000	40
S10	94-04	65004	JW,JX,X	300	9,000	30
Silverado 1500	99-07	65023		500	9,000	20
Silverado 1500	07-13	65052	Ø,GP,X	500	9,000	25
Silverado 1500 LD (Old Body Style)	14-19	65064	Ø,GP,X,FE	500	9,000	25
Silverado 1500	19-21	65082	Ø,GP,X	500	9,000	25
Silverado 1500 HD	01-03	65028	HB	500	9,000	20
Silverado 1500 HD	05-07	65028	HB	500	9,000	20
Silverado 2500	99-04	65028	HB	500	9,000	20
Silverado 2500 HD	01-07	65028	HB	500	9,000	20
Silverado 2500 HD	07-10	65050	Ø,EP,GP,RZ	500	9,000	40
Silverado 2500 HD	11-14	65078	Ø,GP,EP	500	9,000	45
Silverado 2500 HD	15-19	65078	Ø,GP,EP	500	9,000	35
Silverado 2500 HD	20-21	65083	Ø,X	500	9,000	30
Silverado 3500	01-07	65028	HB	500	9,000	20

Make/Model	Years	Part No.	Footnotes	Vert Load	Line Pull	In
<b>CHEVROLET (continued)</b>						
Silverado 3500 HD	07-10	65050	Ø,EP,GP,RZ	500	9,000	40
Silverado 3500 HD	11-14	65078	Ø,GP,EP	500	9,000	45
Silverado 3500 HD	15-19	65078	Ø,GP,EP	500	9,000	35
Silverado 3500 HD	20	65083	Ø,X	500	9,000	30
Suburban	15-20	65064	Ø,GP,X	500	9,000	25
Suburban 1500	00-06	65023		500	9,000	20
Suburban 1500 Except Z71	07-14	65052	Ø,GP,X	500	9,000	25
Suburban 2500	00-06	65028	HB	500	9,000	20
Suburban C1500	92-99	65005 65021†	JU,JV,KC JV,KD	500 500	9,000 9,000	40 30
Suburban C2500	92-99	65005 65021†	JU,JV,KC JV,KD	500 500	9,000 9,000	40 30
Suburban K1500	92-99	65005 65021†	JU,JV,KC JV,KD	500 500	9,000 9,000	40 30
Suburban K2500	92-99	65005 65021†	JU,JV,KC JV,KD	500 500	9,000 9,000	40 30
Tahoe	95-00	65005	JU,JV	500	9,000	40
Tahoe 1500 Series	00-06	65023		500	9,000	20
Tahoe Except Z71	07-14	65052	Ø,GP,X	500	9,000	25
Tahoe	15-20	65064	Ø,GP,X	500	9,000	25
<b>DODGE</b>						
Ram 1500	94-01	65003	Ø,JV	500	9,000	30
Ram 1500	02-05	65033	Ø,GP	500	9,000	25
Ram 1500	09-10	65062	EP,GP	500	9,000	35
Ram 2500	94-02	65003	Ø,JV	500	9,000	30
Ram 2500	03-09	65046		500	9,000	40
Ram 2500 4 WD	10	65057†	Ø,EP,GP,JW	500	9,000	40
Ram 2500 w/Factory Tow Hooks	10	65063	Ø,GPTY	500	9,000	30
Ram 3500	94-02	65003	Ø,JV	500	9,000	30
Ram 3500	03-09	65046		500	9,000	40
Ram 3500	10	65060	EP,GP	500	9,000	30
Ram 3500 w/Factory Tow Hooks	10	65063	Ø,GPTY	500	9,000	30
Ram 4500 Cab & Chassis, w/Factory Tow Hooks	10	65063	Ø,GPTY	500	9,000	30
Ram 5500 Cab & Chassis, w/Factory Tow Hooks	10	65063	Ø,GPTY	500	9,000	30
<b>FORD</b>						
E-150 Econoline	91-07	65001		500	9,000	20
E-150 Econoline	08-14	65053	EP,GP,JV	500	9,000	40
E-250 Econoline	91-07	65001		500	9,000	20



# FRONT MOUNTED RECEIVER HITCH APPLICATION GUIDE

Make/Model	Years	Part No.	Footnotes	Vert Load	Line Pull	In
<b>FORD (continued)</b>						
E-250 Econoline	08-14	65053	EP,GP,JV	500	9,000	40
E-350 Econoline Inc. RV Cutaway	91-07	65001		500	9,000	20
E-350 Econoline Super Duty	08-14	65053	AI,EP,GP,JV	500	9,000	50
E-350 Econoline Super Duty RV Cutaway	08-17	65053	AI,EP,GP,JV	500	9,000	50
E-450 Econoline Super Duty RV Cutaway	03-07	65001		500	9,000	20
E-450 Econoline Super Duty RV Cutaway	08-17	65053	AI,EP,GP,JV	500	9,000	50
E-450 Econoline Super Duty Stripped RV Cutaway	00-02	65001		500	9,000	20
Excursion	00-05	65022	AA,KI	500	9,000	40
Expedition	97-02	65025	Ø	500	9,000	20
Explorer	91-94	65017	Ø	300	9,000	35
Explorer 2 Dr. Sport	01-03	65030†	Ø	300	9,000	25
Explorer Sport Trac	01-05	65030†	Ø	300	9,000	25
F-150	97-03	65025	Ø	500	9,000	20
F-150	04-08	65043	Ø	500	9,000	20
F-150	09-14	65061	Ø,GP,JV,HB	500	9,000	30
F-150	15-20	65067	Ø,GP,JV	500	9,000	30
F-150 Heritage	04	65025	Ø	500	9,000	20
F-250	92-97	65015	Ø,JW	500	9,000	25
F-250 Styleside	92-97	65014	Ø,JT,KB	500	9,000	25
F-250 Styleside	97-98	65025	Ø,JW	500	9,000	20
F-250 Styleside	99	65025	Ø	500	9,000	20
F-250 Super Duty	99-07	65022	AA,KI	500	9,000	40
F-250 Super Duty	08-16	65049	Ø,GP,X	500	9,000	20
F-250 Super Duty	17-21	65076	Ø,JV	500	9,000	30
F-350	92-97	65015	Ø,JW	500	9,000	25
F-350 Styleside	92-97	65014	Ø,JT,KB	500	9,000	25
F-350 Super Duty	99-07	65022	AA,KI	500	9,000	40
F-350 Super Duty Cab & Chassis, w/34" Wide Frames	99-07	65022	AA,KI	500	9,000	40
F-350 Super Duty	08-16	65049	Ø,GP,X	500	9,000	20
F-350 Super Duty Cab & Chassis	08-20	65049	Ø,GP,X	500	9,000	20
F-350 Super Duty	17-21	65076	Ø,JV	500	9,000	30
F-450 Super Duty Cab & Chassis, w/34" Wide Frames	99-07	65022	AA,KI	500	9,000	40
F-450 Super Duty	08-16	65049	Ø,GP,X	500	9,000	20
F-450 Super Duty Cab & Chassis	08-20	65049	Ø,GP,X	500	9,000	20
F-450 Super Duty	17-21	65076	Ø,JV	500	9,000	30
F-550 Super Duty Cab & Chassis, w/34" Wide Frames	99-07	65022	AA,KI	500	9,000	40
F-550 Super Duty Cab & Chassis	08-20	65049	Ø,GP,X	500	9,000	20
Ranger	89-97	65017	Ø,JY	300	9,000	35
Ranger	01-05	65024		500	9,000	35
<b>GMC</b>						
C1500 2 Dr. Regular & Extended Cabs	88-99	65005 65021†	JU,JV,KC JV,KD,KE	500	9,000	40
C1500 4 Dr. Crew Cab	92-99	65021†	JV,KD,KE	500	9,000	30
C2500 2 Dr. Regular & Extended Cabs	88-00	65005 65021†	JU,JV,KC JV,KD,KE	500	9,000	40

Make/Model	Years	Part No.	Footnotes	Vert Load	Line Pull	In
<b>GMC (continued)</b>						
C2500 4 Dr. Crew Cab	92-00	65021†	JV,KD,KE	500	9,000	30
C3500 2 Dr. Regular & Extended Cabs	88-00	65005 65021†	JU,JV,KC JV,KD,KE	500	9,000	40
C3500 4 Dr. Crew Cab	92-00	65021†	JV,KD,KE	500	9,000	30
Canyon	15-20	65071	Ø,X	500	9,000	30
Jimmy Downsize	95-05	65004	JW,JX,X	300	9,000	30
K1500 2 Dr. Regular & Extended Cabs	88-99	65005	JU,JV,KC	500	9,000	40
K1500 4 Dr. Crew Cab	92-99	65005	JU,JV,KC	500	9,000	40
K2500 4 Dr. Crew Cab	92-00	65005	JU,JV,KC	500	9,000	40
K3500 4 Dr. Crew Cab	92-00	65005	JU,JV,KC	500	9,000	40
Savana 1500 Inc. RV Cutaway	96-03	65016	X	500	9,000	35
Savana 2500 Inc. RV Cutaway	96-03	65016	X	500	9,000	35
Savana 3500 Inc. RV Cutaway	96-03	65016	X	500	9,000	35
Sierra 1500 Except Denali (Classic)	99-07	65023		500	9,000	20
Sierra 1500	07-13	65052	Ø,GP,X	500	9,000	25
Sierra 1500 LD (Old Body Style)	14-19	65064	Ø,GP,X	500	9,000	25
Sierra 1500 HD	01-07	65028	HB	500	9,000	20
Sierra 2500	99-04	65028	HB	500	9,000	20
Sierra 2500 HD	01-07	65028	HB	500	9,000	20
Sierra 2500 HD	07-10	65050	Ø,EP,GP,RZ	500	9,000	40
Sierra 2500 HD Except Denali	11-14	65078	Ø,GP,EP	500	9,000	45
Sierra 2500 HD Except Denali	15-19	65078	Ø,GP,EP	500	9,000	35
Sierra 2500 HD	20-21	65083	Ø,X	500	9,000	30
Sierra 3500	01-07	65028	HB	500	9,000	20
Sierra 3500 HD	07-10	65050	Ø,EP,GP,RZ	500	9,000	40
Sierra 3500 HD Except Denali	11-14	65078	Ø,GP,EP	500	9,000	45
Sierra 3500 HD Except Denali	15-19	65078	Ø,GP,EP	500	9,000	35
Sierra 3500 HD	20-21	65083	Ø,X	500	9,000	30
Sonoma	94-04	65004	JW,JX,X	300	9,000	30
Suburban C1500	92-99	65005 65021†	JU,JV,KC JV,KD	500	9,000	40
Suburban C2500	92-99	65005 65021†	JU,JV,KC JV,KD	500	9,000	40
Suburban K1500	92-99	65005 65021†	JU,JV,KC JV,KD	500	9,000	40
Suburban K2500	92-99	65005 65021†	JU,JV,KC JV,KD	500	9,000	40
Yukon	92-00	65005	JU,JV	500	9,000	40
Yukon 1500	00-06	65023		500	9,000	20
Yukon	07-14	65052	Ø,GP,X	500	9,000	25
Yukon	15-20	65064	Ø,GP,X	500	9,000	25
Yukon Denali 1500	01-06	65023		500	9,000	30
Yukon XL	15-20	65064	Ø,GP,X	500	9,000	25
Yukon XL 1500	00-06	65023		500	9,000	20
Yukon XL 1500	07-14	65052	Ø,GP,X	500	9,000	25
Yukon XL 1500 Denali	01-06	65023		500	9,000	30
Yukon XL 2500	00-06	65028	HB	500	9,000	20
<b>HONDA</b>						
Ridgeline	17-20	65073	HM,X,SV	500	9,000	35

## FRONT MOUNTED RECEIVER HITCH APPLICATION GUIDE

Make/Model	Years	Part No.	Footnotes	Vert Load	Line Pull	In
<b>ISUZU</b>						
Hombre	96-00	65004	JW,JX,X	300	9,000	30
<b>JEEP</b>						
Cherokee Downsize	84-01	65009	JV	300	9,000	30
Comanche	86-92	65009	JV	300	9,000	30
Gladiator Except Mojave Edition	20-21	65079	Ø,DU,FE,G-P,SV,	500	9,000	35
Grand Cherokee	93-98	65008	JV	300	9,000	25
Grand Wagoneer	93	65008	Ø,JV	300	9,000	25
TJ (Canada Only)	97-06	65048	Ø,X	300	9,000	25
Wagoneer	84-90	65009	JV	300	9,000	30
Wrangler	87-95	65048	Ø,X	300	9,000	25
Wrangler	97-06	65048	Ø,X	300	9,000	25
Wrangler	07-17	65069	Ø,EP,GP	500	9,000	40
Wrangler JL (New Body Style)	18-21	65079	Ø,DU,FE,G-P,SV,	500	9,000	35
Wrangler JK	18	65069	Ø,EP,GP	500	9,000	40
YJ (Canada Only)	87-95	65048	Ø,X	300	9,000	25
<b>LINCOLN</b>						
Mark LT	06-08	65043	Ø	500	9,000	20
Mark LT (Mexico Only)	10-13	65061	Ø,GP,JV	500	9,000	30
Navigator	98-02	65025	Ø	500	9,000	20
<b>MAZDA</b>						
B2300	94-97	65017	Ø,JY	300	9,000	35
B2300	02-05	65024		500	9,000	35
B2500	01	65024		500	9,000	35
B3000	94-97	65017	Ø,JY	300	9,000	35
B3000	01-05	65024		500	9,000	35
B4000	94-97	65017	Ø,JY	300	9,000	35
B4000	01-05	65024		500	9,000	35
Navajo	91-94	65017	Ø,JY	300	9,000	35
<b>NISSAN</b>						
Frontier	05-20	65075	Ø	500	9,000	35
Pathfinder	05-12	65075	Ø	500	9,000	35
Titan 4 WD Only	09-15	65065	RB,HM,KG, JW,AL	500	9,000	45
Titan Except Titan XD & 4 WD Models	17-20	65077†	Ø,SV,GP,X	500	9,000	60
Titan XD	16-21	65072	Ø,EP	500	9,000	25
<b>OLDSMOBILE</b>						
Bravada	96-01	65004	JW,JX,X	300	9,000	30
<b>RAM</b>						
1500	11-18	65062	EP,GP	500	9,000	35
1500 (Classic)	19	65062	EP,GP	500	9,000	35
1500 (New Body Style), Except with Factory Tow Hooks	19-21	65081	Ø,JV,GP	500	9,000	50
2500 4 WD	11-12	65057†	EP,GP,JW	500	9,000	40
2500 w/Factory Tow Hooks	11-18	65063	Ø,GP,TY	500	9,000	30
2500	19-21	65084		500	9,000	
3500	11-12	65060	EP,GP	500	9,000	30
3500 w/Factory Tow Hooks	11-18	65063	Ø,GP,TY	500	9,000	30
3500	19-21	65084		500	9,000	
4500 Cab & Chassis, w/ Factory Tow Hooks	11-18	65063	Ø,GP,TY	500	9,000	30
4500	19-21	65084		500	9,000	

Make/Model	Years	Part No.	Footnotes	Vert Load	Line Pull	In
<b>RAM (continued)</b>						
5500 Cab & Chassis, w/ Factory Tow Hooks	11-18	65063	Ø,GP,TY	500	9,000	30
5500	19-21	65084		500	9,000	
<b>SUZUKI</b>						
Equator Sport & RMZ-4 Models	09-12	65075	Ø	500	9,000	35
<b>TOYOTA</b>						
4Runner Except Limited	14-20	65074	Ø,HM	500	9,000	20
Sequoia	01-07	65031		500	9,000	40
Sequoia	07-20	65080	Ø,HM,KG	500	9,000	20
Tacoma	01-04	65041		500	9,000	30
Tacoma	05-21	65070	Ø,HM,KG	500	9,000	35
Tundra	00-06	65031		500	9,000	40
Tundra	07-21	65080	Ø,HM,KG	500	9,000	20

**FOOTNOTES:**

† - Available while supplies last.

AA - Requires temporary removal of bumper during installation.

AI - Additional installation time may be required.

A - Additional installation time required for vehicles equipped with load leveling compressor.

DU - Fascia removal required.

EP - Fascia trimming may be required.

FE - Fascia trimming may be required. Allow additional installation time.

GP - Hitch crosstube concealed behind bumper.

HB - Slight fascia deformation may occur on some models.

HM - Hitch crosstube is visible beneath bumper.

JT - 2WD models only.

JU - License plate relocation required to install hitch see 5443. (Sold separately)

JV - Rubber air deflector/fascia must be removed or trimmed to install hitch

JW - 4WD models only.

JX - Requires factory tow hooks for installation on 2WD models.

JY - Extensive fascia cutting required on models w/fog lamp option.

KB - Diesel engine models only.

KC - Does not fit 2500/3500 2WD (C-Series) models w/8 lug wheels.

KD - Fits 2500/3500 2WD (C-Series) models w/8 lug wheels only.

KE - Does not fit 1988-91 4 Dr. Crew Cab models.

KG - Skid shield must be removed or modified if present.

KI - Optional OEM Fog Lights must be removed for receiver installation.

Ø - Uses all existing holes. No drilling required.

RB - Hitch installation can be made easier with a cutter type drill bit.

RZ - License plate holder relocation and/or modification required to install hitch (see #49802 or #5443 Sold separately).

SV - Trimming or removal of under body appearance panel may be required.

TY - Requires factory tow hooks for installation.

X - Minor fascia trimming required.

NOTES

Dotted lines for notes.

## RECEIVER HITCH AND T-CONNECTOR APPLICATION GUIDE

REESE® Towpower receiver hitch and t-connector application guide enables you to find the right towing system components each and every time. These pages have been developed to simplify the look-up of the proper hitch and t-connector for your customer's vehicle by make, model and year.

### RECEIVER HITCH AND T-CONNECTOR APPLICATION GUIDE

MODEL / STYLE	YEAR	TRAILER HITCHES						T-CONNECTOR			
		REC TYPE	REC SIZE	PART NO.	NO DRILL	FOOTNOTES	WC (LBS.)	WD (LBS.)	IN	T-CON PART NO.	FN
<b>BMW</b>											
320i	12-14	SQ1	1-1/4	77332	0	DU,GP,SV,KH	200/2,000		50		
320i	15	SQ1	1-1/4	77332	0	DU,GP,SV,KH	200/2,000		50		
320i	16	SQ1	1-1/4	77332	0	DU,GP,SV,KH	200/2,000		50	85907	CH,BN
320i	17	SQ1	1-1/4	77332	0	DU,GP,SV,KH	200/2,000		50		
320i xDrive	12-14	SQ1	1-1/4	77332	0	DU,GP,SV,KH	200/2,000		50		
320i xDrive	15	SQ1	1-1/4	77332	0	DU,GP,SV,KH	200/2,000		50		
320i xDrive	16-17	SQ1	1-1/4	77332	0	DU,GP,SV,KH	200/2,000		50	85907	CH,BN
320i xDrive	17	SQ1	1-1/4	77332	0	DU,GP,SV,KH	200/2,000		50		
328d	12-14	SQ1	1-1/4	77332	0	DU,GP,SV,KH	200/2,000		50		
328d	15	SQ1	1-1/4	77332	0	DU,GP,SV,KH	200/2,000		50		
328d	16	SQ1	1-1/4	77332	0	DU,GP,SV,KH	200/2,000		50	85907	CH,BN
328d xDrive Sedan	12-14	SQ1	1-1/4	77332	0	DU,GP,SV,KH	200/2,000		50		
328d xDrive Sports Wagon	12-16	SQ1	1-1/4	77332	0	DU,GP,SV,KH	200/2,000		50		
328d xDrive Sedan	15	SQ1	1-1/4	77332	0	DU,GP,SV,KH	200/2,000		50		
328d xDrive Sedan	16	SQ1	1-1/4	77332	0	DU,GP,SV,KH	200/2,000		50	85907	CH,BN
328i Sedan	07-11	SQ1	1-1/4	77231	0	GP,SV	200/2,000		45		
328i Sedan	12-14	SQ1	1-1/4	77332	0	DU,GP,SV,KH	200/2,000		50		
328i Sedan	15	SQ1	1-1/4	77332	0	DU,GP,SV,KH	200/2,000		50		
328i Sedan	16	SQ1	1-1/4	77332	0	DU,GP,SV,KH	200/2,000		50	85907	CH,BN
328xi Sedan	07-08	SQ1	1-1/4	77231	0	GP,SV	200/2,000		45		
335i xDrive Sedan	12-14	SQ1	1-1/4	77332	0	DU,GP,SV,KH	200/2,000		50		
528i	15-16	SQ1	1-1/4	77324	0	GP,SV,TA,AA	200/2,000		50		
528i xDrive	15-16	SQ1	1-1/4	77324	0	GP,SV,TA,AA	200/2,000		50		
535d	15-16	SQ1	1-1/4	77324	0	GP,SV,TA,AA	200/2,000		50		
535d xDrive	15-16	SQ1	1-1/4	77324	0	GP,SV,TA,AA	200/2,000		50		
535i	15-16	SQ1	1-1/4	77324	0	GP,SV,TA,AA	200/2,000		50		

#### 1). VEHICLE MODEL/STYLE & YEAR RANGE

Applications are separated first by make, and subsequently by model and yearly divisions.

#### 2). HITCH FOOTNOTES

Footnotes reference additional information pertinent to the installation and availability of a particular hitch. Common footnotes such as GP (hitch cross-tube concealed behind bumper) are listed at the bottom of each left hand page.

#### 3). REESE® TOWPOWER HITCH PART NUMBERS

Class I, II, III, IV and V receiver hitches are specific for each individual vehicle. This listing indicates the correct hitch by application.

#### 4). RECEIVER TYPE

Receiver Type codes are referenced in a Receiver Type footnote box at the bottom of each right hand page.

#### 5). NO DRILL

Ø - No drilling requires.

#### 6). RECEIVER SIZE

Receiver sizes range from 1-1/4 in. to 3 in.

#### 7). RECEIVER WEIGHT RATINGS

WC or Weight Carrying, refers to the total load the hitch is capable of pulling, without the use of a weight distributing system. WD or Weight Distributing, is the total load capacity of the hitch when a weight distribution system is properly utilized.

#### 8). INSTALLATION TIME

Average installation times (IN) are listed in minutes and are published for all hitches and T-One® wiring connectors. Times are based on common mechanical practices and should be used as an estimate as actual installation times may vary in each individual situation.

#### 9). T-CONNECTOR PART NUMBERS

T-Connector part numbers are for vehicle specific applications.

#### 10). ELECTRICAL FOOTNOTES

Footnotes reference additional information pertinent to the installation and availability of a particular electrical harness. Footnotes are listed at the bottom of each right hand page.



# RECEIVER HITCH AND T-CONNECTOR APPLICATION GUIDE

RECEIVER HITCHES

MODEL / STYLE	YEAR	TRAILER HITCHES								T-CONNECTOR	
		REC TYPE	REC SIZE	PART NO.	NO DRILL	FOOTNOTES	WC (LBS.)	WD (LBS.)	IN	T-CON PART NO.	FN
<b>ACURA</b>											
CL 3.2	01-03	SQ1	1-1/4	77165	0	JR, HM	200/2,000		15	74660	HG
CSX (Canada Only)	06-11	SQ1	1-1/4	77247	0	HM, JR, KH, SV	200/2,000		30		
EL (Canada Only)	97-01	SQ1	1-1/4	77025	0	HM	200/2,000		15		
ILX Except Hybrid	13-20	SQ1	1-1/4	77247	0	HM, JR, KH, SV	200/2,000		35	85842	CH
Integra	94-01	SQ1	1-1/4	77063	0	HM	200/2,000		40	74660	HG
MDX Except w/Full Size Spare Tire	01-06	SQ3	2	44589	0	GP, JR	350/3,500	500/5,000	30	74660	HG
		SQ3	2	51159	0	GP, JR	350/3,500	500/5,000	30		
MDX Except w/Full Size Spare Tire or w/Rear Sport Bumper Option	07-12	RT3	2	44594	0	CR, JR	400/4,000	500/5,000	35	74701	CH
MDX Except w/Full Size Spare Tire or w/Rear Sport Bumper Option	13	RT3	2	44594	0	CR, JR	400/4,000	500/5,000	35	74701	CH
MDX Except w/Full Size Spare Tire	14-20	SQ4	2	44778	0	TA, GP	900/6,000	900/8,000	20	85860	BN, CH
RDX	07-09	SQ2	1-1/4	06465†	0	GP	300/3,500		15	85721	CH
		SQ3	2	44584	0	GP	400/4,000		30		
RDX	10-12	SQ3	2	44695	0	GP	400/4,000		30	85721	CH
RDX	13-18	SQ3	2	44695	0	GP	400/4,000		30	85804	CH
RDX With +12V Power Provision	19-20	SQ2	1-1/4	06193	0	J, JR	300/3,500		30	89516	CH
		RT3	2	84268	0	JR, J	350/3,500		25		
RDX Without +12V Power Provision	19-20	SQ2	1-1/4	06193	0	JR, J	300/3,500		25	118804	CH
		RT3	2	84268	0	JR, J	350/3,500		25		
RDX With +12V Power Provision	21	SQ2	1-1/4	06193	0	J, JR	300/3,500		30		
		RT3	2	84268	0	JR, J	350/3,500		25		
RDX Without +12V Power Provision	21	SQ2	1-1/4	06193	0	JR, J	300/3,500		25		
		RT3	2	84268	0	JR, J	350/3,500		25		
RL 3.5	96-01	SQ2	1-1/4	06996†		†, GP	300/3,500		30	74660	HG
RL 3.5	02-04	SQ2	1-1/4	06996†		†, GP	300/3,500		30		
RLX	14-17	SQ2	1-1/4	06161†	0	DU, EP, GP, SV, TA	300/3,500		60	85841	CH
RLX	18-20	SQ2	1-1/4	06161†	0	DU, EP, GP, SV, TA	300/3,500		60		
RSX	02-06	SQ1	1-1/4	77033		TA, GP	200/2,000		30		
SLX	96-99	SQ3	2	33043†		†, HM	500/5,000	750/7,500	40	74461	BN, HG
TL 3.2	99-03	SQ1	1-1/4	77165	0	JR, HM	200/2,000		15	74660	HG
TL	04-08	SQ1	1-1/4	77131		TA, GP	200/2,000		35	85704	HG
TL	09-14	SQ1	1-1/4	77287	0	HM, JR, KH, SV	200/2,000		45	85808	CH
TLX	15-19	SQ1	1-1/4	77329	0	HM	200/2,000		45	85955	CH
TSX 4 Dr. Sedan	06-08	SQ1	1-1/4	77144†	0	†, HM, JR	200/2,000		40	78002	HG
TSX 4 Dr. Sedan	09-14	SQ1	1-1/4	77287	0	HM, JR, KH, SV	200/2,000		45	74697	CG
ZDX	10-13	SQ1	1-1/4	77226†	0	†, GP, J	200/2,000		25	85723	CH
<b>ALFA ROMEO</b>											
Stelvio Except Quadrifoglio	18-20	SQ3	2	84199	0	GP, DU, X, TA, TZ, TW	600/4,000		80		
<b>AUDI</b>											
A3 Except Sportback e-tron	15-20	SQ1	1-1/4	77317	0	GP	200/2,000		20		
A4 4 Dr. Sedan	09-20	SQ1	1-1/4	77950	0	X, GP, SV	200/2,000		25		
A6 4 Dr. Sedan	05-11	SQ1	1-1/4	77210	0	HM, JR	200/2,000		25		
A6 Quattro Avant Wagon	06-10	SQ1	1-1/4	77210	0	HM, JR	200/2,000		25		
Q3	13-18	SQ3	2	44769	0	DU, EP, GP	450/4,500		50		
Q5	11-12	SQ3	2	44755	0	DU, EP, GP, TA	750/5,000		60		
Q5	13-17	SQ3	2	44755	0	DU, EP, GP, TA	750/5,000		60		
Q5	18	SQ3	2	84183	0	GP, DU, X, TA, TZ, TW	750/5,000		90		
Q5	19-20	SQ3	2	84183	0	GP, DU, X, TA, TZ, TW	750/5,000		90		
Q7	07-16	SQ4	2	44758	0	AI, GP, X	750/7,500		70		
Q7	17-20	SQ4	2	84076	0	X, DU, GP	770/7,700		60		
SQ5	18-20	SQ3	2	84183	0	GP, DU, X, TA, TZ, TW	750/5,000		90		

† Available while supply lasts.  
 AI Additional installation time may be required.  
 BN Exterior mounted plug on some or all models. May require an aftermarket electrical mounting box or bracket. (Sold separately)  
 CG T-One incorporates circuit protected taillight converter.  
 CH T-One is equipped with circuit protected ModuLite® module.  
 CR Fits with mini spare tire stowed under vehicle. Will not fit with full size spare.  
 DU Fascia removal required.  
 EP Fascia trimming may be required.  
 GP Hitch crosstube concealed behind bumper.  
 HG T-One incorporates taillight converter.  
 HM Hitch crosstube is visible beneath bumper.  
 I Hitch is positioned further rearward to accommodate spare tire.

J Under vehicle spare tire stowage is retained.  
 JR Exhaust must be temporarily lowered for installation.  
 KH Minor heat shield modification may be required.  
 K Uses all existing holes. No drilling required.  
 SV Trimming or removal of under body appearance panel may be required.  
 TA Trunk access required for hitch installation.  
 TW Receiver hitch may limit hands-free liftgate sensor range  
 TZ Requires replacement of the impact structure with hitch.  
 X Minor fascia trimming required.

RT3 Round Tube Class III 2"  
 SQ1 Square Tube Class I  
 SQ2 Square Tube Class II  
 SQ3 Square Tube Class III  
 SQ4 Square Tube Class IV

A - AUDI

# RECEIVER HITCH AND T-CONNECTOR APPLICATION GUIDE

MODEL / STYLE	YEAR	TRAILER HITCHES							T-CONNECTOR		
		REC TYPE	REC SIZE	PART NO.	NO DRILL	FOOTNOTES	WC (LBS.)	WD (LBS.)	IN	T-CON PART NO.	FN
<b>BMW</b>											
320i	12-14	SQ1	1-1/4	77332	0	DU,GP,SV,KH	200/2,000		50		
320i	15	SQ1	1-1/4	77332	0	DU,GP,SV,KH	200/2,000		50		
320i	16	SQ1	1-1/4	77332	0	DU,GP,SV,KH	200/2,000		50	85907	CH,BN
320i	17	SQ1	1-1/4	77332	0	DU,GP,SV,KH	200/2,000		50		
320i xDrive	12-14	SQ1	1-1/4	77332	0	DU,GP,SV,KH	200/2,000		50		
320i xDrive	15	SQ1	1-1/4	77332	0	DU,GP,SV,KH	200/2,000		50		
320i xDrive	16-17	SQ1	1-1/4	77332	0	DU,GP,SV,KH	200/2,000		50	85907	CH,BN
320i xDrive	17	SQ1	1-1/4	77332	0	DU,GP,SV,KH	200/2,000		50		
328d	12-14	SQ1	1-1/4	77332	0	DU,GP,SV,KH	200/2,000		50		
328d	15	SQ1	1-1/4	77332	0	DU,GP,SV,KH	200/2,000		50		
328d	16	SQ1	1-1/4	77332	0	DU,GP,SV,KH	200/2,000		50	85907	CH,BN
328d xDrive Sedan	12-14	SQ1	1-1/4	77332	0	DU,GP,SV,KH	200/2,000		50		
328d xDrive Sports Wagon	12-16	SQ1	1-1/4	77332	0	DU,GP,SV,KH	200/2,000		50		
328d xDrive Sedan	15	SQ1	1-1/4	77332	0	DU,GP,SV,KH	200/2,000		50		
328d xDrive Sedan	16	SQ1	1-1/4	77332	0	DU,GP,SV,KH	200/2,000		50	85907	CH,BN
328i Sedan	07-11	SQ1	1-1/4	77231	0	GP,SV	200/2,000		45		
328i Sedan	12-14	SQ1	1-1/4	77332	0	DU,GP,SV,KH	200/2,000		50		
328i Sedan	15	SQ1	1-1/4	77332	0	DU,GP,SV,KH	200/2,000		50		
328i Sedan	16	SQ1	1-1/4	77332	0	DU,GP,SV,KH	200/2,000		50	85907	CH,BN
328xi Sedan	07-08	SQ1	1-1/4	77231	0	GP,SV	200/2,000		45		
335i xDrive Sedan	12-14	SQ1	1-1/4	77332	0	DU,GP,SV,KH	200/2,000		50		
528i	15-16	SQ1	1-1/4	77324	0	GP,SV,TA,AA	200/2,000		50		
528i xDrive	15-16	SQ1	1-1/4	77324	0	GP,SV,TA,AA	200/2,000		50		
535d	15-16	SQ1	1-1/4	77324	0	GP,SV,TA,AA	200/2,000		50		
535d xDrive	15-16	SQ1	1-1/4	77324	0	GP,SV,TA,AA	200/2,000		50		
535i	15-16	SQ1	1-1/4	77324	0	GP,SV,TA,AA	200/2,000		50		
535i GT	15-17	SQ1	1-1/4	77324	0	GP,SV,TA,AA	200/2,000		50		
535i GT xDrive	15-17	SQ1	1-1/4	77324	0	GP,SV,TA,AA	200/2,000		50		
535i xDrive	15-16	SQ1	1-1/4	77324	0	GP,SV,TA,AA	200/2,000		50		
550i	15-16	SQ1	1-1/4	77324	0	GP,SV,TA,AA	200/2,000		50		
550i GT	15	SQ1	1-1/4	77324	0	GP,SV,TA,AA	200/2,000		50		
550i GT xDrive	15-17	SQ1	1-1/4	77324	0	GP,SV,TA,AA	200/2,000		50		
550i xDrive	15-16	SQ1	1-1/4	77324	0	GP,SV,TA,AA	200/2,000		50		
X1 w/Panoramic Moonroof	13-14	SQ3	2	44684	0	GP,JP	400/3,500	400/4,000	60		
X1 w/Panoramic Moonroof	15	SQ3	2	44684	0	GP,JP	400/3,500	400/4,000	60	85910	BN
X1	16-17	SQ3	2	84018		GP,JP,DU,KH	675/4,500	675/4,500	40	85910	BN
X1	18-19	SQ3	2	84018		GP,JP,DU,KH	675/4,500	675/4,500	40		
X2	18-20	SQ3	2	84200	0	GP,AA,TA	525/3,500		80	89510	BN,CH
X3	04-10	SQ3	2	44531		AA,EP	350/3,500	400/4,000	100		
X3	11-17	SQ3	2	84226	0	DU,AA,GP,SV,TA	750/5,000		75		
X3	18-21	SQ3	2	84226	0	DU,AA,GP,SV,TA	750/5,000		75	118823	CH,BN
X5	00-06	SQ4	2	44178		AA,EP	600/6,000	600/6,000	60		
		SQ4	2	51093		AA,EP	600/6,000	600/6,000	60		
X5 Except M Sport Package	07-18	SQ4	2	44590	0	AA,EP,GP	600/6,000	600/6,000	75		
X5 Except M Sport Package	19-20	SQ3	2	84288	0	GP,JP,AA,EP,DU,TA	720/7,200	720/7,200	90		
<b>BUICK</b>											
Allure (Canada Only)	05-09	SQ2	1-1/4	06384		GP,JP	300/3,500		30		
		SQ2	1-1/4	51183		GP,JP	300/3,500		30		
Cascada	16-19	SQ1	1-1/4	779551	0	HM	200/2,000		15		
Century Sedan	97-05	SQ1	1-1/4	77109		TA,GP	200/2,000		30		
		SQ2	1-1/4	06384		GP,JP	300/3,500		30		
		SQ2	1-1/4	51183		GP,JP	300/3,500		30		

**AA** Requires temporary removal of bumper during installation.  
**BN** Exterior mounted plug on some or all models. May require an aftermarket electrical mounting box or bracket. (Sold separately)  
**CH** T-One is equipped with circuit protected ModuLite® module.  
**DU** Fascia removal required.  
**EP** Fascia trimming may be required.  
**GP** Hitch cross-tube concealed behind bumper.  
**HM** Hitch cross-tube is visible beneath bumper.  
**JP** Exhaust must be temporarily lowered for installation.  
**KH** Minor heat shield modification may be required.  
**0** Uses all existing holes. No drilling required.  
**SV** Trimming or removal of under body appearance panel may be required.  
**TA** Trunk access required for hitch installation.

**SQ1** Square Tube Class I  
**SQ2** Square Tube Class II  
**SQ3** Square Tube Class III  
**SQ4** Square Tube Class IV

# RECEIVER HITCH AND T-CONNECTOR APPLICATION GUIDE

RECEIVER HITCHES

MODEL / STYLE	YEAR	TRAILER HITCHES								T-CONNECTOR	
		REC TYPE	REC SIZE	PART NO.	NO DRILL	FOOTNOTES	WC (LBS.)	WD (LBS.)	IN	T-CON PART NO.	FN
<b>BUICK (Continued)</b>											
Enclave	08-12	RT3	2	51083	0	RT,GP,JR	500/5,000	500/5,000	25	78066	BN
		RT3	2	44569	0	GP,JR,TN	750/5,000	750/7,500	25		
Enclave	13-17	RT3	2	51083	0	RT,GP,JR	500/5,000	500/5,000	25	85836	BN
		RT3	2	44569	0	GP,JR,TN	750/5,000	750/7,500	25		
Enclave	18-20	SQ3	2	84184	0	DU,JR	750/5,000	750/5,000	75	85974	BN,CH
Enclave	21	SQ3	2	84184	0	DU,JR	750/5,000	750/5,000	75	85974	BN,CH
Encore	13-16	RT2	1-1/4	06169	0	HM,JR	300/3,500		40	85820	CH
Encore Except Encore GX	17-21	RT2	1-1/4	06169	0	HM,JR	300/3,500		40	85952	CH
Envision	16-18	SQ3	2	84080	0	AA,DU,GP,TA	675/4,500		45	85916	BN
Envision	19	SQ3	2	84300	0	GP	675/4,500		25	85916	
LaCrosse Except Super	05-09	SQ2	1-1/4	06384		GP,JR	300/3,500		30	78111	
		SQ2	1-1/4	51183		GP,JR	300/3,500		30		
LaCrosse	10-16	SQ2	1-1/4	06168	0	HM	300/3,500		35	85719	C,H
LaCrosse AWD	10-11	SQ2	1-1/4	06993†		†,HM	300/3,500		25	85719	CH
LaCrosse FWD	10-12	SQ2	1-1/4	06993†	0	†,HM	300/3,500		20	85719	CH
LaCrosse	14	SQ2	1-1/4	06167†	0	†,HM	300/3,500		30	85719	CH
LaCrosse	17-20	RT2	1-1/4	06189	0	GP,JR,AA,DU,X,TA	350/3,500		80	85945	CH
LeSabre	00-05	SQ2	1-1/4	06976		HM,JR	300/3,500		30		
		SQ2	1-1/4	51173		HM,JR	300/3,500		30		
Lucerne Except Super & Special Edition	06-09	SQ2	1-1/4	06976		HM,JR,KH	300/3,500		30	74696	
		SQ2	1-1/4	51173		HM,JR,KH	300/3,500		30		
Lucerne Super & Special Edition	08-09	SQ2	1-1/4	06125	0	HM,JR	300/3,500		25	74696	
Lucerne	10-11	SQ2	1-1/4	06125	0	HM,JR	300/3,500		25	74696	
Park Avenue	97-04	SQ2	1-1/4	06263		JR,GP	300/3,500		40		
Regal (App. starts with 97-1/2)	97-04	SQ1	1-1/4	77077†	0	†,TA,GP	200/2,000		20		
		SQ2	1-1/4	06262		JR,GP	300/3,500		35		
Regal	11-13	SQ2	1-1/4	06168	0	HM	300/3,500		35	85724	CH
Regal Except Turbo	11-13	SQ2	1-1/4	06993†	0	†,HM	300/3,500		20	85724	CH
Regal	14-17	SQ2	1-1/4	06168	0	HM	300/3,500		35	85845	CH
Regal Sportback	18-20	RT2	1-1/4	06189	0	GP,JR,AA,DU,X,TA	350/3,500		80	85992	CH,BN
Regal TourX	18-20	SQ2	1-1/4	06198	0	EP,GP,JR,KH	350/3,500		30	85992	CH,BN
Rendezvous	02-07	SQ2	1-1/4	06457†		HM	300/3,500		40	85261	BN
		SQ3	2	33061	0		350/3,500		55		
		SQ3	2	44538			350/3,500		40		
		SQ3	2	51151		HM	350/3,500		40		
Terraza	05-07	SQ2	1-1/4	51102		AL,GP,JR	300/3,500		40	85344	BN
		SQ3	2	44574		AL,JR	350/3,500	500/5,000	40		
		SQ3	2	51079		AL,GP,JR	350/3,500	500/5,000	40		
Verano Except Turbo or w/Dual Exhaust	12-19	SQ1	1-1/4	77269	0	AW,GP,JR,KH,QW	200/2,000		40	85797	CH
<b>CADILLAC</b>											
ATS	13-14	SQ1	1-1/4	77288†	0	†,GP	200/2,000		30	85812	CH
ATS Except ATS-V	13-20	SQ1	1-1/4	77311	0	GP	200/2,000		30	85812	CH
CTS	03-07	SQ1	1-1/4	77143		JR,TA,HM	200/2,000		45	74717	CH
CTS 4 Dr. Sedan	08-13	SQ1	1-1/4	77143		JR,TA,HM	200/2,000		45	78033	CH
CTS 4 Dr. Sedan	14-15	SQ1	1-1/4	77314†		GP,JR,KH,TA	200/2,000		60	85865	CH
CTS 4 Dr. Sedan, Except CTS-V	16-20	SQ1	1-1/4	77314†		GP,JR,KH,TA	200/2,000		60	85865	CH
CTS V	04-07	SQ1	1-1/4	77143		JR,TA,HM	200/2,000		45	74717	CH
CTS V 4 Dr. Sedan	09-13	SQ1	1-1/4	77143		JR,TA,HM	200/2,000		45		
DeVille	97-99	SQ2	1-1/4	06265†		†,JR,GP	300/3,500		20		
DeVille	00-05	SQ2	1-1/4	06298	0	GP	300/3,500		20		
DTS	06-11	SQ2	1-1/4	06298	0	GP	300/3,500		20	85778	CH
Escalade	99-00	SQ3	2	44656		HM	500/5,000	750/7,500	30	74180	BN
		SQ4	2	37074		HM	600/6,000	1,000/10,000	30		

† Available while supply lasts.

AA Requires temporary removal of bumper during installation.

AL Additional installation time required for vehicles equipped with load leveling compressor.

AW Will not fit Turbo models.

BN Exterior mounted plug on some or all models. May require an aftermarket electrical mounting box or bracket. (Sold separately)

C 2 or 3 wire system determine at installation.

CH T-One is equipped with circuit protected ModuLite® module.

DU Fascia removal required.

EP Fascia trimming may be required.

GP Hitch crosstube concealed behind bumper.

H 3 wire system with OEM standard 2 wire harness.

HM Hitch crosstube is visible beneath bumper.

JR Exhaust must be temporarily lowered for installation.

KH Minor heat shield modification may be required.

0 Uses all existing holes. No drilling required.

QW Will not fit vehicles with dual exhaust.

RT Round Tube Class III/IV 2"

TA Trunk access required for hitch installation.

TN Hitches produced before 07/09/12 are rated at 500/5000 WC & 500/5000 WD.

X Minor fascia trimming required.

RT2 Round Tube Class II 1-1/4"

RT3 Round Tube Class III 2"

SQ1 Square Tube Class I

SQ2 Square Tube Class II

SQ3 Square Tube Class III

SQ4 Square Tube Class IV

C - CADILLAC

# RECEIVER HITCH AND T-CONNECTOR APPLICATION GUIDE

MODEL / STYLE	YEAR	TRAILER HITCHES								T-CONNECTOR	
		REC TYPE	REC SIZE	PART NO.	NO DRILL	FOOTNOTES	WC (LBS.)	WD (LBS.)	IN	T-CON PART NO.	FN
<b>CADILLAC (Continued)</b>											
Escalade	02	RT4	2	51201	0	RT,CN,HM	600/6,000	800/8,000	15		
		RT4	2	44668	0	CN,HM	900/6,000	1,000/10,000	15		
Escalade EXT	02	RT4	2	51201	0	RT,CN,HM	600/6,000	800/8,000	15		
		RT4	2	44668	0	CN,HM	900/6,000	1,000/10,000	15		
Seville	98-04	SQ2	1-1/4	06617†	0	EP,GP,JR	300/3,500		35		
SRX Except w/Sport Package Fascia	04-09	RT3	2	33086	0	JR,KH	350/3,500	500/5,000	60		
SRX	10-16	RT3	2	44638	0		400/4,000	500/5,000	15		
STS	05-11	SQ1	1-1/4	77143	0	JR,TA,HM	200/2,000		45		
XT4	19-21	SQ3	2	84266	0	GP,JR,DU	675/4,500		80	85999	BN
XT5 Except Platinum	17-20	SQ3	2	84022	0	GP	675/4,500	675/4,500	20	85918	BN
XT5 Except Platinum	21	SQ3	2	84022	0	GP	675/4,500	675/4,500	20	85918	BN
XTS	13-19	SQ2	1-1/4	06168		HM	300/3,500		35		
<b>CHEVROLET</b>											
Astro Extended Body	90-05	SQ2		88001†		†	350/3,500				
		SQ2	1-1/4	06037†	0	CS,GP	300/3,500		30		
		SQ2	1-1/4	06227†	0	CS,HM	300/3,500		30		
		SQ3	2	44010	0	CS,GP	300/3,500	600/6,000	30		
		SQ3	2	51029	0	CS,GP	300/3,500	600/6,000	30		
		SQ3	2	37042		AF	500/5,000	600/6,000	65		
		SQ3	2	37152		AF	500/5,000	600/6,000	65		
Avalanche 1500	02	RT4	2	44668	0	CN,HM	900/6,000	1,000/10,000	15		
Avalanche 1500	02-06	RT4	2	51201	0	RT,CN,HM	600/6,000	800/8,000	15		
Avalanche 1500	03-06	RT4	2	44668	0	CN,HM	900/6,000	1,000/10,000	15		
Avalanche 2500	02-06	RT4	2	44668	0	CN,HM	900/6,000	1,000/10,000	15		
Avalanche 2500	03-06	RT4	2	51201	0	RT,CN,HM	600/6,000	800/8,000	15		
Aveo 5 Dr. Hatchback	04-11	SQ1	1-1/4	77097		GP	200/2,000		30	85709	CG
Aveo 4 Dr. Sedan	06	SQ1	1-1/4	77181†	0	HM,TA	200/2,000		20	85709	CG
Aveo 4 Dr. Sedan	07-11	SQ1	1-1/4	77181†	0	HM,TA	200/2,000		20	85737	
Blazer Downsize	98-05	RT3	2	37041		FP,JT,KK	500/5,000	600/6,000	30		
Blazer Downsize	99-01	SQ2	1-1/4	06955†	0	FP,GP,KK	300/3,500		15		
		RT3	2	33015	0	FP,KK,SD	400/4,000	600/6,000	15		
		SQ3	2	44098	0	FP,HM,KK	400/4,000	600/6,000	20		
		SQ3	2	51031	0	FP,HM,KK	400/4,000	600/6,000	15		
Blazer Downsize	02-05	SQ2	1-1/4	06955†	0	FP,GP,KK	300/3,500		15		
		RT3	2	33015	0	FP,KK,SD	400/4,000	600/6,000	15		
		SQ3	2	44098	0	FP,HM,KK	400/4,000	600/6,000	20		
		SQ3	2	51031	0	FP,HM,KK	400/4,000	600/6,000	15		
Blazer	19-20	SQ3	2	84023	0	GP,JR,AA,DU,SV,TA	675/4,500	675/4,500	90	85918	BN
Blazer	21	SQ3	2	84023	0	GP,JR,AA,DU,SV,TA	675/4,500	675/4,500	90	85918	BN
Blazer Trailblazer	99-01	SQ2	1-1/4	06955†	0	FP,GP,KK	300/3,500		15		
		RT3	2	33015	0	FP,KK,SD	400/4,000	600/6,000	15		
		SQ3	2	44098		FP,HM,KK	400/4,000	600/6,000	20		
		SQ3	2	51031	0	FP,HM,KK	400/4,000	600/6,000	15		
		RT3	2	37041		FP,JT,KK	500/5,000	600/6,000	30		
Bolt EV	17-19	SQ1	1-1/4	77956	0	GP,X	200/2,000		20		
C/K Series 2 Dr. Regular & Extended Cabs w/6 ft. Bed	88-00	SQ3	2	37096		CA,HX	500/5,000	650/6,500	90	74180	
C/K Series 2 Dr. Regular & Extended Cabs w/8 ft. Bed	88-00	SQ2		88001†		†	350/3,500		35	74180	
		SQ3	2	37096		CA,HX	500/5,000	650/6,500	90		
C/K Series 4 Dr. Crew Cab w/8 ft. Bed	92-00	SQ3	2	37096		CA,HX	500/5,000	650/6,500	90	74180	
C15 2 Dr. Regular & Extended Cabs w/6 ft. Bed	88-00	RT4	2	37094			700/7,000	1,200/12,000	40	74180	
C15 2 Dr. Regular & Extended Cabs w/8 ft. Bed	88-00	RT4	2	37094			700/7,000	1,200/12,000	40	74180	

† Available while supply lasts.  
 AA Requires temporary removal of bumper during installation.  
 AF Hitch is ONLY rated for Weight Carrying at 3500 lbs. GTW / 350 lbs. TW and DO NOT use Weight Distribution Spring Bars for this Specific Vehicle. Except for long bed pickups.  
 BN Exterior mounted plug on some or all models. May require an aftermarket electrical mounting box or bracket. (Sold separately)  
 CA Models with dual exhaust require exhaust modification.  
 CG T-One incorporates circuit protected taillight converter.  
 CN Requires OEM factory bumper for hitch installation.  
 CS Will fit with full-size spare tire stowed under vehicle.  
 DU Fascia removal required.  
 EP Fascia trimming may be required.  
 FP Spare tire repositioning and/or modification of spare tire carrier may be required.  
 GP Hitch crosstube concealed behind bumper.

HM Hitch crosstube is visible beneath bumper.  
 HX Minor exhaust modification may be required.  
 JR Exhaust must be temporarily lowered for installation.  
 JT 2WD models only.  
 KH Minor heat shield modification may be required.  
 KK When installing on a vehicle originally equipped with an OEM hitch, OEM bumper brackets must be purchased and installed prior to new hitch installation.  
 0 Uses all existing holes. No drilling required.  
 RT Round Tube Class III/IV 2"  
 SD Hitches produced before 07/21/06 are rated at 350/3500 WC.  
 SV Trimming or removal of under body appearance panel may be required.  
 TA Trunk access required for hitch installation.  
 X Minor fascia trimming required.

RT3 Round Tube Class III 2"  
 RT4 Round Tube Class IV 2"  
 SQ1 Square Tube Class I  
 SQ2 Square Tube Class II  
 SQ3 Square Tube Class III



# RECEIVER HITCH AND T-CONNECTOR APPLICATION GUIDE

RECEIVER HITCHES

MODEL / STYLE	YEAR	TRAILER HITCHES								T-CONNECTOR	
		REC TYPE	REC SIZE	PART NO.	NO DRILL	FOOTNOTES	WC (LBS.)	WD (LBS.)	IN	T-CON PART NO.	FN
<b>CHEVROLET (Continued)</b>											
<b>C1500</b>	<b>88-99</b>	RT3	2	<b>37069</b>			500/5,000	750/7,500	40	<b>85741</b>	BN
		SQ3	2	<b>44105</b>	Ø	GP	500/5,000	1,000/10,000	25		
		SQ3	2	<b>51016</b>		HM	500/5,000	1,000/10,000	40		
		SQ3	2	<b>51021</b>	Ø	HM,J	500/5,000	1,000/10,000	20		
		SQ3	2	<b>51022</b>	Ø	GP	500/5,000	1,000/10,000	20		
		SQ4	2	<b>96524</b>	Ø	GP	600/6,000	1,000/10,000	20		
		RT4	2	<b>37034</b>			700/7,000	1,200/12,000	40		
		SQ5	2	<b>96901</b>		DB,GP,SN	1,000/10,000	1,300/13,000	30		
<b>C1500 2 Dr. Regular &amp; Extended Cabs w/6 ft. Bed</b>	<b>88-00</b>	RT4	2	<b>37094</b>			700/7,000	1,200/12,000	40	<b>74180</b>	
<b>C1500 2 Dr. Regular &amp; Extended Cabs w/8 ft. Bed</b>	<b>88-00</b>	RT4	2	<b>37094</b>			700/7,000	1,200/12,000	40	<b>74180</b>	
<b>C1500 w/10" Deep Drop Bumper</b>	<b>88-99</b>	SQ4	2	<b>96528</b>	Ø	FS,J	600/6,000	1,000/10,000	20	<b>85741</b>	BN
<b>C1500 w/Aftermarket Roll Pan</b>	<b>88-99</b>	SQ3	2	<b>96522</b>		CO,HK	500/5,000	550/5,500	40	<b>85741</b>	BN
<b>C1500 4 Dr. Crew Cab w/8 ft. Bed</b>	<b>92-00</b>	RT4	2	<b>37094</b>			700/7,000	1,200/12,000	40	<b>74180</b>	
<b>C2500 2 Dr. Regular &amp; Extended Cabs w/6 ft. Bed</b>	<b>88-00</b>	RT4	2	<b>37094</b>			700/7,000	1,200/12,000	40	<b>74180</b>	
<b>C2500 2 Dr. Regular &amp; Extended Cabs w/8 ft. Bed</b>	<b>88-00</b>	RT4	2	<b>37094</b>			700/7,000	1,200/12,000	40	<b>74180</b>	
<b>C2500 Regular &amp; Extended Cabs</b>	<b>88-99</b>	RT3	2	<b>37069</b>			500/5,000	750/7,500	40	<b>85741</b>	BN
		SQ3	2	<b>44105</b>	Ø	GP	500/5,000	1,000/10,000	25		
		SQ3	2	<b>51016</b>		HM	500/5,000	1,000/10,000	40		
		SQ3	2	<b>51021</b>	Ø	HM,J	500/5,000	1,000/10,000	20		
		SQ3	2	<b>51022</b>	Ø	GP	500/5,000	1,000/10,000	20		
		SQ4	2	<b>96524</b>	Ø	GP	600/6,000	1,000/10,000	20		
		RT4	2	<b>37034</b>			700/7,000	1,200/12,000	40		
		SQ5	2	<b>45706</b>			1,200/12,000	1,700/14,000	45		
<b>C2500 Regular &amp; Extended Cabs</b>	<b>88-00</b>	SQ5	2	<b>96901</b>		DB,GP,SN	1,000/10,000	1,300/13,000	30	<b>85741</b>	BN
<b>C2500 Regular &amp; Extended Cabs, w/10" Deep Drop Bumper</b>	<b>88-99</b>	SQ4	2	<b>96528</b>	Ø	FS,J	600/6,000	1,000/10,000	20	<b>85741</b>	BN
<b>C2500 w/Aftermarket Roll Pan</b>	<b>88-99</b>	SQ3	2	<b>96522</b>		CO,HK	500/5,000	550/5,500	40	<b>85741</b>	BN
<b>C2500 4 Dr. Crew Cab w/8 ft. Bed</b>	<b>92-00</b>	RT4	2	<b>37094</b>			700/7,000	1,200/12,000	40	<b>74180</b>	
<b>C2500 Crew Cab</b>	<b>92-00</b>	RT3	2	<b>37069</b>	Ø		500/5,000	750/7,500	40	<b>85741</b>	BN
		SQ3	2	<b>44105</b>	Ø	GP	500/5,000	1,000/10,000	25		
		SQ3	2	<b>51016</b>		HM	500/5,000	1,000/10,000	40		
		SQ3	2	<b>51021</b>	Ø	HM,J	500/5,000	1,000/10,000	20		
		SQ3	2	<b>51022</b>	Ø	GP	500/5,000	1,000/10,000	20		
		SQ4	2	<b>96524</b>	Ø	GP	600/6,000	1,000/10,000	20		
		RT4	2	<b>37034</b>			700/7,000	1,200/12,000	40		
		SQ5	2	<b>96901</b>		DB,GP,SN	1,000/10,000	1,300/13,000	30		
		SQ5	2	<b>45706</b>			1,200/12,000	1,700/14,000	45		
<b>C2500 Crew Cab w/10" Deep Drop Bumper</b>	<b>92-00</b>	SQ4	2	<b>96528</b>	Ø	FS,J	600/6,000	1,000/10,000	20	<b>85741</b>	BN
<b>C35 2 Dr. Regular &amp; Extended Cabs w/6 ft. Bed</b>	<b>88-00</b>	RT4	2	<b>37094</b>			700/7,000	1,200/12,000	40	<b>74180</b>	
<b>C35 2 Dr. Regular &amp; Extended Cabs w/8 ft. Bed</b>	<b>88-00</b>	RT4	2	<b>37094</b>			700/7,000	1,200/12,000	40	<b>74180</b>	
<b>C35 4 Dr. Crew Cab w/8 ft. Bed</b>	<b>92-00</b>	RT4	2	<b>37094</b>			700/7,000	1,200/12,000	40	<b>74180</b>	
<b>C3500 2 Dr. Regular &amp; Extended Cabs w/6 ft. Bed</b>	<b>88-00</b>	RT4	2	<b>37094</b>			700/7,000	1,200/12,000	40	<b>74180</b>	
<b>C3500 2 Dr. Regular &amp; Extended Cabs w/8 ft. Bed</b>	<b>88-00</b>	RT4	2	<b>37094</b>			700/7,000	1,200/12,000	40	<b>74180</b>	
<b>C3500 Regular &amp; Extended Cabs</b>	<b>88-00</b>	RT3	2	<b>37069</b>			500/5,000	750/7,500	40	<b>85741</b>	BN
		SQ3	2	<b>44105</b>	Ø	GP	500/5,000	1,000/10,000	25		
		SQ3	2	<b>51016</b>		HM	500/5,000	1,000/10,000	40		
		SQ3	2	<b>51021</b>	Ø	HM,J	500/5,000	1,000/10,000	20		
		SQ3	2	<b>51022</b>	Ø	GP	500/5,000	1,000/10,000	20		
		SQ4	2	<b>96524</b>	Ø	GP	600/6,000	1,000/10,000	20		
		RT4	2	<b>37034</b>			700/7,000	1,200/12,000	40		
		SQ5	2	<b>96901</b>		DB,GP,SN	1,000/10,000	1,300/13,000	30		
		SQ5	2	<b>45706</b>			1,200/12,000	1,700/14,000	45		

**BN** Exterior mounted plug on some or all models. May require an aftermarket electrical mounting box or bracket. (Sold separately)

**CO** Will not fit 8 ft. 2500/3500 Series with heavy-duty suspension or four door Crew Cab.

**DB** Will not fit 6 ft. bed pickups.

**FS** Includes 2 & 4 WD models with heavy duty suspension.

**GP** Hitch cross-tube concealed behind bumper.

**HK** Under vehicle spare tire stowage may be retained with installation of an aftermarket spare tire repositioner. Cutting of rollpan in license plate area required for receiver tube access. Does not fit with bumper.

**HM** Hitch cross-tube is visible beneath bumper.

**J** Under vehicle spare tire stowage is retained.

**Ø** Uses all existing holes. No drilling required.

**SN** Hitches produced before 04/28/08 are rated at 1000/10000 WC & 1200/12000 WD.

**RT3** Round Tube Class III 2"

**RT4** Round Tube Class IV 2"

**SQ3** Square Tube Class III

**SQ4** Square Tube Class IV

**SQ5** Square Tube Class V

C - CHEVROLET

# RECEIVER HITCH AND T-CONNECTOR APPLICATION GUIDE

RECEIVER HITCHES

MODEL / STYLE	YEAR	TRAILER HITCHES							T-CONNECTOR		
		REC TYPE	REC SIZE	PART NO.	NO DRILL	FOOTNOTES	WC (LBS.)	WD (LBS.)	IN	T-CON PART NO.	FN
<b>CHEVROLET (Continued)</b>											
C3500 Regular & Extended Cabs, w/10" Deep Drop Bumper	88-00	SQ4	2	96528	0	FS,J	600/6,000	1,000/10,000	20	85741	BN
C3500 w/Aftermarket Roll Pan	88-00	SQ3	2	96522		CO,HK	500/5,000	550/5,500	40	85741	BN
C3500 4 Dr. Crew Cab w/8 ft. Bed	92-00	RT4	2	37094			700/7,000	1,200/12,000	40	74180	
C3500 Crew Cab	92-00	RT3	2	37069	0		500/5,000	750/7,500	40	85741	BN
		SQ3	2	44105	0	GP	500/5,000	1,000/10,000	25		
		SQ3	2	51016		HM	500/5,000	1,000/10,000	40		
		SQ3	2	51021	0	HM,J	500/5,000	1,000/10,000	20		
		SQ3	2	51022	0	GP	500/5,000	1,000/10,000	20		
		SQ4	2	96524	0	GP	600/6,000	1,000/10,000	20		
		RT4	2	37034			700/7,000	1,200/12,000	40		
SQ5	2	96901		DB,GP,SN	1,000/10,000	1,300/13,000	30				
SQ5	2	45706			1,200/12,000	1,700/14,000	45				
C3500 Crew Cab w/10" Deep Drop Bumper	92-00	SQ4	2	96528	0	FS,J	600/6,000	1,000/10,000	20	85741	BN
C3500HD 2 Dr. Regular & Extended Cabs w/6 ft. Bed	88-00	RT4	2	37094			700/7,000	1,200/12,000	40	74180	
C3500HD 2 Dr. Regular & Extended Cabs w/8 ft. Bed	88-00	RT4	2	37094			700/7,000	1,200/12,000	40	74180	
C3500HD 4 Dr. Crew Cab w/8 ft. Bed	92-00	RT4	2	37094			700/7,000	1,200/12,000	40	74180	
Camaro Except Convertible & w/Dealer Installed Ground Effects	10-11	SQ1	1-1/4	77223	0	GP	200/2,000		15	85710	CH
Camaro Except Convertible & w/Dealer Installed Ground Effects	12-15	SQ1	1-1/4	77223	0	GP	200/2,000		15	85784	CH
Camaro	16-18	SQ1	1-1/4	77326	0	GP	200/2,000		50	85915	CH
Camaro	19-21	SQ1	1-1/4	77326	0	GP	200/2,000		50		
Captiva Sport	12-15	SQ3	2	44580	0	GP	400/4,000	400/4,000	15	74720	CH
Cavalier Except Z-24	95-99	SQ1	1-1/4	77049†		GP,JR	200/2,000		40		
Cavalier	00-01	SQ1	1-1/4	77049†		GP,JR	200/2,000		40		
Cavalier Except Z-24	02	SQ1	1-1/4	77049†		GP,JR	200/2,000		40		
Cavalier Except LS Sport	03-05	SQ1	1-1/4	77049†		GP,JR	200/2,000		40		
Cavalier LS Sport	03-05	SQ1	1-1/4	77069†		†JR,KH,GP	200/2,000		40		
Cavalier Z-24	95-99	SQ1	1-1/4	77069†		†JR,KH,GP	200/2,000		40		
Cavalier Z-24	02	SQ1	1-1/4	77069†		†JR,KH,GP	200/2,000		40		
Cavalier Z-24 (Canada Only)	03-05	SQ1	1-1/4	77069†		†JR,KH,GP	200/2,000		40		
City Express	15-20	RT3	2	44711	0	HM,JR,X	525/3,500		30	85829	CH
Cobalt 2 Dr., Except SS	05-10	SQ1	1-1/4	77122		JR,HM	200/2,000		40	78043	BN
Cobalt 4 Dr., Except SS	05-10	SQ1	1-1/4	77122		JR,HM	200/2,000		40	78035	BN
Cobalt Sport 2 Dr.	08	SQ1	1-1/4	51164		HM,JR	200/2,000		25	78043	BN
		SQ1	1-1/4	77132		HM,JR	200/2,000		25		
Cobalt Sport 4 Dr.	08	SQ1	1-1/4	51164		HM,JR	200/2,000		25	78035	BN
		SQ1	1-1/4	77132		HM,JR	200/2,000		25		
Cobalt SS 2 Dr.	05-10	SQ1	1-1/4	51164		HM,JR	200/2,000		25	78043	BN
		SQ1	1-1/4	77132		HM,JR	200/2,000		25		
Cobalt SS 4 Dr.	05-10	SQ1	1-1/4	51164		HM,JR	200/2,000		25	78035	BN
		SQ1	1-1/4	77132		HM,JR	200/2,000		25		
Colorado	04-12	SQ4	2	44593	0	CP,GP	600/6,000	750/7,500	25	78001	BN,CG
		SQ4	2	51074	0	CP,GP	600/6,000	750/7,500	25		
Colorado	15-21	SQ3	2	97239†	0	HM,V,SO	500/5,000	600/6,000	25		
		RT4	2	44757	0	HM,AA,V,SO,TZ	800/6,000	800/8,000	35		
		SQ4	2	84999	0	HM,AA,V,SO,TZ	800/8,000	1000/10,000	35		
Cruze	11-15	SQ1	1-1/4	77269	0	GP	200/2,000		15	85732	CH
Cruze (New Body Style)	16-19	SQ1	1-1/4	77330	0	GP,X,DU,TA	200/2,000		80	85920	CH
Cruze Limited Only (Old Body Style)	16-18	SQ1	1-1/4	77269	0	GP	200/2,000		15	85732	CH
Cruze Hatchback	17-19	SQ1	1-1/4	77951	0	GP,X,DU	200/2,000		60	85946	CH

† Available while supply lasts.

**AA** Requires temporary removal of bumper during installation.

**BN** Exterior mounted plug on some or all models. May require an aftermarket electrical mounting box or bracket. (Sold separately)

**CG** T-One incorporates circuit protected taillight converter.

**CH** T-One is equipped with circuit protected ModuLite® module.

**CO** Will not fit 8 ft. 2500/3500 Series with heavy-duty suspension or four door Crew Cab.

**CP** Fits all models without factory installed receiver.

**DB** Will not fit 6 ft. bed pickups.

**DU** Fascia removal required.

**FS** Includes 2 & 4 WD models with heavy duty suspension.

**GP** Hitch cross-tube concealed behind bumper.

**HK** Under vehicle spare tire stowage may be retained with installation of an aftermarket spare tire repositioner. Cutting of rollpan in license plate area required for receiver tube access. Does not fit with bumper.

**HM** Hitch cross-tube is visible beneath bumper.

**J** Under vehicle spare tire stowage is retained.

**JR** Exhaust must be temporarily lowered for installation.

**KH** Minor heat shield modification may be required.

**0** Uses all existing holes. No drilling required.

**SN** Hitches produced before 04/28/08 are rated at 1000/10000 WC & 1200/12000 WD.

**SO** With this hitch installed the step bumper is no longer able to be used as a towing point.

**TA** Trunk access required for hitch installation.

**TZ** Requires replacement of the impact structure with hitch.

**V** For vehicles with factory installed step bumpers only.

**X** Minor fascia trimming required.

**RT3** Round Tube Class III 2"

**RT4** Round Tube Class IV 2"

**SQ1** Square Tube Class I

**SQ3** Square Tube Class III

**SQ4** Square Tube Class IV

**SQ5** Square Tube Class V

C - CHEVROLET

# RECEIVER HITCH AND T-CONNECTOR APPLICATION GUIDE

RECEIVER HITCHES

MODEL / STYLE	YEAR	TRAILER HITCHES								T-CONNECTOR	
		REC TYPE	REC SIZE	PART NO.	NO DRILL	FOOTNOTES	WC (LBS.)	WD (LBS.)	IN	T-CON PART NO.	FN
<b>CHEVROLET (Continued)</b>											
Equinox	05-06	SQ2	1-1/4	06391	0	HM	300/3,500		25	78028	CG
		SQ2	1-1/4	51185	0	HM	300/3,500		25		
		SQ3	2	51193	0	HM	350/3,500	400/4,000	30		
		SQ3	2	84028	0	HM	675/4,500	675/4,500	30		
Equinox	07-09	SQ2	1-1/4	06391	0	HM	300/3,500		25	74709	CE
		SQ2	1-1/4	51185	0	HM	300/3,500		25		
		SQ3	2	51193	0	HM	350/3,500	400/4,000	30		
		SQ3	2	84028	0	HM	675/4,500	675/4,500	30		
Equinox	10-17	SQ2	1-1/4	06391	0	HM	300/3,500		25	85716	CH
		SQ2	1-1/4	51185	0	HM	300/3,500		25		
		SQ3	2	51193	0	HM	350/3,500	400/4,000	30		
		SQ3	2	84028	0	HM	675/4,500	675/4,500	30		
Equinox Diesel	18-19	SQ3	2	84217	0	AI,DU,JR,TZ,X	675/4,500	675/4,500	70	85954	CH,BN
Equinox Except Premier or Models w/1.6L Diesel	18-21	SQ2	1-1/4	06180	0	JR	350/3,500		35	85954	CH,BN
		SQ3	2	84419	0	JR	675/4,500	675/4,500	35		
Equinox Premier, Except Models w/1.6L Diesel	18-20	SQ2	1-1/4	06180	0	JR	350/3,500		35	85973	CH,BN
		SQ3	2	84419	0	JR	675/4,500	675/4,500	35		
Equinox Premier, Except Models w/1.6L Diesel	21	SQ2	1-1/4	06180	0	JR	350/3,500		35		
		SQ3	2	84419	0	JR	675/4,500	675/4,500	35		
Express 1500	96-99	SQ2	1-1/4	06099	0	HM	300/3,500		15	74659	HG
		SQ3	2	37004	0	HM	500/5,000	1,000/10,000	20		
		RT3	2	37041		HM	500/5,000	600/6,000	35		
		SQ3	2	37152		HM	500/5,000	600/6,000	30		
		SQ3	2	44028	0	HM	500/5,000	1,000/10,000	30		
		SQ5	2	51023	0	HM	500/5,000	1,000/10,000	15		
Express 1500	00-02	SQ2	1-1/4	06099	0	HM	300/3,500		15	85246	HG
		SQ3	2	37004	0	HM	500/5,000	1,000/10,000	20		
		RT3	2	37041		HM	500/5,000	600/6,000	35		
		SQ3	2	37152		HM	500/5,000	600/6,000	30		
		SQ3	2	44028	0	HM	500/5,000	1,000/10,000	30		
		SQ5	2	51023	0	HM	500/5,000	1,000/10,000	15		
Express 1500	03	SQ2	1-1/4	06099	0	HM	300/3,500		15	78029	
		SQ3	2	37004	0	HM	500/5,000	1,000/10,000	20		
		SQ3	2	37152		HM	500/5,000	600/6,000	30		
		SQ3	2	44028	0	HM	500/5,000	1,000/10,000	30		
		SQ3	2	51023	0	HM	500/5,000	1,000/10,000	15		
		SQ5	2	96946		HM	1,500/10,000	1,300/13,000	35		
Express 1500	03-14	RT3	2	37041		HM	500/5,000	600/6,000	35		
Express 1500	04-14	SQ2	1-1/4	06099	0	HM	300/3,500		15	78029	
		SQ3	2	37004	0	HM	500/5,000	1,000/10,000	20		
		SQ3	2	37152		HM	500/5,000	600/6,000	30		
		SQ3	2	44028	0	HM	500/5,000	1,000/10,000	30		
		SQ3	2	51023	0	HM	500/5,000	1,000/10,000	15		
		SQ5	2	96946		HM	1,500/10,000	1,300/13,000	35		

- AI** Additional installation time may be required.
- BN** Exterior mounted plug on some or all models. May require an aftermarket electrical mounting box or bracket. (Sold separately)
- CE** T-One includes fuse(s) & relay(s). Converter not required. Standard 2 wire system at factory tow plug.
- CG** T-One incorporates circuit protected taillight converter.
- CH** T-One is equipped with circuit protected ModuLite® module.
- DU** Fascia removal required.
- HG** T-One incorporates taillight converter.
- HM** Hitch crosstube is visible beneath bumper.
- JR** Exhaust must be temporarily lowered for installation.
- 0** Uses all existing holes. No drilling required.
- TZ** Requires replacement of the impact structure with hitch.
- X** Minor fascia trimming required.

- RT3** Round Tube Class III 2"
- SQ2** Square Tube Class II
- SQ3** Square Tube Class III
- SQ5** Square Tube Class V

C - CHEVROLET

# RECEIVER HITCH AND T-CONNECTOR APPLICATION GUIDE

MODEL / STYLE	YEAR	TRAILER HITCHES							T-CONNECTOR		
		REC TYPE	REC SIZE	PART NO.	NO DRILL	FOOTNOTES	WC (LBS.)	WD (LBS.)	IN	T-CON PART NO.	FN
<b>CHEVROLET (Continued)</b>											
Express 2500	96-99	SQ2	1-1/4	06099	0	HM	300/3,500		15	74659	HG
		SQ3	2	37004	0	HM	500/5,000	1,000/10,000	20		
		RT3	2	37041		HM	500/5,000	600/6,000	35		
		SQ3	2	37152		HM	500/5,000	600/6,000	30		
		SQ3	2	44028	0	HM	500/5,000	1,000/10,000	30		
		SQ3	2	51023	0	HM	500/5,000	1,000/10,000	15		
		SQ5	2	45707	0	HM	1,200/12,000	1,700/14,000	45		
Express 2500	00-02	SQ2	1-1/4	06099	0	HM	300/3,500		15	85246	HG
		SQ3	2	37004	0	HM	500/5,000	1,000/10,000	20		
		RT3	2	37041		HM	500/5,000	600/6,000	35		
		SQ3	2	37152		HM	500/5,000	600/6,000	30		
		SQ3	2	44028	0	HM	500/5,000	1,000/10,000	30		
		SQ3	2	51023	0	HM	500/5,000	1,000/10,000	15		
		SQ5	2	45707	0	HM	1,200/12,000	1,700/14,000	45		
Express 2500	03	SQ2	1-1/4	06099	0	HM	300/3,500		15	78029	
		SQ3	2	37004	0	HM	500/5,000	1,000/10,000	20		
		SQ3	2	37152		HM	500/5,000	600/6,000	30		
		SQ3	2	44028	0	HM	500/5,000	1,000/10,000	30		
		SQ3	2	51023	0	HM	500/5,000	1,000/10,000	15		
		SQ5	2	45707	0	HM	1,200/12,000	1,700/14,000	45		
		SQ5	2	96946		HM	1,500/10,000	1,300/13,000	35		
Express 2500	03-14	RT3	2	37041		HM	500/5,000	600/6,000	35		
Express 2500	04-18	SQ2	1-1/4	06099	0	HM	300/3,500		15	78029	
		SQ3	2	37004	0	HM	500/5,000	1,000/10,000	20		
		SQ3	2	37152		HM	500/5,000	600/6,000	30		
		SQ3	2	44028	0	HM	500/5,000	1,000/10,000	30		
		SQ3	2	51023	0	HM	500/5,000	1,000/10,000	15		
		SQ5	2	45707	0	HM	1,200/12,000	1,700/14,000	45		
		SQ5	2	96946		HM	1,500/10,000	1,300/13,000	35		
Express 2500	19-20	SQ2	1-1/4	06099	0	HM	300/3,500		15		
		SQ3	2	37004	0	HM	500/5,000	1,000/10,000	20		
		SQ3	2	37152		HM	500/5,000	600/6,000	30		
		SQ3	2	44028	0	HM	500/5,000	1,000/10,000	30		
		SQ3	2	51023	0	HM	500/5,000	1,000/10,000	15		
		SQ5	2	45707	0	HM	1,200/12,000	1,700/14,000	45		
		SQ5	2	96946		HM	1,500/10,000	1,300/13,000	35		
Express 3500	96-99	SQ2	1-1/4	06099	0	HM	300/3,500		15	74659	HG
		SQ3	2	37004	0	HM	500/5,000	1,000/10,000	20		
		RT3	2	37041		HM	500/5,000	600/6,000	35		
		SQ3	2	37152		HM	500/5,000	600/6,000	30		
		SQ3	2	44028	0	HM	500/5,000	1,000/10,000	30		
		SQ3	2	51023	0	HM	500/5,000	1,000/10,000	15		
		SQ5	2	45707	0	HM	1,200/12,000	1,700/14,000	45		
		SQ5	2	96946		HM	1,500/10,000	1,300/13,000	35		

<p><b>HG</b> T-One incorporates taillight converter.</p> <p><b>HM</b> Hitch crosstube is visible beneath bumper.</p> <p><b>0</b> Uses all existing holes. No drilling required.</p>	<p><b>RT3</b> Round Tube Class III 2"</p> <p><b>SQ2</b> Square Tube Class II</p> <p><b>SQ3</b> Square Tube Class III</p> <p><b>SQ5</b> Square Tube Class V</p>
---	--



# RECEIVER HITCH AND T-CONNECTOR APPLICATION GUIDE

RECEIVER HITCHES

MODEL / STYLE	YEAR	TRAILER HITCHES								T-CONNECTOR	
		REC TYPE	REC SIZE	PART NO.	NO DRILL	FOOTNOTES	WC (LBS.)	WD (LBS.)	IN	T-CON PART NO.	FN
<b>CHEVROLET (Continued)</b>											
Express 3500	00-02	SQ2	1-1/4	06099	0	HM	300/3,500		15	85246	HG
		SQ3	2	37004	0	HM	500/5,000	1,000/10,000	20		
		RT3	2	37041		HM	500/5,000	600/6,000	35		
		SQ3	2	37152		HM	500/5,000	600/6,000	30		
		SQ3	2	44028	0	HM	500/5,000	1,000/10,000	30		
		SQ3	2	51023	0	HM	500/5,000	1,000/10,000	15		
		SQ5	2	45707	0	HM	1,200/12,000	1,700/14,000	45		
Express 3500	03	SQ2	1-1/4	06099	0	HM	300/3,500		15	78029	
		SQ3	2	37004	0	HM	500/5,000	1,000/10,000	20		
		SQ3	2	37152		HM	500/5,000	600/6,000	30		
		SQ3	2	44028	0	HM	500/5,000	1,000/10,000	30		
		SQ3	2	51023	0	HM	500/5,000	1,000/10,000	15		
		SQ5	2	45707	0	HM	1,200/12,000	1,700/14,000	45		
		SQ5	2	96946		HM	1,500/10,000	1,300/13,000	35		
Express 3500	03-14	RT3	2	37041		HM	500/5,000	600/6,000	35		
Express 3500	04-18	SQ2	1-1/4	06099	0	HM	300/3,500		15	78029	
		SQ3	2	37004	0	HM	500/5,000	1,000/10,000	20		
		SQ3	2	37152		HM	500/5,000	600/6,000	30		
		SQ3	2	44028	0	HM	500/5,000	1,000/10,000	30		
		SQ3	2	51023	0	HM	500/5,000	1,000/10,000	15		
		SQ5	2	45707	0	HM	1,200/12,000	1,700/14,000	45		
		SQ5	2	96946		HM	1,500/10,000	1,300/13,000	35		
Express 3500	19-20	SQ2	1-1/4	06099	0	HM	300/3,500		15		
Express 4500	03-14	SQ3	2	37004	0	HM	500/5,000	1,000/10,000	20		
		SQ3	2	37152		HM	500/5,000	600/6,000	30		
		SQ3	2	44028	0	HM	500/5,000	1,000/10,000	30		
		SQ3	2	51023	0	HM	500/5,000	1,000/10,000	15		
		SQ5	2	45707	0	HM	1,200/12,000	1,700/14,000	45		
		SQ5	2	96946		HM	1,500/10,000	1,300/13,000	35		
		Express 4500	03-14	RT3	2	37041		HM	500/5,000		
Express Van	96-99	SQ2		88001†		†,HM	350/3,500		30	74659	HG
		SQ3	2	37042		HM	500/5,000	600/6,000	30		
Express Van	00-02	SQ2		88001†		†,HM	350/3,500		30	85246	HG
		SQ3	2	37042		HM	500/5,000	600/6,000	30		
Express Van	03-14	SQ2		88001†		†,HM	350/3,500		30		
		SQ3	2	37042		HM	500/5,000	600/6,000	30		
HHR	06-11	SQ1	1-1/4	51164		HM, JR	200/2,000		25	78043	BN
		SQ1	1-1/4	77132		HM, JR	200/2,000		25		
HHR SS	08-10	SQ1	1-1/4	51164		EP, HM, JR	200/2,000		35	78043	BN
		SQ1	1-1/4	77132		EP, HM, JR	200/2,000		35		
Impala	00-05	SQ1	1-1/4	77082†		†, GP	200/2,000		20	85735	
		SQ2	1-1/4	06389	0	GP, JR	300/3,500		30		
		SQ2	1-1/4	51188	0	GP, JR	300/3,500		30		
Impala	06-13	SQ2	1-1/4	06389	0	GP, JR	300/3,500		30	74694	BN
		SQ2	1-1/4	51188	0	GP, JR	300/3,500		30		
Impala Except Impala Limited	14-20	SQ2	1-1/4	06168		HM, FE	300/3,500		35	85822	
Impala LS Except Impala Limited	14	SQ2	1-1/4	06163†	0	HM, X	300/3,500		30	85822	
Impala LT Except Impala Limited	14	SQ2	1-1/4	06163†	0	HM, X	300/3,500		30	85822	
Impala LTZ Except Impala Limited	14	SQ2	1-1/4	06163†	0	HM, X	300/3,500		30	85822	

- † Available while supply lasts.
- BN Exterior mounted plug on some or all models. May require an aftermarket electrical mounting box or bracket. (Sold separately)
- EP Fascia trimming may be required.
- FE Fascia trimming may be required. Allow additional installation time.
- GP Hitch cross-tube concealed behind bumper.
- HG T-One incorporates taillight converter.
- HM Hitch cross-tube is visible beneath bumper.
- JR Exhaust must be temporarily lowered for installation.
- 0 Uses all existing holes. No drilling required.
- X Minor fascia trimming required.

- RT3 Round Tube Class III 2"
- SQ1 Square Tube Class I
- SQ2 Square Tube Class II
- SQ3 Square Tube Class III
- SQ5 Square Tube Class V

C - CHEVROLET

# RECEIVER HITCH AND T-CONNECTOR APPLICATION GUIDE

MODEL / STYLE	YEAR	TRAILER HITCHES							T-CONNECTOR		
		REC TYPE	REC SIZE	PART NO.	NO DRILL	FOOTNOTES	WC (LBS.)	WD (LBS.)	IN	T-CON PART NO.	FN
<b>CHEVROLET (Continued)</b>											
K1500	88-99	RT3	2	37069			500/5,000	750/7,500	40	85741	BN
		SQ3	2	44105	Ø	GP	500/5,000	1,000/10,000	25		
		SQ3	2	51021	Ø	HM,J	500/5,000	1,000/10,000	20		
		SQ3	2	51022	Ø	GP	500/5,000	1,000/10,000	20		
		SQ4	2	96524	Ø	GP	600/6,000	1,000/10,000	20		
		RT4	2	37034			700/7,000	1,200/12,000	40		
		SQ5	2	96901		DB,GP,SN	1,000/10,000	1,300/13,000	30		
K1500 2 Dr. Regular & Extended Cabs w/6 ft. Bed	88-00	RT4	2	37094			700/7,000	1,200/12,000	40	74180	
K1500 2 Dr. Regular & Extended Cabs w/8 ft. Bed	88-00	RT4	2	37094			700/7,000	1,200/12,000	40	74180	
K1500 w/10" Deep Drop Bumper	88-99	SQ4	2	96528	Ø	FS,J	600/6,000	1,000/10,000	20	85741	BN
K1500 w/Aftermarket Roll Pan	88-99	SQ3	2	96522		CO,HK	500/5,000	550/5,500	40	85741	BN
K1500 4 Dr. Crew Cab w/8 ft. Bed	92-99	RT4	2	37094			700/7,000	1,200/12,000	40	74180	
K2500 2 Dr. Regular & Extended Cabs w/6 ft. Bed	88-00	RT4	2	37094			700/7,000	1,200/12,000	40	74180	
K2500 2 Dr. Regular & Extended Cabs w/8 ft. Bed	88-00	RT4	2	37094			700/7,000	1,200/12,000	40	74180	
K2500 Regular & Extended Cabs	88-99	RT3	2	37069			500/5,000	750/7,500	40	85741	BN
		SQ3	2	44105	Ø	GP	500/5,000	1,000/10,000	25		
		SQ3	2	51021	Ø	HM,J	500/5,000	1,000/10,000	20		
		SQ3	2	51022	Ø	GP	500/5,000	1,000/10,000	20		
		SQ4	2	96524	Ø	GP	600/6,000	1,000/10,000	20		
		RT4	2	37034			700/7,000	1,200/12,000	40		
		SQ5	2	45706			1,200/12,000	1,700/14,000	45		
K2500 Regular & Extended Cabs	88-00	SQ5	2	96901		DB,GP,SN	1,000/10,000	1,300/13,000	30	85741	BN
K2500 Regular & Extended Cabs, w/10" Deep Drop Bumper	88-99	SQ4	2	96528	Ø	FS,J	600/6,000	1,000/10,000	20	85741	BN
K2500 w/Aftermarket Roll Pan	88-99	SQ3	2	96522		CO,HK	500/5,000	550/5,500	40	85741	BN
K2500 4 Dr. Crew Cab w/8 ft. Bed	92-00	RT4	2	37094			700/7,000	1,200/12,000	40	74180	
K2500 Crew Cab	92-00	RT3	2	37069	Ø		500/5,000	750/7,500	40	85741	BN
		SQ3	2	44105	Ø	GP	500/5,000	1,000/10,000	25		
		SQ3	2	51021	Ø	HM,J	500/5,000	1,000/10,000	20		
		SQ3	2	51022	Ø	GP	500/5,000	1,000/10,000	20		
		SQ4	2	96524	Ø	GP	600/6,000	1,000/10,000	20		
		RT4	2	37034			700/7,000	1,200/12,000	40		
		SQ5	2	96901		DB,GP,SN	1,000/10,000	1,300/13,000	30		
		SQ5	2	45706			1,200/12,000	1,700/14,000	45		
K2500 Crew Cab w/10" Deep Drop Bumper	92-00	SQ4	2	96528	Ø	FS,J	600/6,000	1,000/10,000	20	85741	BN
K3500 2 Dr. Regular & Extended Cabs w/6 ft. Bed	88-00	RT4	2	37094			700/7,000	1,200/12,000	40	74180	
K3500 2 Dr. Regular & Extended Cabs w/8 ft. Bed	88-00	RT4	2	37094			700/7,000	1,200/12,000	40	74180	
K3500 Regular & Extended Cabs	88-00	RT3	2	37069			500/5,000	750/7,500	40	85741	BN
		SQ3	2	44105	Ø	GP	500/5,000	1,000/10,000	25		
		SQ3	2	51021	Ø	HM,J	500/5,000	1,000/10,000	20		
		SQ3	2	51022	Ø	GP	500/5,000	1,000/10,000	20		
		SQ4	2	96524	Ø	GP	600/6,000	1,000/10,000	20		
		RT4	2	37034			700/7,000	1,200/12,000	40		
		SQ5	2	96901		DB,GP,SN	1,000/10,000	1,300/13,000	30		
		SQ5	2	45706			1,200/12,000	1,700/14,000	45		
K3500 Regular & Extended Cabs, w/10" Deep Drop Bumper	88-00	SQ4	2	96528	Ø	FS,J	600/6,000	1,000/10,000	20	85741	BN
K3500 w/Aftermarket Roll Pan	88-00	SQ3	2	96522		CO,HK	500/5,000	550/5,500	40	85741	BN
K3500 4 Dr. Crew Cab w/8 ft. Bed	92-00	RT4	2	37094			700/7,000	1,200/12,000	40	74180	

<b>BN</b>	Exterior mounted plug on some or all models. May require an aftermarket electrical mounting box or bracket. (Sold separately)	<b>RT3</b>	Round Tube Class III 2"
<b>CO</b>	Will not fit 8 ft. 2500/3500 Series with heavy-duty suspension or four door Crew Cab.	<b>RT4</b>	Round Tube Class IV 2"
<b>DB</b>	Will not fit 6 ft. bed pickups.	<b>SQ3</b>	Square Tube Class III
<b>FS</b>	Includes 2 & 4 WD models with heavy duty suspension.	<b>SQ4</b>	Square Tube Class IV
<b>GP</b>	Hitch cross-tube concealed behind bumper.	<b>SQ5</b>	Square Tube Class V
<b>HK</b>	Under vehicle spare tire stowage may be retained with installation of an aftermarket spare tire repositioner. Cutting of rollpan in license plate area required for receiver tube access. Does not fit with bumper.		
<b>HM</b>	Hitch cross-tube is visible beneath bumper.		
<b>J</b>	Under vehicle spare tire stowage is retained.		
<b>Ø</b>	Uses all existing holes. No drilling required.		
<b>SN</b>	Hitches produced before 04/28/08 are rated at 1000/10000 WC & 1200/12000 WD.		

# RECEIVER HITCH AND T-CONNECTOR APPLICATION GUIDE

RECEIVER HITCHES

MODEL / STYLE	YEAR	TRAILER HITCHES								T-CONNECTOR	
		REC TYPE	REC SIZE	PART NO.	NO DRILL	FOOTNOTES	WC (LBS.)	WD (LBS.)	IN	T-CON PART NO.	FN
<b>CHEVROLET (Continued)</b>											
K3500 Crew Cab	92-00	RT3	2	37069	0		500/5,000	750/7,500	40	85741	BN
		SQ3	2	44105	0	GP	500/5,000	1,000/10,000	25		
		SQ3	2	51021	0	HM,J	500/5,000	1,000/10,000	20		
		SQ3	2	51022	0	GP	500/5,000	1,000/10,000	20		
		SQ4	2	96524	0	GP	600/6,000	1,000/10,000	20		
		RT4	2	37034			700/7,000	1,200/12,000	40		
K3500 Crew Cab w/10" Deep Drop Bumper	92-00	SQ5	2	96901		DB,GP,SN	1,000/10,000	1,300/13,000	30	85741	BN
		SQ5	2	45706			1,200/12,000	1,700/14,000	45		
		SQ4	2	96528	0	FS,J	600/6,000	1,000/10,000	20		
		SQ5	2	96947			1,600/15,000	1,600/16,000	35		
		SQ5	2	96947			1,600/15,000	1,600/16,000	35		
Kodiak C4500 Cab & Chassis, w/34" Wide Frames	03-09	SQ5	2	96947			1,600/15,000	1,600/16,000	35		
Kodiak C5500 Cab & Chassis, w/34" Wide Frames	03-09	SQ5	2	96947			1,600/15,000	1,600/16,000	35		
Kodiak C6500 Cab & Chassis, w/34" Wide Frames	99-09	SQ5	2	96947			1,600/15,000	1,600/16,000	35		
Kodiak C7500 Cab & Chassis, w/34" Wide Frames	99-09	SQ5	2	96947			1,600/15,000	1,600/16,000	35		
Kodiak C8500 Cab & Chassis, w/34" Wide Frames	99-09	SQ5	2	96947			1,600/15,000	1,600/16,000	35		
Lumina	95-00	SQ1	1-1/4	77259†		AI,GP	200/2,000		30		
		SQ2	1-1/4	06022†	0	†,JR,GP	300/3,500		60		
Malibu 4 Dr.	97-05	SQ1	1-1/4	77076	0	GP	200/2,000		15		
		SQ2	1-1/4	06249		GP	300/3,500		20		
Malibu 4 Dr.	04-07	SQ2	1-1/4	06988		JR,HM	300/3,500		40	74716	BN
Malibu Except LTZ	08-12	SQ2	1-1/4	06658		GP,JR,RB	300/3,500		45	78066	BN
Malibu Except LTZ & Canada Models	13-15	SQ2	1-1/4	06168	0	HM	300/3,500		35	85833	CH
Malibu Except Premier (New Body Style)	16-21	RT2	1-1/4	06189	0	GP,JR,AA,DU,X,TA	350/3,500		80	85917	CH
Malibu Limited, Except LTZ & Canada Models (Old Body Style)	16-19	SQ2	1-1/4	06168	0	HM	300/3,500		35	85833	CH
Malibu Limited, LTZ, Except Canada Models (Old Body Style)	16-19	SQ2	1-1/4	06168	0	HM	300/3,500		35	85850	CH
Malibu Premier (New Body Style)	16-20	RT2	1-1/4	06189	0	GP,JR,AA,DU,X,TA	350/3,500		80	85949	CH
Malibu Premier (New Body Style)	21	RT2	1-1/4	06189	0	GP,JR,AA,DU,X,TA	350/3,500		80		
Malibu Classic LS	08	SQ2	1-1/4	06988		JR,HM	300/3,500		40	74716	BN
Malibu Classic LT	08	SQ2	1-1/4	06988		JR,HM	300/3,500		40	74716	BN
Malibu LTZ	08-12	SQ2	1-1/4	06658		GP,JR,RB	300/3,500		45		
Malibu LTZ Except Canada Models	14-15	SQ2	1-1/4	06168	0	HM	300/3,500		35	85850	CH
Malibu Maxx LS	04-07	SQ2	1-1/4	06388†		†,HM	300/3,500		25	74716	BN
Malibu Maxx LT	04-07	SQ2	1-1/4	06388†		†,HM	300/3,500		25	74716	BN
Malibu SS 4 Dr.	06-07	SQ2	1-1/4	06988		JR,X,HM	300/3,500		50	74716	BN
Monte Carlo	95-99	SQ1	1-1/4	77259†		AI,GP	200/2,000		30		
		SQ2	1-1/4	06022†	0	†,JR,GP	300/3,500		60		
Monte Carlo Except SS Sport Appearance Pkg.	00-05	SQ2	1-1/4	06358	0	JR,GP	300/3,500		30		
Monte Carlo Except SS Sport Appearance Pkg.	06-07	SQ2	1-1/4	06358	0	JR,GP	300/3,500		30		
Orlando (Canada Only)	12-13	SQ1	1-1/4	77268	0	HM,JR,KH	200/2,000		35	85785	CH
Prizm	98-02	SQ1	1-1/4	77005		GP	200/2,000		30		
S10	98-04	SQ2	1-1/4	06958	0	GU,RH,GP	300/3,500		35	74216	BN
		SQ3	2	44062		CN,GU	350/3,500	500/5,000	20		
		SQ3	2	51063		CN,GP,GU	350/3,500	500/5,000	20		
		SQ3	2	37152		AF,CN,GU,ST	500/5,000	600/6,000	30		
S10 w/Standard Bed & Step Bumper	98-04	SQ2		88001†		†,CN,GU,ST	350/3,500		40	74216	
		SQ3	2	37042		AF,CN,GU,ST	500/5,000	600/6,000	30		

† Available while supply lasts.

AA Requires temporary removal of bumper during installation.

AF Hitch is ONLY rated for Weight Carrying at 3500 lbs. GTW / 350 lbs. TW and DO NOT use Weight Distribution Spring Bars for this Specific Vehicle. Except for long bed pickups.

AI Additional installation time may be required.

BN Exterior mounted plug on some or all models. May require an aftermarket electrical mounting box or bracket. (Sold separately)

CH T-One is equipped with circuit protected ModuLite® module.

CN Requires OEM factory bumper for hitch installation.

DB Will not fit 6 ft. bed pickups.

DU Fascia removal required.

FS Includes 2 & 4 WD models with heavy duty suspension.

GP Hitch cross-tube concealed behind bumper.

GU Will not fit vehicles with factory or aftermarket lower Fascia/Rollpan or Tube Bumper.

HM Hitch cross-tube is visible beneath bumper.

J Under vehicle spare tire storage is retained.

JR Exhaust must be temporarily lowered for installation.

KH Minor heat shield modification may be required.

0 Uses all existing holes. No drilling required.

RB Hitch installation can be made easier with a cutter type drill bit.

RH Optional drawbar #36051 required (Sold separately) except for models with ZR2 & Highrider package.

SN Hitches produced before 04/28/08 are rated at 1000/10000 WC & 1200/12000 WD.

ST Will not fit 2WD models with short bed.

TA Trunk access required for hitch installation.

X Minor fascia trimming required.

RT2 Round Tube Class II 1-1/4"

RT3 Round Tube Class III 2"

RT4 Round Tube Class IV 2"

SQ1 Square Tube Class I

SQ2 Square Tube Class II

SQ3 Square Tube Class III

SQ4 Square Tube Class IV

SQ5 Square Tube Class V

C - CHEVROLET

# RECEIVER HITCH AND T-CONNECTOR APPLICATION GUIDE

MODEL / STYLE	YEAR	TRAILER HITCHES								T-CONNECTOR	
		REC TYPE	REC SIZE	PART NO.	NO DRILL	FOOTNOTES	WC (LBS.)	WD (LBS.)	IN	T-CON PART NO.	FN
<b>CHEVROLET (Continued)</b>											
Silverado 1500	99-02	RT3	2	37069	0	RO	500/5,000	750/7,500	25		
		RT3	2	51072	0	RT,JL,RO	500/5,000	750/7,500	15		
		RT4	2	51081	0	RT,JL,RO	600/6,000	1,050/10,500	15		
		RT4	2	37034	0	RO	700/7,000	1,200/12,000	25		
		SQ4	2	37016	0	RO	750/7,500	1,200/12,000	20		
		RT4	2	44563	0	JL,RO,SZ	900/6,000	1,050/10,500	15		
		RT4	2	44564	0	JL,RO	900/6,000	900/8,000	15		
		SQ5	2	96932	0	HM,JL,RO	1,200/12,000	1,400/14,000	20		
Silverado 1500	99-05	SQ2		88001†		†,DB,RO	350/3,500		35	85262	RD
		SQ3	2	37096	0	JL,RO	500/5,000	650/6,500	35		
		RT4	2	37094	0	RO	700/7,000	1,200/12,000	25		
Silverado 1500 (Classic)	03-07	RT3	2	37069	0		500/5,000	750/7,500	25		
		RT3	2	51072	0	RT,JL	500/5,000	750/7,500	15		
		RT4	2	51081	0	RT,JL	600/6,000	1,050/10,500	15		
		RT4	2	37034	0		700/7,000	1,200/12,000	25		
		SQ4	2	37016	0		750/7,500	1,200/12,000	20		
		RT4	2	44563	0	JL,SZ	900/6,000	1,050/10,500	15		
		RT4	2	44564	0	JL	900/6,000	900/8,000	15		
		SQ5	2	96932	0	HM,JL	1,200/12,000	1,400/14,000	20		
Silverado 1500	06	SQ2		88001†		†,DB,RO	350/3,500		35	85262	RD
		SQ3	2	37096	0	JL,RO	500/5,000	650/6,500	35		
		RT4	2	37094	0	RO	700/7,000	1,200/12,000	25		
Silverado 1500	07-13	RT3	2	51072	0	RT,JL	500/5,000	750/7,500	15	85877	BN
		RT4	2	51081	0	RT,JL	600/6,000	1,050/10,500	15		
		RT4	2	44563	0	JL,SZ	900/6,000	1,050/10,500	15		
		RT4	2	44564	0	JL	900/6,000	900/8,000	15		
Silverado 1500 (Classic)	07	SQ2		88001†		†,DB,RO	350/3,500		35	85262	RD
		SQ3	2	37096	0	JL,RO	500/5,000	650/6,500	35		
		RT4	2	37094	0	RO	700/7,000	1,200/12,000	25		
Silverado 1500 LD (Old Body Style)	14-18	SQ3	2	51235†	0	†,HM,JL	500/5,000	800/8,000	15	85877	
		SQ3	2	97235†	0	HM,JL	500/5,000	800/8,000	15		
		RT4	2	44703	0	HM,JL	900/6,000	1,200/12,000	20		
		SQ4	2	84016	0	GP,JL	900/6,000	1,000/10,000	25		
Silverado 1500	19-21	SQ3	2	84326	0	CP	900/6,000	1,000/10,000	60		
Silverado 1500 HD	01-02	SQ4	2	37016	0		750/7,500	1,200/12,000	20		
Silverado 1500 HD	01-03	RT3	2	37069	0		500/5,000	750/7,500	25		
		RT3	2	51072	0	RT,JL	500/5,000	750/7,500	15		
		RT4	2	51081	0	RT,JL	600/6,000	1,050/10,500	15		
		RT4	2	37034	0		700/7,000	1,200/12,000	25		
		RT4	2	44563	0	JL,SZ	900/6,000	1,050/10,500	15		
		RT4	2	44564	0	JL	900/6,000	900/8,000	15		
		SQ5	2	96932	0	HM,JL	1,200/12,000	1,400/14,000	20		
Silverado 1500 HD	01-05	SQ3	2	37096	0	JL	500/5,000	650/6,500	35	85262	RD
		RT4	2	37094	0		700/7,000	1,200/12,000	25		
Silverado 1500 HD 6.6 ft. Bed	01-05	SQ2		88001†		†,DB	350/3,500		35	85262	RD
Silverado 1500 HD	03	SQ4	2	37016	0		750/7,500	1,200/12,000	20		
Silverado 1500 HD	05-07	SQ4	2	37016	0		750/7,500	1,200/12,000	20		

† Available while supply lasts.  
 BN Exterior mounted plug on some or all models. May require an aftermarket electrical mounting box or bracket. (Sold separately)  
 CP Fits all models without factory installed receiver.  
 DB Will not fit 6 ft. bed pickups.  
 GP Hitch crosstube concealed behind bumper.  
 HM Hitch crosstube is visible beneath bumper.  
 JL Installation requires OEM bumper and brackets.  
 0 Uses all existing holes. No drilling required.  
 RD For vehicles equipped with factory tow package may require additional components or may be used as a replacement harness.  
 RO Will not fit Silverado SS.  
 RT Round Tube Class III/IV 2"  
 SZ Hitches produced before 03/10/11 are rated at 600/6000 WC.

RT3 Round Tube Class III 2"  
 RT4 Round Tube Class IV 2"  
 SQ2 Square Tube Class II  
 SQ3 Square Tube Class III  
 SQ4 Square Tube Class IV  
 SQ5 Square Tube Class V



# RECEIVER HITCH AND T-CONNECTOR APPLICATION GUIDE

RECEIVER HITCHES

MODEL / STYLE	YEAR	TRAILER HITCHES								T-CONNECTOR	
		REC TYPE	REC SIZE	PART NO.	NO DRILL	FOOTNOTES	WC (LBS.)	WD (LBS.)	IN	T-CON PART NO.	FN
<b>CHEVROLET (Continued)</b>											
Silverado 1500 HD (Classic)	05-07	RT3	2	37069	0		500/5,000	750/7,500	25		
		RT3	2	51072	0	RT,JL	500/5,000	750/7,500	15		
		RT4	2	51081	0	RT,JL	600/6,000	1,050/10,500	15		
		RT4	2	37034	0		700/7,000	1,200/12,000	25		
		RT4	2	44563	0	JL,SZ	900/6,000	1,050/10,500	15		
		RT4	2	44564	0	JL	900/6,000	900/8,000	15		
Silverado 1500 HD	06	SQ3	2	37096	0	JL	500/5,000	650/6,500	35	85262	RD
		RT4	2	37094	0		700/7,000	1,200/12,000	25		
Silverado 1500 HD 6.6 ft. Bed	06	SQ2		88001†		†,DB	350/3,500		35	85262	RD
Silverado 1500 HD (Classic)	07	SQ3	2	37096	0	JL,RO	500/5,000	650/6,500	35	85262	RD
		RT4	2	37094	0	RO	700/7,000	1,200/12,000	25		
Silverado 1500 HD 6.6 ft. Bed (Classic)	07	SQ2		88001†		†,DB,RO	350/3,500		35	85262	RD
Silverado 2500	99-02	SQ2		88001†		†,DB	350/3,500		35	85262	RD
		RT3	2	37069	0		500/5,000	750/7,500	25		
		RT3	2	51072	0	RT,JL	500/5,000	750/7,500	15		
		RT4	2	51081	0	RT,JL	600/6,000	1,050/10,500	15		
		RT4	2	37034	0		700/7,000	1,200/12,000	25		
		RT4	2	37094	0		700/7,000	1,200/12,000	25		
		SQ4	2	37016	0		750/7,500	1,200/12,000	20		
		RT4	2	44563	0	JL,SZ	900/6,000	1,050/10,500	15		
		RT4	2	44564	0	JL	900/6,000	900/8,000	15		
		SQ5	2	96932	0	HM,JL	1,200/12,000	1,400/14,000	20		
Silverado 2500	03-04	RT3	2	37069	0		500/5,000	750/7,500	25		
		RT3	2	51072	0	RT,JL	500/5,000	750/7,500	15		
		RT4	2	51081	0	RT,JL	600/6,000	1,050/10,500	15		
		RT4	2	37034	0		700/7,000	1,200/12,000	25		
		SQ4	2	37016	0		750/7,500	1,200/12,000	20		
		RT4	2	44563	0	JL,SZ	900/6,000	1,050/10,500	15		
		RT4	2	44564	0	JL	900/6,000	900/8,000	15		
		SQ5	2	96932	0	HM,JL	1,200/12,000	1,400/14,000	20		
		SQ5	2-1/2	45009†	0	†	1,200/12,000	1,700/14,000	20		
		Silverado 2500 HD	01-02	SQ2		88001†		†,DB	350/3,500		35
SQ3	2			37096	0	JL	500/5,000	650/6,500	40		
RT3	2			51073	0	RT,CS,FS,JL,LT	500/5,000	750/7,500	20		
RT4	2			44577	0	CS,FS,JL,LT	600/6,000	1,100/11,000	20		
SQ4	2			44657	0	HM,SA	600/6,000	1,200/12,000	20		
SQ5	2			96944	0	CS,FS,HM,LT	1,950/13,000	1,600/16,000	25		
SQ5	2-1/2			45717	0	#,CS,FS,LT	1,300/13,000	1,700/17,000	25		
Silverado 2500 HD 8 ft. Bed	01-02	SQ5	2-1/2	45719	0	#,CS,FS,LT	2,000/18,000	2,500/18,000	25		
Silverado 2500 HD	03-06	SQ2		88001†		†,DB	350/3,500		35	85262	RD
		SQ3	2	37096	0	JL	500/5,000	650/6,500	40		
Silverado 2500 HD (Classic)	03-07	RT3	2	51073	0	RT,CS,FS,JL,LT	500/5,000	750/7,500	20		
		RT4	2	44577	0	CS,FS,JL,LT	600/6,000	1,100/11,000	20		
		SQ4	2	44657	0	HM,SA	600/6,000	1,200/12,000	20		
		SQ5	2	96944	0	CS,FS,HM,LT	1,950/13,000	1,600/16,000	25		
		SQ5	2-1/2	45717	0	#,CS,FS,LT	1,300/13,000	1,700/17,000	25		
Silverado 2500 HD 8 ft. Bed (Classic)	03-07	SQ5	2-1/2	45719	0	#,CS,FS,LT	2,000/18,000	2,500/18,000	25		
Silverado 2500 HD	07-10	RT3	2	51073	0	RT,CS,FS,JL,LT	500/5,000	750/7,500	20	85877	BN
		RT4	2	44577	0	CS,FS,JL,LT	600/6,000	1,100/11,000	20		
		SQ5	2	96944	0	CS,FS,HM,LT	1,950/13,000	1,600/16,000	25		
		SQ5	2-1/2	45717	0	#,CS,FS,LT	1,300/13,000	1,700/17,000	25		

#	Titan hitches require use of a 2-1/2" shank Titan ball mount.	RT	Round Tube Class III/IV 2"
†	Available while supply lasts.	SA	Requires drilling on 6 ft. bed models.
BN	Exterior mounted plug on some or all models. May require an aftermarket electrical mounting box or bracket. (Sold separately)	SZ	Hitches produced before 03/10/11 are rated at 600/6000 WC.
CS	Will fit with full-size spare tire stowed under vehicle.		
DB	Will not fit 6 ft. bed pickups.		
FS	Includes 2 & 4 WD models with heavy duty suspension.		
HM	Hitch crosstube is visible beneath bumper.		
JL	Installation requires OEM bumper and brackets.		
LT	Requires removal of factory hitch if equipped.		
0	Uses all existing holes. No drilling required.		
RD	For vehicles equipped with factory tow package may require additional components or may be used as a replacement harness.		
RO	Will not fit Silverado SS.		
RT3	Round Tube Class III 2"		
RT4	Round Tube Class IV 2"		
SQ2	Square Tube Class II		
SQ3	Square Tube Class III		
SQ4	Square Tube Class IV		
SQ5	Square Tube Class V		

C - CHEVROLET

# RECEIVER HITCH AND T-CONNECTOR APPLICATION GUIDE

MODEL / STYLE	YEAR	TRAILER HITCHES							T-CONNECTOR		
		REC TYPE	REC SIZE	PART NO.	NO DRILL	FOOTNOTES	WC (LBS.)	WD (LBS.)	IN	T-CON PART NO.	FN
<b>CHEVROLET (Continued)</b>											
Silverado 2500 HD (Classic)	07	SQ2 SQ3	2	88001† 37096	0	†,DB JL	350/3,500 500/5,000	650/6,500	35 40	85262	RD
Silverado 2500 HD 8 ft. Bed	07-10	SQ5	2-1/2	45719	0	#,CS,FS,LT	2,000/18,000	2,500/18,000	25	85877	BN
Silverado 2500 HD	11-14	SQ4	2	44653	0	CS,FS,GP,JL,LT	800/8,000	1,200/12,000	20	85877	BN
		SQ5	2	96942	0	CS,FS,GP,JL,KH,LT	1,500/15,000	1,600/16,000	20		
		SQ5	2	45710	0	CS,FS,HM,JL,KH,LT	2,000/18,000	2,500/18,000	60		
		SQ5	2-1/2	45300†	0	†,CS,FS,HM,JL,KH,LT	2,000/18,000	2,500/18,000	60		
Silverado 2500 HD	15-19	SQ4	2	44749	0	HM,JL	1,200/8,000	1,200/12,000	30	85877	BN
		SQ5	2	96950	0	CS,FS,GP,JL,KH,LT	1,700/15,000	1,700/17,000	60		
		SQ5	2	45711	0	HM	2,700/20,000	2,700/20,000	60		
Silverado 3500	01-02	RT3	2	51073	0	RT,CS,FS,JL,LT	500/5,000	750/7,500	20		
		RT4	2	44577	0	CS,FS,JL,LT	600/6,000	1,100/11,000	20		
		SQ4	2	44657	0	HM,SA	600/6,000	1,200/12,000	20		
		SQ5	2	96944	0	CS,FS,HM,LT	1,950/13,000	1,600/16,000	25		
		SQ5	2-1/2	45717	0	#,CS,FS,LT	1,300/13,000	1,700/17,000	25		
		SQ5	2-1/2	45719	0	#,CS,FS,LT	2,000/18,000	2,500/18,000	25		
Silverado 3500 8 ft. Bed	01-06	SQ2		88001†		†,DB	350/3,500		35	85262	RD
Silverado 3500 Cab & Chassis, w/34" Wide Frames (Classic)	01-07	SQ5	2	96936			1,200/12,000		30		
		SQ5	2	96938		CC	1,200/12,000	1,500/15,000	40		
		SQ5	2	96947			1,600/15,000	1,600/16,000	35		
Silverado 3500 (Classic)	03-06	SQ5	2-1/2	45717	0	#,CS,FS,LT	1,300/13,000	1,700/17,000	25		
		SQ5	2-1/2	45719	0	#,CS,FS,LT	2,000/18,000	2,500/18,000	25		
Silverado 3500 (Classic)	03-07	RT3	2	51073	0	RT,CS,FS,JL,LT	500/5,000	750/7,500	20		
		RT4	2	44577	0	CS,FS,JL,LT	600/6,000	1,100/11,000	20		
		SQ4	2	44657	0	HM,SA	600/6,000	1,200/12,000	20		
		SQ5	2	96944	0	CS,FS,HM,LT	1,950/13,000	1,600/16,000	25		
Silverado 3500 8 ft. Bed (Classic)	07	SQ2		88001†		†,DB	350/3,500		35	85262	RD
Silverado 3500 HD	07-10	RT3	2	51073	0	RT,CS,FS,JL,LT	500/5,000	750/7,500	20	85877	BN
		RT4	2	44577	0	CS,FS,JL,LT	600/6,000	1,100/11,000	20		
		SQ5	2	96944	0	CS,FS,HM,LT	1,950/13,000	1,600/16,000	25		
		SQ5	2-1/2	45717	0	#,CS,FS,LT	1,300/13,000	1,700/17,000	25		
		SQ5	2-1/2	45719	0	#,CS,FS,LT	2,000/18,000	2,500/18,000	25		
Silverado 3500 HD Cab & Chassis, w/34" Wide Frames	07-19	SQ5	2	96936			1,200/12,000		30		
		SQ5	2	96938		CC	1,200/12,000	1,500/15,000	40		
		SQ5	2	96947			1,600/15,000	1,600/16,000	35		
Silverado 3500 HD	11-14	SQ4	2	44653	0	CS,FS,GP,JL,LT	800/8,000	1,200/12,000	20	85877	BN
		SQ5	2	96942	0	CS,FS,GP,JL,KH,LT	1,500/15,000	1,600/16,000	20		
		SQ5	2	45710	0	CS,FS,HM,JL,KH,LT	2,000/18,000	2,500/18,000	60		
		SQ5	2-1/2	45300†	0	†,CS,FS,HM,JL,KH,LT	2,000/18,000	2,500/18,000	60		
Silverado 3500 HD	15-19	SQ4	2	44749	0	HM,JL	1,200/8,000	1,200/12,000	30	85877	BN
		SQ5	2	96950	0	CS,FS,GP,JL,KH,LT	1,700/15,000	1,700/17,000	60		
		SQ5	2	45711	0	HM	2,700/20,000	2,700/20,000	60		
Sonic 4 Dr. Sedan	12-16	SQ1	1-1/4	77251	0	GP	200/2,000		20	85862	CH
Sonic 5 Dr. Hatchback	12-16	SQ1	1-1/4	77265	0	HB,HM,JR	200/2,000		20	85862	CH
Sonic 4 Dr. Sedan	17-18	SQ1	1-1/4	77251	0	GP	200/2,000		20	85970	CH
Sonic 5 Dr. Hatchback	17-19	SQ1	1-1/4	77265	0	HB,HM,JR	200/2,000		20	85970	CH
Spark Except w/Ground Effects	13-15	SQ1	1-1/4	77281†		GP,JR	200/2,000		25	85802	CH
Spark	16	SQ1	1-1/4	77328	0	DU,GP,X	200/2,000		45	85930	CH
Spark	17-21	SQ1	1-1/4	77328	0	DU,GP,X	200/2,000		45		
Spark LT w/Ground Effects	13-15	SQ1	1-1/4	77282†		GP,JR	200/2,000		25	85802	CH
Suburban	92-99	SQ2		88001†		†	350/3,500		30	74180	
		SQ3	2	37042			500/5,000	600/6,000	30		
Suburban w/Amber Turn Signals	00-06	SQ2		88001†		†	350/3,500		30	85262	

#	Titan hitches require use of a 2-1/2" shank Titan ball mount.	JL	Installation requires OEM bumper and brackets.	RT3	Round Tube Class III 2"
†	Available while supply lasts.	JR	Exhaust must be temporarily lowered for installation.	RT4	Round Tube Class IV 2"
BN	Exterior mounted plug on some or all models. May require an aftermarket electrical mounting box or bracket. (Sold separately)	KH	Minor heat shield modification may be required.	SQ1	Square Tube Class I
CC	Requires minimum of 19 in. from end of frame rail to spring shackle bracket.	LT	Requires removal of factory hitch if equipped.	SQ2	Square Tube Class II
CH	T-One is equipped with circuit protected ModuLite® module.	0	Uses all existing holes. No drilling required.	SQ3	Square Tube Class III
CS	Will fit with full-size spare tire stowed under vehicle.	RD	For vehicles equipped with factory tow package may require additional components or may be used as a replacement harness.	SQ4	Square Tube Class IV
DB	Will not fit 6 ft. bed pickups.	SA	Requires drilling on 6 ft. bed models.	SQ5	Square Tube Class V
DU	Fascia removal required.	X	Minor fascia trimming required.		
FS	Includes 2 & 4 WD models with heavy duty suspension.				
GP	Hitch crosstube concealed behind bumper.				
HB	Slight fascia deformation may occur on some models.				
HM	Hitch crosstube is visible beneath bumper.				

# RECEIVER HITCH AND T-CONNECTOR APPLICATION GUIDE

RECEIVER HITCHES

MODEL / STYLE	YEAR	TRAILER HITCHES								T-CONNECTOR	
		REC TYPE	REC SIZE	PART NO.	NO DRILL	FOOTNOTES	WC (LBS.)	WD (LBS.)	IN	T-CON PART NO.	FN
<b>CHEVROLET (Continued)</b>											
Suburban w/Amber Turn Signals	03-06	SQ3	2	37042			500/5,000	600/6,000	30	85262	
Suburban 1500 w/Amber Turn Signals	00-02	SQ3	2	37152			500/5,000	600/6,000	30	85877	BN
		RT4	2	51201	0	RT,CN,HM	600/6,000	800/8,000	15		
		RT4	2	44668	0	CN,HM	900/6,000	1,000/10,000	15		
		SQ5	2	96930		CN,HM	1,000/10,000	1,200/12,000	35		
Suburban 1500 w/Amber Turn Signals	03-06	SQ3	2	37152			500/5,000	600/6,000	30	85877	BN
		RT4	2	51201	0	RT,CN,HM	600/6,000	800/8,000	15		
		RT4	2	44668	0	CN,HM	900/6,000	1,000/10,000	15		
		SQ5	2	96930		CN,HM	1,000/10,000	1,200/12,000	35		
Suburban 2500 w/Amber Turn Signals	00-02	SQ3	2	37152			500/5,000	600/6,000	30	85877	BN
		RT4	2	51201	0	RT,CN,HM	600/6,000	800/8,000	15		
		RT4	2	44668	0	CN,HM	900/6,000	1,000/10,000	15		
		SQ5	2	96930		CN,HM	1,000/10,000	1,200/12,000	35		
		SQ5	2	45715			1,200/12,000	1,700/14,000	50		
Suburban 2500 w/Amber Turn Signals	03-06	SQ3	2	37152			500/5,000	600/6,000	30	85877	BN
		RT4	2	51201	0	RT,CN,HM	600/6,000	800/8,000	15		
		RT4	2	44668	0	CN,HM	900/6,000	1,000/10,000	15		
		SQ5	2	96930		CN,HM	1,000/10,000	1,200/12,000	35		
Suburban C1500	92-99	SQ3	2	37152			500/5,000	600/6,000	30	74180	BN
		SQ3	2	44656		HM	500/5,000	750/7,500	30		
		SQ4	2	37074		HM	600/6,000	1,000/10,000	30		
Suburban C2500	92-99	SQ3	2	37152			500/5,000	600/6,000	30	74180	BN
		SQ3	2	44656		HM	500/5,000	750/7,500	30		
		SQ4	2	37074		HM	600/6,000	1,000/10,000	30		
Suburban K1500	92-99	SQ3	2	37152			500/5,000	600/6,000	30	74180	BN
		SQ3	2	44656		HM	500/5,000	750/7,500	30		
		SQ4	2	37074		HM	600/6,000	1,000/10,000	30		
Suburban K2500	92-99	SQ3	2	37152			500/5,000	600/6,000	30	74180	BN
		SQ3	2	44656		HM	500/5,000	750/7,500	30		
		SQ4	2	37074		HM	600/6,000	1,000/10,000	30		
Tahoe	95-00	SQ2		88001†		†	350/3,500		30	74180	
		SQ3	2	37042			500/5,000	600/6,000	30		
		SQ3	2	37152			500/5,000	600/6,000	30		
		SQ3	2	44656		HM	500/5,000	750/7,500	30		
		SQ4	2	37074		HM	600/6,000	1,000/10,000	30		
Tahoe w/Amber Turn Signals	00-02	SQ3	2	37152			500/5,000	600/6,000	30	85877	BN
		RT4	2	51201	0	RT,CN,HM	600/6,000	800/8,000	15		
		RT4	2	44668	0	CN,HM	900/6,000	1,000/10,000	15		
Tahoe w/Amber Turn Signals	00-06	SQ2		88001†		†	350/3,500		30	85262	
		SQ3	2	37042			500/5,000	600/6,000	30		
Tahoe w/Amber Turn Signals	03-06	SQ3	2	37152			500/5,000	600/6,000	30	85877	BN
		RT4	2	51201	0	RT,CN,HM	600/6,000	800/8,000	15		
		RT4	2	44668	0	CN,HM	900/6,000	1,000/10,000	15		
Tracker	99-04	SQ2		88001†		†	350/3,500		35	74896	HG
		SQ1	1-1/4	77023	0	HM	200/2,000		15		
		SQ3	2	33038	0	HM	350/3,500		15		
		SQ3	2	51152	0	HM	350/3,500		15		
Trailblazer	21	SQ2	1-1/4	06197	0	X,GP,AA	300/3,500		60	118825	CH
Traverse	09-12	RT3	2	51083	0	RT,GP,JR	500/5,000	500/5,000	25	78066	BN
		RT3	2	44569	0	GP,JR,TN	750/5,000	750/7,500	25		
Traverse	13-17	RT3	2	51083	0	RT,GP,JR	500/5,000	500/5,000	25	85836	BN
		RT3	2	44569	0	GP,JR,TN	750/5,000	750/7,500	25		
Traverse	18-20	SQ3	2	84184	0	DU,JR	750/5,000	750/5,000	75	85974	BN,CH

- † Available while supply lasts.
- AA Requires temporary removal of bumper during installation.
- BN Exterior mounted plug on some or all models. May require an aftermarket electrical mounting box or bracket. (Sold separately)
- CH T-One is equipped with circuit protected ModuLite® module.
- CN Requires OEM factory bumper for hitch installation.
- DU Fascia removal required.
- GP Hitch crosstube concealed behind bumper.
- HG T-One incorporates taillight converter.
- HM Hitch crosstube is visible beneath bumper.
- JR Exhaust must be temporarily lowered for installation.
- 0 Uses all existing holes. No drilling required.
- RT Round Tube Class III/IV 2"

- TN Hitches produced before 07/09/12 are rated at 500/5000 WC & 500/5000 WD.
- X Minor fascia trimming required.

- RT3 Round Tube Class III 2"
- RT4 Round Tube Class IV 2"
- SQ1 Square Tube Class I
- SQ2 Square Tube Class II
- SQ3 Square Tube Class III
- SQ4 Square Tube Class IV
- SQ5 Square Tube Class V

C - CHEVROLET

# RECEIVER HITCH AND T-CONNECTOR APPLICATION GUIDE

MODEL / STYLE	YEAR	TRAILER HITCHES							T-CONNECTOR		
		REC TYPE	REC SIZE	PART NO.	NO DRILL	FOOTNOTES	WC (LBS.)	WD (LBS.)	IN	T-CON PART NO.	FN
<b>CHEVROLET (Continued)</b>											
Trax	13-16	RT2	1-1/4	06169	0	HM,JR	300/3,500		40	85871	CH
Trax Except LS	17-20	RT2	1-1/4	06169	0	HM,JR	300/3,500		40	85966	CH
Trax LS	17-21	RT2	1-1/4	06169	0	HM,JR	300/3,500		40	85871	CH
Trax Except LS	21	RT2	1-1/4	06169	0	HM,JR	300/3,500		40		
Uplander	05-08	SQ2	1-1/4	51102		AL,GP,JR	300/3,500		40	85344	BN
		SQ3	2	44574		AL,JR	350/3,500	500/5,000	40		
		SQ3	2	51079		AL,GP,JR	350/3,500	500/5,000	40		
Uplander (Canada Only)	09	SQ2	1-1/4	51102		AL,GP,JR	300/3,500		40	85344	BN
		SQ3	2	44574		AL,JR	350/3,500	500/5,000	40		
		SQ3	2	51079		AL,GP,JR	350/3,500	500/5,000	40		
Venture	97-05	SQ1	1-1/4	77040†		†,AL,GP,JR	200/2,000		30	74207	HG
		SQ2	1-1/4	51102		AL,GP,JR	300/3,500		40		
		SQ3	2	44574		AL,JR	350/3,500	500/5,000	40		
		SQ3	2	51079		AL,GP,JR	350/3,500	500/5,000	40		
Volt	16-19	SQ1		77334	0	GP,DU,SV,JR	200/2,000		60	85938	CH,BN
<b>CHRYSLER</b>											
200 4 Dr. Sedan	11	SQ1	1-1/4	77254	0	GP,JR	200/2,000		15	85773	BN,CH
200 Convertible	11	SQ1	1-1/4	77254	0	GP,JR	200/2,000		15	85773	BN,CH
200 4 Dr. Sedan	12-14	SQ1	1-1/4	77254	0	GP,JR	200/2,000		15	85811	CH
200 Convertible	12-14	SQ1	1-1/4	77254	0	GP,JR	200/2,000		15	85811	CH
200 4 Dr. Sedan	15-18	SQ1	1-1/4	77306	0	GP,SV	200/2,000		20	85844	CH
300	05-07	SQ2	1-1/4	06946	0	HM	300/3,500		30	78040	
300	08-10	SQ2	1-1/4	06946	0	HM	300/3,500		30	78042	CH
300	11-14	SQ2	1-1/4	06946	0	HM	300/3,500		40	85832	CH
300	15-20	SQ2	1-1/4	06946	0	HM	300/3,500		30	85894	CH
300M	99-01	SQ2	1-1/4	06284†		†,HM,JR	300/3,500		30	74224	BN,HG
300M Except Special	02-04	SQ2	1-1/4	06284†		†,HM,JR	300/3,500		30	74224	BN,HG
Aspen	07-08	SQ3	2	44173			500/5,000	750/7,500	30	78027	BN,CH
		SQ3	2	51067			500/5,000	750/7,500	30		
		SQ4	2	33082		AI	600/6,000	900/9,000	50		
Aspen	09	SQ3	2	44173			500/5,000	750/7,500	30	78027	BN,CH
		SQ3	2	51067			500/5,000	750/7,500	30		
		SQ4	2	33082		AI	600/6,000	900/9,000	50		
Cirrus	95-00	SQ2	1-1/4	06977		JR,HM	300/3,500		60		
Concorde	02	SQ2	1-1/4	06281†		†,JR,GP	300/3,500		30	74224	BN,HG
Concorde	03-04	SQ2	1-1/4	06281†		†,JR,GP	300/3,500		30		
Intrepid (Canada Only)	98-04	SQ2	1-1/4	06355†		†,JR,HM	300/3,500		30	74224	BN,HG
LHS	99	SQ2	1-1/4	06281†		†,JR,GP	300/3,500		30	74224	BN,HG
LHS	00-01	SQ2	1-1/4	06281†		†,JR,GP	300/3,500		30		
Pacifica	04-08	RT3	2	44566	0	JR	350/3,500	500/5,000	45	78003	BN,CH
		RT3	2	51084	0	RT,JR	350/3,500	500/5,000	45		
Pacifica Hybrid (Needs Conversion Kit: 76046SK)	17-20	SQ2	1-1/4	06181	0	GP,JR,SV,KH,TW	300/3,500		45		
		SQ3	2	84046	0	GP,JR,SV,KH,TW	675/4,500	675/5,000	45		
Pacifica Limited	17-20	SQ2	1-1/4	06181	0	GP,JR,SV,KH,TW	300/3,500		45	85905	CH,BN
		SQ3	2	84046	0	GP,JR,SV,KH,TW	675/4,500	675/5,000	45		
Pacifica LX	17-20	SQ2	1-1/4	06181	0	GP,JR,SV,KH,TW	300/3,500		45	85921	CH,BN
		SQ3	2	84046	0	GP,JR,SV,KH,TW	675/4,500	675/5,000	45		
Pacifica Touring	17-20	SQ2	1-1/4	06181	0	GP,JR,SV,KH,TW	300/3,500		45	85921	CH,BN
		SQ3	2	84046	0	GP,JR,SV,KH,TW	675/4,500	675/5,000	45		
Pacifica Touring L	17-20	SQ2	1-1/4	06181	0	GP,JR,SV,KH,TW	300/3,500		45	85905	CH,BN
		SQ3	2	84046	0	GP,JR,SV,KH,TW	675/4,500	675/5,000	45		
Pacifica Touring L Plus	17-20	SQ2	1-1/4	06181	0	GP,JR,SV,KH,TW	300/3,500		45	85905	CH,BN
		SQ3	2	84046	0	GP,JR,SV,KH,TW	675/4,500	675/5,000	45		

†	Available while supply lasts.	RT	Round Tube Class III/IV 2"
AI	Additional installation time may be required.	SV	Trimming or removal of under body appearance panel may be required.
AL	Additional installation time required for vehicles equipped with load leveling compressor.	TW	Receiver hitch may limit hands-free liftgate sensor range
BN	Exterior mounted plug on some or all models. May require an aftermarket electrical mounting box or bracket. (Sold separately)		
CH	T-One is equipped with circuit protected ModuLite® module.		
DU	Fascia removal required.		
GP	Hitch cross-tube concealed behind bumper.		
HG	T-One incorporates taillight converter.		
HM	Hitch cross-tube is visible beneath bumper.		
JR	Exhaust must be temporarily lowered for installation.		
KH	Minor heat shield modification may be required.		
0	Uses all existing holes. No drilling required.		
RT2	Round Tube Class II 1-1/4"		
RT3	Round Tube Class III 2"		
SQ1	Square Tube Class I		
SQ2	Square Tube Class II		
SQ3	Square Tube Class III		
SQ4	Square Tube Class IV		

# RECEIVER HITCH AND T-CONNECTOR APPLICATION GUIDE

RECEIVER HITCHES

MODEL / STYLE	YEAR	TRAILER HITCHES								T-CONNECTOR	
		REC TYPE	REC SIZE	PART NO.	NO DRILL	FOOTNOTES	WC (LBS.)	WD (LBS.)	IN	T-CON PART NO.	FN
<b>CHRYSLER (Continued)</b>											
Pacifica Touring Plus	17-20	SQ2	1-1/4	06181	0	GP, JR, SV, KH, TW	300/3,500		45	85905	CH, BN
		SQ3	2	84046	0	GP, JR, SV, KH, TW	675/4,500	675/5,000	45		
PT Cruiser	01-04	SQ1	1-1/4	77135		JR, GP	200/2,000		30	78021	BN, CH
PT Cruiser	05-10	SQ1	1-1/4	77135		JR, GP	200/2,000		30	78021	BN, CH
PT Cruiser Convertible	05-09	SQ1	1-1/4	77135		JR, GP	200/2,000		30		
Sebring 4 Dr.	01-06	SQ2	1-1/4	06977		JR, HM	300/3,500		60		
Sebring Convertible	01-06	SQ1	1-1/4	77092†		GP	200/2,000		15		
Sebring Convertible	07-10	SQ1	1-1/4	77254	0	GP, JR	200/2,000		15	74721	BN, CH
Sebring Except Convertible	07-10	SQ1	1-1/4	77254	0	GP, JR	200/2,000		15	74721	BN, CH
		SQ2	1-1/4	06526		GP, JR	300/3,500		30		
Town & Country	96-00	SQ2		88001†		†	350/3,500		45	74658	HG
		RT3	2	33045†		†	350/3,500	500/5,000	30		
		SQ3	2	44006		HM	350/3,500	400/3,500	30		
		SQ3	2	51062		HM	350/3,500	400/3,500	30		
		SQ3	2	37042			500/5,000	600/6,000	40		
		SQ3	2	37152			500/5,000	600/6,000	40		
Town & Country	01-03	SQ2		88001†		†	350/3,500		45	85245	HG
		RT3	2	33045†	0	†	350/3,500	500/5,000	30		
		SQ3	2	44006		HM	350/3,500	400/3,500	30		
		SQ3	2	51062		HM	350/3,500	400/3,500	30		
		SQ3	2	37042			500/5,000	600/6,000	40		
		SQ3	2	37152			500/5,000	600/6,000	40		
Town & Country Except w/Stow & Go Seats	04-07	SQ2		88001†		†	350/3,500		45		
		RT3	2	33045†	0	†	350/3,500	500/5,000	30		
		SQ3	2	44006		HM	350/3,500	400/3,500	30		
		SQ3	2	51062		HM	350/3,500	400/3,500	30		
		SQ3	2	37042			500/5,000	600/6,000	40		
		SQ3	2	37152			500/5,000	600/6,000	40		
Town & Country w/Stow & Go Seats	05-07	SQ2	1-1/4	06992	0	HM	300/3,500		25	78000	
		SQ3	2	44176	0		350/3,500	400/4,000	25		
Town & Country	08-10	SQ2	1-1/4	06550	0	GP, JR	300/3,500		20	85775	CH
		SQ2	1-1/4	51192	0	GP, JR	300/3,500		20		
		SQ3	2	44586	0	GP, JR	400/4,000	500/5,000	20		
		SQ3	2	51203	0	GP, JR	400/4,000	400/4,000	20		
Town & Country	11-16	SQ2	1-1/4	06550	0	GP, JR	300/3,500		20	85777	BN, CH
		SQ2	1-1/4	51192	0	GP, JR	300/3,500		20		
		SQ3	2	44586	0	GP, JR	400/4,000	500/5,000	20		
		SQ3	2	51203	0	GP, JR	400/4,000	400/4,000	20		
Voyager	01-03	SQ2		88001†		†	350/3,500		45	85245	HG
		RT3	2	33045†	0	†	350/3,500	500/5,000	30		
		SQ3	2	44006		HM	350/3,500	400/3,500	30		
		SQ3	2	51062		HM	350/3,500	400/3,500	30		
		SQ3	2	37042			500/5,000	600/6,000	40		
		SQ3	2	37152			500/5,000	600/6,000	40		
<b>DODGE</b>											
Avenger	08-10	SQ1	1-1/4	77254	0	GP, JR	200/2,000		15	74722	BN, CH
		SQ2	1-1/4	06526		GP, JR	300/3,500		30		
Avenger	11	SQ1	1-1/4	77254	0	GP, JR	200/2,000		15	85773	BN, CH
Avenger	12-14	SQ1	1-1/4	77254	0	GP, JR	200/2,000		15	85811	CH
Caliber	07	SQ1	1-1/4	77145	0	GP	200/2,000		15	74705	BN, CH
Caliber Except SRT-4	08-12	SQ1	1-1/4	77145	0	GP	200/2,000		15	85775	CH

- † Available while supply lasts.
- BN Exterior mounted plug on some or all models. May require an aftermarket electrical mounting box or bracket. (Sold separately)
- CH T-One is equipped with circuit protected ModuLite® module.
- GP Hitch cross tube concealed behind bumper.
- HG T-One incorporates taillight converter.
- HM Hitch cross tube is visible beneath bumper.
- JR Exhaust must be temporarily lowered for installation.
- KH Minor heat shield modification may be required.
- 0 Uses all existing holes. No drilling required.
- SV Trimming or removal of under body appearance panel may be required.
- TW Receiver hitch may limit hands-free liftgate sensor range

- RT3 Round Tube Class III 2"
- SQ1 Square Tube Class I
- SQ2 Square Tube Class II
- SQ3 Square Tube Class III



# RECEIVER HITCH AND T-CONNECTOR APPLICATION GUIDE

MODEL / STYLE	YEAR	TRAILER HITCHES								T-CONNECTOR	
		REC TYPE	REC SIZE	PART NO.	NO DRILL	FOOTNOTES	WC (LBS.)	WD (LBS.)	IN	T-CON PART NO.	FN
<b>DODGE (Continued)</b>											
Caravan	96-00	SQ2		88001†		†	350/3,500		45	74658	HG
		RT3	2	33045†		†	350/3,500	500/5,000	30		
		SQ3	2	44006		HM	350/3,500	400/3,500	30		
		SQ3	2	51062		HM	350/3,500	400/3,500	30		
		SQ3	2	37042			500/5,000	600/6,000	40		
		SQ3	2	37152			500/5,000	600/6,000	40		
Caravan	01-03	SQ2		88001†		†	350/3,500		45	85245	HG
		RT3	2	33045†	0	†	350/3,500	500/5,000	30		
		SQ3	2	44006		HM	350/3,500	400/3,500	30		
		SQ3	2	51062		HM	350/3,500	400/3,500	30		
		SQ3	2	37042			500/5,000	600/6,000	40		
		SQ3	2	37152			500/5,000	600/6,000	40		
Caravan Except w/Stow & Go Seats	04-07	SQ2		88001†		†	350/3,500		45		
		RT3	2	33045†	0	†	350/3,500	500/5,000	30		
		SQ3	2	44006		HM	350/3,500	400/3,500	30		
		SQ3	2	51062		HM	350/3,500	400/3,500	30		
		SQ3	2	37042			500/5,000	600/6,000	40		
		SQ3	2	37152			500/5,000	600/6,000	40		
Challenger Except Models w/Quad Tip Exhaust	08-14	SQ2	1-1/4	06946	0	HM	300/3,500		30	78040	
		SQ3	2	84145	0	HM	675/4,500		30		
Challenger Except Models w/Quad Tip Exhaust	15-20	SQ2	1-1/4	06946	0	HM	300/3,500		30	85880	CH
		SQ3	2	84145	0	HM	675/4,500		30		
Challenger Except Models w/Quad Tip Exhaust	20	SQ3	2	84145	0	HM	675/4,500		30		CH
Charger	06-10	SQ2	1-1/4	06946	0	HM	300/3,500		30	78040	
		SQ3	2	84145	0	HM	675/4,500		30		
Charger	11-14	SQ2	1-1/4	06946	0	HM	300/3,500		30	85790	CH
		SQ3	2	84145	0	HM	675/4,500		30		
Charger	15-20	SQ2	1-1/4	06946	0	HM	300/3,500		30	85870	CH
		SQ3	2	84145	0	HM	675/4,500		30		
Dakota	96-01	SQ2		88001†		†,CT,GU	350/3,500		40	74475	HJ
		SQ3	2	37042		CT,GU	500/5,000	600/6,000	35		
Dakota	97-99	SQ3	2	44102	0	GU	300/3,500	500/5,000	30	74475	BN,HJ
		SQ3	2	51025	0	GU	300/3,500	500/5,000	30		
		SQ3	2	36047	0	GU	500/5,000	700/7,000	30		
		SQ3	2	37152	0	CT,GU	500/5,000	600/6,000	35		
Dakota	00-01	SQ3	2	44102	0	GU	300/3,500	500/5,000	30	74475	BN,HJ
		SQ3	2	51025	0	GU	300/3,500	500/5,000	30		
		SQ3	2	36047	0	GU	500/5,000	700/7,000	30		
		SQ3	2	37152	0	CT,GU	500/5,000	600/6,000	35		
Dakota	02-03	SQ3	2	36047	0	GU	500/5,000	700/7,000	30	74475	BN,HJ
Dakota Except Quad Cab	02-03	SQ2		88001†		†,CT,GU	350/3,500		40	74475	HJ
		SQ3	2	44102	0	GU	300/3,500	500/5,000	30		
		SQ3	2	51025	0	GU	300/3,500	500/5,000	30		
		SQ3	2	37042	0	CT,GU	500/5,000	600/6,000	35		
		SQ3	2	37152	0	CT,GU	500/5,000	600/6,000	35		
Dakota	04	SQ3	2	36047	0	GU	500/5,000	700/7,000	30	74187	BN,HJ
Dakota Except Quad Cab	04	SQ2		88001†		†,CT,GU	350/3,500		40	74187	HJ
		SQ3	2	44102	0	GU	300/3,500	500/5,000	30		
		SQ3	2	51025	0	GU	300/3,500	500/5,000	30		
		SQ3	2	37042	0	CT,GU	500/5,000	600/6,000	35		
		SQ3	2	37152	0	CT,GU	500/5,000	600/6,000	35		
Dakota	05-09	SQ3	2	33092	0	HM	500/5,000	800/8,000	20	74187	BN,HJ
		SQ3	2	51138	0	HM	500/5,000	800/8,000	20		

† Available while supply lasts.

BN Exterior mounted plug on some or all models. May require an aftermarket electrical mounting box or bracket. (Sold separately)

CH T-One is equipped with circuit protected ModuLite® module.

CT Will not fit long bed models after 1999.

GU Will not fit vehicles with factory or aftermarket lower Fascia/Rollpan or Tube Bumper.

HG T-One incorporates taillight converter.

HJ Per Dodge owner's manual: If trailer is equipped with more than standard lighting (1 taillight per side) use of ModuLite® or dealer supplied harness is required.

HM Hitch cross-tube is visible beneath bumper.

0 Uses all existing holes. No drilling required.

RT3 Round Tube Class III 2"

SQ2 Square Tube Class II

SQ3 Square Tube Class III

# RECEIVER HITCH AND T-CONNECTOR APPLICATION GUIDE

RECEIVER HITCHES

MODEL / STYLE	YEAR	TRAILER HITCHES								T-CONNECTOR	
		REC TYPE	REC SIZE	PART NO.	NO DRILL	FOOTNOTES	WC (LBS.)	WD (LBS.)	IN	T-CON PART NO.	FN
<b>DODGE (Continued)</b>											
<b>Dakota</b>	<b>10</b>	SQ3	2	<b>33092</b>	0	HM	500/5,000	800/8,000	20	<b>74187</b>	BN,HJ
		SQ3	2	<b>51138</b>	0	HM	500/5,000	800/8,000	20		
<b>Dart</b>	<b>13-16</b>	SQ1	1-1/4	<b>77278</b>	0	HM	200/2,000		20	<b>85799</b>	
<b>Durango</b>	<b>98-99</b>	SQ3	2	<b>44064</b>	0		300/3,500	500/5,000	20	<b>74658</b>	BN,HG
		SQ3	2	<b>51035</b>	0		300/3,500	500/5,000	15		
		SQ3	2	<b>44733</b>	0		500/5,000	750/7,500	30		
<b>Durango</b>	<b>00-03</b>	SQ3	2	<b>44064</b>	0		300/3,500	500/5,000	20	<b>74658</b>	BN,HG
		SQ3	2	<b>51035</b>	0		300/3,500	500/5,000	15		
		SQ3	2	<b>44733</b>	0		500/5,000	750/7,500	30		
<b>Durango</b>	<b>04-06</b>	SQ3	2	<b>44173</b>			500/5,000	750/7,500	30	<b>78027</b>	BN,CH
		SQ3	2	<b>51067</b>			500/5,000	750/7,500	30		
		SQ4	2	<b>33082</b>		AI	600/6,000	900/9,000	50		
		RT4	2	<b>44175</b>	0		600/6,000	900/9,000	20		
<b>Durango</b>	<b>07-08</b>	SQ3	2	<b>44173</b>			500/5,000	750/7,500	30	<b>78027</b>	BN,CH
		SQ3	2	<b>51067</b>			500/5,000	750/7,500	30		
		SQ4	2	<b>33082</b>		AI	600/6,000	900/9,000	50		
<b>Durango</b>	<b>09</b>	SQ3	2	<b>44173</b>			500/5,000	750/7,500	30	<b>78027</b>	BN,CH
		SQ3	2	<b>51067</b>			500/5,000	750/7,500	30		
		SQ4	2	<b>33082</b>		AI	600/6,000	900/9,000	50		
<b>Durango</b>	<b>11-13</b>	RT4	2	<b>44662</b>	0	CS,HM	900/6,000	900/7,500	20	<b>85775</b>	CH
		SQ4	2	<b>84196</b>	0	DU,GP,JR,TZ	900/6,000	900/7,500	90		
<b>Durango</b>	<b>14-20</b>	RT4	2	<b>44662</b>	0	CS,HM	900/6,000	900/7,500	20	<b>85838</b>	CH,BN
		SQ4	2	<b>84196</b>	0	DU,GP,JR,TZ	900/6,000	900/7,500	90		
<b>Durango</b>	<b>21</b>	RT4	2	<b>44662</b>	0	CS,HM	900/6,000	900/7,500	20	<b>85838</b>	CH,BN
		SQ4	2	<b>84196</b>	0	DU,GP,JR,TZ	900/6,000	900/7,500	90		
<b>Grand Caravan</b>	<b>96-00</b>	SQ2		<b>88001†</b>		†	350/3,500		45	<b>74658</b>	HG
		RT3	2	<b>33045†</b>		†	350/3,500	500/5,000	30		
		SQ3	2	<b>44006</b>		HM	350/3,500	400/3,500	30		
		SQ3	2	<b>51062</b>		HM	350/3,500	400/3,500	30		
		SQ3	2	<b>37042</b>			500/5,000	600/6,000	40		
		SQ3	2	<b>37152</b>			500/5,000	600/6,000	40		
<b>Grand Caravan</b>	<b>01-03</b>	SQ2		<b>88001†</b>		†	350/3,500		45	<b>85245</b>	HG
		RT3	2	<b>33045†</b>	0	†	350/3,500	500/5,000	30		
		SQ3	2	<b>44006</b>		HM	350/3,500	400/3,500	30		
		SQ3	2	<b>51062</b>		HM	350/3,500	400/3,500	30		
		SQ3	2	<b>37042</b>			500/5,000	600/6,000	40		
		SQ3	2	<b>37152</b>			500/5,000	600/6,000	40		
<b>Grand Caravan Except w/Stow &amp; Go Seats</b>	<b>04-07</b>	SQ2		<b>88001†</b>		†	350/3,500		45		
		RT3	2	<b>33045†</b>	0	†	350/3,500	500/5,000	30		
		SQ3	2	<b>44006</b>		HM	350/3,500	400/3,500	30		
		SQ3	2	<b>51062</b>		HM	350/3,500	400/3,500	30		
		SQ3	2	<b>37042</b>			500/5,000	600/6,000	40		
		SQ3	2	<b>37152</b>			500/5,000	600/6,000	40		
<b>Grand Caravan w/Stow &amp; Go Seats</b>	<b>05-07</b>	SQ2	1-1/4	<b>06992</b>	0	HM	300/3,500		25	<b>78000</b>	
		SQ3	2	<b>44176</b>	0		350/3,500	400/4,000	25		
<b>Grand Caravan</b>	<b>08-10</b>	SQ2	1-1/4	<b>06550</b>	0	GP,JR	300/3,500		20	<b>85775</b>	CH
		SQ2	1-1/4	<b>51192</b>	0	GP,JR	300/3,500		20		
		SQ3	2	<b>44586</b>	0	GP,JR	400/4,000	500/5,000	20		
		SQ3	2	<b>51203</b>	0	GP,JR	400/4,000	400/4,000	20		
<b>Grand Caravan</b>	<b>11-20</b>	SQ2	1-1/4	<b>06550</b>	0	GP,JR	300/3,500		20	<b>85777</b>	BN,CH
		SQ2	1-1/4	<b>51192</b>	0	GP,JR	300/3,500		20		
		SQ3	2	<b>44586</b>	0	GP,JR	400/4,000	500/5,000	20		
		SQ3	2	<b>51203</b>	0	GP,JR	400/4,000	400/4,000	20		

† Available while supply lasts.

AI Additional installation time may be required.

BN Exterior mounted plug on some or all models. May require an aftermarket electrical mounting box or bracket. (Sold separately)

CH T-One is equipped with circuit protected ModuLite® module.

CS Will fit with full-size spare tire stowed under vehicle.

DU Fascia removal required.

GP Hitch cross-tube concealed behind bumper.

HG T-One incorporates taillight converter.

HJ Per Dodge owner's manual: If trailer is equipped with more than standard lighting (1 taillight per side) use of ModuLite® or dealer supplied harness is required.

HM Hitch cross-tube is visible beneath bumper.

JR Exhaust must be temporarily lowered for installation.

0 Uses all existing holes. No drilling required.

TZ Requires replacement of the impact structure with hitch.

**RT3** Round Tube Class III 2"

**RT4** Round Tube Class IV 2"

**SQ1** Square Tube Class I

**SQ2** Square Tube Class II

**SQ3** Square Tube Class III

**SQ4** Square Tube Class IV

D - DODGE

# RECEIVER HITCH AND T-CONNECTOR APPLICATION GUIDE

MODEL / STYLE	YEAR	TRAILER HITCHES							T-CONNECTOR		
		REC TYPE	REC SIZE	PART NO.	NO DRILL	FOOTNOTES	WC (LBS.)	WD (LBS.)	IN	T-CON PART NO.	FN
<b>DODGE (Continued)</b>											
Intrepid	98-04	SQ2	1-1/4	06355†		†,JR,HM	300/3,500		30	74224	BN,HG
Journey	09	RT3	2	44601	0	HM,JR	400/4,000	400/4,000	25	78086	CH
		RT3	2	51208	0	RT,HM,JR	400/4,000	400/4,000	25		
		RT3	2	97208	0	HM,JR	400/4,000	400/4,000	25		
		SQ3	2	84225	0	DU,FE,GP,JR,TZ	525/3,500		90		
Journey	10	RT3	2	44601	0	HM,JR	400/4,000	400/4,000	25	85717	
		RT3	2	51208	0	RT,HM,JR	400/4,000	400/4,000	25		
		RT3	2	97208	0	HM,JR	400/4,000	400/4,000	25		
		SQ3	2	84225	0	DU,FE,GP,JR,TZ	525/3,500		90		
Journey w/LED Taillights	11-20	RT3	2	44601	0	HM,JR	400/4,000	400/4,000	25	85796	CH
		RT3	2	51208	0	RT,HM,JR	400/4,000	400/4,000	25		
		RT3	2	97208	0	HM,JR	400/4,000	400/4,000	25		
		SQ3	2	84225	0	DU,FE,GP,JR,TZ	525/3,500		90		
Journey Except w/LED Taillights	12-20	RT3	2	44601	0	HM,JR	400/4,000	400/4,000	25	85809	CH
		RT3	2	51208	0	RT,HM,JR	400/4,000	400/4,000	25		
		RT3	2	97208	0	HM,JR	400/4,000	400/4,000	25		
		SQ3	2	84225	0	DU,FE,GP,JR,TZ	525/3,500		90		
Magnum	05-08	SQ2	1-1/4	06946	0	HM	300/3,500		30	78039	BN,CH
		SQ3	2	84145	0	HM	675/4,500		30		
Neon	00-05	SQ1	1-1/4	77052†		†,GP,JR	200/2,000		20		
Nitro	07	SQ3	2	44559	0	GP	500/5,000	600/6,000	20	85787	BN,CH
		SQ3	2	51089	0	GP	500/5,000	600/6,000	20		
Nitro	08-11	SQ3	2	44559	0	GP	500/5,000	600/6,000	20	85787	BN,CH
		SQ3	2	51089	0	GP	500/5,000	600/6,000	20		
Ram	99	SQ2		88001†		†,GU	350/3,500		30	74475	HJ
		SQ3	2	37096		JL	500/5,000	650/6,500	45		
Ram	00-01	SQ2		88001†		†,GU	350/3,500		30	74475	HJ
		SQ3	2	37096		JL	500/5,000	650/6,500	45		
Ram 2500/3500	02	SQ2		88001†		†,GU	350/3,500		30	74475	HJ
		SQ3	2	37096		JL	500/5,000	650/6,500	45		
Ram 1500	95-01	RT3	2	37069		GU	500/5,000	750/7,500	40	74475	BN,HJ
		SQ3	2	44103		GU	500/5,000	1,000/10,000	20		
		SQ3	2	51016		HM,FP	500/5,000	1,000/10,000	40		
		SQ3	2	51039			500/5,000	1,000/10,000	15		
		RT4	2	37034		GU	700/7,000	1,200/12,000	40		
		SQ5	2	96923	0	GP	1,200/12,000	1,400/14,000	35		
Ram 1500 w/Deep Drop Bumper	95-01	SQ3	2	37081		CQ	500/5,000	1,000/10,000	40	74475	BN,HJ
Ram 1500	99	RT4	2	37094		GU	700/7,000	1,200/12,000	40	74475	HJ
Ram 1500	00-01	RT4	2	37094		GU	700/7,000	1,200/12,000	40	74475	HJ
Ram 1500 (Built Before 11/2002)	02-03	SQ3	2	37084	0	CP,DS,GU	500/5,000	1,000/10,000	20		
Ram 1500 (Built After 11/2002)	03	SQ3	2	33072	0	CP,DS,GU	500/5,000	800/8,000	20		
		SQ3	2	44738	0	CP,DS,GU	500/5,000	800/8,000	20		
		SQ3	2	51143	0	CP,DS,GU	500/5,000	800/8,000	20		
		SQ4	2	44536	0	CP,DY	600/6,000	1,000/10,000	25		
		SQ4	2	44603	0	CP,DS	600/6,000	1,000/10,000	20		
		SQ5	2	96929		DY,GP,KL,SG	1,200/12,000	1,500/15,000	35		
		SQ5	2-1/2	45288†		†,DY,KL,SB	1,200/12,000	1,700/14,000	35		
		SQ5	2-1/2	45718		#,DY,KL,SB	1,200/12,000	1,700/14,000	35		

**#** Titan hitches require use of a 2-1/2" shank Titan ball mount.  
**†** Available while supply lasts.  
**BN** Exterior mounted plug on some or all models. May require an aftermarket electrical mounting box or bracket. (Sold separately)  
**CH** T-One is equipped with circuit protected ModuLite® module.  
**CP** Fits all models without factory installed receiver.  
**CQ** Will not fit with heavy duty suspension.  
**DS** Use DT #75151 On 1500 Models Built After 11/1/02. Use DT #75135 On 1500 Models Built Before 11/1/02.  
**DU** Fascia removal required.  
**DY** Use On 1500 Models Built After 11/1/02.  
**FE** Fascia trimming may be required. Allow additional installation time.  
**FP** Spare tire repositioning and/or modification of spare tire carrier may be required.  
**GP** Hitch cross-tube concealed behind bumper.

**GU** Will not fit vehicles with factory or aftermarket lower Fascia/Rollpan or Tube Bumper.  
**HG** T-One incorporates taillight converter.  
**HJ** Per Dodge owner's manual: If trailer is equipped with more than standard lighting (1 taillight per side) use of ModuLite® or dealer supplied harness is required.  
**HM** Hitch cross-tube is visible beneath bumper.  
**JL** Installation requires OEM bumper and brackets.  
**JR** Exhaust must be temporarily lowered for installation.  
**KL** Hitch is designed to attach beneath the OEM hitch.  
**O** Uses all existing holes. No drilling required.  
**RT** Round Tube Class III/IV 2"  
**SB** Will not fit models with short bed.  
**SG** Hitches produced before 09/10/07 are rated at 1000/10000 WC & 1200/12000 WD.  
**TZ** Requires replacement of the impact structure with hitch.

**RT3** Round Tube Class III 2"  
**RT4** Round Tube Class IV 2"  
**SQ1** Square Tube Class I  
**SQ2** Square Tube Class II  
**SQ3** Square Tube Class III  
**SQ4** Square Tube Class IV  
**SQ5** Square Tube Class V

MODEL / STYLE	YEAR	TRAILER HITCHES								T-CONNECTOR	
		REC TYPE	REC SIZE	PART NO.	NO DRILL	FOOTNOTES	WC (LBS.)	WD (LBS.)	IN	T-CON PART NO.	FN
<b>DODGE (Continued)</b>											
Ram 1500 Except Daytona/Hemi Sport Quad Cab/Ram Rumble Bee/SRT-10	04-05	SQ3	2	33072	0	CP,GU	500/5,000	800/8,000	20		
		SQ3	2	44738	0	CP,GU	500/5,000	800/8,000	20		
		SQ3	2	51143	0	CP,GU	500/5,000	800/8,000	20		
		SQ4	2	44536	0	CP	600/6,000	1,000/10,000	25		
		SQ4	2	44603	0	CP	600/6,000	1,000/10,000	20		
		SQ5	2	96929		GP,KL,SG	1,200/12,000	1,500/15,000	35		
		SQ5	2-1/2	45288†		†,KL,SB	1,200/12,000	1,700/14,000	35		
Ram 1500	06-08	SQ3	2	33072	0	CP,GU	500/5,000	800/8,000	20		
		SQ3	2	44738	0	CP,GU	500/5,000	800/8,000	20		
		SQ3	2	51143	0	CP,GU	500/5,000	800/8,000	20		
		SQ4	2	44536	0	CP	600/6,000	1,000/10,000	25		
		SQ4	2	44603	0	CP	600/6,000	1,000/10,000	20		
		SQ5	2	96929		GP,KL,SG	1,200/12,000	1,500/15,000	35		
		SQ5	2-1/2	45288†		†,KL,SB	1,200/12,000	1,700/14,000	35		
Ram 1500	09	SQ4	2	44603	0	CP	600/6,000	1,000/10,000	20		
		SQ4	2	44603	0	CP	600/6,000	1,000/10,000	20		
Ram 2500	95-02	RT3	2	37069		GU	500/5,000	750/7,500	40	74475	BN,HJ
Ram 2500	95-02	SQ3	2	44103		GU	500/5,000	1,000/10,000	20		
		SQ3	2	51016		HM,FP	500/5,000	1,000/10,000	40		
		SQ3	2	51039			500/5,000	1,000/10,000	15		
		RT4	2	37034		GU	700/7,000	1,200/12,000	40		
		SQ5	2	96923	0	GP	1,200/12,000	1,400/14,000	35		
Ram 2500 w/Deep Drop Bumper	95-02	SQ3	2	37081		CQ	500/5,000	1,000/10,000	40	74475	BN,HJ
Ram 2500	99	RT4	2	37094		GU	700/7,000	1,200/12,000	40	74475	HJ
Ram 2500	99-02	SQ5	2	45713			1,200/12,000	1,700/14,000	30	74475	BN,HJ
Ram 2500	00-01	RT4	2	37094		GU	700/7,000	1,200/12,000	40	74475	HJ
Ram 2500	02	RT4	2	37094		GU	700/7,000	1,200/12,000	40	74475	HJ
Ram 2500	03-05	SQ3	2	33072	0	CP,GU	500/5,000	800/8,000	20		
		SQ3	2	44738	0	CP,GU	500/5,000	800/8,000	20		
		SQ3	2	51143	0	CP,GU	500/5,000	800/8,000	20		
		SQ4	2	44536	0	CP	600/6,000	1,000/10,000	25		
		SQ4	2	44603	0	CP	600/6,000	1,000/10,000	20		
		SQ5	2	96929		GP,KL,SG	1,200/12,000	1,500/15,000	35		
		SQ5	2	45709		AA,GH,HM,LT,SO,TO	2,000/18,000	2,500/18,000	95		
		SQ5	2-1/2	45288†		†,KL,SB	1,200/12,000	1,700/14,000	35		
		SQ5	2-1/2	45718		#,KL,SB	1,200/12,000	1,700/14,000	35		
		SQ5	2-1/2	45299†		†,AA,GH,HM,LT,SO,TO	2,000/18,000	2,500/18,000	95		
Ram 2500	06-09	SQ3	2	33072	0	CP,GU	500/5,000	800/8,000	20		
		SQ3	2	44738	0	CP,GU	500/5,000	800/8,000	20		
		SQ3	2	51143	0	CP,GU	500/5,000	800/8,000	20		
		SQ4	2	44536	0	CP	600/6,000	1,000/10,000	25		
		SQ4	2	44603	0	CP	600/6,000	1,000/10,000	20		
		SQ5	2	96929		GP,KL,SG	1,200/12,000	1,500/15,000	35		
		SQ5	2	45709		AA,GH,HM,LT,SO,TO	2,000/18,000	2,500/18,000	95		
Ram 2500 Except Mega Cab	06-09	SQ5	2-1/2	45288†		†,KL,SB	1,200/12,000	1,700/14,000	35		
		SQ5	2-1/2	45718		#,KL,SB	1,200/12,000	1,700/14,000	35		
Ram 2500	10	SQ5	2	96929		GP,KL,SG	1,200/12,000	1,500/15,000	35		
		SQ5	2	45709		AA,GH,HM,LT,SO,TO	2,000/18,000	2,500/18,000	95		
		SQ5	2-1/2	45299†		†,AA,GH,HM,LT,SO,TO	2,000/18,000	2,500/18,000	95		

# Titan hitches require use of a 2-1/2" shank Titan ball mount.  
 † Available while supply lasts.  
 AA Requires temporary removal of bumper during installation.  
 BN Exterior mounted plug on some or all models. May require an aftermarket electrical mounting box or bracket. (Sold separately)  
 CP Fits all models without factory installed receiver.  
 CQ Will not fit with heavy duty suspension.  
 FP Spare tire repositioning and/or modification of spare tire carrier may be required.  
 GH Will not fit models with 34 in. wide frames.  
 GP Hitch cross-tube concealed behind bumper.  
 GU Will not fit vehicles with factory or aftermarket lower Fascia/Rollpan or Tube Bumper.  
 HJ Per Dodge owner's manual: If trailer is equipped with more than standard lighting (1 taillight per side) use of ModuLite® or dealer supplied harness is required.

KL Hitch is designed to attach beneath the OEM hitch.  
 LT Requires removal of factory hitch if equipped.  
 0 Uses all existing holes. No drilling required.  
 SB Will not fit models with short bed.  
 SG Hitches produced before 09/10/07 are rated at 1000/10000 WC & 1200/12000 WD.  
 SO With this hitch installed the step bumper is no longer able to be used as a towing point.  
 TO Will not fit models equipped Chassis Cab spring mount.

RT3 Round Tube Class III 2"  
 RT4 Round Tube Class IV 2"  
 SQ3 Square Tube Class III  
 SQ4 Square Tube Class IV  
 SQ5 Square Tube Class V

# RECEIVER HITCH AND T-CONNECTOR APPLICATION GUIDE

MODEL / STYLE	YEAR	TRAILER HITCHES							T-CONNECTOR		
		REC TYPE	REC SIZE	PART NO.	NO DRILL	FOOTNOTES	WC (LBS.)	WD (LBS.)	IN	T-CON PART NO.	FN
<b>DODGE (Continued)</b>											
Ram 2500 Except Mega Cab	10	SQ5	2-1/2	45288†		†,KL,SB	1,200/12,000	1,700/14,000	35		
		SQ5	2-1/2	45718		#,KL,SB	1,200/12,000	1,700/14,000	35		
Ram 3500	95-02	RT3	2	37069		GU	500/5,000	750/7,500	40	74475	BN,HJ
		SQ3	2	44103		GU	500/5,000	1,000/10,000	20		
		SQ3	2	51016		HM,FP	500/5,000	1,000/10,000	40		
		SQ3	2	51039			500/5,000	1,000/10,000	15		
		RT4	2	37034		GU	700/7,000	1,200/12,000	40		
		SQ5	2	96923	Ø	GP	1,200/12,000	1,400/14,000	35		
Ram 3500 w/Deep Drop Bumper	95-02	SQ3	2	37081		CQ	500/5,000	1,000/10,000	40	74475	BN,HJ
Ram 3500	99	RT4	2	37094		GU	700/7,000	1,200/12,000	40	74475	HJ
Ram 3500	99-02	SQ5	2	45713			1,200/12,000	1,700/14,000	30	74475	BN,HJ
Ram 3500	00-01	RT4	2	37094		GU	700/7,000	1,200/12,000	40	74475	HJ
Ram 3500	02	RT4	2	37094		GU	700/7,000	1,200/12,000	40	74475	HJ
Ram 3500	03-05	SQ3	2	33072	Ø	CP,GU	500/5,000	800/8,000	20		
		SQ3	2	44738	Ø	CP,GU	500/5,000	800/8,000	20		
		SQ3	2	51143	Ø	CP,GU	500/5,000	800/8,000	20		
		SQ4	2	44536	Ø	CP	600/6,000	1,000/10,000	25		
		SQ4	2	44603	Ø	CP	600/6,000	1,000/10,000	20		
		SQ5	2	96929		GP,KL,SG	1,200/12,000	1,500/15,000	35		
		SQ5	2	45709		AA,GH,HM,LT,SO,TO	2,000/18,000	2,500/18,000	95		
		SQ5	2-1/2	45288†		†,KL,SB	1,200/12,000	1,700/14,000	35		
		SQ5	2-1/2	45718		#,KL,SB	1,200/12,000	1,700/14,000	35		
		SQ5	2-1/2	45299†		†,AA,GH,HM,LT,SO,TO	2,000/18,000	2,500/18,000	95		
Ram 3500	06-09	SQ3	2	33072	Ø	CP,GU	500/5,000	800/8,000	20		
		SQ3	2	44738	Ø	CP,GU	500/5,000	800/8,000	20		
		SQ3	2	51143	Ø	CP,GU	500/5,000	800/8,000	20		
		SQ4	2	44536	Ø	CP	600/6,000	1,000/10,000	25		
		SQ4	2	44603	Ø	CP	600/6,000	1,000/10,000	20		
		SQ5	2	96929		GP,KL,SG	1,200/12,000	1,500/15,000	35		
		SQ5	2	45709		AA,GH,HM,LT,SO,TO	2,000/18,000	2,500/18,000	95		
		SQ5	2-1/2	45299†		†,AA,GH,HM,LT,SO,TO	2,000/18,000	2,500/18,000	95		
Ram 3500 Except Mega Cab	06-09	SQ5	2-1/2	45288†		†,KL,SB	1,200/12,000	1,700/14,000	35		
		SQ5	2-1/2	45718		#,KL,SB	1,200/12,000	1,700/14,000	35		
Ram 3500 Cab & Chassis, w/34" Wide Frames	07-10	SQ5	2	96936			1,200/12,000		30		
		SQ5	2	96947			1,600/15,000	1,600/16,000	35		
Ram 3500	10	SQ5	2	96929		GP,KL,SG	1,200/12,000	1,500/15,000	35		
		SQ5	2	45709		AA,GH,HM,LT,SO,TO	2,000/18,000	2,500/18,000	95		
		SQ5	2-1/2	45299†		†,AA,GH,HM,LT,SO,TO	2,000/18,000	2,500/18,000	95		
Ram 3500 Except Mega Cab	10	SQ5	2-1/2	45288†		†,KL,SB	1,200/12,000	1,700/14,000	35		
		SQ5	2-1/2	45718		#,KL,SB	1,200/12,000	1,700/14,000	35		
Ram 4000	95-01	SQ3	2	44103			500/5,000	1,000/10,000	15	74475	BN,HJ
		SQ3	2	51016		HM,FP	500/5,000	1,000/10,000	40		
		SQ3	2	51039			500/5,000	1,000/10,000	15		
Ram 4000	99	RT4	2	37094		GU	700/7,000	1,200/12,000	40	74475	HJ
Ram 4000	00-01	RT4	2	37094		GU	700/7,000	1,200/12,000	40	74475	HJ
Ram 4500 Cab & Chassis, w/34" Wide Frames	08-10	SQ5	2	96936			1,200/12,000		30		
		SQ5	2	96947			1,600/15,000	1,600/16,000	35		
Ram 5500 Cab & Chassis, w/34" Wide Frames	08-10	SQ5	2	96936			1,200/12,000		30		
		SQ5	2	96947			1,600/15,000	1,600/16,000	35		
Sprinter 2500 w/41" Wide Frames, Except 118" Wheelbase & Factory Metal Step Platform	03-06	SQ3	2	33089	Ø	†,HM	500/5,000	750/7,500	20		
Sprinter 2500 144" & 170" Wheelbase, Except w/Factory Step Bumper	07-09	SQ4	2	44576	Ø	HM,UL	600/6,000	750/7,500	20	85925	CH

**#** Titan hitches require use of a 2-1/2" shank Titan ball mount.  
**†** Available while supply lasts.  
**AA** Requires temporary removal of bumper during installation.  
**BN** Exterior mounted plug on some or all models. May require an aftermarket electrical mounting box or bracket. (Sold separately)  
**CH** T-One is equipped with circuit protected ModuLite® module.  
**CP** Fits all models without factory installed receiver.  
**CQ** Will not fit with heavy duty suspension.  
**FP** Spare tire repositioning and/or modification of spare tire carrier may be required.  
**GH** Will not fit models with 34 in. wide frames.  
**GP** Hitch cross-tube concealed behind bumper.  
**GU** Will not fit vehicles with factory or aftermarket lower Fascia/Rollpan or Tube Bumper.

**HM** Hitch cross-tube is visible beneath bumper.  
**KL** Hitch is designed to attach beneath the OEM hitch.  
**LT** Requires removal of factory hitch if equipped.  
**Ø** Uses all existing holes. No drilling required.  
**SB** Will not fit models with short bed.  
**SG** Hitches produced before 09/10/07 are rated at 1000/10000 WC & 1200/12000 WD.  
**SO** With this hitch installed the step bumper is no longer able to be used as a towing point.  
**TO** Will not fit models equipped Chassis Cab spring mount.  
**UL** This hitch will not fit a Sprinter single or dual rear-wheel vehicle with a 30-3/8 in. wide frame measured outside of frame to outside of frame.

**RT3** Round Tube Class III 2"  
**RT4** Round Tube Class IV 2"  
**SQ3** Square Tube Class III  
**SQ4** Square Tube Class IV  
**SQ5** Square Tube Class V



# RECEIVER HITCH AND T-CONNECTOR APPLICATION GUIDE

RECEIVER HITCHES

MODEL / STYLE	YEAR	TRAILER HITCHES								T-CONNECTOR	
		REC TYPE	REC SIZE	PART NO.	NO DRILL	FOOTNOTES	WC (LBS.)	WD (LBS.)	IN	T-CON PART NO.	FN
<b>DODGE (Continued)</b>											
Sprinter 2500 w/Factory Step Bumper Excluding Models w/30-3/8" Frame Width	07-09	SQ3	2	44591	0	HM	500/5,000	750/7,500	30	85925	CH
Sprinter 3500 144" & 170" Wheelbase, Except w/Factory Step Bumper	07-09	SQ4	2	44576	0	HM,UL	600/6,000	750/7,500	20	85925	CH
Sprinter 3500 w/Factory Step Bumper Excluding Models w/30-3/8" Frame Width	07-09	SQ3	2	44591	0	HM	500/5,000	750/7,500	30	85925	CH
Stratus 4 Dr.	95-06	SQ2	1-1/4	06977		JR,HM	300/3,500		60		
Van, Ram 1500	99-00	SQ3	2	44094	0		500/5,000	1,000/10,000	30	74888	BN
		SQ3	2	51037	0		500/5,000	1,000/10,000	30		
Van, Ram 1500 Except w/Factory Step Bumper	99-00	SQ4	2	37070	0	BF	600/6,000	1,000/10,000	25	74888	BN
Van, Ram 1500	01-03	SQ3	2	44094	0		500/5,000	1,000/10,000	30	85253	BN
		SQ3	2	51037	0		500/5,000	1,000/10,000	30		
Van, Ram 1500 Except w/Factory Step Bumper	01-03	SQ4	2	37070	0	BF	600/6,000	1,000/10,000	25	85253	BN
Van, Ram 2500	99-00	SQ3	2	44094	0		500/5,000	1,000/10,000	30	74888	BN
		SQ3	2	51037	0		500/5,000	1,000/10,000	30		
Van, Ram 2500 Except w/Factory Step Bumper	99-00	SQ4	2	37070	0	BF	600/6,000	1,000/10,000	25	74888	BN
Van, Ram 2500	01-03	SQ3	2	44094	0		500/5,000	1,000/10,000	30	85253	BN
		SQ3	2	51037	0		500/5,000	1,000/10,000	30		
Van, Ram 2500 Except w/Factory Step Bumper	01-03	SQ4	2	37070	0	BF	600/6,000	1,000/10,000	25	85253	BN
Van, Ram 3500	99-00	SQ3	2	44094	0		500/5,000	1,000/10,000	30	74888	BN
		SQ3	2	51037	0		500/5,000	1,000/10,000	30		
Van, Ram 3500 Except w/Factory Step Bumper	99-00	SQ4	2	37070	0	BF	600/6,000	1,000/10,000	25	74888	BN
Van, Ram 3500	01-03	SQ3	2	44094	0		500/5,000	1,000/10,000	30	85253	BN
		SQ3	2	51037	0		500/5,000	1,000/10,000	30		
Van, Ram 3500 Except w/Factory Step Bumper	01-03	SQ4	2	37070	0	BF	600/6,000	1,000/10,000	25	85253	BN
<b>FIAT</b>											
500 Except Abarth	12-19	SQ1	1-1/4	77255	0	GP,JR	200/2,000		30	85769	CH
500L	14-17	SQ1	1-1/4	77969†		EP,SV	200/2,000		45	85995	CH
500L	18-20	SQ1	1-1/4	77969†		EP,SV	200/2,000		45		
500x	16-20	SQ3	2	84019	0	HM	675/4,500		45	85923	CH
<b>FORD</b>											
C-MAX	13-18	SQ1	1-1/4	77284		GP,JR,KH	200/2,000		25		
Crown Victoria	98-09	SQ1	1-1/4	77002†		†,CA,GP	200/2,000		25		
		SQ3	2	33047		CA,GP	350/3,500	750/6,000	30		
		SQ3	2	51103		CA,GP	350/3,500	750/6,000	30		
E-150 Econoline	95-02	SQ3	2	44027		HX,O,PA,T	500/5,000	1,000/10,000	30	74665	BN
		SQ3	2	51007		HM,HX,O,PA,T	500/5,000	1,000/10,000	30		
		RT4	2	44652		CS,HM	600/6,000	1,000/10,000	20		
		SQ5	2	96906		HM,HY	1,000/10,000	1,200/12,000	30		
E-150 Econoline	97-02	RT3	2	37041			500/5,000	600/6,000	20	74665	
E-150 Econoline	00-02	RT4	2	51094	0	RT	600/6,000	800/8,000	15	74665	BN
		SQ5	2	96926	0	HM	1,000/10,000	1,200/12,000	30		
		SQ5	2	96945	0	HM	1,500/10,000	1,200/12,000	30		
E-150 Econoline	03-07	RT4	2	44652		CS,HM	600/6,000	1,000/10,000	20		
		RT4	2	51094	0	RT	600/6,000	800/8,000	15		
		SQ5	2	96906		HM,HY	1,000/10,000	1,200/12,000	30		
		SQ5	2	96926	0	HM	1,000/10,000	1,200/12,000	30		
		SQ5	2	96945	0	HM	1,500/10,000	1,200/12,000	30		
E-150 Econoline	04-14	RT3	2	37041			500/5,000	600/6,000	20		

- † Available while supply lasts.
- BF Requires standard bumper. Will not fit with step bumper.
- BN Exterior mounted plug on some or all models. May require an aftermarket electrical mounting box or bracket. (Sold separately)
- CA Models with dual exhaust require exhaust modification.
- CH T-One is equipped with circuit protected ModuLite® module.
- CS Will fit with full-size spare tire stowed under vehicle.
- EP Fascia trimming may be required.
- GP Hitch crosstube concealed behind bumper.
- HM Hitch crosstube is visible beneath bumper.
- HX Minor exhaust modification may be required.
- HY Ultra Frame ball mount DT #4283/HH #80125 cannot be used in rise position on vehicles with step bumpers.
- JR Exhaust must be temporarily lowered for installation.

- KH Minor heat shield modification may be required.
- O Will not fit vehicles equipped with dual exhaust exiting below the bumper.
- 0 Uses all existing holes. No drilling required.
- PA Will not fit 124 in. wheelbase or E-350 models.
- RT Round Tube Class III/IV 2"
- SV Trimming or removal of under body appearance panel may be required.
- T Vans with step bumpers require longer ball mounts.
- UL This hitch will not fit a Sprinter single or dual rear-wheel vehicle with a 30-3/8 in. wide frame measured outside of frame to outside of frame.

- RT3 Round Tube Class III 2"
- RT4 Round Tube Class IV 2"
- SQ1 Square Tube Class I
- SQ2 Square Tube Class II
- SQ3 Square Tube Class III
- SQ4 Square Tube Class IV
- SQ5 Square Tube Class V

F - FORD

# RECEIVER HITCH AND T-CONNECTOR APPLICATION GUIDE

MODEL / STYLE	YEAR	TRAILER HITCHES							T-CONNECTOR		
		REC TYPE	REC SIZE	PART NO.	NO DRILL	FOOTNOTES	WC (LBS.)	WD (LBS.)	IN	T-CON PART NO.	FN
<b>FORD (Continued)</b>											
E-150 Econoline	08	RT4	2	44652		CS, HM	600/6,000	1,000/10,000	20	85774	CH
		RT4	2	51094	0	RT	600/6,000	800/8,000	15		
		SQ5	2	96906		HM, HY	1,000/10,000	1,200/12,000	30		
		SQ5	2	96926	0	HM	1,000/10,000	1,200/12,000	30		
		SQ5	2	96945	0	HM	1,500/10,000	1,200/12,000	30		
E-150 Econoline	09-14	RT4	2	44652	0	CS, HM	600/6,000	1,000/10,000	20	85774	CH
		RT4	2	51094	0	RT	600/6,000	800/8,000	15		
		SQ5	2	96906		HM, HY	1,000/10,000	1,200/12,000	30		
		SQ5	2	96926	0	HM	1,000/10,000	1,200/12,000	30		
		SQ5	2	96945	0	HM	1,500/10,000	1,200/12,000	30		
E-250 Econoline	95-02	SQ3	2	44027		HX, O, PA, T	500/5,000	1,000/10,000	30	74665	BN
		SQ3	2	51007		HM, HX, O, PA, T	500/5,000	1,000/10,000	30		
		RT4	2	44652		CS, HM	600/6,000	1,000/10,000	20		
		SQ5	2	96906		HM, HY	1,000/10,000	1,200/12,000	30		
E-250 Econoline	97-02	RT3	2	37041			500/5,000	600/6,000	20	74665	
E-250 Econoline	00-02	SQ5	2	96926	0	HM	1,000/10,000	1,200/12,000	30	74665	BN
		SQ5	2	96945	0	HM	1,500/10,000	1,200/12,000	30		
E-250 Econoline Except E-250 Super Wagon Cargo Van	00-02	RT4	2	51094	0	RT	600/6,000	800/8,000	15	74665	BN
E-250 Econoline	03-07	RT4	2	44652		CS, HM	600/6,000	1,000/10,000	20		
		SQ5	2	96906		HM, HY	1,000/10,000	1,200/12,000	30		
		SQ5	2	96926	0	HM	1,000/10,000	1,200/12,000	30		
		SQ5	2	96945	0	HM	1,500/10,000	1,200/12,000	30		
E-250 Econoline Except E-250 Super Wagon Cargo Van	03-07	RT4	2	51094	0	RT	600/6,000	800/8,000	15		
E-250 Econoline Except E-250 Super Wagon Cargo Van	03-14	RT3	2	37041			500/5,000	600/6,000	20		
E-250 Econoline	08	RT4	2	44652		CS, HM	600/6,000	1,000/10,000	20	85774	CH
		SQ5	2	96906		HM, HY	1,000/10,000	1,200/12,000	30		
		SQ5	2	96926	0	HM	1,000/10,000	1,200/12,000	30		
		SQ5	2	96945	0	HM	1,500/10,000	1,200/12,000	30		
E-250 Econoline Except E-250 Super Wagon Cargo Van	08	RT4	2	51094	0	RT	600/6,000	800/8,000	15	85774	CH
E-250 Econoline	09-14	RT4	2	44652		CS, HM	600/6,000	1,000/10,000	20	85774	CH
		SQ5	2	96906		HM, HY	1,000/10,000	1,200/12,000	30		
		SQ5	2	96926	0	HM	1,000/10,000	1,200/12,000	30		
		SQ5	2	96945	0	HM	1,500/10,000	1,200/12,000	30		
E-250 Econoline Except E-250 Super Wagon Cargo Van	09-14	RT4	2	51094	0	RT	600/6,000	800/8,000	15	85774	CH
E-350 Econoline	95-02	RT4	2	44652		CS, HM	600/6,000	1,000/10,000	20	74665	BN
		SQ5	2	96906		HM, HY	1,000/10,000	1,200/12,000	30		
E-350 Econoline	97-00	RT3	2	37041			500/5,000	600/6,000	20	74665	
E-350 Econoline	00-02	RT4	2	51094	0	RT	600/6,000	800/8,000	15	74665	BN
		SQ5	2	96926	0	HM	1,000/10,000	1,200/12,000	30		
		SQ5	2	96945	0	HM	1,500/10,000	1,200/12,000	30		
E-350 Econoline Super Duty	03-07	RT4	2	44652		CS, HM	600/6,000	1,000/10,000	20		
		RT4	2	51094	0	RT	600/6,000	800/8,000	15		
		SQ5	2	96906		HM, HY	1,000/10,000	1,200/12,000	30		
		SQ5	2	96926	0	HM	1,000/10,000	1,200/12,000	30		
		SQ5	2	96945	0	HM	1,500/10,000	1,200/12,000	30		
E-350 Econoline Super Duty	08	RT4	2	44652		CS, HM	600/6,000	1,000/10,000	20	85774	CH
		RT4	2	51094	0	RT	600/6,000	800/8,000	15		
		SQ5	2	96906		HM, HY	1,000/10,000	1,200/12,000	30		
		SQ5	2	96926	0	HM	1,000/10,000	1,200/12,000	30		
		SQ5	2	96945	0	HM	1,500/10,000	1,200/12,000	30		

**BN** Exterior mounted plug on some or all models. May require an aftermarket electrical mounting box or bracket. (Sold separately)

**CH** T-One is equipped with circuit protected ModuLite® module.

**CS** Will fit with full-size spare tire stowed under vehicle.

**HM** Hitch crosstube is visible beneath bumper.

**HX** Minor exhaust modification may be required.

**HY** Ultra Frame ball mount DT #4283/HH #80125 cannot be used in rise position on vehicles with step bumpers.

**O** Will not fit vehicles equipped with dual exhaust exiting below the bumper.

**0** Uses all existing holes. No drilling required.

**PA** Will not fit 124 in. wheelbase or E-350 models.

**RT** Round Tube Class III/IV 2"

**T** Vans with step bumpers require longer ball mounts.

**RT3** Round Tube Class III 2"

**RT4** Round Tube Class IV 2"

**SQ3** Square Tube Class III

**SQ5** Square Tube Class V

# RECEIVER HITCH AND T-CONNECTOR APPLICATION GUIDE

RECEIVER HITCHES

MODEL / STYLE	YEAR	TRAILER HITCHES							T-CONNECTOR		
		REC TYPE	REC SIZE	PART NO.	NO DRILL	FOOTNOTES	WC (LBS.)	WD (LBS.)	IN	T-CON PART NO.	FN
<b>FORD (Continued)</b>											
<b>E-350 Econoline Super Duty</b>	<b>09-14</b>	RT4	2	<b>44652</b>	0	CS, HM	600/6,000	1,000/10,000	20	<b>85774</b>	CH
		RT4	2	<b>51094</b>	0	RT	600/6,000	800/8,000	15		
		SQ5	2	<b>96906</b>	0	HM, HY	1,000/10,000	1,200/12,000	30		
		SQ5	2	<b>96926</b>	0	HM	1,000/10,000	1,200/12,000	30		
		SQ5	2	<b>96945</b>	0	HM	1,500/10,000	1,200/12,000	30		
<b>EcoSport</b>	<b>18-20</b>	SQ2	1-1/4	<b>06190</b>	0	JR, GP, SV	300/3,500		45		
<b>Edge Except Sport</b>	<b>07-10</b>	SQ2	1-1/4	<b>06525</b>	0	GP, JR, KH	300/3,500		45	<b>85774</b>	CH
		SQ3	2	<b>44764</b>	0	GP, KH, JR	400/4,000	400/4,000	55		
		SQ3	2	<b>51200</b>	0	CP, GP, JR, KH	400/4,000		55		
<b>Edge Sport</b>	<b>09-10</b>	SQ3	2	<b>44641</b>	0	GP, JR, KH	350/3,500		45	<b>85774</b>	CH
<b>Edge Except Sport</b>	<b>11-14</b>	SQ3	2	<b>44764</b>	0	GP, KH, JR	400/4,000	400/4,000	55	<b>85742</b>	CH
		SQ3	2	<b>51200</b>	0	CP, GP, JR, KH	400/4,000		55		
<b>Edge Sport</b>	<b>11-14</b>	SQ3	2	<b>44672</b>	0	GP, JR, KH	525/3,500	525/4,000	45	<b>85742</b>	CH
<b>Edge Except Sport &amp; Titanium Models</b>	<b>15-20</b>	RT3	2	<b>44766</b>	0	JR, HM, SV, TW	600/4,000	600/4,000	30	<b>85875</b>	CH, BN
		SQ3	2	<b>44784</b>	0	GP, TA, SV, JR, TW	675/4,500	675/4,500	45		
<b>Edge Titanium and Sport Models Only</b>	<b>15-20</b>	SQ3	2	<b>44784</b>	0	GP, TA, SV, JR, TW	675/4,500	675/4,500	45		CH, BN
<b>Edge Titanium Model Only</b>	<b>15</b>	RT3	2	<b>44766</b>	0	JR, HM, SV, TW	600/4,000	600/4,000	30	<b>85889</b>	CH, BN
<b>Edge Except Titanium Models</b>	<b>19-20</b>	RT3	2	<b>44766</b>	0	JR, HM, SV, TW	600/4,000	600/4,000	30	<b>89523</b>	CH, BN
		SQ3	2	<b>44784</b>	0	JR, HM, SV, TW	675/4,500	675/4,500	30		
<b>Escape</b>	<b>01-02</b>	SQ2		<b>88001†</b>		†, KH	350/3,500		60	<b>74664</b>	HG, RW
		SQ3	2	<b>37042</b>		KH	500/5,000	600/6,000	60		
<b>Escape</b>	<b>01-03</b>	RT3	2	<b>44723</b>	0	HM, KH	350/3,500	500/5,000	35	<b>74664</b>	HG, RW
		SQ3	2	<b>37152</b>		KH	500/5,000	600/6,000	60		
<b>Escape</b>	<b>03</b>	SQ2		<b>88001†</b>		†	350/3,500		60	<b>74664</b>	HG, RW
		SQ3	2	<b>37042</b>			500/5,000	600/6,000	60		
<b>Escape</b>	<b>04</b>	SQ2		<b>88001†</b>		†	350/3,500		60	<b>74672</b>	
		RT3	2	<b>44723</b>	0	HM	350/3,500	500/5,000	35		
		SQ3	2	<b>37042</b>			500/5,000	600/6,000	60		
		SQ3	2	<b>37152</b>			500/5,000	600/6,000	60		
<b>Escape</b>	<b>05-07</b>	SQ2	1-1/4	<b>06417</b>		HM	300/3,500		20	<b>74703</b>	BN, CH
		SQ2	1-1/4	<b>51194</b>		HM	300/3,500		20		
		RT3	2	<b>97232</b>	0	HM	350/3,500	500/5,000	25		
		RT3	2	<b>44680</b>	0	HM	675/4,500	675/5,250	25		
<b>Escape</b>	<b>08-12</b>	SQ2	1-1/4	<b>06417</b>		HM	300/3,500		20	<b>85774</b>	CH
		SQ2	1-1/4	<b>51194</b>		HM	300/3,500		20		
		RT3	2	<b>97232</b>	0	HM	350/3,500	500/5,000	25		
		RT3	2	<b>44680</b>	0	HM	675/4,500	675/5,250	25		
<b>Escape</b>	<b>13-16</b>	SQ2	1-1/4	<b>06147</b>	0	HM	300/3,500		15	<b>85795</b>	BN, CH
		SQ2	1-1/4	<b>06156</b>	0	GP, JR, KH	300/3,500		20		
		RT3	2	<b>51233†</b>	0	†, HM	350/3,500	400/4,000	15		
		RT3	2	<b>97233†</b>	0	HM	350/3,500	400/4,000	15		
		SQ3	2	<b>44694</b>	0	GP, JR, KH	525/3,500	525/5,000	60		
		RT3	2	<b>44681</b>	0	HM	675/4,500	675/5,000	15		
<b>Escape</b>	<b>17-18</b>	SQ2	1-1/4	<b>06147</b>	0	HM	300/3,500		15	<b>85909</b>	CH
		SQ2	1-1/4	<b>06156</b>	0	GP, JR, KH	300/3,500		60		
		RT3	2	<b>51233†</b>	0	†, HM	350/3,500	400/4,000	15		
		RT3	2	<b>97233†</b>	0	HM	350/3,500	400/4,000	15		
		SQ3	2	<b>44694</b>	0	GP, JR, KH	525/3,500	525/5,000	60		
		RT3	2	<b>44681</b>	0	HM	675/4,500	675/5,000	15		

† Available while supply lasts.  
 BN Exterior mounted plug on some or all models. May require an aftermarket electrical mounting box or bracket. (Sold separately)  
 CH T-One is equipped with circuit protected ModuLite® module.  
 CP Fits all models without factory installed receiver.  
 CS Will fit with full-size spare tire stowed under vehicle.  
 GP Hitch crosstube concealed behind bumper.  
 HG T-One incorporates taillight converter.  
 HM Hitch crosstube is visible beneath bumper.  
 HY Ultra Frame ball mount DT #4283/HH #80125 cannot be used in rise position on vehicles with step bumpers.  
 JR Exhaust must be temporarily lowered for installation.  
 KH Minor heat shield modification may be required.  
 0 Uses all existing holes. No drilling required.

RT Round Tube Class III/IV 2"  
 RW On some models it may require an upgraded flasher or ModuLite®.  
 SV Trimming or removal of under body appearance panel may be required.  
 TA Trunk access required for hitch installation.  
 TW Receiver hitch may limit hands-free liftgate sensor range

RT3 Round Tube Class III 2"  
 RT4 Round Tube Class IV 2"  
 SQ2 Square Tube Class II  
 SQ3 Square Tube Class III  
 SQ5 Square Tube Class V

F - FORD

# RECEIVER HITCH AND T-CONNECTOR APPLICATION GUIDE

MODEL / STYLE	YEAR	TRAILER HITCHES							T-CONNECTOR		
		REC TYPE	REC SIZE	PART NO.	NO DRILL	FOOTNOTES	WC (LBS.)	WD (LBS.)	IN	T-CON PART NO.	FN
<b>FORD (Continued)</b>											
Escape	19	SQ2	1-1/4	06147	0	HM	300/3,500		15	89522	CH,BN
		SQ2	1-1/4	06156	0	GP,JR,KH	300/3,500		60		
		RT3	2	51233†	0	†,HM	350/3,500	400/4,000	15		
		RT3	2	97233†	0	HM	350/3,500	400/4,000	15		
		SQ3	2	44694	0	GP,JR,KH	525/3,500	525/5,000	60		
		RT3	2	44681	0	HM	675/4,500	675/5,000	15		
Escape	20	SQ3	2	84424	0		675/4,500		50	118816	CH
Escape Except Hybrid	20	SQ2	1-1/4	06195	0	HM,JR	350/3,500		30		
		RT3	2	84327	0	HM,JR	675/4,500	675/5,000	30		
Expedition	97-02	SQ3	2	33052	0	GP	500/5,000	800/8,000	20	74665	BN
		SQ4	2	44622	0	GP	600/6,000	1,000/10,000	15		
Explorer	95-00	SQ2	1-1/4	06365	0	HM	300/3,500		15	74724	BN,CH
		SQ3	2	37012	0	HM	500/5,000	600/6,000	40		
		RT3	2	44067	0	JF,HM	500/5,000	600/6,000	45		
		SQ3	2	44100	0	HM	500/5,000	600/6,000	20		
		SQ3	2	51033	0	HM	500/5,000	600/6,000	15		
Explorer	98-99	RT3	2	37041		JF	500/5,000	600/6,000	30	74724	GC
Explorer	00	RT3	2	37041		JF	500/5,000	600/6,000	30	74724	GC
Explorer 2 Dr. Sport	01	SQ3	2	37012	0	HM	500/5,000	600/6,000	40	74665	BN
		SQ3	2	44100	0	HM	500/5,000	600/6,000	20		
		SQ3	2	51033	0	HM	500/5,000	600/6,000	15		
Explorer 2 Dr. Sport	01-03	SQ2	1-1/4	06365	0	HM	300/3,500		15	74665	BN
		RT3	2	37041	0	JF	500/5,000	600/6,000	30		
		RT3	2	44067	0	JF,HM	500/5,000	600/6,000	45		
Explorer 4 Dr.	01	SQ2	1-1/4	06365	0	HM	300/3,500		15	74724	BN,CH
		SQ3	2	37012	0	HM	500/5,000	600/6,000	40		
		RT3	2	37041	0	JF	500/5,000	600/6,000	30		
		RT3	2	44067	0	JF,HM	500/5,000	600/6,000	45		
		SQ3	2	44100	0	HM	500/5,000	600/6,000	20		
		SQ3	2	51033	0	HM	500/5,000	600/6,000	15		
Explorer 2 Dr. Sport	02-03	SQ3	2	37012	0	HM	500/5,000	600/6,000	40	74665	BN
		SQ3	2	44100	0	HM	500/5,000	600/6,000	20		
		SQ3	2	51033	0	HM	500/5,000	600/6,000	15		
Explorer 4 Dr.	02-03	RT3	2	33031	0	HM,KL	500/5,000	800/8,000	20	74665	BN
Explorer 4 Dr.	04-05	RT3	2	33031	0	HM,KL	500/5,000	800/8,000	20		
Explorer w/1-1/4" Receivers	06-10	RT3	2	44542	0	HM,KL	500/5,000	800/8,000	25		
Explorer	11-19	RT3	2	51202	0	RT,HM,JR,L	400/4,000	500/5,000	45	85759	BN
		SQ3	2	84034	0	HM,JR,L,TW	675/4,500	500/5,000	45		
Explorer	20	SQ2	1-1/4	06194	0	JR,KH,GP,X,SV	300/3,500			85831	CH
		SQ3	2	84320	0	JR,KH,GP,X,SV	900/6,000		40		
Explorer	21	SQ2	1-1/4	06194	0	JR,KH,GP,X,SV	300/3,500			85831	CH
		SQ3	2	84320	0	JR,KH,GP,X,SV	900/6,000		40		
Explorer Sport Trac	01	RT3	2	33020†	0	†,CS	500/5,000	600/6,000	15		
		RT3	2	51141	0	RT,CS	500/5,000	600/6,000	15		
Explorer Sport Trac	02-03	RT3	2	33020†	0	†,CS	500/5,000	600/6,000	15	74665	BN
		RT3	2	51141	0	RT,CS	500/5,000	600/6,000	15		
Explorer Sport Trac	04-05	RT3	2	33020†	0	†,CS	500/5,000	600/6,000	15		
		RT3	2	51141	0	RT,CS	500/5,000	600/6,000	15		

† Available while supply lasts.  
**BN** Exterior mounted plug on some or all models. May require an aftermarket electrical mounting box or bracket. (Sold separately)  
**CH** T-One is equipped with circuit protected ModuLite® module.  
**CS** Will fit with full-size spare tire stowed under vehicle.  
**GC** T-One is equipped with ModuLite® Lite module.  
**GP** Hitch crossbar concealed behind bumper.  
**HM** Hitch crossbar is visible beneath bumper.  
**JF** Will not fit with 16 in. spare tire.  
**JR** Exhaust must be temporarily lowered for installation.  
**KH** Minor heat shield modification may be required.  
**KL** Hitch is designed to attach beneath the OEM hitch.  
**L** Exhaust repositioning required.

**0** Uses all existing holes. No drilling required.  
**RT** Round Tube Class III/IV 2"  
**SV** Trimming or removal of under body appearance panel may be required.  
**TW** Receiver hitch may limit hands-free liftgate sensor range  
**X** Minor fascia trimming required.

**RT3** Round Tube Class III 2"  
**SQ2** Square Tube Class II  
**SQ3** Square Tube Class III  
**SQ4** Square Tube Class IV

# RECEIVER HITCH AND T-CONNECTOR APPLICATION GUIDE

RECEIVER HITCHES

MODEL / STYLE	YEAR	TRAILER HITCHES							T-CONNECTOR		
		REC TYPE	REC SIZE	PART NO.	NO DRILL	FOOTNOTES	WC (LBS.)	WD (LBS.)	IN	T-CON PART NO.	FN
<b>FORD (Continued)</b>											
F-150 Flareside	97-03	SQ2		88001†		†	350/3,500		35	74665	
		RT3	2	37069	0		500/5,000	750/7,500	25		
		SQ3	2	37096	0		500/5,000	650/6,500	40		
		SQ3	2	44007	0		500/5,000	1,000/10,000	20		
		SQ3	2	51020	0		500/5,000	1,000/10,000	15		
		SQ4	2	36099	0		600/6,000	1,000/10,000	20		
		SQ4	2	51095	0	FP,GP	600/6,000	1,000/10,000	20		
		RT4	2	37034	0		700/7,000	1,200/12,000	25		
		RT4	2	37094	0		700/7,000	1,200/12,000	25		
		RT4	2	44673	0	FP,HM	900/6,000	1,000/10,000	20		
SQ5	2	96920		GP,SU	1,000/10,000	1,300/13,000	30				
F-150 Styleside	97-03	SQ2		88001†		†	350/3,500		35		
		RT3	2	37069	0		500/5,000	750/7,500	25		
		SQ3	2	37096	0		500/5,000	650/6,500	40		
		SQ3	2	44007	0		500/5,000	1,000/10,000	20		
		SQ3	2	51020	0		500/5,000	1,000/10,000	15		
		SQ4	2	36099	0		600/6,000	1,000/10,000	20		
		SQ4	2	51095	0	FP,GP	600/6,000	1,000/10,000	20		
		RT4	2	37034	0		700/7,000	1,200/12,000	25		
		RT4	2	37094	0		700/7,000	1,200/12,000	25		
		RT4	2	44673	0	FP,HM	900/6,000	1,000/10,000	20		
SQ5	2	96920		GP,SU	1,000/10,000	1,300/13,000	30				
F-150 SuperCrew	00-03	SQ2		88001†		†	350/3,500		35	74665	
		RT3	2	37069	0		500/5,000	750/7,500	25		
		SQ3	2	37096	0		500/5,000	650/6,500	40		
		SQ3	2	44007	0		500/5,000	1,000/10,000	20		
		SQ3	2	51020	0		500/5,000	1,000/10,000	15		
		SQ4	2	36099	0		600/6,000	1,000/10,000	20		
		SQ4	2	51095	0	FP,GP	600/6,000	1,000/10,000	20		
		RT4	2	37034	0		700/7,000	1,200/12,000	25		
		RT4	2	37094	0		700/7,000	1,200/12,000	25		
		RT4	2	44673	0	FP,HM	900/6,000	1,000/10,000	20		
SQ5	2	96920		GP,SU	1,000/10,000	1,300/13,000	30				
F-150	04	RT3	2	37069	0	VB	500/5,000	750/7,500	45		
		SQ3	2	44131	0	VB	500/5,000	1,000/10,000	30		
		RT3	2	51064	0	RT,VB,KM	500/5,000	1,000/10,000	30		
		RT4	2	37090	0	HM,VB,KM	600/6,000	1,000/10,000	30		
RT4	2	44655	0	HM,KM	600/6,000	800/8,000	30				
F-150 SuperCrew, 5.5 ft. Bed	04-05	SQ3	2	37096		VB	500/5,000	650/6,500	50		
F-150	05	RT3	2	37069		VB	500/5,000	750/7,500	45		
		SQ3	2	44131	0	VB	500/5,000	1,000/10,000	30		
		RT3	2	51064	0	RT,VB,KM	500/5,000	1,000/10,000	30		
		RT4	2	37090	0	HM,VB,KM	600/6,000	1,000/10,000	30		
RT4	2	44655	0	HM,VB,KM	600/6,000	800/8,000	30				
F-150	06-08	SQ4	2	44552	0	CP,HM	600/6,000	1,000/10,000	20		
		SQ4	2	51075	0	CP,HM	600/6,000	1,000/10,000	20		
		SQ5	2	96933	0	CP,HM	1,200/12,000	1,400/14,000	20		
F-150	09-14	SQ3	2	51097	0	CP,HM	500/5,000	1,000/10,000	15		
		SQ4	2	44645	0	CP,GP	600/6,000	1,200/12,000	20		

† Available while supply lasts.  
 CP Fits all models without factory installed receiver.  
 FP Spare tire repositioning and/or modification of spare tire carrier may be required.  
 GP Hitch crosstube concealed behind bumper.  
 HM Hitch crosstube is visible beneath bumper.  
 KM Does not work with models originally equipped with OEM hitch.  
 0 Uses all existing holes. No drilling required.  
 RT Round Tube Class III/IV 2"  
 SU Hitches produced before 03/11/08 are rated at 1000/10000 WC & 1200/12000 WD.  
 VB Will not fit vehicles with vibration damper installed at rear of frame on drivers side.

RT3 Round Tube Class III 2"  
 RT4 Round Tube Class IV 2"  
 SQ2 Square Tube Class II  
 SQ3 Square Tube Class III  
 SQ4 Square Tube Class IV  
 SQ5 Square Tube Class V

F - FORD



# RECEIVER HITCH AND T-CONNECTOR APPLICATION GUIDE

MODEL / STYLE	YEAR	TRAILER HITCHES							T-CONNECTOR		
		REC TYPE	REC SIZE	PART NO.	NO DRILL	FOOTNOTES	WC (LBS.)	WD (LBS.)	IN	T-CON PART NO.	FN
<b>FORD (Continued)</b>											
<b>F-150</b>	<b>15-20</b>	SQ3	2	<b>51238</b>	0	HM,JL	500/5,000	800/8,000	30		
		SQ3	2	<b>97238</b>	0	HM,JL	500/5,000	800/8,000	30		
		RT4	2	<b>44754</b>	0	HM,JL	900/6,000	800/8,000	30		
		RT4	2	<b>44767</b>	0	HM,JL	900/6,000	1,200/12,000	30		
		SQ4	2	<b>84136</b>	0	GP,FP	900/6,000	1,000/10,000	30		
<b>F-150 Heritage</b>	<b>04</b>	SQ3	2	<b>37096</b>	0		500/5,000	650/6,500	40	<b>74665</b>	
<b>F-150 Heritage Flareside</b>	<b>04</b>	SQ2	2	<b>88001†</b>	0	†	350/3,500		35	<b>74665</b>	
		RT3	2	<b>37069</b>	0		500/5,000	750/7,500	25		
		SQ3	2	<b>44007</b>	0		500/5,000	1,000/10,000	20		
		SQ3	2	<b>51020</b>	0		500/5,000	1,000/10,000	15		
		SQ4	2	<b>36099</b>	0		600/6,000	1,000/10,000	20		
		SQ4	2	<b>51095</b>	0	FP,GP	600/6,000	1,000/10,000	20		
		RT4	2	<b>37034</b>	0		700/7,000	1,200/12,000	25		
		RT4	2	<b>37094</b>	0		700/7,000	1,200/12,000	25		
		RT4	2	<b>44673</b>	0	FP,HM	900/6,000	1,000/10,000	20		
SQ5	2	<b>96920</b>	0	GP,SU	1,000/10,000	1,300/13,000	30				
<b>F-150 Heritage Styleside</b>	<b>04</b>	SQ2	2	<b>88001†</b>	0	†	350/3,500		35		
		RT3	2	<b>37069</b>	0		500/5,000	750/7,500	25		
		SQ3	2	<b>44007</b>	0		500/5,000	1,000/10,000	20		
		SQ3	2	<b>51020</b>	0		500/5,000	1,000/10,000	15		
		SQ4	2	<b>36099</b>	0		600/6,000	1,000/10,000	20		
		SQ4	2	<b>51095</b>	0	FP,GP	600/6,000	1,000/10,000	20		
		RT4	2	<b>37034</b>	0		700/7,000	1,200/12,000	25		
		RT4	2	<b>37094</b>	0		700/7,000	1,200/12,000	25		
		RT4	2	<b>44673</b>	0	FP,HM	900/6,000	1,000/10,000	20		
SQ5	2	<b>96920</b>	0	GP,SU	1,000/10,000	1,300/13,000	30				
<b>F-250 Styleside</b>	<b>97-99</b>	SQ2	2	<b>88001†</b>	0	†	350/3,500		35		
		RT3	2	<b>37069</b>	0		500/5,000	750/7,500	25		
		SQ3	2	<b>37096</b>	0		500/5,000	650/6,500	40		
		SQ3	2	<b>44007</b>	0		500/5,000	1,000/10,000	20		
		SQ3	2	<b>51020</b>	0		500/5,000	1,000/10,000	15		
		SQ4	2	<b>36099</b>	0		600/6,000	1,000/10,000	20		
		SQ4	2	<b>51095</b>	0	FP,GP	600/6,000	1,000/10,000	20		
		RT4	2	<b>37034</b>	0		700/7,000	1,200/12,000	25		
		RT4	2	<b>37094</b>	0		700/7,000	1,200/12,000	25		
RT4	2	<b>44673</b>	0	FP,HM	900/6,000	1,000/10,000	20				
SQ5	2	<b>96920</b>	0	GP,SU	1,000/10,000	1,300/13,000	30				
<b>F-250 Super Duty Except Cab &amp; Chassis</b>	<b>99-01</b>	RT3	2	<b>37069</b>	0		500/5,000	750/7,500	30		
		SQ4	2	<b>44141</b>	0	HM	600/6,000	1,000/10,000	20		
		SQ4	2	<b>51068</b>	0	HM	600/6,000	1,000/10,000	20		
		SQ4	2	<b>51095</b>	0	FP,GP	600/6,000	1,000/10,000	20		
		RT4	2	<b>37034</b>	0		700/7,000	1,200/12,000	30		
		RT4	2	<b>44673</b>	0	FP,HM	900/6,000	1,000/10,000	20		
		SQ5	2	<b>96922</b>	0	GP	1,000/10,000	1,200/12,000	15		
		SQ5	2	<b>96931</b>	0	HM,SH	1,200/12,000	1,500/15,000	30		
SQ5	2	<b>45708</b>	0	CS,EF,HM,LT,M	2,000/18,000	2,500/18,000	50				
<b>F-250 Super Duty Except Cab &amp; Chassis</b>	<b>99-04</b>	SQ2	2	<b>88001†</b>	0	†	350/3,500		35		
		SQ3	2	<b>37096</b>	0		500/5,000	650/6,500	40		
		RT4	2	<b>37094</b>	0		700/7,000	1,200/12,000	30		
<b>F-250 Super Duty w/Deep Drop Bumper</b>	<b>99-01</b>	SQ5	2	<b>45714†</b>	0		1,200/12,000	1,700/14,000	20		
		SQ5	2-1/2	<b>45012†</b>	0	†	1,200/12,000	1,700/14,000	20		

<p>† Available while supply lasts.</p> <p>CS Will fit with full-size spare tire stowed under vehicle.</p> <p>EF Fits all models with standard bumpers.</p> <p>FP Spare tire repositioning and/or modification of spare tire carrier may be required.</p> <p>GP Hitch cross-tube concealed behind bumper.</p> <p>HM Hitch cross-tube is visible beneath bumper.</p> <p>JL Installation requires OEM bumper and brackets.</p> <p>LT Requires removal of factory hitch if equipped.</p> <p>M Will fit with heavy-duty suspension.</p> <p>0 Uses all existing holes. No drilling required.</p> <p>SH Hitches produced before 09/27/07 are rated at 1200/12000 WC &amp; 1400/14000 WD.</p> <p>SU Hitches produced before 03/11/08 are rated at 1000/10000 WC &amp; 1200/12000 WD.</p>	<p><b>RT3</b> Round Tube Class III 2"</p> <p><b>RT4</b> Round Tube Class IV 2"</p> <p><b>SQ2</b> Square Tube Class II</p> <p><b>SQ3</b> Square Tube Class III</p> <p><b>SQ4</b> Square Tube Class IV</p> <p><b>SQ5</b> Square Tube Class V</p>
--	--

# RECEIVER HITCH AND T-CONNECTOR APPLICATION GUIDE

RECEIVER HITCHES

MODEL / STYLE	YEAR	TRAILER HITCHES								T-CONNECTOR	
		REC TYPE	REC SIZE	PART NO.	NO DRILL	FOOTNOTES	WC (LBS.)	WD (LBS.)	IN	T-CON PART NO.	FN
<b>FORD (Continued)</b>											
F-250 Super Duty Except Cab & Chassis	02-04	RT3	2	37069			500/5,000	750/7,500	30		
		SQ4	2	44141	Ø	HM	600/6,000	1,000/10,000	20		
		SQ4	2	51068	Ø	HM	600/6,000	1,000/10,000	20		
		SQ4	2	51095	Ø	FP,GP	600/6,000	1,000/10,000	20		
		RT4	2	37034			700/7,000	1,200/12,000	30		
		RT4	2	44673	Ø	FP,HM	900/6,000	1,000/10,000	20		
		SQ5	2	96922	Ø	GP	1,000/10,000	1,200/12,000	15		
		SQ5	2	96931	Ø	HM,SH	1,200/12,000	1,500/15,000	30		
F-250 Super Duty w/Deep Drop Bumper	02-04	SQ5	2	45708	Ø	CS,EF,HM,LT,M	2,000/18,000	2,500/18,000	50		
		SQ5	2-1/2	45012†	Ø	†	1,200/12,000	1,700/14,000	20		
F-250 Super Duty Except Cab & Chassis	05-07	SQ4	2	44141	Ø	EB,HM	600/6,000	1,000/10,000	20		
		SQ4	2	51068	Ø	EB,HM	600/6,000	1,000/10,000	20		
		SQ4	2	51095	Ø	FP,GP	600/6,000	1,000/10,000	20		
		RT4	2	44673	Ø	FP,HM	900/6,000	1,000/10,000	20		
		SQ5	2	96931	Ø	EB,HM,SH	1,200/12,000	1,500/15,000	30		
F-250 Super Duty Except Cab & Chassis	08-20	SQ5	2	45708	Ø	CS,EF,HM,LT,M	2,000/18,000	2,500/18,000	50		
		SQ5	2	96931	Ø	EB,HM,SH	1,200/12,000	1,500/15,000	30		
F-250 Super Duty Except Cab & Chassis	21	SQ5	2	45708	Ø	CS,EF,HM,LT,M	2,000/18,000	2,500/18,000	50		
		SQ5	2	96931	Ø	EB,HM,SH	1,200/12,000	1,500/15,000	30		
F-350 Super Duty Cab & Chassis, w/34" Wide Frames	99-00	SQ4	2	37087		FP	600/6,000	1,000/10,000	45		
		SQ4	2	37088			750/7,500	1,200/12,000	60		
		SQ5	2	96938		CC	1,200/12,000	1,500/15,000	40		
		SQ5	2	96947			1,600/15,000	1,600/16,000	35		
		SQ5	2	96943			2,400/16,000	1,600/16,000	40		
		SQ5	2-1/2	45014†	†		1,200/12,000	1,700/14,000	60		
		SQ5	2-1/2	45716†	†		1,200/12,000	1,700/14,000	60		
F-350 Super Duty Cab & Chassis, w/34" Wide Frames & w/Deep Drop Bumper	99-00	SQ3	2	37081		FP,M	500/5,000	1,000/10,000	40		
F-350 Super Duty Except Cab & Chassis	99-01	RT3	2	37069			500/5,000	750/7,500	30		
		SQ4	2	44141	Ø	HM	600/6,000	1,000/10,000	20		
		SQ4	2	51068	Ø	HM	600/6,000	1,000/10,000	20		
		SQ4	2	51095	Ø	FP,GP	600/6,000	1,000/10,000	20		
		RT4	2	37034			700/7,000	1,200/12,000	30		
		RT4	2	44673	Ø	FP,HM	900/6,000	1,000/10,000	20		
		SQ5	2	96922	Ø	GP	1,000/10,000	1,200/12,000	15		
		SQ5	2	96931	Ø	HM,SH	1,200/12,000	1,500/15,000	30		
F-350 Super Duty Except Cab & Chassis	99-04	SQ2		88001†		†	350/3,500		35		
		SQ3	2	37096			500/5,000	650/6,500	40		
		RT4	2	37094			700/7,000	1,200/12,000	30		
F-350 Super Duty w/Deep Drop Bumper	99-01	SQ5	2	45714†	Ø		1,200/12,000	1,700/14,000	20		
		SQ5	2-1/2	45012†	Ø	†	1,200/12,000	1,700/14,000	20		
F-350 Super Duty Cab & Chassis, w/34" Wide Frames	01-04	SQ5	2	96947			1,600/15,000	1,600/16,000	35		
		SQ5	2	96943			2,400/16,000	1,600/16,000	40		

† Available while supply lasts.  
**CC** Requires minimum of 19 in. from end of frame rail to spring shackle bracket.  
**CS** Will fit with full-size spare tire stowed under vehicle.  
**EB** Factory electrical bracket will NOT fit with this hitch. Must use aftermarket electrical box or bracket.  
**EF** Fits all models with standard bumpers.  
**FP** Spare tire repositioning and/or modification of spare tire carrier may be required.  
**GP** Hitch crosstube concealed behind bumper.  
**HM** Hitch crosstube is visible beneath bumper.  
**LT** Requires removal of factory hitch if equipped.  
**M** Will fit with heavy-duty suspension.  
**Ø** Uses all existing holes. No drilling required.  
**SH** Hitches produced before 09/27/07 are rated at 1200/12000 WC & 1400/14000 WD.

**RT3** Round Tube Class III 2"  
**RT4** Round Tube Class IV 2"  
**SQ2** Square Tube Class II  
**SQ3** Square Tube Class III  
**SQ4** Square Tube Class IV  
**SQ5** Square Tube Class V

F - FORD

# RECEIVER HITCH AND T-CONNECTOR APPLICATION GUIDE

MODEL / STYLE	YEAR	TRAILER HITCHES								T-CONNECTOR	
		REC TYPE	REC SIZE	PART NO.	NO DRILL	FOOTNOTES	WC (LBS.)	WD (LBS.)	IN	T-CON PART NO.	FN
<b>FORD (Continued)</b>											
F-350 Super Duty Except Cab & Chassis	02-04	RT3	2	37069			500/5,000	750/7,500	30		
		SQ4	2	44141	Ø	HM	600/6,000	1,000/10,000	20		
		SQ4	2	51068	Ø	HM	600/6,000	1,000/10,000	20		
		SQ4	2	51095	Ø	FP,GP	600/6,000	1,600/16,000	20		
		RT4	2	37034			700/7,000	1,200/12,000	30		
		RT4	2	44673	Ø	FP,HM	900/6,000	1,000/10,000	20		
		SQ5	2	96922	Ø	GP	1,000/10,000	1,200/12,000	15		
		SQ5	2	96931	Ø	HM,SH	1,200/12,000	1,500/15,000	30		
F-350 Super Duty w/Deep Drop Bumper	02-04	SQ5	2	45714†	Ø		1,200/12,000	1,700/14,000	20		
		SQ5	2-1/2	45012†	Ø	†	1,200/12,000	1,700/14,000	20		
F-350 Super Duty Cab & Chassis, w/34" Wide Frames	05-07	SQ5	2	96947			1,600/15,000	1,600/16,000	35		
		SQ5	2	96943			2,400/16,000	1,600/16,000	40		
F-350 Super Duty Except Cab & Chassis	05-07	SQ4	2	44141	Ø	EB,HM	600/6,000	1,000/10,000	20		
		SQ4	2	51068	Ø	EB,HM	600/6,000	1,000/10,000	20		
		SQ4	2	51095	Ø	FP,GP	600/6,000	1,000/10,000	20		
		RT4	2	44673	Ø	FP,HM	900/6,000	1,000/10,000	20		
		SQ5	2	96931	Ø	EB,HM,SH	1,200/12,000	1,500/15,000	30		
		SQ5	2	45708	Ø	CS,EF,HM,LT,M	2,000/18,000	2,500/18,000	50		
F-350 Super Duty Cab & Chassis, w/34" Wide Frames	08-19	SQ5	2	96943			2,400/16,000	1,600/16,000	40		
F-350 Super Duty Cab & Chassis, w/34" Wide Frames	08-20	SQ5	2	96947			1,600/15,000	1,600/16,000	35		
F-350 Super Duty Except Cab & Chassis	08-20	SQ5	2	96931	Ø	EB,HM,SH	1,200/12,000	1,500/15,000	30		
		SQ5	2	45708	Ø	CS,EF,HM,LT,M	2,000/18,000	2,500/18,000	50		
F-350 Super Duty Except Cab & Chassis	21	SQ5	2	96931	Ø	EB,HM,SH	1,200/12,000	1,500/15,000	30		
		SQ5	2	45708	Ø	CS,EF,HM,LT,M	2,000/18,000	2,500/18,000	50		
F-450 Super Duty Cab & Chassis, w/34" Wide Frames	99-04	SQ4	2	37088			750/7,500	1,200/12,000	60		
		SQ5	2	96947			1,600/15,000	1,600/16,000	35		
		SQ5	2	96943			2,400/16,000	1,600/16,000	40		
		SQ5	2-1/2	45014†	†		1,200/12,000	1,700/14,000	60		
		SQ5	2-1/2	45716†	†		1,200/12,000	1,700/14,000	60		
F-450 Super Duty Cab & Chassis, w/34" Wide Frames	05-07	SQ4	2	37088			750/7,500	1,200/12,000	60		
		SQ5	2	96947			1,600/15,000	1,600/16,000	35		
		SQ5	2	96943			2,400/16,000	1,600/16,000	40		
		SQ5	2-1/2	45014†	†		1,200/12,000	1,700/14,000	60		
		SQ5	2-1/2	45716†	†		1,200/12,000	1,700/14,000	60		
F-450 Super Duty Cab & Chassis, w/34" Wide Frames	08-16	SQ4	2	37088			750/7,500	1,200/12,000	60		
		SQ5	2	96947			1,600/15,000	1,600/16,000	35		
		SQ5	2	96943			2,400/16,000	1,600/16,000	40		
		SQ5	2-1/2	45014†	†		1,200/12,000	1,700/14,000	60		
		SQ5	2-1/2	45716†	†		1,200/12,000	1,700/14,000	60		
F-450 Super Duty Except Cab & Chassis	08-10	SQ5	2	45708	Ø	CS,EF,HM,LT,M	2,000/18,000	2,500/18,000	50		
F-450 Super Duty Except Cab & Chassis	11-20	SQ5	2	45708	Ø	CS,EF,HM,LT,M	2,000/18,000	2,500/18,000	50		
F-450 Super Duty Cab & Chassis, w/34" Wide Frames	17-19	SQ5	2	96943			2,400/16,000	1,600/16,000	40		
F-450 Super Duty Cab & Chassis, w/34" Wide Frames	17-20	SQ4	2	37088			750/7,500	1,200/12,000	60		
		SQ5	2	96947			1,600/15,000	1,600/16,000	35		
		SQ5	2-1/2	45014†	†		1,200/12,000	1,700/14,000	60		
		SQ5	2-1/2	45716†	†		1,200/12,000	1,700/14,000	60		
F-450 Super Duty Except Cab & Chassis	21	SQ5	2	45708	Ø	CS,EF,HM,LT,M	2,000/18,000	2,500/18,000	50		
F-550 Super Duty Cab & Chassis, w/34" Wide Frames	99-04	SQ4	2	37088			750/7,500	1,200/12,000	60		
		SQ5	2	96947			1,600/15,000	1,600/16,000	35		
		SQ5	2	96943			2,400/16,000	1,600/16,000	40		
		SQ5	2-1/2	45014†	†		1,200/12,000	1,700/14,000	60		
		SQ5	2-1/2	45716†	†		1,200/12,000	1,700/14,000	60		

† Available while supply lasts.  
 CS Will fit with full-size spare tire stowed under vehicle.  
 EB Factory electrical bracket will NOT fit with this hitch. Must use aftermarket electrical box or bracket.  
 EF Fits all models with standard bumpers.  
 FP Spare tire repositioning and/or modification of spare tire carrier may be required.  
 GP Hitch crosstube concealed behind bumper.  
 HM Hitch crosstube is visible beneath bumper.  
 LT Requires removal of factory hitch if equipped.  
 M Will fit with heavy-duty suspension.  
 Ø Uses all existing holes. No drilling required.  
 SH Hitches produced before 09/27/07 are rated at 1200/12000 WC & 1400/14000 WD.

**RT3** Round Tube Class III 2"  
**RT4** Round Tube Class IV 2"  
**SQ4** Square Tube Class IV  
**SQ5** Square Tube Class V

# RECEIVER HITCH AND T-CONNECTOR APPLICATION GUIDE

RECEIVER HITCHES

MODEL / STYLE	YEAR	TRAILER HITCHES							T-CONNECTOR		
		REC TYPE	REC SIZE	PART NO.	NO DRILL	FOOTNOTES	WC (LBS.)	WD (LBS.)	IN	T-CON PART NO.	FN
<b>FORD (Continued)</b>											
F-550 Super Duty Cab & Chassis, w/34" Wide Frames	05-07	SQ4	2	37088			750/7,500	1,200/12,000	60		
		SQ5	2	96947			1,600/15,000	1,600/16,000	35		
		SQ5	2	96943			2,400/16,000	1,600/16,000	40		
		SQ5	2-1/2	45014†		†	1,200/12,000	1,700/14,000	60		
		SQ5	2-1/2	45716†		†	1,200/12,000	1,700/14,000	60		
F-550 Super Duty Cab & Chassis, w/34" Wide Frames	08-16	SQ4	2	37088			750/7,500	1,200/12,000	60		
		SQ5	2	96947			1,600/15,000	1,600/16,000	35		
		SQ5	2	96943			2,400/16,000	1,600/16,000	40		
		SQ5	2-1/2	45014†		†	1,200/12,000	1,700/14,000	60		
		SQ5	2-1/2	45716†		†	1,200/12,000	1,700/14,000	60		
F-550 Super Duty Cab & Chassis, w/34" Wide Frames	17-19	SQ5	2	96943			2,400/16,000	1,600/16,000	40		
F-550 Super Duty Cab & Chassis, w/34" Wide Frames	17-20	SQ4	2	37088			750/7,500	1,200/12,000	60		
		SQ5	2	96947			1,600/15,000	1,600/16,000	35		
		SQ5	2-1/2	45014†		†	1,200/12,000	1,700/14,000	60		
		SQ5	2-1/2	45716†		†	1,200/12,000	1,700/14,000	60		
F-550 Super Duty Cab & Chassis, w/34" Wide Frames	21	SQ4	2	37088			750/7,500	1,200/12,000	60		
		SQ5	2	96947			1,600/15,000	1,600/16,000	35		
Fiesta 4 Dr. Sedan	11-13	SQ1	1-1/4	77229	0	HM	200/2,000		15	74699	CH
Fiesta 5 Dr. Hatchback	11-13	SQ1	1-1/4	77961	0	HM, JR, KH	200/2,000		30	78095	CH
Fiesta 4 Dr. Sedan	14-19	SQ1	1-1/4	77297	0	HM	200/2,000		15	85987	CH
Fiesta 5 Dr. Hatchback	14-19	SQ1	1-1/4	77961	0	HM, JR, KH	200/2,000		30	85840	CH
Five Hundred	05-07	SQ2	1-1/4	06301	0	GP, JR	300/3,500		30	78032	
		SQ2	1-1/4	51179	0	GP, JR	300/3,500		30		
		SQ3	2	44525	0	JR	350/3,500	400/4,000	30		
Flex	09-11	RT3	2	44636	0	HM, JR	400/4,000	400/4,000	30	78087	
Flex	12-20	RT3	2	44636	0	HM, JR	400/4,000	400/4,000	30	78087	
Focus Sedan	00	SQ1	1-1/4	77114	0	HM	200/2,000		20		
Focus Wagon (Built Before 11/2002)	00-02	SQ1	1-1/4	77115	0	JR, GP	200/2,000		20	74665	FW
Focus Sedan	01-04	SQ1	1-1/4	77114	0	HM	200/2,000		20		
Focus Wagon (Built After 11/2002)	03-07	SQ1	1-1/4	77115	0	JR, GP	200/2,000		20		
Focus Sedan, Except w/Street Appearance Pkg.	05-07	SQ1	1-1/4	77114	0	HM	200/2,000		20		
Focus	08-11	SQ1	1-1/4	77176	0	HM, JR, KH	200/2,000		30	78019	BN
Focus 5 Dr. Hatchback, Except ST w/Center Exhaust	12-14	SQ1	1-1/4	77256	0	GP, JR, KH	200/2,000		25	85772	CH
Focus Sedan	12-19	SQ1	1-1/4	77256	0	GP, JR, KH	200/2,000		25	85771	CH
Focus 5 Dr. Hatchback, Except ST w/Center Exhaust Models & RS	15-19	SQ1	1-1/4	77256	0	GP, JR, KH	200/2,000		25	85887	CH
Focus RS	16-19	SQ1	1-1/4	77977	0	DU, GP, TA, X	200/2,000		60	85771	CH
Focus ZX3 3 Dr. Hatchback, Except SVT & w/Street Appearance Pkg.	00-06	SQ1	1-1/4	77114		HM	200/2,000		20		
Focus ZX5 5 Dr. Hatchback, Except SVT & w/Street Appearance Pkg.	02-06	SQ1	1-1/4	77114		HM	200/2,000		20		
Freestar	04-07	SQ2	1-1/4	06989	0	GP, JR	300/3,500		25	78022	CH
		SQ3	2	44129		GP, JR	350/3,500	500/5,000	30		
Freestyle	05-07	SQ2	1-1/4	06301	0	GP, JR	300/3,500		30	78032	
		SQ2	1-1/4	51179	0	GP, JR	300/3,500		30		
		SQ3	2	44525	0	JR	350/3,500	400/4,000	30		
Fusion	06-09	SQ1	1-1/4	77152		GP, JR, TA	200/2,000		45	74699	CH
Fusion	10-12	SQ1	1-1/4	77239	0	GP, JR	200/2,000		20	74699	CH
Fusion Except Sport	13-20	SQ1	1-1/4	77285	0	HM, SV	200/2,000		20	85801	CH
Mustang Except Cobra SVT	99-04	SQ1	1-1/4	77029		RB, GP	200/2,000		20	74428	
Mustang Except GT/CS (California Special)/Shelby GT/GT500	05-09	SQ1	1-1/4	77124†		†, GP, JR	200/2,000		45		
		SQ1	1-1/4	77242		GP, JR	200/2,000		45		
Mustang V6 Models	11-14	SQ1	1-1/4	77238	0	HM, JR	200/2,000		40	85706	CH

† Available while supply lasts.  
 BN Exterior mounted plug on some or all models. May require an aftermarket electrical mounting box or bracket. (Sold separately)  
 CH T-One is equipped with circuit protected ModuLite® module.  
 DU Fascia removal required.  
 FW 2003 Models w/Build date before 11/1/02.  
 GP Hitch crosstube concealed behind bumper.  
 HM Hitch crosstube is visible beneath bumper.  
 JR Exhaust must be temporarily lowered for installation.  
 KH Minor heat shield modification may be required.  
 0 Uses all existing holes. No drilling required.  
 RB Hitch installation can be made easier with a cutter type drill bit.  
 SV Trimming or removal of under body appearance panel may be required.

TA Trunk access required for hitch installation.  
 X Minor fascia trimming required.

RT3 Round Tube Class III 2"  
 SQ1 Square Tube Class I  
 SQ2 Square Tube Class II  
 SQ3 Square Tube Class III  
 SQ4 Square Tube Class IV  
 SQ5 Square Tube Class V

F - FORD

# RECEIVER HITCH AND T-CONNECTOR APPLICATION GUIDE

MODEL / STYLE	YEAR	TRAILER HITCHES							T-CONNECTOR		
		REC TYPE	REC SIZE	PART NO.	NO DRILL	FOOTNOTES	WC (LBS.)	WD (LBS.)	IN	T-CON PART NO.	FN
<b>FORD (Continued)</b>											
Mustang V8 Models	11-14	SQ1	1-1/4	77238	0	GP,HB,JR	200/2,000		40	85706	CH
Mustang	15-17	SQ1	1-1/4	77316	0	HM,JR,AI	200/2,000		30	85706	CH
Mustang	18-20	SQ1	1-1/4	77316	0	HM,JR,AI	200/2,000		30		
Ranger Except Flareside or w/Rear Fascia	98-99	SQ2		88001†		†	350/3,500		35	74424	HG
		SQ3	2	37042	0		500/5,000	600/6,000	40		
		SQ3	2	37152	0		500/5,000	600/6,000	40		
Ranger	99	SQ3	2	44101			300/3,500	500/5,000	20	74424	BN,HG
		SQ3	2	51032		V	300/3,500	500/5,000	20		
Ranger	00-03	SQ3	2	44101			300/3,500	500/5,000	20	74665	BN
		SQ3	2	51032		V	300/3,500	500/5,000	20		
Ranger Except Flareside or w/Rear Fascia	00-03	SQ2		88001†		†	350/3,500		35	74665	
		SQ3	2	37042	0		500/5,000	600/6,000	40		
		SQ3	2	37152	0		500/5,000	600/6,000	40		
Ranger	04-11	SQ3	2	44101			300/3,500	500/5,000	20		
		SQ3	2	51032		V	300/3,500	500/5,000	20		
Ranger Except Flareside or w/Rear Fascia	04-11	SQ2		88001†		†	350/3,500		35		
		SQ3	2	37042	0		500/5,000	600/6,000	40		
		SQ3	2	37152	0		500/5,000	600/6,000	40		
Ranger	13-16	SQ3	2	84790	0	HM,CS	600/4,000	600/6,000	30	85919	CH,BN
Ranger	19-20	SQ3	2	84275	0	CP,J	1,125/7,500	1,200/8,000	20		
Taurus 4 Dr. Sedan, Except SHO	96-99	SQ1	1-1/4	77017	0	GP,JR	200/2,000		20	74657	HG
Taurus Wagon	96-99	SQ1	1-1/4	77017	0	GP,JR	200/2,000		20		
Taurus 4 Dr. Sedan	00-03	SQ1	1-1/4	77017	0	GP,JR	200/2,000		20	85243	
		SQ2	1-1/4	06991	0	GP,JR	300/3,500		40		
Taurus Wagon	00-03	SQ1	1-1/4	77017	0	GP,JR	200/2,000		20		
		SQ2	1-1/4	06991	0	GP,JR	300/3,500		40		
Taurus 4 Dr. Sedan	04-06	SQ2	1-1/4	06991	0	GP,JR	300/3,500		40		
Taurus Wagon	04-06	SQ2	1-1/4	06991	0	GP,JR	300/3,500		40		
Taurus 4 Dr. Sedan	08-09	SQ2	1-1/4	06301	0	GP,JR	300/3,500		30	78069	
		SQ2	1-1/4	51179	0	GP,JR	300/3,500		30		
		SQ3	2	44525	0	JR	350/3,500	400/4,000	30		
Taurus 4 Dr. Sedan	10-19	SQ2	1-1/4	06121		GP,JR	300/3,500		30	85831	CH
		SQ3	2	44632		GP,JR	400/4,000	400/4,000	30		
Taurus X	08-09	SQ2	1-1/4	06301	0	GP,JR	300/3,500		30	78068	
		SQ2	1-1/4	51179	0	GP,JR	300/3,500		30		
		SQ3	2	44525	0	JR	350/3,500	400/4,000	30		
Transit Connect	10-13	RT3	2	44634	0		350/3,500	400/4,000	20	85816	BN,CH
Transit Connect	14-21	RT3	2	44702	0	HM	400/3,500	400/4,000	15	85855	BN,CH
Transit-150 Except Cab & Chassis and the Cutaway	15-20	RT3	2	44719	0	HM	750/5,000	800/8,000	25	85863	CH
Transit-250 Except Cab & Chassis and the Cutaway	15-20	RT3	2	44719	0	HM	750/5,000	800/8,000	25	85863	CH
Transit-350 Except Single Rear Wheel w/148" Wheelbase or Cab & Chassis and the Cutaway	15-20	RT3	2	44719	0	HM	750/5,000	800/8,000	25	85936	BN,CH
Transit-350 Single Rear Wheel w/148" Wheelbase, Except Cab & Chassis and the Cutaway	15-20	RT3	2	44719	0	HM	750/5,000	800/8,000	25	85863	BN,CH
Windstar (Built Before 11/2002)	99-03	SQ2		88001†	0	†	350/3,500		40	74226	FW,LS
		SQ2	1-1/4	06967	0	GP	300/3,500		30		
		SQ3	2	37042	0	AF	500/5,000	600/6,000	40		
		SQ3	2	37152	0	AF	500/5,000	600/6,000	40		
Windstar (Built After 11/2002)	03	SQ2		88001†	0	†	350/3,500		40	85290	FW,LS
		SQ2	1-1/4	06967	0	GP	300/3,500		30		
		SQ3	2	37042	0	AF	500/5,000	600/6,000	40		
		SQ3	2	37152	0	AF	500/5,000	600/6,000	40		

† Available while supply lasts.  
**AF** Hitch is ONLY rated for Weight Carrying at 3500 lbs. GTW / 350 lbs. TW and DO NOT use Weight Distribution Spring Bars for this Specific Vehicle. Except for long bed pickups.  
**AI** Additional installation time may be required.  
**BN** Exterior mounted plug on some or all models. May require an aftermarket electrical mounting box or bracket. (Sold separately)  
**CH** T-One is equipped with circuit protected ModuLite® module.  
**CP** Fits all models without factory installed receiver.  
**CS** Will fit with full-size spare tire stowed under vehicle.  
**FV** 2003 Models w/Build date after 11/1/02.  
**FW** 2003 Models w/Build date before 11/1/02.  
**GP** Hitch cross-tube concealed behind bumper.  
**HB** Slight fascia deformation may occur on some models.  
**HG** T-One incorporates taillight converter.

**HM** Hitch cross-tube is visible beneath bumper.  
**J** Under vehicle spare tire stowage is retained.  
**JR** Exhaust must be temporarily lowered for installation.  
**LS** T-One incorporates low-side switching taillight converter. Additional installation time required.  
**0** Uses all existing holes. No drilling required.  
**V** For vehicles with factory installed step bumpers only.

**RT3** Round Tube Class III 2"  
**SQ1** Square Tube Class I  
**SQ2** Square Tube Class II  
**SQ3** Square Tube Class III



# RECEIVER HITCH AND T-CONNECTOR APPLICATION GUIDE

RECEIVER HITCHES

MODEL / STYLE	YEAR	TRAILER HITCHES								T-CONNECTOR	
		REC TYPE	REC SIZE	PART NO.	NO DRILL	FOOTNOTES	WC (LBS.)	WD (LBS.)	IN	T-CON PART NO.	FN
<b>FREIGHTLINER</b>											
Sprinter 2500 w/41" Wide Frames, Except 118" Wheelbase & Factory Metal Step Platform	03-06	SQ3	2	33089	0	†,HM	500/5,000	750/7,500	20		
Sprinter 2500 144" & 170" Wheelbase, Except w/Factory Step Bumper	07-09	SQ4	2	44576	0	HM,UL	600/6,000	750/7,500	20	85925	CH
Sprinter 2500 w/Factory Step Bumper Excluding Models w/30-3/8" Frame Width	07-09	SQ3	2	44591	0	HM	500/5,000	750/7,500	30	85925	CH
Sprinter 2500 144" & 170" Wheelbase, Except w/Factory Step Bumper	10-12	SQ4	2	44576	0	HM,UL	600/6,000	750/7,500	20	85925	CH
Sprinter 2500 w/Factory Step Bumper Excluding Models w/30-3/8" Frame Width	10-12	SQ3	2	44591	0	HM	500/5,000	750/7,500	30	85925	CH
Sprinter 2500 144" & 170" Wheelbase, Except w/Factory Step Bumper	13	SQ4	2	44576	0	HM,UL	600/6,000	750/7,500	20	85925	CH
Sprinter 2500 w/Factory Step Bumper Excluding Models w/30-3/8" Frame Width	13	SQ3	2	44591	0	HM	500/5,000	750/7,500	30	85925	CH
Sprinter 3500 144" & 170" Wheelbase, Except w/Factory Step Bumper	07-09	SQ4	2	44576	0	HM,UL	600/6,000	750/7,500	20	85925	CH
Sprinter 3500 w/Factory Step Bumper Excluding Models w/30-3/8" Frame Width	07-09	SQ3	2	44591	0	HM	500/5,000	750/7,500	30	85925	CH
Sprinter 3500 144" & 170" Wheelbase, Except w/Factory Step Bumper	10-12	SQ4	2	44576	0	HM,UL	600/6,000	750/7,500	20	85925	CH
Sprinter 3500 w/Factory Step Bumper Excluding Models w/30-3/8" Frame Width	10-12	SQ3	2	44591	0	HM	500/5,000	750/7,500	30	85925	CH
Sprinter 3500 144" & 170" Wheelbase, Except w/Factory Step Bumper	13	SQ4	2	44576	0	HM,UL	600/6,000	750/7,500	20	85925	CH
Sprinter 3500 w/Factory Step Bumper Excluding Models w/30-3/8" Frame Width	13	SQ3	2	44591	0	HM	500/5,000	750/7,500	30	85925	CH
<b>GMC</b>											
Acadia	07-12	RT3	2	51083	0	RT,GP,JP	500/5,000	500/5,000	25	78009	BN
		RT3	2	44569	0	GP,JP,TN	750/5,000	750/7,500	25		
Acadia	13-16	RT3	2	51083	0	RT,GP,JP	500/5,000	500/5,000	25	85836	BN
		RT3	2	44569	0	GP,JP,TN	750/5,000	750/7,500	25		
Acadia	17	SQ3	2	84023	0	GP,JP,AA,DU,SV,TA	675/4,500	675/4,500	90	85918	BN
Acadia	18-20	SQ3	2	84023	0	GP,JP,AA,DU,SV,TA	675/4,500	675/4,500	90	85918	BN
Acadia	21	SQ3	2	84023	0	GP,JP,AA,DU,SV,TA	675/4,500	675/4,500	90	85918	BN
Acadia Limited	17	RT3	2	51083	0	RT,GP,JP	500/5,000	500/5,000	25	85836	BN
		RT3	2	44569	0	GP,JP,TN	750/5,000	750/7,500	25		
C/K Series 2 Dr. Regular & Extended Cabs w/6 ft. Bed	88-00	SQ3	2	37096		CA,HX	500/5,000	650/6,500	90	74180	
C/K Series 2 Dr. Regular & Extended Cabs w/8 ft. Bed	88-00	SQ2		88001†		†	350/3,500		35	74180	
		SQ3	2	37096		CA,HX	500/5,000	650/6,500	90		
C/K Series 4 Dr. Crew Cab w/8 ft. Bed	92-00	SQ3	2	37096		CA,HX	500/5,000	650/6,500	90	74180	
C1500 w/34" Wide Frames	85-99	SQ5	2	96938		CC	1,200/12,000	1,500/15,000	40		
		SQ5	2	96947			1,600/15,000	1,600/16,000	35		
C1500	88-99	RT3	2	37069			500/5,000	750/7,500	40	85741	BN
		SQ3	2	44105	0	GP	500/5,000	1,000/10,000	25		
		SQ3	2	51016		HM,FP	500/5,000	1,000/10,000	40		
		SQ3	2	51021	0	HM,J	500/5,000	1,000/10,000	20		
		SQ3	2	51022	0	GP	500/5,000	1,000/10,000	20		
		SQ4	2	96524	0	GP	600/6,000	1,000/10,000	20		
		RT4	2	37034			700/7,000	1,200/12,000	40		
		SQ5	2	96901		DB,GP,SN	1,000/10,000	1,300/13,000	30		
C1500 2 Dr. Regular & Extended Cabs w/6 ft. Bed	88-00	RT4	2	37094			700/7,000	1,200/12,000	40	74180	
C1500 2 Dr. Regular & Extended Cabs w/8 ft. Bed	88-99	RT4	2	37094			700/7,000	1,200/12,000	40	74180	

† Available while supply lasts.  
**AA** Requires temporary removal of bumper during installation.  
**BN** Exterior mounted plug on some or all models. May require an aftermarket electrical mounting box or bracket. (Sold separately)  
**CA** Models with dual exhaust require exhaust modification.  
**CC** Requires minimum of 19 in. from end of frame rail to spring shackle bracket.  
**CH** T-One is equipped with circuit protected ModuLite® module.  
**DB** Will not fit 6 ft. bed pickups.  
**DU** Fascia removal required.  
**FP** Spare tire repositioning and/or modification of spare tire carrier may be required.  
**GP** Hitch crosstube concealed behind bumper.  
**HM** Hitch crosstube is visible beneath bumper.  
**HX** Minor exhaust modification may be required.

**J** Under vehicle spare tire storage is retained.  
**JR** Exhaust must be temporarily lowered for installation.  
**0** Uses all existing holes. No drilling required.  
**RT** Round Tube Class III/IV 2"  
**SN** Hitches produced before 04/28/08 are rated at 1000/10000 WC & 1200/12000 WD.  
**SV** Trimming or removal of under body appearance panel may be required.  
**TA** Trunk access required for hitch installation.  
**TN** Hitches produced before 07/09/12 are rated at 500/5000 WC & 500/5000 WD.  
**UL** This hitch will not fit a Sprinter single or dual rear-wheel vehicle with a 30-3/8 in. wide frame measured outside of frame to outside of frame.

**RT3** Round Tube Class III 2"  
**RT4** Round Tube Class IV 2"  
**SQ2** Square Tube Class II  
**SQ3** Square Tube Class III  
**SQ4** Square Tube Class IV  
**SQ5** Square Tube Class V

G - GMC

# RECEIVER HITCH AND T-CONNECTOR APPLICATION GUIDE

MODEL / STYLE	YEAR	TRAILER HITCHES							T-CONNECTOR		
		REC TYPE	REC SIZE	PART NO.	NO DRILL	FOOTNOTES	WC (LBS.)	WD (LBS.)	IN	T-CON PART NO.	FN
<b>GMC (Continued)</b>											
C1500 w/10" Deep Drop Bumper	88-99	SQ4	2	96528	0	FS,J	600/6,000	1,000/10,000	20	85741	BN
C1500 w/Aftermarket Roll Pan	88-99	SQ3	2	96522		CO,HK	500/5,000	550/5,500	40	85741	BN
C1500 4 Dr. Crew Cab w/8 ft. Bed	92-99	RT4	2	37094			700/7,000	1,200/12,000	40	74180	
C2500 w/34" Wide Frames	85-00	SQ5	2	96938		CC	1,200/12,000	1,500/15,000	40		
		SQ5	2	96947			1,600/15,000	1,600/16,000	35		
C2500	88-00	RT3	2	37069			500/5,000	750/7,500	40	85741	BN
		SQ3	2	44105	0	GP	500/5,000	1,000/10,000	25		
		SQ3	2	51016		HM,FP	500/5,000	1,000/10,000	40		
		SQ3	2	51021	0	HM,J	500/5,000	1,000/10,000	20		
		SQ3	2	51022	0	GP	500/5,000	1,000/10,000	20		
		SQ4	2	96524	0	GP	600/6,000	1,000/10,000	20		
		RT4	2	37034			700/7,000	1,200/12,000	40		
		SQ5	2	96901		DB,GP,SN	1,000/10,000	1,300/13,000	30		
SQ5	2	45706			1,200/12,000	1,700/14,000	45				
C2500 2 Dr. Regular & Extended Cabs w/6 ft. Bed	88-00	RT4	2	37094			700/7,000	1,200/12,000	40	74180	
C2500 2 Dr. Regular & Extended Cabs w/8 ft. Bed	88-99	RT4	2	37094			700/7,000	1,200/12,000	40	74180	
C2500 w/10" Deep Drop Bumper	88-00	SQ4	2	96528	0	FS,J	600/6,000	1,000/10,000	20	85741	BN
C2500 w/Aftermarket Roll Pan	88-00	SQ3	2	96522		CO,HK	500/5,000	550/5,500	40	85741	BN
C2500 4 Dr. Crew Cab w/8 ft. Bed	92-00	RT4	2	37094			700/7,000	1,200/12,000	40	74180	
C3500 w/34" Wide Frames	85-00	SQ5	2	96938		CC	1,200/12,000	1,500/15,000	40		
		SQ5	2	96947			1,600/15,000	1,600/16,000	35		
C3500	88-00	RT3	2	37069			500/5,000	750/7,500	40	85741	BN
		SQ3	2	44105	0	GP	500/5,000	1,000/10,000	25		
		SQ3	2	51016		HM,FP	500/5,000	1,000/10,000	40		
		SQ3	2	51021	0	HM,J	500/5,000	1,000/10,000	20		
		SQ3	2	51022	0	GP	500/5,000	1,000/10,000	20		
		SQ4	2	96524	0	GP	600/6,000	1,000/10,000	20		
		RT4	2	37034			700/7,000	1,200/12,000	40		
		SQ5	2	96901		DB,GP,SN	1,000/10,000	1,300/13,000	30		
SQ5	2	45706			1,200/12,000	1,700/14,000	45				
C3500 2 Dr. Regular & Extended Cabs w/6 ft. Bed	88-00	RT4	2	37094			700/7,000	1,200/12,000	40	74180	
C3500 2 Dr. Regular & Extended Cabs w/8 ft. Bed	88-00	RT4	2	37094			700/7,000	1,200/12,000	40	74180	
C3500 w/10" Deep Drop Bumper	88-00	SQ4	2	96528	0	FS,J	600/6,000	1,000/10,000	20	85741	BN
C3500 w/Aftermarket Roll Pan	88-00	SQ3	2	96522		CO,HK	500/5,000	550/5,500	40	85741	BN
C3500 4 Dr. Crew Cab w/8 ft. Bed	92-00	RT4	2	37094			700/7,000	1,200/12,000	40	74180	
C4500 Topkick Cab & Chassis, w/34" Wide Frames	03-09	SQ5	2	96947			1,600/15,000	1,600/16,000	35		
C5000 2 Dr. Regular & Extended Cabs w/6 ft. Bed	88-00	RT4	2	37094			700/7,000	1,200/12,000	40	74180	
C5500 Topkick Cab & Chassis, w/34" Wide Frames	03-09	SQ5	2	96947			1,600/15,000	1,600/16,000	35		
C6500 Topkick Cab & Chassis, w/34" Wide Frames	99-09	SQ5	2	96947			1,600/15,000	1,600/16,000	35		
C7000 2 Dr. Regular & Extended Cabs w/6 ft. Bed	88-00	RT4	2	37094			700/7,000	1,200/12,000	40	74180	
C7500 Topkick Cab & Chassis, w/34" Wide Frames	99-09	SQ5	2	96947			1,600/15,000	1,600/16,000	35		
Canyon	04-12	SQ4	2	44593	0	CP,GP	600/6,000	750/7,500	25	78001	BN,CG
		SQ4	2	51074	0	CP,GP	600/6,000	750/7,500	25		
Canyon	15-20	SQ3	2	97239†	0	HM,V,SO	500/5,000	600/6,000	25		
		RT4	2	44757	0	HM,AA,V,SO,TZ	800/6,000	800/8,000	35		
		SQ4	2	84999	0	HM,AA,V,SO,TZ	800/8,000	1000/10,000	35		
Jimmy Downsize	98-05	RT3	2	37041		FP,JT,KK	500/5,000	600/6,000	30		
Jimmy Downsize	99-01	SQ2	1-1/4	06955†	0	FP,GP,KK	300/3,500		15		
		RT3	2	33015	0	FP,KK,SD	400/4,000	600/6,000	15		
		SQ3	2	44098	0	FP,HM,KK	400/4,000	600/6,000	20		
		SQ3	2	51031	0	FP,HM,KK	400/4,000	600/6,000	15		
Jimmy Downsize	02	RT3	2	33015	0	FP,KK,SD	400/4,000	600/6,000	15		

<b>AA</b> Requires temporary removal of bumper during installation.	<b>J</b> Under vehicle spare tire stowage is retained.
<b>BN</b> Exterior mounted plug on some or all models. May require an aftermarket electrical mounting box or bracket. (Sold separately)	<b>JT</b> 2WD models only.
<b>CC</b> Requires minimum of 19 in. from end of frame rail to spring shackle bracket.	<b>KK</b> When installing on a vehicle originally equipped with an OEM hitch. OEM bumper brackets must be purchased and installed prior to new hitch installation.
<b>CG</b> T-One incorporates circuit protected taillight converter.	<b>0</b> Uses all existing holes. No drilling required.
<b>CO</b> Will not fit 8 ft. 2500/3500 Series with heavy-duty suspension or four door Crew Cab.	<b>SD</b> Hitches produced before 07/21/06 are rated at 350/3500 WC.
<b>CP</b> Fits all models without factory installed receiver.	<b>SN</b> Hitches produced before 04/28/08 are rated at 1000/10000 WC & 1200/12000 WD.
<b>DB</b> Will not fit 6 ft. bed pickups.	<b>SO</b> With this hitch installed the step bumper is no longer able to be used as a towing point.
<b>FP</b> Spare tire repositioning and/or modification of spare tire carrier may be required.	<b>TZ</b> Requires replacement of the impact structure with hitch.
<b>FS</b> Includes 2 & 4 WD models with heavy duty suspension.	<b>V</b> For vehicles with factory installed step bumpers only.
<b>GP</b> Hitch cross tube concealed behind bumper.	

<b>RT3</b> Round Tube Class III 2"
<b>RT4</b> Round Tube Class IV 2"
<b>SQ2</b> Square Tube Class II
<b>SQ3</b> Square Tube Class III
<b>SQ4</b> Square Tube Class IV
<b>SQ5</b> Square Tube Class V

# RECEIVER HITCH AND T-CONNECTOR APPLICATION GUIDE

RECEIVER HITCHES

MODEL / STYLE	YEAR	TRAILER HITCHES								T-CONNECTOR	
		REC TYPE	REC SIZE	PART NO.	NO DRILL	FOOTNOTES	WC (LBS.)	WD (LBS.)	IN	T-CON PART NO.	FN
<b>GMC (Continued)</b>											
Jimmy Downsize	02-05	SQ2	1-1/4	069551	0	FP,GP,KK	300/3,500		15		
		SQ3	2	44098	0	FP,HM,KK	400/4,000	600/6,000	20		
		SQ3	2	51031	0	FP,HM,KK	400/4,000	600/6,000	15		
K1500	88-99	RT3	2	37069			500/5,000	750/7,500	40	85741	BN
		SQ3	2	44105	0	GP	500/5,000	1,000/10,000	25		
		SQ3	2	51021	0	HM,J	500/5,000	1,000/10,000	20		
		SQ3	2	51022	0	GP	500/5,000	1,000/10,000	20		
		SQ4	2	96524	0	GP	600/6,000	1,000/10,000	20		
		RT4	2	37034			700/7,000	1,200/12,000	40		
		SQ5	2	96901		DB,GP,SN	1,000/10,000	1,300/13,000	30		
K1500 2 Dr. Regular & Extended Cabs w/6 ft. Bed	88-99	RT4	2	37094			700/7,000	1,200/12,000	40	74180	
K1500 2 Dr. Regular & Extended Cabs w/8 ft. Bed	88-99	RT4	2	37094			700/7,000	1,200/12,000	40	74180	
K1500 w/10" Deep Drop Bumper	88-99	SQ4	2	96528	0	FS,J	600/6,000	1,000/10,000	20	85741	BN
K1500 w/34" Wide Frames	88-99	SQ5	2	96938		CC	1,200/12,000	1,500/15,000	40		
		SQ5	2	96947			1,600/15,000	1,600/16,000	35		
K1500 w/Aftermarket Roll Pan	88-99	SQ3	2	96522		CO,HK	500/5,000	550/5,500	40	85741	BN
K1500 4 Dr. Crew Cab w/8 ft. Bed	92-99	RT4	2	37094			700/7,000	1,200/12,000	40	74180	
K2500	88-00	RT3	2	37069			500/5,000	750/7,500	40	85741	BN
		SQ3	2	44105	0	GP	500/5,000	1,000/10,000	25		
		SQ3	2	51021	0	HM,J	500/5,000	1,000/10,000	20		
		SQ3	2	51022	0	GP	500/5,000	1,000/10,000	20		
		SQ4	2	96524	0	GP	600/6,000	1,000/10,000	20		
		RT4	2	37034			700/7,000	1,200/12,000	40		
		SQ5	2	96901		DB,GP,SN	1,000/10,000	1,300/13,000	30		
		SQ5	2	45706			1,200/12,000	1,700/14,000	45		
K2500 2 Dr. Regular & Extended Cabs w/6 ft. Bed	88-00	RT4	2	37094			700/7,000	1,200/12,000	40	74180	
K2500 2 Dr. Regular & Extended Cabs w/8 ft. Bed	88-00	RT4	2	37094			700/7,000	1,200/12,000	40	74180	
K2500 w/10" Deep Drop Bumper	88-00	SQ4	2	96528	0	FS,J	600/6,000	1,000/10,000	20	85741	BN
K2500 w/34" Wide Frames	88-00	SQ5	2	96938		CC	1,200/12,000	1,500/15,000	40		
		SQ5	2	96947			1,600/15,000	1,600/16,000	35		
K2500 w/Aftermarket Roll Pan	88-00	SQ3	2	96522		CO,HK	500/5,000	550/5,500	40	85741	BN
K2500 4 Dr. Crew Cab w/8 ft. Bed	92-00	RT4	2	37094			700/7,000	1,200/12,000	40	74180	
K3500	88-00	RT3	2	37069			500/5,000	750/7,500	40	85741	BN
		SQ3	2	44105	0	GP	500/5,000	1,000/10,000	25		
		SQ3	2	51021	0	HM,J	500/5,000	1,000/10,000	20		
		SQ3	2	51022	0	GP	500/5,000	1,000/10,000	20		
		SQ4	2	96524	0	GP	600/6,000	1,000/10,000	20		
		RT4	2	37034			700/7,000	1,200/12,000	40		
		SQ5	2	96901		DB,GP,SN	1,000/10,000	1,300/13,000	30		
		SQ5	2	45706			1,200/12,000	1,700/14,000	45		
K3500 2 Dr. Regular & Extended Cabs w/6 ft. Bed	88-00	RT4	2	37094			700/7,000	1,200/12,000	40	74180	
K3500 2 Dr. Regular & Extended Cabs w/8 ft. Bed	88-00	RT4	2	37094			700/7,000	1,200/12,000	40	74180	
K3500 w/10" Deep Drop Bumper	88-00	SQ4	2	96528	0	FS,J	600/6,000	1,000/10,000	20	85741	BN
K3500 w/34" Wide Frames	88-00	SQ5	2	96938		CC	1,200/12,000	1,500/15,000	40		
		SQ5	2	96947			1,600/15,000	1,600/16,000	35		
K3500 w/Aftermarket Roll Pan	88-00	SQ3	2	96522		CO,HK	500/5,000	550/5,500	40	85741	BN
K3500 4 Dr. Crew Cab w/8 ft. Bed	92-00	RT4	2	37094			700/7,000	1,200/12,000	40	74180	
S15 & Sonoma w/Standard Bed & Step Bumper	98-04	SQ2		880011		†,CN,GU,ST	350/3,500		40	74216	
		SQ3	2	37042		AF,CN,GU,ST	500/5,000	600/6,000	40		

† Available while supply lasts.

**AF** Hitch is ONLY rated for Weight Carrying at 3500 lbs. GTW / 350 lbs. TW and DO NOT use Weight Distribution Spring Bars for this Specific Vehicle. Except for long bed pickups.

**BN** Exterior mounted plug on some or all models. May require an aftermarket electrical mounting box or bracket. (Sold separately)

**CC** Requires minimum of 19 in. from end of frame rail to spring shackle bracket.

**CN** Requires OEM factory bumper for hitch installation.

**CO** Will not fit 8 ft. 2500/3500 Series with heavy-duty suspension or four door Crew Cab.

**DB** Will not fit 6 ft. bed pickups.

**FP** Spare tire repositioning and/or modification of spare tire carrier may be required.

**FS** Includes 2 & 4 WD models with heavy duty suspension.

**GP** Hitch cross-tube concealed behind bumper.

**HM** Hitch cross-tube is visible beneath bumper.

**J** Under vehicle spare tire storage is retained.

**KK** When installing on a vehicle originally equipped with an OEM hitch. OEM bumper brackets must be purchased and installed prior to new hitch installation.

**0** Uses all existing holes. No drilling required.

**SN** Hitches produced before 04/28/08 are rated at 1000/10000 WC & 1200/12000 WD.

**ST** Will not fit 2WD models with short bed.

**RT3** Round Tube Class III 2"

**RT4** Round Tube Class IV 2"

**SQ2** Square Tube Class II

**SQ3** Square Tube Class III

**SQ4** Square Tube Class IV

**SQ5** Square Tube Class V

G - GMC

# RECEIVER HITCH AND T-CONNECTOR APPLICATION GUIDE

MODEL / STYLE	YEAR	TRAILER HITCHES							T-CONNECTOR		
		REC TYPE	REC SIZE	PART NO.	NO DRILL	FOOTNOTES	WC (LBS.)	WD (LBS.)	IN	T-CON PART NO.	FN
<b>GMC (Continued)</b>											
Safari Extended Body	90-05	SQ2		88001†		†	350/3,500				
		SQ2	1-1/4	06037†	0	CS,GP	300/3,500		30		
		SQ2	1-1/4	06227†	0	CS,HM	300/3,500		30		
		SQ3	2	44010	0	CS,GP	300/3,500	600/6,000	30		
		SQ3	2	51029	0	CS,GP	300/3,500	600/6,000	30		
		SQ3	2	37042		AF	500/5,000	600/6,000	65		
Savana 1500	96-99	SQ3	1-1/4	06099	0	HM	300/3,500		15	74659	HG
		SQ3	2	37004	0	HM	500/5,000	1,000/10,000	20		
		RT3	2	37041		HM	500/5,000	600/6,000	35		
		SQ3	2	37152		HM	500/5,000	600/6,000	30		
		SQ3	2	44028	0	HM	500/5,000	1,000/10,000	30		
		SQ3	2	51023	0	HM	500/5,000	1,000/10,000	15		
Savana 1500	00-02	SQ5	2	96946		HM	1,500/10,000	1,300/13,000	35		
		SQ2	1-1/4	06099	0	HM	300/3,500		15	85246	HG
		SQ3	2	37004	0	HM	500/5,000	1,000/10,000	20		
		RT3	2	37041		HM	500/5,000	600/6,000	35		
		SQ3	2	37152		HM	500/5,000	600/6,000	30		
		SQ3	2	44028	0	HM	500/5,000	1,000/10,000	30		
Savana 1500	03	SQ3	2	51023	0	HM	500/5,000	1,000/10,000	15		
		SQ5	2	96946		HM	1,500/10,000	1,300/13,000	35		
		SQ2	1-1/4	06099	0	HM	300/3,500		15	78029	
		SQ3	2	37004	0	HM	500/5,000	1,000/10,000	20		
		SQ3	2	37152		HM	500/5,000	600/6,000	30		
		SQ3	2	44028	0	HM	500/5,000	1,000/10,000	30		
Savana 1500	03-14	SQ3	2	51023	0	HM	500/5,000	1,000/10,000	15		
		SQ5	2	96946		HM	1,500/10,000	1,300/13,000	35		
		RT3	2	37041		HM	500/5,000	600/6,000	35		
		SQ2	1-1/4	06099	0	HM	300/3,500		15	78029	
		SQ3	2	37004	0	HM	500/5,000	1,000/10,000	20		
		SQ3	2	37152		HM	500/5,000	600/6,000	30		
Savana 1500	04-14	SQ3	2	37152		HM	500/5,000	600/6,000	30		
		SQ3	2	44028	0	HM	500/5,000	1,000/10,000	30		
		SQ3	2	51023	0	HM	500/5,000	1,000/10,000	15		
		SQ5	2	96946		HM	1,500/10,000	1,300/13,000	35		
		SQ2	1-1/4	06099	0	HM	300/3,500		15	74659	HG
		SQ3	2	37004	0	HM	500/5,000	1,000/10,000	20		
Savana 2500	96-99	RT3	2	37041		HM	500/5,000	600/6,000	35		
		SQ3	2	37152		HM	500/5,000	600/6,000	30		
		SQ3	2	44028	0	HM	500/5,000	1,000/10,000	30		
		SQ3	2	51023	0	HM	500/5,000	1,000/10,000	15		
		SQ5	2	45707	0	HM	1,200/12,000	1,700/14,000	45		
		SQ5	2	96946		HM	1,500/10,000	1,300/13,000	35		
Savana 2500	00-02	SQ2	1-1/4	06099	0	HM	300/3,500		15	85246	HG
		SQ3	2	37004	0	HM	500/5,000	1,000/10,000	20		
		RT3	2	37041		HM	500/5,000	600/6,000	35		
		SQ3	2	37152		HM	500/5,000	600/6,000	30		
		SQ3	2	44028	0	HM	500/5,000	1,000/10,000	30		
		SQ3	2	51023	0	HM	500/5,000	1,000/10,000	15		
		SQ5	2	45707	0	HM	1,200/12,000	1,700/14,000	45		
		SQ5	2	96946		HM	1,500/10,000	1,300/13,000	35		
		SQ5	2	96946		HM	1,500/10,000	1,300/13,000	35		

<p>† Available while supply lasts.</p> <p><b>AF</b> Hitch is ONLY rated for Weight Carrying at 3500 lbs. GTW / 350 lbs. TW and DO NOT use Weight Distribution Spring Bars for this Specific Vehicle. Except for long bed pickups.</p> <p><b>CS</b> Will fit with full-size spare tire stowed under vehicle.</p> <p><b>GP</b> Hitch crosstube concealed behind bumper.</p> <p><b>HG</b> T-One incorporates taillight converter.</p> <p><b>HM</b> Hitch crosstube is visible beneath bumper.</p> <p><b>0</b> Uses all existing holes. No drilling required.</p>	<p><b>RT3</b> Round Tube Class III 2"</p> <p><b>SQ2</b> Square Tube Class II</p> <p><b>SQ3</b> Square Tube Class III</p> <p><b>SQ5</b> Square Tube Class V</p>
---	--

# RECEIVER HITCH AND T-CONNECTOR APPLICATION GUIDE

RECEIVER HITCHES

MODEL / STYLE	YEAR	TRAILER HITCHES								T-CONNECTOR	
		REC TYPE	REC SIZE	PART NO.	NO DRILL	FOOTNOTES	WC (LBS.)	WD (LBS.)	IN	T-CON PART NO.	FN
<b>GMC (Continued)</b>											
Savana 2500	03	SQ2	1-1/4	06099	0	HM	300/3,500		15	78029	
		SQ3	2	37004	0	HM	500/5,000	1,000/10,000	20		
		SQ3	2	37152		HM	500/5,000	600/6,000	30		
		SQ3	2	44028	0	HM	500/5,000	1,000/10,000	30		
		SQ3	2	51023	0	HM	500/5,000	1,000/10,000	15		
		SQ5	2	45707	0	HM	1,200/12,000	1,700/14,000	45		
SQ5	2	96946		HM	1,500/10,000	1,300/13,000	35				
Savana 2500	03-14	RT3	2	37041		HM	500/5,000	600/6,000	35		
Savana 2500	04-20	SQ2	1-1/4	06099	0	HM	300/3,500		15	78029	
		SQ3	2	37004	0	HM	500/5,000	1,000/10,000	20		
		SQ3	2	37152		HM	500/5,000	600/6,000	30		
		SQ3	2	51023	0	HM	500/5,000	1,000/10,000	15		
		SQ5	2	45707	0	HM	1,200/12,000	1,700/14,000	45		
		SQ5	2	96946		HM	1,500/10,000	1,300/13,000	35		
Savana 3500	96-99	SQ2	1-1/4	06099	0	HM	300/3,500		15	74659	HG
		SQ3	2	37004	0	HM	500/5,000	1,000/10,000	20		
		RT3	2	37041		HM	500/5,000	600/6,000	35		
		SQ3	2	37152		HM	500/5,000	600/6,000	30		
		SQ3	2	44028	0	HM	500/5,000	1,000/10,000	30		
		SQ3	2	51023	0	HM	500/5,000	1,000/10,000	15		
		SQ5	2	45707	0	HM	1,200/12,000	1,700/14,000	45		
		SQ5	2	96946		HM	1,500/10,000	1,300/13,000	35		
		SQ5	2	96946		HM	1,500/10,000	1,300/13,000	35		
Savana 3500	00-02	SQ2	1-1/4	06099	0	HM	300/3,500		15	85246	HG
		SQ3	2	37004	0	HM	500/5,000	1,000/10,000	20		
		RT3	2	37041		HM	500/5,000	600/6,000	35		
		SQ3	2	37152		HM	500/5,000	600/6,000	30		
		SQ3	2	44028	0	HM	500/5,000	1,000/10,000	30		
		SQ3	2	51023	0	HM	500/5,000	1,000/10,000	15		
		SQ5	2	45707	0	HM	1,200/12,000	1,700/14,000	45		
		SQ5	2	96946		HM	1,500/10,000	1,300/13,000	35		
		SQ5	2	96946		HM	1,500/10,000	1,300/13,000	35		
Savana 3500	03	SQ2	1-1/4	06099	0	HM	300/3,500		15	78029	
		SQ3	2	37004	0	HM	500/5,000	1,000/10,000	20		
		SQ3	2	37152		HM	500/5,000	600/6,000	30		
		SQ3	2	44028	0	HM	500/5,000	1,000/10,000	30		
		SQ3	2	51023	0	HM	500/5,000	1,000/10,000	15		
		SQ5	2	45707	0	HM	1,200/12,000	1,700/14,000	45		
SQ5	2	96946		HM	1,500/10,000	1,300/13,000	35				
Savana 3500	03-14	RT3	2	37041		HM	500/5,000	600/6,000	35		
Savana 3500	04-20	SQ2	1-1/4	06099	0	HM	300/3,500		15	78029	
		SQ3	2	37004	0	HM	500/5,000	1,000/10,000	20		
		SQ3	2	37152		HM	500/5,000	600/6,000	30		
		SQ3	2	44028	0	HM	500/5,000	1,000/10,000	30		
		SQ3	2	51023	0	HM	500/5,000	1,000/10,000	15		
		SQ5	2	45707	0	HM	1,200/12,000	1,700/14,000	45		
SQ5	2	96946		HM	1,500/10,000	1,300/13,000	35				
Savana 4500	03-14	RT3	2	37041		HM	500/5,000	600/6,000	35		
Savana Van	96-99	SQ2		88001†		†,HM	350/3,500		30	74659	HG
		SQ3	2	37042		HM	500/5,000	600/6,000	30		
Savana Van	00-02	SQ2		88001†		†,HM	350/3,500		30	85246	HG
		SQ3	2	37042		HM	500/5,000	600/6,000	30		
Savana Van	03-14	SQ2		88001†		†,HM	350/3,500		30		
		SQ3	2	37042		HM	500/5,000	600/6,000	30		

† Available while supply lasts.  
 HG T-One incorporates taillight converter.  
 HM Hitch crosstube is visible beneath bumper.  
 0 Uses all existing holes. No drilling required.

RT3 Round Tube Class III 2"  
 SQ2 Square Tube Class II  
 SQ3 Square Tube Class III  
 SQ5 Square Tube Class V

G - GMC



# RECEIVER HITCH AND T-CONNECTOR APPLICATION GUIDE

MODEL / STYLE	YEAR	TRAILER HITCHES								T-CONNECTOR	
		REC TYPE	REC SIZE	PART NO.	NO DRILL	FOOTNOTES	WC (LBS.)	WD (LBS.)	IN	T-CON PART NO.	FN
<b>GMC (Continued)</b>											
Sierra 1500	99-02	RT3	2	37069	0		500/5,000	750/7,500	25		
		RT3	2	51072	0	RT,JL	500/5,000	750/7,500	15		
		RT4	2	51081	0	RT,JL	600/6,000	1,050/10,500	15		
		RT4	2	37034	0		700/7,000	1,200/12,000	25		
		SQ4	2	37016	0		750/7,500	1,200/12,000	20		
		RT4	2	44563	0	JL,SZ	900/6,000	1,050/10,500	15		
		RT4	2	44564	0	JL	900/6,000	900/8,000	15		
		SQ5	2	96932	0	HM,JL	1,200/12,000	1,400/14,000	20		
Sierra 1500	99-05	SQ2		88001†		†,DB	350/3,500		35	85262	RD
		SQ3	2	37096	0	JL	500/5,000	650/6,500	35		
		RT4	2	37094	0		700/7,000	1,200/12,000	25		
Sierra 1500 (Classic)	03-07	RT3	2	37069	0		500/5,000	750/7,500	25		
		RT3	2	51072	0	RT,JL	500/5,000	750/7,500	15		
		RT4	2	51081	0	RT,JL	600/6,000	1,050/10,500	15		
		RT4	2	37034	0		700/7,000	1,200/12,000	25		
		SQ4	2	37016	0		750/7,500	1,200/12,000	20		
		RT4	2	44563	0	JL,SZ	900/6,000	1,050/10,500	15		
		RT4	2	44564	0	JL	900/6,000	900/8,000	15		
		SQ5	2	96932	0	HM,JL	1,200/12,000	1,400/14,000	20		
Sierra 1500	06	SQ2		88001†		†,DB	350/3,500		35	85262	RD
		SQ3	2	37096	0	JL	500/5,000	650/6,500	35		
		RT4	2	37094	0		700/7,000	1,200/12,000	25		
Sierra 1500	07-13	RT3	2	51072	0	RT,JL	500/5,000	750/7,500	15	85877	BN
		RT4	2	51081	0	RT,JL	600/6,000	1,050/10,500	15		
		RT4	2	44563	0	JL,SZ	900/6,000	1,050/10,500	15		
		RT4	2	44564	0	JL	900/6,000	900/8,000	15		
Sierra 1500 (Classic)	07	SQ2		88001†		†,DB	350/3,500		35	85262	RD
		SQ3	2	37096	0	JL	500/5,000	650/6,500	35		
		RT4	2	37094	0		700/7,000	1,200/12,000	25		
Sierra 1500 LD (Old Body Style)	14-19	SQ3	2	51235†	0	†,HM,JL	500/5,000	800/8,000	15	85877	
		SQ3	2	97235†	0	HM,JL	500/5,000	800/8,000	15		
		RT4	2	44703	0	HM,JL	900/6,000	1,200/12,000	20		
		SQ4	2	84016	0	GP,JL	900/6,000	1,000/10,000	25		
Sierra 1500	19-20	SQ3	2	84326	0	CP	900/6,000	1,000/10,000	60		
Sierra 1500	21	SQ3	2	84326	0	CP	900/6,000	1,000/10,000	60		
Sierra 1500 HD	01-02	RT3	2	37069	0		500/5,000	750/7,500	25		
		RT3	2	51072	0	RT,JL	500/5,000	750/7,500	15		
		RT4	2	51081	0	RT,JL	600/6,000	1,050/10,500	15		
		RT4	2	37034	0		700/7,000	1,200/12,000	25		
		SQ4	2	37016	0		750/7,500	1,200/12,000	20		
		RT4	2	44563	0	JL,SZ	900/6,000	1,050/10,500	15		
		RT4	2	44564	0	JL	900/6,000	900/8,000	15		
		SQ5	2	96932	0	HM,JL	1,200/12,000	1,400/14,000	20		
Sierra 1500 HD 6.6 ft. Bed	01-05	SQ2		88001†		†,DB	350/3,500		35	85262	RD
		SQ3	2	37096	0	JL	500/5,000	650/6,500	35		
		RT4	2	37094	0		700/7,000	1,200/12,000	25		

† Available while supply lasts.  
**BN** Exterior mounted plug on some or all models. May require an aftermarket electrical mounting box or bracket. (Sold separately)  
**CP** Fits all models without factory installed receiver.  
**DB** Will not fit 6 ft. bed pickups.  
**GP** Hitch crossbar concealed behind bumper.  
**HM** Hitch crossbar is visible beneath bumper.  
**JL** Installation requires OEM bumper and brackets.  
**0** Uses all existing holes. No drilling required.  
**RD** For vehicles equipped with factory tow package may require additional components or may be used as a replacement harness.  
**RT** Round Tube Class III/IV 2"  
**SZ** Hitches produced before 03/10/11 are rated at 600/6000 WC.

**RT3** Round Tube Class III 2"  
**RT4** Round Tube Class IV 2"  
**SQ2** Square Tube Class II  
**SQ3** Square Tube Class III  
**SQ4** Square Tube Class IV  
**SQ5** Square Tube Class V

# RECEIVER HITCH AND T-CONNECTOR APPLICATION GUIDE

RECEIVER HITCHES

MODEL / STYLE	YEAR	TRAILER HITCHES								T-CONNECTOR	
		REC TYPE	REC SIZE	PART NO.	NO DRILL	FOOTNOTES	WC (LBS.)	WD (LBS.)	IN	T-CON PART NO.	FN
<b>GMC (Continued)</b>											
Sierra 1500 HD	03	RT3	2	37069	0		500/5,000	750/7,500	25		
		RT3	2	51072	0	RT,JL	500/5,000	750/7,500	15		
		RT4	2	51081	0	RT,JL	600/6,000	1,050/10,500	15		
		RT4	2	37034	0		700/7,000	1,200/12,000	25		
		SQ4	2	37016	0		750/7,500	1,200/12,000	20		
		RT4	2	44563	0	JL,SZ	900/6,000	1,050/10,500	15		
Sierra 1500 HD	05-07	RT4	2	44564	0	JL	900/6,000	900/8,000	15		
		SQ5	2	96932	0	HM,JL	1,200/12,000	1,400/14,000	20		
Sierra 1500 HD (Classic)	05-07	SQ4	2	37016	0		750/7,500	1,200/12,000	20		
Sierra 1500 HD 6.6 ft. Bed	06	RT3	2	37069	0		500/5,000	750/7,500	25		
		RT3	2	51072	0	RT,JL	500/5,000	750/7,500	15		
		RT4	2	51081	0	RT,JL	600/6,000	1,050/10,500	15		
		RT4	2	37034	0		700/7,000	1,200/12,000	25		
		RT4	2	44563	0	JL,SZ	900/6,000	1,050/10,500	15		
		RT4	2	44564	0	JL	900/6,000	900/8,000	15		
Sierra 1500 HD 6.6 ft. Bed (Classic)	07	SQ5	2	96932	0	HM,JL	1,200/12,000	1,400/14,000	20		
		SQ2		88001†		†,DB	350/3,500		35	85262	RD
Sierra 1500 HD 6.6 ft. Bed (Classic)	07	SQ3	2	37096	0	JL	500/5,000	650/6,500	35		
		RT4	2	37094	0		700/7,000	1,200/12,000	25		
		SQ2		88001†		†,DB	350/3,500		35	85262	RD
Sierra 2500	99-02	SQ3	2	37096	0	JL	500/5,000	650/6,500	35		
		RT4	2	37094	0		700/7,000	1,200/12,000	25		
		RT3	2	37069	0		500/5,000	750/7,500	25		
		RT3	2	51072	0	RT,JL	500/5,000	750/7,500	15		
		RT4	2	51081	0	RT,JL	600/6,000	1,050/10,500	15		
		RT4	2	37034	0		700/7,000	1,200/12,000	25		
Sierra 2500	99-04	SQ4	2	37016	0		750/7,500	1,200/12,000	20		
		RT4	2	44563	0	JL,SZ	900/6,000	1,050/10,500	15		
		RT4	2	44564	0	JL	900/6,000	900/8,000	15		
		RT4	2	96932	0	HM,JL	1,200/12,000	1,400/14,000	20		
		SQ5	2	96932	0	HM,JL	1,200/12,000	1,400/14,000	20		
		SQ5	2-1/2	45009†	0	†	1,200/12,000	1,700/14,000	20		
Sierra 2500	03-04	SQ2		88001†		†,DB	350/3,500		35	85262	RD
		RT4	2	37094	0		700/7,000	1,200/12,000	25		
Sierra 2500	01-02	RT3	2	37069	0		500/5,000	750/7,500	25		
		RT3	2	51072	0	RT,JL	500/5,000	750/7,500	15		
		RT4	2	51081	0	RT,JL	600/6,000	1,050/10,500	15		
		RT4	2	37034	0		700/7,000	1,200/12,000	25		
		SQ4	2	37016	0		750/7,500	1,200/12,000	20		
		RT4	2	44563	0	JL,SZ	900/6,000	1,050/10,500	15		
Sierra 2500	01-06	RT4	2	44564	0	JL	900/6,000	900/8,000	15		
		SQ5	2	96932	0	HM,JL	1,200/12,000	1,400/14,000	20		
		SQ5	2-1/2	45009†	0	†	1,200/12,000	1,700/14,000	20		
		SQ2		88001†		†,DB	350/3,500		35	85262	RD
		SQ3	2	37096	0	JL	500/5,000	650/6,500	40		
		SQ5	2-1/2	45717	0	#,CS,FS,LT	1,300/13,000	1,700/17,000	25		
Sierra 2500 HD	01-02	RT3	2	51073	0	RT,CS,FS,JL,LT	500/5,000	750/7,500	20		
Sierra 2500 HD	01-02	RT4	2	44577	0	CS,FS,JL,LT	600/6,000	1,100/11,000	20		
		SQ4	2	44657	0	HM,SA	600/6,000	1,200/12,000	20		
		SQ5	2	96944	0	CS,FS,HM,LT	1,950/13,000	1,600/16,000	25		
		SQ5	2-1/2	45717	0	#,CS,FS,LT	1,300/13,000	1,700/17,000	25		
Sierra 2500 HD	01-02	SQ2		88001†		†,DB	350/3,500		35	85262	RD
Sierra 2500 HD 8 ft. Bed	01-02	SQ3	2	37096	0	JL	500/5,000	650/6,500	40		
Sierra 2500 HD 8 ft. Bed	01-02	SQ5	2-1/2	45719	0	#,CS,FS,LT	2,000/18,000	2,500/18,000	25		

<p># Titan hitches require use of a 2-1/2" shank Titan ball mount.</p> <p>† Available while supply lasts.</p> <p>CS Will fit with full-size spare tire stowed under vehicle.</p> <p>DB Will not fit 6 ft. bed pickups.</p> <p>FS Includes 2 &amp; 4 WD models with heavy duty suspension.</p> <p>HM Hitch crosstube is visible beneath bumper.</p> <p>JL Installation requires OEM bumper and brackets.</p> <p>LT Requires removal of factory hitch if equipped.</p> <p>0 Uses all existing holes. No drilling required.</p> <p>RD For vehicles equipped with factory tow package may require additional components or may be used as a replacement harness.</p> <p>RT Round Tube Class III/IV 2"</p> <p>SA Requires drilling on 6 ft. bed models.</p>	<p>SZ Hitches produced before 03/10/11 are rated at 600/6000 WC.</p>	<p>RT3 Round Tube Class III 2"</p> <p>RT4 Round Tube Class IV 2"</p> <p>SQ2 Square Tube Class II</p> <p>SQ3 Square Tube Class III</p> <p>SQ4 Square Tube Class IV</p> <p>SQ5 Square Tube Class V</p>
--	--	--

# RECEIVER HITCH AND T-CONNECTOR APPLICATION GUIDE

MODEL / STYLE	YEAR	TRAILER HITCHES								T-CONNECTOR	
		REC TYPE	REC SIZE	PART NO.	NO DRILL	FOOTNOTES	WC (LBS.)	WD (LBS.)	IN	T-CON PART NO.	FN
<b>GMC (Continued)</b>											
Sierra 2500 HD (Classic)	03-07	RT3	2	51073	0	RT,CS,FS,JL,LT	500/5,000	750/7,500	20		
		RT4	2	44577	0	CS,FS,JL,LT	600/6,000	1,100/11,000	20		
		SQ4	2	44657	0	HM,SA	600/6,000	1,200/12,000	20		
		SQ5	2	96944	0	CS,FS,HM,LT	1,950/13,000	1,600/16,000	25		
		SQ5	2-1/2	45717	0	#,CS,FS,LT	1,300/13,000	1,700/17,000	25		
Sierra 2500 HD 8 ft. Bed	03-06	SQ5	2-1/2	45719	0	#,CS,FS,LT	2,000/18,000	2,500/18,000	25		
Sierra 2500 HD	07-10	RT3	2	51073	0	RT,CS,FS,JL,LT	500/5,000	750/7,500	20	85877	BN
		RT4	2	44577	0	CS,FS,JL,LT	600/6,000	1,100/11,000	20		
		SQ5	2	96944	0	CS,FS,HM,LT	1,950/13,000	1,600/16,000	25		
		SQ5	2-1/2	45717	0	#,CS,FS,LT	1,300/13,000	1,700/17,000	25		
Sierra 2500 HD (Classic)	07	SQ2	2	88001†		†,DB	350/3,500		35	85262	RD
		SQ3	2	37096	0	JL	500/5,000	650/6,500	40		
Sierra 2500 HD 8 ft. Bed	07-10	SQ5	2-1/2	45719	0	#,CS,FS,LT	2,000/18,000	2,500/18,000	25	85877	BN
Sierra 2500 HD 8 ft. Bed (Classic)	07	SQ5	2-1/2	45719	0	#,CS,FS,LT	2,000/18,000	2,500/18,000	25		
Sierra 2500 HD	11-14	SQ4	2	44653	0	CS,FS,GP,JL,LT	800/8,000	1,200/12,000	20	85877	BN
		SQ5	2	96942	0	CS,FS,GP,JL,KH,LT	1,500/15,000	1,600/16,000	20		
		SQ5	2	45710	0	CS,FS,HM,JL,KH,LT	2,000/18,000	2,500/18,000	60		
		SQ5	2-1/2	45300†	0	†,CS,FS,HM,JL,KH,LT	2,000/18,000	2,500/18,000	60		
Sierra 2500 HD	15-19	SQ4	2	44749	0	HM,JL	1,200/8,000	1,200/12,000	30		
		SQ5	2	96950	0	CS,FS,GP,JL,KH,LT	1,700/15,000	1,700/17,000	60		
		SQ5	2	45711	0	HM	2,700/20,000	2,700/20,000	60		
Sierra 3500	01-02	RT3	2	51073	0	RT,CS,FS,JL,LT	500/5,000	750/7,500	20		
		RT4	2	44577	0	CS,FS,JL,LT	600/6,000	1,100/11,000	20		
		SQ4	2	44657	0	HM,SA	600/6,000	1,200/12,000	20		
		SQ5	2	96944	0	CS,FS,HM,LT	1,950/13,000	1,600/16,000	25		
		SQ5	2-1/2	45717	0	#,CS,FS,LT	1,300/13,000	1,700/17,000	25		
Sierra 3500 8 ft. Bed	01-06	SQ2	2	88001†		†,DB	350/3,500		35	85262	RD
Sierra 3500 Cab & Chassis, w/34" Wide Frames (Classic)	01-07	SQ5	2	96936			1,200/12,000		30		
		SQ5	2	96938		CC	1,200/12,000	1,500/15,000	40		
		SQ5	2	96947			1,600/15,000	1,600/16,000	35		
Sierra 3500 (Classic)	03-07	RT3	2	51073	0	RT,CS,FS,JL,LT	500/5,000	750/7,500	20		
		RT4	2	44577	0	CS,FS,JL,LT	600/6,000	1,100/11,000	20		
		SQ4	2	44657	0	HM,SA	600/6,000	1,200/12,000	20		
		SQ5	2	96944	0	CS,FS,HM,LT	1,950/13,000	1,600/16,000	25		
		SQ5	2-1/2	45717	0	#,CS,FS,LT	1,300/13,000	1,700/17,000	25		
		SQ5	2-1/2	45719	0	#,CS,FS,LT	2,000/18,000	2,500/18,000	25		
Sierra 3500 8 ft. Bed (Classic)	07	SQ2	2	88001†		†,DB	350/3,500		35	85262	RD
Sierra 3500 HD	07-10	RT3	2	51073	0	RT,CS,FS,JL,LT	500/5,000	750/7,500	20	85877	BN
		RT4	2	44577	0	CS,FS,JL,LT	600/6,000	1,100/11,000	20		
		SQ5	2	96944	0	CS,FS,HM,LT	1,950/13,000	1,600/16,000	25		
		SQ5	2-1/2	45717	0	#,CS,FS,LT	1,300/13,000	1,700/17,000	25		
		SQ5	2-1/2	45719	0	#,CS,FS,LT	2,000/18,000	2,500/18,000	25		
Sierra 3500 HD Cab & Chassis, w/34" Wide Frames	07-20	SQ5	2	96936			1,200/12,000		30		
		SQ5	2	96938		CC	1,200/12,000	1,500/15,000	40		
		SQ5	2	96947			1,600/15,000	1,600/16,000	35		
Sierra 3500 HD	11-14	SQ4	2	44653	0	CS,FS,GP,JL,LT	800/8,000	1,200/12,000	20	85877	BN
		SQ5	2	96942	0	CS,FS,GP,JL,KH,LT	1,500/15,000	1,600/16,000	20		
		SQ5	2	45710	0	CS,FS,HM,JL,KH,LT	2,000/18,000	2,500/18,000	60		
		SQ5	2-1/2	45300†	0	†,CS,FS,HM,JL,KH,LT	2,000/18,000	2,500/18,000	60		
Sierra 3500 HD	15-19	SQ4	2	44749	0	HM,JL	1,200/8,000	1,200/12,000	30	85877	BN
		SQ5	2	96950	0	CS,FS,GP,JL,KH,LT	1,700/15,000	1,700/17,000	60		
		SQ5	2	45711	0	HM	2,700/20,000	2,700/20,000	60		

#	Titan hitches require use of a 2-1/2" shank Titan ball mount.	0	Uses all existing holes. No drilling required.	RT3	Round Tube Class III 2"
†	Available while supply lasts.	RD	For vehicles equipped with factory tow package may require additional components or may be used as a replacement harness.	RT4	Round Tube Class IV 2"
BN	Exterior mounted plug on some or all models. May require an aftermarket electrical mounting box or bracket. (Sold separately)	RT	Round Tube Class III/IV 2"	SQ2	Square Tube Class II
CC	Requires minimum of 19 in. from end of frame rail to spring shackle bracket.	SA	Requires drilling on 6 ft. bed models.	SQ3	Square Tube Class III
CS	Will fit with full-size spare tire stowed under vehicle.			SQ4	Square Tube Class IV
DB	Will not fit 6 ft. bed pickups.			SQ5	Square Tube Class V
FS	Includes 2 & 4 WD models with heavy duty suspension.				
GP	Hitch crosstube concealed behind bumper.				
HM	Hitch crosstube is visible beneath bumper.				
JL	Installation requires OEM bumper and brackets.				
KH	Minor heat shield modification may be required.				
LT	Requires removal of factory hitch if equipped.				

# RECEIVER HITCH AND T-CONNECTOR APPLICATION GUIDE

RECEIVER HITCHES

MODEL / STYLE	YEAR	TRAILER HITCHES								T-CONNECTOR	
		REC TYPE	REC SIZE	PART NO.	NO DRILL	FOOTNOTES	WC (LBS.)	WD (LBS.)	IN	T-CON PART NO.	FN
<b>GMC (Continued)</b>											
Sonoma	98-04	SQ2	1-1/4	06958	0	GU,RH,GP	300/3,500		35	74216	BN
		SQ3	2	44062		CN,GU	350/3,500	500/5,000	20		
		SQ3	2	51063		CN,GP,GU	350/3,500	500/5,000	20		
Suburban	92-99	SQ2		88001†		†	350/3,500		30	74180	
		SQ3	2	37042			500/5,000	600/6,000	30		
Suburban C1500	92-99	SQ3	2	37152			500/5,000	600/6,000	30	74180	BN
		SQ3	2	44656		HM	500/5,000	750/7,500	30		
		SQ4	2	37074		HM	600/6,000	1,000/10,000	30		
Suburban C2500	92-99	SQ3	2	37152			500/5,000	600/6,000	30	74180	BN
		SQ3	2	44656		HM	500/5,000	750/7,500	30		
		SQ4	2	37074		HM	600/6,000	1,000/10,000	30		
Suburban K1500	92-99	SQ3	2	37152			500/5,000	600/6,000	30	74180	BN
		SQ3	2	44656		HM	500/5,000	750/7,500	30		
		SQ4	2	37074		HM	600/6,000	1,000/10,000	30		
Suburban K2500	92-99	SQ3	2	37152			500/5,000	600/6,000	30	74180	BN
		SQ3	2	44656		HM	500/5,000	750/7,500	30		
		SQ4	2	37074		HM	600/6,000	1,000/10,000	30		
Terrain	10-17	SQ2	1-1/4	06391	0	HM	300/3,500		25	85716	CH
		SQ2	1-1/4	51185	0	HM	300/3,500		25		
		SQ3	2	51193	0	HM	350/3,500	400/4,000	30		
		SQ3	2	84028	0	HM	675/4,500	675/4,500	30		
Terrain	18-17	SQ2	1-1/4	06391	0	HM	300/3,500		25		CH
Terrain	18-20	SQ2	1-1/4	51185	0	HM	300/3,500		25		CH
		SQ3	2	51193	0	HM	350/3,500	400/4,000	30		
Terrain Diesel	18-20	SQ3	2	84217	0	AI,DU,JR,TZ,X	675/4,500	675/4,500	70	89505	BN,CH
Terrain Except Diesel	18-20	SQ2	1-1/4	06180	0	JR	350/3,500		35	89505	BN,CH
		SQ3	2	84419	0	JR	675/4,500	675/4,500	35		
Terrain Except Diesel	21	SQ2	1-1/4	06180	0	JR	350/3,500		35	89505	BN,CH
		SQ3	2	84419	0	JR	675/4,500	675/4,500	35		
Yukon	92-00	SQ2		88001†		†	350/3,500		30	74180	
		SQ3	2	37042			500/5,000	600/6,000	30		
		SQ3	2	37152			500/5,000	600/6,000	30		
		SQ3	2	44656		HM	500/5,000	750/7,500	30		
Yukon w/Amber Turn Signals	00-02	SQ4	2	37074		HM	600/6,000	1,000/10,000	30		
		RT4	2	51201	0	RT,CN,HM	500/5,000	600/6,000	30		
		RT4	2	44668	0	CN,HM	600/6,000	800/8,000	15		
Yukon w/Amber Turn Signals	00-06	SQ2		88001†		†	350/3,500		30	85262	
		SQ3	2	37042			500/5,000	600/6,000	30		
Yukon w/Amber Turn Signals	03-06	SQ3	2	37152			500/5,000	600/6,000	30	85877	BN
		RT4	2	51201	0	RT,CN,HM	600/6,000	800/8,000	15		
		RT4	2	44668	0	CN,HM	900/6,000	1,000/10,000	15		
Yukon Denali	99-00	SQ3	2	37042			500/5,000	600/6,000	30	74180	
		SQ3	2	37152			500/5,000	600/6,000	30		
		SQ3	2	44656		HM	500/5,000	750/7,500	30		
		SQ4	2	37074		HM	600/6,000	1,000/10,000	30		
Yukon Denali w/Amber Turn Signals	01-02	SQ3	2	37042			500/5,000	600/6,000	30	85262	
		SQ3	2	37152			500/5,000	600/6,000	30		
		RT4	2	51201	0	RT,CN,HM	600/6,000	800/8,000	15		
		RT4	2	44668	0	CN,HM	900/6,000	1,000/10,000	15		

- † Available while supply lasts.
- AF Hitch is ONLY rated for Weight Carrying at 3500 lbs. GTW / 350 lbs. TW and DO NOT use Weight Distribution Spring Bars for this Specific Vehicle. Except for long bed pickups.
- AI Additional installation time may be required.
- BN Exterior mounted plug on some or all models. May require an aftermarket electrical mounting box or bracket. (Sold separately)
- CH T-One is equipped with circuit protected ModuLite® module.
- CN Requires OEM factory bumper for hitch installation.
- DU Fascia removal required.
- GP Hitch cross-tube concealed behind bumper.
- GU Will not fit vehicles with factory or aftermarket lower Fascia/Rollpan or Tube Bumper.
- HM Hitch cross-tube is visible beneath bumper.
- JR Exhaust must be temporarily lowered for installation.
- 0 Uses all existing holes. No drilling required.

- RH Optional drawbar #36051 required (Sold separately) except for models with ZR2 & Highrider package.
- RT Round Tube Class III/IV 2"
- ST Will not fit 2WD models with short bed.
- TZ Requires replacement of the impact structure with hitch.
- X Minor fascia trimming required.

- RT4 Round Tube Class IV 2"
- SQ2 Square Tube Class II
- SQ3 Square Tube Class III
- SQ4 Square Tube Class IV

G - GMC

# RECEIVER HITCH AND T-CONNECTOR APPLICATION GUIDE

MODEL / STYLE	YEAR	TRAILER HITCHES								T-CONNECTOR	
		REC TYPE	REC SIZE	PART NO.	NO DRILL	FOOTNOTES	WC (LBS.)	WD (LBS.)	IN	T-CON PART NO.	FN
<b>GMC (Continued)</b>											
Yukon XL 1500	00-02	SQ3	2	37152			500/5,000	600/6,000	30	85877	BN
		RT4	2	51201	0	RT,CN,HM	600/6,000	800/8,000	15		
		RT4	2	44668	0	CN,HM	900/6,000	1,000/10,000	15		
		SQ5	2	96930		CN,HM	1,000/10,000	1,200/12,000	35		
Yukon XL 1500	00-06	SQ2		88001†		†	350/3,500		30	85262	
		SQ3	2	37042			500/5,000	600/6,000	30		
Yukon XL 1500	03-06	SQ3	2	37152			500/5,000	600/6,000	30	85877	BN
		RT4	2	51201	0	RT,CN,HM	600/6,000	800/8,000	15		
		RT4	2	44668	0	CN,HM	900/6,000	1,000/10,000	15		
		SQ5	2	96930		CN,HM	1,000/10,000	1,200/12,000	35		
Yukon XL 1500 Denali	01-02	SQ3	2	37042			500/5,000	600/6,000	30	85262	
		SQ3	2	37152			500/5,000	600/6,000	30		
		RT4	2	51201	0	RT,CN,HM	600/6,000	800/8,000	15		
		RT4	2	44668	0	CN,HM	900/6,000	1,000/10,000	15		
		SQ5	2	96930		CN,HM	1,000/10,000	1,200/12,000	35		
Yukon XL 2500	00-02	SQ3	2	37152			500/5,000	600/6,000	30	85877	BN
		RT4	2	51201	0	RT,CN,HM	600/6,000	800/8,000	15		
		RT4	2	44668	0	CN,HM	900/6,000	1,000/10,000	15		
		SQ5	2	96930		CN,HM	1,000/10,000	1,200/12,000	35		
		SQ5	2	45715			1,200/12,000	1,700/14,000	50		
Yukon XL 2500	03-06	SQ3	2	37152			500/5,000	600/6,000	30	85877	BN
		RT4	2	51201	0	RT,CN,HM	600/6,000	800/8,000	15		
		RT4	2	44668	0	CN,HM	900/6,000	1,000/10,000	15		
		SQ5	2	96930		CN,HM	1,000/10,000	1,200/12,000	35		
		SQ5	2	45715			1,200/12,000	1,700/14,000	50		
<b>HONDA</b>											
Accord Sedan	98-02	SQ1	1-1/4	77165	0	JR,HM	200/2,000		15	74660	HG
Accord Coupe	03-05	SQ1	1-1/4	77161	0	HR,JR,HM	200/2,000		25	74718	CG
Accord Sedan	03-05	SQ1	1-1/4	77161	0	HR,JR,HM	200/2,000		25	78002	HG
Accord Coupe	06-07	SQ1	1-1/4	77161	0	HR,JR,HM	200/2,000		25	74713	HG
Accord Sedan	06-07	SQ1	1-1/4	77161	0	HR,JR,HM	200/2,000		25	78002	HG
Accord Coupe	08-12	SQ1	1-1/4	77287	0	HM,JR,KH	200/2,000		30	74697	CG
Accord Sedan	08-12	SQ1	1-1/4	77287	0	HM,JR,KH	200/2,000		30	74697	CG
Accord Coupe, Except w/LED Taillights	13-15	SQ1	1-1/4	77287	0	HM,JR,KH,SV	200/2,000		30	85828	CH
Accord Sedan, Except w/LED Taillights	13-15	SQ1	1-1/4	77287	0	HM,JR,KH,SV	200/2,000		30	85828	CH
Accord Sedan, w/LED Taillights	13-15	SQ1	1-1/4	77287	0	HM,JR,KH,SV	200/2,000		30	85859	CH
Accord Coupe	16-17	SQ1	1-1/4	77287	0	HM,JR,KH	200/2,000		30	85828	CH
Accord Sedan	16-17	SQ1	1-1/4	77287	0	HM,JR,KH,SV	200/2,000		30	85903	CH
Accord	18-20	SQ1	1-1/4	77972	0	GP,AA,DU,TA	200/2,000		60	89504	CH
Accord Crosstour	10-11	SQ1	1-1/4	77224	0	HM,JR,KH	200/2,000		40	85721	CH
Civic 3 Dr. Hatchback	96-00	SQ1	1-1/4	77194†		X,GP	200/2,000		20		
Civic	99-00	SQ1	1-1/4	77025	0	HM	200/2,000		15		
Civic	01-05	SQ1	1-1/4	77116		HM	200/2,000		15		
Civic Si	02-05	SQ1	1-1/4	77033		TA,GP	200/2,000		30		
Civic 2 Dr. Coupe, Except Si	06-15	SQ1	1-1/4	51165	0	HM,JR	200/2,000		30	74714	CG
		SQ1	1-1/4	77139	0	HM,JR	200/2,000		30		
Civic 4 Dr. Sedan, Except Hybrid & Si	06-15	SQ1	1-1/4	51165	0	HM,JR	200/2,000		30	74697	CG
		SQ1	1-1/4	77139	0	HM,JR	200/2,000		30		
Civic Hybrid	06-11	SQ1	1-1/4	51165	0	HM,JR	200/2,000		30		
		SQ1	1-1/4	77139	0	HM,JR	200/2,000		30		
Civic Si, 2 Dr. Coupe	06-11	SQ1	1-1/4	51165	0	HM,JR	200/2,000		30		
		SQ1	1-1/4	77139	0	HM,JR	200/2,000		30		

† Available while supply lasts.	<b>KH</b> Minor heat shield modification may be required.	<b>RT4</b> Round Tube Class IV 2"
<b>AA</b> Requires temporary removal of bumper during installation.	<b>0</b> Uses all existing holes. No drilling required.	<b>SQ1</b> Square Tube Class I
<b>BN</b> Exterior mounted plug on some or all models. May require an aftermarket electrical mounting box or bracket. (Sold separately)	<b>RT</b> Round Tube Class III/IV 2"	<b>SQ2</b> Square Tube Class II
<b>CG</b> T-One incorporates circuit protected taillight converter.	<b>SV</b> Trimming or removal of under body appearance panel may be required.	<b>SQ3</b> Square Tube Class III
<b>CH</b> T-One is equipped with circuit protected ModuLite® module.	<b>TA</b> Trunk access required for hitch installation.	<b>SQ5</b> Square Tube Class V
<b>CN</b> Requires OEM factory bumper for hitch installation.	<b>X</b> Minor fascia trimming required.	
<b>DU</b> Fascia removal required.		
<b>GP</b> Hitch crossbar concealed behind bumper.		
<b>HG</b> T-One incorporates taillight converter.		
<b>HM</b> Hitch crossbar is visible beneath bumper.		
<b>HR</b> Requires drilling of heat shields on V6 models.		
<b>JR</b> Exhaust must be temporarily lowered for installation.		



# RECEIVER HITCH AND T-CONNECTOR APPLICATION GUIDE

RECEIVER HITCHES

MODEL / STYLE	YEAR	TRAILER HITCHES							T-CONNECTOR		
		REC TYPE	REC SIZE	PART NO.	NO DRILL	FOOTNOTES	WC (LBS.)	WD (LBS.)	IN	T-CON PART NO.	FN
<b>HONDA (Continued)</b>											
Civic Si, 4 Dr. Sedan	06-11	SQ1	1-1/4	51165	0	HM, JR	200/2,000		30		
		SQ1	1-1/4	77139	0	HM, JR	200/2,000		30		
Civic Hybrid	12-15	SQ1	1-1/4	51165		HM, JR, KH, SV	200/2,000		35		
		SQ1	1-1/4	77139		HM, JR, KH, SV	200/2,000		35		
Civic Coupe	16	SQ1		77333†		†, EP, GP, AA, DU	200/2,000		65	85937	CH
Civic Coupe, Except Models w/Center Exhaust	16	SQ1		77336		DU, X, GP, TA	200/2,000		65	85937	CH
Civic Hatchback, Except Models w/Center Exhaust	16-20	SQ1		77336		DU, X, GP, TA	200/2,000		65		
Civic Sedan	16	SQ1		77333†		†, EP, GP, AA, DU	200/2,000		65	85943	CH
		SQ1	1-1/4	77325†	0	†, EP, GP, AA, DU	200/2,000		65		
Civic Sedan, Except Models w/Center Exhaust	16-20	SQ1		77336		DU, X, GP, TA	200/2,000		65	85943	CH
Civic Coupe, Except Models w/Center Exhaust	17-20	SQ1		77336		DU, X, GP, TA	200/2,000		65		
Crosstour	12	SQ1	1-1/4	77224	0	HM, JR, KH	200/2,000		40	85721	CH
Crosstour	13-15	SQ1	1-1/4	77224	0	HM, JR, KH	200/2,000		40	85835	CH
CR-V	97-01	SQ1	1-1/4	77164	0	RC, GP	200/2,000		20	74660	HG
CR-V	02-06	SQ1	1-1/4	77149	0	BY, JR, HM	200/2,000		20	74660	HG
		SQ3	2	44643	0	BY, HM, JR	350/3,500		30		
CR-V	07-11	SQ1	1-1/4	51168	0	JR	200/2,000		20	74704	CG
		SQ1	1-1/4	77147	0	JR, HM	200/2,000		20		
		RT3	2	51205	0	RT, HM, JR	350/3,500		25		
		RT3	2	44575	0	HM, JR, TJ	675/4,500		25		
CR-V	12-16	RT2	1-1/4	06144	0	HM, JR, SV	300/3,500		40	85791	CH
		RT3	2	51209	0	RT, HM, JR, SV	350/3,500		40		
		RT3	2	97209	0	HM, JR, SV	350/3,500		40		
		RT3	2	44675	0	HM, JR, SV	675/4,500		40		
CR-V Except Hybrid	17-20	RT2	1-1/4	06183	0	HM, JR, TW	350/3,500		20	85950	CH
		SQ3	2	84128	0	HM, JR, TW	675/4,500		20		
Element	03-04	SQ1	1-1/4	77034		GP	200/2,000		25	74660	HG
		RT3	2	44612	0		350/3,500		30		
Element Except SC	05-06	SQ1	1-1/4	77034		GP	200/2,000		25		
		RT3	2	44612	0		350/3,500		30		
Element SC	05-06	RT3	2	44612	0	EP	350/3,500		35		
Element Except SC	07-08	SQ1	1-1/4	77034		GP	200/2,000		25	78099	CH
		RT3	2	44612	0		350/3,500		30		
Element SC	07-10	RT3	2	44612	0	EP	350/3,500		35	78099	CH
Element Except SC	09-11	SQ1	1-1/4	77034		GP	200/2,000		25	78099	CH
		RT3	2	44612	0		350/3,500		30		
Fit	07-08	SQ1	1-1/4	77153	0	HM	200/2,000		25	74697	CG
Fit	09-13	SQ1	1-1/4	77198	0	HM	200/2,000		25	74697	CG
Fit	15-20	RT1	1-1/4	77307	0	HM, JR	200/2,000		25	85980	CH, BN
HR-V	16-20	RT1	1-1/4	77319	0	GP, JR, SV	200/2,000		35	85886	CH
Odyssey	99-04	SQ2	1-1/4	06398	0	HM, JR	300/3,500		20	74660	HG
		RT3	2	51156	0	RT, HM, JR	350/3,500	500/5,000	15		
		RT3	2	44174	0	HM, JR	675/4,500	675/5,000	15		
Odyssey	05-10	SQ2	1-1/4	06398	0	HM, JR	300/3,500		20	74715	CH
		RT3	2	51156	0	RT, HM, JR	350/3,500	500/5,000	15		
		RT3	2	44174	0	HM, JR	675/4,500	675/5,000	15		
Odyssey	11-17	SQ2	1-1/4	06398	0	HM, JR	300/3,500		20	85747	CH
		RT3	2	51156	0	RT, HM, JR	350/3,500	500/5,000	15		
		SQ3	2	84025	0	GP, X, DU	525/3,500		80		
		RT3	2	44174	0	HM, JR	675/4,500	675/5,000	15		
Odyssey With Fuse Provisions	18-21	RT2	1-1/4	06182	0	GP, DU, X, TA, TW	350/3,500		80	89500	CH
		SQ3	2	84170	0	GP, DU, X, TA, TW	525/3,500		80		
		RT3	2	84171	0	GP, DU, X, TA, TW	675/4,500	675/5,000	25		

† Available while supply lasts.

**AA** Requires temporary removal of bumper during installation.

**BN** Exterior mounted plug on some or all models. May require an aftermarket electrical mounting box or bracket. (Sold separately)

**BY** Minor repositioning of muffler required.

**CG** T-One incorporates circuit protected taillight converter.

**CH** T-One is equipped with circuit protected ModuLite® module.

**DU** Fascia removal required.

**EP** Fascia trimming may be required.

**GP** Hitch crosstube concealed behind bumper.

**HG** T-One incorporates taillight converter.

**HM** Hitch crosstube is visible beneath bumper.

**JR** Exhaust must be temporarily lowered for installation.

**KH** Minor heat shield modification may be required.

**O** Uses all existing holes. No drilling required.

**RC** Will not fit with rear sport bars.

**RT** Round Tube Class III/IV 2"

**SV** Trimming or removal of under body appearance panel may be required.

**TA** Trunk access required for hitch installation.

**TJ** Hitches produced before 07/13/11 are rated at 350/3500 WC.

**TW** Receiver hitch may limit hands-free liftgate sensor range

**X** Minor fascia trimming required.

**RT1** Round Tube Class I 1-1/4"

**RT2** Round Tube Class II 1-1/4"

**RT3** Round Tube Class III 2"

**SQ1** Square Tube Class I

**SQ2** Square Tube Class II

**SQ3** Square Tube Class III

H - HONDA

# RECEIVER HITCH AND T-CONNECTOR APPLICATION GUIDE

MODEL / STYLE	YEAR	TRAILER HITCHES							T-CONNECTOR		
		REC TYPE	REC SIZE	PART NO.	NO DRILL	FOOTNOTES	WC (LBS.)	WD (LBS.)	IN	T-CON PART NO.	FN
<b>HONDA (Continued)</b>											
Odyssey Without Fuse Provisions	18-21	RT2	1-1/4	06182	0	HM,JR,SV,TW	350/3,500		25	85967	CH
		SQ3	2	84170	0	GP,DU,X,TA,TW	525/3,500		80		
		RT3	2	84171	0	HM,JR,SV,TW	675/4,500	675/5,000	25		
Passport w/Door Mounted Spare	98-01	SQ3	2	44621	0		350/3,500	500/5,000	15	74217	BN,HG
Passport w/Under Vehicle Spare	98-02	RT3	2	33041	0	†	350/3,500	500/5,000	15	74217	BN,HG
Passport	19-20	SQ3	2	84290	0	GP	900/6,000	900/8,000	20	89529	CH
Passport	21	SQ3	2	84290	0	GP	900/6,000	900/8,000	20	89529	CH
Pilot	03-08	SQ3	2	44589	0	CS,GP,JR	350/3,500	500/5,000	30	74660	HG
		SQ3	2	51159	0	CS,GP,JR	350/3,500	500/5,000	30		
Pilot	16-17	SQ4	2	44778	0	TA,GP	900/6,000	900/8,000	20	85964	BN,CH
Pilot	18-20	SQ4	2	44778	0	TA,GP	900/6,000	900/8,000	20	85964	BN,CH
Pilot	21	SQ4	2	44778	0	TA,GP	900/6,000	900/8,000	20		
Ridgeline	06-14	RT3	2	51139	0	RT,HM,JR	500/5,000	600/6,000	20	78037	BN,CG
		RT3	2	44528	0	HM,JR,TK	750/5,000	750/7,500	20		
<b>HUMMER</b>											
H3	06-10	SQ3	2	44177	0		500/5,000	500/5,000	25		
<b>HYUNDAI</b>											
Accent 4 Dr. Sedan	06-11	SQ1	1-1/4	77136	0	GP	200/2,000		20		
Accent 3 Dr. Hatchback	07-11	SQ1	1-1/4	77167	0	JR,GP	200/2,000		25		
Accent 4 Dr. Sedan	12-17	SQ1	1-1/4	77272	0	HM	200/2,000		15	85798	CH
Accent 5 Dr. Hatchback	12	SQ1	1-1/4	77272	0	HM	200/2,000		15		
Accent 5 Dr. Hatchback	13-17	SQ1	1-1/4	77272	0	HM	200/2,000		15	85988	CH
Accent 4 Dr. Sedan	18-20	SQ1	1-1/4	77272	0	HM	200/2,000		15		CH
Azera	06-11	SQ1	1-1/4	77148†	0	†,JR,HM	200/2,000		20	74690	HG
Azera	12-17	RT2	1-1/4	06165†		HM,JR	300/3,500		20	85827	CH
Elantra	96-00	SQ1	1-1/4	77111†		†,TA,GP	200/2,000		30		
Elantra	01-06	SQ1	1-1/4	77089	0	HM	200/2,000		15		
Elantra 4 Dr. Sedan	07-10	SQ1	1-1/4	77167	0	JR,X,GP	200/2,000		25	74710	CG
Elantra Touring, 5 Dr.	09-12	SQ1	1-1/4	77246	0	GP,JR	200/2,000		25	78088	CG
Elantra 4 Dr. Sedan	11-12	SQ1	1-1/4	77289		HM	200/2,000		25	85761	CH
Elantra 2 Dr. Coupe	13-14	SQ1	1-1/4	77289		HM,SV	200/2,000		25	85761	CH
Elantra 4 Dr. Sedan	13-16	SQ1	1-1/4	77289		HM,SV	200/2,000		25	85761	CH
Elantra 4 Dr. Except Limited & Sport Models	17-20	SQ1	1-1/4	77939		EP,JR,GP,KH	200/2,000		50	85292	CH
Elantra 4 Dr. Limited Models Except Sport	17-20	SQ1	1-1/4	77939		EP,JR,GP,KH	200/2,000		50	85904	CH
Elantra Except GT & Sport	18-20	SQ1	1-1/4	77964	0	EP,JR,GP,KH	200/2,000		40	85929	CH
Elantra GT Except for Korean Manufactured Vehicles	13-20	SQ1	1-1/4	77292	0	HM	200/2,000		25	85929	CH
Elantra GT Except Sport	18	SQ1	1-1/4	77970	0	DU,GP,X,SV,JR	200/2,000		45		
Entourage	07-09	RT3	2	44537	0	HM,JR	350/3,500	400/4,000	20	78046	BN,CH
Genesis 4 Dr. Sedan	09-11	SQ2	1-1/4	06659		HM,JR,KH	300/3,500		60	78110	CH
Genesis 4 Dr. Sedan	12-14	SQ2	1-1/4	06659		HM,JR,KH	300/3,500		60		
Ioniq Hybrid	17-20	SQ1	1-1/4	77963	0	JR,GP,SV	200/2,000		30		CH
Kona	18-21	SQ1	1-1/4	77976	0	GP,JR	200/2,000		35		
Palisade	20-21	SQ3	2	84420	0	JR,X	500/5,000	750/6,000	30	89517	BN,CH
Santa Fe	01-06	RT3	2	51088	0	RT,GP,JR	315/3,500		35	78088	CG
		SQ3	2	96543†	0	GP,JR	315/3,500		35		
Santa Fe	07-09	SQ3	2	51076	0		350/3,500		20	74692	CG
		SQ3	2	44549	0	TG	525/3,500		20		
Santa Fe	10-12	SQ2	1-1/4	06133	0	HM	300/3,500		15	74692	CG
		SQ3	2	44639	0	HM	350/3,500	500/5,000	15		
		SQ3	2	51206	0	HM	350/3,500	500/5,000	15		
Santa Fe (6/7 Passenger)	13-18	RT3	2	44691	0	FP,GP,J	750/5,000	750/7,500	30	85815	
Santa Fe Sport (5 Passenger)	13-18	RT2	1-1/4	06158	0	HM,JR,SV	300/3,500		30	85805	BN,CH
		RT3	2	44689	0	HM,JR,SV	525/3,500	525/5,250	30		

† Available while supply lasts.  
**BN** Exterior mounted plug on some or all models. May require an aftermarket electrical mounting box or bracket. (Sold separately)  
**CG** T-One incorporates circuit protected taillight converter.  
**CH** T-One is equipped with circuit protected ModuLite® module.  
**CS** Will fit with full-size spare tire stowed under vehicle.  
**DU** Fascia removal required.  
**EP** Fascia trimming may be required.  
**FP** Spare tire repositioning and/or modification of spare tire carrier may be required.  
**GP** Hitch crossbar concealed behind bumper.  
**HG** T-One incorporates taillight converter.  
**HM** Hitch crossbar is visible beneath bumper.  
**J** Under vehicle spare tire storage is retained.

**JR** Exhaust must be temporarily lowered for installation.  
**KH** Minor heat shield modification may be required.  
**0** Uses all existing holes. No drilling required.  
**RT** Round Tube Class III/IV 2"  
**SV** Trimming or removal of under body appearance panel may be required.  
**TA** Trunk access required for hitch installation.  
**TG** Hitches produced before 05/13/11 are rated at 350/3500 WC.  
**TK** Hitches produced before 09/09/11 are rated at 500/5000 WC & 600/6000 WD.  
**TW** Receiver hitch may limit hands-free liftgate sensor range  
**X** Minor fascia trimming required.

**RT2** Round Tube Class II 1-1/4"  
**RT3** Round Tube Class III 2"  
**SQ1** Square Tube Class I  
**SQ2** Square Tube Class II  
**SQ3** Square Tube Class III  
**SQ4** Square Tube Class IV

MODEL / STYLE	YEAR	TRAILER HITCHES							T-CONNECTOR		
		REC TYPE	REC SIZE	PART NO.	NO DRILL	FOOTNOTES	WC (LBS.)	WD (LBS.)	IN	T-CON PART NO.	FN
<b>HYUNDAI (Continued)</b>											
Santa Fe	19-20	RT3	2	44750	0	HM,TA,JR	500/5,000		40	89517	BN,CH
Sonata	02-05	SQ1	1-1/4	77030†	0	†,HM	200/2,000		15		
Sonata	06-09	SQ1	1-1/4	77133	0	HM	200/2,000		20	74710	CG
Sonata	10	SQ1	1-1/4	77133	0	HM	200/2,000		20	85788	CH
Sonata Except Hybrid	11-14	SQ1	1-1/4	77965	0	HM,JR,KH,SV	200/2,000		40	85788	CH
Sonata Hybrid	11-14	SQ1	1-1/4	77965	0	HM,JR,KH,SV	200/2,000		40	85876	
Sonata Except Hybrid	15-17	SQ1	1-1/4	77965	0	HM,JR,KH,SV	200/2,000		40	85864	CH
Sonata Hybrid	15-19	SQ1	1-1/4	77965	0	HM,JR,KH,SV	200/2,000		40	85876	
Sonata Except Hybrid	18-19	SQ1	1-1/4	77965	0	HM,JR,KH,SV	200/2,000		40	85975	CH
Sonata	20	SQ1	1-1/4	77993	0	HM,JR	200/2,000		30		
Tucson	05-09	SQ2	1-1/4	06339	0	GP,JR	300/3,500		25	78034	CG
		SQ3	2	44582	0	GP,JR	350/3,500		25		
Tucson	10-15	SQ2	1-1/4	06132	0	GP,JR	300/3,500		20	85722	CH
		SQ3	2	44666	0	GP,JR	525/3,500	525/5,250	20		
Tucson	16-18	RT2	1-1/4	06949	0	GP,JR	300/3,500		30	85722	CH
		SQ3	2	44780	0	GP,JR	525/3,500		30		
Tucson	19-21	RT2	1-1/4	06949			300/3,500			89533	CH
		SQ3	2	44780			525/3,500				
Venue	20	SQ1	1-1/4	77992	0	HM,JR,KH,EP,X	200/2,000		30	118818	CH
Veracruz	07-12	SQ3	2	44573	0	HM,JR	500/5,000	500/5,000	30	85815	BN,CH
<b>INFINITI</b>											
FX35	09-12	RT3	2	44692	0		400/4,000		40	85825	CH
FX37	13	RT3	2	44692		HM	400/4,000		40	85825	CH
FX50	09-13	RT3	2	44692		HM	400/4,000		40	85825	CH
G35 4 Dr. Sedan	07-08	SQ1	1-1/4	77204		EP,GP	200/2,000		45	78108	CH
G37 4 Dr. Sedan	09-13	SQ1	1-1/4	77204		EP,GP	200/2,000		45	78108	CH
I30	96-99	SQ1	1-1/4	77028		TA,GP	200/2,000		30		
I30	00-01	SQ1	1-1/4	77028		TA,GP	200/2,000		30		
I35	02-04	SQ1	1-1/4	77028		TA,GP	200/2,000		30		
JX35	13	SQ3	2	84031	0	HM	900/6,000	900/6,000	25		
Q50	14-20	SQ1	1-1/4	77318		GP,JR	200/2,000		40	85885	CH
QX30 Except Sport Model	17-20	SQ3	2	44777	0	GP,JR,TA,KH	350/3,500		90	85947	CH
QX4	97-03	SQ2	1-1/4	06061†	0	†,HM	300/3,500		20	74218	HG
		RT3	2	33050	0		500/5,000	550/5,500	20		
		SQ3	2	44132	0		500/5,000	550/5,500	20		
		SQ3	2	51046	0	HM	500/5,000	550/5,500	20		
QX50	19-20	SQ3	2	84240	0		400/4,000		20	89004	BN,CH
QX56	04-10	RT4	2	44674	0	HM	600/6,000	1,000/10,000	15		
QX60	14-15	SQ3	2	84031	0	HM	900/6,000	900/6,000	25	85883	BN
QX60	16-17	SQ3	2	84031	0	HM	900/6,000	900/6,000	25	85883	BN
QX60	18-20	SQ3	2	84031	0	HM	900/6,000	900/6,000	25	85883	BN
QX60	21	SQ3	2	84031	0	HM	900/6,000	900/6,000	25	85883	BN
QX70	14-20	RT3	2	44692		HM	400/4,000		40		
<b>ISUZU</b>											
Axiom w/Under Vehicle Spare	02-03	RT3	2	33041		†	350/3,500	500/5,000	20		
Hombre w/Step Bumper	98-00	SQ2		88001†		†,CN,GU,ST	350/3,500		40	74216	
		SQ2	1-1/4	06958	0	GU,RH,GP	300/3,500		35		
		SQ3	2	44062		CN,GU	350/3,500	500/5,000	20		
		SQ3	2	51063		CN,GP,GU	350/3,500	500/5,000	20		
		SQ3	2	37042		AF,CN,GU,ST	500/5,000	600/6,000	40		
		SQ3	2	37152		AF,CN,GU,ST	500/5,000	600/6,000	40		
i-280	06	SQ4	2	44593	0	GP	600/6,000	750/7,500	25	78001	BN,CG
		SQ4	2	51074	0	GP	600/6,000	750/7,500	25		

† Available while supply lasts.  
**AF** Hitch is ONLY rated for Weight Carrying at 3500 lbs. GTW / 350 lbs. TW and DO NOT use Weight Distribution Spring Bars for this Specific Vehicle. Except for long bed pickups.  
**BN** Exterior mounted plug on some or all models. May require an aftermarket electrical mounting box or bracket. (Sold separately)  
**CG** T-One incorporates circuit protected taillight converter.  
**CH** T-One is equipped with circuit protected ModuLite® module.  
**CN** Requires OEM factory bumper for hitch installation.  
**EP** Fascia trimming may be required.  
**GP** Hitch cross tube concealed behind bumper.  
**GU** Will not fit vehicles with factory or aftermarket lower Fascia/Rollpan or Tube Bumper.  
**HG** T-One incorporates taillight converter.  
**HM** Hitch cross tube is visible beneath bumper.  
**JR** Exhaust must be temporarily lowered for installation.

**KH** Minor heat shield modification may be required.  
**0** Uses all existing holes. No drilling required.  
**RH** Optional drawbar #36051 required (Sold separately) except for models with ZR2 & Highrider package.  
**ST** Will not fit 2WD models with short bed.  
**SV** Trimming or removal of under body appearance panel may be required.  
**TA** Trunk access required for hitch installation.  
**X** Minor fascia trimming required.

**RT2** Round Tube Class II 1-1/4"  
**RT3** Round Tube Class III 2"  
**RT4** Round Tube Class IV 2"  
**SQ1** Square Tube Class I  
**SQ2** Square Tube Class II  
**SQ3** Square Tube Class III  
**SQ4** Square Tube Class IV

# RECEIVER HITCH AND T-CONNECTOR APPLICATION GUIDE

MODEL / STYLE	YEAR	TRAILER HITCHES							T-CONNECTOR		
		REC TYPE	REC SIZE	PART NO.	NO DRILL	FOOTNOTES	WC (LBS.)	WD (LBS.)	IN	T-CON PART NO.	FN
<b>ISUZU (Continued)</b>											
i-290	07-08	SQ4	2	44593	0	GP	600/6,000	750/7,500	25	78001	BN,CG
		SQ4	2	51074	0	GP	600/6,000	750/7,500	25		
i-350	06	SQ4	2	44593	0	GP	600/6,000	750/7,500	25	78001	BN,CG
		SQ4	2	51074	0	GP	600/6,000	750/7,500	25		
i-370	07-08	SQ4	2	44593	0	GP	600/6,000	750/7,500	25	78001	BN,CG
		SQ4	2	51074	0	GP	600/6,000	750/7,500	25		
Oasis	96-99	SQ2	1-1/4	06953†		HM,JR	300/3,500		30	74660	HG
Rodeo w/Door Mounted Spare	98-01	SQ3	2	44621	0		350/3,500	500/5,000	15	74217	BN,HG
Rodeo w/Under Vehicle Spare, Except w/3.5L	98-04	RT3	2	33041	0	†	350/3,500	500/5,000	15	74217	BN,HG
Trooper	92-02	SQ3	2	33043†		†,HM	500/5,000	750/7,500	40	74461	BN,HG
<b>JAGUAR</b>											
E-Pace	18-20	SQ3	2	84330	0	GP,DU,EP	350/3,500		90	89509	BN,CH
F-Pace	17-20	SQ3	2	84026	0	GP,AA,DU,SV,TA,TZ	900/6,000		90	89507	CH,BN
<b>JEEP</b>											
Cherokee	97-01	SQ2		88001†		†	350/3,500		40	74206	HG
		SQ2	1-1/4	06954†	0	GP	300/3,500		30		
		SQ3	2	44088		GP	300/3,500	500/5,000	40		
		SQ3	2	51001		GP	300/3,500	500/5,000	40		
		SQ3	2	37042			500/5,000	600/6,000	45		
		SQ3	2	37152			500/5,000	600/6,000	45		
Cherokee	14-18	SQ3	2	44765	0	EP,GP	500/5,000	500/5,000	60	85834	CH,BN
Cherokee Trailhawk	14-20	RT3	2	44701	0	HM	600/5,000	600/6,000	30	85834	CH,BN
Cherokee	19-20	SQ3	2	44765	0	EP,GP	500/5,000	500/5,000	20	89501	CH,BN
Cherokee	21	SQ3	2	44765	0	EP,GP	500/5,000	500/5,000	20	89501	CH,BN
Commander	06-10	SQ2	1-1/4	06378	0	GP	300/3,500		20	78044	BN,CG
		SQ3	2	51149	0		500/5,000	750/7,500	20		
		SQ3	2	44748	0	TL	750/5,000	750/7,500	20		
Compass	07-10	SQ2	1-1/4	06428	0	GP	300/3,500		15	74705	BN,CH
		SQ3	2	51085	0	GP	350/3,500		15		
		SQ3	2	44661	0	GP,TU	525/3,500		15		
Compass Rallye Edition	07-10	SQ2	1-1/4	06428	0	EP,GP	300/3,500		30	74705	BN,CH
		SQ3	2	51085	0	EP,GP	350/3,500		30		
		SQ3	2	44661	0	EP,GP,TU	525/3,500		30		
Compass (Old Body Style)	11-17	SQ2	1-1/4	06428	0	EP,GP	300/3,500		30	85764	BN,CH
		SQ3	2	51085	0	EP,GP	350/3,500		30		
		SQ3	2	44661	0	EP,GP,TU	525/3,500		30		
Compass (New Body Style)	17-21	RT2	1-1/4	06598	0	HM,JR,KH	350/3,500		40	85958	BN,CH
		RT3	2	84144	0	HM,JR,KH	675/4,500		40		
Gladiator Except Rubicon	20-21	SQ3	2	84310	0	HM	1,125/7,500	1,200/8,000	30	89506	BN,CH
Grand Cherokee	99	SQ2	1-1/4	06966	0	HM	300/3,500		15	74889	CH
		SQ3	2	44092	0		300/3,500	500/5,000	20		
		SQ3	2	51059	0		300/3,500	500/5,000	15		
		SQ3	2	44716	0	EP	500/5,000	750/7,500	75		
Grand Cherokee	00-04	SQ2	1-1/4	06966	0	HM	300/3,500		15	74889	CH
		SQ3	2	44092	0		300/3,500	500/5,000	20		
		SQ3	2	51059	0		300/3,500	500/5,000	15		
		SQ3	2	44716	0	EP	500/5,000	750/7,500	75		
Grand Cherokee Except SRT-8	05-06	SQ2	1-1/4	06378	0	AI,GP	300/3,500		90	78031	BN,CG
		SQ3	2	51149	0	AI	500/5,000	750/7,500	90		
		SQ3	2	44748	0	AI,TL	750/5,000	750/7,500	90		
Grand Cherokee Except SRT-8	07-10	SQ2	1-1/4	06378	0	AI,GP	300/3,500		90	74702	BN
		SQ3	2	51149	0	AI	500/5,000	750/7,500	90		
		SQ3	2	44748	0	AI,TL	750/5,000	750/7,500	90		

† Available while supply lasts.  
**AA** Requires temporary removal of bumper during installation.  
**AI** Additional installation time may be required.  
**BN** Exterior mounted plug on some or all models. May require an aftermarket electrical mounting box or bracket. (Sold separately)  
**CG** T-One incorporates circuit protected taillight converter.  
**CH** T-One is equipped with circuit protected ModuLite® module.  
**DU** Fascia removal required.  
**EP** Fascia trimming may be required.  
**GP** Hitch cross-tube concealed behind bumper.  
**HG** T-One incorporates taillight converter.  
**HM** Hitch cross-tube is visible beneath bumper.  
**JR** Exhaust must be temporarily lowered for installation.

**KH** Minor heat shield modification may be required.  
**0** Uses all existing holes. No drilling required.  
**SV** Trimming or removal of under body appearance panel may be required.  
**TA** Trunk access required for hitch installation.  
**TL** Hitches produced before 10/31/11 are rated at 500/5000 WC & 750/7500 WD.  
**TU** Hitches produced before 07/24/12 are rated at 350/3500 WC.  
**TZ** Requires replacement of the impact structure with hitch.

**RT2** Round Tube Class II 1-1/4"  
**RT3** Round Tube Class III 2"  
**SQ2** Square Tube Class II  
**SQ3** Square Tube Class III  
**SQ4** Square Tube Class IV

MODEL / STYLE	YEAR	TRAILER HITCHES								T-CONNECTOR	
		REC TYPE	REC SIZE	PART NO.	NO DRILL	FOOTNOTES	WC (LBS.)	WD (LBS.)	IN	T-CON PART NO.	FN
<b>JEEP (Continued)</b>											
Grand Cherokee Except w/OEM Tow Hook	11-13	SQ3	2	44650	0	GP	500/5,000	750/7,500	20	74702	BN
		SQ3	2	51195	0	GP	500/5,000	750/7,500	20		
Grand Cherokee w/OEM Tow Hook	11-13	SQ3	2	44650	0	AI,GP	500/5,000	750/7,500	40	74702	BN
		SQ3	2	51195	0	AI,GP	500/5,000	750/7,500	40		
Grand Cherokee EcoDiesel	14-20	RT4	2	44662	0	CS,HM	900/6,000	900/7,500	20	85944	BN,CH
Grand Cherokee Except w/OEM Tow Hook or ECODiesel Engine	14-20	SQ3	2	44650	0	GP	500/5,000	750/7,500	20	85944	BN,CH
		SQ3	2	51195	0	GP	500/5,000	750/7,500	20		
Grand Cherokee w/OEM Tow Hook, Except w/ECODiesel Engine	14-20	SQ3	2	44650	0	AI,GP	500/5,000	750/7,500	40	85944	BN,CH
		SQ3	2	51195	0	AI,GP	500/5,000	750/7,500	40		
Grand Cherokee Except w/OEM Tow Hook or ECODiesel Engine	21	SQ3	2	44650	0	GP	500/5,000	750/7,500	20	85944	BN,CH
		SQ3	2	51195	0	GP	500/5,000	750/7,500	20		
Grand Cherokee w/OEM Tow Hook, Except w/ECODiesel Engine	21	SQ3	2	44650	0	AI,GP	500/5,000	750/7,500	40	85944	BN,CH
		SQ3	2	51195	0	AI,GP	500/5,000	750/7,500	40		
Liberty	02-04	SQ2	1-1/4	06971†	0	†,GP	300/3,500		15	85750	HG
		SQ3	2	37053	0	GP	400/4,000	500/5,000	20		
		SQ3	2	37152	0		500/5,000	600/6,000	35		
		SQ3	2	44082	0	GP	500/5,000	750/7,500	20		
		SQ3	2	51054	0	GP	500/5,000	750/7,500	20		
Liberty	02-07	SQ2		88001†		†	350/3,500		35	85254	HG
		SQ3	2	37042			500/5,000	600/6,000	35		
Liberty	05-07	SQ2	1-1/4	06971†	0	†,GP	300/3,500		15	85750	HG
		SQ3	2	37053	0	GP	400/4,000	500/5,000	20		
		SQ3	2	37152	0		500/5,000	600/6,000	35		
		SQ3	2	44082	0	GP	500/5,000	750/7,500	20		
		SQ3	2	51054	0	GP	500/5,000	750/7,500	20		
Liberty	08	SQ2	1-1/4	06529	0	HM	300/3,500		15	85787	BN,CH
		RT3	2	44585	0	HM	500/5,000	750/7,500	20		
Liberty	09-12	SQ2	1-1/4	06529	0	HM	300/3,500		15	85787	BN,CH
		RT3	2	44585	0	HM	500/5,000	750/7,500	20		
Patriot	07	SQ2	1-1/4	06428	0	GP	300/3,500		15	74705	BN,CH
		SQ3	2	51085	0	GP	350/3,500		15		
		SQ3	2	44661	0	GP,TU	525/3,500		15		
Patriot	08-17	SQ2	1-1/4	06428	0	EP,GP	300/3,500		30	85775	CH
		SQ3	2	51085	0	EP,GP	350/3,500		30		
		SQ3	2	44661	0	EP,GP,TU	525/3,500		30		
Renegade	15-20	RT2	1-1/4	06947		HM	300/3,500		30	85848	CH
		SQ3	2	84021		HM,JR	675/4,500		40		
TJ (Canada Only)	98-06	SQ1	1-1/4	77016	0	DA,HM	200/2,000		15	74223	BN
		SQ2	1-1/4	06021	0	HM	300/3,500		15		
		RT3	2	44565	0	HM	400/4,000		15		
		RT3	2	51145	0	RT,HM	400/4,000		15		
Wrangler	98-06	SQ1	1-1/4	77016	0	DA,HM	200/2,000		15	74223	BN
		SQ2	1-1/4	06021	0	HM	300/3,500		15		
		RT3	2	44565	0	HM	400/4,000		15		
		RT3	2	51145	0	RT,HM	400/4,000		15		
Wrangler Except w/Right Hand Drive	07-17	SQ3	2	84104	0	†	675/4,500	675/4,500	20	74693	BN
Wrangler Except w/Right Hand Drive, Hard Rock Edition, 75th Anniversary Edition & vehicles with Mopar Off Road Bumper #82213654	07-17	SQ2	1-1/4	06448†	0	†,GP	300/3,500		20	74693	BN
		SQ3	2	51077	0		350/3,500	400/4,000	20		
Wrangler Right Hand Drive	07-17	SQ3	2	84104	0	†	675/4,500	675/4,500	20		
Wrangler Right Hand Drive, Except Hard Rock Edition, 75th Anniversary Edition & vehicles with Mopar Off Road Bumper #82213654	07-17	SQ2	1-1/4	06448†	0	†,GP	300/3,500		20		
		SQ3	2	51077	0		350/3,500	400/4,000	20		

- † Available while supply lasts.
- AI Additional installation time may be required.
- BN Exterior mounted plug on some or all models. May require an aftermarket electrical mounting box or bracket. (Sold separately)
- CH T-One is equipped with circuit protected ModuLite® module.
- CS Will fit with full-size spare tire stowed under vehicle.
- DA Will not fit with tube style bumper.
- EP Fascia trimming may be required.
- GP Hitch crosstube concealed behind bumper.
- HG T-One incorporates taillight converter.
- HM Hitch crosstube is visible beneath bumper.
- JR Exhaust must be temporarily lowered for installation.
- 0 Uses all existing holes. No drilling required.

- RT Round Tube Class III/IV 2"
- TU Hitches produced before 07/24/12 are rated at 350/3500 WC.

- RT2 Round Tube Class II 1-1/4"
- RT3 Round Tube Class III 2"
- RT4 Round Tube Class IV 2"
- SQ1 Square Tube Class I
- SQ2 Square Tube Class II
- SQ3 Square Tube Class III



# RECEIVER HITCH AND T-CONNECTOR APPLICATION GUIDE

MODEL / STYLE	YEAR	TRAILER HITCHES								T-CONNECTOR	
		REC TYPE	REC SIZE	PART NO.	NO DRILL	FOOTNOTES	WC (LBS.)	WD (LBS.)	IN	T-CON PART NO.	FN
<b>JEEP (Continued)</b>											
Wrangler JL (New Body Style), Except Diesel	18-21	SQ2	1-1/4	06448†	0	†,GP	300/3,500		20	89506	BN,CH
		SQ3	2	51077	0		350/3,500	400/4,000	20		
		SQ3	2	84104	0	†	675/4,500	675/4,500	20		
Wrangler JK Except w/Right Hand Drive	18	SQ3	2	84104	0	†	675/4,500	675/4,500	20	74693	BN
Wrangler JK Except w/Right Hand Drive, Hard Rock Edition, 75th Anniversary Edition & vehicles with Mopar Off Road Bumper #82213654	18	SQ2	1-1/4	06448†	0	†,GP	300/3,500		20	74693	BN
		SQ3	2	51077	0		350/3,500	400/4,000	20		
Wrangler JK Right Hand Drive	18	SQ3	2	84104	0	†	675/4,500	675/4,500	20		
Wrangler JK Right Hand Drive, Except Hard Rock Edition, 75th Anniversary Edition & vehicles with Mopar Off Road Bumper #82213654	18	SQ2	1-1/4	06448†	0	†,GP	300/3,500		20		
		SQ3	2	51077	0		350/3,500	400/4,000	20		
<b>KIA</b>											
Cadenza	14	RT2	1-1/4	06165†		HM,JR	300/3,500		20	85857	CH
Forte 4 Dr. Sedan	10-13	SQ1	1-1/4	77234	0	HM,JR	200/2,000		20	74692	CG
Forte 4 Dr. Sedan	14-18	SQ1	1-1/4	77290	0	HM	200/2,000		20	85826	CH
		SQ1	1-1/4	77990	0	HM	200/2,000		20		
Forte Sedan	19-21	SQ1	1-1/4	77990	0	HM	200/2,000		20	118814	CH
Magentis (Canada Only)	06-10	SQ1	1-1/4	77154†	0	HM,JR	200/2,000		20		
Niro Except Plug-In-Hybrid	17-20	RT2	1-1/4	06179	0	GP,JR,EP,SV	350/3,500		40	85965	CH
Optima (App. starts with 2006-1/2)	06-08	SQ1	1-1/4	77154†	0	HM,JR	200/2,000		20	78065	
Optima	09-10	SQ1	1-1/4	77154†	0	HM,JR	200/2,000		20	74710	CG
Optima	11-20	SQ1	1-1/4	77965	0	HM,JR,KH,SV	200/2,000		40	78011	HG
Rio	02-05	SQ1	1-1/4	77044†		†,TA,GP	200/2,000		20		
Rio 4 Dr. Sedan	06-11	SQ1	1-1/4	77136	0	GP	200/2,000		20		
Rio 4 Dr. Sedan, Except S	12-17	SQ1	1-1/4	77272	0	HM	200/2,000		15	85794	CH
Rio 5 Dr. Hatchback	12-17	SQ1	1-1/4	77270	0	GP,JR,SV	200/2,000		30	85794	CH
Rio Sedan	18-20	SQ1	1-1/4	77964	0	EP,JR,GP,KH	200/2,000		40	118793	CH
Rio5 5 Dr. Hatchback	06-11	SQ1	1-1/4	77167	0	JR,X,GP	200/2,000		25		
Rondo	07-10	SQ1	1-1/4	77169†	0	†,GP,JR	200/2,000		30	74708	BN,CG
Rondo (Canada Only)	11-12	SQ1	1-1/4	77169†	0	†,GP,JR	200/2,000		30	74708	BN,CG
Rondo (Canada Only) Sedona	02-05	SQ2	1-1/4	06029†		†,HM	300/3,500		20	85266	HG
		RT3	2	33062		HM	500/5,000	550/5,500	30		
Sedona 118.9" Long Wheelbase	06-12	RT3	2	44537	0	HM,JR	350/3,500	400/4,000	20	78046	BN,CH
Sedona 113.8" Short Wheelbase	07-10	RT3	2	44578		HM,JR	350/3,500	400/4,000	25	78046	BN,CH
Sedona 118.9" Long Wheelbase	14	RT3	2	44537	0	HM,JR	350/3,500	400/4,000	20	78046	BN,CH
Sedona	15-21	RT3	2	44709	0	HM,JR,SV	400/4,000	400/4,000	20	85815	BN,CH
		RT3	2	44558	0	HM	500/5,000	500/5,000	15		
Sorento	03-06	RT3	2	51082	0	RT,HM	500/5,000	500/5,000	15	85317	BN,HG
		RT3	2	51082	0	RT,HM	500/5,000	500/5,000	15		
Sorento	07-09	RT3	2	44558	0	HM	500/5,000	500/5,000	15		
		RT3	2	51082	0	RT,HM	500/5,000	500/5,000	15		
Sorento EX V6, w/Factory Tow Package	11-13	SQ2	1-1/4	06133	0	HM	300/3,500		15		
		SQ3	2	44639	0	HM	350/3,500	500/5,000	15		
		SQ3	2	51206	0	HM	350/3,500	500/5,000	15		
Sorento Except SX V6 & EX V6 w/Factory Tow Package	11-13	SQ2	1-1/4	06133	0	HM	300/3,500		15	85726	CH
		SQ3	2	44639	0	HM	350/3,500	500/5,000	15		
		SQ3	2	51206	0	HM	350/3,500	500/5,000	15		
Sorento SX V6	11-13	SQ2	1-1/4	06133	0	HM	300/3,500		15	85815	BN,CH
		SQ3	2	44639	0	HM	350/3,500	500/5,000	15		
		SQ3	2	51206	0	HM	350/3,500	500/5,000	15		
Sorento w/ 14 Engine	14-15	RT2	1-1/4	06158	0	HM,J,JR,SV	300/3,500		30	85818	BN,CH
		RT3	2	44689	0	HM,J,JR,SV	525/3,500	525/5,250	30		

† Available while supply lasts.  
 BN Exterior mounted plug on some or all models. May require an aftermarket electrical mounting box or bracket. (Sold separately)  
 CG T-One incorporates circuit protected taillight converter.  
 CH T-One is equipped with circuit protected ModuLite® module.  
 EP Fascia trimming may be required.  
 GP Hitch crosstube concealed behind bumper.  
 HG T-One incorporates taillight converter.  
 HM Hitch crosstube is visible beneath bumper.  
 J Under vehicle spare tire stowage is retained.  
 JR Exhaust must be temporarily lowered for installation.  
 KH Minor heat shield modification may be required.  
 O Uses all existing holes. No drilling required.

RT Round Tube Class III/IV 2"  
 SV Trimming or removal of under body appearance panel may be required.  
 TA Trunk access required for hitch installation.  
 X Minor fascia trimming required.

RT2 Round Tube Class II 1-1/4"  
 RT3 Round Tube Class III 2"  
 SQ1 Square Tube Class I  
 SQ2 Square Tube Class II  
 SQ3 Square Tube Class III

# RECEIVER HITCH AND T-CONNECTOR APPLICATION GUIDE

RECEIVER HITCHES

MODEL / STYLE	YEAR	TRAILER HITCHES								T-CONNECTOR	
		REC TYPE	REC SIZE	PART NO.	NO DRILL	FOOTNOTES	WC (LBS.)	WD (LBS.)	IN	T-CON PART NO.	FN
<b>KIA (Continued)</b>											
Sorento w/ V6 Engine	14-15	RT2	1-1/4	06158	0	HM,JJR,SV	300/3,500		30	85815	BN,CH
		RT3	2	44689	0	HM,JJR,SV	525/3,500	525/5,250	30		
Sorento w/ I4 Engine	16-20	RT2	1-1/4	06196	0	JR,HM,TA	300/3,500		40	118583	BN,CH
		RT3	2	44750	0	HM,TA,JR	500/5,000		40		
Sorento w/ V6 Engine	16-20	RT2	1-1/4	06196	0	HM,TA,JR	300/3,500		40	118269	BN,CH
		RT3	2	44750	0	HM,TA,JR	500/5,000		40		
Soul Except w/LED Taillights	10-13	SQ1	1-1/4	77230	0	GP,JR	200/2,000		40	74708	BN,CG
Soul w/LED Taillights	10-13	SQ1	1-1/4	77230	0	GP,JR	200/2,000		40	85843	CH
Soul Except w/LED Taillights	14-19	SQ1	1-1/4	77302	0	GP,JR	200/2,000		40	74708	BN,CG
Soul w/LED Taillights	14-19	SQ1	1-1/4	77302	0	GP,JR	200/2,000		40	85843	CH
Soul Except GT Turbo & EV	20-21	SQ1	1-1/4	77985	0	JR,X	200/2,000		30		
Sportage	98-02	SQ2	1-1/4	06264†		†,HM	300/3,500		20		HG
Sportage 4 Cyl.	05-10	SQ2	1-1/4	06339	0	GP,JR	300/3,500		25		
		SQ3	2	44582	0	GP,JR	350/3,500		25		
Sportage 6 Cyl.	05-10	SQ2	1-1/4	06339	0	GP,JR	300/3,500		25	78038	BN,CG
		SQ3	2	44582	0	GP,JR	350/3,500		25		
Sportage	11-16	SQ2	1-1/4	06132	0	GP,JR	300/3,500		20	85751	CH
		SQ3	2	44666	0	GP,JR	525/3,500	525/5,250	20		
Sportage Except SX & SX Turbo	17-19	RT2	1-1/4	06176	0	GP,SV,JR,X	300/3,500		30	85932	CH,BN
Sportage Except SX & SX Turbo	17-21	SQ3	2	84074	0	GP,SV,JR	675/4,500	675/4,500	25	85932	CH,BN
Stinger	18-20	SQ1	1-1/4	77974	0	DU,FE,JR,KH	200/2,000		90	89518	CH
Telluride	20-21	SQ3	2	84420	0	JR,X	500/5,000	750/6,000	30	89517	BN,CH
<b>LAND ROVER</b>											
LR2	08-14	RT3	2	44640	0	HM	400/4,000	400/4,000	20		
Range Rover Evoque Excluding Autobiography	12-14	SQ3	2	44779	0	EP,GP,X,KH	675/4,500		45	85846	BN
Range Rover Evoque Excluding Autobiography	15-19	SQ3	2	44779	0	EP,GP,X,KH	675/4,500		45		
Range Rover Sport	15-18	SQ4	2	44781	0	GP,SV	800/8,000		45	85897	
Range Rover Velar	18-20	SQ3	2	84260	0	JR,TZ	900/6,000		80	89507	CH,BN
<b>LEXUS</b>											
ES300 4 Dr.	97-01	SQ2	1-1/4	06326		HM	300/3,500		15		
		SQ2	1-1/4	51178		HM	300/3,500		15		
ES300 4 Dr.	02-03	SQ2	1-1/4	06326		HM	300/3,500		15		
		SQ2	1-1/4	51178		HM	300/3,500		15		
ES330 4 Dr.	04-06	SQ2	1-1/4	06326		HM	300/3,500		15		
		SQ2	1-1/4	51178		HM	300/3,500		15		
ES350	07-12	SQ2	1-1/4	06397		GP,JR,TA	300/3,500		45	85703	CH
		SQ2	1-1/4	51190		GP,JR,TA	300/3,500		45		
ES350 Except Hybrid	13-18	SQ2	1-1/4	06154		HM,JR	300/3,500		40	85824	CH
GS350	13	SQ2	1-1/4	06945†	0	†,GP,EP,FE	300/3,500		60	85830	CH
GX460	10-14	SQ3	2	44644	0		500/5,000	500/5,000	15		
GX460	15	SQ3	2	44644	0		500/5,000	500/5,000	15		
GX460	16-20	SQ3	2	44644	0		500/5,000	500/5,000	15		
GX470	03-06	RT4	2	44548	0	LT,SI	600/6,000	730/7,300	35		
GX470	07-09	RT4	2	44548	0	LT,SI	600/6,000	730/7,300	35		
IS250 Except Convertible	14-15	RT1	1-1/4	77310	0	KH,AE,HM	200/2,000		35		
IS350	14	RT1	1-1/4	77310	0	KH,AE,HM	200/2,000		35	85852	CH
IS350	15-20	RT1	1-1/4	77310	0	KH,AE,HM	200/2,000		35		
LX470	98-99	SQ3	2	44546	0	GP	500/5,000	750/6,000	20	74225	BN,HG
LX470	00	SQ3	2	44546	0	GP	500/5,000	750/6,000	20		
LX470	01-02	SQ3	2	44546	0	GP	500/5,000	750/6,000	20		
LX470	03-07	SQ3	2	44546	0	GP	500/5,000	750/6,000	20		
NX200t	15-20	RT3	2	44762	0	JR,HM	350/3,500	400/4,000	35	85867	CH

- † Available while supply lasts.
- AE Requires temporary removal of muffler during installation.
- BN Exterior mounted plug on some or all models. May require an aftermarket electrical mounting box or bracket. (Sold separately)
- CG T-One incorporates circuit protected taillight converter.
- CH T-One is equipped with circuit protected ModuLite® module.
- DU Fascia removal required.
- EP Fascia trimming may be required.
- FE Fascia trimming may be required. Allow additional installation time.
- GP Hitch cross-tube concealed behind bumper.
- HG T-One incorporates taillight converter.
- HM Hitch cross-tube is visible beneath bumper.
- J Under vehicle spare tire stowage is retained.

- JR Exhaust must be temporarily lowered for installation.
- KH Minor heat shield modification may be required.
- LT Requires removal of factory hitch if equipped.
- 0 Uses all existing holes. No drilling required.
- SI Hitches produced before 07/31/07 are rated at 350/3500 WC & 500/5000 WD.
- SV Trimming or removal of under body appearance panel may be required.
- TA Trunk access required for hitch installation.
- TZ Requires replacement of the impact structure with hitch.
- X Minor fascia trimming required.

- RT1 Round Tube Class I 1-1/4"
- RT2 Round Tube Class II 1-1/4"
- RT3 Round Tube Class III 2"
- RT4 Round Tube Class IV 2"
- SQ1 Square Tube Class I
- SQ2 Square Tube Class II
- SQ3 Square Tube Class III
- SQ4 Square Tube Class IV

L - LEXUS

# RECEIVER HITCH AND T-CONNECTOR APPLICATION GUIDE

MODEL / STYLE	YEAR	TRAILER HITCHES							T-CONNECTOR		
		REC TYPE	REC SIZE	PART NO.	NO DRILL	FOOTNOTES	WC (LBS.)	WD (LBS.)	IN	T-CON PART NO.	FN
<b>LEXUS (Continued)</b>											
RX300	99-00	SQ2	1-1/4	06276	0	HM	300/3,500		15		
		SQ3	2	51153	0	HM	300/3,500		15		
		SQ3	2	44076	0		350/3,500		15		
RX300	01-03	SQ2	1-1/4	06276	0	HM	300/3,500		15		
		SQ3	2	51153	0	HM	300/3,500		15		
		SQ3	2	44076	0		350/3,500		15		
RX330	04-06	RT3	2	33075	0	HM	350/3,500		20	78106	CH
		RT3	2	51155	0	RT,HM	350/3,500		20		
RX350	07-09	RT3	2	33075	0	HM	350/3,500		20	78106	CH
		RT3	2	51155	0	RT,HM	350/3,500		20		
RX350 Except F Sport	10-12	SQ3	2	44633	0	GP, JR, JV	400/4,000	500/5,000	30	78106	CH
RX350 Except F Sport	13-20	SQ3	2	44633	0	GP, JR, JV	400/4,000	500/5,000	30	85708	CH, BN
RX350	16-19	SQ3	2	84540	0	GP, SV	675/4,500	675/4,500	20	85708	CH, BN
RX350L	18-20	SQ3	2	84156	0	HM, SV	500/5,000		30		BN, CH
		SQ3	2	84336	0	†, HM, SV	500/5,000		30		
RX400h Hybrid	06-08	RT3	2	33075	0	HM	350/3,500		20		
		RT3	2	51155	0	RT, HM	350/3,500		20		
RX450h Hybrid	10-15	SQ3	2	44633	0	GP, JR, JV	400/4,000	500/5,000	30	85708	BN, CH
RX450h	16-19	SQ3	2	84540	0	GP, SV	675/4,500	675/4,500	40	85708	BN, CH
<b>LINCOLN</b>											
Aviator	03-04	RT3	2	33031	0	HM, KL	500/5,000	800/8,000	20	74665	BN
Aviator	05	RT3	2	33031	0	HM, KL	500/5,000	800/8,000	20		
Continental	88-02	SQ1	1-1/4	77017	0	GP, JR	200/2,000		20		
Continental	17-20	SQ2	1-1/4	06178†	0	GP, JR, KH, SV	300/3,500		50	85898	CH
LS	00-06	SQ2	1-1/4	06393†	0	†, FE, GP	300/3,500		30	85251	
Mark LT (Built After 8/2005)	06-08	SQ4	2	44552	0	CP, HM	600/6,000	1,000/10,000	20		
		SQ4	2	51075	0	CP, HM	600/6,000	1,000/10,000	20		
		SQ5	2	96933	0	CP, HM	1,200/12,000	1,400/14,000	20		
Mark LT (Built Before 8/2005)	06	SQ3	2	44131	0		500/5,000	1,000/10,000	30		
		RT3	2	51064	0	RT, KM	500/5,000	1,000/10,000	30		
		RT4	2	37090	0	HM, KM	600/6,000	1,000/10,000	30		
		RT4	2	44655	0	HM, KM	600/6,000	800/8,000	30		
MKC	15-17	SQ2	1-1/4	06173	0	GP, JR	300/3,500		45	85985	CH
		SQ3	2	44756	0	GP, JR	525/3,500		45		
MKC	18-19	SQ2	1-1/4	06173	0	GP, JR	300/3,500		45		
		SQ3	2	44756	0	GP, JR	525/3,500		45		
MKS	09-12	SQ2	1-1/4	06663	0	GP, JR	300/3,500		30	78095	CH
MKS	13-16	SQ2	1-1/4	06663	0	GP, JR	300/3,500		30	85831	CH
MKT	10-11	RT3	2	44636	0	HM, JR	400/4,000	400/4,000	30	85727	CH
MKT	12-14	RT3	2	44636	0	HM, JR	400/4,000	400/4,000	30	85727	CH
MKT	15-20	RT3	2	44636	0	HM, JR	400/4,000	400/4,000	30		
MKX	07-10	SQ2	1-1/4	06525	0	GP, JR, KH	300/3,500		45	85774	CH
		SQ3	2	44764	0	GP, KH, JR	400/4,000	400/4,000	55		
		SQ3	2	51200	0	CP, GP, JR, KH	400/4,000		55		
MKX	11-15	SQ3	2	44764	0	GP, KH, JR	400/4,000	400/4,000	55	85746	CH
		SQ3	2	51200	0	GP, JR, KH	400/4,000		55		
MKX	16-18	SQ3	2	44784	0	GP, TA, SV, JR, TW	675/4,500	675/4,500	45	85898	CH
MKZ	07-09	SQ1	1-1/4	77152	0	GP, JR, TA	200/2,000		45	85731	CH
MKZ	10-12	SQ1	1-1/4	77239	0	GP, JR	200/2,000		20	85766	CH, TR
MKZ Except 3.0 Liter Engine	13-19	SQ1	1-1/4	77285	0	HM, SV	200/2,000		20	85823	CH
Nautilus	19	SQ3	2	44784	0	GP, TA, SV, JR, TW	675/4,500	675/4,500	45		
Nautilus	20	SQ3	2	44784	0	GP, TA, SV, JR, TW	675/4,500	675/4,500	45		

† Available while supply lasts.

**BN** Exterior mounted plug on some or all models. May require an aftermarket electrical mounting box or bracket. (Sold separately)

**CH** T-One is equipped with circuit protected ModuLite® module.

**CP** Fits all models without factory installed receiver.

**FE** Fascia trimming may be required. Allow additional installation time.

**GP** Hitch cross-tube concealed behind bumper.

**HM** Hitch cross-tube is visible beneath bumper.

**JR** Exhaust must be temporarily lowered for installation.

**JV** Rubber air deflector/fascia must be removed or trimmed to install hitch.

**KH** Minor heat shield modification may be required.

**KL** Hitch is designed to attach beneath the OEM hitch.

**KM** Does not work with models originally equipped with OEM hitch.

**0** Uses all existing holes. No drilling required.

**RT** Round Tube Class III/IV 2"

**SV** Trimming or removal of under body appearance panel may be required.

**TA** Trunk access required for hitch installation.

**TR** Trimming or Modification of the vehicle connector may be required.

**TW** Receiver hitch may limit hands-free liftgate sensor range

**RT3** Round Tube Class III 2"

**RT4** Round Tube Class IV 2"

**SQ1** Square Tube Class I

**SQ2** Square Tube Class II

**SQ3** Square Tube Class III

**SQ4** Square Tube Class IV

**SQ5** Square Tube Class V

# RECEIVER HITCH AND T-CONNECTOR APPLICATION GUIDE

RECEIVER HITCHES

MODEL / STYLE	YEAR	TRAILER HITCHES							T-CONNECTOR		
		REC TYPE	REC SIZE	PART NO.	NO DRILL	FOOTNOTES	WC (LBS.)	WD (LBS.)	IN	T-CON PART NO.	FN
<b>LINCOLN (Continued)</b>											
Navigator	98-02	SQ3	2	33052	0	GP	500/5,000	800/8,000	20	74665	BN
		SQ4	2	44622	0	GP	600/6,000	1,000/10,000	15		
Town Car	81-02	SQ1	1-1/4	77002†		†,CA,GP,HA	200/2,000		25		
Town Car	90-11	SQ3	2	33047		AB,CA,EO,GP,HA	350/3,500	750/6,000	30		
		SQ3	2	51103		AB,CA,EO,GP,HA	350/3,500	750/6,000	30		
Zephyr	06	SQ1	1-1/4	77152		GP,JR,TA	200/2,000		45	85731	CH
<b>MAZDA</b>											
2	11-14	SQ1	1-1/4	77252	0	GP,JR	200/2,000		30	85754	CH
3 4 Dr. Sedan, Except w/Grand Touring LED Taillights	04-09	SQ1	1-1/4	77188		GP	200/2,000		35	74697	CG
3 5 Dr. Hatchback, Except w/Grand Touring LED Taillights	04-09	SQ1	1-1/4	77188		GP	200/2,000		35	74697	CG
3 4 Dr. Sedan, w/Grand Touring LED Taillights	06-09	SQ1	1-1/4	77188		GP	200/2,000		35		
3 5 Dr. Hatchback, w/Grand Touring LED Taillights	06-09	SQ1	1-1/4	77188		GP	200/2,000		35		
3 4 Dr. Sedan, Except w/Grand Touring LED Taillights	10-13	SQ1	1-1/4	77244	0	GP	200/2,000		20	74697	CG
3 4 Dr. Sedan, w/Grand Touring LED Taillights	10-13	SQ1	1-1/4	77244	0	GP	200/2,000		20		
3 5 Dr. Hatchback, Except w/Grand Touring LED Taillights	10-13	SQ1	1-1/4	77245	0	GP	200/2,000		15	74697	CG
3 5 Dr. Hatchback, w/Grand Touring LED Taillights	10-13	SQ1	1-1/4	77245	0	GP	200/2,000		15		
3 4 Dr. Sedan	14-18	RT1	1-1/4	77299	0	HM,JR	200/2,000		15	85701	CH
3 5 Dr. Hatchback	14-18	SQ1	1-1/4	77301	0	HM,JR	200/2,000		30	85701	CH
3 Hatchback	19-20	SQ1	1-1/4	77984		GP,JR,KH,SV	200/2,000		40	89528	CH
3 Sedan	19-20	SQ1	1-1/4	77982	0	GP,SV	200/2,000		40	89528	CH
5	06-10	SQ1	1-1/4	77150		GP	200/2,000		25	85754	CH
5	12-20	SQ1	1-1/4	77262		GP	200/2,000		25	85754	CH
6 4 Dr. Sedan	03-08	SQ1	1-1/4	77152		GP,JR,TA	200/2,000		45	85701	CH
6 5 Dr. Hatchback	04-08	SQ1	1-1/4	77152		GP,JR,TA	200/2,000		45	85701	CH
6 Sport Wagon	04-07	SQ1	1-1/4	77159†	0	†,TA,GP	200/2,000		25		
6 4 Dr. Sedan	09-13	SQ1	1-1/4	77205		GP,JR	200/2,000		30	78112	CH
6 4 Dr. Sedan	14-20	SQ1	1-1/4	77295	0	HM	200/2,000		30	85821	CH
B2300	02-09	SQ3	2	44101		V	300/3,500	500/5,000	20	74424	BN,HG
		SQ3	2	51032		V	300/3,500	500/5,000	20		
		SQ3	2	37152	0		500/5,000	600/6,000	40		
B2500	98-01	SQ3	2	44101		V	300/3,500	500/5,000	20	74424	BN,HG
		SQ3	2	51032		V	300/3,500	500/5,000	20		
		SQ3	2	37152	0		500/5,000	600/6,000	40		
B3000	98-01	SQ3	2	44101		V	300/3,500	500/5,000	20	74424	BN,HG
		SQ3	2	51032		V	300/3,500	500/5,000	20		
		SQ3	2	37152	0		500/5,000	600/6,000	40		
B3000	02-08	SQ3	2	44101		V	300/3,500	500/5,000	20	74424	BN,HG
		SQ3	2	51032		V	300/3,500	500/5,000	20		
		SQ3	2	37152	0		500/5,000	600/6,000	40		
B4000	98-01	SQ3	2	44101		V	300/3,500	500/5,000	20	74424	BN,HG
		SQ3	2	51032		V	300/3,500	500/5,000	20		
		SQ3	2	37152	0		500/5,000	600/6,000	40		
B4000	02-09	SQ3	2	44101		V	300/3,500	500/5,000	20	74424	BN,HG
		SQ3	2	51032		V	300/3,500	500/5,000	20		
		SQ3	2	37152	0		500/5,000	600/6,000	40		
B-Series	98-09	SQ2		88001†		†	350/3,500		35	74424	HG
		SQ3	2	37042	0		500/5,000	600/6,000	40		
CX-3	16-20	SQ1	1-1/4	77320	0	JR,GP	200/2,000		25	85934	CH
CX-30	20	SQ1	1-1/4	77995		GP,JR,KH	200/2,000		45		

† Available while supply lasts.  
**AB** Requires four (4) 3/8 in. spacer blocks (#01077011) for installation. (Sold separately)  
**BN** Exterior mounted plug on some or all models. May require an aftermarket electrical mounting box or bracket. (Sold separately)  
**CA** Models with dual exhaust require exhaust modification.  
**CG** T-One incorporates circuit protected taillight converter.  
**CH** T-One is equipped with circuit protected ModuLite® module.  
**EO** Requires longer ball mount.  
**GP** Hitch cross tube concealed behind bumper.  
**HA** External dress panel beneath 95-97 and 03-05 vehicles must be removed for hitch installation.  
**HG** T-One incorporates taillight converter.  
**HM** Hitch cross tube is visible beneath bumper.  
**JR** Exhaust must be temporarily lowered for installation.

**KH** Minor heat shield modification may be required.  
**0** Uses all existing holes. No drilling required.  
**SV** Trimming or removal of under body appearance panel may be required.  
**TA** Trunk access required for hitch installation.  
**V** For vehicles with factory installed step bumpers only.

**RT1** Round Tube Class I 1-1/4"  
**SQ1** Square Tube Class I  
**SQ2** Square Tube Class II  
**SQ3** Square Tube Class III  
**SQ4** Square Tube Class IV

M - MAZDA

# RECEIVER HITCH AND T-CONNECTOR APPLICATION GUIDE

MODEL / STYLE	YEAR	TRAILER HITCHES							T-CONNECTOR		
		REC TYPE	REC SIZE	PART NO.	NO DRILL	FOOTNOTES	WC (LBS.)	WD (LBS.)	IN	T-CON PART NO.	FN
<b>MAZDA (Continued)</b>											
CX-5	13-16	SQ2	1-1/4	06948†	0	†,GP,JR	300/3,500		30	85793	CH
		SQ2	1-1/4	06185	0	GP,JR	350/3,500		30		
		SQ3	2	84138	0	GP,JR	675/4,500		20		
CX-5 Except Diesel	17-19	SQ2	1-1/4	06185	0	GP,JR	350/3,500		20	85964	CH
		SQ3	2	84138	0	GP,JR	675/4,500		20		
CX-5 Diesel	19	SQ3	2	84029	0	HM,JR,DU,SV	350/3,500		30	85964	CH
CX-7	07-12	SQ2	1-1/4	06401	0	GP,JR	300/3,500		40	85701	CH
		SQ3	2	44554	0	GP,JR	350/3,500		40		
CX-9	07-15	RT3	2	44572	0	HM	400/4,000	400/4,000	15	85754	CH
CX-9	16-17	SQ2	1-1/4	06174	0	SV,JR,GP	300/3,500		30		
		SQ3	2	84020	0	SV,JR,GP	675/4,500	675/4,500	30		
CX-9	18-20	SQ2	1-1/4	06174	0	SV,JR,GP	300/3,500		30		
		SQ3	2	84020	0	SV,JR,GP	675/4,500	675/4,500	30		
MPV w/Ground Effects	00-03	RT3	2	44553	0	HM,JR	350/3,500	500/5,000	20		
MPV	04-06	RT3	2	44553	0	HM,JR	350/3,500	500/5,000	20		
Protege	99-03	SQ1	1-1/4	77080†	0	†,HM	200/2,000		20		
Protege5	02-03	SQ1	1-1/4	77119†	0	†,JR,GP	200/2,000		15		
Tribute	01-03	SQ2		88001†		†,KH	350/3,500		60	74664	HG,RW
		RT3	2	44723	0	HM,KH	350/3,500	500/5,000	35		
		SQ3	2	37042		KH	500/5,000	600/6,000	60		
		SQ3	2	37152		KH	500/5,000	600/6,000	60		
Tribute	04	SQ2		88001†		†	350/3,500		60	74672	
		RT3	2	44723	0	HM	350/3,500	500/5,000	35		
		SQ3	2	37042			500/5,000	600/6,000	60		
		SQ3	2	37152			500/5,000	600/6,000	60		
Tribute	05-06	SQ2	1-1/4	06417		HM	300/3,500		20	74703	BN,CH
		SQ2	1-1/4	51194		HM	300/3,500		20		
		RT3	2	97232	0	HM	350/3,500	500/5,000	25		
		RT3	2	44680	0	HM	675/4,500	675/5,250	25		
Tribute	08-11	SQ2	1-1/4	06417		HM	300/3,500		20	85774	CH
		SQ2	1-1/4	51194		HM	300/3,500		20		
		RT3	2	97232	0	HM	350/3,500	500/5,000	25		
		RT3	2	44680	0	HM	675/4,500	675/5,250	25		
<b>MERCEDES-BENZ</b>											
C300 Sedan, Except Models w/Sport Package	15-20	SQ1	1-1/4	77953	0	DU,GP,SV	200/2,000		75		
GLA250	15-20	SQ3	2	44777	0	GP,JR,TA,KH,FE	350/3,500		90		
GLC300 SUV, Except P03 Premium Package	16-20	SQ3	2	84082	0	JR,GP,KH,TA,AA,DU,TW	675/4,500		65	89513	CH
GLC300 SUV, with P03 Premium Package	16-20	SQ3	2	84082	0	JR,GP,KH,TA,AA,DU,TW	675/4,500		65		
GLE350 Except w/Active Curve System	16-20	SQ4	2	84141	0	GP,JR,SV,KH	700/7,000	700/7,000	40		
GLK350	10-12	RT3	2	44690	0	HM	600/4,000		20		
GLK350	13-15	RT3	2	44690	0	HM	600/4,000		20		
Metris	16-20	SQ3	2	84015	0	HM	750/5,000	750/6,000	20		
ML320	98-02	SQ3	2	44720	0		500/5,000	500/5,000	30		
ML320 CDI Except w/Adaptive Variable Suspension	07-08	SQ3	2	44534		MB,TA	350/3,500	400/4,000	50		
ML350	03-05	SQ3	2	44720	0		500/5,000	500/5,000	30		
ML350 Except w/Adaptive Variable Suspension	06-09	SQ3	2	44534		MB,TA	350/3,500	400/4,000	50		
ML350 Except BlueTEC or w/Adaptive Variable Suspension	10-11	SQ3	2	44534		MB,TA	350/3,500	400/4,000	50		
ML350 Except w/Active Curve System	12-20	SQ4	2	84141	0	GP,JR,SV,KH	700/7,000	700/7,000	40		
ML430	99-01	SQ3	2	44720	0		500/5,000	500/5,000	30		
ML450 Hybrid, Except w/Adaptive Variable Suspension	10-11	SQ3	2	44534		MB,TA	350/3,500	400/4,000	50		
ML500	02-05	SQ3	2	44720	0		500/5,000	500/5,000	30		

† Available while supply lasts.	0 Uses all existing holes. No drilling required.	RT3 Round Tube Class III 2"
AA Requires temporary removal of bumper during installation.	RW On some models it may require an upgraded flasher or ModuLite®.	SQ1 Square Tube Class I
BN Exterior mounted plug on some or all models. May require an aftermarket electrical mounting box or bracket. (Sold separately)	SV Trimming or removal of under body appearance panel may be required.	SQ2 Square Tube Class II
CH T-One is equipped with circuit protected ModuLite® module.	TA Trunk access required for hitch installation.	SQ3 Square Tube Class III
DU Fascia removal required.	TW Receiver hitch may limit hands-free liftgate sensor range	SQ4 Square Tube Class IV
FE Fascia trimming may be required. Allow additional installation time.		
GP Hitch crossbar concealed behind bumper.		
HG T-One incorporates taillight converter.		
HM Hitch crossbar is visible beneath bumper.		
JR Exhaust must be temporarily lowered for installation.		
KH Minor heat shield modification may be required.		
MB Will not fit models equipped with air suspension package.		



# RECEIVER HITCH AND T-CONNECTOR APPLICATION GUIDE

RECEIVER HITCHES

MODEL / STYLE	YEAR	TRAILER HITCHES								T-CONNECTOR	
		REC TYPE	REC SIZE	PART NO.	NO DRILL	FOOTNOTES	WC (LBS.)	WD (LBS.)	IN	T-CON PART NO.	FN
<b>MERCEDES-BENZ (Continued)</b>											
ML500 Except w/Adaptive Variable Suspension	06-07	SQ3	2	44534		MB,TA	350/3,500	400/4,000	50		
ML550 Except w/Adaptive Variable Suspension	08-11	SQ3	2	44534		MB,TA	350/3,500	400/4,000	50		
R320 BlueTEC	09	SQ3	2	44547	0	SC	350/3,500		25		
R320 BlueTEC w/Panoramic Roof Package	09	SQ3	2	44547		SC	350/3,500		50		
R320 CDI	07-08	SQ3	2	44547	0	SC	350/3,500		25		
R320 CDI w/Panoramic Roof Package	07-08	SQ3	2	44547		SC	350/3,500		50		
R350	06-12	SQ3	2	44547	0	SC	350/3,500		25		
R350 w/Panoramic Roof Package	06-12	SQ3	2	44547		SC	350/3,500		50		
R500	06-07	SQ3	2	44547	0	SC	350/3,500		25		
R500 w/Panoramic Roof Package	06-07	SQ3	2	44547		SC	350/3,500		50		
Sprinter 144" & 170" Wheelbase, Except w/Factory Step Bumper	07-11	SQ4	2	44576	0	HM,UL	600/6,000	750/7,500	20	85925	CH
Sprinter w/Factory Step Bumper Excluding Models w/30-3/8" Frame Width	07-11	SQ3	2	44591	0	HM	500/5,000	750/7,500	30	85925	CH
Sprinter 144" & 170" Wheelbase, Except w/Factory Step Bumper	12-13	SQ4	2	44576	0	HM,UL	600/6,000	750/7,500	20	85925	CH
Sprinter w/Factory Step Bumper Excluding Models w/30-3/8" Frame Width	12-13	SQ3	2	44591	0	HM	500/5,000	750/7,500	30	85925	CH
Sprinter 144" & 170" Wheelbase, Except w/Factory Step Bumper	14-18	SQ4	2	44576	0	HM,UL	600/6,000	750/7,500	20	85925	CH
Sprinter w/Factory Step Bumper Excluding Models w/30-3/8" Frame Width	14-18	SQ3	2	44591	0	HM	500/5,000	750/7,500	30	85924	CH
Sprinter 2500 144" & 170" Wheelbase, Except w/Factory Step Bumper	10-11	SQ4	2	44576	0	HM,UL	600/6,000	750/7,500	20	85925	CH
Sprinter 2500 w/Factory Step Bumper Excluding Models w/30-3/8" Frame Width	10-11	SQ3	2	44591	0	HM	500/5,000	750/7,500	30	85925	CH
Sprinter 2500 144" & 170" Wheelbase, Except w/Factory Step Bumper	12-13	SQ4	2	44576	0	HM,UL	600/6,000	750/7,500	20	85925	CH
Sprinter 2500 144" & 170" Wheelbase, Except w/Factory Step Bumper	12-20	SQ4	2	44576	0	HM,UL	600/6,000	750/7,500	20	85924	CH
Sprinter 2500 w/Factory Step Bumper Excluding Models w/30-3/8" Frame Width	12-13	SQ3	2	44591	0	HM	500/5,000	750/7,500	30	85925	CH
Sprinter 2500 w/Factory Step Bumper Excluding Models w/30-3/8" Frame Width	12-20	SQ3	2	44591	0	HM	500/5,000	750/7,500	30	85924	CH
Sprinter 3500 144" & 170" Wheelbase, Except w/Factory Step Bumper	10-11	SQ4	2	44576	0	HM,UL	600/6,000	750/7,500	20	85925	CH
Sprinter 3500 w/Factory Step Bumper Excluding Models w/30-3/8" Frame Width	10-11	SQ3	2	44591	0	HM	500/5,000	750/7,500	30	85925	CH
Sprinter 3500 144" & 170" Wheelbase, Except w/Factory Step Bumper	12-13	SQ4	2	44576	0	HM,UL	600/6,000	750/7,500	20	85925	CH
Sprinter 3500 144" & 170" Wheelbase, Except w/Factory Step Bumper	12-20	SQ4	2	44576	0	HM,UL	600/6,000	750/7,500	20	85924	CH
Sprinter 3500 w/Factory Step Bumper Excluding Models w/30-3/8" Frame Width	12-13	SQ3	2	44591	0	HM	500/5,000	750/7,500	30	85925	CH
Sprinter 3500 w/Factory Step Bumper Excluding Models w/30-3/8" Frame Width	12-20	SQ3	2	44591	0	HM	500/5,000	750/7,500	30	85924	CH
<b>MERCURY</b>											
Grand Marquis	98-11	SQ1	1-1/4	77002†		†,CA,GP	200/2,000		25		
		SQ3	2	33047		CA,GP	350/3,500	750/6,000	30		
		SQ3	2	51103		CA,GP	350/3,500	750/6,000	30		
Marauder	03-04	SQ1	1-1/4	77002†		†,CA,GP	200/2,000		25		
		SQ3	2	33047		CA,GP	350/3,500	750/6,000	30		
		SQ3	2	51103		CA,GP	350/3,500	750/6,000	30		

M - MERCURY

- † Available while supply lasts.
- CA Models with dual exhaust require exhaust modification.
- CH T-One is equipped with circuit protected ModuLite® module.
- GP Hitch crosstube concealed behind bumper.
- HM Hitch crosstube is visible beneath bumper.
- MB Will not fit models equipped with air suspension package.
- 0 Uses all existing holes. No drilling required.
- SC Minor trimming of plastic trunk pan required.
- TA Trunk access required for hitch installation.
- UL This hitch will not fit a Sprinter single or dual rear-wheel vehicle with a 30-3/8 in. wide frame measured outside of frame to outside of frame.

- SQ1 Square Tube Class I
- SQ3 Square Tube Class III
- SQ4 Square Tube Class IV

# RECEIVER HITCH AND T-CONNECTOR APPLICATION GUIDE

MODEL / STYLE	YEAR	TRAILER HITCHES							T-CONNECTOR		
		REC TYPE	REC SIZE	PART NO.	NO DRILL	FOOTNOTES	WC (LBS.)	WD (LBS.)	IN	T-CON PART NO.	FN
<b>MERCURY (Continued)</b>											
Mariner	05-07	SQ2	1-1/4	06417		HM	300/3,500		20	85774	CH
		SQ2	1-1/4	51194		HM	300/3,500		20		
		RT3	2	97232	0	HM	350/3,500	500/5,000	25		
		RT3	2	44680	0	HM	675/4,500	675/5,250	25		
Mariner	08-11	SQ2	1-1/4	06417		HM	300/3,500		20	85774	CH
		SQ2	1-1/4	51194		HM	300/3,500		20		
		RT3	2	97232	0	HM	350/3,500	500/5,000	25		
		RT3	2	44680	0	HM	675/4,500	675/5,250	25		
Milan	06-09	SQ1	1-1/4	77152		GP, JR, TA	200/2,000		45	85731	CH
Milan	10-11	SQ1	1-1/4	77239	0	GP, JR	200/2,000		20	85731	CH
Montego	05-07	SQ2	1-1/4	06301	0	GP, JR	300/3,500		30		
		SQ2	1-1/4	51179	0	GP, JR	300/3,500		30		
		SQ3	2	44525	0	JR	350/3,500	400/4,000	30		
Monterey	04-07	SQ2	1-1/4	06989	0	GP, JR	300/3,500		25	78022	CH
		SQ3	2	44129	0	GP, JR	350/3,500	500/5,000	30		
Mountaineer	97-01	SQ2	1-1/4	06365	0	HM	300/3,500		15	74724	BN, CH
		SQ3	2	37012	0	HM	500/5,000	600/6,000	40		
		RT3	2	37041	0	JF	500/5,000	600/6,000	30		
		RT3	2	44067	0	JF, HM	500/5,000	600/6,000	45		
		SQ3	2	44100	0	HM	500/5,000	600/6,000	20		
		SQ3	2	51033	0	HM	500/5,000	600/6,000	15		
Mountaineer	02-03	RT3	2	33031	0	HM, KL	500/5,000	800/8,000	20	74665	BN
Mountaineer	04-05	RT3	2	33031	0	HM, KL	500/5,000	800/8,000	20		
Mountaineer w/1-1/4" Receivers	06-07	RT3	2	44542	0	HM, KL	500/5,000	800/8,000	25		
Mountaineer w/1-1/4" Receivers	08-10	RT3	2	44542	0	HM, KL	500/5,000	800/8,000	25		
Sable Sedan	96-99	SQ1	1-1/4	77017	0	GP, JR	200/2,000		20	74657	HG
Sable Wagon	96-99	SQ1	1-1/4	77017	0	GP, JR	200/2,000		20		
Sable Sedan	00-03	SQ1	1-1/4	77017	0	GP, JR	200/2,000		20	85243	
		SQ2	1-1/4	06991	0	GP, JR	300/3,500		40		
Sable Wagon	00-03	SQ1	1-1/4	77017	0	GP, JR	200/2,000		20		
		SQ2	1-1/4	06991	0	GP, JR	300/3,500		40		
Sable Sedan	04-05	SQ2	1-1/4	06991	0	GP, JR	300/3,500		40		
Sable Wagon	04-05	SQ2	1-1/4	06991	0	GP, JR	300/3,500		40		
Sable Sedan	08-09	SQ2	1-1/4	06301	0	GP, JR	300/3,500		30	78069	
		SQ2	1-1/4	51179	0	GP, JR	300/3,500		30		
		SQ3	2	44525	0	JR	350/3,500	400/4,000	30		
Villager	99-02	SQ2	1-1/4	06968†	0	†JR, GP	300/3,500		15		
		SQ3	2	33017†	0	†JR	350/3,500	500/5,000	15		
<b>MINI</b>											
Cooper Countryman Except John Cooper Works Model	11-16	SQ1	1-1/4	77321	0	DU, GP, X	200/2,000		70		
<b>MITSUBISHI</b>											
Eclipse	06-12	SQ1	1-1/4	77130		TA, GP	200/2,000		30		
Eclipse Cross	18-20	SQ3	2	84244	0		675/4,500		20		
Endeavor	04-05	RT3	2	33080	0	JR	350/3,500	500/5,000	20	85743	
Endeavor	06-08	SQ3	2	44561	0	JR	350/3,500		25	85743	
Galant	07-12	SQ1	1-1/4	77209†	0	JR, KH, HM	200/2,000		30	74697	CG
L200 w/Factory Step Bumper	15-20	SQ4	2	84114	0	AA	750/7,500	750/7,500	45		
Lancer 4 Dr. Sedan, Except Evolution, Ralliart & w/Dual Exhaust	08-11	SQ1	1-1/4	77273	0	GP, JR	200/2,000		25		
Lancer 5 Dr. Hatchback, Except Ralliart & w/Dual Exhaust	10-14	SQ1	1-1/4	77273	0	GP, JR	200/2,000		25	85758	
Lancer 4 Dr. Sedan, Except Evolution, Ralliart & w/Dual Exhaust	12-17	SQ1	1-1/4	77273	0	GP, JR	200/2,000		25	85758	

† Available while supply lasts.  
**AA** Requires temporary removal of bumper during installation.  
**BN** Exterior mounted plug on some or all models. May require an aftermarket electrical mounting box or bracket. (Sold separately)  
**CG** T-One incorporates circuit protected taillight converter.  
**CH** T-One is equipped with circuit protected ModuLite® module.  
**DU** Fascia removal required.  
**GP** Hitch cross-tube concealed behind bumper.  
**HG** T-One incorporates taillight converter.  
**HM** Hitch cross-tube is visible beneath bumper.  
**JF** Will not fit with 16 in. spare tire.  
**JR** Exhaust must be temporarily lowered for installation.  
**KH** Minor heat shield modification may be required.

**KL** Hitch is designed to attach beneath the OEM hitch.  
**0** Uses all existing holes. No drilling required.  
**TA** Trunk access required for hitch installation.  
**X** Minor fascia trimming required.

**RT3** Round Tube Class III 2"  
**SQ1** Square Tube Class I  
**SQ2** Square Tube Class II  
**SQ3** Square Tube Class III  
**SQ4** Square Tube Class IV

# RECEIVER HITCH AND T-CONNECTOR APPLICATION GUIDE

RECEIVER HITCHES

MODEL / STYLE	YEAR	TRAILER HITCHES							T-CONNECTOR		
		REC TYPE	REC SIZE	PART NO.	NO DRILL	FOOTNOTES	WC (LBS.)	WD (LBS.)	IN	T-CON PART NO.	FN
<b>MITSUBISHI (Continued)</b>											
Mirage	14-15	SQ1	1-1/4	77303	0	HM,JR	200/2,000		20	85986	CH
Mirage Except Mirage G4	17-20	SQ1	1-1/4	77303	0	HM,JR	200/2,000		20	85986	CH
Montero Except Montero Sport	01-06	SQ3	2	33028	0	KH	500/5,000	550/5,500	25	85252	BN,HG
Montero Sport	97-04	SQ3	2	33044	0	†,GP	500/5,000	550/5,500	20		
Outlander	03-06	SQ1	1-1/4	77048	0	KH,GP	200/2,000		40	85315	
Outlander	07-10	SQ3	2	44579	0	HM,JR	400/4,000	400/4,000	25	85745	CH
Outlander Except Outlander Sport or PHEV	11-13	SQ3	2	44579	0	HM,JR	400/4,000	400/4,000	25	85745	CH
Outlander Except Outlander Sport or PHEV	14-20	RT3	2	44707	0	HM,JR	600/4,000	600/4,000	30	78109	CH
Outlander Except Outlander Sport or PHEV	16-20	RT3	2	44707	0	HM,JR	600/4,000	600/4,000	30	78109	CH
Outlander Sport Except PHEV	11-20	RT2	1-1/4	06131	0	HM	300/3,500		30	85758	CH
		SQ3	2	84098	0		675/4,500		20		
Raider	06-09	SQ3	2	33092	0	HM	500/5,000	800/8,000	20	74187	BN,HJ
		SQ3	2	51138	0	HM	500/5,000	800/8,000	20		
RVR (Canada Only)	11-14	RT2	1-1/4	06131	0	HM	300/3,500		30	85758	CH
RVR (Canada Only)	11-20	SQ3	2	84098	0		675/4,500		30	85758	CH
Triton w/Factory Step Bumper	15-20	SQ4	2	84114	0	AA	750/7,500	750/7,500	45		
<b>NISSAN</b>											
Altima	98-01	SQ1	1-1/4	77112	0	HM,JR	200/2,000		20	74218	HG
Altima	02-06	SQ1	1-1/4	77162	0	JR,TA,GP	200/2,000		30		
Altima Sedan	07-15	SQ1	1-1/4	77168		AE,HM,TA	200/2,000		45	78094	CH
Altima Coupe, Except SR Models	08-13	SQ1	1-1/4	77172†	0	†,HM	200/2,000		30	78094	CH
Altima Sedan	16-20	SQ1	1-1/4	77168		AE,HM,TA	200/2,000		45	85942	CH
Armada	05-07	RT4	2	44674	0	HM	600/6,000	1,000/10,000	15		
Armada	08-14	RT4	2	44596	0	HM	600/6,000	1,000/10,000	15		
Cube	09-13	SQ1	1-1/4	77233		HM,JR	200/2,000		45	85713	CG
Frontier	98-04	SQ2		88001†		†	350/3,500		45	74219	HG
		SQ3	2	44148			400/4,000	550/5,500	30		
		SQ3	2	37042			500/5,000	600/6,000	35		
		SQ3	2	37152			500/5,000	600/6,000	35		
Frontier	05-20	SQ3	2	51147	0	GP	500/5,000	800/8,000	30	85757	BN
		SQ3	2	44526	0	GP,TE	750/5,000	800/8,000	30		
Frontier	21	SQ3	2	51147	0	GP	500/5,000	800/8,000	30	85757	BN
		SQ3	2	44526	0	GP,TE	750/5,000	800/8,000	30		
JUKE AWD, Except Nismo & Nismo RS	11-17	SQ1	1-1/4	77248	0	HM,JR	200/2,000		40	85755	CH
JUKE FWD, Except Nismo & Nismo RS	11-17	SQ1	1-1/4	77280		HM,JR	200/2,000		25	85755	CH
Kicks	18-20	SQ1	1-1/4	77980		GP,JR,KH	200/2,000		45	89520	CH,BN
Kicks	19-20	SQ1	1-1/4	77980		GP,JR,KH	200/2,000		45		
Maxima Sedan	95-99	SQ1	1-1/4	77028		TA,GP	200/2,000		30		
Maxima Sedan	00-02	SQ1	1-1/4	77028		TA,GP	200/2,000		30		
Maxima Sedan	03	SQ1	1-1/4	77028		TA,GP	200/2,000		30		
Maxima	04-08	SQ1	1-1/4	77162	0	JR,TA,GP	200/2,000		30	78094	CH
Maxima	09-14	SQ1	1-1/4	77168		AE,HM,TA	200/2,000		45	78094	CH
Maxima	16-21	SQ1	1-1/4	77168		AE,HM,TA	200/2,000		45	85893	CH
Murano	03-05	SQ3	2	44583	0	JR	350/3,500		30		
Murano	06-07	SQ3	2	44583	0	JR	350/3,500		30	85991	CH
Murano Except w/Aero Kit & CrossCabriolet	09-14	SQ3	2	44600	0	GP,JR	400/4,000		35	85849	CH
Murano	15-20	RT3	2	44761	0	HM	600/4,000	600/4,000	15	85868	CH
NP300 Navara International Only	16-20	SQ4	2	84078	0	HM	800/8,000	800/8,000	30		
NV1500	13-20	SQ4	2	44664	0	HM	1,125/7,500	1,000/10,000	20	85776	CH
NV200	13-20	RT3	2	44711	0	HM,JR,X	525/3,500		30	85829	CH
NV2500	12-20	SQ4	2	44664	0	HM	1,125/7,500	1,000/10,000	20	85776	CH
NV3500	12-20	SQ4	2	44664	0	HM	1,125/7,500	1,000/10,000	20	85776	CH

- † Available while supply lasts.
- AA Requires temporary removal of bumper during installation.
- AE Requires temporary removal of muffler during installation.
- BN Exterior mounted plug on some or all models. May require an aftermarket electrical mounting box or bracket. (Sold separately)
- CG T-One incorporates circuit protected taillight converter.
- CH T-One is equipped with circuit protected ModuLite® module.
- GP Hitch cross-tube concealed behind bumper.
- HG T-One incorporates taillight converter.
- HJ Per Dodge owner's manual: If trailer is equipped with more than standard lighting (1 taillight per side) use of ModuLite® or dealer supplied harness is required.
- HM Hitch cross-tube is visible beneath bumper.
- JR Exhaust must be temporarily lowered for installation.
- KH Minor heat shield modification may be required.

- 0 Uses all existing holes. No drilling required.
- TA Trunk access required for hitch installation.
- TE Hitches produced before 04/20/11 are rated at 500/5000 WC.
- X Minor fascia trimming required.

- RT2 Round Tube Class II 1-1/4"
- RT3 Round Tube Class III 2"
- RT4 Round Tube Class IV 2"
- SQ1 Square Tube Class I
- SQ2 Square Tube Class II
- SQ3 Square Tube Class III
- SQ4 Square Tube Class IV

N - NISSAN

# RECEIVER HITCH AND T-CONNECTOR APPLICATION GUIDE

MODEL / STYLE	YEAR	TRAILER HITCHES							T-CONNECTOR		
		REC TYPE	REC SIZE	PART NO.	NO DRILL	FOOTNOTES	WC (LBS.)	WD (LBS.)	IN	T-CON PART NO.	FN
<b>NISSAN (Continued)</b>											
Pathfinder	96-04	SQ2	1-1/4	06061†	0	†,HM	300/3,500		20	74218	HG
		RT3	2	33050	0		500/5,000	550/5,500	20		
		SQ3	2	44132	0		500/5,000	550/5,500	20		
		SQ3	2	51046	0	HM	500/5,000	550/5,500	20		
Pathfinder	13-17	SQ3	2	84031	0	HM	900/6,000	900/6,000	25	85883	BN
Pathfinder	18-20	SQ3	2	84031	0	HM	900/6,000	900/6,000	25	85883	BN
Pathfinder Armada	04	RT4	2	44674	0	HM	600/6,000	1,000/10,000	15		
Qashqai	17-20	SQ3	2	84177	0	GP, JR	525/3,500		45		
Quest	99-02	SQ2	1-1/4	06968†	0	†,JR,GP	300/3,500		15		
		SQ3	2	33017†	0	†,JR	350/3,500	500/5,000	15		
Quest	04-09	SQ3	2	33079	0	JR	350/3,500	500/5,000	20	78093	CH
Quest	11-16	RT3	2	44663	0	HM, JR	525/3,500		35	85770	BN, CH
Rogue Except Krom	08-13	SQ2	1-1/4	06162	0	GP, TW	300/3,500		15	78108	CH
		SQ3	2	44712	0	GP, TW	350/3,500		15		
Rogue Except Sport	14-20	SQ2	1-1/4	06162	0	GP, TW	300/3,500		15	78108	CH
		SQ3	2	44712	0	GP, TW	350/3,500		15		
Rogue Select	14	SQ2	1-1/4	06162	0	GP, TW	300/3,500		15	78108	CH
		SQ3	2	44712	0	GP, TW	350/3,500		15		
Rogue Sport	17-19	SQ3	2	84177	0	GP, JR	525/3,500		45	85971	CH
Rogue Sport	20	SQ3	2	84177	0	GP, JR	525/3,500		45		CH
Sentra	00-02	SQ1	1-1/4	77126	0	TA, HM	200/2,000		20		
Sentra	03-06	SQ1	1-1/4	77126	0	TA, HM	200/2,000		20		
Sentra	07-12	SQ1	1-1/4	77166		TA, GP	200/2,000		30	78094	CH
Sentra Except SR	13-20	SQ1	1-1/4	77294		HM	200/2,000		35	85817	CH
Titan	04-15	RT4	2	37092	0		600/6,000	1,000/10,000	15		
		RT4	2	51106	0	RT	600/6,000	1,000/10,000	15		
Titan Except Titan XD or Models w/ Factory 7-Way Wiring	17-20	RT4	2	84154	0	HM	800/8,000	1,200/12,000	30		
Titan w/ Factory 7-Way Wiring Except Titan XD	17-20	RT4	2	84154	0	HM	800/8,000	1,200/12,000	30		
Titan Except Titan XD or Models w/ Factory 7-Way Wiring	21	RT4	2	84154	0	HM	800/8,000	1,200/12,000	30		
Titan w/ Factory 7-Way Wiring Except Titan XD	21	RT4	2	84154	0	HM	800/8,000	1,200/12,000	30		
Versa 4 Dr. Sedan	07-11	SQ1	1-1/4	77170		HM	200/2,000		25		
Versa 5 Dr. Hatchback	07-12	SQ1	1-1/4	77170		HM	200/2,000		25	85768	CH
Versa 4 Dr. Sedan	12-20	SQ1	1-1/4	77275		HM, JR, KH	200/2,000		30		
Versa Note	14-20	SQ1	1-1/4	77296		HM, JR, KH	200/2,000		30	85817	CH
Xterra	00-04	RT3	2	33019	0		350/3,500	550/5,500	15		
Xterra	05-15	RT3	2	44529	0		350/3,500	550/5,500	30	85757	BN
X-Trail (Canada Only)	05-06	SQ1	1-1/4	77096	0	EP, GP	200/2,000		45		
<b>OLDSMOBILE</b>											
Alero	99-04	SQ2	1-1/4	06299		GP	300/3,500		20		
Aurora	01-03	SQ2	1-1/4	06976		HM, JR	300/3,500		30		
		SQ2	1-1/4	51173		HM, JR	300/3,500		30		
Bravada	98-01	SQ2	1-1/4	06955†	0	FP, GP, KK	300/3,500		15		
		RT3	2	33015	0	FP, KK, SD	400/4,000	600/6,000	15		
		SQ3	2	44098	0	FP, HM, KK	400/4,000	600/6,000	20		
		SQ3	2	51031	0	FP, HM, KK	400/4,000	600/6,000	15		
		RT3	2	37041	0	FP, JT, KK	500/5,000	600/6,000	30		
Cutlass 4 Dr., FWD	97-99	SQ1	1-1/4	77076	0	GP	200/2,000		15		
		SQ2	1-1/4	06249		GP	300/3,500		20		
Intrigue	98-02	SQ1	1-1/4	77109		TA, GP	200/2,000		30		
		SQ2	1-1/4	06384		GP, JR	300/3,500		30		
		SQ2	1-1/4	51183		GP, JR	300/3,500		30		

† Available while supply lasts.

**BN** Exterior mounted plug on some or all models. May require an aftermarket electrical mounting box or bracket. (Sold separately)

**CH** T-One is equipped with circuit protected ModuLite® module.

**EP** Fascia trimming may be required.

**FP** Spare tire repositioning and/or modification of spare tire carrier may be required.

**GP** Hitch cross-tube concealed behind bumper.

**HG** T-One incorporates taillight converter.

**HM** Hitch cross-tube is visible beneath bumper.

**JR** Exhaust must be temporarily lowered for installation.

**JT** 2WD models only.

**KH** Minor heat shield modification may be required.

**KK** When installing on a vehicle originally equipped with an OEM hitch, OEM bumper brackets must be purchased and installed prior to new hitch installation.

**0** Uses all existing holes. No drilling required.

**RT** Round Tube Class III/IV 2"

**SD** Hitches produced before 07/21/06 are rated at 350/3500 WC.

**TA** Trunk access required for hitch installation.

**TW** Receiver hitch may limit hands-free liftgate sensor range

**RT3** Round Tube Class III 2"

**RT4** Round Tube Class IV 2"

**SQ1** Square Tube Class I

**SQ2** Square Tube Class II

**SQ3** Square Tube Class III

# RECEIVER HITCH AND T-CONNECTOR APPLICATION GUIDE

RECEIVER HITCHES

MODEL / STYLE	YEAR	TRAILER HITCHES								T-CONNECTOR	
		REC TYPE	REC SIZE	PART NO.	NO DRILL	FOOTNOTES	WC (LBS.)	WD (LBS.)	IN	T-CON PART NO.	FN
<b>OLDSMOBILE (Continued)</b>											
Silhouette	97-04	SQ1	1-1/4	77040†		†,AL,GP,JR	200/2,000		30	74207	HG
		SQ2	1-1/4	51102		AL,GP,JR	300/3,500		40		
		SQ3	2	44574		AL,JR	350/3,500	500/5,000	40		
		SQ3	2	51079		AL,GP,JR	350/3,500	500/5,000	40		
<b>PLYMOUTH</b>											
Breeze	96-00	SQ2	1-1/4	06977		JR,HM	300/3,500		60		
Grand Voyager	96-00	SQ2		88001†		†	350/3,500		45	74658	HG
		RT3	2	33045†		†	350/3,500	500/5,000	30		
		SQ3	2	44006		HM	350/3,500	400/3,500	30		
		SQ3	2	51062		HM	350/3,500	400/3,500	30		
		SQ3	2	37042			500/5,000	600/6,000	40		
		SQ3	2	37152			500/5,000	600/6,000	40		
Neon	00-01	SQ1	1-1/4	77052†		†,GP,JR	200/2,000		20		
Voyager	96-00	SQ2		88001†		†	350/3,500		45	74658	HG
		RT3	2	33045†		†	350/3,500	500/5,000	30		
		SQ3	2	44006		HM	350/3,500	400/3,500	30		
		SQ3	2	51062		HM	350/3,500	400/3,500	30		
		SQ3	2	37042			500/5,000	600/6,000	40		
		SQ3	2	37152			500/5,000	600/6,000	40		
<b>PONTIAC</b>											
Aztek	01-05	SQ2	1-1/4	06457†		HM	300/3,500		40	85261	BN
		SQ3	2	33061	Ø		350/3,500		55		
		SQ3	2	44538			350/3,500		40		
		SQ3	2	51151		HM	350/3,500		40		
Bonneville	00-05	SQ2	1-1/4	06976		HM,JR	300/3,500		30		
		SQ2	1-1/4	51173		HM,JR	300/3,500		30		
G3 5 Dr.	09	SQ1	1-1/4	77097		GP	200/2,000		30	85709	CG
G3 Wave 5 Dr. (Canada Only)	09	SQ1	1-1/4	77097		GP	200/2,000		30		
G5 Except GT	07-09	SQ1	1-1/4	77122		JR,HM	200/2,000		40	78043	BN
G5 GT	07-09	SQ1	1-1/4	51164		HM,JR	200/2,000		25	78043	BN
		SQ1	1-1/4	77132		HM,JR	200/2,000		25		
G6	05-09	SQ2	1-1/4	06463		GP	300/3,500		30	74716	BN
G8	08-09	SQ1	1-1/4	77193†	Ø	†,JR,KH,HM	200/2,000		45		
Grand Am	99-05	SQ2	1-1/4	06299		GP	300/3,500		20		
Grand Prix	97-08	SQ1	1-1/4	77077†	Ø	†,TA,GP	200/2,000		20		
		SQ2	1-1/4	06262		JR,GP	300/3,500		35		
Grand Prix SE Sedan	97-03	SQ1	1-1/4	77109		TA,GP	200/2,000		30		
Montana	99-05	SQ1	1-1/4	77040†		†,AL,GP,JR	200/2,000		30	74207	HG
		SQ2	1-1/4	51102		AL,GP,JR	300/3,500		40		
		SQ3	2	44574		AL,JR	350/3,500	500/5,000	40		
		SQ3	2	51079		AL,GP,JR	350/3,500	500/5,000	40		
Montana SV6	05-06	SQ2	1-1/4	51102		AL,GP,JR	300/3,500		40	85344	BN
		SQ3	2	44574		AL,JR	350/3,500	500/5,000	40		
		SQ3	2	51079		AL,GP,JR	350/3,500	500/5,000	40		
Montana SV6 (Canada Only)	07-09	SQ2	1-1/4	51102		AL,GP,JR	300/3,500		40	85344	BN
		SQ3	2	44574		AL,JR	350/3,500	500/5,000	40		
		SQ3	2	51079		AL,GP,JR	350/3,500	500/5,000	40		
Pursuit 2 Dr. (Canada Only)	05-06	SQ1	1-1/4	77122		JR,HM	200/2,000		40	78043	BN
Pursuit 4 Dr. (Canada Only)	05-06	SQ1	1-1/4	77122		JR,HM	200/2,000		40	78035	BN
Solstice	06-08	SQ1	1-1/4	77206	Ø	HM,JR	200/2,000		35		
Solstice GXP	07-08	SQ1	1-1/4	77206	Ø	HM,JR,X	200/2,000		35		
Solstice	09	SQ1	1-1/4	77206		HM,JR	200/2,000		40		
Solstice GXP	09	SQ1	1-1/4	77206		HM,JR,X	200/2,000		40		

- † Available while supply lasts.
- AL Additional installation time required for vehicles equipped with load leveling compressor.
- BN Exterior mounted plug on some or all models. May require an aftermarket electrical mounting box or bracket. (Sold separately)
- CG T-One incorporates circuit protected taillight converter.
- GP Hitch crosstube concealed behind bumper.
- HG T-One incorporates taillight converter.
- HM Hitch crosstube is visible beneath bumper.
- JR Exhaust must be temporarily lowered for installation.
- KH Minor heat shield modification may be required.
- Ø Uses all existing holes. No drilling required.
- TA Trunk access required for hitch installation.
- X Minor fascia trimming required.

- RT3 Round Tube Class III 2"
- SQ1 Square Tube Class I
- SQ2 Square Tube Class II
- SQ3 Square Tube Class III

P - PONTIAC



# RECEIVER HITCH AND T-CONNECTOR APPLICATION GUIDE

MODEL / STYLE	YEAR	TRAILER HITCHES							T-CONNECTOR		
		REC TYPE	REC SIZE	PART NO.	NO DRILL	FOOTNOTES	WC (LBS.)	WD (LBS.)	IN	T-CON PART NO.	FN
<b>PONTIAC (Continued)</b>											
Sunfire Except GT	95-99	SQ1	1-1/4	77049†		GP, JR	200/2,000		40		
Sunfire	00-02	SQ1	1-1/4	77069†		†, JR, KH, GP	200/2,000		40		
Sunfire	03-05	SQ1	1-1/4	77049†		GP, JR	200/2,000		40		
Sunfire GT	95-99	SQ1	1-1/4	77069†		†, JR, KH, GP	200/2,000		40		
Torrent	06	SQ2	1-1/4	06391	0	HM	300/3,500		25	78028	CG
		SQ2	1-1/4	51185	0	HM	300/3,500		25		
		SQ3	2	51193	0	HM	350/3,500	400/4,000	30		
		SQ3	2	84028	0	HM	675/4,500	675/4,500	30		
Torrent	07-09	SQ2	1-1/4	06391	0	HM	300/3,500		25	74709	CE
		SQ2	1-1/4	51185	0	HM	300/3,500		25		
		SQ3	2	51193	0	HM	350/3,500	400/4,000	30		
		SQ3	2	84028	0	HM	675/4,500	675/4,500	30		
Vibe	03-08	SQ1	1-1/4	51169	0	HM	200/2,000		15	78008	CG
		SQ1	1-1/4	77183	0	HM	200/2,000		15		
Vibe Except GT	09-10	SQ1	1-1/4	51169	0	HM	200/2,000		15	78010	CH
		SQ1	1-1/4	77183	0	HM	200/2,000		15		
Wave 5 Dr. (Canada Only)	05-07	SQ1	1-1/4	77097		GP	200/2,000		30		
Wave5 (Canada Only)	08	SQ1	1-1/4	77097		GP	200/2,000		30		
<b>PORSCHE</b>											
Cayenne	11-18	SQ4	2	44758	0	GP, EP, TA	750/7,500		70		
Cayenne Coupe	20	SQ3	2	84338	0	GP, TZ, X	600/6,000		75		
Macan	15-20	SQ3	2	44755	0	DU, EP, GP, TA	750/5,000		60		
<b>RAM</b>											
1500	11-12	SQ4	2	44603		CP	600/6,000	1,000/10,000	20		
		RT5	2	44782	0	CP	1,000/10,000	1,200/12,000	40		
		SQ5	2	96948	0	HM, CP	1,500/12,000	1,500/15,000	30		
1500	13-14	SQ4	2	44603		CP	600/6,000	1,000/10,000	20		
		RT5	2	44782	0	CP	1,000/10,000	1,200/12,000	40		
		SQ5	2	96948	0	HM, CP	1,500/12,000	1,500/15,000	30		
1500	15-18	SQ4	2	44603		CP	600/6,000	1,000/10,000	20		
		RT5	2	44782	0	CP	1,000/10,000	1,200/12,000	40		
		SQ5	2	96948	0	HM, CP	1,500/12,000	1,500/15,000	30		
1500	19-20	SQ3	2	84328		CP	600/6,000		15		
1500 (Classic)	19	SQ4	2	44603		CP	600/6,000	1,000/10,000	20		
		RT5	2	44782	0	CP	1,000/10,000	1,200/12,000	40		
		SQ5	2	96948	0	HM, CP	1,500/12,000	1,500/15,000	30		
1500 (New Body Style)	19-20	SQ5	2	96913	0	AA, EF, J, LT	1,700/15,000	1,700/17,000	30		
1500	21	SQ3	2	84328		CP	600/6,000		15		
1500 (New Body Style)	21	SQ5	2	96913	0	AA, EF, J, LT	1,700/15,000	1,700/17,000	30		
2500	11-12	SQ5	2	96929		GP, KL, SG	1,200/12,000	1,500/15,000	35		
		SQ5	2	45709		AA, GH, HM, LT, SO, TO	2,000/18,000	2,500/18,000	95		
		SQ5	2-1/2	45299†		†, AA, GH, HM, LT, SO, TO	2,000/18,000	2,500/18,000	95		
2500 Except Mega Cab	11-12	SQ5	2-1/2	45288†		†, KL, SB	1,200/12,000	1,700/14,000	35		
		SQ5	2-1/2	45718		#, KL, SB	1,200/12,000	1,700/14,000	35		
2500	13-14	SQ5	2	96929		GP, KL, SG	1,200/12,000	1,500/15,000	35		
		SQ5	2	45709		AA, GH, HM, LT, SO, TO	2,000/18,000	2,500/18,000	95		
		SQ5	2-1/2	45299†		†, AA, GH, HM, LT, SO, TO	2,000/18,000	2,500/18,000	95		
2500 Except Mega Cab	13-14	SQ5	2-1/2	45288†		†, KL, SB	1,200/12,000	1,700/14,000	35		
		SQ5	2-1/2	45718		#, KL, SB	1,200/12,000	1,700/14,000	35		
2500	15-21	SQ5	2	96929		GP, KL, SG	1,200/12,000	1,500/15,000	35		
		SQ5	2	45709		AA, GH, HM, LT, SO, TO	2,000/18,000	2,500/18,000	95		
		SQ5	2-1/2	45299†		†, AA, GH, HM, LT, SO, TO	2,000/18,000	2,500/18,000	95		

# Titan hitches require use of a 2-1/2" shank Titan ball mount.	HM Hitch cross-tube is visible beneath bumper.	RT5 Round Tube Class V 2"
† Available while supply lasts.	J Under vehicle spare tire storage is retained.	SQ1 Square Tube Class I
AA Requires temporary removal of bumper during installation.	JR Exhaust must be temporarily lowered for installation.	SQ2 Square Tube Class II
CE T-One includes fuse(s) & relay(s). Converter not required. Standard 2 wire system at factory tow plug.	KH Minor heat shield modification may be required.	SQ3 Square Tube Class III
CG T-One incorporates circuit protected taillight converter.	KL Hitch is designed to attach beneath the OEM hitch.	SQ4 Square Tube Class IV
CH T-One is equipped with circuit protected ModuLite® module.	LT Requires removal of factory hitch if equipped.	SQ5 Square Tube Class V
CP Fits all models without factory installed receiver.	0 Uses all existing holes. No drilling required.	
DU Fascia removal required.	SB Will not fit models with short bed.	
EF Fits all models with standard bumpers.	SG Hitches produced before 09/10/07 are rated at 1000/10000 WC & 1200/12000 WD.	
EP Fascia trimming may be required.	SO With this hitch installed the step bumper is no longer able to be used as a towing point.	
GH Will not fit models with 34 in. wide frames.	TA Trunk access required for hitch installation.	
GP Hitch cross-tube concealed behind bumper.	TO Will not fit models equipped Chassis Cab spring mount.	
	TZ Requires replacement of the impact structure with hitch.	

# RECEIVER HITCH AND T-CONNECTOR APPLICATION GUIDE

RECEIVER HITCHES

MODEL / STYLE	YEAR	TRAILER HITCHES							T-CONNECTOR		
		REC TYPE	REC SIZE	PART NO.	NO DRILL	FOOTNOTES	WC (LBS.)	WD (LBS.)	IN	T-CON PART NO.	FN
<b>RAM (Continued)</b>											
2500 Except Mega Cab	15-20	SQ5	2-1/2	45288†		†,KL,SB	1,200/12,000	1,700/14,000	35		
		SQ5	2-1/2	45718		#,KL,SB	1,200/12,000	1,700/14,000	35		
3500	11-12	SQ5	2	96929		GP,KL,SG	1,200/12,000	1,500/15,000	35		
		SQ5	2	45709		AA,GH,HM,LT,SO,TO	2,000/18,000	2,500/18,000	95		
		SQ5	2-1/2	45299†		†,AA,GH,HM,LT,SO,TO	2,000/18,000	2,500/18,000	95		
3500 Cab & Chassis, w/34" Wide Frames	11-12	SQ5	2	96936			1,200/12,000		30		
		SQ5	2	96947			1,600/15,000	1,600/16,000	35		
3500 Except Mega Cab	11-12	SQ5	2-1/2	45288†		†,KL,SB	1,200/12,000	1,700/14,000	35		
		SQ5	2-1/2	45718		#,KL,SB	1,200/12,000	1,700/14,000	35		
3500	13-14	SQ5	2	96929		GP,KL,SG	1,200/12,000	1,500/15,000	35		
		SQ5	2	45709		AA,GH,HM,LT,SO,TO	2,000/18,000	2,500/18,000	95		
		SQ5	2-1/2	45299†		†,AA,GH,HM,LT,SO,TO	2,000/18,000	2,500/18,000	95		
3500 Except Mega Cab	13-14	SQ5	2-1/2	45288†		†,KL,SB	1,200/12,000	1,700/14,000	35		
		SQ5	2-1/2	45718		#,KL,SB	1,200/12,000	1,700/14,000	35		
3500	15-21	SQ5	2	96929		GP,KL,SG	1,200/12,000	1,500/15,000	35		
		SQ5	2	45709		AA,GH,HM,LT,SO,TO	2,000/18,000	2,500/18,000	95		
		SQ5	2-1/2	45299†		†,AA,GH,HM,LT,SO,TO	2,000/18,000	2,500/18,000	95		
3500 Except Mega Cab	15-20	SQ5	2-1/2	45288†		†,KL,SB	1,200/12,000	1,700/14,000	35		
		SQ5	2-1/2	45718		#,KL,SB	1,200/12,000	1,700/14,000	35		
4500 Cab & Chassis, w/34" Wide Frames	11-12	SQ5	2	96936			1,200/12,000		30		
		SQ5	2	96947			1,600/15,000	1,600/16,000	35		
4500 Cab & Chassis, w/34" Wide Frames	13-18	SQ5	2	96952			1,500/15,000	1,600/16,000	45		
5500 Cab & Chassis, w/34" Wide Frames	11-12	SQ5	2	96936			1,200/12,000		30		
		SQ5	2	96947			1,600/15,000	1,600/16,000	35		
5500 Cab & Chassis, w/34" Wide Frames	13-18	SQ5	2	96952			1,500/15,000	1,600/16,000	45		
C/V Tradesman	12-15	SQ2	1-1/4	06550	0	GP,JR	300/3,500		20	85777	BN,CH
		SQ2	1-1/4	51192	0	GP,JR	300/3,500		20		
		SQ3	2	44586	0	GP,JR	400/4,000	500/5,000	20		
		SQ3	2	51203	0	GP,JR	400/4,000	400/4,000	20		
Dakota	11	SQ3	2	33092		HM	500/5,000	800/8,000	20	74187	BN,HJ
		SQ3	2	51138		HM	500/5,000	800/8,000	20		
ProMaster 1500 All Models	14-20	SQ3	2	51236†	0	†,AA,DU,GP	500/5,000		45	85858	CH
		SQ3	2	97236	0	AA,DU,GP	500/5,000		45		
ProMaster 1500 All Models	14-21	SQ3	2	84050	0	AA,DU,GP	500/5,000		45	85858	CH
ProMaster 1500 Except w/Extended Body	14-20	RT4	2	44706		HM	750/6,000	750/7,500	45	85858	CH
ProMaster 2500 All Models	14-20	SQ3	2	51236†	0	†,AA,DU,GP	500/5,000		45	85858	CH
		SQ3	2	97236	0	AA,DU,GP	500/5,000		45		
ProMaster 2500 All Models	14-21	SQ3	2	84050	0	AA,DU,GP	500/5,000		45	85858	CH
ProMaster 2500 Except w/Extended Body	14-20	RT4	2	44706		HM	750/6,000	750/7,500	45	85858	CH
ProMaster 3500 All Models	14-20	SQ3	2	51236†	0	†,AA,DU,GP	500/5,000		45	85858	CH
		SQ3	2	97236	0	AA,DU,GP	500/5,000		45		
ProMaster 3500 All Models	14-21	SQ3	2	84050	0	AA,DU,GP	500/5,000		45	85858	CH
ProMaster 3500 Except w/Extended Body	14-20	RT4	2	44706		HM	750/6,000	750/7,500	45	85858	CH
ProMaster City	15-20	SQ3	2	44770	0	GP	350/3,500		60	85922	CH,BN
<b>SAAB</b>											
9-3	99-02	SQ2	1-1/4	06135†		JR,GP	300/3,500		30		
9-3 Convertible	03	SQ2	1-1/4	06135†		JR,GP	300/3,500		30		
9-5	99-05	SQ2	1-1/4	06136†	0	TA,HM	300/3,500		30		
<b>SATURN</b>											
Astra Hatchback	08-09	SQ1	1-1/4	77180†	0	†,GP,JR	200/2,000		25		
Aura	07-09	SQ2	1-1/4	06658		GP,JR,RB	300/3,500		45	7470000	BN,HG
Ion Except Redline & w/2.4 Liter Engine	03-07	SQ1	1-1/4	77050		JR,GP	200/2,000		35		

# Titan hitches require use of a 2-1/2" shank Titan ball mount.  
 † Available while supply lasts.  
 AA Requires temporary removal of bumper during installation.  
 BN Exterior mounted plug on some or all models. May require an aftermarket electrical mounting box or bracket. (Sold separately)  
 CH T-One is equipped with circuit protected ModuLite® module.  
 DU Fascia removal required.  
 GH Will not fit models with 34 in. wide frames.  
 GP Hitch crosstube concealed behind bumper.  
 HG T-One incorporates taillight converter.  
 HJ Per Dodge owner's manual: If trailer is equipped with more than standard lighting (1 taillight per side) use of ModuLite® or dealer supplied harness is required.  
 HM Hitch crosstube is visible beneath bumper.  
 JR Exhaust must be temporarily lowered for installation.

KL Hitch is designed to attach beneath the OEM hitch.  
 LT Requires removal of factory hitch if equipped.  
 0 Uses all existing holes. No drilling required.  
 RB Hitch installation can be made easier with a cutter type drill bit.  
 SB Will not fit models with short bed.  
 SG Hitches produced before 09/10/07 are rated at 1000/10000 WC & 1200/12000 WD.  
 SO With this hitch installed the step bumper is no longer able to be used as a towing point.  
 TA Trunk access required for hitch installation.  
 TO Will not fit models equipped Chassis Cab spring mount.

RT4 Round Tube Class IV 2"  
 SQ1 Square Tube Class I  
 SQ2 Square Tube Class II  
 SQ3 Square Tube Class III  
 SQ5 Square Tube Class V

S - SATURN

# RECEIVER HITCH AND T-CONNECTOR APPLICATION GUIDE

MODEL / STYLE	YEAR	TRAILER HITCHES							T-CONNECTOR		
		REC TYPE	REC SIZE	PART NO.	NO DRILL	FOOTNOTES	WC (LBS.)	WD (LBS.)	IN	T-CON PART NO.	FN
<b>SATURN (Continued)</b>											
Ion 3 w/2.4 Liter Engine	05-07	SQ1	1-1/4	51164		HM,JR	200/2,000		25		
		SQ1	1-1/4	77132		HM,JR	200/2,000		25		
Ion Red Line	04-06	SQ1	1-1/4	51164		HM,JR	200/2,000		25		
		SQ1	1-1/4	77132		HM,JR	200/2,000		25		
L100	01-02	SQ1	1-1/4	77113†		†,TA,GP	200/2,000		35		
L200	01-02	SQ1	1-1/4	77113†		†,TA,GP	200/2,000		35		
L300	01-02	SQ1	1-1/4	77113†		†,TA,GP	200/2,000		35		
LS	00	SQ1	1-1/4	77113†		†,TA,GP	200/2,000		35		
LS1	00	SQ1	1-1/4	77113†		†,TA,GP	200/2,000		35		
LS2	00	SQ1	1-1/4	77113†		†,TA,GP	200/2,000		35		
LW200 Wagon	03	SQ1	1-1/4	77113†		†,TA,GP	200/2,000		35		
LW300 Wagon	03	SQ1	1-1/4	77113†		†,TA,GP	200/2,000		35		
Outlook	07-09	RT3	2	51083	0	RT,GP,JR	500/5,000	500/5,000	25	74711	BN
		RT3	2	44569	0	GP,JR,TN	750/5,000	750/7,500	25		
Relay	05-07	SQ2	1-1/4	51102		AL,GP,JR	300/3,500		40	85344	BN
		SQ3	2	44574		AL,JR	350/3,500	500/5,000	40		
		SQ3	2	51079		AL,GP,JR	350/3,500	500/5,000	40		
SC1 2 Dr. Coupe	96-02	SQ1	1-1/4	77014		HM,JR,KH,TA	200/2,000		40		
SC2 2 Dr. Coupe	96-02	SQ1	1-1/4	77014		HM,JR,KH,TA	200/2,000		40		
Sky	07-09	SQ1	1-1/4	77206	0	HM,JR	200/2,000		35		
SL 4 Dr. Sedan	91-02	SQ1	1-1/4	77014		HM,JR,KH,TA	200/2,000		40		
SL1 4 Dr. Sedan	91-02	SQ1	1-1/4	77014		HM,JR,KH,TA	200/2,000		40		
SL2 4 Dr. Sedan	91-02	SQ1	1-1/4	77014		HM,JR,KH,TA	200/2,000		40		
SW1 Wagon	93-99	SQ1	1-1/4	77014		HM,JR,KH,TA	200/2,000		40		
SW2 Wagon	93-01	SQ1	1-1/4	77014		HM,JR,KH,TA	200/2,000		40		
Vue Except Redline	02-07	SQ2	1-1/4	06391	0	HM	300/3,500		25	74695	BN,CG
		SQ2	1-1/4	51185	0	HM	300/3,500		25		
		SQ3	2	51193	0	HM	350/3,500	400/4,000	30		
		SQ3	2	84028	0	HM	675/4,500	675/4,500	30		
Vue	08-09	SQ2	1-1/4	06528	0	GP	300/3,500		15	74720	CH
		SQ3	2	44580	0	GP	400/4,000	400/4,000	15		
<b>SCION</b>											
FR-S	13-16	SQ1	1-1/4	77322	0		200/2,000		75	85861	CH
iA	16	SQ1	1-1/4	77335	0	HM	200/2,000		30	85939	CH,BN
iM	16	SQ1	1-1/4	77952	0	GP,JR,SV	200/2,000		40	85940	BN,CH
tC	05-06	SQ1	1-1/4	77199		GP	200/2,000		30		
tC	07-10	SQ1	1-1/4	77199		GP	200/2,000		30	85702	CG
tC Except Release Series	11-13	SQ1	1-1/4	77187	0	GP	200/2,000		15		
tC Except Dual Exhaust	14-16	SQ1	1-1/4	77308	0	GP	200/2,000		15	85839	CH
xB Except Release Series	08-10	SQ1	1-1/4	77187	0	GP	200/2,000		15	78100	CH
xB Except Release Series	11-13	SQ1	1-1/4	77187	0	GP	200/2,000		15	78010	CH
xD	08-10	SQ1	1-1/4	77200	0	GP,JR	200/2,000		20		
<b>STERLING TRUCK</b>											
Bullet 45 w/34" Wide Frames	08-09	SQ5	2	96936			1,200/12,000		30		
		SQ5	2	96947			1,600/15,000	1,600/16,000	35		
Bullet 55 w/34" Wide Frames	08-09	SQ5	2	96936			1,200/12,000		30		
		SQ5	2	96947			1,600/15,000	1,600/16,000	35		
<b>SUBARU</b>											
Ascent	19-20	SQ3	2	84253	0	DU,J,TZ	750/5,000		60	89511	CH
Ascent	21	SQ3	2	84253	0	DU,J,TZ	750/5,000		60	89511	CH
B9 Tribeca	06-07	SQ3	2	44535	0	GP,JR	350/3,500	400/4,000	35	78064	CH
Baja	03-06	SQ1	1-1/4	77051†	0	†,HM	200/2,000		20		
BRZ	13-20	SQ1	1-1/4	77322	0		200/2,000		75	85861	CH

† Available while supply lasts.  
**AL** Additional installation time required for vehicles equipped with load leveling compressor.  
**BN** Exterior mounted plug on some or all models. May require an aftermarket electrical mounting box or bracket. (Sold separately)  
**CG** T-One incorporates circuit protected taillight converter.  
**CH** T-One is equipped with circuit protected ModuLite® module.  
**DU** Fascia removal required.  
**GP** Hitch crossbar concealed behind bumper.  
**HM** Hitch crossbar is visible beneath bumper.  
**J** Under vehicle spare tire stowage is retained.  
**JR** Exhaust must be temporarily lowered for installation.  
**KH** Minor heat shield modification may be required.  
**0** Uses all existing holes. No drilling required.

**RT** Round Tube Class III/IV 2"  
**SV** Trimming or removal of under body appearance panel may be required.  
**TA** Trunk access required for hitch installation.  
**TN** Hitches produced before 07/09/12 are rated at 500/5000 WC & 500/5000 WD.  
**TZ** Requires replacement of the impact structure with hitch.

**RT3** Round Tube Class III 2"  
**SQ1** Square Tube Class I  
**SQ2** Square Tube Class II  
**SQ3** Square Tube Class III  
**SQ5** Square Tube Class V

# RECEIVER HITCH AND T-CONNECTOR APPLICATION GUIDE

RECEIVER HITCHES

MODEL / STYLE	YEAR	TRAILER HITCHES							T-CONNECTOR		
		REC TYPE	REC SIZE	PART NO.	NO DRILL	FOOTNOTES	WC (LBS.)	WD (LBS.)	IN	T-CON PART NO.	FN
<b>SUBARU (Continued)</b>											
Crosstrek Except Hybrid	16-17	SQ3	2	84084	0	HM,JR,KH	525/3,500		20	78092	CH
Crosstrek Hybrid	16-17	SQ3	2	84084	0	HM,JR,KH	525/3,500		20		
Crosstrek Except Hybrid	18-21	RT2	1-1/4	06813	0	JR,HM	300/3,500		60	78092	CH
		SQ3	2	84209	0	JR,HM	675/4,500		60		
Crosstrek Hybrid	18-21	RT2	1-1/4	06813	0	JR,HM	300/3,500		60		
		SQ3	2	84209	0	JR,HM	675/4,500		60		
Forester	98-08	SQ2	1-1/4	51174	0	GP,JR	300/3,500		30	78064	CH
Forester	09-13	SQ1	1-1/4	77178		HM,JR	200/2,000		35	78092	CH
		RT2	1-1/4	06150		HM,JR	300/3,500		35		
		SQ3	2	44607		HM,JR,TQ	600/4,000		35		
Forester	14-18	SQ2	1-1/4	06155		HM,JR,KH	300/3,500		30	78092	CH
		SQ3	2	44705	0	HM,JR,KH	525/3,500	525/4,000	25		
		SQ3	2	84182	0	DU,FE,GP,JR	525/3,500		60		
Forester	19-21	SQ2	1-1/4	06191	0		350/3,500		30	78092	CH
		RT3	2	84271	0	JR,KH	525/3,500	525/3,500	30		
Impreza	93-01	SQ1	1-1/4	77091	0	JR,GP	200/2,000		30		
Impreza Except WRX STi	02-07	SQ1	1-1/4	77091	0	JR,GP	200/2,000		30		
Impreza 4 Dr. Sedan	08-11	SQ1	1-1/4	77178		HM,JR	200/2,000		35	78098	CH
Impreza 5 Dr. Wagon, Except WRX STi & w/Quad Exhaust Outlets	08-11	RT1	1-1/4	77959		HM,JR	200/2,000		45		
Impreza 4 Dr. Sedan, Except WRX & WRX STi	12-16	SQ1	1-1/4	77276†		†,HM,JR	200/2,000		30	85813	CH
		SQ1	1-1/4	77960	0	HM,JR,KH	200/2,000		40		
Impreza 5 Dr. Wagon, Except WRX STi & w/Quad Exhaust Outlets	12-16	RT1	1-1/4	77959		HM,JR	200/2,000		20	85800	CH
Impreza 4 Dr. Sedan, Except WRX & WRX STi	17-20	SQ1	1-1/4	77960	0	HM,JR,KH	200/2,000		40	85861	CH
Impreza 5 Dr. Wagon, Except WRX STi & w/Quad Exhaust Outlets	17-20	RT1	1-1/4	77959		HM,JR	200/2,000		20	85957	CH,BN
Impreza 5 Dr. Wagon, Except WRX STi & w/Quad Exhaust Outlets	18-20	RT2	1-1/4	06813		HM,JR	300/3,500		60	85957	CH,BN
		SQ3	2	84209		HM,JR	675/4,500		60		
Legacy Coupe & Sedan	90-99	SQ2	1-1/4	06020†		KH,HM	300/3,500		25		
Legacy Wagon, Except Outback	96-99	SQ2	1-1/4	06020†		KH,HM	300/3,500		20		
Legacy Wagon, Outback	96-99	SQ2	1-1/4	06020†		KH,HM	300/3,500		20	78064	CH
Legacy Sedan, Except Outback	00-04	SQ2	1-1/4	06287	0	HM	300/3,500		20		
Legacy Wagon, Except Outback	00-04	SQ2	1-1/4	06287	0	HM	300/3,500		20		
Legacy Sedan, Except Outback	05-07	SQ2	1-1/4	06377	0	JR,HM	300/3,500		25		
		SQ3	2	44581	0	JR	400/4,000		25		
Legacy Wagon, Except Outback	05-07	SQ2	1-1/4	06377	0	JR,HM	300/3,500		25	78064	CH
		SQ3	2	44581	0	JR	400/4,000		25		
Legacy Sedan	08-09	SQ2	1-1/4	06377	0	JR,HM	300/3,500		25		
		SQ3	2	44581	0	JR	400/4,000		25		
Legacy Sedan	10-14	SQ2	1-1/4	06669		HM,JR,KH	300/3,500		45	85734	CH
		SQ3	2	51204		HM,JR,KH	400/4,000		45		
		SQ3	2	44631		HM,JR,KH,TI	600/4,000		45		
Legacy Sedan	15-19	SQ2	1-1/4	06669		HM,JR,KH	300/3,500		45	85884	CH
		SQ3	2	51204		HM,JR,KH	400/4,000		45		
		SQ3	2	44631		HM,JR,KH,TI	600/4,000		45		
Legacy Sedan	20	RT3	2	84332	0	HM,JR,KH	675/4,500		40		
Outback Sedan, Except Sport	00-04	SQ2	1-1/4	06287	0	HM	300/3,500		20		
Outback Wagon, Except Sport	00-04	SQ2	1-1/4	06287	0	HM	300/3,500		20	78064	CH
Outback Sedan, Except Sport	05-07	SQ2	1-1/4	06377	0	JR,HM	300/3,500		25		
		SQ3	2	44581	0	JR	400/4,000		25		
Outback Wagon, Except Sport	05-09	SQ2	1-1/4	06377	0	JR,HM	300/3,500		25	78064	CH
		SQ3	2	44581	0	JR	400/4,000		25		

- † Available while supply lasts.
- BN Exterior mounted plug on some or all models. May require an aftermarket electrical mounting box or bracket. (Sold separately)
- CH T-One is equipped with circuit protected ModuLite® module.
- DU Fascia removal required.
- FE Fascia trimming may be required. Allow additional installation time.
- GP Hitch crosstube concealed behind bumper.
- HM Hitch crosstube is visible beneath bumper.
- JR Exhaust must be temporarily lowered for installation.
- KH Minor heat shield modification may be required.
- 0 Uses all existing holes. No drilling required.
- TI Hitches produced before 06/06/11 are rated at 400/4000 WC.
- TQ Hitches produced before 07/30/12 are rated at 350/3500 WC.

- RT1 Round Tube Class I 1-1/4"
- RT2 Round Tube Class II 1-1/4"
- RT3 Round Tube Class III 2"
- SQ1 Square Tube Class I
- SQ2 Square Tube Class II
- SQ3 Square Tube Class III

S - SUBARU

# RECEIVER HITCH AND T-CONNECTOR APPLICATION GUIDE

MODEL / STYLE	YEAR	TRAILER HITCHES							T-CONNECTOR		
		REC TYPE	REC SIZE	PART NO.	NO DRILL	FOOTNOTES	WC (LBS.)	WD (LBS.)	IN	T-CON PART NO.	FN
<b>SUBARU (Continued)</b>											
Outback Wagon, Except Sport	10-19	SQ2	1-1/4	06669		HM, JR, KH	300/3,500		45	78092	CH
		SQ3	2	51204		HM, JR, KH	400/4,000		45		
		SQ3	2	44631		HM, JR, KH, TI	600/4,000		45		
		SQ3	2	84227		AA, AI, DU, FE, X	600/4,000		45		
Outback Wagon	20	SQ3	2	84333	0	HM, JR, KH	525/3,500		40	78092	CH
		RT3	2	84332	0	HM, JR, KH	675/4,500		40		
Tribeca	08-10	SQ3	2	44535	0	GP, JR	350/3,500	400/4,000	35	78064	CH
Tribeca	11-14	SQ3	2	44665	0	GP	525/3,500	525/5,250	30	78064	CH
WRX STI	15-20	SQ1	1-1/4	77968	0	JR, KH	200/2,000		60		
XV Crosstrek Except Hybrid	13-15	RT1	1-1/4	77959		HM, JR	200/2,000		30	78092	CH
		SQ3	2	84084	0	HM, JR, KH, SY	525/3,500		20		
XV Crosstrek Hybrid	13-15	RT1	1-1/4	77959		HM, JR	200/2,000		30	78092	CH
<b>SUZUKI</b>											
Equator	09-12	SQ3	2	51147	0	GP	500/5,000	800/8,000	30	85757	BN
		SQ3	2	44526	0	GP, TE	750/5,000	800/8,000	30		
Grand Vitara	99-05	SQ2		88001†		†	350/3,500		35	74896	HG
		SQ1	1-1/4	77023	0	HM	200/2,000		15		
		SQ3	2	33038	0	HM	350/3,500		15		
		SQ3	2	51152	0	HM	350/3,500		15		
Grand Vitara Except 3 Dr Hatchback	06-13	SQ3	2	44543	0	EP	350/3,500	400/4,000	20	78018	CG
Swift+ 5 Dr. (Canada Only)	04-09	SQ1	1-1/4	77097		GP	200/2,000		30		
SX4 Crossover	07-11	SQ1	1-1/4	77189		HM, JR	200/2,000		40	78018	CG
Vitara	99-04	SQ2		88001†		†	350/3,500		35	74896	HG
		SQ1	1-1/4	77023	0	HM	200/2,000		15		
		SQ3	2	33038	0	HM	350/3,500		15		
		SQ3	2	51152	0	HM	350/3,500		15		
XL-7	02-06	SQ2		88001†		†	350/3,500		35	74896	HG
		SQ1	1-1/4	77023	0	HM	200/2,000		15		
		SQ3	2	33038	0	HM	350/3,500		15		
		SQ3	2	51152	0	HM	350/3,500		15		
XL-7	07-09	SQ3	2	44570	0	HM	400/4,000	400/4,000	30		
<b>TESLA</b>											
S	12-20	SQ1	1-1/4	77958	0	GP, AA, EP, DU, SV, TA	200/2,000		150		
X	16-20	SQ3	2	84143	0	GP, DU, SV, TZ, X	500/5,000		75		
<b>TOYOTA</b>											
4Runner	03-06	RT4	2	44548	0	FE, LT, SI	600/6,000	730/7,300	35		
4Runner	07-09	RT4	2	44548	0	FE, LT, SI	600/6,000	730/7,300	35		
86	17-20	SQ1	1-1/4	77322	0		200/2,000		75		
Avalon	95-99	SQ2	1-1/4	06326		HM	300/3,500		15		
		SQ2	1-1/4	51178		HM	300/3,500		15		
Avalon	00-04	SQ2	1-1/4	06025		GP	300/3,500		20		
Avalon	05-10	SQ1	1-1/4	77253	0	HM, JR	200/2,000		40		
Avalon	11-12	SQ1	1-1/4	77253	0	HM, JR	200/2,000		40	78109	CH
Avalon	13-18	SQ2	1-1/4	06160		HM, JR, KH, SV	300/3,500		40	85814	CH
Avalon	19	SQ2	1-1/4	06187		HM, JR, KH, SV	300/3,500		40	89515	CH
Avalon	20-21	SQ2	1-1/4	06187		HM, JR, KH, SV	300/3,500		40		CH
Camry 4 Dr. Sedan	97-01	SQ1	1-1/4	77035	0	HM, JR	200/2,000		15	74205	HG
		SQ2	1-1/4	06326		HM	300/3,500		15		
		SQ2	1-1/4	51178		HM	300/3,500		15		
Camry 4 Dr. Sedan	02-04	SQ1	1-1/4	77035	0	HM, JR	200/2,000		15	85318	
		SQ2	1-1/4	06326		HM	300/3,500		15		
		SQ2	1-1/4	51178		HM	300/3,500		15		

† Available while supply lasts.  
 AA Requires temporary removal of bumper during installation.  
 AI Additional installation time may be required.  
 BN Exterior mounted plug on some or all models. May require an aftermarket electrical mounting box or bracket. (Sold separately)  
 CG T-One incorporates circuit protected taillight converter.  
 CH T-One is equipped with circuit protected ModuLite® module.  
 DU Fascia removal required.  
 EP Fascia trimming may be required.  
 FE Fascia trimming may be required. Allow additional installation time.  
 GP Hitch crosstube concealed behind bumper.  
 HG T-One incorporates taillight converter.  
 HM Hitch crosstube is visible beneath bumper.

JR Exhaust must be temporarily lowered for installation.  
 KH Minor heat shield modification may be required.  
 LT Requires removal of factory hitch if equipped.  
 0 Uses all existing holes. No drilling required.  
 SI Hitches produced before 07/31/07 are rated at 350/3500 WC & 500/5000 WD.  
 SV Trimming or removal of under body appearance panel may be required.  
 SY Hitch crosstube is visible beneath bumper with a more than normal gap between fascia and crosstube.  
 TA Trunk access required for hitch installation.  
 TE Hitches produced before 04/20/11 are rated at 500/5000 WC.  
 TI Hitches produced before 06/06/11 are rated at 400/4000 WC.  
 TZ Requires replacement of the impact structure with hitch.  
 X Minor fascia trimming required.

RT1 Round Tube Class I 1-1/4"  
 RT3 Round Tube Class III 2"  
 RT4 Round Tube Class IV 2"  
 SQ1 Square Tube Class I  
 SQ2 Square Tube Class II  
 SQ3 Square Tube Class III



# RECEIVER HITCH AND T-CONNECTOR APPLICATION GUIDE

RECEIVER HITCHES

MODEL / STYLE	YEAR	TRAILER HITCHES							T-CONNECTOR		
		REC TYPE	REC SIZE	PART NO.	NO DRILL	FOOTNOTES	WC (LBS.)	WD (LBS.)	IN	T-CON PART NO.	FN
<b>TOYOTA (Continued)</b>											
Camry 4 Dr. Sedan	05-06	SQ2	1-1/4	06326		HM	300/3,500		15	85318	
		SQ2	1-1/4	51178		HM	300/3,500		15		
Camry 4 Dr. Sedan, Except Hybrid	07-09	SQ2	1-1/4	06397		GP,JR,TA	300/3,500		45	85701	CH
		SQ2	1-1/4	51190		GP,JR,TA	300/3,500		45		
Camry 4 Dr. Sedan, Except Hybrid	10-11	SQ2	1-1/4	06397		GP,JR,TA	300/3,500		45	78109	CH
		SQ2	1-1/4	51190		GP,JR,TA	300/3,500		45		
Camry Except Hybrid	12-17	SQ2	1-1/4	06160		HM,JR,KH,SV	300/3,500		40	85701	CH
Camry Except Hybrid	18-19	SQ2	1-1/4	06160		HM,JR,KH,SV	300/3,500		40	85976	CH
Camry Including Hybrid	18-20	SQ2	1-1/4	06187		HM,JR,KH,SV	300/3,500		40	85976	CH
Camry Hybrid 4 Dr. Sedan	07-11	SQ2	1-1/4	06397		GP,JR,TA	300/3,500		45	78109	CH
		SQ2	1-1/4	51190		GP,JR,TA	300/3,500		45		
C-HR	18-20	SQ1	1-1/4	77962†	0	†,DU,GP,SV	200/2,000		60	85969	CH,BN
Corolla Sedan	93-02	SQ1	1-1/4	77005		GP	200/2,000		30		
Corolla	03	SQ1	1-1/4	51171	0	HM	200/2,000		20	78024	CG
		RT1	1-1/4	77300	0	HM	200/2,000		20		
Corolla	04-07	SQ1	1-1/4	51171	0	HM	200/2,000		20		
		RT1	1-1/4	77300	0	HM	200/2,000		20		
Corolla	08	SQ1	1-1/4	51171	0	HM	200/2,000		20		
		RT1	1-1/4	77300	0	HM	200/2,000		20		
Corolla	09-13	SQ1	1-1/4	51171	0	HM	200/2,000		20	78020	CH
		RT1	1-1/4	77300	0	HM	200/2,000		20		
Corolla Except Hatchback	14-19	RT1	1-1/4	77300	0	HM	200/2,000		20	85701	CH
Corolla Hatchback	19-20	SQ1	1-1/4	77991	0	JR,X	200/2,000		30		
Corolla Sedan	20	SQ1	1-1/4	77983	0		200/2,000		40	89531	CH
Corolla iM	17-18	SQ1	1-1/4	77952	0	GP,JR,SV	200/2,000		40	85940	BN,CH
Echo Except Hatchback	00-02	SQ1	1-1/4	77323†	0	X,GP	200/2,000		15	78023	CG
Echo Except Hatchback	03-05	SQ1	1-1/4	77323†	0	X,GP	200/2,000		15		
FJ Cruiser	07-14	SQ3	2	44545	0	GP	500/5,000	600/6,000	30	85701	CH
		SQ3	2	51087	0	GP	500/5,000	600/6,000	30		
Highlander	01-03	SQ2	1-1/4	06276	0	HM	300/3,500		15	74690	HG
		SQ3	2	51153	0	HM	300/3,500		15		
		SQ3	2	44076	0		350/3,500		15		
Highlander	04-07	RT3	2	33075	0	HM	350/3,500		20	78062	CH
		RT3	2	51155	0	RT,HM	350/3,500		20		
Highlander	08-13	RT3	2	44670	0	HM,SV	750/5,000	750/5,000	40	78067	CH
Highlander Except w/Full Size 19" Spare Tire	08-13	SQ3	2	44587	0	HM	500/5,000	500/5,000	25	78067	CH
		SQ3	2	51158	0	HM	500/5,000	500/5,000	25		
Highlander	14-19	SQ3	2	84156	0	GP,SV	500/5,000		45	78067	CH
		SQ3	2	84336	0	†,EP,JR,X	500/5,000		45		
		RT4	2	44710	0	HM,SV	900/6,000	900/8,000	30		
Highlander	20	SQ3	2	84336	0	†,EP,JR,X	500/5,000		45	118827	CH
Hilux	08-12	SQ4	2	44669	0	AA,GP	900/6,000	900/9,000	60	85718	HG
Hilux	13-14	SQ4	2	44669	0	AA,GP	900/6,000	900/9,000	60		
Hilux	16-20	SQ4	2	84791	0	HM	800/8,000	800/8,000	45		
Hilux SW4	14	SQ3	2	84914	0	HM	525/3,500		15		
Land Cruiser	98-99	SQ3	2	44546	0	GP	500/5,000	750/6,000	20	74225	BN,HG
Land Cruiser	00	SQ3	2	44546	0	GP	500/5,000	750/6,000	20		
Land Cruiser	01-02	SQ3	2	44546	0	GP	500/5,000	750/6,000	20		
Land Cruiser	03-07	SQ3	2	44546	0	GP	500/5,000	750/6,000	20		
Matrix	03-08	SQ1	1-1/4	51169	0	HM,UD	200/2,000		15	78023	CG
		SQ1	1-1/4	77183	0	HM,UD	200/2,000		15		
Matrix	09-13	SQ1	1-1/4	51169	0	HM	200/2,000		15	78010	CH
		SQ1	1-1/4	77183	0	HM	200/2,000		15		

- † Available while supply lasts.
- AA Requires temporary removal of bumper during installation.
- BN Exterior mounted plug on some or all models. May require an aftermarket electrical mounting box or bracket. (Sold separately)
- CG T-One incorporates circuit protected taillight converter.
- CH T-One is equipped with circuit protected ModuLite® module.
- DU Fascia removal required.
- EP Fascia trimming may be required.
- GP Hitch crosstube concealed behind bumper.
- HG T-One incorporates taillight converter.
- HM Hitch crosstube is visible beneath bumper.
- JR Exhaust must be temporarily lowered for installation.
- KH Minor heat shield modification may be required.

- 0 Uses all existing holes. No drilling required.
- RT Round Tube Class III/IV 2"
- SV Trimming or removal of under body appearance panel may be required.
- TA Trunk access required for hitch installation.
- UD Fascia removal required on XR & XRS models.
- X Minor fascia trimming required.

- RT1 Round Tube Class I 1-1/4"
- RT3 Round Tube Class III 2"
- RT4 Round Tube Class IV 2"
- SQ1 Square Tube Class I
- SQ2 Square Tube Class II
- SQ3 Square Tube Class III
- SQ4 Square Tube Class IV

T - TOYOTA

# RECEIVER HITCH AND T-CONNECTOR APPLICATION GUIDE

MODEL / STYLE	YEAR	TRAILER HITCHES							T-CONNECTOR		
		REC TYPE	REC SIZE	PART NO.	NO DRILL	FOOTNOTES	WC (LBS.)	WD (LBS.)	IN	T-CON PART NO.	FN
<b>TOYOTA (Continued)</b>											
<b>Matrix (Canada Only)</b>	<b>14</b>	SQ1	1-1/4	<b>51169</b>	0	HM	200/2,000		15		
		SQ1	1-1/4	<b>77183</b>	0	HM	200/2,000		15		
<b>Prius</b>	<b>04-09</b>	SQ1	1-1/4	<b>77179</b>	0	HM,SC	200/2,000		30	<b>85725</b>	CH
<b>Prius Except w/Plug-In Model</b>	<b>10-19</b>	SQ1	1-1/4	<b>77236</b>	0	HM,JR	200/2,000		25	<b>85725</b>	CH
<b>Prius Except w/Plug-In Model</b>	<b>10-20</b>	SQ1	1-1/4	<b>77967</b>	0	GP,SV	200/2,000		40	<b>85725</b>	CH
<b>Prius Except Prius Prime</b>	<b>16-20</b>	SQ1	1-1/4	<b>77966</b>	0	DU,GP,SV	200/2,000		45	<b>85933</b>	CH
<b>Prius Except w/Plug-In Model</b>	<b>20</b>	SQ1	1-1/4	<b>77236</b>	0	HM,JR	200/2,000		25	<b>85725</b>	CH
<b>Prius C</b>	<b>12-20</b>	SQ1	1-1/4	<b>77277</b>	0	GP	200/2,000		20	<b>85896</b>	CH
		SQ1	1-1/4	<b>77971</b>	0	GP	200/2,000		20		
<b>Prius Plug-In</b>	<b>12-15</b>	SQ1	1-1/4	<b>77967</b>	0	GP,SV	200/2,000		40	<b>85725</b>	CH
<b>Prius Prime</b>	<b>17-20</b>	SQ1	1-1/4	<b>77966</b>	0	DU,GP,SV	200/2,000		45		
<b>Prius V</b>	<b>12-20</b>	SQ1	1-1/4	<b>77236</b>	0	HM,JR	200/2,000		25	<b>85853</b>	CH
		SQ1	1-1/4	<b>77967</b>	0	HM,JR	200/2,000		25		
<b>RAV4</b>	<b>96-00</b>	SQ1	1-1/4	<b>77107</b>	0	HM	200/2,000		15	<b>78025</b>	CG
		SQ3	2	<b>33060</b>	0	RA	350/3,500		20		
<b>RAV4</b>	<b>01-05</b>	SQ1	1-1/4	<b>77107</b>	0	HM	200/2,000		15	<b>78026</b>	CG
		SQ3	2	<b>33060</b>	0		350/3,500		20		
<b>RAV4</b>	<b>06-12</b>	RT2	1-1/4	<b>06172</b>	0	HM,JR,SV	300/3,500		20	<b>78048</b>	CH
		SQ3	2	<b>97234</b>	0	HM,HX,JR	350/3,500	400/4,000	35		
		RT3	2	<b>44785</b>	0	HM,JR,SV	675/4,500	675/4,500	20		
<b>RAV4</b>	<b>13-15</b>	RT2	1-1/4	<b>06172</b>	0	HM,JR,SV	300/3,500		20	<b>85814</b>	CH
		SQ3	2	<b>84134</b>	0	JR,GP,TA,HX,DU,SV	350/3,500		20		
		RT3	2	<b>44785</b>	0	HM,JR,SV	675/4,500	675/4,500	20		
<b>RAV4</b>	<b>13-18</b>	SQ3	2	<b>97234</b>	0	HM,HX,JR	350/3,500	400/4,000	35	<b>85814</b>	CH
<b>RAV4</b>	<b>16-18</b>	RT2	1-1/4	<b>06172</b>	0	HM,JR,SV,TW	300/3,500		20	<b>85814</b>	CH
		SQ3	2	<b>84134</b>	0	JR,GP,TA,HX,SV,TW	350/3,500		45		
		RT3	2	<b>44785</b>	0	HM,JR,SV,TW	675/4,500	675/4,500	20		
<b>RAV4</b>	<b>19-21</b>	SQ2	1-1/4	<b>06192</b>	0	CH,BN	350/3,500		35	<b>89521</b>	
		SQ3	2	<b>84201</b>	0	CH,BN	675/4,500	675/4,500	35		
<b>Sequoia Except Models w/OEM Hitch</b>	<b>01-02</b>	SQ3	2	<b>44089</b>	0	CP	500/5,000	650/6,500	25		
<b>Sequoia Except Models w/OEM Hitch</b>	<b>03-07</b>	SQ3	2	<b>44089</b>	0	CP	500/5,000	650/6,500	25		
<b>Sequoia</b>	<b>08-10</b>	SQ4	2	<b>44602†</b>	0	AI	600/6,000	1,000/10,000	40	<b>78048</b>	CH
<b>Sequoia</b>	<b>11-20</b>	SQ4	2	<b>44602†</b>	0	AI	600/6,000	1,000/10,000	40		
<b>Sienna</b>	<b>98-00</b>	SQ3	2	<b>33008</b>	0	†,GP	350/3,500	500/5,000	30		
<b>Sienna</b>	<b>98-03</b>	SQ2	1-1/4	<b>06077</b>	0	GP	300/3,500		15		
<b>Sienna</b>	<b>01-03</b>	SQ3	2	<b>33008</b>	0	†,GP	350/3,500	500/5,000	30		
<b>Sienna</b>	<b>04-10</b>	RT2	1-1/4	<b>06137</b>	0	HM,JR	300/3,500		20	<b>78004</b>	
		RT3	2	<b>51080</b>	0	RT,HM,JR	350/3,500	500/5,000	30		
		RT3	2	<b>44786</b>	0	HM,SV,JR,SY	675/4,500	675/5,000	30		
<b>Sienna</b>	<b>11-14</b>	RT2	1-1/4	<b>06137</b>	0	HM,JR,SV,SY	300/3,500		20	<b>85720</b>	CH
		RT3	2	<b>51080</b>	0	RT,HM,JR,SV,SY	350/3,500	500/5,000	30		
		SQ3	2	<b>84112</b>	0	SV,JR,GP,TA,DU	525/3,500	525/3,500	60		
		RT3	2	<b>44786</b>	0	HM,SV,JR,SY	675/4,500	675/5,000	30		
<b>Sienna Except SE</b>	<b>15-20</b>	RT2	1-1/4	<b>06137</b>	0	HM,JR,SV,SY	300/3,500		20	<b>85866</b>	CH
		RT3	2	<b>51080</b>	0	RT,HM,JR,SV,SY	350/3,500	500/5,000	30		
		SQ3	2	<b>84112</b>	0	SV,JR,GP,TA,DU	525/3,500	525/3,500	60		
		RT3	2	<b>44786</b>	0	HM,SV,JR,SY	675/4,500	675/5,000	30		
<b>Sienna SE</b>	<b>15-20</b>	RT2	1-1/4	<b>06137</b>	0	HM,JR,SV,SY	300/3,500		20	<b>85720</b>	CH
		RT3	2	<b>51080</b>	0	RT,HM,JR,SV,SY	350/3,500	500/5,000	30		
		SQ3	2	<b>84112</b>	0	SV,JR,GP,TA,DU	525/3,500	525/3,500	60		
		RT3	2	<b>44786</b>	0	HM,SV,JR,SY	675/4,500	675/5,000	30		

† Available while supply lasts.	0 Uses all existing holes. No drilling required.	<b>RT2</b> Round Tube Class II 1-1/4"
AI Additional installation time may be required.	RA Do not install on early 1996 models equipped with M10 fasteners.	<b>RT3</b> Round Tube Class III 2"
BN Exterior mounted plug on some or all models. May require an aftermarket electrical mounting box or bracket. (Sold separately)	RT Round Tube Class III/IV 2"	<b>SQ1</b> Square Tube Class I
CG T-One incorporates circuit protected taillight converter.	SC Minor trimming of plastic trunk pan required.	<b>SQ2</b> Square Tube Class II
CH T-One is equipped with circuit protected ModuLite® module.	SV Trimming or removal of under body appearance panel may be required.	<b>SQ3</b> Square Tube Class III
CH T-One is equipped with circuit protected ModuLite® module.	SY Hitch crosstube is visible beneath bumper with a more than normal gap between fascia and crosstube.	<b>SQ4</b> Square Tube Class IV
CP Fits all models without factory installed receiver.	TA Trunk access required for hitch installation.	
DU Fascia removal required.	TW Receiver hitch may limit hands-free liftgate sensor range	
GP Hitch crosstube concealed behind bumper.		
HM Hitch crosstube is visible beneath bumper.		
HX Minor exhaust modification may be required.		
JR Exhaust must be temporarily lowered for installation.		

# RECEIVER HITCH AND T-CONNECTOR APPLICATION GUIDE

RECEIVER HITCHES

MODEL / STYLE	YEAR	TRAILER HITCHES							T-CONNECTOR		
		REC TYPE	REC SIZE	PART NO.	NO DRILL	FOOTNOTES	WC (LBS.)	WD (LBS.)	IN	T-CON PART NO.	FN
<b>TOYOTA (Continued)</b>											
<b>Solara</b>	<b>99-03</b>	SQ1	1-1/4	<b>77035</b>	0	HM,JR	200/2,000		15		
		SQ2	1-1/4	<b>06326</b>		HM	300/3,500		15		
		SQ2	1-1/4	<b>51178</b>		HM	300/3,500		15		
<b>Solara</b>	<b>04-06</b>	SQ2	1-1/4	<b>06387</b>	0	JR,HM	300/3,500		15		
<b>Solara</b>	<b>07-08</b>	SQ2	1-1/4	<b>06387</b>	0	JR,HM	300/3,500		15		
<b>Tacoma (App. starts with 95-1/2)</b>	<b>95-04</b>	SQ3	2	<b>44051</b>	0		500/5,000	550/5,500	40	<b>85250</b>	BN,HG
		SQ3	2	<b>51108</b>	0	GP	500/5,000	550/5,500	40		
<b>Tacoma Except X-Runner</b>	<b>05-08</b>	SQ3	2	<b>44746</b>	0	GP	500/5,000	550/5,500	30	<b>85718</b>	HG
		SQ3	2	<b>51146</b>	0	GP	500/5,000	550/5,500	30		
<b>Tacoma Except X-Runner</b>	<b>09-15</b>	SQ3	2	<b>44746</b>	0	GP	500/5,000	550/5,500	30	<b>85718</b>	HG
		SQ3	2	<b>51146</b>	0	GP	500/5,000	550/5,500	30		
<b>Tacoma</b>	<b>16-20</b>	SQ4	2	<b>84238</b>	0	GP	1,050/7,000	1,200/8,000	20	<b>85926</b>	BN,CH
<b>Tacoma</b>	<b>21</b>	SQ4	2	<b>84238</b>	0	GP	1,050/7,000	1,200/8,000	20	<b>85926</b>	BN,CH
<b>Tundra</b>	<b>00</b>	SQ3	2	<b>33049</b>	0		500/5,000	750/7,500	20	<b>74887</b>	BN,CH
		RT3	2	<b>37069</b>			500/5,000	750/7,500	35		
		SQ3	2	<b>44054</b>	0		500/5,000	750/7,500	20		
		SQ3	2	<b>51047</b>	0	GP	500/5,000	750/7,500	15		
		RT4	2	<b>37034</b>			700/7,000	1,200/12,000	30		
		RT4	2	<b>37094</b>			700/7,000	1,200/12,000	30		
<b>Tundra</b>	<b>01-02</b>	SQ3	2	<b>33049</b>	0		500/5,000	750/7,500	20	<b>85247</b>	BN,CH
		RT3	2	<b>37069</b>			500/5,000	750/7,500	35		
		SQ3	2	<b>44054</b>	0		500/5,000	750/7,500	20		
		SQ3	2	<b>51047</b>	0	GP	500/5,000	750/7,500	15		
		RT4	2	<b>37034</b>			700/7,000	1,200/12,000	30		
		RT4	2	<b>37094</b>			700/7,000	1,200/12,000	30		
<b>Tundra</b>	<b>03-06</b>	SQ3	2	<b>33049</b>	0		500/5,000	750/7,500	20		
		RT3	2	<b>37069</b>			500/5,000	750/7,500	35		
		SQ3	2	<b>44054</b>	0		500/5,000	750/7,500	20		
		SQ3	2	<b>51047</b>	0	GP	500/5,000	750/7,500	15		
		RT4	2	<b>37034</b>			700/7,000	1,200/12,000	30		
		RT4	2	<b>37094</b>			700/7,000	1,200/12,000	30		
<b>Tundra (See Footnote CP)</b>	<b>07-09</b>	RT4	2	<b>44568</b>	0	CP,HM	600/6,000	800/8,000	20		
		RT4	2	<b>51091</b>	0	RT,CP,HM	600/6,000	800/8,000	20		
		SQ5	2	<b>96935</b>	0	CP,HM	1,200/12,000	1,400/14,000	30		
<b>Tundra (See Footnote CP)</b>	<b>10-14</b>	RT4	2	<b>44568</b>	0	CP,HM	600/6,000	800/8,000	20		
		RT4	2	<b>51091</b>	0	RT,CP,HM	600/6,000	800/8,000	20		
		SQ5	2	<b>96935</b>	0	CP,HM	1,200/12,000	1,400/14,000	30		
<b>Tundra (See Footnote CP)</b>	<b>15-17</b>	RT4	2	<b>44568</b>	0	CP,HM	600/6,000	800/8,000	20		
		RT4	2	<b>51091</b>	0	RT,CP,HM	600/6,000	800/8,000	20		
		SQ5	2	<b>96935</b>	0	CP,HM	1,200/12,000	1,400/14,000	30		
<b>Tundra (See Footnote CP)</b>	<b>18-21</b>	RT4	2	<b>44568</b>	0	CP,HM	600/6,000	800/8,000	20		
		RT4	2	<b>51091</b>	0	RT,CP,HM	600/6,000	800/8,000	20		
		SQ5	2	<b>96935</b>	0	CP,HM	1,200/12,000	1,400/14,000	30		
<b>Venza</b>	<b>09-16</b>	RT2	1-1/4	<b>06138</b>	0	HM,JR	300/3,500		20	<b>78109</b>	CH
		RT3	2	<b>44604</b>	0	HM,JR	350/3,500	400/4,000	20		
<b>Yaris 3 Dr. Liftback</b>	<b>07-11</b>	SQ1	1-1/4	<b>77191</b>	0	GP	200/2,000		20		
<b>Yaris 3 Dr. Liftback</b>	<b>07-14</b>	SQ1	1-1/4	<b>77298</b>	0	GP	200/2,000		20		
<b>Yaris 4 Dr. Sedan</b>	<b>07-11</b>	SQ1	1-1/4	<b>77191</b>	0	GP	200/2,000		20	<b>85744</b>	CH
<b>Yaris 5 Dr. Liftback, Except SE</b>	<b>07-14</b>	SQ1	1-1/4	<b>77298</b>	0	GP	200/2,000		20		
<b>Yaris 5 Dr. Hatchback</b>	<b>09-11</b>	SQ1	1-1/4	<b>77191</b>	0	GP	200/2,000		20		
<b>Yaris Except SE</b>	<b>15-20</b>	SQ1	1-1/4	<b>77315</b>	0	GP,EP	200/2,000		25	<b>85872</b>	CH
<b>Yaris iA</b>	<b>17-20</b>	SQ1	1-1/4	<b>77335</b>	0	HM	200/2,000		30	<b>85939</b>	CH,BN

- BN** Exterior mounted plug on some or all models. May require an aftermarket electrical mounting box or bracket. (Sold separately)
- CH** T-One is equipped with circuit protected ModuLite® module.
- CP** Fits all models without factory installed receiver.
- EP** Fascia trimming may be required.
- GP** Hitch cross-tube concealed behind bumper.
- HG** T-One incorporates taillight converter.
- HM** Hitch cross-tube is visible beneath bumper.
- JR** Exhaust must be temporarily lowered for installation.
- 0** Uses all existing holes. No drilling required.
- RT** Round Tube Class III/IV 2"

- RT2** Round Tube Class II 1-1/4"
- RT3** Round Tube Class III 2"
- RT4** Round Tube Class IV 2"
- SQ1** Square Tube Class I
- SQ2** Square Tube Class II
- SQ3** Square Tube Class III
- SQ4** Square Tube Class IV
- SQ5** Square Tube Class V

T - TOYOTA

# RECEIVER HITCH AND T-CONNECTOR APPLICATION GUIDE

MODEL / STYLE	YEAR	TRAILER HITCHES							T-CONNECTOR		
		REC TYPE	REC SIZE	PART NO.	NO DRILL	FOOTNOTES	WC (LBS.)	WD (LBS.)	IN	T-CON PART NO.	FN
<b>VOLKSWAGEN</b>											
Amarok (International Only)	13	SQ3	2	84808†	0	t,HM	600/4,000	800/8,000	30		
Arteon	19-20	SQ1	1-1/4	77989	0	DU,EP	200/2,000		50		
Atlas Except Cross Sport	18-20	SQ2	1-1/4	06186	0	GP	300/3,500		25	85968	CH
		SQ4	2	84176		GP	900/6,000	900/6,000	25		
Atlas Except Cross Sport	21	SQ2	1-1/4	06186	0	GP	300/3,500		25	85968	CH
		SQ4	2	84176		GP	900/6,000	900/6,000	25		
Beetle	98-01	SQ1	1-1/4	77026		TA,GP	200/2,000		30		
Beetle Except Turbo S	02-10	SQ1	1-1/4	77026		TA,GP	200/2,000		30		
Beetle Except Convertible & Gas Turbo	12-13	SQ1	1-1/4	77264†	0	t,HM,JR	200/2,000		20	85928	CH
Beetle Gas Turbo, Except Convertible	12-13	SQ1	1-1/4	77266†		GP,JR	200/2,000		30	85928	CH
Beetle Except R-Line & GSR	14-20	SQ1	1-1/4	77309	0	HM	200/2,000		20	85928	CH
CC Except 4 Motion	09-12	SQ1	1-1/4	77221		HM,JR,X	200/2,000		35		
CC Except 4 Motion	13-18	SQ1	1-1/4	77221		HM,JR,X	200/2,000		35	85908	CH
Eos	07-13	SQ1	1-1/4	77196	0	GP,JR	200/2,000		40		
Golf	99-06	SQ1	1-1/4	77026		TA,GP	200/2,000		30		
Golf 2 Dr. Hatchback, Except R	10-13	SQ1	1-1/4	77197	0	HM	200/2,000		15		
Golf 4 Dr. Hatchback, Except R	10-14	SQ1	1-1/4	77197	0	HM	200/2,000		15		
Golf Hatchback (Canada Only), Except R	10-13	SQ1	1-1/4	77197	0	HM	200/2,000		15		
Golf Wagon (Canada Only)	10-14	SQ1	1-1/4	77249	0	HM,JR,TA	200/2,000		40		
Golf Except Sportwagen Models	15-20	SQ1	1-1/4	77313	0	TA,FE	200/2,000		60	85879	
Golf Alltrack	17-20	SQ1	1-1/4	77949	0	EP,GP,DU,AA	200/2,000		60	85941	CH
Golf Alltrack	18-20	SQ1	1-1/4	77949	0	EP,GP,DU,AA	200/2,000		60		
Golf City (Canada Only)	07-10	SQ1	1-1/4	77026		TA,GP	200/2,000		30		
Golf R	15-20	SQ1	1-1/4	77975	0	DU,GP,TA,X	200/2,000		75	89508	CH
Golf SportWagen	15	SQ1	1-1/4	77949	0	EP,GP,DU,AA	200/2,000		60		
Golf SportWagen	16-20	SQ1	1-1/4	77949	0	EP,GP,DU,AA	200/2,000		60	85941	CH
GTI 2 Dr. Hatchback	06-09	SQ1	1-1/4	77197	0	HM	200/2,000		15		
GTI 4 Dr. Hatchback	07-09	SQ1	1-1/4	77197	0	HM	200/2,000		15		
GTI Hatchback	10-14	SQ1	1-1/4	77291	0	JR,KH,GP	200/2,000		40		
GTI Hatchback (Canada Only)	10-12	SQ1	1-1/4	77291	0	JR,KH,GP	200/2,000		40		
GTI	16-20	SQ1	1-1/4	77313	0	TA,FE	200/2,000		60		
GTI	18-20	SQ1	1-1/4	77979	0	GP,AA,SV,TA	200/2,000		80		
Jetta Sedan, Except Gas Turbo & Wagon	99-04	SQ1	1-1/4	77106		TA,HM	200/2,000		30		
Jetta 4 Dr. Sedan	05-10	SQ1	1-1/4	77249	0	HM,JR,TA	200/2,000		40	85874	CH
Jetta Sedan, Except Gas Turbo & Wagon	05	SQ1	1-1/4	77106		TA,HM	200/2,000		30		
Jetta SportWagon	09-14	SQ1	1-1/4	77249	0	HM,JR,TA	200/2,000		40		
Jetta 4 Dr. Sedan	11-14	SQ1	1-1/4	77249	0	HM,JR,TA	200/2,000		40	85810	CH
Jetta 4 Dr. Sedan, Except Hybrid & TDI	15-18	RT1	1-1/4	77312	0	JR,HM,TA,SV	200/2,000		40	85810	CH
Jetta	19-20	SQ1	1-1/4	77978	0	GP,AA,X,TA	200/2,000		80	89525	CH,NZ
Jetta City Sedan (Canada Only)	07-09	SQ1	1-1/4	77106		TA,HM	200/2,000		30		
Passat 4 Dr. Sedan, Except 4 Motion & W8 Engine	99-05	SQ1	1-1/4	77039		RB,TA,HM	200/2,000		40		
Passat Wagon, Except 4 Motion & W8 Engine	99-05	SQ1	1-1/4	77039		RB,TA,HM	200/2,000		40		
Passat 4 Dr. Sedan, Except 4 Motion	06-10	SQ1	1-1/4	77221		HM,JR,X	200/2,000		35	85792	CH
Passat Wagon, Except 4 Motion	07-10	SQ1	1-1/4	77221		HM,JR,X	200/2,000		35	85781	CH
Passat 4 Dr. Sedan	12-19	SQ1	1-1/4	77267	0	EP,GP,JR,SV,TA	200/2,000		30	85879	
Passat Except SE & SEL	16-20	SQ1	1-1/4	77267	0	EP,GP,JR,SV,TA,TW	200/2,000		30	85935	CH
Passat SE & SEL Only	16-19	SQ1	1-1/4	77267	0	EP,GP,JR,SV,TA,TW	200/2,000		30	85951	CH
Passat	17-19	SQ1	1-1/4	77267	0	EP,GP,JR,SV,TA,TW	200/2,000		30	85935	CH
Passat 2.0T S	20	SQ1	1-1/4	77994		DU,EP,GP	200/2,000		40		
Rabbit	06-09	SQ1	1-1/4	77197	0	HM	200/2,000		15		

† Available while supply lasts.  
**AA** Requires temporary removal of bumper during installation.  
**CH** T-One is equipped with circuit protected ModuLite® module.  
**DU** Fascia removal required.  
**EP** Fascia trimming may be required.  
**FE** Fascia trimming may be required. Allow additional installation time.  
**GP** Hitch cross-tube concealed behind bumper.  
**HM** Hitch cross-tube is visible beneath bumper.  
**JR** Exhaust must be temporarily lowered for installation.  
**KH** Minor heat shield modification may be required.  
**NZ** DO NOT use ZCI with this application. Please use other approved kit or contact dealer.  
**0** Uses all existing holes. No drilling required.

**RB** Hitch installation can be made easier with a cutter type drill bit.  
**SV** Trimming or removal of under body appearance panel may be required.  
**TA** Trunk access required for hitch installation.  
**TW** Receiver hitch may limit hands-free liftgate sensor range  
**X** Minor fascia trimming required.

**RT1** Round Tube Class I 1-1/4"  
**SQ1** Square Tube Class I  
**SQ2** Square Tube Class II  
**SQ3** Square Tube Class III  
**SQ4** Square Tube Class IV

# RECEIVER HITCH AND T-CONNECTOR APPLICATION GUIDE

RECEIVER HITCHES

MODEL / STYLE	YEAR	TRAILER HITCHES								T-CONNECTOR	
		REC TYPE	REC SIZE	PART NO.	NO DRILL	FOOTNOTES	WC (LBS.)	WD (LBS.)	IN	T-CON PART NO.	FN
<b>VOLKSWAGEN (Continued)</b>											
Routan	09-12	SQ2	1-1/4	06550	0	GP, JR	300/3,500		20	85712	
		SQ2	1-1/4	51192	0	GP, JR	300/3,500		20		
		SQ3	2	44586	0	GP, JR	400/4,000	500/5,000	20		
		SQ3	2	51203	0	GP, JR	400/4,000	400/4,000	20		
Routan (Canada Only)	13-14	SQ2	1-1/4	06550	0	GP, JR	300/3,500		20		
		SQ2	1-1/4	51192	0	GP, JR	300/3,500		20		
		SQ3	2	44586	0	GP, JR	400/4,000	500/5,000	20		
		SQ3	2	51203	0	GP, JR	400/4,000	400/4,000	20		
Tiguan	09-11	SQ2	1-1/4	06625	0	EP, HM	300/3,500		20		
		SQ3	2	44611	0	EP	350/3,500		20		
Tiguan	12-17	SQ2	1-1/4	06625	0	EP, HM	300/3,500		20	85888	CH, BN
		SQ3	2	44611	0	EP	350/3,500		20		
Tiguan 4 Motion	18-20	SQ2	1-1/4	06188	0	GP, JR	300/3,500		20	89532	CH
		SQ3	2	84192	0	EP, GP, JR	675/4,500	675/4,500	40		
Tiguan Except 4 Motion	18-20	SQ2	1-1/4	06188	0	GP, JR	300/3,500		20	89532	CH
		SQ3	2	84192	0	EP, GP, JR	675/4,500	675/4,500	40		
Touareg	04-10	SQ4	2	44530		AA, RB	600/6,000	600/6,000	90	85733	CH
Touareg	11-17	SQ4	2	44758	0	GP, EP, TA	750/7,500		70	85882	CH
<b>VOLVO</b>											
C30	08-10	SQ1	1-1/4	77182†		†, HM, JR, KH	200/2,000		45		
C70 Convertible	98-04	SQ2	1-1/4	06024		GP, JR	300/3,500		20		
C70 Coupe	98-02	SQ2	1-1/4	06024		GP, JR	300/3,500		20		
S40 Sedan (App. starts with 2004-1/2)	04-11	SQ1	1-1/4	77156	0	GP, JR	200/2,000		25		
S60 Sedan	01-09	SQ2	1-1/4	06420	0	HM, JR	300/3,500		15		
S60 Sedan	11-13	SQ3	2	44999	0	DU, EP, GP	400/4,000		70		
S60 Sedan	14-18	SQ3	2	44999	0	DU, EP, GP	400/4,000		70	85994	CH
S70 Sedan	98-00	SQ2	1-1/4	06024		GP, JR	300/3,500		20		
S80 Sedan	07-16	SQ2	1-1/4	06608†	0	HM, JR, KH	300/3,500		35	78012	CH
V50 Wagon, Except T5 R-Design	05-10	SQ1	1-1/4	77156	0	GP, JR	200/2,000		25		
V60 (App. starts with 2015-1/2)	15-17	SQ3	2	44999	0	DU, EP, GP	400/4,000		70	85869	CH
V70 Wagon	98-00	SQ2	1-1/4	06024	0	GP	300/3,500		20		
V70 Wagon	01-02	SQ2	1-1/4	06420	0	HM, JR	300/3,500		15		
V70 Wagon	03-07	SQ2	1-1/4	06420	0	HM, JR	300/3,500		15		
V70 Wagon	08-10	SQ3	2	44999	0	DU, EP, GP	400/4,000		70	78005	CH
XC40	19-20	SQ3	2	84245	0	DU, AA, GP, TA	600/4,000		70	89519	CH
XC60	10-17	SQ3	2	44629	0	GP, JR, KH, SR	400/4,000	450/4,500	45	85749	CH
XC60	14	SQ3	2	84116	0	JR, AG, KH	400/4,000	450/4,500	30	85749	CH
XC60	15-17	SQ3	2	84116	0	JR, AG, KH	400/4,000	450/4,500	30		
XC60	18-20	SQ4	2	84194	0	AA, DU, EP, GP, KH	900/6,000		65	89512	CH
XC70 Wagon, AWD	03-07	SQ2	1-1/4	06420	0	HM, JR	300/3,500		15		
XC70	08-16	SQ3	2	44999	0	DU, EP, GP	400/4,000		70	85989	CH
XC90	03-04	SQ3	2	33073	0	JR	500/5,000	500/5,000	25		
XC90	05-14	SQ3	2	33073	0	JR	500/5,000	500/5,000	25	78047	CH
XC90	16-21	SQ4	2	84194	0	AA, DU, EP, GP, KH	900/6,000		65	85902	CH

- † Available while supply lasts.
- AA Requires temporary removal of bumper during installation.
- AG Drawbar Kit & Accessory Adapter sold separately.
- BN Exterior mounted plug on some or all models. May require an aftermarket electrical mounting box or bracket. (Sold separately)
- CH T-One is equipped with circuit protected ModuLite® module.
- DU Fascia removal required.
- EP Fascia trimming may be required.
- GP Hitch crosstube concealed behind bumper.
- HM Hitch crosstube is visible beneath bumper.
- JR Exhaust must be temporarily lowered for installation.
- KH Minor heat shield modification may be required.
- 0 Uses all existing holes. No drilling required.

- RB Hitch installation can be made easier with a cutter type drill bit.
- SR Only use ball mounts with 8-1/2 in. length : 3/4 in. rise : 2 in. drop for this vehicle.
- TA Trunk access required for hitch installation.

- SQ1 Square Tube Class I
- SQ2 Square Tube Class II
- SQ3 Square Tube Class III
- SQ4 Square Tube Class IV



## RECEIVER HITCH AND T-CONNECTOR APPLICATION GUIDE

## ELECTRICAL APPLICATION FOOTNOTES

<b>BN</b>	Exterior mounted plug on some or all models. May require an aftermarket electrical mounting box or bracket. (Sold separately)
<b>C</b>	2 or 3 wire system determine at installation.
<b>CE</b>	T-One includes fuse(s) & relay(s). Converter not required. Standard 2 wire system at factory tow plug.
<b>CG</b>	T-One incorporates circuit protected taillight converter.
<b>CH</b>	T-One is equipped with circuit protected ModuLite® module.
<b>FV</b>	2003 Models w/Build date after 11/1/02.
<b>FW</b>	2003 Models w/Build date before 11/1/02.
<b>GC</b>	T-One is equipped with ModuLite® Lite module.
<b>H</b>	3 wire system with OEM standard 2 wire harness.
<b>HG</b>	T-One incorporates taillight converter.
<b>HJ</b>	Per Dodge owner's manual: If trailer is equipped with more than standard lighting (1 taillight per side) use of ModuLite® or dealer supplied harness is required.
<b>LS</b>	T-One incorporates low-side switching taillight converter. Additional installation time required.
<b>NZ</b>	DO NOT use ZCI with this application. Please use other approved kit or contact dealer.
<b>RD</b>	For vehicles equipped with factory tow package may require additional components or may be used as a replacement harness.
<b>RW</b>	On some models it may require an upgraded flasher or ModuLite®.
<b>TR</b>	Trimming or Modification of the vehicle connector may be required.

## HITCH APPLICATION FOOTNOTES

<b>#</b>	Titan hitches require use of a 2-1/2" shank Titan ball mount.
<b>†</b>	Available while supply lasts.
<b>AA</b>	Requires temporary removal of bumper during installation.
<b>AB</b>	Requires four (4) 3/8 in. spacer blocks (#01077011) for installation. (Sold separately)
<b>AE</b>	Requires temporary removal of muffler during installation.
<b>AF</b>	Hitch is ONLY rated for Weight Carrying at 3500 lbs. GTW / 350 lbs. TW and DO NOT use Weight Distribution Spring Bars for this Specific Vehicle. Except for long bed pickups.
<b>AG</b>	Drawbar Kit & Accessory Adapter sold separately.
<b>AI</b>	Additional installation time may be required.
<b>AL</b>	Additional installation time required for vehicles equipped with load leveling compressor.
<b>AW</b>	Will not fit Turbo models.
<b>BF</b>	Requires standard bumper. Will not fit with step bumper.
<b>BN</b>	Exterior mounted plug on some or all models. May require an aftermarket electrical mounting box or bracket. (Sold separately)
<b>BY</b>	Minor repositioning of muffler required.
<b>CA</b>	Models with dual exhaust require exhaust modification.
<b>CC</b>	Requires minimum of 19 in. from end of frame rail to spring shackle bracket.
<b>CH</b>	T-One is equipped with circuit protected ModuLite® module.
<b>CN</b>	Requires OEM factory bumper for hitch installation.
<b>CO</b>	Will not fit 8 ft. 2500/3500 Series with heavy-duty suspension or four door Crew Cab.
<b>CP</b>	Fits all models without factory installed receiver.
<b>CQ</b>	Will not fit with heavy duty suspension.
<b>CR</b>	Fits with mini spare tire stowed under vehicle. Will not fit with full size spare.
<b>CS</b>	Will fit with full-size spare tire stowed under vehicle.
<b>CT</b>	Will not fit long bed models after 1999.
<b>DA</b>	Will not fit with tube style bumper.
<b>DB</b>	Will not fit 6 ft. bed pickups.
<b>DS</b>	Use DT #75151 On 1500 Models Built After 11/1/02. Use DT #75135 On 1500 Models Built Before 11/1/02.
<b>DU</b>	Fascia removal required.
<b>DY</b>	Use On 1500 Models Built After 11/1/02.
<b>EB</b>	Factory electrical bracket will NOT fit with this hitch. Must use aftermarket electrical box or bracket.
<b>EF</b>	Fits all models with standard bumpers.
<b>EO</b>	Requires longer ball mount.
<b>EP</b>	Fascia trimming may be required.
<b>FE</b>	Fascia trimming may be required. Allow additional installation time.
<b>FP</b>	Spare tire repositioning and/or modification of spare tire carrier may be required.
<b>FS</b>	Includes 2 & 4 WD models with heavy duty suspension.

HITCH APPLICATION FOOTNOTES (Continued)	
GH	Will not fit models with 34 in. wide frames.
GP	Hitch crosstube concealed behind bumper.
GU	Will not fit vehicles with factory or aftermarket lower Fascia/Rollpan or Tube Bumper.
HA	External dress panel beneath 95-97 and 03-05 vehicles must be removed for hitch installation.
HB	Slight fascia deformation may occur on some models.
HK	Under vehicle spare tire stowage may be retained with installation of an aftermarket spare tire repositioner. Cutting of rollpan in license plate area required for receiver tube access. Does not fit with bumper.
HM	Hitch crosstube is visible beneath bumper.
HR	Requires drilling of heat shields on V6 models.
HX	Minor exhaust modification may be required.
HY	Ultra Frame ball mount DT #4283/HH #80125 cannot be used in rise position on vehicles with step bumpers.
I	Hitch is positioned further rearward to accommodate spare tire.
J	Under vehicle spare tire stowage is retained.
JF	Will not fit with 16 in. spare tire.
JL	Installation requires OEM bumper and brackets.
JR	Exhaust must be temporarily lowered for installation.
JT	2WD models only.
JV	Rubber air deflector/fascia must be removed or trimmed to install hitch.
KH	Minor heat shield modification may be required.
KK	When installing on a vehicle originally equipped with an OEM hitch. OEM bumper brackets must be purchased and installed prior to new hitch installation.
KL	Hitch is designed to attach beneath the OEM hitch.
KM	Does not work with models originally equipped with OEM hitch.
L	Exhaust repositioning required.
LT	Requires removal of factory hitch if equipped.
M	Will fit with heavy-duty suspension.
MB	Will not fit models equipped with air suspension package.
O	Will not fit vehicles equipped with dual exhaust exiting below the bumper.
Ø	Uses all existing holes. No drilling required.
PA	Will not fit 124 in. wheelbase or E-350 models.
QW	Will not fit vehicles with dual exhaust.
RA	Do not install on early 1996 models equipped with M10 fasteners.
RB	Hitch installation can be made easier with a cutter type drill bit.
RC	Will not fit with rear sport bars.
RH	Optional drawbar #36051 required (Sold separately) except for models with ZR2 & Highrider package.
RO	Will not fit Silverado SS.
RT	Round Tube Class III/IV 2"
SA	Requires drilling on 6 ft. bed models.
SB	Will not fit models with short bed.
SC	Minor trimming of plastic trunk pan required.
SD	Hitches produced before 07/21/06 are rated at 350/3500 WC.
SG	Hitches produced before 09/10/07 are rated at 1000/10000 WC & 1200/12000 WD.
SH	Hitches produced before 09/27/07 are rated at 1200/12000 WC & 1400/14000 WD.
SI	Hitches produced before 07/31/07 are rated at 350/3500 WC & 500/5000 WD.
SN	Hitches produced before 04/28/08 are rated at 1000/10000 WC & 1200/12000 WD.
SO	With this hitch installed the step bumper is no longer able to be used as a towing point.
SR	Only use ball mounts with 8-1/2 in. length : 3/4 in. rise : 2 in. drop for this vehicle.
ST	Will not fit 2WD models with short bed.
SU	Hitches produced before 03/11/08 are rated at 1000/10000 WC & 1200/12000 WD.
SV	Trimming or removal of under body appearance panel may be required.
SY	Hitch crosstube is visible beneath bumper with a more than normal gap between fascia and crosstube.
SZ	Hitches produced before 03/10/11 are rated at 600/6000 WC.
T	Vans with step bumpers require longer ball mounts.
TA	Trunk access required for hitch installation.

## RECEIVER HITCH AND T-CONNECTOR APPLICATION GUIDE

## HITCH APPLICATION FOOTNOTES (Continued)

<b>TE</b>	Hitches produced before 04/20/11 are rated at 500/5000 WC.
<b>TG</b>	Hitches produced before 05/13/11 are rated at 350/3500 WC.
<b>TI</b>	Hitches produced before 06/06/11 are rated at 400/4000 WC.
<b>TJ</b>	Hitches produced before 07/13/11 are rated at 350/3500 WC.
<b>TK</b>	Hitches produced before 09/09/11 are rated at 500/5000 WC & 600/6000 WD.
<b>TL</b>	Hitches produced before 10/31/11 are rated at 500/5000 WC & 750/7500 WD.
<b>TN</b>	Hitches produced before 07/09/12 are rated at 500/5000 WC & 500/5000 WD.
<b>TO</b>	Will not fit models equipped Chassis Cab spring mount.
<b>TQ</b>	Hitches produced before 07/30/12 are rated at 350/3500 WC.
<b>TU</b>	Hitches produced before 07/24/12 are rated at 350/3500 WC.
<b>TW</b>	Receiver hitch may limit hands-free liftgate sensor range
<b>TZ</b>	Requires replacement of the impact structure with hitch.
<b>UD</b>	Fascia removal required on XR & XRS models.
<b>UL</b>	This hitch will not fit a Sprinter single or dual rear-wheel vehicle with a 30-3/8 in. wide frame measured outside of frame to outside of frame.
<b>V</b>	For vehicles with factory installed step bumpers only.
<b>VB</b>	Will not fit vehicles with vibration damper installed at rear of frame on drivers side.
<b>X</b>	Minor fascia trimming required.

## PASSENGER CARS (PC)

Passenger car wiring positions are referenced by the letters PC and a number. Use the illustration to identify the wiring location for all passenger cars.

- PC1** - Behind driver side tail light - externally
- PC2** - Behind passenger side tail light - externally
- PC3** - Inside trunk behind driver side tail light - internally
- PC4** - Inside trunk behind passenger side tail light - internally
- PC5** - Under vehicle, driver side
- PC6** - Under vehicle, center
- PC7** - Under vehicle, passenger side



## PICKUP TRUCKS, FULL & MID-SIZE (PU)

Pickup truck wiring positions are referenced by the letters PU and a number. Use the illustration to identify the wiring location for all trucks.

- PU1** - Behind driver side tail light
- PU2** - Behind passenger side tail light
- PU3** - Under vehicle, driver side
- PU4** - Under vehicle, passenger side
- PU5** - Under vehicle, center

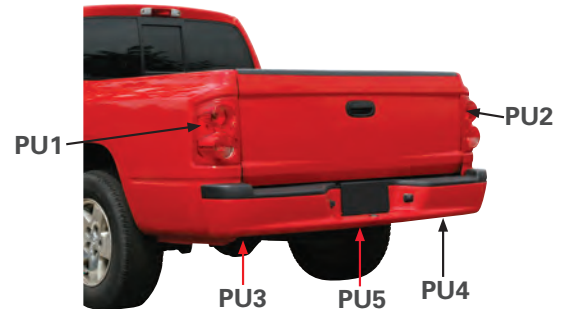

## SPORT UTILITY, VAN & MINI-VANS (SUV)

Sport utility, vans & mini-van wiring positions are referenced by the letters SUV and a number. Use the illustration to identify the wiring location for all sport utility vehicles, vans and mini-vans.

- SUV1** - Behind driver side tail light
- SUV2** - Behind passenger side tail light
- SUV3** - Behind driver side trim panel
- SUV4** - Behind passenger side trim panel
- SUV5** - Under vehicle, driver side
- SUV6** - Under vehicle, center
- SUV7** - Under vehicle, passenger side
- SUV8** - Inside vehicle, center
- SUV9** - Inside vehicle, passenger side, behind panel near rear seat

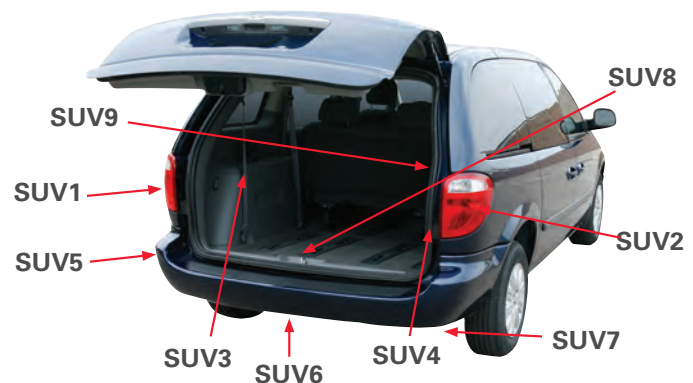



# HITCH ACCESSORIES

No towing system is complete without the right hitch ball mount. REESE® Towpower is fundamentally changing the approach to ball mounts with an innovative and patent pending line of products. REESE® Towpower manufactures many different ball mounts, so you can choose the right fit, based on your vehicle type, towing capacity, trailer and load size, along with the height of your hitch. Each trailer hitch ball mount is dipped in a zinc-phosphate based coating for maximum protection against rust and corrosion, even in the most "hard to fill" places. Then it is coated again with a powder coat for two layers of superior protection.

## BALL MOUNTS

Ball Mount Selection .....	B-5
Class I and II .....	B-5
Towing Starter Kits .....	B-6
Class III and IV .....	B-6
Carbon Forged .....	B-7
Forged Solid Shank .....	B-8
Class V Heavy Duty .....	B-8
Dual Ball Mounts .....	B-8
Tri Ball Mounts .....	B-9 - B-10
Adjustable Ball Mounts .....	B-10

## SPECIALTY BALL MOUNTS

Tow Hooks .....	B-13 - B-16
Pintle Hooks and Mounts .....	B-13 - B-16
Clevis Mounts .....	B-16
Vehicle Recovery Rings .....	B-17
ATV Hitch .....	B-17
Boot Brush Ball Mount .....	B-18
Tow and Go Hitch Steps .....	B-18

## HITCH BALLS

Hitch Ball Selection .....	B-3
Standard Hitch Balls .....	B-3
InterLock® Hitch Balls .....	B-4
Interchangeable Hitch Balls .....	B-4

## HITCH ACCESSORIES

Reducer Sleeves and Adapters .....	B-11
Hitch Extensions .....	B-11 - B-12
Pins and Clips .....	B-19 - B-20
Receiver Locks .....	B-20 - B-22
Coupler Locks .....	B-23 - B-24
Cable Locks .....	B-24
Receiver Tube Covers .....	B-25
Hitch Ball Accessories .....	B-26

## DISCONTINUED PRODUCTS .....

	B-27
--	------



NEW

**STANDARD HITCH BALL**

For over 65 years REESE Towpower has been the number ONE manufacturer of towing products. This position has been achieved and sustained through market innovation and a commitment to the highest quality standards. Our complete line of products is used by recreation enthusiasts, heavy-duty agriculture users and even vehicle manufacturers around the world. Easy-to-understand tri-lingual instructions make use and installation simple and straightforward. All REESE TOWPOWER products endure testing so rigorous that in many cases our method actually became the industry standard. Rest assured your peace of mind is our business. No other towing company in the industry can compare.



7091200

- Solid steel hitch balls engineered to meet all safety requirements of SAE J684
- Forged for superior strength
- Chrome finish for corrosion prevention and lasting good looks
- 25,000 lbs capacity
- See page B-3 for additional information

FEATURED

**SOLID SHANK TRI-BALL MOUNT**

REESE Towpower Tri-Ball ball mount provides the greatest convenience and versatility for ease of use to customers who have various towing requirements. Simply adjust the ball mount and rotate to the desired hitch ball. Engineered and tested to exceed towing standards.



7094300

- 1- 7/8 In. hitch ball 200/2,000 Lb. capacity
- 2 In. hitch ball 1,000/10,000 Lb. capacity
- 2- 5/16 In. hitch ball 1,600/16,000 lb. capacity
- Perfect for multi trailer owners
- Superior rust protection
- Fits 2 In. square shank
- Limited lifetime warranty
- See page B-9 for additional information

HITCH BALLS

**SELECTING THE RIGHT HITCH BALL:**

1. Always use the properly-rated hitch ball for your towing system
2. Your towing system's maximum weight rating is always equal to the lowest rated item in the system
3. Your hitching system cannot be upgraded to a rating higher than the maximum rating of your hitch

For example, a 3,500 lbs. ball on a 2,000 lbs. max trailer weight-rated hitch does not increase your towing capacity to 3,500 lbs. Your hitching system is still rated at 2,000 lbs.

- Conversely, a 2,000 lbs. ball on a 3,500 lbs. max trailer weight-rated hitch decreases your maximum towing capacity to 2,000 lbs
- The hitch ball diameter (A) must be the same diameter as the trailer coupler (1-7/8, 2 or 2-5/16 in.)
- The shank diameter (B) of the hitch ball should be the same as the hole diameter in the ball mount
- The shank length (C) should be long enough to allow at least two threads to be visible when the hitch ball is installed and the nut completely tightened

\*The ball diameter required is stamped into the coupler handle or body  
 \*\*During hitch ball installation, torque all 3/4 in. shank diameter balls to 160 ft. lbs., and 1 in. shank diameter balls to 250 ft. lbs., and 1-1/4 in. shank diameter balls to 450 ft. lbs.

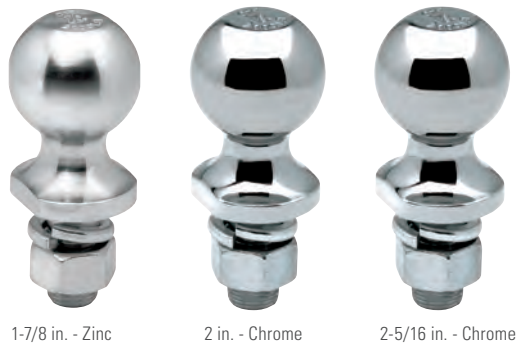
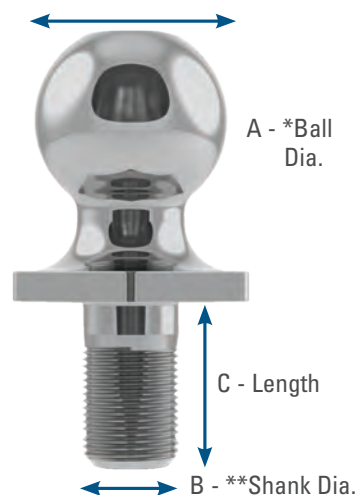

**STANDARD HITCH BALLS**

- Solid steel hitch balls engineered to meet all safety requirements of SAE J684
- Forged for superior strength
- Chrome or zinc finish for corrosion prevention and lasting good looks
- When installing hitch balls, torque all 3/4 in. shank diameter balls to 160 ft. lbs.  
 all 1 in. shank diameter balls to 250 ft. lbs.  
 all 1-1/4 in. shank diameter balls to 450 ft. lbs.

Part Number	Finish	Ball Diameter (in.)	Shank Diameter (in.)	Shank Length (in.)	Capacity (lbs.)	Packaging	Master Carton
74006	Chrome	1-7/8	3/4	1-1/2	2,000	Litho Box	3
7036800	Chrome	1-7/8	5/8	1-3/4	2,000	Display Label	6
7028900	Chrome	1-7/8	3/4	2-3/8	2,000	Display Label	3
74020	Chrome	2	3/4	2-3/8	3,500	Litho Box	3
74026	Chrome	2	1	3-1/4	6,000	Clamshell	3
7402136	Chrome	2-5/16	1	2	6,000	Litho Box	3
7033920	Chrome	2	1-1/4	2-3/4	8,000	Display Label	3
74294	Chrome	2-5/16	1-1/4	2-1/2	12,000	Clamshell	3
7028400	Chrome	2-5/16	1-1/4	2-3/4	12,000	Display Label	3
7028500	Chrome	2-5/16	1-1/4	2-3/4	14,000	Display Label	3
7028636	Chrome	2-5/16	1-1/4	2-3/4	17,000	Display Label	3
7091200	Chrome	2-5/16	1-1/4	2-3/4	25,000	Litho Box	3

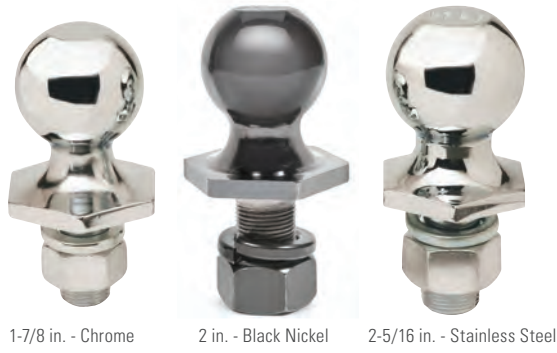

1-7/8 in. - Chrome      2 in. - Black Nickel      2-5/16 in. - Stainless Steel

### INTERLOCK® HITCH BALLS

- Solid steel hitch balls engineered to meet all safety requirements of SAE J684
- Forged for superior strength
- The Interlock® feature allows the hitch ball to be seated into the hex location on the ball mount bar and tightened with a single wrench
- When installing hitch balls, torque all 3/4 in. shank diameter balls to 160 ft. lbs. all 1 in. shank diameter balls to 250 ft. lbs. all 1-1/4 in. shank diameter balls to 450 ft. lbs.



Part Number	Finish	Ball Diameter (in.)	Shank Diameter (in.)	Shank Length (in.)	Capacity (lbs.)	Packaging	Master Carton
7008100	Chrome	1-7/8	3/4	1-1/2	2,000	Plastic Shroud	3
7008700	Chrome	1-7/8	1	2	2,000	Plastic Shroud	3
7008400	Chrome	1-7/8	3/4	2-3/8	2,000	Plastic Shroud	3
7071100	Chrome	1-7/8	3/4	1-1/2	3,500	Litho Box	3
7008200	Chrome	2	3/4	1-1/2	3,500	Plastic Shroud	3
7071200	Chrome	1-7/8	1	2	3,500	Litho Box	3
7008500	Chrome	2	3/4	2-3/8	3,500	Plastic Shroud	3
7008300	Chrome	2	1	2	6,000	Plastic Shroud	3
7011300	Stainless Steel	2	1	2	6,000	Plastic Shroud	3
7008600	Chrome	2-5/16	1	2	6,000	Plastic Shroud	3
7011400	Stainless Steel	2-5/16	1	2	6,000	Plastic Shroud	3
7061200	Chrome	2	1	2	7,500	Plastic Shroud	3
7060400	Black Nickel	2	1	2	7,500	Plastic Shroud	3
7071000	Chrome	2-5/16	1	2	7,500	Plastic Shroud	3
7063400	Chrome	2-5/16	1-1/4	2-5/8	14,000	Display Label	3



74309

### INTERCHANGEABLE HITCH BALLS

Designed to accommodate towing multiple trailers with ease, the Interchangeable Hitch Ball System allows you to change hitch ball sizes in seconds without any tools. Available in 2- and 3-ball sets, these kits feature a quick-release, positive-latch design.

- Available in 3/4 in. and 1 in. shank models
- Innovative quick release changes balls in seconds
- Rated capacities up to 8,000 lbs.
- Durable heat-treated shank
- Positive latch design
- No special tools required

Part Number	Finish	Shank Diameter (in.)	Capacity (lbs.)	Hitch Ball Diameters (in.)	Packaging	Master Carton
74307	Chrome	3/4	5,000	1-7/8 and 2	Clamshell	2
74308	Chrome	1	8,000	1-7/8 and 2	Clamshell	2
74309	Chrome	1	8,000	1-7/8, 2 and 2-5/16	Clamshell	2

**CLASS I/II BALL MOUNTS**

**BALL MOUNTS**

There is a REESE Towpower® ball mount for just about every application. Choose from Class I- Class V conventional ball mounts with rise or drop styles and multiple lengths to meet your hitching needs. REESE Towpower's Towing Starter Kit contains everything you need to get underway with your trailer. A wide range of specialty hitches enables a quick conversion to other ball sizes and other hitching options. A range of accessories makes your trailering experience easier and more convenient. Make REESE Towpower® ball mounts your first and only choice in meeting your towing needs.

**SELECTING THE RIGHT BALL MOUNT:**

1. Measure from the ground to the top of the hitch
2. Measure from the ground to the (inside) top of the trailer coupler (when level)  
(The difference in the two measurements is the amount of ball mount 'rise' or 'drop' required)
3. Subtract the height of the hitch ball (most are 2-1/2 in. - 3 in. high) from coupler measurement  
(The difference in the two measurements is the amount of ball mount 'rise' or 'drop' required)



3594011



06474

**STANDARD CLASS I/II BALL MOUNTS**

- Quick load for faster and easier mounting and removal
- Lifetime limited warranty
- Includes pin and clip

Part Number	Rating GTW/TW (lbs.)	Ball Hole Size (in.)	A Length (in.)	B Rise (in.)	C Drop (in.)	Receiver Opening (in.)	Packaging	Master Carton
<b>Metal Shield® Finish</b>								
3594011	2,000/200	3/4	10	4	-	1-1/4	Display Label	2
3592011	2,000/200	3/4	9-3/4	2-1/8	2-3/4	1-1/4	Display Label	2
<b>Bright Zinc Finish</b>								
06280	3,000/350	3/4	9	3/4	1-1/4	1-1/4	Display Label	2
06474	3,000/350	3/4	7	2	2-1/2	1-1/4	Display Label	2



7005100

**INTERLOCK® STARTER SECURITY KITS**

- The Interlock® feature allows the hitch ball to be seated into the hex location on the ball mount bar and tightened with a single wrench
- Includes ball, locking pin and two flat keys
- Case provides convenient storage when not in use



Part Number	Rating GTW/TW (lbs.)	Ball Size (in.)	A Length (in.)	B Rise (in.)	C Drop (in.)	Receiver Opening (in.)	Packaging	Master Carton
7005100	6,000/600	2	8-1/5	3/4	2	2	Plastic Shroud	2
7005200	5,000/500	2	9	2	3-1/4	2	Display Label	2



21542



7092400

### INTERLOCK® STARTER KITS

- The Interlock® feature allows the hitch ball to be seated into the hex location on the ball mount bar and tightened with a single wrench
- Includes ball and pin and clip (not included in 7039200 and 7039300)



Part Number	Rating GTW/TW (lbs.)	Ball Size (in.)	A Length (in.)	B Rise (in.)	C Drop (in.)	Receiver Opening (in.)	Packaging	Master Carton
<b>Metal Shield® Finish</b>								
7043000	3,500/350	2	9	3/4	1-1/4	1-1/4	Display Label	2
7043120	3,500/350	2	7	2	2-1/2	1-1/4	Display Label	2
21542	6,000/600	2	8-1/5	3/4	2	2	Display Label	2
21543	5,000/500	2	9	2	3-1/4	2	Display Label	2
7090800	14,000/1,400	2-5/16	9-7/8	1-1/2	3	2-1/2	Display Label	2
7090900	13,000/1,300	2-5/16	10-1/4	3-1/2	5	2-1/2	Display Label	2
<b>REESE® Tactical™ Matte Black Finish</b>								
7092400	6,000/600	2	8-1/5	3/4	2	2	Display Label	2
7092500	5,000/500	2	9	2	3-1/4	2	Display Label	2
<b>Black Nickel Finish</b>								
7039200	6,000/600	2	5/8	3/4	2	2	Display Label	2
7039300	5,000/500	2	5/8	2	3-1/4	2	Display Label	2

### STANDARD TOWING STARTER KITS

- Includes ball and pin and clip
- Angle cut design for quick load and removal
- Metal Shield® finish resists rust and corrosion



21536

Part Number	Rating GTW/TW (lbs.)	Ball Size (in.)	Pin Size (in.)	B Rise (in.)	C Drop (in.)	Receiver Opening (in.)	Packaging	Master Carton
21536	6,000/600	2	1/2	3/4	2	2	Display Label	2
21556	5,000/500	2	1/2	2	3-1/4	2	Display Label	2
7043200	2,000/200	1-7/8	5/8	3/4	2	2	Display Label	2
7080500	7,500/750	2	5/8	3/4	2	2	Display Label	2
7081000	7,500/750	2	5/8	2-3/4	4	2	Display Label	2

### STANDARD CLASS III/IV BALL MOUNTS

- Quick load for faster and easier mounting and removal
- Lifetime limited warranty
- Metal Shield® finish resists rust and corrosion



21345

Part Number	Rating GTW/TW (lbs.)	Ball Hole Size (in.)	A Length (in.)	B Rise (in.)	C Drop (in.)	Receiver Opening (in.)	Packaging	Master Carton
21171	6,000/600	1	8	3/4	2	2	Display Label	6
21175	6,000/600	1	8-1/2	2	3-1/4	2	Display Label	6
21344	5,000/500	1	9	2-3/4	4	2	Display Label	6
21345	6,000/600	1	11	2-3/4	4	2	Display Label	6
21186	5,000/500	1	10	4	5-1/4	2	Display Label	2
21347	5,000/500	1	10	6-3/4	8	2	Display Label	2
21342	7,500/750	1	8-1/2	3/4	2	2	Display Label	6



CLASS III/IV BALL MOUNTS



INTERLOCK® BALL MOUNTS

- Quick and easy installation
- One-wrench tightening system
- The Interlock® feature allows the hitch ball to be seated into the hex location on the ball mount bar and tightened with a single wrench



Part Number	Rating GTW/TW (lbs.)	Ball Hole Size (in.)	A Length (in.)	B Rise (in.)	C Drop (in.)	Receiver Opening (in.)	Packaging	Master Carton
<b>Metal Shield® Finish</b>								
21901	3,500/300	3/4	9	3/4	1-1/4	1-1/4	Display Label	2
21900	3,500/300	3/4	7	2	2-1/2	1-1/4	Display Label	2
21792	6,500/600	1	9	3/4	2	2	Display Label	2
21793	5,000/500	1	8-3/4	2	3-1/4	2	Display Label	2
21794	5,000/500	1	10	4	5-1/4	2	Display Label	2
7081300	7,000/700	1	12	9-3/4	11	2	Display Label	2
7063200	14,000/1,400	1-1/4	9-4/5	1-1/2	3	2-1/2	Display Label	2
7063300	13,000/1,300	1-1/4	10	3-1/2	5	2-1/2	Display Label	2
<b>Stainless Steel Finish</b>								
21790	6,000/600	1	9	3/4	2	2	Display Label	2
21791	5,000/500	1	9-1/2	2	3-1/4	2	Display Label	2



CARBON FORGED INTERLOCK® BALL MOUNTS

- Quick and easy installation
- One-wrench tightening system
- The Interlock® feature allows the hitch ball to be seated into the hex location on the ball mount bar and tightened with a single wrench



Part Number	Rating GTW/TW (lbs.)	Ball Hole Size (in.)	A Length (in.)	B Rise (in.)	C Drop (in.)	Receiver Opening (in.)	Packaging	Master Carton
<b>O.E.M. Black Finish</b>								
7067900	3,500/350	3/4	8-3/8	3/4	1-1/4	1-1/4	Display Label	2
7068000	3,500/350	3/4	8-1/2	1-1/2	2	1-1/4	Display Label	2
7068300	3,500/350	3/4	8-1/2	2-1/2	3	1-1/4	Display Label	2
7062800	7,000/700	1	8-1/2	1/2	2	2	Display Label	2
7062900	6,000/600	1	8-1/2	1-1/2	3	2	Display Label	2
7065700	5,000/500	1	8-3/4	2-1/2	4	2	Display Label	2
7068100	5,000/500	1	10	3-1/2	5	2	Display Label	2
<b>Black Nickel Finish</b>								
7060700	7,000/700	1	8-1/2	1/2	2	2	Display Label	2
7060800	6,000/600	1	8-1/2	1-1/2	3	2	Display Label	2
<b>Chrome Finish</b>								
7060600	6,000/600	1	8-1/2	1-1/2	3	2	Display Label	2





### STANDARD CLASS III/IV FORGED BALL MOUNTS - SOLID SHANK

- Solid one-piece forged construction
- 1 in. thick x 3 in. wide ball platforms
- Angle cut design for quick load and removal
- Metal Shield® finish resists rust and corrosion

Part Number	Rating GTW/TW (lbs.)	Ball Hole Size (in.)	A Length (in.)	B Rise (in.)	C Drop (in.)	Receiver Opening (in.)	Packaging	Master Carton
21330	16,000/1,600	1-1/4	9-1/2	1	2	2	Display Label	2
21331	16,000/1,600	1-1/4	10	2	4	2	Display Label	2
21332	16,000/1,600	1-1/4	10-1/2	3	6	2	Display Label	2



### STANDARD CLASS V HEAVY DUTY BALL MOUNTS

- Metal Shield® finish resists rust and corrosion

Part Number	Rating GTW/TW (lbs.)	Ball Hole Size (in.)	A Length (in.)	B Rise (in.)	C Drop (in.)	Receiver Opening (in.)	Packaging	Master Carton
7028100	14,000/1,400	1-1/4	-	1-1/2	3	2-1/2	Display Label	2
7028200	13,000/1,300	1-1/4	-	3-1/2	5	2-1/2	Display Label	1
7089500	21,000/2,100	1-1/4	-	2	4	3	Display Label	1
7089600	21,000/2,100	1-1/4	-	4	6	3	Display Label	1
7089700	21,000/2,100	1-1/4	-	6	8	3	Display Label	1
7089800	21,000/2,100	1-1/4	-	8	10	3	Display Label	1
7063200	14,000/1,400	1-1/4	-	1-1/2	3	2-1/2	Display Label	2
7063300	13,000/1,300	1-1/4	-	3-1/2	5	2-1/2	Display Label	2

Note: 7063200 & 7063300 interlock



### STANDARD DUAL-BALL MOUNTS

- Lifetime limited warranty
- Metal Shield® finish resists rust and corrosion

Part Number	Description	Rating GTW/TW (lbs.)	Length (in.)	Ball Size (in.)	Receiver Opening (in.)	Packaging	Master Carton
21511	Dual Ball Mount	2,000/200 6,000/600	10	1-7/8 2	2	Display Label	2
21518	Dual Ball Mount	6,000/600 6,000/600	10	2 2-2/16	2	Display Label	2

TRI-BALL MOUNTS



21514



7094300



STANDARD TRI-BALL MOUNTS

- Ideal for those with multiple trailers
- Lifetime limited warranty

Part Number	Description	Rating GTW/TW (lbs.)	Length (in.)	Ball Size (in.)	Receiver Opening (in.)	Packaging	Master Carton
<b>Metal Shield® Finish</b>							
7022400	Tri-Ball Mount	2,000/200	8	1-7/8	2	Display Label	2
		6,000/600		2			
7068800	Tri-Ball Mount	10,000/1,000	8-1/2	2-5/16	2-1/2	Display Label	1
		2,000/200		1-7/8			
21514	Tri-Ball Mount	10,000/1,000	8	2	2	Display Label	2
		14,000/1,400		2-5/16			
<b>Hollow Shank, Chrome Ball Finish</b>							
21514	Tri-Ball Mount	2,000/200	8	1-7/8	2	Display Label	2
		6,000/600		2			
7039800	Tri-Ball Mount	10,000/1,000	8	2-5/16	2	Display Label	2
		16,000/1,600		2-5/16			
<b>Solid Shank, Chrome Ball Finish</b>							
7094300	Tri-Ball Mount	2,000/200	8	1-7/8	2	Display Label	1
		10,000/1,000		2			
7094300	Tri-Ball Mount	16,000/1,600	8	2-5/16	2	Display Label	1
		10,000/1,000		2-5/16			

STANDARD TRI-BALL MOUNT WITH HOOK

- Ideal for those with multiple trailers
- Lifetime limited warranty



7095620

Part Number	Description	Rating GTW/TW (lbs.)	Length (in.)	Ball Size (in.)	Receiver Opening (in.)	Packaging	Master Carton
<b>Metal Shield® Finish</b>							
7031400	Tri-Ball Mount with Hook	2,000/200	8	1-7/8	2	Display Label	1
		6,000/600		2			
		10,000/1,000		2-5/16			
7095620	Tri-Ball Mount with Hook	1,000	8	Hook	2	Display Label	1
		2,000/200		1-7/8			
		6,000/600		2			
7095620	Tri-Ball Mount with Hook	10,000/1,000	8	2-5/16	2	Display Label	1
		1,000		Hook			

REESE® TACTICAL™ HOOK AND SHACKLE

- Perfect for working with tow hooks and lunette rings
- Lifetime limited warranty



7089300

Part Number	Description	Gross Trailer Weight (lbs.)	Length (in.)	Receiver Opening (in.)	Packaging	Master Carton
7089344	Hook and Shackle	10,000	-	2	Litho Box	1

21141



### CLASS III ADJUSTABLE WEIGHT-CARRYING BALL MOUNTS

- Quick release pin and clip for maximum adjustability
- Fits 2 in. square receiver tube opening
- Metal Shield® finish resists rust and corrosion

Part Number	Description	Rating GTW/TW (lbs.)	Length (in.)	Max Rise (in.)	Max Drop (in.)	Packaging	Master Carton
21141	Adjustable Weight Carrying Ball Mount	5,000/500	13-1/2	6-1/4	7-1/2	Litho Box	1
7031300	Adjustable Weight Carrying Ball Mount	5,000/500	13-1/2	6-1/4	7-1/2	Display Label	2

7089400



### REESE® TACTICAL™ ADJUSTABLE BALL AND CLEVIS UTILITY MOUNT

- Quick release pin and clip for maximum adjustability
- Fits 2 in. square receiver tube opening
- Matte black powder coat finish

Part Number	Description	Rating GTW/TW (lbs.)	Length (in.)	Max Rise (in.)	Max Drop (in.)	Total Travel	Packaging	Master Carton
7089444	Adjustable Ball and Clevis Utility Mount	7,500/750	13-1/2	5	7-1/4	12-1/4	Litho Box	1

### ROTATING HEIGHT ADJUSTABLE TRI-BALL MOUNT

The adjustable mount only takes a pull of the pin and a turn to get ready for towing with the most common hitch ball sizes. Just like you, it's always ready to get the job done.

- Height adjusts easily and securely with pins included
- Fits 2 in. receivers, rated up to 14,000 lbs. GTW
- Adjust height up to 10-1/2 in.
- Adjustable cast shank, knurled bolt pin
- Black powder coat finish resists corrosion

7068900



Part Number	Description	Length (in.)	Max Rise (in.)	Max Drop (in.)	Packaging	Master Carton
7068900	Adjustable Tri-Ball Ball Mount System with Step and 2" Square Shank <b>1-7/8" Ball</b> - 2,000 lbs. (GTW) <b>2" Ball</b> - 10,000 lbs. (GTW) <b>2-5/16" Ball</b> - 14,000 lbs. (GTW)	10	5-11/16	4-3/4	Litho Box	1
7021800	Adjustable Tri-Ball Ball Mount System with Step and 2" Square Shank <b>1-7/8" Ball</b> - 2,000 lbs. (GTW) <b>2" Ball</b> - 6,000 lbs. (GTW) <b>2-5/16" Ball</b> - 16,000 lbs. (GTW)	10	7	7	Display Label	1

7012800

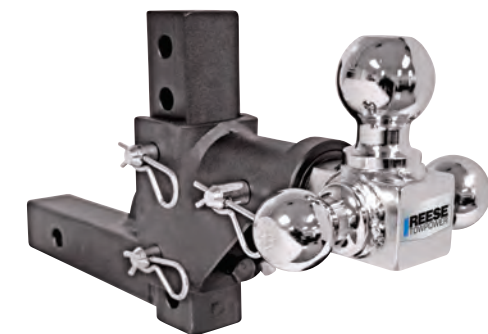

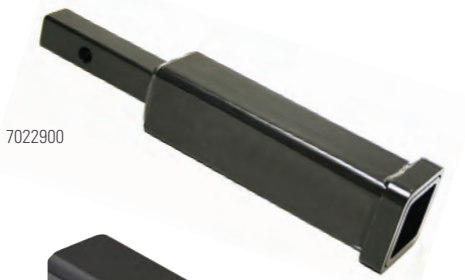

7022900



7052500



7088200



7090600



11021



11080



7060100

## RECEIVER HITCH ADAPTERS

- Enables one-size receivers to accept accessories designed for a different size receiver opening
- Metal Shield® resists rust and corrosion

Part Number	Description	Capacity (lbs.)	Length (in.)	Packaging	Master Carton
7020500	1-1/4" to 2" Receiver Adapter	3,500	6	Display Label	2
7022900	1-1/4" to 2" Receiver Adapter	3,500	10	Display Label	2
7052500	2" to 1/14" Receiver Adapter	3,500	7	Display Label	2
7028700	2-1/2" to 2" Receiver Adapter	-	6	Display Label	1
7088800	3" to 2-1/2" Receiver Adapter, Features 3/4" Pin Hole for HD Class V 4000 - 25k Receivers	-	5	Display Label	2
7088200	3" to 2-1/2" Receiver Adapter	-	10	Display Label	1
7090600	3" to 2" Receiver Adapter, Anti-Rattle J Pin Ready with Welded Collar	1,200	4	Display Label	1

## RECEIVER TUBES WITH COLLARS

- 2 in. square receiver tube opening
- Designed for use in fabricating under-car receiver hitches
- Welded stress ring

Part Number	Description	Length (in.)	Packaging	Master Carton
11021	2" Receiver Tube with Collar	12	Boxed	1
11080	2" Receiver Tube with Collar	6	Boxed	1

## DUAL HITCH EXTENSION

- 2 in. square receiver tube opening
- Carry your bikes or add a cargo tray while you tow
- Great for RV accessories
- Features two, 2 in. receivers
- Three 5/8 in. receiver pins required

Part Number	Description	Gross Trailer Weight (lbs.)	Tongue Weight (lbs.)	Packaging	Master Carton
7060100	Dual Hitch Extension	4,000	400	Display Label	2



### RECEIVER EXTENSIONS

- Ideal for slide-out campers with extended overhangs
- Designed to extend the receiver up to 18 in.
- 2 in. square tube opening for use with ball mounts and hitch-mounted accessories
- 3,500 lbs. weight carrying capacity

Part Number	Description	Weight Carrying (lbs.)	Weight Distribution (lbs.)	Length (in.)	Packaging	Master Carton
80307	Receiver Extension	3,500	-	8	Display Label	1
80305	Receiver Extension	3,500	-	14	Display Label	50
80306	Receiver Extension	3,500	-	18	Display Label	1

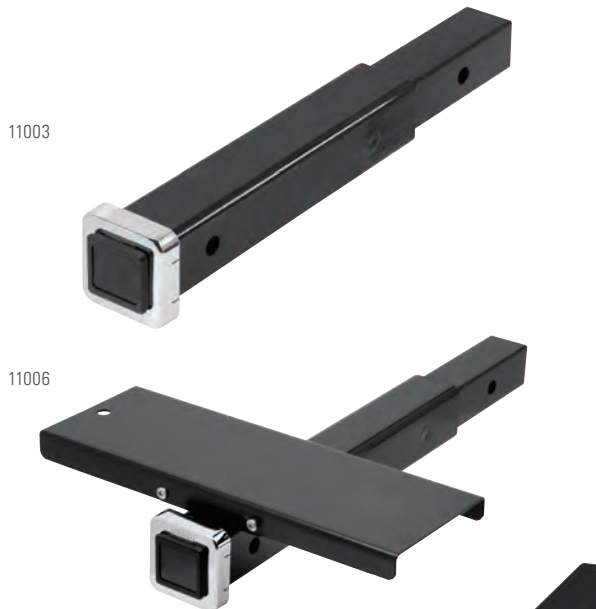

### HEAVY DUTY RECEIVER EXTENSIONS

- Ideal for slide-out campers with extended overhangs
- Designed to extend the receiver up to 18 in.
- 2 in. square tube opening for use with ball mounts and hitch-mounted accessories
- 4,000 lbs. weight carrying capacity
- 6,500 lbs. weight distribution capacity

Part Number	Description	Weight Carrying (lbs.)	Weight Distribution (lbs.)	Length (in.)	Packaging	Master Carton
11003	HD Receiver Extension	4,000	6,500	14	Display Label	1
11004	HD Receiver Extension	4,000	6,500	18	Display Label	1
11006	HD Receiver Extension with Step	4,000	6,500	18	Display Label	1



### 2-1/2 IN. RECEIVER EXTENSIONS

- Ideal for slide-out campers with extended overhangs
- Designed to extend the receiver up to 48 in.
- 2 in. square tube opening for use with ball mounts and hitch-mounted accessories
- For 2-1/2 in. receivers
- Integrated electrical bracket attached
- Up to 6,000 lbs. weight carrying capacity
- Up to 7,500 lbs. weight distribution capacity

Part Number	Description	Weight Carrying (lbs.)	Weight Distribution (lbs.)	Length (in.)	Packaging	Master Carton
45292	2-1/2" Receiver Extension	6,000 4,500	8,000 6,000	24 34	Display Label	1
45018	2-1/2" Receiver Extension	5,000 4,000	7,500 6,000	41 48	Display Label	1





74115



74116



7021600



7021700



74118

## 8 TON BALL AND PINTLE HOOK COMBINATIONS

- Heavy-duty forged steel
- Secure, effortless towing over rough terrain
- Mounting hardware included
- Metal Shield® finish resists rust and corrosion

Part Number	Ball Size (in.)	Ball Rating (lbs.)	Gross Trailer Weight (lbs.)	Max Vertical Load (lbs.)	Packaging	Master Carton
7411520	1-7/8	6,000	16,000	3,000	Litho Box	1
7411620	2	10,000	16,000	3,000	Litho Box	1
7411720	2-5/16	14,000	16,000	3,000	Litho Box	1
74115†	1-7/8	6,000	16,000	3,000	Litho Box	1
74116†	2	10,000	16,000	3,000	Litho Box	1
74117†	2-5/16	14,000	16,000	3,000	Litho Box	1

NOTE: 7411520, 7411620 and 7411720 are replacing 74115, 74116 and 74117.  
 † = Available while supplies last.

## PINTLE REPLACEMENT BALLS

- Chrome finish

Part Number	Description	Shank (in.)	Length (in.)	Capacity (lbs.)	Packaging	Master Carton
7021500	1-7/8" Replacement Ball	1-1/4	2-1/4	6,000	Display Label	6
7021600	2" Replacement Ball	1-1/4	2-1/4	10,000	Display Label	6
7021700	2-5/16" Replacement Ball	1-1/4	2-1/4	14,000	Display Label	6

## PINTLE HOOK

- Mounting hardware included
- Metal Shield® finish resists rust and corrosion

Part Number	Description	Gross Trailer Weight (lbs.)	Max Vertical Load (lbs.)	Packaging	Master Carton
74118	10-ton Pintle Hook	20,000	4,000	Litho Box	1
74119	15-ton Pintle Hook	30,000	6,000	Litho Box	1





74281

### PINTLE HOOK MOUNTING PLATES

- Solid shank
- Metal Shield® finish resists rust and corrosion

Part Number	Gross Trailer Weight (lbs.)	Shank Length (in.)	Plate Size (in.)	Receiver Opening (in.)	Packaging	Master Carton
74281	12,000	7-3/4	7-1/2 x 5	2	Display Label	2
45156	12,000	7-3/4	6 x 5	2-1/2	Display Label	2
45294	18,000	8-1/2	7-1/4 x 5	2-1/2	Litho Box	2
38186	25,000	9	9 x 5	3	Display Label	1



7013700

### LUNETTE RING

- 2-1/2 in. diameter
- 4 in. hole
- Mounting hardware sold separately
- Metal Shield® finish resists rust and corrosion

Part Number	Description	Gross Trailer Weight (lbs.)	Max Vertical Load (lbs.)	Packaging	Master Carton
7013700	Lunette Ring	42,000	4,000	Litho Box	1



4210

NOTE: Lunette ring not included

### PINTLE AND LUNETTE ACCESSORIES

Part Number	Description	Packaging	Master Carton
7044900	Pintle Pin and Chain, 1/4" Diameter Pin	Display Card	6
4210	Lunette Eye Lock, Fits 2-1/2" and 3" Lunette Eyes	Litho box	1



7024000

### RECEIVER MOUNT PINTLE BALL COMBO

- Solid Shank
- Includes snapper pin
- Fits 2 in. square receiver tube opening
- Metal Shield® finish resists rust and corrosion

Part Number	Description	Max GTW (lbs.)	Ball GTW (lbs.)	Max Vertical Load (lbs.)	Packaging	Master Carton
7024000	1-7/8" Receiver Mount Pintle Hook and Ball Combination	12,000	2,000	2,400	Display Label	2
7024100	2" Receiver Mount Pintle Hook and Ball Combination	12,000	7,000	2,400	Display Label	2
7024200	2-5/16" Receiver Mount Pintle Hook and Ball Combination	12,000	12,000	2,400	Display Label	2



7024300

### 5 TON RECEIVER MOUNT PINTLE HOOK

- Solid Shank
- Includes snapper pin
- Fits 2 in. square receiver tube opening
- Metal Shield® finish resists rust and corrosion

Part Number	Description	Max GTW (lbs.)	Ball GTW (lbs.)	Max Vertical Load (lbs.)	Packaging	Master Carton
7024300	5 Ton Receiver Mount Pintle Hook	10,000	-	2,000	Display Label	2



7024400

### FORGED RECEIVER MOUNT TOW HOOK

- Solid Shank
- Fits 2 in. square receiver tube opening
- Lifetime limited warranty
- Metal Shield® finish resists rust and corrosion

Part Number	Description	Max GTW (lbs.)	Length (in.)	Packaging	Master Carton
7024400	Tow Hook, Forged	10,000	7-3/8	Display Label	2



7024500

### FORGED RECEIVER MOUNT TOW EYE

- Solid Shank
- Fits 2 in. square receiver tube opening
- Lifetime limited warranty
- Metal Shield® finish resists rust and corrosion

Part Number	Description	Max GTW (lbs.)	Length (in.)	Packaging	Master Carton
7024500	Tow Ring, Forged	10,000	7-3/8	Display Label	2



8040900

### RECEIVER MOUNT CLEVIS

- 1 in. diameter hole
- Fits 2 in. square receiver tube opening
- Lifetime limited warranty
- Metal Shield® finish resists rust and corrosion

Part Number	Description	Gross Trailer Weight (lbs.)	Max Vertical Load (lbs.)	Packaging	Master Carton
8040900	Clevis Mount	6,000	600	Display Label	100



7089200

### REESE® TACTICAL™ CLEVIS AND HITCH BALL UTILITY MOUNT

- Reinforced recovery sleeve, use with tow straps for maximum security
- Fits 2 in. square receiver tube opening
- 5/8 in. pin diameter
- Lifetime limited warranty

Part Number	Description	Gross Trailer Weight (lbs.)	Max Vertical Load (lbs.)	Packaging	Master Carton
7089244	Clevis and Hitch Ball Utility Mount	7,500	750	Litho Box	1

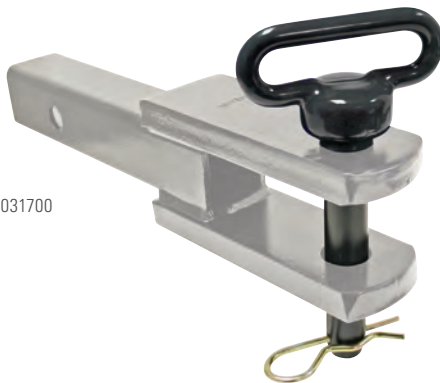

7031700

### RECEIVER MOUNT CLEVIS PIN

- Heat-treated Grade 8 steel
- Comfortable soft-grip handle
- Fits 2 in. square receiver tube opening
- Includes cotter pin
- 4-3/4 in. effective length

Part Number	Description	Packaging	Master Carton
7031700	Clevis Pin, 1" Diameter	Bulk	3



7024600

### RECEIVER MOUNT TOW RING

- Solid Shank
- Ring is zinc finished
- Fits 2 in. square receiver tube opening
- Metal Shield® finish resists rust and corrosion

Part Number	Description	Max GTW (lbs.)	Length (in.)	Packaging	Master Carton
7024600	Tow Ring	800	7-3/8	Display Label	2



7065500

### VEHICLE RECOVERY RINGS

- For multi-purpose pulling, hauling and recovery on and off road
- Alloy steel
- Proven military design
- Tested by independent and accredited labs
- Unique patent pending design
- 360° rotation, 180° pivot

Part Number	Description	Capacity (lbs.)	Length (in.)	Pin Opening (in.)	Receiver Opening (in.)	Packaging	Master Carton
7065500	Recovery Ring	10,000	13	5/8	2	Litho Box	1



7074000

### BALL MOUNT STORAGE

- Mountable in horizontal or vertical position
- Safe storage for ball mounts
- Prevent damage from loose bar
- Fits 2 in. ball mounts

Part Number	Description	Packaging	Master Carton
7074000	2" Ball Mount Storage	Display Label	3



7065000

### 3-WAY ATV HITCH

- Fits most ATVs
- Use a hitch ball, 5/8 in. clevis pin or tow hook
- 3/4 in. diameter ball shank hole
- Mounting hardware included
- Hitch ball sold separately

Part Number	Description	Gross Trailer Weight (lbs.)	Tongue Weight (in.)	Packaging	Master Carton
7065000	3-Way ATV Hitch	2,000	200	Litho Box	1
7065100	3-Way ATV Hitch	3,500	350	Litho Box	1



7065100

7074100



### BALL MOUNT BOOT BRUSH

- Attaches to existing ball mount
- Remove sand, grass, dirt and mud
- Allows towing while installed
- Long-lasting heavy-duty fiber brush and high-strength aluminum alloy scraper mounted to a high-impact modular platform
- Mounts to standard and Interlock® 2 in. ball mounts
- Includes mounting hardware

Part Number	Description	Packaging	Master Carton
7074100	Ball Mount Boot Brush, Stainless Steel Mounting Hardware Included	Litho Box	1

7060200



### TOW & GO HITCH STEP

- Attaches to existing ball mount
- Slip-resistant tread surface with raised edges, stays in place while you tow
- Durable high-grade aluminum alloy with black powder-coat finish for extended durability
- Extends reach for mini vans, suvs or trucks
- One-tool assembly; no drilling required
- Mounts to standard and Interlock® 1-1/4 in. and 2 in. ball mounts
- Supports 500 lbs.
- Includes mounting hardware and adapter

Part Number	Description	Packaging	Master Carton
7060200	Tow and Go Hitch Step, Stainless Steel Mounting Hardware and Adapter Included	Litho Box	2

7065300



### TOW & GO LIGHTED HITCH STEP

- Attaches to existing ball mount
- Easily connects into OEM vehicle's wiring system via US car OEM style plug-in harness
- Ultra bright LEDs illuminate the area behind the vehicle for increased operational visibility during the trailer hook up or backing up at night
- Three function switch for operating different lighting features
- One-tool assembly; no drilling required
- Mounts to standard and Interlock® 2 in. ball mounts
- Includes mounting hardware and adapter

Part Number	Description	Packaging	Master Carton
7065300	Tow and Go Lighted Hitch Step with LEDs, Stainless Steel Mounting Hardware and Adapter Included	Litho Box	2



Ultra Bright LEDs



HITCH PINS AND CLIPS

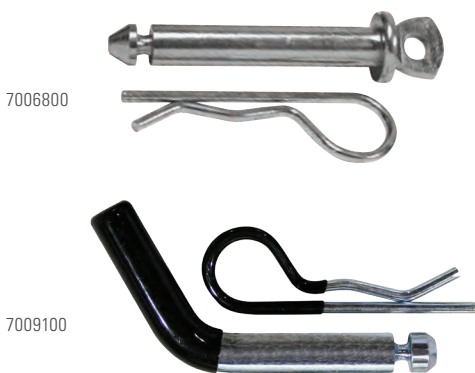

**CLASS I/II HITCH PINS AND CLIPS**

- Bright zinc finish

Part Number	Description	Pin Diameter (in.)	Receiver Opening (in.)	Span (in.)	Packaging	Master Carton
7006800	Tethering Eyelet	1/2 and 5/8	1-1/4 and 2	3	Plastic Shroud	6
7009100	Comfort Grip	1/2	1-1/4	2-1/4	Plastic Shroud	12
7010600	Clip Groove	1/2	1-1/4	2-1/4	Plastic Shroud	12
7021300	3-pack clip, vinyl coated				Display Label	12



**CLASS III/IV HITCH PINS AND CLIPS**

- Bright zinc finish

Part Number	Description	Pin Diameter (in.)	Receiver Opening (in.)	Span (in.)	Packaging	Master Carton
7006800	Tethering Eyelet	1/2 and 5/8	1-1/4 and 2	3	Plastic Shroud	6
7009200	Comfort Grip	5/8	2	3	Plastic Shroud	12
7010500	Clip Groove	5/8	2	3	Plastic Shroud	12
7063930	Rugged Pin Hole	5/8	2	3	Bulk	12



**CLASS V HITCH PINS AND CLIPS**

Part Number	Description	Pin Diameter (in.)	Receiver Opening (in.)	Span (in.)	Packaging	Master Carton
<b>Bright Zinc Finish</b>						
7033100	Clip Groove	5/8	2 and 2-1/2	3-1/2	Plastic Shroud	6
7057730	Rugged Pin Hole	5/8	2 and 2-1/2	3-1/2	Display Card	6
7081600	Ergo Clip	3/4	2, 2-1/2 and 3	4	Plastic Shroud	3
<b>REESE® Tactical™ Matte Black Finish</b>						
7090200	Pull-Pin Clip	5/8	2 and 2-1/2	3-1/2	Plastic Shroud	3
7092100	Pull-Pin Clip	5/8	2 and 2-1/2	3-1/2	Bulk	3



### SWIVEL LATCH PINS

- Bright zinc finish

Part Number	Description	Pin Diameter (in.)	Receiver Opening (in.)	Span (in.)	Packaging	Master Carton
7014500	Lock Included	5/8	2	3	Plastic Shroud	6
7021200	Sleeved, Lock Included	1/2 and 5/8	1-1/4 and 2	3	Plastic Shroud	6
7006700	Sleeved, Lock Not Included	1/2 and 5/8	2	3	Plastic Shroud	6
7007100	Lock Not Included	5/8	2	3	Plastic Shroud	6

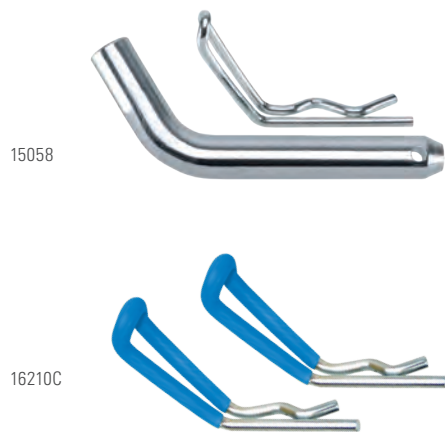

### ERGO CLIPS® HITCH PIN AND CLIP

- Unique design, better clearance
- Ergonomic design for easier installation
- High-visibility blue comfort grips
- Clips are 0.148 in. wire diameter
- Bright zinc finish

Part Number	Description	Pin Diameter (in.)	Receiver Opening (in.)	Span (in.)	Packaging	Master Carton
15058	Rugged Clip Hole	5/8	2	3	Display Card	10
16210C	Vinyl Dipped Clips	-	-	-	Clamshell	10



### BENT PIN RECEIVER LOCKS

- Flat key design, keys can be copied by most retailers
- Includes 2 keys and vinyl lock cover
- Bright zinc finish

Part Number	Description	Pin Diameter (in.)	Receiver Opening (in.)	Span (in.)	Packaging	Master Carton
7006400	Bent Pin Receiver Lock	1/2	1-1/4	2-1/4	Plastic Shroud	3
7006500	Bent Pin Receiver Lock	5/8	2 and 2-1/2	3-1/2	Plastic Shroud	3
7006000	Bent Pin Push-Button Receiver Lock	1/2 and 5/8	1-1/4 and 2	3	Plastic Shroud	3
7006100	Ben Pin Push-Button Receiver/Coupler Lock Combo	1/2 and 5/8	1-1/4 and 2	3	Plastic Shroud	3

RECEIVER LOCKS



PROFESSIONAL CLASS III/IV LOCKS

- Heavy-duty steel design
- Security for ball mounts and hitch-mounted accessories
- Square key pick proof design

Part Number	Description	Pin Diameter (in.)	Receiver Opening (in.)	Style	Span (in.)	Packaging	Master Carton
<b>Stainless Steel Finish</b>							
7030200	Receiver Lock	5/8	2	Dogbone	3	Plastic Shroud	3
<b>Chrome Finish</b>							
7030300	Receiver Lock	5/8	2	Dogbone	3	Plastic Shroud	3
7030400	Receiver Lock	5/8	2	Bent	3	Plastic Shroud	3
7030600	Receiver and Coupler Lock, Keyed Alike	5/8	2	Dogbone	3	Plastic Shroud	3
7070800	Receiver Lock	1/2 and 5/8	2	Sleeved	3	Plastic Shroud	3
7030500	Coupler Lock	-	-	-	3	Plastic Shroud	3



PROFESSIONAL CLASS V LOCKS

- Heavy-duty steel design
- Security for ball mounts and hitch-mounted accessories
- Chrome finish

Part Number	Description	Pin Diameter (in.)	Receiver Opening (in.)	Span (in.)	Packaging	Master Carton
7070700	Receiver Lock	5/8	2 and 2-1/2	3-1/2	Plastic Shroud	3
7081500	Receiver Lock	5/8 and 3/4	2, 2-1/2 and 3	4	Plastic Shroud	3



EASY ACCESS II LOCKS

- Swivel head for convenient front access
- Durable black cover
- Easier access

Part Number	Description	Pin Diameter (in.)	Receiver Opening (in.)	Span (in.)	Packaging	Master Carton
<b>Stainless Steel Finish</b>						
7057030	Sleeved Receiver Lock	1/2 and 5/8	2 and 2-1/2	2-7/8	Display Card	3
7057130	Class V Receiver Lock	5/8	2 and 2-1/2	3-1/2	Display Card	3
7057330	Adjustable Coupler Lock	3/16	-	3	Display Card	3
<b>Chrome Finish</b>						
7054630	Sleeved Receiver Lock	1/2 and 5/8	1-1/4 and 2	2-7/8	Display Card	3
7054430	Bent Pin Receiver Lock	1/2 and 5/8	1-1/4 and 2	2 and 2-7/8	Display Card	3
7057230	Class V Receiver Lock	5/8	2 and 2-1/2	3-1/2	Display Card	3
7057830	Class V Bent Pin Lock	5/8	2 and 2-1/2	3-1/2	Display Card	3
7057430	Adjustable Coupler Lock	3/16	-	3	Display Card	3
<b>Chrome and Stainless Steel Finish</b>						
7054530	Bent Pin Receiver and Coupler Lock	1/2 and 5/8	1-1/4 and 2	2 and 2-7/8	Display Card	3



### EASY ACCESS LOCKS - ROTATING HEAD

- 360° rotating head for easy lock access
- Integrated key slot cover helps protect lock from dirt
- Chrome finish

7009300



Part Number	Description	Pin Diameter (in.)	Receiver Opening (in.)	Span (in.)	Packaging	Master Carton
7009300	Sleeved Receiver Lock	1/2 and 5/8	1-1/4 and 2	-	Plastic Shroud	3
7031500	Adjustable Coupler Lock	3/16	-	1 and 2-7/8	Plastic Shroud	3

### BARREL STYLE LOCKS

- Push-button lock mechanism
- Rubber cap keeps dirt out

7005600



Part Number	Description	Pin Diameter (in.)	Receiver Opening (in.)	Span (in.)	Packaging	Master Carton
<b>Chrome Finish</b>						
7005600	Sleeved Dog Bone Receiver Lock	1/2 and 5/8	1-1/4 and 2	3	Plastic Shroud	3
7010200	Sleeved Dog Bone Coupler Lock	1/2 and 5/8	1-1/4 and 2	3	Plastic Shroud	3
7033300	Bent Pin Receiver Lock	5/8	2 and 2-1/2	3-1/2	Plastic Shroud	6
7033200	Dog Bone Receiver Lock	5/8	2-1/2	3-1/2	Plastic Shroud	6
7081400	Sleeved Dog Bone Receiver Lock	5/8 and 3/4	2, 2-1/2 and 3	4	Plastic Shroud	3
7039100	Sleeved Dog Bone Receiver Lock	1/2 and 5/8	1-1/4 and 2	3	Plastic Shroud	3
<b>Stainless Steel Finish</b>						
7010100	Sleeved Dog Bone Receiver Lock	1/2 and 5/8	1-1/4 and 2	3	Plastic Shroud	3
<b>Black Nickel Finish</b>						
7039000	Sleeved Dog Bone Receiver Lock	1/2 and 5/8	1-1/4 and 2	3	Plastic Shroud	3
<b>REESE® Tactical™ Matte Black Finish</b>						
7092330	Dog Bone Receiver Lock	5/8	2 and 2-1/2	3-1/2	Plastic Shroud	3

7033300



7039000



7039100



7092300



COUPLER LOCKS



7088300

HEAVY-DUTY UNIVERSAL COUPLER LOCK

- 5/8 in. hexagonal steel lock bar provides superior strength
- Guards against trailer tow-away theft
- Virtually pick-proof square key design
- Works with all coupler styles

Part Number	Description	Coupler Size (in.)	Packaging	Master Carton
7088300	Heavy-Duty Die Cast Aluminum Coupler Lock	1-7/8, 2 and 2-5/16	Plastic Shroud	3



7066900

PROFESSIONAL UNIVERSAL COUPLER LOCK

- Heavy-duty die-cast aluminum design
- Ratchet design with 11 locking positions
- Square key virtually eliminates lock picking
- Provides security for trailer when in storage
- Works with all coupler styles

Part Number	Description	Coupler Size (in.)	Packaging	Master Carton
7066900	Heavy-Duty Die Cast Aluminum Coupler Lock	1-7/8, 2 and 2-5/16	Plastic Shroud	2



72783

UNIVERSAL TRAILER COUPLER LOCKS

- Ratchet design with 11 locking positions
- Provides security for trailer when in storage

Part Number	Description	Coupler Size (in.)	Packaging	Master Carton
72783	Heavy-Duty Die Cast Aluminum Trailer Coupler Lock	1-7/8, 2 and 2-5/16	Plastic Shroud	3
55003	Heavy-Duty Die Cast Aluminum Trailer Coupler Lock, Keyed Alike	1-7/8, 2 and 2-5/16	Display Label	1



7006600

TRAILER COUPLER LOCKS

- Fits most couplers
- Flat key design
- Keeps coupler secure
- Patented design
- 1 year limited warranty

Part Number	Description	Span (in.)	Packaging	Master Carton
7006600	Brass Plated Trailer Coupler Lock	-	Plastic Shroud	3
7005300	Brass Plated Trailer Coupler Lock	5/8 to 1	Plastic Shroud	6
7005800	Stainless Steel Trailer Coupler Lock	5/8 to 1	Plastic Shroud	6
7042100	Brushed Silver Trailer Coupler Lock	5/8 to 3	Plastic Shroud	3



7005800





7014700

### TOW AND STORE ANTI-THEFT LOCK KIT

- Kit includes:
  - Universal coupler lock (72783)
  - Brass coupler lock (7005300)
  - Dual bent pin lock for both 1/2 in. and 5/8 in. receivers (7006000)
- Keyed alike
- Two flat keys

Part Number	Description	Packaging	Master Carton
7014700	Tow and Store Anti-Theft Lock Kit	Plastic Shroud	2



63251

### FIFTH WHEEL KING PIN LOCK

- Durable extruded T6 tempered aluminum body
- Maximum security for all king pins
- Bright yellow for visibility
- Includes 2 keys

Part Number	Description	Packaging	Master Carton
63251	Fifth Wheel King Pin Lock	Litho Box	12



7031600

### EASY ACCESS RECEIVER LOCK AND CABLE

- Sleeved receiver lock
- Converts 1/2 in. to 5/8 in. diameter
- Lock works with or without cable
- 360 degree head turn for easy access
- Fully removable cable

Part Number	Description	Packaging	Master Carton
7031600	Chrome Sleeved Dog Bone Receiver Lock and Cable with 360 Degree Rotating Head, 3" Span	Display Card	3



7033830

### HEAVY-DUTY SPARE TIRE CABLE LOCK

- 5/16 in. diameter x 4 ft.
- Vinyl-coated braided cable with looped ends
- 40mm chrome laminated lock
- Two flat keys
- Security for ladders, utilities, spare tires, tools

Part Number	Description	Packaging	Master Carton
7033830	5/16" x 4' Security Cable and 40mm Chrome Laminated Steel Padlock	Display Bag	3

RECEIVER TUBE COVERS



7074630

**SPRING-LOADED HITCH COVER**

- Fits most 2 in. receiver openings
- Stays in place while you tow, anti-rattle design
- Spring-loaded cover keeps opening free from debris

Part Number	Description	Packaging	Master Carton
7074630	Spring-Loaded Hitch Cover	Display Card	3



7000600

**RECEIVER TUBE COVERS**

- Durable and weatherproof
- No tools required

Part Number	Description	Packaging	Master Carton
74514	Tethered Rubber Tube Cover with 4-Way Flat Holder, Fits 2" Receivers	Display Card	6
7000600	Plastic Tube Cover, Fits 2" Receivers	Display Card	4
7051500	Plastic Tube Cover, Fits 1-1/4" Receivers	Display Card	4



86061

**LIGHTED RECEIVER TUBE COVERS**

REESE® Towpower offers a variety of LED-lighted hitch covers that provide low illumination with taillights on and high illumination when the brakes are applied. When not illuminated, the hitch cover is in the standard vehicle logo colors. This is a great way to customize your ride with a different look than the other vehicles on the road. Our logo hitch covers are fully licensed and ready to shine. Unique one-of-a-kind lighted hitch covers display standard logos at daytime, then glow at night.

- Fits 1-1/4 in. and 2 in. hitches
- Long life: LED light powered
- Low illumination with tail lights, high illumination with brakes
- Officially licensed and patented
- Plug & Play features allows for quick and easy installation



86065



86530



86531

Part Number	Description	Packaging	Master Carton
<b>Chrome Finish</b>			
86061	GMC Lighted Tube Cover	Display Card	3
86062	Chevrolet Bow Tie Lighted Tube Cover	Display Card	3
86065	Ford Lighted Tube Cover	Display Card	3
86066	RAM Lighted Tube Cover	Display Card	3
86523	Skull Lighted Tube Cover	Display Card	3
<b>Black Finish</b>			
86530	Chevrolet Bow Tie Lighted Tube Cover	Display Card	3
86532	Ford Lighted Tube Cover	Display Card	3
86531	RAM Lighted Tube Cover	Display Card	3
86529	Skull Lighted Tube Cover	Display Card	3



7013100

### HITCH BALL COVER

- Includes a 4-way flat wiring mounting pocket
- Prolong life of hitch ball
- Prevents accidental grease stains on hands and clothing
- Durable black vinyl

Part Number	Description	Packaging	Master Carton
7013100	Hitch Ball Cover, Fits 1-7/8" and 2" Balls	Display Card	6



74342

### HITCH BALL WRENCHES

The REESE® Towpower hitch ball wrench simplifies the process of tightening hitch ball nuts. A long handle provides leverage for torquing. It can be used by itself when tightening a REESE® Towpower Interlock® hitch ball to an Interlock® ball mount.

- Vinyl coating protects against rust
- Chrome finish

Part Number	Description	Wrench Ends (in.)	Length (in.)	Packaging	Master Carton
7073930	Collapsible Hitch Ball Wrench	1-1/2 and 1-7/8	11-1/2	Display Label	2
74342	Hitch Ball Wrench	1-1/8 and 1-1/2	19	Display Label	5



58117

### HITCH BALL LUBRICANT

- Water resistant, helps fight corrosion
- Reduces coupler and ball wear

Part Number	Description	Packaging	Master Carton
58117	Hitch Ball Lubricant, 4 oz. Jar	Jar	12



58109

58184

### HITCH BALL BUSHINGS

- Allows smaller shank hitch balls to be used with ball mounts with larger shank holes

Part Number	Description	Packaging	Master Carton
58109	Reduces from 1" to 3/4"	Clamshell	6
58184	Reduces from 1-1/4" to 1"	Clamshell	6



7012900

### SOLO HITCH ALIGNMENT SYSTEM

- Convenient one-person hitch alignment system
- Magnetic base for fast, easy location
- Rods adjust up to 42 in.
- Align trailer and hitch on first attempt
- Bright optic yellow balls

Part Number	Description	Packaging	Master Carton
7012900	Solo Hitch Alignment System	Clamshell	3

DISCONTINUED PRODUCTS

**LAST CHANCE**

**HITCH BALLS**

Part Number	Finish	Ball Diameter (in.)	Shank Diameter (in.)	Shank Length (in.)	Capacity (lbs.)	Packaging	Master Carton
74024 †	Chrome	1-7/8	1	3-1/4	2,000	Litho Box	3
74008 †	Chrome	2	3/4	1-1/2	3,500	Litho Box	3



7086100

**LAST CHANCE**

**DUAL-BALL MOUNTS**

Part Number	Description	Rating GTW/TW (lbs.)	Length (in.)	Ball Size (in.)	Receiver Opening (in.)	Packaging	Master Carton
7086100 †	Dual Ball Mount	10,000/1,000 16,000/1,600	10	2 2-5/16	2	Display Label	2

† = Available while supplies last

NOTES

Lined area for notes, consisting of multiple horizontal dashed lines.





# ELECTRICAL WIRING

Trailers require electrical hook-ups that make towing safer for you and others on the road. In fact, while each state has its own laws and regulations governing everything from size limits to weight restrictions, the one thing they all have in common is that your trailer must be wired for tail lights, brake lights and turn signals. This is accomplished by connecting your trailer to your vehicle's electric system.

Unfortunately, not all trailer electrical wiring is compatible with the wires of your car, truck, van or SUV. Fortunately, REESE® Towpower manufactures a full line of trailer electrical components for everything you need to get your trailer lights up and running for safe towing. We manufacture T-Connectors, wiring converters, wiring connectors, adapters, brake controls and more to make towing safe for you and the drivers around you. Best of all, our products install quickly and easily with simple do-it-yourself instructions.

<b>T-CONNECTORS</b> .....	C-3
Application Guide .....	A-11 - A-84

<b>TAIL LIGHT CONVERTERS</b>	
Power Module Information .....	C-4
Standard Converter .....	C-5
Powered Converter .....	C-5
Heavy Duty Powered Converter .....	C-5
Heavy Duty Powered Plus Converter .....	C-6
ModuLite® ZCI™ .....	C-6
Wiring Kit .....	C-6

<b>WIRE HARNESSES</b>	
4-Way .....	C-7 - C-9
5-Way .....	C-9
6-Way .....	C-10
7-Way .....	C-11 - C-13

<b>BREAKAWAY SYSTEMS</b> .....	C-14
--------------------------------	------

<b>ELECTRICAL ACCESSORIES</b>	
Junction Boxes .....	C-15 - C-16
Wiring and Hardware Components .....	C-16
Electrical and Circuit Testers .....	C-16
Vehicle and Trailer Adapters .....	C-17 - C-19

# FEATURED

## MODULITE® ZCI™ - (ZERO CONTACT INTERFACE)

- Snap, Don't Snip™ – No cutting or splicing vehicle wiring!
- Our ZCI™ sensors easily snap over wires to detect an electrical current and engage trailer lights -- crucial for high-end vehicles with complex wiring in which snipping, cutting, or splicing voids the vehicle's electrical system warranty.
- Have a leased vehicle? The ZCI™ is easy to remove without leaving any permanent damage. Take to your next vehicle with the same easy installation.
- See page C-6 for additional information



## T-CONNECTORS

- With more than 460 products covering 8,700 vehicle applications, REESE Towpower® is pleased to offer the widest coverage of T-Connectors in the industry.
- Benefits of our REESE Towpower® T-Connectors include:
  - "Factory" appearance
  - Quick and easy installation
  - Solid construction, built with our surface mount technology
  - Weatherproof connection when needed
  - No cutting, splicing or taping of vehicle wires
  - Includes ModuLite® or converter where needed
  - 16 gauge bonded wire with 4-Flat plug and integrated cap
- See application guide on page A-11 for vehicle specific applications



## 7-WAY BLADE TO 4-FLAT ADAPTER

- Easily adapt OEM 7-Way blade connector to basic 4-Flat connector
- Instantly checks electrical circuit for connectivity
- Displays connectivity using high-visibility LEDs
- U.S. Patent# D620,453S
- See page C-17 for additional information



## 7-WAY BLADE RV MOLDED CABLE

- 7-Way molded trailer connector with heavy-duty 7-Way insulated cable. Molded with encapsulated terminals and wires to form one weather-resistant, non-corrosive assembly.
- Heavy-duty construction and encapsulated molding
- Insulated 6 ft. cable protects wires from elements
- Easy OEM RV cable replacement
- See page C-13 for additional information





85262 -  
RAM 3500

## T-CONNECTORS

- With more than 460 products covering 8,700 vehicle applications, REESE Towpower® is pleased to offer the widest coverage of T-Connectors in the industry.
- Benefits of our REESE Towpower® T-Connectors include:
  - “Factory” appearance
  - Quick and easy installation
  - Solid construction, built with our surface mount technology
  - Weatherproof connection when needed
  - No cutting, splicing or taping of vehicle wires
  - Includes ModuLite® or converter where needed
  - 16 gauge bonded wire with 4-Flat plug and integrated cap
- See application guide on page A-11 for vehicle specific applications



8551000

## MULTI-PLUG T-CONNECTORS

- Ability to tow trailers with different style trailer connectors
- Durable plastic shell
- Weather tight seal
- See application guide for fit information

Part Number	Description	Packaging	Master Carton
8550900	7-Way/4-Flat Multi-Plug T-Connector	Clamshell	3
8551000	7-Way/4-Flat Multi-Plug T-Connector	Clamshell	3
74682	7-Way/4-Flat Multi-Plug T-Connector	Clamshell	3



1. Locate wiring position, see chart on page A-81



2. Unplug the tail light harness.



3. Route T-Connector to the tail light harness.



4. Plug the tail light into the T-Connector.



5. Re-secure the tail light and you're ready to tow!



NOTE: Some vehicles may require grounding and/or direct connection to the battery.

## POWERED TAIL LIGHT CONVERTERS ELIMINATE THE DRAIN ON YOUR VEHICLE'S ELECTRICAL SYSTEM

**With a Power Module** the additional power required to supply the trailer lights (represented by the red line) is supplied directly from the battery. Only a small amount of power is required from the fuse panel, turn signal switch, tail light harness and lamp out sensor, to signal when to illuminate the trailer lights.

**Without a Power Module** all the additional power required to supply the trailer lights pass through the vehicle's electrical system.

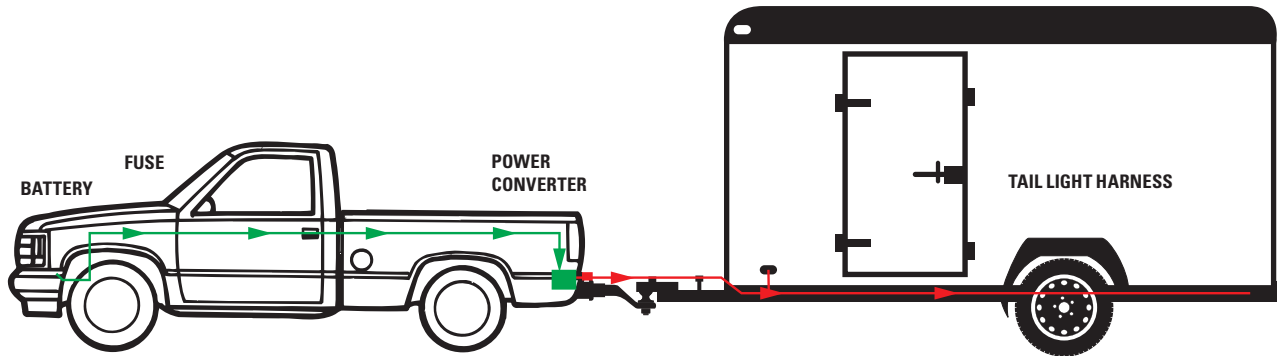

### TRAILER LIGHT POWER MODULES

- Virtually eliminates additional electrical draw on the vehicle's tail light circuits
- Ensures maximum trailer light brightness
- Powers the trailer's stop, turn, tail and running lights without overloading vehicle electrical systems
- Compatible with:
  - 2-Wire and 3-Wire systems
  - Multiplex
  - PWM
  - LED tail lights

### IDENTIFYING THE NEED FOR CONVERTER

- Today's vehicles have light gauge wire
- Computerized vehicle sensors monitor electrical current draw
- Without ModuLite® the sensors may give false readings
- Adding additional towing lights without converter may overload the system
- System problems and failure may occur without converter

### HOW IT WORKS

- Converter connects directly to vehicle's battery and powers the towing lights
- Converter provides from 2.1 to 16 amps of power per circuit to the trailer lights, depending on the unit

### INSTALLATION

Converter power modules typically install in 30 to 45 minutes depending on the ease of routing the power supply wire from the battery to the rear of the vehicle.

### WHEN YOU NEED CONVERTER

- Trailer has more than one light assembly per side and is equipped with multiple clearance or running lights
- If the tow vehicle may tow a variety of different trailers
- Vehicle is equipped with lamp out sensors or other electronic devices that could be damaged by voltage fluctuations
- Owners manuals caution against adding additional loads to electrical circuits

### AMP REQUIREMENTS - INCANDESCENT

Bulb Type	Candle Power	Rated Amps	Watts
57 - 1895	2	0.27	3.780
2057	32	2.10	26.880
	2	0.48	6.720
MR16	-	-	35
921	21	1.40	17.920
922	15	0.98	12.544
1141	21	1.44	18.432
93	15	1.04	13.312
105	12	1.07	13.696
1156	32	2.10	26.880
1157	32	2.10	26.880
	3	0.59	8.260
168	3	0.35	4.900
194	2	0.27	3.780

### AMP REQUIREMENTS- LED

Stop / Turn	Tail Light / License	SM / CL
0.3	0.05	0.05

## TAIL LIGHT CONVERTERS



8507900

## STANDARD TAIL LIGHT CONVERTER

- Adapts import and domestic vehicles with separate turn and stop lights (3-Wire system) to standard trailer tail light wiring (2-Wire system)
- Rated for up to 2.1 amps for Turn/Stop circuits and 5.6 amps for the tail light circuit
- Will work with most LED and incandescent/standard bulbs (vehicle and trailer) and with most vehicle multiplex systems for lighting
- Prevents feedback from the trailer to the vehicle system
- Integrated protective cover

Part Number	Description	Packaging	Master Carton
8507900	Standard Tail Light Converter with Circuit Protector	Clamshell	3



8551200

## POWERED TAIL LIGHT CONVERTER

- Draws power directly from vehicle's battery and uses less than 5 milliamps of the vehicle's circuit to sense the required functions and applies appropriate lighting to the trailer
- Works with most LED and incandescent/standard bulbs
- Rated for up to 2.1 amps for Turn/Stop circuits and 5.6 amps for the tail light circuit
- Tail Light circuit has been upgraded to work with vehicle's pulse width modulation (PWM), allowing the converter to turn on fully and give the trailer lights full brightness during activation
- This unit prevents feedback from the trailer to the vehicle system
- Can be used on a 2- or 3-Wire system
- Integrated protective cover

Part Number	Description	Packaging	Master Carton
8551200	Powered Tail Light Converter with Circuit Protector	Clamshell	2



8551300

## HEAVY-DUTY POWERED TAIL LIGHT CONVERTER KIT

- Draws power directly from vehicle's battery and uses less than 5 milliamps of the vehicle's circuit to sense the required functions and appropriate lighting to the trailer
- Works with most LED and incandescent/standard bulbs
- Rated for up to 5.0 amps for Turn/Stop circuits and 7.5 amps for the tail light circuit
- Tail light circuit has been upgraded to work with vehicle's pulse width modulation (PWM), allowing the converter to turn on fully and give the trailer lights full brightness during activation
- Works with most vehicles that have multiplex systems for lighting
- Use on a 2- or 3-Wire system
- Integrated protective cover

Part Number	Description	Packaging	Master Carton
8551300	Heavy-Duty Powered Tail Light Converter Kit with Integrated Circuit Protector	Clamshell	3





8551400

## HEAVY-DUTY PLUS POWERED TAIL LIGHT CONVERTER KIT

- Draws power directly from vehicle's battery and uses less than 5 milliamps of the vehicle's circuit to sense the required functions and appropriate lighting to the trailer
- Works with most LED and incandescent/standard bulbs
- Rated for up to 5.0 amps for Turn/Stop circuits and 7.5 amps for the tail light circuit
- Works with most vehicles that have multiplex systems for lighting
- Can be used on a 2- or 3-Wire system
- Includes integrated protective cover

Part Number	Description	Packaging	Master Carton
8551400	Heavy-Duty Plus Powered Tail Light Converter Kit with Integrated Circuit Protector	Clamshell	3



119250

## MODULITE® ZCI™ - (ZERO CONTACT INTERFACE)

- Snap, Don't Snip™ – No cutting or splicing vehicle wiring!
- Our ZCI™ sensors easily snap over wires to detect an electrical current and engage trailer lights -- crucial for high-end vehicles with complex wiring in which snipping, cutting, or splicing voids the vehicle's electrical system warranty.
- Have a leased vehicle? The ZCI™ is easy to remove without leaving any permanent damage. Take to your next vehicle with the same easy installation.

Part Number	Description	Packaging	Master Carton
119250	ModuLite ZCI (Zero Contact Interface)	Clamshell	3
119251	ModuLite ZCI (Zero Contact Interface) with Installation Kit	Litho Box	3



78103

## TAIL LIGHT CONVERTER WIRING KIT

- Includes: 20 ft. of wire, fuse holder, fuse, terminals and cable ties

Part Number	Description	Packaging	Master Carton
78103	Tail Light Converter Wiring Kit	Clamshell	3

## 4-FLAT CONNECTORS AND WIRING KITS



78115

78114

## 4-FLAT INSTA-PLUG CONNECTORS

- No slicing, no stripping, just close cover and screw down
- U.S. Patent # D617,284S

Part Number	Description	Packaging	Master Carton
78114	4-Flat Connector - Vehicle End with LED Circuit Tester and Dust Cover	Clamshell	3
78115	4-Flat Connector - Trailer End with LED Circuit Tester and Dust Cover	Clamshell	3
85353	4-Flat Connector Kit - Vehicle End and Trailer End with LED Circuit Tester and Dust Cover	Clamshell	3

## 4-FLAT VEHICLE END WIRING KITS

- 7.5 Amps / circuit, 18 gauge bonded wire, ground wire runs full length of assembly
- Conforms to SAE spec. J1128



20250

Part Number	Description	Packaging	Master Carton
85217	4-Flat Wiring Kit - Vehicle End, 12" with Splice Connectors and Built-in Dust Cover	Clamshell	3
20250	4-Flat Heavy-Duty Wiring Kit - Vehicle End, 144" with 4 Insulated Butt Connectors and Built-in Dust Cover, 16 Gauge	Clamshell	12
78058	4-Flat Wiring Kit - Vehicle End, 48" with Splice Connectors and Eyelet	Clamshell	6
118001	4-Flat Wiring Kit - Vehicle End, 48" with Splice Connectors	Clamshell	12
78090	4-Flat Wiring Kit - Vehicle End, 48" with LED and Built-in Dust Cover	Clamshell	6
74123	4-Flat Wiring Kit - Vehicle End, 60"	Clamshell	6
74051	4-Flat Wiring Kit - Vehicle End, 60" with Splice Connectors and HD Flasher #552	Clamshell	3
118002	4-Flat Wiring Kit - Vehicle End, 60" with Splice Connectors, LED Tester and Built-in Dust Cover	Clamshell	12
20252	4-Flat Heavy-Duty Wiring Kit - Vehicle End, 72" with Water-Tight Shrink Splice Connectors and Circuit Tester, 16 Gauge	Clamshell	12
85277	4-Flat Loop Wiring Kit - Vehicle End, 18" with Splice Connectors	Clamshell	6

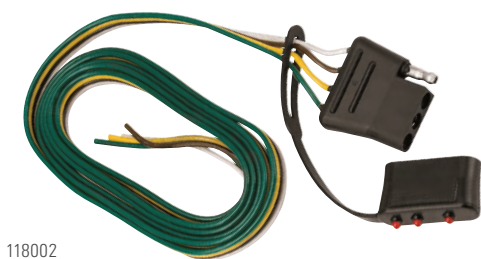

118002

## 4-FLAT TRAILER END WIRING KITS

- 7.5 Amps / circuit, 18 gauge bonded wire, ground wire runs full length of assembly
- Conforms to SAE spec. J1128

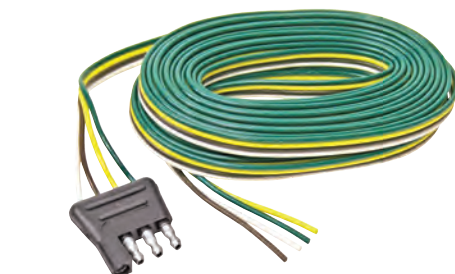

85275

Part Number	Description	Packaging	Master Carton
74124	4-Flat Wiring Kit - Trailer End, 12"	Clamshell	6
118033	4-Flat Wiring Kit - Trailer End, 48"	Clamshell	12
85275	4-Flat Wiring Kit - Trailer End, 24' with 2 Splice Connectors	Clamshell	3

## 4-FLAT WEATHERPROOF CONNECTORS

- Ergonomic weatherproof design with built-in "STRAIN RELIEF"
- Professional-grade jacketed cable over insulated 18 gauge wires



8550811

Part Number	Description	Packaging	Master Carton
8550811	4-Flat Connector - Trailer End, Y-Wishbone Harness, 20'	Clamshell	3
8551700	4-Flat Connector - Trailer End, 36"	Clamshell	3
8550511	4-Flat Connector - Vehicle End, 48"	Clamshell	3

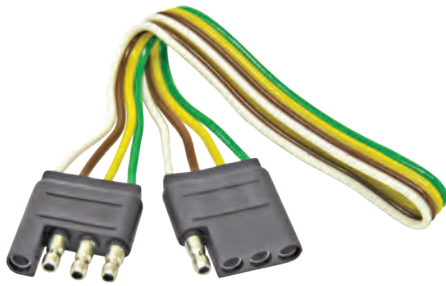

74687



8552600

### 4-FLAT CONNECTOR LOOP VEHICLE AND TRAILER ENDS

- Features 18 gauge bonded wire
- Conforms to SAE spec. J1128

Part Number	Description	Packaging	Master Carton
74687	4-Flat Connector - Vehicle and Trailer Ends, 12 in.	Clamshell	6
8552600	4-Flat Connector - Vehicle and Trailer Ends, 12" with LED Trailer Side	Clamshell	3
85307	4-Flat Connector - Vehicle and Trailer Ends, 18"	Clamshell	6
74684	4-Flat Connector - 24"	Clamshell	6
8552500	4-Flat Connector - 24" with LED	Clamshell	3
78091	4-Flat Connector - 36" with Eyelet	Clamshell	6
74689	4-Flat Connector - 48"	Clamshell	6
8552200	4-Flat Connector - 48" with 4 Slice Connectors	Clamshell	3
118044	4-Flat Connector - 48" with Splices	Clamshell	12
74125	4-Flat Connector - 60"	Clamshell	6
118045	4-Flat Connector - 60" with Splices	Clamshell	12
74636	4-Flat Connector - 24'	Clamshell	3



118192

### 4-FLAT TRAILER END WISHBONE CONNECTOR KITS

- 18 gauge split harness for running wires down each side of trailer
- Conforms to SAE spec. J1128

Part Number	Description	Packaging	Master Carton
78082	4-Flat Wishbone Connector Kit - Trailer End, 20' with Splice Connectors	Clamshell	3
74676	4-Flat Wishbone Connector Kit - Trailer End, 25' with Splice Connectors	Clamshell	3
8550811	4-Flat Wishbone Connector Kit - Trailer End, 20'	Clamshell	3
118192	4-Flat Wishbone Connector Kit - Trailer End, 25', Dual Tail Light	Clamshell	6



85211

### 4-FLAT VEHICLE END KNOCK-OUT WIRING KIT

- Mates with most standard 4-Way plugs
- 30 in. leads, integrated dust cover

Part Number	Description	Packaging	Master Carton
85211	4-Flat Knock-Out Wiring Kit - Vehicle End	Clamshell	3

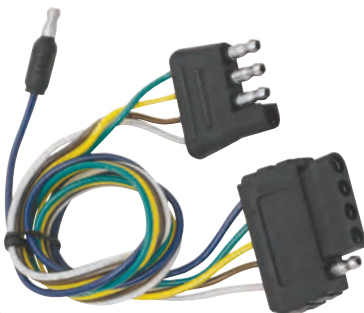

20136

### 4-FLAT TO 5-FLAT CONNECTOR KIT

- Allows convenient connection to multiple trailers
- Simple plug-in installation

Part Number	Description	Packaging	Master Carton
20136	4-Flat to 5-Flat Connector Kit	Clamshell	12

## 4-PIN CONNECTORS AND 5-FLAT CONNECTORS



85206

74613

## 4-PIN ROUND CHROME CONNECTORS

- 4-Pin round style set
- Features non-corroding brass pins
- Chrome-plated finish, zinc die-cast construction for durability

Part Number	Description	Packaging	Master Carton
85206	4-Pin Round Chrome Connector - Vehicle End	Clamshell	3
74613	4-Pin Round Chrome Connector - Trailer End	Clamshell	6
74131	4-Pin Round Chrome Connector Set - Vehicle and Trailer Ends	Clamshell	6

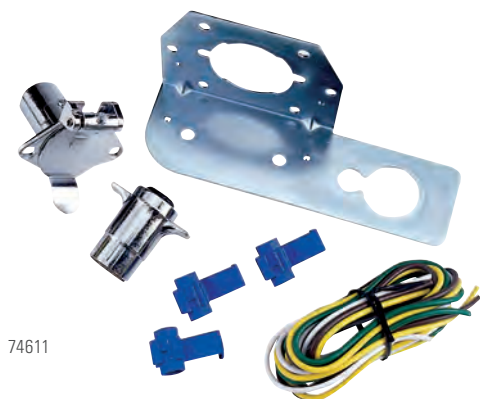

74611

## 4-PIN ROUND CONNECTOR KIT

- Complete 4-Pin round style kit
- Features non-corrosive chrome-plated connectors
- Includes 48 in. of each wire and 3 wire splices for easy installation

Part Number	Description	Packaging	Master Carton
74611	4-Pin Round Connector Kit - Vehicle and Trailer Ends, Mounting Bracket and Hardware Included	Clamshell	3

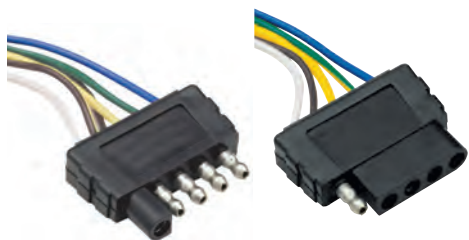

85214

85213

## 5-FLAT CONNECTORS

- Compatible with most standard 4-Flat plugs
- Includes fifth circuit for backup lights, surge brake lockouts or other low-amp 12V options, 7.5 Amps / circuit

Part Number	Description	Packaging	Master Carton
85213	5-Flat Connector - Vehicle End, 6'	Clamshell	6
85214	5-Flat Connector - Trailer End, 4'	Clamshell	6
85215	5-Flat Connector - Loop, 60"	Clamshell	6



855111

## 4-FLAT/5-FLAT/7-WAY BLADE VEHICLE END MULTI-PORT CONNECTOR

- Gasketed dust cap
- Glass fiber-reinforced nylon construction,
- Corrosion-resistant tin-plated terminals
- Wire-protecting strain relief

Part Number	Description	Packaging	Master Carton
855111	4-Flat/5-Flat/7-Way Blade Multi-Port Connector - Vehicle End	Clamshell	3



85342

DUAL PORT ROUND CONNECTOR  
4-FLAT TO 4-FLAT 6-PIN ROUND

- Dual port connectors convert vehicle 4-Flat to 2-Port flexibility
- Provides versatility in going from 4-Flat to 6-Pin round
- Sealed connection protects against moisture and corrosion
- Low-profile design provides factory installed appearance

Part Number	Description	Packaging	Master Carton
85342	Dual-Port Round Connector, 4-Flat to 4-Flat 6-Pin Round	Clamshell	3





85476



85477

### 6-PIN ROUND CONNECTORS

- Easy wire a 6-Pole connector
- Corrosion-resistant tin-plated contacts
- Snap-on strain relief terminal cover allows instant access to terminals
- Durable glass-reinforced nylon construction

Part Number	Description	Packaging	Master Carton
85476	6-Pin Round Connector - Vehicle End, Dust Cover, Mounting Bracket and Hardware Included	Clamshell	3
85477	6-Pin Round Connector - Trailer End	Clamshell	3
85479	6-Pin Round Connector Set - Vehicle and Trailer Ends, LED Circuit Tester. Dust Cover, Mounting Bracket and Hardware Included	Clamshell	3



74129

74130

### 6-PIN HEAVY-DUTY METAL ROUND CONNECTORS

- Non-corrosive zinc die-cast construction and non-corroding brass pins
- Built-in strain relief keeps wire secured to terminals
- Designed for 12 volt systems when pulling agricultural and livestock trailers

Part Number	Description	Packaging	Master Carton
74129	6-Pin Metal Round Connector - Vehicle End, Requires Mounting Bracket #74132	Clamshell	3
74130	6-Pin Metal Round Connector - Trailer End	Clamshell	6



74183

### 6-PIN METAL ROUND CONNECTOR

- Provides versatility in going from 4-Flat to 6-Pin round plug
- Extra wires for adding brake controls, backup or hot wire

Part Number	Description	Packaging	Master Carton
74183	6-Pin Metal Round Connector - Vehicle End	Clamshell	3



74608

### 6-PIN METAL ROUND CONNECTOR KIT

- Complete 6-Pin round-style kit
- Features non-corrosive 6-Pin vehicle connector and Zinc die-cast 6-Pin trailer connector
- Includes 48 in. of each wire, 5 wire splices, mounting bracket and hardware

Part Number	Description	Packaging	Master Carton
74608	6-Pin Metal Round Connector Kit - Vehicle and Trailer Ends	Clamshell	3



## 7-WAY BLADE CONNECTORS



8551511

## 7-WAY BLADE TWIST CONNECTOR

- Direct replacement for GM twist connector
- Heavy-duty stainless steel pin and spring resist rusting
- Gasket-sealed cap to reduce moisture and corrosion
- Durable reinforced nylon construction

Part Number	Description	Packaging	Master Carton
8551511	7-Way Blade Twist Connector - Vehicle End	Clamshell	3



85478

## 7-WAY BLADE CONNECTOR

- Easy-Wire 7-Way blade trailer connector
- Corrosion-resistant tin-plated contacts
- Strain relief protects wires from being pulled out
- Durable glass-reinforced nylon construction
- Patented

Part Number	Description	Packaging	Master Carton
85478	7-Way Blade Connector - Trailer End	Clamshell	3



85219

## 7-WAY BLADE OEM CONNECTOR

- Easily plugs 7-Way connector into factory-equipped car end socket harness on Ford, GM and Nissan vehicles
- Allows remote trailer wiring in pickup beds or other hard-to-access areas
- Durable plastic shell; weathertight, mounting bracket

Part Number	Description	Packaging	Master Carton
85219	7-Way Blade Connector - For OEM Wired Vehicle	Clamshell	3



85475

## 7-WAY BLADE CONNECTOR KIT

- Easy-Wire 7-Way blade vehicle connector
- Durable glass-reinforced nylon construction with corrosion-resistant tin-plated contacts
- Snap-on strain-relief cover for instant access to terminals

Part Number	Description	Packaging	Master Carton
85475	7-Way Blade Connector Kit - Vehicle End, Mounting Hardware and Bracket Included	Clamshell	3



20147

8550111

## 7-WAY BLADE WIRING KITS

- Easily upgrade your vehicle with a professional 7-Way Blade Connector
- Heavy-duty hinged dust cover with weather seal and corrosion-resistant terminals
- Plug directly into OEM socket with quick connect OEM-type pigtail socket

Part Number	Description	Packaging	Master Carton
8550111	7-Way Blade Wiring Kit - Vehicle End	Clamshell	3
20147	7-Way Blade Pigtail OEM Replacement Wiring Kit with Butt Connectors - Vehicle End	Clamshell	12



74682

### 7-WAY PRE-WIRED DUAL-PORT BLADE AND 4-FLAT CONNECTOR KIT

- Easily plugs 7-Way connector into factory vehicles - Ford, Dodge, GM, Lexus, Nissan and Toyota
- Allows remote trailer wiring in pickup beds or other hard-to-access areas

Part Number	Description	Packaging	Master Carton
74682	7-Way Pre-Wired Dual-Port Blade and 4-Way Flat Wiring Kit, Mounting Bracket Included	Clamshell	3



8536511

### 7-WAY BLADE HEAVY-DUTY WIRING KIT

- Heavy-duty hinged dust cover with weather seal with corrosion-resistant terminals
- Plug directly into OEM socket

Part Number	Description	Packaging	Master Carton
8536511	7-Way Blade Wiring Kit - Vehicle End, Mounting Bracket and Hardware Included	Clamshell	3



74126

118031

### 7-WAY RV BLADE CONNECTORS

- Non-corrosive thermoplastic construction with non-corroding brass and tin-plated terminals
- Weatherproof rear grommet and strain relief

Part Number	Description	Packaging	Master Carton
74126	7-Way RV Blade Connector - Vehicle End, Plastic	Clamshell	3
118030	7-Way RV Blade Connector - Vehicle End, Metal	Clamshell	8
74127	7-Way RV Blade Connector - Trailer End, Plastic	Clamshell	6
118031	7-Way RV Blade Connector - Trailer End, Metal	Clamshell	12

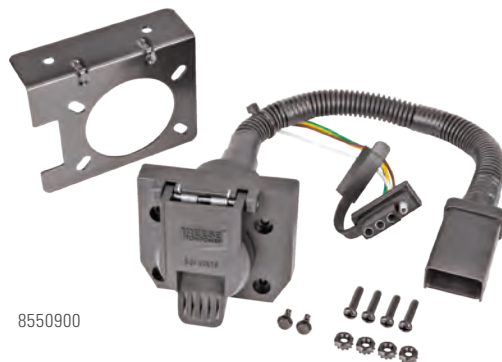

8550900

### 7-WAY PRE-WIRED OEM BLADE AND 4-FLAT CONNECTOR KITS

- Easily plugs 7-Way connector onto factory vehicles
- For quick connection to 4-Flat or 7-Way trailer connectors
- Includes mounting bracket and hardware
- Easily adapts to existing vehicle 7-Way plug
- Ability to tow trailers with different style trailer connectors
- Durable plastic and weathertight seal

Part Number	Description	Packaging	Master Carton
8550900	7-Way Pre-Wired OEM Blade and 4-Flat Connector Kit - Chrysler, Dodge, Freightliner, Jeep and Mitsubishi	Clamshell	3
8551000	7-Way Pre-Wired OEM Blade and 4-Flat Connector Kit - Toyota and Lexus	Clamshell	3

## 7-WAY BLADE AND 7-PIN CONNECTORS



8549100

## 7-WAY BLADE RV MOLDED CABLE

- 7-Way molded trailer connector with heavy-duty 7-Way insulated cable. Molded with encapsulated terminals and wires to form one weather-resistant, non-corrosive assembly.
- Heavy-duty construction and encapsulated molding
- Insulated 6 ft. cable protects wires from elements
- Easy OEM RV cable replacement

Part Number	Description	Packaging	Master Carton
8549100	7-Way Blade RV Molded Cable - Trailer End, 6'	Display Card	3



74184

## 7-WAY PRE-WIRED BLADE CONNECTOR

- Provide versatility in going from 4-Flat to 7-Way standard plug
- Extra wires for adding brake controls, back-up or hot wire

Part Number	Description	Packaging	Master Carton
74184	7-Way Pre-Wired Blade Connector - Vehicle End, Plastic	Clamshell	3

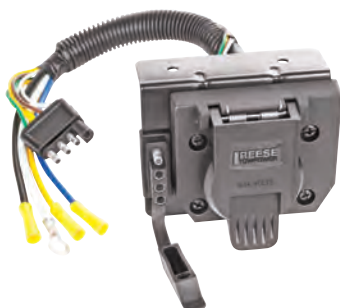

85343

## 7-WAY DUAL-PORT BLADE CONNECTOR AND 4-FLAT TO 4-FLAT CONNECTOR

- Simple wiring converts vehicle 4-Flat to 2-port flexibility
- Sealed connection increases protection against moisture and corrosion

Part Number	Description	Packaging	Master Carton
85343	7-Way Dual Port Blade Connector and 4-Flat to 4-Flat Connector	Clamshell	3



85209

## 7-WAY RV BLADE CONNECTOR KIT

- Kit includes:
  - 7-Way vehicle end
  - 7-Way trailer end
  - Standard 7-Way bracket and wire

Part Number	Description	Packaging	Master Carton
85209	7-Way RV Blade Connector Kit - Vehicle and Trailer Ends	Clamshell	3



8549711

## 7-PIN ROUND CONNECTORS WITH CABLE PROTECTOR

- Weathertight design ideal for extreme conditions
- Corrosion-resistant tin-plated terminals
- Strain-relief spring protects cable
- Rated for 40 Amps continuous duty @ 6-28 VDCs
- Interchangeable with all competitive makes

Part Number	Description	Packaging	Master Carton
8549411	7-Pin Round Connector with Cable Protector - Trailer End	Clamshell	3
8549711	7-Pin Round Connector with Cable Protector - Vehicle End	Clamshell	3

8549411



50-85-320

### PUSH TO TEST BREAKAWAY SYSTEMS

This REESE® Towpower trailer breakaway system features a push-to-test button that instantly indicates the charge level of the battery. Breakaway systems are designed to apply the brakes if the trailer becomes disconnected from the tow vehicle's hitch while in motion. This type of device is required in many States and Provinces as a safety precaution.

- Push to Test: LED's indicate fully charged or recharge
- Built in battery charger charges battery when plugged into the tow vehicle
- Breakaway Switch with 7.5 in. or 48 in. lead wires
- 5 Amp/hr Battery
- Activates trailer brakes upon separation of trailer and tow vehicle
- For use on 1, 2, or 3 axle trailers equipped with electric brakes
- 2 or 3 mounting options
- Note: Make sure battery is fully charged prior to towing



85062

Part Number	Description	Packaging	Master Carton
50-85-315	Push to Test Breakaway System for 1 to 3 Axle Trailers with Electric Brakes, 2 Mounting Options, Includes Battery Box, 5 Amp Battery with Push to Test LED Test Meter and 7.5" Breakaway Switch	Bulk	10
85062	Push to Test Breakaway System for 1 to 3 Axle Trailers with Electric Brakes, 2 Mounting Options, Includes Battery Box, 5 Amp Battery with Push to Test LED Test Meter and 7.5" Breakaway Switch	Boxed	2
50-85-320	Push to Test Breakaway System with ABCD charger for 1 to 3 Axle Trailers with Electric Brakes, 3 Mounting Options, Includes Battery Box, 5 Amp Battery with Push to Test LED Test Meter, and 48" Breakaway Switch	Bulk	10
5085115	Optional Post Mount Bracket	Bulk	48

NOTE: 3 and 4 axle trailers require minimum 5 Amp-hr battery. For optimal performance, replacement of breakaway electrical components is recommended every 3 to 5 years.

### BREAKAWAY SWITCHES

This REESE® Towpower trailer breakaway switch features an LED indicator to confirm the switch is actively functioning. The nylon coated lanyard keeps rust from running down the side of the trailer. Breakaway switches are part of the system that is designed to apply the brakes if the trailer becomes disconnected from the tow vehicle's hitch while in motion. This type of device is required in many States and Provinces as a safety precaution. Emergency use only, not to be used to lock brakes when parked or stored.

- Weather resistant sealed switch
- Scratch resist nylon coated cable
- 48 in. cable to easily reach you tow vehicle
- Strong rust resistant nylon push in plug
- Metal swivel mounting bracket
- Weld able mounting is desired
- Weather-tight O-ring seal
- Switch securely riveted to mounting bracket



8507311

8506300

Part Number	Description	Packaging	Master Carton
8507311	Breakaway Switch with LED Test Light	Clamshell	3
8506300	Breakaway Switch	Clamshell	3



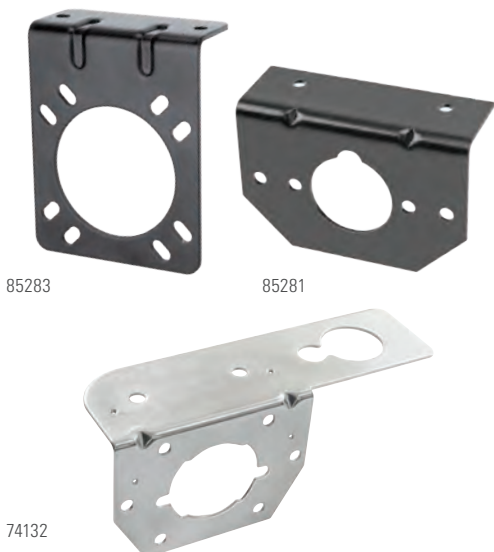

85283

85281

74132

## MOUNTING BRACKETS

- Mounts electrical connector to the attachment bracket or vehicle
- Easy installation

Part Number	Description	Packaging	Master Carton
85281	Mounting Bracket - Vehicle End, Metal, For 4-Pin, 5-Pin and 6-Pin Round Connectors, Screws and Nuts Included	Clamshell	3
85283	Mounting Bracket - Vehicle End, Metal, For 7-Way U.S. Car Connectors, Screws and Nuts Included	Clamshell	3
74132	Mounting Bracket - Vehicle End, Metal Zinc Plated Finish with Hitch Ball Attachment Hole, For 4-Pin, 5-Pin and 6-Pin Connectors,	Clamshell	3
74128	Mounting Bracket - Vehicle End, Metal Zinc Plated Finish with Vertical and Horizontal Mounting Holes for Connector, For 7-Way Connectors	Clamshell	6
85282	Mounting Bracket - Vehicle End, Black Powder-Coat Finish, For 7-Way Connectors, Screws and Nuts Included	Clamshell	3

## OPTIONAL "NO DRILL" ATTACHMENTS

- Attaches to cross tube of hitch without damage to bumpers or fascia trim
- Includes clamp

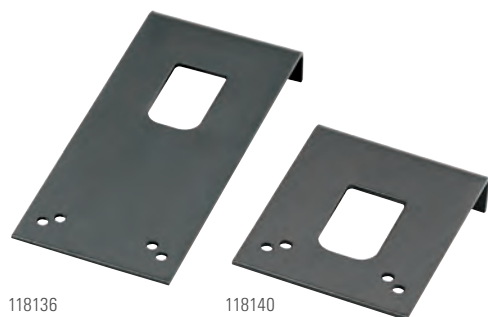

118136

118140

Part Number	Description	Packaging	Master Carton
118136	Mounting Bracket - Vehicle End, Black Powder-Coat Finish, For 6-Pin and 7-Pin Connectors, No Drill 3" x 3.75"	Clamshell	12
118140	Mounting Bracket - Vehicle End, Black Powder-Coat Finish, For 4-Flat, 5-Flat, 4-Pin and 5-Way Round Connectors, No Drill 3" x 6.5"	Clamshell	12

## UNIVERSAL 4-FLAT MOUNTING BRACKET

- Compact high-impact plastic design; corrosion free
- Designed to be attached to the receiver cross tube; does not require any drilling during installation or mounting
- Mounts with included plastic cable ties
- Fits most common 4-Flat connectors
- Can be used with 4-Flat dust cover (#85218)
- Patented



78096

Part Number	Description	Packaging	Master Carton
78096	Universal 4-Flat Mounting Bracket	Clamshell	3

## 6-PIN AND 7-WAY CONNECTOR MOUNTING BOX

- For hitches with 2-1/2 in. square cross tubes
- Securely mounts all standard 6-Pin and 7-Way vehicle end connectors to hitch
- No drilling and no need to disconnect existing wiring
- Corrosion-free high-impact plastic



85285

Part Number	Description	Packaging	Master Carton
85285	6-Pin and 7-Way Connector Mounting Box	Clamshell	3





74641

## CONNECTOR STORAGE BOX

- Neatly stores 4- and 5-Flat connectors
- Easily installs with cable ties or screws (included)
- Weatherproof plastic construction

Part Number	Description	Packaging	Master Carton
74641	Connector Storage Box	Clamshell	3



85355

## CIRCUIT TESTERS

Electrical circuit testers are used to check the continuity of the lighting circuits on your vehicle.

- Use circuit testers whether installing for the first time or confirming that each circuit is functioning properly

Part Number	Description	Packaging	Master Carton
74633	4-Flat Tester with LED Indicator and Key Chain Hook	Clamshell	6
85484	4-Flat Tester with LED Indicator, Tethered	Clamshell	3
85355	Circuit Tester Kit - 6 to 36 Volt, LED Indicator and Alligator Clip	Clamshell	3
20117	7-Way Flat Pin Car End Tester with LED Display	Clamshell	12



8692000

## ELECTRICAL KIT

50-piece automotive and trailer wiring kit includes everything needed for installation, maintenance and repair of a vehicle's or trailer's electrical system.

- Designed for 12- and 24-volt systems
- Universal trailer and automobile applications
- Clear, resealable case keeps items organized and secured
- Multi-purpose cutting, stripping and crimping wiring tool
- 12V probe circuit tester
- Electrical tape
- Replacement dust cover
- Includes butt splices, cable ties, connectors, terminals and ground screws

Part Number	Description	Packaging	Master Carton
8692000	Electrical Kit, 50 Pieces	Clamshell	4



85205

## ELECTRICAL WIRING ACCESSORIES

Part Number	Description	Packaging	Master Carton
85218	4-Flat Cover	Clamshell	6
85489	4 Wire Taps, Fits 16 to 18 Gauge Wire	Clamshell	6
85205	4-Flat Bonded Trailer Wire, 25', 16/18-gauge	Poly Bag	3
85208	2-Flat Polarized Connector, 12" Loop with 2 Ends	Clamshell	6

## ELECTRICAL ADAPTERS



85357

**6-PIN TO 4-FLAT ADAPTER**

- Easily adapt 6-Pin connector to basic 4-Flat connector
- Built-in LED circuit tester instantly checks and displays connectivity

Part Number	Description	Packaging	Master Carton
85357	6-Pin to 4-Flat Adapter, Tethered Dust Cover	Clamshell	3



78116

**7-WAY BLADE TO 4-FLAT ADAPTER**

- Easily adapt OEM 7-Way blade connector to basic 4-Flat connector
- Instantly checks electrical circuit for connectivity
- Displays connectivity using high-visibility LEDs
- U.S. Patent# D620,453S

Part Number	Description	Packaging	Master Carton
78116	7-Way Blade to 4-Flat Adapter with LED Circuit Tester, Snap-Close Dust Cover	Clamshell	3

Glowes RED when tail light circuit is activated

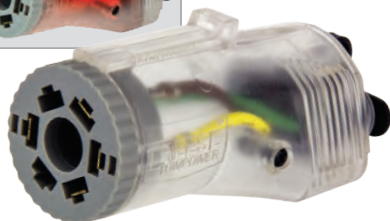

78117

**7-WAY BLADE TO 4-FLAT ADAPTER WITH TOW-GLO**

- Easily adapt OEM 7-Way connector to basic 4-Flat connector
- Glows red when tail light circuit is activated assisting on seeing connection at night time
- Attached dust cover included to keep terminals clean when not towing a trailer
- U.S. Patent# D620,452S

Part Number	Description	Packaging	Master Carton
78117	7-Way Blade to 4-Flat Adapter with Tow-Glo, Dust Cover Included	Clamshell	3



78118

**7-WAY BLADE TO 4/5-FLAT ADAPTER**

- Easily adapt OEM 7-Way blade connector to either 4-Flat or a 5-Flat connector
- Instantly checks electrical circuit for connectivity
- Displays connectivity using high-visibility LEDs
- U.S. Patent# D620,453S

Part Number	Description	Packaging	Master Carton
78118	7-Way Blade to 4/5-Flat Adapter with LED Circuit Tester, Dust Cover Included	Clamshell	3

85350



## 7-WAY BLADE TO 6-PIN OR 4-FLAT ADAPTER

- Easily adapt OEM 7-Way connector to either 6-Pin or a 4-Flat connector
- 6-Pin round connector is switchable to meet desired wiring requirement
- Instantly checks basic trailer electrical circuit for connectivity and displays connectivity using high-visibility LEDs
- Patent pending

Part Number	Description	Packaging	Master Carton
85350	7-Way Blade to 6-Pin or 4-Flat Adapter with LED Circuit Tester, Snap-Close Dust Cover, 2-Mode Switch	Clamshell	3

78119



## 7-WAY BLADE TO 4/5-FLAT ADAPTER WITH 12V POWER OUTLET

- Easily adapt OEM 7-Way connector to 4-Flat or a 5-Flat connector
- Built-in 12V power outlet
- Displays connectivity using high-visibility LEDs
- Patented

Part Number	Description	Packaging	Master Carton
78119	7-Way Blade to 4/5-Flat Adapter with 12V Power Outlet, Snap-Close Dust Cover	Clamshell	3

74686



## COILED ADAPTERS

- Stretches with movement of vehicle
- Heavy-duty abrasion-resistant coiled cable
- Durable molded design
- Tin-plated terminals

Part Number	Description	Packaging	Master Carton
74686	7-Way Blade to 4-Flat Coiled Adapter, 16 Gauge Wire, 6' Full Extension	Clamshell	3
85360	7-Way Blade to 5-Flat Coiled Adapter, 16 Gauge Wire, 5' Full Extension	Clamshell	3

85360



78007



## RETRACTABLE 7-WAY BLADE TO 4-WAY FLAT ADAPTER

- Converts 7-Way connector to standard 4-Flat connector
- Adjust length up to 42 in., no wires dragging on the ground
- Retractable 4-Flat car end plug connects with standard 4-Flat trailer end plug
- Protects and stores wire when not in use
- Patented

Part Number	Description	Packaging	Master Carton
78007	Retractable 7-Way Blade to 4-Way Flat Adapter, 42" Full Extension	Display Card	2



8536900

## FLEX ADAPTERS

- Easily adapt OEM connector to basic connector
- Tethered dust cover
- Corrosion-resistant terminals

Part Number	Description	Packaging	Master Carton
8536700	7-Way to 4-Flat Flex Adapter	Clamshell	3
8536800	7-Way to 4-Flat Flex Adapter with LED Tester	Clamshell	3
118710	7-Way to 4-Flat Flex Adapter, European Style, Dust Cover Included	Boxed	10
8536900	6-Pin to 4-Flat Flex Adapter with LED Tester	Clamshell	3
8536200	6-Pin to 7-Way Flex Adapter, Center-Pin Brake, Flexible Loom Protects Wires	Clamshell	3



85212



85232



74679



74681

## EASY-GRIP ADAPTERS

- Easily adapt OEM connector to basic connector
- Corrosion-resistant terminals

Part Number	Description	Packaging	Master Carton
74607	7-Way to 4-Flat Easy-Grip Adapter	Clamshell	6
74685	7-Way to 4-Flat Easy-Grip Adapter with Separate LED 4-Flat Tester	Clamshell	3
20141	7-Way to 5-Flat Easy-Grip Adapter with LED Lamp Out By-Pass	Clamshell	12
118601	4-Flat Knock-Out Easy-Grip Adapter with LED Lamp Out By-Pass for European Vehicles	Clamshell	12
85212	7-Way to 4/5-Flat Easy-Grip Adapter, For Boat or Utility Trailers with Certain Hydraulic Surge Brakes and/or Back-up Lights	Clamshell	3
85216	7-Way to 6-Pin Easy-Grip Adapter, Auxiliary Center Pin	Clamshell	3
74645	7-Way to 6-Pin Easy-Grip Adapter, Brake Center Pin	Clamshell	3
85232	7-Pin to 4-Flat Easy-Grip Adapter, Rated for 7.5 amps per Circuit	Clamshell	3
74605	6-Pin to 4-Flat Easy-Grip Adapter, Rated for 7.5 amps per Circuit	Clamshell	6
74606	4-Pin to 4-Flat Easy-Grip Adapter, Rated for 7.5 amps per Circuit	Clamshell	6

## 7-WAY BACK-UP ALARM ADAPTER

The 7-Way backup alarm adapter allows for an instant addition of a backup alarm and lets you still use the 7-Way connector to pull a trailer.

- Pass-through design with built-in back-up alarm
- Warns when vehicle is in reverse
- 80 decibel alarm

Part Number	Description	Packaging	Master Carton
74679	7-Way to 7-Way Blade Adapter with Back-Up Alarm, 80 dB	Clamshell	3

## DUAL PORT 12-VOLT POWER ADAPTER

- Instant dual 12-volt power
- Dual ports - use 2 accessories at the same time
- Quick installation

Part Number	Description	Packaging	Master Carton
74681	Dual Port 12-Volt Power Adapter with LED Indicators	Clamshell	3

NOTES

Lined area for notes with horizontal dashed lines.





# BRAKE CONTROLS

**REESE® Towpower electric trailer brake controls** supplies power from your vehicle to your trailer’s brakes so the vehicle does not do all the work. Our brake controls are designed for use with one to four axle systems. These units meet all National Highway Traffic Safety Administration (NHTSA/DOT) regulations regarding tow vehicle/trailer stoplight activation. Our electric trailer brake controls are available in digital and non-digital models, as well as proportional and time base styles. The pre-assembled wire harnesses offers simple hook-up and quick disconnect. Their ease of operation and innovative design features make them the perfect choices for your towing needs. Make sure you check out our selection of brake controllers and choose the one that meets your needs before you hit the road.

**PROPORTIONAL BRAKE CONTROLS**

Prodigy® RF.....	D-2
Prodigy® P2.....	D-3
BRAKE-EVN™ .....	D-3
Voyager® .....	D-3

**TIMED BRAKE CONTROLS**

Brakeman® IV.....	D-4
Brakeman® .....	D-4
Pilot® .....	D-4
POD™ .....	D-5
Compact IQ™ .....	D-5

**BRAKE CONTROL WIRING**

Installation Kits .....	D-5
Universal Wiring Harness.....	D-5
Vehicle Specific Wiring Harnesses.....	D-6

**BRAKE CONTROL WIRING HARNESSES**

Wiring Harnesses.....	D-6
Application Guide .....	D-7 - D-9
Electrical Positions.....	D-9

**DISCONTINUED PRODUCTS.....** D-10

# NEW



90920

## PRODIGY® ID

Take complete control with the Prodigy® ID, the latest in brake control technology. The in-dash rotary knob seamlessly integrates into your vehicle and features a digital diagnostic readout so you can adjust settings at your fingertips.

- The Tekonsha® EDGE™ mobile app provides even more customization, letting you store settings for multiple trailers and drivers switch between proportional or timed braking, receive real-time diagnostics and alerts and more!
- Easy-to-read diagnostics and alerts
- Manual override using rotary knob
- Works proportional in reverse
- Suitable for any trailer with up to 4 braking axles



Part Number	Description	Packaging	Master Carton
90920	Prodigy ID	Litho Box	1

NOW WITH BLUETOOTH WIRELESS COMMUNICATION!



902502

## PRODIGY® RF

The perfect shared-trailer solution. If you take to the road with multiple vehicles, there's really only one solution: Prodigy® RF

### On the Trailer (Power Module Unit):

- Power module uses standard RV blade style 7-Way truck and trailer connectors
- Trailer power module is watertight and is powered through 7-Way cable from the tow vehicle
- Multiple mounting options on the tongue or front of the trailer
- Trailer mounted power module has a 15-year limited warranty (limited 1-year warranty on cord)
- For 1 to 3 axle trailers



### In the Tow Vehicle (Hand Held Unit):

- Wireless communication between the remote handheld unit and trailer mounted power module eliminates the need for under dash wiring
- Easy to see LED display for trailer brake voltage, power output and diagnostics
- Easy to use remote handheld control; includes the Prodigy® "Boost" system to allow for different levels of customized braking
- Unit provides continual diagnostic scanning with a visual warning display
- Handheld unit plugs into any standard 12-volt power accessory adapter
- Handheld unit has a limited 5-year warranty

90255



Part Number	Description	Packaging	Master Carton
902502	Prodigy RF Trailer Mount Brake Control with Handheld Unit with Bluetooth Wireless Communication	Litho Box	2
<b>Replacement Part</b>			
90255	Prodigy RF Bluetooth Remote Handheld Unit	Clamshell	3



90885C

### PRODIGY® P2

Advanced Intelligence

- Reverse battery protection for both vehicle and breakaway
- Designed to work with electric over hydraulic brake systems
- Numerous mounting options – including 360 degree vertical rotation
- Digital display depicts voltage delivery to trailer during braking
- No level adjustment necessary – it adjusts itself to varying terrain
- Works proportionally in reverse - with the ability to disable
- Produces stops that are in proportion to vehicle’s deceleration rate
- “The Original Boost” feature allows for customized braking
- Integrated Plug & Play port for 2-Plug adapters
- Pocket-mount allows user to remove and store the control when not in use
- Mounting bracket, hardware and 2 ft. pigtail harness kit included
- For 1 to 4 axle trailers



Part Number	Description	Packaging	Master Carton
90885C	Prodigy P2 Proportional Electronic Trailer Brake Control	Litho Box	3



8508211

### BRAKE-EVN™

The BRAKE-EVN™ brake controller offers advanced proportional braking by applying brake pressure to match the vehicles deceleration rate.

- Boost feature gives ability to apply more initial trailer braking
- Diagnostics features incorporated in easy to read LED display
- Reverse battery protection
- No leveling required
- Plug & Play feature allows for quick and easy connections
- Small compact design designed for todays dashes
- Simple push button adjustments
- For 1 to 4 axle trailers



Part Number	Description	Packaging	Master Carton
8508211	BRAKE-EVN Proportional Electronic Trailer Brake Control	Clamshell	3



9030C

### VOYAGER®

The Voyager® incorporates Tekonsha’s patented braking sensor and is the best value you’ll find for smooth and secure trailer braking.

- Broad control range makes setting quick and easy
- As braking power is applied, the LED changes color gradually from green (completed circuit) to red, to indicate relative braking power
- Advanced electronics minimize false braking for smoother ride
- Plug & Play feature allows quick and easy connection
- Mounting bracket and hardware included
- For 1 to 4 axle trailers



Part Number	Description	Packaging	Master Carton
9030C	Voyager Proportional Electronic Trailer Brake Control	Litho Box	3

*NOTE: Plug & Play feature allows quick and easy connection. It adapts to all REESE Towpower 2-Plug vehicle specific brake control wiring harnesses.*

*See application guide for vehicle specific applications.*



8507111

### BRAKEMAN® IV

- Digital output indicator
- Small, compact design
- Up-front push buttons for sync and output
- Diagnostics for overload, open ground
- Short circuit protected
- Mounts in any direction
- No leveling required
- Smooth and simple installation
- Plug & Play feature allows quick and easy connection
- Attractive point-of-purchase display packaging
- Mounting bracket and hardware included
- For 1 to 4 axle trailers



Part Number	Description	Packaging	Master Carton
8507111	Brakeman IV Timed Electronic Trailer Brake Control	Clamshell	3



74378

### PILOT®

The Pilot® has just made owning and operating a digital brake control easier than ever.

- Large easy to read dual digital display
- Dark smoke lens ideal for direct light applications; performs better than red lens
- Microprocessor allows control to be mounted upside down and still have a readable display
- Protection against short circuit and loss of ground
- Optional pivot mount available
- For use on any 12 volt negative ground system
- Plug & Play feature allows quick and easy connection
- Mounting bracket and hardware included
- For 1 to 3 axle trailers



Part Number	Description	Packaging	Master Carton
74378	Pilot Timed Electronic Trailer Brake Control	Clamshell	3



74642

### BRAKEMAN®

- Illuminated LED output indicator
- Slide adjustment output control
- “Up- front” manual over-ride control
- Smooth and simple installation
- Plug & Play feature allows quick and easy connection
- Mounting bracket and hardware included
- For 1 to 2 axle trailers



Part Number	Description	Packaging	Master Carton
74642	Brakeman Compact Timed Electronic Trailer Brake Control	Clamshell	3

NOTE: Plug & Play feature allows quick and easy connection. It adapts to all REESE Towpower 2-Plug vehicle specific brake control wiring harnesses.

See application guide for vehicle specific applications.



## TIMED BRAKE CONTROLS



74377

**POD™**

The POD™ (Power on Demand) is your best choice for 1 or 2 axle trailers, especially when your installation options are limited.

- Power-on LED for a positive tow vehicle-to-trailer connection
- “Up-front” manual over-ride control
- Rugged, easy mount chassis
- Smooth and simple installation
- Solid state electronics
- Plug & Play feature allows quick and easy connection
- Mounting bracket and hardware included
- For 1 to 2 axle trailers



Part Number	Description	Packaging	Master Carton
74377	POD Timed Electronic Trailer Brake Control	Clamshell	3



8508700

**COMPACT IQ™ BRAKE CONTROL**

- Unique remote “boost” feature for greater braking control on heavier trailers
- Flexible mounting options
- LED indicator shows status of braking system
- Hardware included
- For 1 to 3 axle trailers



Part Number	Description	Packaging	Master Carton
8508700	Compact IQ Trailer Brake Control	Clamshell	3



85060

**BRAKE CONTROL INSTALLATION KIT**

- Complete kit containing wire and hardware
- Fuse and fuse holder included
- Wires color coded to match brake control functions
- Perfect kit for when no factory harness is present
- Works on time proportional and time based controls
- Works without factory harness

Part Number	Description	Packaging	Master Carton
85060	Brake Control Installation Kit	Boxed	3



850691

**UNIVERSAL BRAKE CONTROL WIRING HARNESS**

- Complete kit containing wire and hardware
- Compatible with REESE® Towpower, and Tekonsha® brake controls
- Allows controller to be unplugged and moved to other vehicles
- Wires color coded to match brake control functions
- Works on time proportional and time based controls

Part Number	Description	Packaging	Master Carton
8506911	Universal Brake Control Wiring Harness	Clamshell	3

*NOTE: Plug & Play feature allows quick and easy connection. It adapts to all REESE Towpower 2-Plug vehicle specific brake control wiring harnesses.*

*See application guide for vehicle specific applications.*





Ford, 1-Plug - 74437



Dodge, 1-Plug - 74439



GM, 1-Plug - 74438



Jeep, 2-Plug - 8507400



Toyota, 2-Plug - 8508400

## BRAKE CONTROL WIRING HARNESSSES

Many of today's vehicles are pre-wired with a brake control connector. A standard brake control wiring harness is an easy way to install a brake controller into the factory's under-dash connector. REESE® Towpower brake control harnesses are designed to provide simple plug-in installation of your vehicle to the REESE® Towpower brake control.

- Complete kit containing wire and hardware
- Fuse and fuse holder included
- Wires color coded to match brake control functions
- Perfect kit for when no factory harness is present
- Works on time proportional and time based controls
- Universal installation kit
- Works without factory harness

Part Number	Application	Packaging	Master Carton
74437	Ford, Land Rover and Lincoln	Clamshell	3
74439	Chrysler and Dodge	Clamshell	3
74438	GM	Clamshell	3
85340	GM and Hummer	Clamshell	3
85100	Toyota, 2-Plug	Clamshell	3
85131	Freightliner and Mercedes-Benz, 2-Plug	Clamshell	3
85132	Dodge, Freightliner and Mercedes-Benz, 2-Plug	Clamshell	3
85133	Chevrolet and GMC, 2-Plug	Clamshell	3
85137	Freightliner, 2-Plug	Clamshell	3
78050	GM and Hummer, 2-Plug	Clamshell	3
78051	Chrysler and Dodge, 2-Plug	Clamshell	3
78052	GM, 2-Plug	Clamshell	3
78053	Buick and GM, 2-Plug	Clamshell	3
78054	Ford and Land Rover, 2-Plug	Clamshell	3
78055	Lexus and Toyota, 2-Plug	Clamshell	3
78056	Infiniti and Nissan, 2-Plug	Clamshell	3
78057	Honda, 2-Plug	Clamshell	3
78059	Ford Super Duty, 2-Plug	Clamshell	3
78060	Ford, 2-Plug	Clamshell	3
78124	Ford F-150, 2-Plug	Clamshell	3
85064	Kia, 2-Plug	Clamshell	3
85066	Dodge and RAM, 2-Plug	Clamshell	3
85067	Dodge and Jeep, 2-Plug	Clamshell	3
8507400	Jeep, 2-Plug	Clamshell	3
8507500	RAM, 2-Plug	Clamshell	3
8507800	Toyota, 2-Plug	Clamshell	3
85083	RAM, 2-Plug	Clamshell	3
8508400	Toyota, 2-Plug	Clamshell	3
8509000	Freightliner, 2-Plug	Clamshell	3

## BRAKE CONTROL WIRING HARNESS APPLICATION GUIDE

Make/Model	Years	Pos.	2-Plug Clam	1-Plug Clam
<b>BUICK</b>				
Enclave with Factory 7-Way	08-17	BP1	78053	
<b>CADILLAC</b>				
Escalade	02	BP1	78052	74438
Escalade	03-06	BP1	78050	85340
Escalade	15-20	BP2	8507000	
Escalade ESV	03-06	BP1	78050	85340
Escalade EXT	02	BP1	78052	74438
Escalade EXT	03-06	BP1	78050	85340
<b>CHEVROLET</b>				
Avalanche 1500	02	BP1	78052	74438
Avalanche 1500	03-06	BP1	78050	85340
Avalanche 2500	02	BP1	78052	74438
Avalanche 2500	03-06	BP1	78050	85340
Silverado 1500	99-02	BP1	78052	74438
Silverado 1500	03-06	BP1	78050	85340
Silverado 1500	14-18	BP2	8507000	
Silverado 1500 (Classic)	07	BP1	78050	85340
Silverado 1500 HD	01-02	BP1	78052	74438
Silverado 1500 HD	03-06	BP1	78050	85340
Silverado 1500 HD (Classic)	07	BP1	78050	85340
Silverado 2500	99-02	BP1	78052	74438
Silverado 2500	03-04	BP1	78050	85340
Silverado 2500 HD	01-02	BP1	78052	74438
Silverado 2500 HD	03-06	BP1	78050	85340
Silverado 2500 HD	15-19	BP2	8507000	
Silverado 2500 HD (Classic)	07	BP1	78050	85340
Silverado 3500	01-02	BP1	78052	74438
Silverado 3500	03-06	BP1	78050	85340
Silverado 3500 (Classic)	07	BP1	78050	85340
Silverado 3500 HD	15-19	BP2	8507000	
Suburban	15-20	BP2	8507000	
Suburban 1500	03-06	BP1	78050	85340
Suburban 1500 w/Amber Turn Signals	00-02	BP1	78052	74438
Suburban 2500	03-06	BP1	78050	85340
Suburban 2500 w/Amber Turn Signals	00-02	BP1	78052	74438
Tahoe	03-06	BP1	78050	85340
Tahoe	15-20	BP2	8507000	
Tahoe w/Amber Turn Signals	00-02	BP1	78052	74438
Traverse w/Factory 7-Way	09-17	BP1	78053	
<b>CHRYSLER</b>				
Aspen w/Factory Tow Package	07-09	BP2	78051	74439
Pacifica w/Factory 7-Way	17-20	BP4	85067	
<b>DODGE</b>				
Dakota w/Factory Tow Package	97-10	BP2	78051	74439
Durango w/Factory Tow Package	98-09	BP2	78051	74439
Durango w/Factory Tow Package	11-20	BP2	85067	
Ram 1500	95-09	BP2	78051	74439
Ram 1500	10	BP1	85066	
Ram 2500	95-09	BP2	78051	74439
Ram 2500	10	BP1	85066	
Ram 3500	95-09	BP2	78051	74439

Make/Model	Years	Pos.	2-Plug Clam	1-Plug Clam
<b>DODGE (continued)</b>				
Ram 3500	10	BP1	85066	
<b>FORD</b>				
Bronco	94-96	BP3	78054	74437
E-150 Econoline	92-08	BP3	78054	74437
E-150 Econoline	09-14	BP7	78059	
E-250 Econoline	92-08	BP3	78054	74437
E-250 Econoline	09-14	BP7	78059	
E-350 Econoline	92-08	BP3	78054	74437
E-350 Econoline RV Cutaway, w/Factory Tow Prep Plug	92-08	BP3	78054	74437
E-350 Econoline Super Duty	09-14	BP7	78059	
E-350 Econoline Super Duty RV Cutaway, w/Factory Tow Prep Plug	09-11	BP7	78059	
E-450 Econoline Super Duty RV Cutaway, w/Factory Tow Prep Plug	03-08	BP3	78054	74437
E-450 Econoline Super Duty RV Cutaway, w/Factory Tow Prep Plug	09-11	BP7	78059	
E-450 Econoline Super Duty Stripped RV Cutaway, w/Factory Tow Prep Plug	00-02	BP3	78054	74437
Excursion	00-05	BP3	78054	74437
Expedition	97-12	BP3	78054	74437
Expedition	13-14	BP5	78059	
Expedition	15-17	BP3	78124	
Explorer w/Factory Tow Package	02-19	BP2	78054	74437
Explorer Sport Trac w/Factory Tow Package	07-10	BP2	78054	74437
F-150	94-08	BP3	78054	74437
F-150	09-20	BP3	78124	
F-150 Heritage	04	BP3	78054	74437
F-250	94-96	BP3	78054	74437
F-250 Heavy Duty	97	BP3	78054	74437
F-250 Styleside	97-99	BP3	78054	74437
F-250 Super Duty	99-04	BP3	78054	74437
F-250 Super Duty	05-07	BP5	78060	
F-250 Super Duty	08-16	BP3	78059	
F-250 Super Duty	17-20	BP3	78124	
F-350	94-96	BP3	78054	74437
F-350 Heavy Duty	97	BP3	78054	74437
F-350 Super Duty	99-04	BP3	78054	74437
F-350 Super Duty	05-07	BP5	78060	
F-350 Super Duty	08-16	BP3	78059	
F-350 Super Duty	17-20	BP3	78124	
F-350 Super Duty Cab & Chassis	05-07	BP5	78060	
F-350 Super Duty Cab & Chassis	08-16	BP3	78059	
F-450 Super Duty	08-16	BP3	78059	
F-450 Super Duty	17-20	BP3	78124	
F-450 Super Duty Cab & Chassis	99-04	BP3	78054	74437
F-450 Super Duty Cab & Chassis	05-07	BP5	78060	
F-450 Super Duty Cab & Chassis	08-16	BP3	78059	
F-550 Super Duty	17-20	BP3	78124	
F-550 Super Duty Cab & Chassis	99-04	BP3	78054	74437
F-550 Super Duty Cab & Chassis	05-07	BP5	78060	
F-550 Super Duty Cab & Chassis	08-20	BP3	78059	
Flex w/Factory Tow Package	09-11	BP2	78054	74437

Make/Model	Years	Pos.	2-Plug Clam	1-Plug Clam
<b>FORD (continued)</b>				
Flex w/Factory Tow Package	12-20	BP5	78124	
Windstar w/Factory Tow Package	95-03	BP3	78054	74437
<b>FREIGHTLINER</b>				
SL	04-20		8509000	
XC	04-20		8509000	
<b>GMC</b>				
Acadia Limited w/Factory 7-Way	17	BP1	78053	
Sierra 1500	99-02	BP1	78052	74438
Sierra 1500	03-06	BP1	78050	85340
Sierra 1500 (Classic)	07	BP1	78050	85340
Sierra 1500 LD (Old Body Style)	14-19	BP2	8507000	
Sierra 1500 HD	01-02	BP1	78052	74438
Sierra 1500 HD	03-06	BP1	78050	85340
Sierra 1500 HD (Classic)	07	BP1	78050	85340
Sierra 2500	99-02	BP1	78052	74438
Sierra 2500	03-04	BP1	78050	85340
Sierra 2500 HD	01-02	BP1	78052	74438
Sierra 2500 HD	03-06	BP1	78050	85340
Sierra 2500 HD	15-19	BP2	8507000	
Sierra 2500 HD (Classic)	07	BP1	78050	85340
Sierra 3500	01-02	BP1	78052	74438
Sierra 3500	03-06	BP1	78050	85340
Sierra 3500 (Classic)	07	BP1	78050	85340
Sierra 3500 HD	15-19	BP2	8507000	
Yukon	03-06	BP1	78050	85340
Yukon	15-20	BP2	8507000	
Yukon w/Amber Turn Signals	00-02	BP1	78052	74438
Yukon Denali	03-06	BP1	78050	85340
Yukon Denali w/Amber Turn Signals	01-02	BP1	78052	74438
Yukon XL 1500	00-02	BP1	78052	74438
Yukon XL 1500	03-06	BP1	78050	85340
Yukon XL 1500 Denali	01-02	BP1	78052	74438
Yukon XL 1500 Denali	03-06	BP1	78050	85340
Yukon XL 2500	00-02	BP1	78052	74438
Yukon XL 2500	03-06	BP1	78050	85340
<b>HONDA</b>				
Pilot w/Factory Tow Package	09-20	BP1	78057	
Ridgeline w/Factory Tow Package	06-14	BP1	78057	
Ridgeline w/Factory Tow Package	17-20	BP1	78057	
H2		BP1	78050	85340
QX56		BP1	78056	
<b>JEEP</b>				
Cherokee	14-20	BP1	8507400	
Grand Cherokee w/Factory Tow Package	11-20	BP2	85067	
<b>KIA</b>				
Borrego	09-11	BP4	85064	
<b>LAND ROVER</b>				
LR3	05-09	BP3	78054	74437
LR4	10-20	BP3	78054	74437
Range Rover	05-14	BP3	78054	74437
Range Rover	15	BP3	78054	74437

Make/Model	Years	Pos.	2-Plug Clam	1-Plug Clam
<b>LAND ROVER (continued)</b>				
Range Rover Evoque	12-19	BP2	78054	74437
Range Rover Sport	20	BP3	78054	74437
<b>LEXUS</b>				
GX460	10-20	BP4	78055	
GX470	03-09	BP3	78055	
LX470	03-07	BP3	78055	
LX570	08-11	BP3	78055	
LX570	13-20	BP4	78055	
<b>LINCOLN</b>				
Aviator w/Factory Tow Package	03-05	BP6	78054	74437
Mark LT	06-08	BP3	78054	74437
MKT w/Factory Tow Package	10-11	BP1	78054	74437
MKT w/Factory Tow Package	12-20	BP1	78124	
Navigator	98-12	BP3	78054	74437
Navigator	13-14	BP3	78059	
Navigator	15-20	BP1	78124	
<b>MERCURY</b>				
Mountaineer w/Factory Tow Package	02-10	BP2	78054	74437
<b>NISSAN</b>				
Armada	05-20	BP1	78056	
Frontier	05-20	BP3	78056	
NV1500	13-20	BP1	78056	
NV2500	13-20	BP1	78056	
NV3500	13-20	BP1	78056	
Pathfinder	05-20	BP3	78056	
Pathfinder Armada	04	BP1	78056	
Titan Except Titan XD	04-20	BP1	78056	
Xterra w/Factory Tow Package	05-15	BP3	78056	
<b>RAM</b>				
1500	11-12	BP1	85066	
1500	13-14	BP3 BP8	8507500 8507600	
1500 (Classic)	13-20	BP9	8507700	
1500 (Classic)	15-20	BP2	85083	
1500 (New Body Style)	19-20	BP9	8507700	
2500	11-12	BP1	85066	
2500	13-14	BP3 BP8	8507500 8507600	
2500	13-21	BP9	8507700	
2500	15-21	BP2	85083	
3500	11-12	BP1	85066	
3500	13-14	BP3 BP8	8507500 8507600	
3500	13-21	BP9	8507700	
3500	15-21	BP2	85083	
Dakota w/Factory Tow Package	11	BP2	78051	74439
<b>SATURN</b>				
Outlook w/Factory 7-Way	07-09	BP1	78053	
4Runner	03-13	BP4	78055	
4Runner	14-20	BP4	8508400	
Land Cruiser	03-11	BP3	78055	
Land Cruiser	13-21	BP3	78055	

## BRAKE CONTROL WIRING HARNESS APPLICATION GUIDE

Make/Model	Years	Pos.	2-Plug Clam	1-Plug Clam
<b>TOYOTA (continued)</b>				
Sequoia	03-20	BP4	78055	
Tacoma	07-15	BP4	78055	
Tacoma	16-20	BP7	8507800	
Tundra	03-14	BP4	78055	
Tundra	15-20	BP7	8507800	

**NOTES:**

- 1-Plug units are designed for brake controls manufactured with electrical wiring mounted on the back of the unit, otherwise known as a pigtail. Wiring harnesses must be spliced into the existing pigtail to allow the vehicle specific plug to be installed.
- 2-Plug units are designed for brake controls that have a wiring port built into the back of the unit. Simply plug the brake control end of the wiring harness into the back of the brake control and the vehicle end into the automobile's port. Brake controls that utilize the 2-plug style of wiring harness will be identified with the Plug & Play logo.

**ELECTRICAL POSITIONS:**

BP1 - Under or behind dash, to the left or right of the emergency brake pedal.

BP2 - Under or behind dash to the left of the steering column and brake pedal.

BP3 - Under or behind dash to the right of the steering column and brake pedal.

BP4 - Kick panel area, on the driver's side.

BP5 - Under or behind dash, behind the center console.

BP6 - Under or behind dash on the passenger side, near glovebox.

BP7 - Centered behind dash between the steering column and the radio.

BP8 - Under or behind dash to the right of the steering column and brake pedal. Also includes 7-Way adapter kit located at the rear center behind the bumper. This unit complies with all applicable California Regulations.

BP9 - Includes 7-Way adapter kit located at the rear center behind the bumper. This unit complies with all applicable California Regulations.

BP10 - Under drivers seat

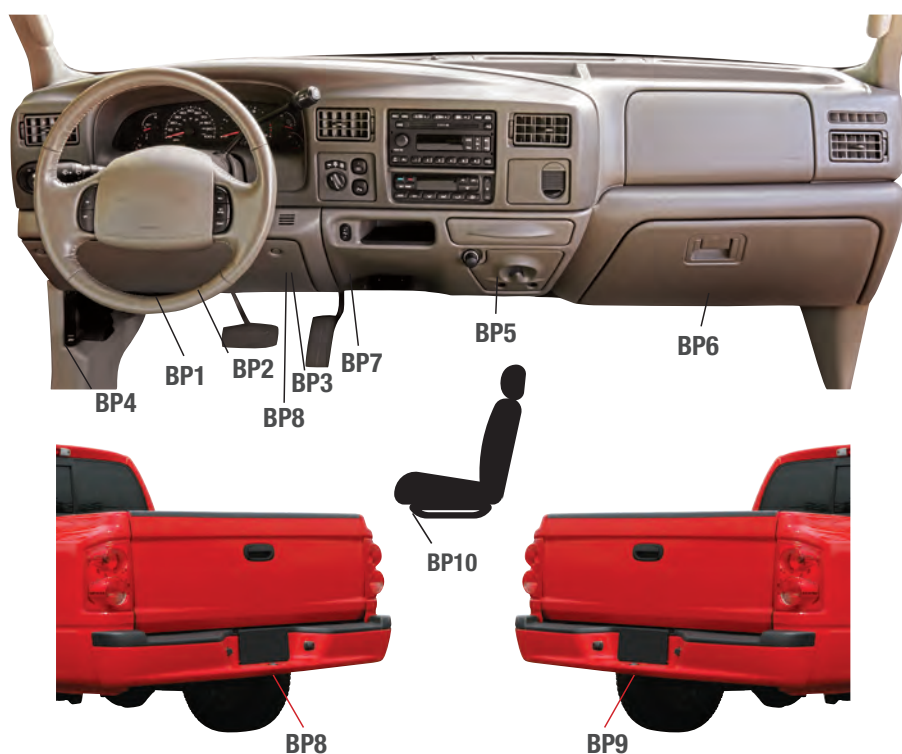



902501



85065

**LAST CHANCE** PRODIGY® RF

Part Number	Description	Substitute Part Number	Packaging	Master Carton
902501†	Prodigy RF Trailer Mount Brake Control with Hand Held Unit with Bluetooth Wireless Communication	902502	Litho Box	2
85065†	Echelon RF Trailer Mount Brake Control with Hand Held Unit		Printed Box	2



8507600



8507700

**LAST CHANCE** BRAKE CONTROL WIRING HARNESSES

Part Number	Application	Substitute Part Number	Packaging	Master Carton
8507600†	RAM, 2-Plug		Clamshell	3
8507700†	RAM, 2-Plug		Clamshell	3

† = Available while supplies last





# CARGO MANAGEMENT

Whether you're heading out on a road trip or visiting a neighborhood park, REESE® Explore offers durable cargo management solutions to get you where you're going. As a leader in the industry we offer a range of products that help transport and organize your gear. Our goal is to increase your vehicles storage capacity by allowing you to carry cargo outside your vehicle, on the roof, using the hitch or mounted to a trunk.

Don't limit taking what you need, solely because there isn't enough room – consider a REESE® Explore cargo product to safely get you and your gear to where you want to go.

## ROOFTOP CARGO CARRIERS

- Adjustable Cross Bars..... E-3
- Rooftop Baskets ..... E-3
- Car Top Mat ..... E-4
- Rooftop Cargo Bags ..... E-4

## HITCH MOUNTED CARGO CARRIERS

- Cargo Trays ..... E-5
- Cargo Carriers ..... E-5
- Cargo Tray Bags ..... E-6
- Cargo Nets ..... E-6
- Solo™ Cargo Carrier ..... E-6

## WATERCRAFT CARRIERS

- Kayak & Canoe Carriers ..... E-8

## TRUCK RACKS

- TransRACK Cargo Rack ..... E-9
- TransRACK Conduit Carrier..... E-9

## BIKE CARRIERS

- Hitch Mounted.....E-7 - E-8

## LOADING RAMPS

- Aluminum Loading Ramps..... E-10 - E-12
- Steel Ramps..... E-13
- Threshold Ramps ..... E-13
- Ramp Kits ..... E-14
- Loading Ramp Accessories ..... E-15

## CARGO ACCESSORIES

- Ratcheting Cargo Bar..... E-16
- Storage Net ..... E-16
- Trunk Organizer..... E-16
- Pet Barrier ..... E-16

## DISCONTINUED PRODUCTS..... E-17- E-23

*Photo courtesy of Elijah Aikens, @aikens.photoart*

# FEATURED

## ROOFTOP CARGO BAG

The REESE® Explore rooftop cargo bag is designed to increase your cargo space. It is made with premium quality material, sonically welded seams and coated zippers.

- Easily attaches to permanent roof racks
- 15 cubic ft. of storage space
- All installation straps included
- Padded structure helps maintain shape
- Storm flap protects zippers
- See page E-4 for additional information



## RAMBLER™ CARGO CARRIERS

A hitch mounted cargo tray is an excellent way to create extra carrying capacity on your vehicle. Use it to carry sports gear, camping or lawn equipment, extra luggage and anything else you don't want taking up precious space inside your vehicle. Cargo trays are also great for hauling items that don't fit in your vehicle, like bulky coolers. REESE® Explore manufactures a rust-resistant steel hitch mounted cargo tray that's easy to assemble using the included hardware. Best of all, they're easy to access, load and unload.

- Mounts to vehicle's receiver hitch
- 5-1/2 in. side rails
- Easy to access, load and unload
- Heavy-duty construction
- Black powder coat finish resists rust
- All hardware included
- See page E-5 for additional information



## CARGO CARRIER BAG

The REESE® Explore cargo carrier bag is constructed from premium quality material with sonically sealed seams. It provides 15 cu ft. of cargo space and measures 59 in. x 18.5 in. x 24 in. It is made to fit on most full size hitch mounted cargo carriers. Perfect for hauling camping gear, sports equipment and tailgating supplies

- Keeps cargo clean and secure
- Includes straps for secure attachment to most cargo trays
- Made with premium, quality materials
- Sonically welded construction
- Folds flat for easy storage
- See page E-6 for additional information



## ROOFTOP CROSS BARS AND BASKETS

### HELPFUL HINTS FOR TRANSPORTING GEAR ON YOUR ROOF

#### Know your vehicle's roof

- Cargo bags mount to raised side rails, cross bars or rooftop baskets
- Rooftop baskets require cross bars

#### Try your bag before you travel

- Adjust strap length and placement on raised side rails and/or cross bars
- Make sure contents fit into bag without overstuffing

#### How to load your bag

- Attach cargo bag to rooftop first—then load
- Keep all valuables in vehicle's interior
- Do not exceed your vehicle's rated roof capacity



1390100



1391400



### ADJUSTABLE CROSS BARS

The REESE® Explore 48 in. cross bars are the perfect answer for carrying extra cargo on long trips and hauls. They are great for use with all accessories, whether it be cargo bags, baskets, or even a kayak. The cross bars are easy to take on and off and are here for all your adventures.

- Expands carrying capacity of any vehicle
- Perfect for carrying rooftop boxes, baskets, cargo bags and other accessories
- All hardware included
- Secure clamp design fits most side rails with roof widths of 35 in. to 46 in.
- Tamper resistant lock and key included (1391400 only)

Part Number	Description	Capacity (lbs.)	Packaging	Master Carton
1391400	Adjustable Cross Bars, 48"	110	Litho Box	1
1395900	Roof Rack Cross Bars, 48"	110	Litho Box	1

### ROOFTOP CARGO BASKETS

- Provide extra cargo space
- Adjustable brackets fit most cross bar styles
- Rust-resistant finish
- Sleek, sporty styling
- Easy to assemble
- All hardware included



1391300

Part Number	Description	Dimensions (in.)	Capacity (lbs)	Packaging	Master Carton
1394400	Rooftop Cargo Basket, Low Profile	37.25 x 26.5 x 3.75	100	Litho Box	1
1391300	Rooftop Cargo Basket, 3-Piece with Custom Air Deflector	44 x 35 x 4.25	125	Litho Box	1





1390100

### ROOFTOP CARGO BAG

- Easily attaches to permanent roof racks
- Made of premium durable material with sonically welded seams
- All installation straps included
- Padded structure helps maintain shape
- Storm flap protects zippers

Part Number	Description	Dimensions (in.)	Capacity (cu ft.)	Packaging	Master Carton
1391100	Cargo Carrier Bag	37 x 32 x 21	15	Litho Box	2
1390100	Rooftop Cargo Bag	40 x 38 x 23	15	Litho Box	2



1391100



1041000

### ROOFTOP CARGO BAGS

- Increase your storage area and free up space in your vehicle
- Easily attach to raised side rails, cross bars and/or rooftop baskets
- Available in a variety of sizes and styles, made with quality materials
- Folds flat when not in use



1041100

Part Number	Description	Dimensions (in.)	Capacity (cu ft.)	Packaging	Master Carton
1041000	Rooftop Cargo Bag	37 x 30 x 15.5	10	Litho Box	2
1041100	Rooftop Cargo Bag	38 x 38 x 18	15	Litho Box	2



1390200

### CAR TOP MAT

- Made of non-slip material to prevent cargo carriers from sliding
- Protects roof finish from scratches
- Allows you to cut the mat to fit your roof or cargo carrier

Part Number	Description	Dimensions (in.)	Packaging	Master Carton
1390200	Car Top Mat	36 x 36	Litho Box	3

## HITCH MOUNTED CARGO CARRIERS

### TRANSPORT YOUR GEAR WITH A HITCH MOUNTED CARGO CARRIER

#### Know your vehicle's hitch size

- Cargo carriers are designed to fit 1-1/4 in. or 2 in. receivers

#### Determine how to best secure your cargo

- Cargo net
- Cargo tray bag
- Ratchet straps

#### Know the weight of the cargo you are carrying

- Cargo tray fitting a 1-1/4 in. receiver will hold up to 300 lbs.
- Cargo tray fitting a 2 in. receiver will hold up to 500 lbs.



Bag  
1043000

Tray  
1394500



1394500

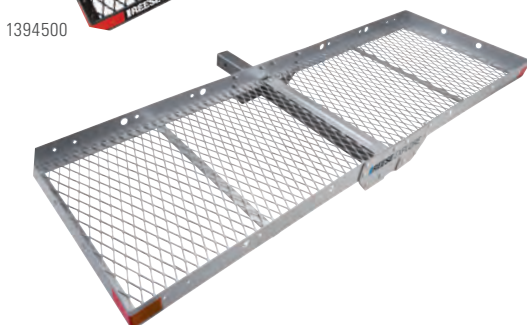

1395800

### CARGO TRAYS

- Great for carrying sports gear, lawn and garden supplies, and camping equipment
- Mounts to vehicle's receiver hitch
- Easy to access, load and unload
- Heavy-duty construction
- Long lasting rust resistant finish
- All hardware included

Part Number	Description	Dimensions (in.)	Receiver Size (in.)	Capacity (lbs.)	Packaging	Master Carton
6502	Folding Cargo Tray	48 x 20	2	500	Litho Box	1
1041500	Steel Cargo Tray, Fits with Included Adapter	60 x 20	1-1/4 2	500	Litho Box	1
1394500	Steel Cargo Tray	60 x 20	2	500	Litho Box	1
1395800	Aluminum Cargo Tray	60 x 20	2	500	Litho Box	1



63153



63155

### RAMBLER™ CARGO CARRIERS

- Great for carrying sports gear, lawn and garden supplies, and camping equipment
- Mounts to vehicle's receiver hitch
- 5-1/2 in. side rails
- Easy to access, load and unload
- Heavy-duty construction
- Black powder coat finish resists rust
- All hardware included

Part Number	Description	Dimensions (in.)	Receiver Size (in.)	Capacity (lbs.)	Packaging	Master Carton
63155	Rambler Cargo Carrier, Bolt-Together	48 x 20	1-1/4	300	Litho Box	1
63153	Rambler Cargo Carrier, Bolt-Together	60 x 24	2	500	Litho Box	1





1040100



63604



1043000



9427200

## SOLO™ CARGO CARRIER

- Ideal for coolers, bags, generators, lawn equipment, or extra gear
- 3 in. side rails keep cargo secure and in place
- Includes holes for attaching bungee cords or cargo nets
- Smart, rugged mesh floors make clean-up quick and easy
- Durable powder coat finish resists the elements, scratches, and rust
- Ramp length 4 ft. (2 ft. when folded)
- Bi-fold ramp for easy travel

Part Number	Description	Dimensions (in.)	Receiver Size (in.)	Capacity (cu ft.)	Packaging	Master Carton
1040100	Solo Cargo Carrier	48 x 32	2	400	Litho Box	1
1040200	Loading Ramp for Solo Cargo Carrier	48 x 32	-	400	Litho Box	1

## CARGO TRAY BAGS

- Perfect for hauling camping gear, sports equipment and tailgating supplies
- Includes straps for secure attachment to most cargo trays
- Made with premium, quality materials
- Sonically welded construction
- Folds flat for easy storage

Part Number	Description	Dimensions (in.)	Capacity (cu ft.)	Packaging	Master Carton
1043000	Cargo Tray Bag	54 x 20 x 21	13	Litho Box	2
63604	Cargo Tray Bag	59 x 18.5 x 24	15	Litho Box	2

## DELUXE CARGO NETS

- Quickly secure complex loads
- Easy to hook to most anchor points
- Durable anti-tangle plastic hooks fit over 1 in. bars
- Holds up under extreme weather conditions
- Bungee material stretches to fit with rubber protectors
- Exclusive no-tangle hook design
- Only use for light loads

Part Number	Description	Dimensions (in.)	Packaging	Master Carton
9427200	Bungee Cargo Net, Includes Heavy Duty Storage Bag	36 x 48	Litho Box	3
1393700	Bungee Cargo Net	36 x 48	Litho Box	6
9424200	Universal Heavy Duty Truck Bed Cargo Net	55 x 78	Litho Box	2
9424100	Bungee Truck Net	60 x 78	Litho Box	2
9427100	Bungee Truck Bed Cargo Net, Includes Heavy Duty Storage Bag	60 x 78	Litho Box	3



1393100G

Arm and carrier fold down when not in use

### TILT-AWAY HITCH MOUNT 4-BIKE CARRIER

The Tilt-Away steel hitch mount bike rack holds up to four bicycles. The tilt-away design allows for easy access to the rear of the vehicle. Bikes are held securely by the molded cradles with hook and loop straps.

- Steel frame has black powder coated, rust resistant finish
- Tilts away for easy trunk access
- Narrow arm design fits a variety of bike styles
- Supports bikes by the frame
- Arms fold down when not in use
- Injection molded cradles protect bike frames
- Anti-rattle hitch pin included
- Arms remove with quick release pin

Part Number	Description	Receiver Size (in.)	Capacity (lbs.)	Packaging	Master Carton
1393100G	Tilt-Away 4-Bike Carrier	1-1/4 and 2	120	Litho Box	1



63134



63138

### Q-SLOT™ BIKE CARRIERS

The Q-Slot™ steel hitch mount bike rack holds up to four bicycles. The platform design holds bikes in the upright position. The support tube with adjustable padded hooks support bikes by the frame. Rear wheels are secured with hook and loop straps. The rise shank provides greater ground clearance.

- Fully adjustable wheel slots
- Carries most bikes regardless of the frame style
- Padded contact points
- Bolt-on 2 in. shank adapter (2 bike carrier only)
- Folds for compact storage
- Center post tilt for easy bike loading and unloading
- Rear reflectors for nighttime visibility included

Part Number	Description	Capacity (lbs.)	Packaging	Master Carton
63134	Q-Slot 2 Bike Carrier, Fits 1-1/4" and 2" Receivers	90	Litho Box	1
63138	Q-Slot 4 Bike Carrier, Fits 2" Receivers	140	Litho Box	1
Replacement Parts				
63135	Q-Slot Bike Carrier Hook and Loop Strap, (4 Pack)		Litho Box	25



63120

63124

## ECLIPSE™ HITCH MOUNT BIKE CARRIER

The Traditional, sport, mountain, racing, men's and women's; no matter the type of bike being transported, REESE® Explore offers a wide variety of bike carriers to fit your needs. Designed with stylish function, these carriers have everything you would expect from an industry leader.

- Accommodates most bike styles and sizes
- Smart swing-arm design tilts forward allowing rear vehicle access without unloading bikes
- Padded cradles secure bikes without damage to the frame
- Hook and loop straps offer superior support and promote quick and easy loading & unloading
- Integrated rear reflector for nighttime visibility

Part Number	Description	Receiver Size (in.)	Capacity (lbs.)	Packaging	Master Carton
63120	Trailer Hitch Mount 2-Bike Carrier	1-1/4	66	Litho Box	1
63124	Trailer Hitch Mount 4-Bike Carrier	2	120	Litho Box	1



1394900

## J-RAC KAYAK CARRIER

The J-Rac kayak carrier attaches to most crossbars and secures the kayak in an upright position. The carrier includes two J-Rac holders and securing straps and mounting hardware are included.

- Premium bow and stern tie down ropes and mounting hardware included
- Heavy-duty powder coated steel construction
- Foam pads cradle and protect kayak during transport
- Universal hardware fits most crossbars

Part Number	Description	Capacity (lbs.)	Packaging	Master Carton
1394900	J-Rac Kayak Carrier	165	Litho Box	1



7018100

## CANOE LOADER

- Allows one person to quickly load and unload a canoe or kayak
- Simply and quickly mounts to trailer hitch
- Includes adapter mount that allows towing while using this canoe loader
- Features adjustable hardware
- Fits most cars, trucks and suvs

Part Number	Description	Receiver Size (in.)	Capacity (lbs.)	Packaging	Master Carton
7018100	Canoe Loader	1-1/4	100	Boxed	1

**TRANSRACK CARGO TRUCK RACK**

- Aluminum construction with stainless steel hardware resists rust and corrosion
- Aerodynamic design
- Includes 4 load stops
- No-drill installation and easy adjustability
- Vinyl-dipped feet and clamps protect truck bed
- Natural wear-resistant finish
- One size fits long and short bed pickup trucks (not recommended for Nissan Titan, Toyota Tacoma and Toyota Tundra)

7054700



Part Number	Description	Capacity (lbs.)	Packaging	Master Carton
7054700	TransRACK Truck Rack System	800	Litho Box	1



TransRACK Truck Rack



TransRACK Workmate Truck Rack



TransRACK Top Rail Kit

**TRANSRACK CONDUIT CARRIER**

- Use with 6 in. PVC pipe (not included)
- Easily attaches to crossbars with provided hardware
- Spring loaded mechanism and rubber gasket for weather resistance
- Works with any truck rack system
- Includes cast aluminum door, end cap and saddle brackets
- Stainless steel hardware included

7054900



Part Number	Description	Packaging	Master Carton
7054900	TransRACK Conduit Carrier	Litho Box	1

**LOADING RAMP KITS**

REESE® Explore self adjusting ramp kits allow you to turn ordinary 2 in. by 8 in. boards into sturdy, rust-proof, all-purpose ramps. No need to worry about angle cuts as these kits are easy to install and use. The included self-stick protective pads keep your tailgate scratch free.

- Rust resistant ramp attaches to trailer tongue or side rails
- 36 In. long
- Keeps you dry when launching your boat
- Self adhesive non-slip pads
- No drill, complete with mounting hardware

9517800



Part Number	Description	Packaging	Master Carton
9517800	Ramp Kit, For 2" x 8" Boards	Litho Box	4



### LOADING RAMPS

REESE® Explore standard duty ramps are great for loading ATVs, snow mobiles, motorcycles and lawn equipment. The innovative rung design provides superior traction for wheels of all sizes while the spacing between the rungs has been optimized to reduce rolling resistance.

- Close rung spacing supports wheels of all sizes
- Smooth rolling rung design
- Adjustable attachment straps
- Welded aluminum construction
- Rust and corrosion resistant

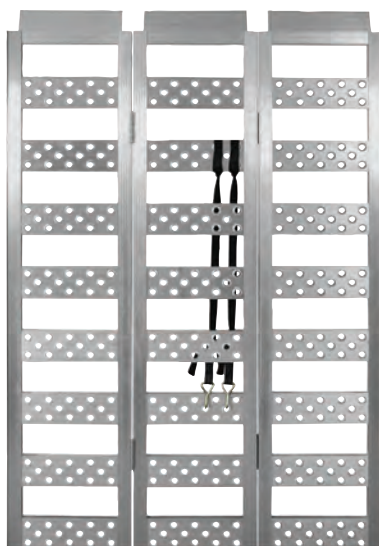

7454700

Part Number	Description	Dimensions (in.)	Capacity (lbs.)	Packaging	Master Carton
7454300	Centerfold Ramp, Single	12 x 85	700	Litho Box	1
7452700	Arched Ramps, Pair	12 x 90	1,500	Sleeve	1
9515000	Arched Centerfold Ramps, Pair	12 x 90	1,500	Sleeve	1
7454700	Tri-Fold Ramp, Single	45 x 69	1,600	Litho Box	1



Standard Duty Tri-Fold Ramp



Standard Duty Arched Ramps



Heavy Duty Straight Ramps

### HEAVY DUTY LOADING RAMPS

REESE® Explore heavy duty ramps are perfect for loading ATVs, UTVs as well as other heavy duty equipment. Aluminum construction makes the ramp durable and resistant to rust. The top plate provides a smooth transition to your truck bed or trailer and the included safety straps are great for safely securing the ramps when loading or unloading.

- Reinforced rungs for loading heavy equipment
- 360° anti-slip ribs provide superior traction
- Full bottom transition plate for easier loading
- Includes cambuckle safety strap for easy attachment
- Constructed from durable aluminum
- Rust and corrosion resistant



9515500

Part Number	Description	Dimensions (in.)	Capacity (lbs.)	Packaging	Master Carton
7454500	Heavy Duty Arched Ramps, Pair	12 x 90	3,000	Sleeve	1
9515500	Heavy Duty Straight Ramps, Pair	15 x 80	4,000	Sleeve	1



### ZERO-TURN MOWER LOADING RAMPS

REESE® Explore all-aluminum ramp pairs have a long loading surface with wide rungs featuring 360 degree anti-slip ribs. Its rungs are spaced closer together for loading and unloading equipment with ease. It is perfect for loading zero turn mowers, lawn tractors and ATVs.

- Smooth rolling rung design
- Close rung spacing perfect for zero-turn mowers
- Rustproof aluminum construction
- Adjustable safety straps included



9515900

Part Number	Description	Dimensions (in.)	Capacity (lbs.)	Packaging	Master Carton
9515800	Arched Ramps, Pair	12 x 94	1,500	Sleeve	1
9515900	Arched Centerfold Ramps, Pair	12 x 92	1,500	Sleeve	1
9516400	Arched Ramps, Ice Black Finish, Pair	12 x 94	1,500	Sleeve	1



Arched Zero-Turn Mower Ramps



Arched Ice Back Finish Ramps



Straight Xtrusion Ramp

### XTRUSION SERIES LOADING RAMPS

Xtruded ramps features a solid, aluminum body designed for improved safety. Its raised traction pattern is perfect for loading and unloading ATVs, UTVs, golf carts and lawn mowers.

- Raised side rails guide wheels
- Full width top plate provides an easy transition point
- Smoothest rolling ramp
- Safe, solid aluminum, no-weld construction
- Superior traction with raised tread
- Attached D-ring for safety strap attachment
- Patented design



9515600

Part Number	Description	Dimensions (in.)	Capacity (lbs.)	Packaging	Master Carton
9515400	Straight Xtrusion Ramp, Single	8 x 80	1,000	Sleeve	1
9515600	Straight Xtrusion Ramps, Pair	11.5 x 80	2,000	Sleeve	1
9515700	Angled Centerfold Xtrusion Ramp, Single	11.5 x 86	1,000	Sleeve	1

### TELESCOPING LOADING RAMP

REESE® Explore telescoping ramp is the newest innovative design offered in REESE ramp line. In its closed position at 48 inches, it fits perfectly in a pick up truck bed or trailer during travel. Perfect for loading and unloading motorcycles, scooters and touring bikes.

- Designed for trailers, trucks or thresholds
- Telescopes to three lengths: 48 in., 71 in. and 82 in.
- Wide rungs provide smoother loading and unloading
- Bottom transition plate allows for smooth transition
- Rustproof aluminum construction
- Adjustable safety strap included
- Compact design for easy storage

Part Number	Description	Dimensions (in.)	Capacity (lbs.)	Packaging	Master Carton
9515300	Telescoping Ramp, Single	13 x 82	700	Sleeve	1

9515300

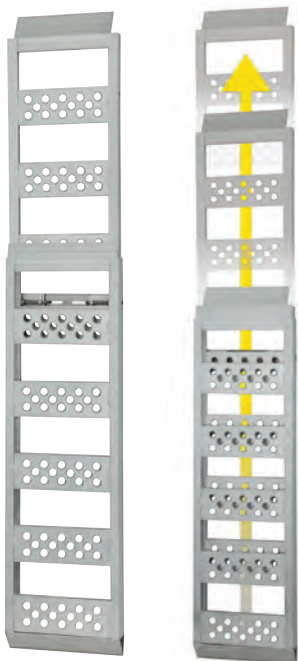

Built-In Ramp Connectors



Straight Ramp with Connectors



Telescoping Ramp

### LOADING RAMPS WITH CONNECTORS

REESE® Explore standard duty straight aluminum ramps are ideal for loading ATVs, snowmobiles, dirt bikes and lawn equipment. Adjustable attachment straps are included to make loading easier and safe. The innovative rung design provides superior traction for wheels of all sizes while the spacing between the rungs has been optimized to reduce rolling resistance.

- Create wider ramps in seconds with built in connectors
- Full width top plate for improved loading
- Wide rungs provide smoother loading and unloading
- Includes cambuckle safety strap for easy attachment
- Rust and corrosion resistant

Part Number	Description	Dimensions (in.)	Capacity (lbs.)	Packaging	Master Carton
7454600	Extra Wide Ramp with Connectors, Single	24 x 84	900	Sleeve	1
7453700	Straight Ramp with Connectors, Pair	13 x 77	1,250	Sleeve	1

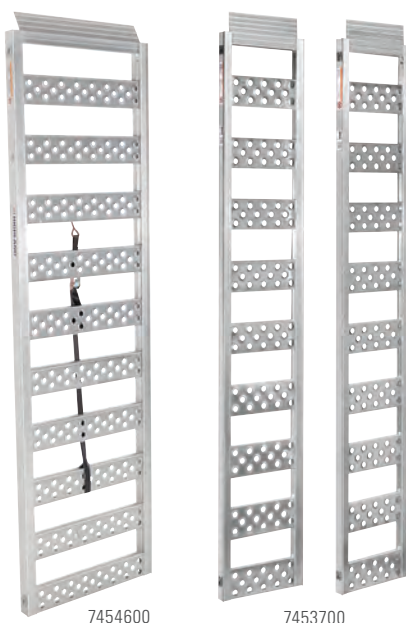

7454600

7453700



STEEL LOADING RAMPS

**STEEL CENTER FOLDING LOADING RAMPS**

REESE® Explore steel center folding loading ramps are designed to provide a smooth transition from the ground to your trailer or truck bed. The punched hole design provides side to side and front to back traction to prevent slipping. Coated side handles are provided to make carrying easy. Smooth rolling rung design.

- Separates at hinges to form two ramps
- Built-in handles for easy carrying
- Includes adjustable attachment strap
- Center folds for easy storage
- Galvanized steel for rust protection



7454000

Part Number	Description	Dimensions (in.)	Capacity (lbs.)	Packaging	Master Carton
9515200	Centerfold Steel Ramp, Single	11 x 80	600	Sleeve	1
7454000	Centerfold Steel Ramp, Single	11 x 80	800	Sleeve	1



Centerfold Steel Ramp - Separated



Centerfold Steel Ramp - Combined



Threshold Steel Ramp

**THRESHOLD STEEL LOADING RAMPS**

REESE® Explore threshold steel loading ramp is designed to provide a smooth transition from the ground to your shed, barn or truck bed. The punched hole design provides side to side and front to back traction to prevent slipping. Coated side handles are provided to make carrying easy.

- Connect into one 80 in.
- Galvanized steel for rust protection
- All hardware included



9516000

Part Number	Description	Dimensions (in.)	Capacity (lbs.)	Packaging	Master Carton
9516000	Straight Threshold Ramp, Pair	11 x 40	1,200	Sleeve	1

0700900 -  
Ramp Tops

## LOADING RAMP KITS

REESE® Explore ramp kits turn ordinary 2 in. x 8 in. boards into sturdy all purpose ramps. Since angle cuts are not necessary, installing and using these ramp tops are simple. Self stick pads are included to protect your tailgate from scratches. Designed for trailers, trucks or thresholds.

- For use with 2 in. x 8 in. or 2 in. x 12 in. boards
- Protective pads included
- Corrosion resistant
- 2 pieces per package
- Installation hardware included



Ramp Top



Ramp Bottom

Part Number	Description	Packaging	Master Carton
0700900	Ramp Top Kit, For 2" x 8" Boards	Litho Box	4
9517100	Ramp Top Kit, For 2" x 12" Boards	Litho Box	4
7455000	Ramp Top and Bottom Kit, For 2" x 8" Boards	Litho Box	4
9518400	Ramp Kit, For 2" x 8" Boards	Litho Box	4

## ALL INCLUSIVE LOADING RAMP KIT

- Super strong, top quality extruded aluminum kits
- 700 lbs. capacity
- For use with 2 in. x 8 in. boards
- Includes: (2) ramp tops, (2) straps, (12) mats, (2) protective pads, and installation hardware

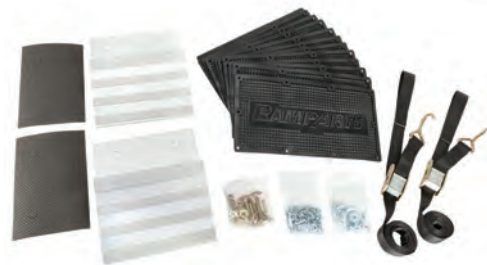

9517300

Part Number	Description	Packaging	Master Carton
9517300	All Inclusive Loading Ramp Top Kit	Litho Box	4



9517700

## ADJUSTABLE LOADING RAMP KITS

- Super strong, top quality extruded aluminum kits
- 700 lbs. capacity
- For use with 2 in. x 8 in. or 2 in. x 12 in. boards
- Installation hardware included
- Self-adjusting top plate creates smooth transitions on and off ramp
- Protective pads included
- 2 pieces per package



Adjustable Ramp Top

Part Number	Description	Packaging	Master Carton
9517500	Adjustable Loading Ramp Kit, For 2" x 8" Boards	Litho Box	4
9517700	Adjustable Loading Ramp Kit, For 2" x 12" Boards	Litho Box	4

LOADING RAMP ACCESSORIES



9518000



LOADING RAMP CARRYING HANDLE

- Handle is vinyl dipped for protective soft covering
- Includes C-clamps and thumb screws for easy attachment
- Works on straight, arched, or folded ramps
- Quickly attaches and removes for transportation

Part Number	Description	Packaging	Master Carton
9518000	Loading Ramp Carrying Handle	Litho Box	4



9518300



LOADING RAMP CARRYING STRAP

- Bundle and carry multiple ramps
- For use on straight, arched or folded ramps
- Secure buckle provides custom fit
- Contoured handle allows for easy gripping
- Carry ramps up to 50 lbs.

Part Number	Description	Packaging	Master Carton
9518300	Loading Ramp Carrying Strap	Litho Box	4



9518200



LOADING RAMP SAFETY STRAP

- 1 in. x 5 ft. cambuckle
- Adjustable strap secures ramp to loading vehicle
- Helps avoid ramp slip-offs from loading vehicle
- Use one strap per ramp

Part Number	Description	Packaging	Master Carton
9518200	Loading Ramp Security Strap	Litho Box	4



2060300

RETRACTABLE TRANSOM TIE DOWNS

REESE® Powersports transom tie downs lock in place to eliminate slippage during traveling. These high quality tie downs can't be over tightened, so you won't damage your boat.

- Strap retracts for easy storage when not in use
- Easily bolt onto trailer with included hardware
- 2 in. webbing with S hooks



Part Number	Description	Capacity (lbs.)	Length (in.)	Packaging	Master Carton
2060300	Retractable Transom Tie Downs, Zinc, (2 Pack)	833/2,500	43	Plastic Shroud	3





1390600



### RATCHETING CARGO BAR

- Easy to use ratchet bar provides maximum hold
- Stops cargo from shifting
- Adjustable design ratchets from 40 in. to 70 in.
- Cushioned pads for extra secure grip
- No tools required

Part Number	Description	Dimensions (in.)	Packaging	Master Carton
1390600	Ratcheting Cargo Bar	40 to 70	Litho Box	2



1392200

### TRUNK ORGANIZER

- Great solution for organizing many items
- 2 large compartments
- Easy to open and easy to fold when not in use
- Rigid inserts provide structure
- Stylish look and design
- Perfect size for any trunk
- Side pockets and straps for small items

Part Number	Description	Dimensions (in.)	Packaging	Master Carton
1392200	Two Pocket Blue and Gray Vehicle Trunk Organizer	26 x 12 x 12	Litho Box	4



9424000

### INTERIOR STORAGE NET

- Organizes and secures cargo in your car, truck, SUV or van
- Installs easily with 3M tape or OEM-style screws (both included)
- Perfect for groceries, sports gear and cleaning supplies
- Quality, durable net material

Part Number	Description	Dimensions (in.)	Packaging	Master Carton
9424000	Storage Net	12 x 45 to 60	Litho Box	3

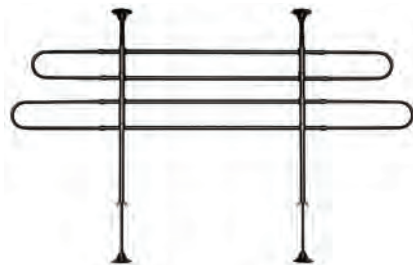

1390800

### UNIVERSAL PET BARRIER

- Safely keeps pet in the cargo area of the vehicle, away from the driver and passengers
- Non-marring brace pads won't harm vehicle interior
- Easy to install and remove to use only when needed

Part Number	Description	Dimensions (in.)	Packaging	Master Carton
1390800	Adjustable Universal Pet Barrier	31 x 39 to 45 x 65	Litho Box	2

DISCONTINUED PRODUCTS



7063500

**LAST CHANCE**

**TRANSRACK WORKMATE CARGO TRUCK RACK**

Part Number	Description	Substitute Part Number	Packaging	Master Carton
7063500 †	TransRACK Workmate Cargo Truck Rack System	800	Litho Box	1



7055200

**LAST CHANCE**

**TRANSRACK TOP RAIL KIT**

Part Number	Description	Substitute Part Number	Packaging	Master Carton
7055200 †	TransRACK Top Rail Kit		Litho Box	1



7063000

**LAST CHANCE**

**TRANSRACK LOAD STOPS**



Part Number	Description	Substitute Part Number	Packaging	Master Carton
7063000 †	TransRACK Load Stops, (4 Pack)		Litho Box	1



7061700

**LAST CHANCE**

**TRANSRACK CROSS BAR GLIDES**

Part Number	Description	Substitute Part Number	Packaging	Master Carton
7061700 †	TransRACK Crossbar Glides, (4 Pack)		Litho Box	3



9424700

**LAST CHANCE**

**LIGHT DUTY CAMBUCKLES**

Part Number	Description	Substitute Part Number	Packaging	Master Carton
9424700 †	1" Webbing with Metal Handle and S Hooks, (4 Pack)		Plastic Shroud	3

† = Available while supplies last



9547800

**LAST CHANCE**
**HEAVY DUTY CAMBUCKLE**

Part Number	Description	Substitute Part Number	Packaging	Master Carton
9547800 †	2" Webbing with Metal Handle and S Hooks		Bulk PDQ	6



9521000

**LAST CHANCE**
**LIGHT DUTY RATCHETS**

Part Number	Description	Substitute Part Number	Packaging	Master Carton
9521000 †	1" Endless Webbing		Litho Box	3



9425900

**LAST CHANCE**
**STANDARD DUTY RATCHETS**

Part Number	Description	Substitute Part Number	Packaging	Master Carton
9521400 †	1" Webbing with Aluminum Full Grip Sport Handle and S Hooks, (2 Pack)		Plastic Shroud	4
9425900 †	1" Webbing with Aluminum Titan Grip Handle and S Hooks, (2 Pack)		Plastic Shroud	4
9510500 †	1" Webbing with Aluminum Full Grip Sport Handle and S Hooks, (2 Pack)		Plastic Shroud	4
9485500 †	1" Webbing with Metal Handle and S Hooks		Bulk PDQ	10



9510500



9427300

**LAST CHANCE**
**HEAVY DUTY RATCHETS**

Part Number	Description	Substitute Part Number	Packaging	Master Carton
9427300 †	2" Webbing Retractable with S Hooks		Bulk PDQ	4
9426001 †	1" Webbing with Titan Max Grip Handle and S Hooks, (2 Pack)		Plastic Shroud	4
9426200 †	1" Webbing with Titan Max Grip Handle and S Hooks, (4 Pack)		Plastic Shroud	3



9429700

**LAST CHANCE**
**SUPER DUTY RATCHETS**

Part Number	Description	Substitute Part Number	Packaging	Master Carton
9425300 †	1.5" Webbing with Grip Handle and Double J Hooks		Bulk	2
9429700 †	1.5" Webbing with Aluminum Max Grip Open Handle and Double S Hooks		Plastic Shroud	4
9560100 †	1" Webbing with Max Grip Handle, REESE Tactical, (4 Pack)		Bulk PDQ	3
9511800 †	2" Webbing with Grip Handle and Double J Hooks		Bulk PDQ	4



9511800

† = Available while supplies last

DISCONTINUED PRODUCTS



**LAST CHANCE**

**BOW TIE DOWNS**

Part Number	Description	Substitute Part Number	Packaging	Master Carton
2060000 †	Bow Tie Downs, (2 Pack)		Clamshell	4



2061300

**LAST CHANCE**

**GUNWALE TIE DOWNS**

Part Number	Description	Substitute Part Number	Packaging	Master Carton
2061300 †	Gunwale Tie Downs		Plastic Shroud	3
2061400 †	Gunwale Tie Downs		Plastic Shroud	3



2060200

**LAST CHANCE**

**RETRACTABLE TRANSOM TIE DOWNS**

Part Number	Description	Substitute Part Number	Packaging	Master Carton
2060200 †	Retractable Transom Tie Downs, Stainless Steel, (2 Pack)		Plastic Shroud	3



**LAST CHANCE**

**TRANSOM TIE DOWNS**

Part Number	Description	Substitute Part Number	Packaging	Master Carton
2060400 †	Transom Tie Downs, (2 Pack)		Plastic Shroud	4



**LAST CHANCE**

**VEHICLE TIE DOWNS**

Part Number	Description	Substitute Part Number	Packaging	Master Carton
9514600 †	1.5" Vehicle Ratchet		PDQ Tray	4



9514600

† = Available while supplies last





9531500



9531600



9428900



9429000

**LAST CHANCE**

**STANDARD BUNGEE CORDS**

Part Number	Description	Substitute Part Number	Packaging	Master Carton
9528000 †	Standard Bungee		Clamshell	6
9531500 †	Standard Bungee		Clamshell	6
9528200 †	Standard Bungee		Clamshell	6
9428900 †	Standard Bungee Assortment, 10 Piece		Clamshell	4
9429000 †	Standard Bungee Assortment, 20 Piece		Clamshell	4



9481300

**LAST CHANCE**

**FAT STRAP® BUNGEE CORDS**

Part Number	Description	Substitute Part Number	Packaging	Master Carton
9481300 †	Adjustable Fat Strap Bungee		Clamshell	8
9532100 †	Adjustable Fat Strap Bungee		Clamshell	6



9545500

**LAST CHANCE**

**WINCH STRAPS**

Part Number	Description	Length (ft.)	Capacity (lbs.)	Packaging	Master Carton
9545400 †	2" Winch Strap	30	3,300/10,000	Boxed	4
9545500 †	4" Winch Strap	30	6,000/18,000	Boxed	3



9526000



9436100

**LAST CHANCE**

**CAMO BUNGEE CORDS**

Part Number	Description	Substitute Part Number	Packaging	Master Carton
9436100 †	Camo Bungee Assortment, 16 Piece		Clamshell	3

† = Available while supplies last



DISCONTINUED PRODUCTS



9524600



9481900



9548300

9549100



9544900

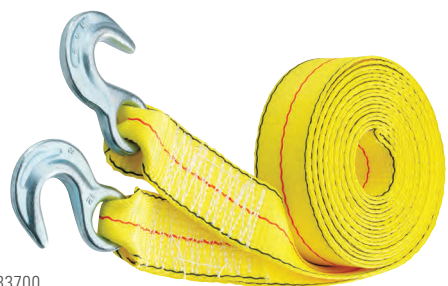

9533700



9426400

† = Available while supplies last

**MULTI-PURPOSE RUBBER TARP STRAPS**

**LAST CHANCE**

Part Number	Description	Substitute Part Number	Packaging	Master Carton
9524600 †	Tarp Strap		Boxed	6
9524200 †	Tarp Strap, (2 Pack)		Boxed	6
9481800 †	Tarp Strap		Boxed	10
9524900 †	Tarp Strap		Boxed	6
9429300 †	Tarp Strap Assortment, 6 Piece		Boxed	4

**CANOPY TIES**

**LAST CHANCE**

Part Number	Description	Substitute Part Number	Packaging	Master Carton
9548300 †	Canopy Tie, 4 Piece		Clamshell	6

**AXLE STRAPS**

**LAST CHANCE**

Part Number	Description	Substitute Part Number	Packaging	Master Carton
9544900 †	2" Axle Strap		Sleeve	4

**TOW STRAPS WITH HOOK ENDS**

**LAST CHANCE**

Part Number	Description	Substitute Part Number	Packaging	Master Carton
9533700 †	2" Reflective Tow Strap with Hook Ends		Sleeve	3
9426300 †	2" Reflective Tow Strap with Hook Ends		Sleeve	3
9426500 †	2" Reflective Tow Strap with Hook Ends		Sleeve	3
9544600 †	2" Reflective Ratchet Tow Strap with Hook Ends, (4 Pack)		Bulk PDQ	50

**TOW STRAPS WITH LOOP ENDS**

**LAST CHANCE**

Part Number	Description	Substitute Part Number	Packaging	Master Carton
9426400 †	2" Reflective Tow Strap with Loop Ends		Sleeve	3

9549200

**LAST CHANCE**

## SURFACE-MOUNT RING ANCHOR POINTS

Part Number	Description	Substitute Part Number	Packaging	Master Carton
9549100†	Surface-Mount Ring Anchor Point		Bulk	20
9549000†	Heavy-Duty Surface-Mount Ring Anchor Point		Bulk	10

9526900

**LAST CHANCE**

## CABLE TIES

Part Number	Description	Substitute Part Number	Packaging	Master Carton
9526900†	Nylon Cable Ties, 650 Piece		Clamshell	3

9420800



9429800

**LAST CHANCE**

## STAKE POCKET ANCHOR POINTS

Part Number	Description	Substitute Part Number	Packaging	Master Carton
9420800†	Universal Chrome Stake Pocket Anchor Point		Bulk	8
9429800†	Eyebolt Stake Pocket Anchor Point		Bulk	6

9549400

**LAST CHANCE**

## RECESS-MOUNT RING ANCHOR POINTS

Part Number	Description	Substitute Part Number	Packaging	Master Carton
9549400†	Recess-Mount Ring Anchor Point		Bulk	8

† = Available while supplies last

DISCONTINUED PRODUCTS



9523500

**LAST CHANCE**

**ANCHOR SHACKLES**

Part Number	Description	Substitute Part Number	Packaging	Master Carton
9523700 †	1/2" Anchor Shackle		Bulk	8
9523600 †	3/4" Anchor Shackle		Bulk	4
9523500 †	7/8" Anchor Shackle		Bulk	4



9535300

**LAST CHANCE**

**E-TRACK O-RINGS**

Part Number	Description	Substitute Part Number	Packaging	Master Carton
9535300 †	E-Track O-Ring		Bulk	3



9535100

**LAST CHANCE**

**E-TRACK SECTIONS**

Part Number	Description	Substitute Part Number	Packaging	Master Carton
9535000 †	E-Track Section		Bulk	4
9535100 †	E-Track Section		Bulk	4
9535200 †	E-Track Section		Bulk	4



9535400

**LAST CHANCE**

**E-TRACK D-RING STRAP**

Part Number	Description	Substitute Part Number	Packaging	Master Carton
9535400 †	E-Track D-Ring Strap		Bulk	3



E-TRACK SYSTEM\*

**LAST CHANCE**

**E-TRACK TIE DOWNS**

Part Number	Description	Substitute Part Number	Packaging	Master Carton
9535900 †	Standard Duty E-Track Retractable Ratchet		Plastic Shroud	3
9535700 †	Heavy Duty E-Track Ratchet with Open Handle		Plastic Shroud	3

*\*This system is specifically designed to work with Ford Boxlink anchors; no track is needed. Simply lock in place and go. Standard since 2015 on F-Series.*

† = Available while supplies last

NOTES

Lined area for notes with horizontal dashed lines.



# JACKS, COUPLERS AND WINCHES

**REESE® Towpower offers a complete line of jacks, couplers and winches that will keep your customers coming back for all their trailering and towing needs.**

**Jacks are offered in a variety of mounting options including, retaining ring swivel, tubular swivel and the popular A-frame, with lift capacities ranging from 2,000 lbs. to 5,000 lbs. Crank handles are available in both topwind and sidewind models.**

**Stamped couplers come in the popular higher capacity A-frame couplers to be married together with the A-frame jack. The spring loaded latching mechanism will keep your trailer securely and safely attached to your tow vehicle. The dual fit coupler will maximize your sales and optimize shelf space using one SKU for several trailer applications.**

**REESE® Towpower winches feature capacities ranging from 600 lbs. to 3,200 lbs., available in single speed, dual speed and the versatile and portable electric winch which includes a manual override crank. The high carbon steel gear construction along with the zinc plating provide exceptional corrosion resistance and long life.**

**TRAILER JACKS**

Powered.....	F-2
Marine.....	F-2
Recreational.....	F-2 - F-4
Industrial.....	F-2
Round Bolt-On.....	F-3
Round Weld-On.....	F-3
Round A-Frame.....	F-4
Square Weld-On.....	F-4
Heavy Duty Farm and UTV.....	F-4

**TRAILER COUPLERS**

Straight Tongue.....	F-5
Dual Fit.....	F-5
A-Frame.....	F-5

**TRAILER WINCHES**

Single Speed.....	F-6
Two Speed.....	F-6
Marine.....	F-6
Electric.....	F-6

<b>DISCONTINUED PRODUCTS.....</b>	<b>F-7</b>
-----------------------------------	------------





7036400

### 2.5K JACK WITH POWERED DRIVE

- Integrated circuit breaker
- 18 in. of total travel
- Works in case of power loss with supplied manual override crank handle
- Glass black painted outer tube and motor assembly, clear zinc inner tube
- Footplate not included
- 1-year limited warranty

Part Number	Description	Lift Capacity (lbs.)	Travel (in.)	Retracted (in.)	Extended (in.)	Clearance (in.)	Packaging	Master Carton
7036400	Black	2,500	18.00	8.50	26.50	N/A	Litho Box	1

### MARINE AND RECREATIONAL JACKS

- Heavy duty swivel mechanism for easy use
- 6 in. wheel to move your trailer into position for easy hook-up
- Fits tongues up to 3 in. x 5 in.
- 3/8 in. pull pin
- Zinc finish



74410

Part Number	Description	Lift Capacity (lbs.)	Handle	Travel (in.)	Packaging	Master Carton
7042900	Swing Away Side Mount Trailer Jack with 6" Dual Wheel, Bolt-On	1,000	Topwind	10.00	Litho Box	1
74412	Swing Away Side Mount Trailer Jack with 6" Wheel, Bolt-On	600	Topwind	10.00	Litho Box	1
74413	Swing Away Side Mount Trailer Jack with Footplate, Bolt-On	1,000	Topwind	10.00	Litho Box	1
74410	Swing Away Side Mount Trailer Jack with 6 in. Wheel, Bolt-On	1,000	Sidewind	10.00	Litho Box	1
<b>Accessory</b>						
74326	Trailer Jack Caster Wheel, 1,000 lbs. Capacity				Boxed	50

### INDUSTRIAL JACKS

- Bolt-on versions include all necessary mounting hardware
- Weld-on versions include mating mount and retaining ring
- A-frame model has black painted outer and inner tube, all other models have black painted outer and clear zinc inner tubes
- A-frame model includes removable footplate



74407

Part Number	Description	Lift Capacity (lbs.)	Handle	Travel (in.)	Packaging	Master Carton
74415	Tubular Swivel Mount Trailer Jack with Footplate, Weld-On	2,000	Topwind	10.00	Litho Box	1
74414	Retaining Ring Swivel Mount Trailer Jack with Footplate, Weld-On	2,000	Topwind	10.00	Litho Box	1
74407	A-Frame Trailer Jack with Removable Footplate	2,000	Topwind	14.00	Litho Box	1



7076600

### BOLT-ON RETAINING RING SWIVEL MOUNT ROUND JACK

- Designed for use with recreational and utility trailers
- Black painted outer and clear zinc inner tubes
- Footplate included
- Mounting hardware included
- Instruction sheet bagged and zip tied to jack

Part Number	Lift Capacity (lbs.)	Handle Style	Travel (in.)	Retracted (in.)	Extended (in.)	Clearance (in.)	Packaging	Master Carton
7076600	2,000	Topwind	10.00	11.00	21.00	4.00	Bulk	1



7077900

### WELD-ON RETAINING RING SWIVEL MOUNT ROUND JACKS

- Designed for use with recreational and utility trailers
- Black painted outer and clear zinc inner tubes
- Footplate included
- Mating mount included
- Instruction sheet bagged and zip tied to jack

Part Number	Lift Capacity (lbs.)	Handle Style	Travel (in.)	Retracted (in.)	Extended (in.)	Clearance (in.)	Packaging	Master Carton
7078700	2,000	Topwind	10.00	11.00	21.00	4.00	Bulk	1
7078100	2,000	Topwind	15.00	14.50	29.50	10.00	Bulk	1
7077900	2,000	Sidewind	10.00	10.00	20.00	6.30	Bulk	1



7079500

### WELD-ON TUBULAR SWIVEL MOUNT ROUND JACKS

- Designed for use with recreational and utility trailers
- Black painted outer and clear zinc inner tubes
- Footplate included
- Mating mount and pull pin included
- Instruction sheet bagged and zip tied to jack

Part Number	Lift Capacity (lbs.)	Handle Style	Travel (in.)	Retracted (in.)	Extended (in.)	Clearance (in.)	Packaging	Master Carton
7078300	2,000	Sidewind	10.00	11.20	21.20	5.50	Bulk	1
7078500	2,000	Sidewind	15.00	14.40	29.40	12.30	Bulk	1
7076100	2,000	Topwind	10.00	11.00	21.00	4.00	Bulk	1
7078900	2,000	Topwind	15.00	14.50	29.50	10.00	Bulk	1
7079000	5,000	Sidewind	10.00	10.50	20.50	6.30	Bulk	1
7079200	5,000	Sidewind	15.00	15.50	30.50	6.30	Bulk	1
7079500	5,000	Topwind	10.00	11.20	21.20	4.00	Bulk	1
7076300	5,000	Topwind	15.00	14.70	29.70	10.00	Bulk	1

### A-FRAME ROUND JACKS

- Designed for use with trailers with A-frame couplers
- Weld-on or bolt-on A-frame mount
- Black painted outer and inner tubes
- No footplate
- Instruction sheet bagged and zip tied to jack



7080100

Part Number	Support Capacity (lbs.)	Handle Style	Travel (in.)	Retracted (in.)	Extended (in.)	Clearance (in.)	Packaging	Master Carton
7080300	2,000	Sidewind	14.00	9.00	23.00	13.00	Bulk	1
7080100	2,000	Topwind	14.00	8.00	22.00	11.00	Bulk	1
7080200†	2,000	Sidewind	14.00	9.00	23.00	13.00	Litho Box	1
7076800	5,000	Topwind	15.00	10.80	25.80	14.60	Bulk	1
Accessory								
74326	Trailer Jack Caster Wheel, 1,000 lbs. Capacity						Boxed	50

† = Available while supplies last

### WELD-ON SQUARE JACK

- Tubular swivel mount
- Mating mount and pull pin included
- Fixed leg
- Black painted outer and zinc clear inner tubes
- Instruction sheet bagged and zip tied to jack



7079900

Part Number	Support Capacity (lbs.)	Handle Style	Travel (in.)	Retracted (in.)	Extended (in.)	Clearance (in.)	Packaging	Master Carton
7079900	5,000	Sidewind	10.00	17.40	27.40	8.00	Bulk	1

### HEAVY DUTY FARM AND UTV JACKS

- Long handle for ease of use
- Lifting platform allows load to stay in contact
- Easy lift, camp and winch
- Lifting platform drops away for fast disengage when load is removed
- Removable handle and clamp



7064200

Part Number	Lift Capacity (lbs.)	Height (in.)	Travel (in.)	Finish	Packaging	Master Carton
7064200	7,000	36	30	Black	Litho Box	3
7033400	7,000	48	42	Red and Black	Litho Box	1
7060900	8,000	54	48	Black	Litho Box	1
Accessories						
7071300	Universal ATV/UTV Jack Mounts, Mount Jacks to Bumpers, Bull Cars, Rolls Cages, Roof Racks or Cargo Racks				Litho Box	1
7061500	Farm Jack Handle Holder, Durable PVC, Eliminates Rattle				Litho Box	3
7064100	Farm Jack Maintenance Kit, Includes: (2) Climbing Pins, (2) Climbing Pin Springs, (2) Cross Pins, (1) Handle Pin and Clip				Litho Box	6



74338



7004800

## TRAILER COUPLERS

- The Fas Lok trigger latching mechanism allows quick and easy trailer hook-up, and is factory adjusted for convenience
- Zinc finish

Part Number	Description	GTW (lbs.)	Ball Size (in.)	Channel Width (in.)	Packaging	Master Carton
74338	Trailer Coupler, (2 Pack)	2,000	1-7/8	2	PDQ Tray	2
74040	Trailer Coupler, (2 Pack)	2,000	1-7/8	2-1/2	PDQ Tray	2
74783	Trailer Coupler, (2 Pack)	2,000	1-7/8	3	Bulk	2
74042	Trailer Coupler, (2 Pack)	3,500	2	2-1/2	PDQ Tray	2
74280	Trailer Coupler, (2 Pack)	3,500	2	3	PDQ Tray	2

## DUAL-FIT TRAILER COUPLERS

- The Fas Lok trigger latching mechanism allows quick and easy trailer hook-up, and is factory adjusted for convenience
- Dual-fit spacers ensure a proper fit for sizes of channels
- Tethered pin included for added safety
- Zinc finish

Part Number	Description	GTW (lbs.)	Ball Size (in.)	Channel Width (in.)	Packaging	Master Carton
7004800	Dual-Fit Trailer Coupler, (2 Pack)	2,000	1-7/8	2 and 2-1/2	PDQ Tray	2
7004700	Dual-Fit Trailer Coupler, (2 Pack)	3,500	2	2-1/2 and 3	PDQ Tray	2



E438050303

## A-FRAME COUPLERS

- Designed for utility, horse/livestock, cargo and construction trailer applications
- Quick to hook up and disconnect
- Black primer finish

Part Number	Description	GTW (lbs.)	Ball Size (in.)	Channel Width (in.)	Packaging	Master Carton
E338050303	A-Frame Coupler	5,000	2	A-Frame	Bulk	1
E438050303	A-Frame Coupler	8,000	2	A-Frame	Bulk	1



7479636

## COUPLER ACCESSORIES

Part Number	Description	Packaging	Master Carton
7479636	1-7/8" Ball Coupler Repair kit	Clamshell	3
7479736	2" Ball Coupler Repair Kit, Coupler Pin and Chain	Clamshell	3
7050900	Coupler Pin and Chain	Clamshell	6



74329

### SINGLE SPEED TRAILER WINCHES

- Full-length drum bushing and oil-impregnated shaft bushing minimize maintenance
- High-carbon steel gears to resist wear and last longer
- Zinc finish

Part Number	Capacity (lbs.)	Gear Ratio	Ratchet Type	Rope (ft. x in.)	Strap (ft. x in.)	Strap Included	Packaging	Master Carton
74337	600	3.1:1	One-Way	36 x 1/4	15 x 2	No	Litho Box	2
7019400	600	3.1:1	One-Way	-	15 x 2	Yes	Litho Box	2
74418	1,100	4.1:1	Two-Way	36 x 1/4	15 x 2	No	Litho Box	2
74556	1,100	4.1:1	Two-Way	-	15 x 2	No	Litho Box	2
74329	1,500	4.1:1	Two-Way	20 x 5/16	20 x 2	Yes	Litho Box	1
7016900	1,500	4.1:1	Two-Way	-	20 x 2	Yes	Litho Box	2



7017000

### TWO SPEED TRAILER WINCH

- Full-length drum bushing and oil-impregnated shaft bushing minimize maintenance
- High-carbon steel gears to resist wear and last longer
- Zinc finish

Part Number	Capacity (lbs.)	Gear Ratio	Ratchet Type	Rope (ft. x in.)	Strap (ft. x in.)	Strap Included	Packaging	Master Carton
74529	1,800	4.1:1 9.8:1	Two-Way	20 x 7/16	-	No	Litho Box	1
7017000	2,000	4.1:1 9.8:1	Two-Way	-	20 x 2	Yes	Litho Box	2



7064800

### MARINE COLLECTION TRAILER WINCHES

- Easy-grip non-skid handle
- All-weather strap with coated hook
- High performance gear ratio
- Precision two-way ratchet
- Corrosion resistant powder coat finish

Part Number	Capacity (lbs.)	Gear Ratio	Ratchet Type	Finish	Strap (ft. x in.)	Strap Included	Packaging	Master Carton
7064800	1,800	5.1:1	Two-Way	Black	20 x 2	Yes	Litho Box	1



7033600

### PORTABLE ELECTRIC WINCH

- Perfect for vehicle recovery or mounting boat to trailers
- Wired Remote control
- Steel mounting plate
- Manual hand crank and knob

Part Number	Pulling Capacity (lbs.)	Marine Capacity (lbs.)	Rolling Capacity (lbs.)	Steel Cable (ft.)	Power Cable (ft.)	Cable Included	Packaging	Master Carton
7033600	2,000	5,000	6,000	29	20	Yes	Litho Box	1

### WINCH STRAPS

- Made with heavy duty webbing

Part Number	Description	Packaging	Master Carton
7017200	Winch Strap, 2 ft. x 20 in., 5,000 lbs. Capacity	Boxed	3



DISCONTINUED PRODUCTS



7005000



704900

**LAST CHANCE**

**DUAL-FIT KEYLOK™  
COUPLERS**

Part Number	Description	GTW (lbs.)	Ball Size (in.)	Channel Width (in.)	Packaging	Master Carton
7005000 †	Dual-Fit KeyLok Coupler, (2 Pack)	2,000	1-7/8	2 and 2-1/2	PDO Tray	2
7004900 †	Dual-Fit KeyLok Coupler, (2 Pack)	3,500	2	2-1/2 and 3	PDO Tray	2

**LAST CHANCE**

**MARINE COLLECTION  
TRAILER WINCHES**

Part Number	Capacity (lbs.)	Gear Ratio	Ratchet Type	Finish	Strap (ft. x in.)	Strap Included	Packaging	Master Carton
7064600 †	1,200	4.1:1	Two-Way	Silver	15 x 2	Yes	Litho Box	1



7064600

**LAST CHANCE**

**WINCH STRAPS**

Part Number	Description	Packaging	Master Carton
7017200 †	Winch Strap, 2 ft. x 20 in., 5,000 lbs. Capacity	Boxed	3



7017200

† = Available while supplies last

NOTES

Lined area for notes with horizontal dashed lines.



# TRAILER LIGHTING

Since 1931, REESE® Towpower has served as a trusted partner to commercial truck and light-duty trailer manufacturers and their respective aftermarkets. We manufacture incandescent and LED trailer lighting products that provide an extensive variety of lighting options for agricultural, industrial, recreational, and utility trailers.

While each state has its own set of towing laws and regulations from size limits to weight restrictions, the one thing they all have in common is that your trailer must be wired for tail lights, brake lights and turn signals. REESE® Towpower manufactures every type of lighting you need to tow safely: stop/turn/tail lights, clearance lights, utility and back-up lights, reflectors, lighted hitch covers, tailgate lights and license plate lights. And rest assured that all of our lighting products comply with Department of Transportation requirements.

## TAIL LIGHTS

LED.....	G-2 - G-3
Incandescent.....	G-4 - G-6
Pedestal Mount.....	G-7

## CLEARANCE / SIDE MARKER LIGHTS

LED.....	G-8 - G-10
Incandescent.....	G-11 - G-13

## ID LIGHT BARS

LED.....	G-14
Incandescent.....	G-14

## AUXILIARY LIGHTS

License Plate Lights.....	G-15
Interior Lights.....	G-15
Utility Lights.....	G-16

## REFLECTORS

Quick Mount Reflex.....	G-18
Aluminum.....	G-18
Conspicuity.....	G-18

## SPECIALTY LIGHTS

Tractor Light.....	G-16
LED Hitch Step Light.....	G-16
Hazard Lights.....	G-17
Lighted Receiver Tube Covers.....	G-19
Lighted Logo Emblems.....	G-19
Tailgate Light Bar.....	G-20
LED Light Strips.....	G-20
LED Strobe Lights.....	G-20

<b>DISCONTINUED PRODUCTS.....</b>	<b>G-21</b>
-----------------------------------	-------------



### LED SUBMERSIBLE STOP/TURN/TAIL LIGHTS



- Long life: 100,000 + hours LED
- Combination stop/turn/tail
- Built-in side marker reflectors meet D.O.T. requirements
- Submersible/waterproof
- Solid-state design
- Amperage draw is lower than incandescent
- Mounts on 2 in. centers



Part Number	Description	Packaging	Master Carton
<b>Under 80 in. Wide Trailers</b>			
73854	LED Left/Roadside, 7-Function Tail Light for Under 80" Wide Trailers, Includes License Plate Light	Clamshell	2
73853	LED Right/Curbside, 6-Function Tail Light for Under 80" Wide Trailers	Clamshell	2
73857	LED Tail Light Kit, Includes: (2) Tail Lights, (1) License Plate Bracket, (1) 25' Wishbone Trailer Harness, (1) 48" Connector and Mounting Hardware, for Under 80" Wide Trailers	Clamshell	2
73858	LED Tail Light Kit, Includes: (2) Tail Lights, (1) License Plate Bracket, (1) 25' Wishbone Trailer Harness, (1) 48" Connector and Mounting Hardware, for Under or Over 80" Wide Trailers	Clamshell	2
<b>Over 80 in. Wide Trailers</b>			
73856	LED Left/Roadside, 8-Function Tail Light for Over 80" Wide Trailers, Includes License Plate Light	Clamshell	2
73855	LED Right/Curbside, 7-Function Tail Light for Over 80" Wide Trailers	Clamshell	2
73858	LED Tail Light Kit, Includes: (2) Tail Lights, (1) License Plate Bracket, (1) 25' Wishbone Trailer Harness, (1) 48" Connector and Mounting Hardware, for Under or Over 80" Wide Trailers	Clamshell	2



### LED LOW PROFILE SUBMERSIBLE STOP/TURN TAIL LIGHTS



- Long life: 100,000 + hours LED
- Combination stop/turn/tail
- Built-in side marker reflectors meet D.O.T. requirements
- Submersible/waterproof
- Solid-state design
- Amperage draw is lower than incandescent
- Mounts on 2 in. centers

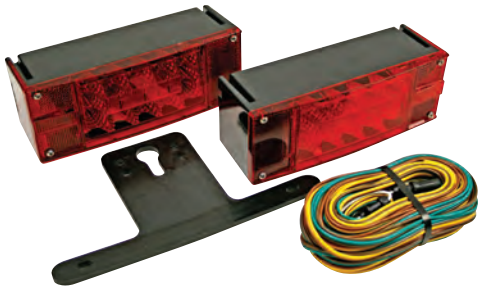

Part Number	Description	Packaging	Master Carton
86038	LED Low Profile Left/Roadside, 8-Function Tail Light for Over 80" Wide Trailers	Clamshell	2
86037	LED Low Profile Right/Curbside, 7-Function Tail Light for Over 80" Wide Trailers	Clamshell	2
86006	LED Low Profile Tail Light Kit, Includes: (2) Tail Lights, (1) License Plate Bracket, (1) 25' Wishbone Trailer Harness, (1) 48" Connector and Mounting Hardware, for Over 80" Wide Trailers	Clamshell	2





86078



86035



86036

### LED 6 IN. CLEAR OVAL SEALED TURN AND TAIL LAMP KITS



- Long life: 100,000 + hours LED
- Suitable for horizontal or vertical mounting
- Epoxy-encapsulated solid-state electronics, sonically sealed for water resistance

Part Number	Description	Packaging	Master Carton
86078	LED 6" Oval Backup Light Kit, White with Clear Lens	Blister Card	3
86035	LED 6" Oval Turn Lamp Kit, Amber with Clear Lens	Blister Card	3
86036	LED 6" Oval Stop/Tail Lamp Kit, Red with Clear Lens	Blister Card	3



73885



73884

### LED 6 IN. OVAL SEALED STOP/TURN/ TAIL LIGHTS



- Long life: 100,000 + hours LED
- Amperage draw is lower than incandescent
- Grommet mount, includes light, grommet and pigtail

Part Number	Description	Packaging	Master Carton
73885	LED 6" Oval Stop/Turn/Tail Light, Red	Blister Card	3
73884	LED 6" Oval Turn Light, Amber	Blister Card	3
86056	Replacement Red Light, LED	Blister Card	3



86046



8610911

### LED 6 IN. OVAL SEALED STOP/TURN/ TAIL LIGHTS WITH FIXED BEZEL



- Long life: 100,000 + hours LED
- Suitable for horizontal or vertical mounting
- Epoxy-encapsulated solid-state electronics, sonically sealed for water resistance

Part Number	Description	Packaging	Master Carton
86046	LED 6" Oval Stop/Turn/Tail Light, Red, with Fixed Bezel	Blister Card	3
8610911	LED 6" Oval Stop/Turn/Tail Light, Red, with Fixed Chrome Bezel	Blister Card	3



86014

### LED 4 IN. ROUND SEALED STOP/TURN/TAIL LIGHT KIT



- Long life: 100,000 + hours LED
- Grommet mount
- Epoxy-encapsulated solid-state electronics, sonically sealed for water resistance

Part Number	Description	Packaging	Master Carton
86014	LED 4" Round Stop/Turn/Tail Light Kit, Red	Blister Card	3





73829

### UNIVERSAL STOP/TURN/TAIL LIGHT WITH LICENSE PLATE LIGHT

- Suitable for: tail light, stop light, turn signal, license light, back-up light and rear reflector
- Heavy-duty flexible PVC tube with pre-installed wires
- Universal light, fits most trucks, 5.75 in. x 6.75 in.

Part Number	Description	Packaging	Master Carton
73829	Universal Stop/Turn/Tail Light with License Plate Light, Red	Blister Card	2



73825

73824

### SQUARE STOP/TURN/TAIL LIGHTS

- 4.5 in. square style
- Red screw-on lens
- Easy stud mounting
- For general use on medium and light duty trailers
- Meets department of transportation requirements
- Grounds through mounting studs

Part Number	Description	Packaging	Master Carton
73825	Square Left/Roadside, 7-Function Tail Light for Under 80" Wide Trailers, Includes Reflector, Side Marker Light, Side Reflector and License Plate Light	Clamshell	4
73824	Square Right/Curbside, 6-Function Tail Light for Under 80" Wide Trailers, Includes Reflector, Side Marker Light and Side Reflector	Clamshell	4
73832	Square Tail Light Kit, Includes: (2) Tail Lights, (2) Amber Front Marker Lights, (1) License Plate Bracket, (1) 25' Wishbone Trailer Harness, (1) 48' Connector and Mounting Hardware, for Under 80' Wide Trailers	Clamshell	2
73849	Replacement Lens Set, 3 Piece	Blister Card	6



73832

### SQUARE WATERPROOF STOP/TURN/ TAIL LIGHT KIT

- Kit combines submersible trailer lights with wiring, bracket and hardware
- Removal lens to change bulb if necessary
- Gasketed lens seals space between lens and housing
- Lights pre-wired with pigtails for faster wiring
- Easy stud post mounting of lights
- License plate bracket included
- Includes 4-Flat connector and bonded wire for a clean for clean appearance
- Grounds through stud mounting post



7383411

Part Number	Description	Packaging	Master Carton
7383411	Square Tail Light Kit, Includes: (2) Tail Lights, (1) License Plate Bracket, (1) 25' Wishbone Trailer Harness, (1) 48" Connector and Mounting Hardware, for Under 80" Wide Trailers	Clamshell	2



73827

73826



73833

### SQUARE SUBMERSIBLE STOP/TURN/ TAIL LIGHTS



- 4.5 in. square style
- Red screw-on lens
- Easy stud mounting
- For general use on medium and light duty trailers
- Meets department of transportation requirements
- Grounds through mounting studs

Part Number	Description	Packaging	Master Carton
73827	Square Left/Roadside, 8-Function Tail Light for Over 80" Wide Square Trailers, Includes Reflector, Side Marker Light, Side Reflector and License Plate Light	Clamshell	2
73826	Right/Curbside, 7-Function Tail Light for Over 80" Wide Trailers, Includes Reflector, Side Marker Light and Side Reflector	Clamshell	2
73833	Square Tail Light Kit, Includes: (2) Tail Lights, (1) License Plate Bracket, (1) 25' Wishbone Trailer Harness, (1) 48" Connector and Mounting Hardware, for Over 80" Wide Trailers	Clamshell	2



86054

86055



73867

### LOW PROFILE SUBMERSIBLE STOP/ TURN/TAIL LIGHTS



- Submersible built construction
- Low profile ideal for boat trailer channels
- Built in rear reflectors
- Complies with rear lighting requirements over or under 80 in. wide
- Universal mounting hardware included
- Built in rear side marker light with reflex reflectors
- Meets or exceeds all DOT requirements
- Screw on lens

Part Number	Description	Packaging	Master Carton
86055	Low Profile Left/Roadside, 8-Function Tail Light for Over 80" Wide Square Trailers, Includes License Plate Light	Clamshell	2
86054	Low Profile Right/Curbside, 7-Function Tail Light for Over 80" Wide Trailers	Clamshell	2
73867	Low Profile Tail Light Kit, Includes: (2) Tail Lights, (1) License Plate Bracket, (1) 25' Wishbone Trailer Harness, (1) 48" Connector and Mounting Hardware, for Over 80" Wide Trailers	Clamshell	2



73883

## 6 IN. OVAL SEALED STOP/TURN/TAIL LIGHT KIT

- Can be used on roadside or curbside of vehicle or trailer
- Kit includes light, grommet, and wire plug
- Fits most competitive oval lights; popular on commercial market vehicles

Part Number	Description	Packaging	Master Carton
73883	6" Oval Stop/Turn/Tail Light Kit, Red	Blister Card	3
73828	6" Oval Stop/Turn/Tail Light Kit, Red, Light Only	Blister Card	2



73831

## RECTANGULAR SURFACE MOUNT STOP/TURN/TAIL LIGHT

- Multi-function stop/turn/tail light
- Designed for left or right hand side use
- Hardware included

Part Number	Description	Packaging	Master Carton
73831	Rectangular Surface Mount Stop/Turn/Tail Light, Red	Blister Card	3



73822

## ROUND FLUSH MOUNT STOP/TURN/TAIL LIGHT

- Designed for 12-volt systems
- Flange mount; 5.1875 in. diameter red lens mounts with tension ring

Part Number	Description	Packaging	Master Carton
73822	Round Flush Mount Stop/Turn/Tail Light, Red, Metal	Blister Card	3



73830

## ROUND SEALED UNIVERSAL GROMMET STOP/TURN/TAIL LIGHT KIT

- Kit includes 4 in. diameter red stop/turn/tail light, grommet and wire plug
- Replacement on trucks, trailers and other applications

Part Number	Description	Packaging	Master Carton
73830	Round Sealed Universal Grommet Mount Stop/Turn/Tail Light, Red	Blister Card	3



73823

## ROUND STOP/TURN/TAIL LIGHT WITH LICENSE PLATE LIGHT

- 4 in. diameter red screw-on lens with stop/turn/tail light
- Stud-mount design

Part Number	Description	Packaging	Master Carton
73823	Round Stop/Turn/Tail Light with License Plate Light, Red	Blister Card	2

PEDESTAL MOUNT STOP/TURN/TAIL LIGHTS



PEDESTAL MOUNT STOP/TURN/TAIL LIGHTS

- Combination amber and red lenses
- Snap-on lens, mounting requires no rings or screws
- Reflector diameter: 4 in., total height: 5 in.

Part Number	Description	Packaging	Master Carton
73821	Pedestal Mount Stop/Turn/Tail Light, Dual Face, Red and Amber	Blister Card	2
73871	Pedestal Mount Stop/Turn/Tail Light, Single Face, Red	Boxed	2

MAGNETIC TOWING LIGHT KIT

- Ideal when temporary lighting is needed
- Easy hook-up and removal; use with RVs, cars, boats, tow trucks and trailers
- Easy attachment magnetic mounting base
- Features standard 4-Flat plug in connector
- Long 20 ft. cord reach
- Rugged durable construction
- Snap on lens
- Has replaceable 1157 bulbs



Part Number	Description	Packaging	Master Carton
73864	Magnetic Towing Light Kit	Clamshell	2

LED AGRICULTURAL PEDESTAL MOUNT TAIL LIGHTS

- Long life: 100,000 + hours LED
- Designed specifically for the rigors of the Agriculture industry
- Waterproof, heavy-duty
- Vibration-resistant mounting stud
- Stainless steel hardware



Part Number	Description	Packaging	Master Carton
8609900	LED Pedestal Mount Tail Light, Dual Face, Amber	Boxed	4
8610000	LED Pedestal Mount Tail Light, Single Face, Red	Boxed	4

HEAVY DUTY AGRICULTURAL TRANSPORT TRAILER DUAL LIGHT KIT

- Dual AG trailer light kit, 7-Way round pin connector tail light, side marker, turn and stop signal - 3-Wire
- Features left and right side dual lamp units
- 46 ft. round jacket wishbone cable
- Four heavy-duty magnets with 90 lbs. pull force
- Mounting hardware and installation instructions



Part Number	Description	Packaging	Master Carton
86040	Heavy Duty Agricultural Transport Trailer Dual Trailer Light Kit	Bulk	3

86040





### LED SEALED CLEARANCE/SIDE MARKER LIGHTS

- Long life 100,000 + hours LED
- Designed for 12 volt systems
- Attractive chrome plated base
- Non-corrosion ABS acrylic construction
- Environmentally sealed, durable and waterproof design
- 1.25 in. x 2.5 in. rectangular shape
- Snap in lens and light
- Grounds through unit featuring single wire hook up



Part Number	Description	Packaging	Master Carton
73841	LED Sealed Clearance/Side Marker Light, Amber	Blister Card	4
73842	LED Sealed Clearance/Side Marker Light, Red	Blister Card	4



### LED SEALED CLEARANCE/SIDE MARKER LIGHTS

- Long life 100,000 + hours LED
- Hard wired with separate lead and ground wires
- Attractive chrome plated base
- Solid state design
- Amperage draw is lower the incandescent lights
- Environmentally sealed, durable and waterproof design
- 1.25 in. x 3.875 in. rectangular shape



Part Number	Description	Packaging	Master Carton
73848	LED Sealed Clearance/Side Marker Light, Amber	Blister Card	3
73847	LED Sealed Clearance/Side Marker Light, Red	Blister Card	3

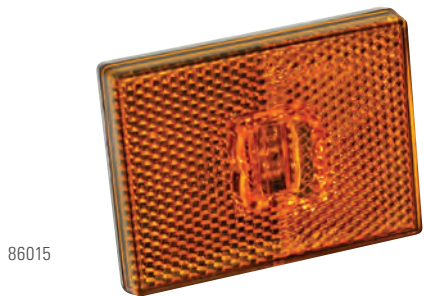

### LED RECTANGULAR CLEARANCE/SIDE MARKER LIGHTS WITH REFLEX LENS

- Long life 100,000 + hours LED
- Hard wired with separate lead and ground wires
- Smooth reflective lens
- Solid state design
- Single stud mounting
- Grounds through mounting hole
- Amperage draw is lower than incandescent lights
- Environmentally sealed, durable and waterproof design
- Compact size and still meets D.O.T. requirements



Part Number	Description	Packaging	Master Carton
8608711	LED Rectangular Clearance/Side Marker Light with Reflex Lens, Amber	Blister Card	3
86015	LED Rectangular Clearance/Side Marker Light with Reflex Lens, Amber, PC-Rated	Blister Card	3



LED WATERPROOF CLEARANCE/SIDE MARKER LIGHTS



8610100      8610200      8610300

LED MICRO LIGHTS

- High intensity LED
- Environmentally sealed design
- Pre-Wired with 12 in. pigtail
- Durable and waterproof



Part Number	Description	Packaging	Master Carton
8610100	LED Micro Light, Amber	Blister Card	4
8610200	LED Micro Light, Red	Blister Card	4
8610300	LED Micro Light, Clear	Blister Card	4



8608500



8608600

LED STUD MOUNT LIGHTS

- Easy stud-mount application
- Stainless mounting hardware included
- Designed for compact areas
- Grounds through mounting stud
- Environmentally sealed, durable and waterproof design
- Features a pre-installed 18 gauge, 7 in. pigtail wire



Part Number	Description	Packaging	Master Carton
8608500	LED Stud Mount Light, Amber	Blister Card	4
8608600	LED Stud Mount Light, Red	Blister Card	4



73862



73863

LED CLEARANCE/SIDE MARKER LIGHTS WITH REFLECTOR

- Long life 100,000 + hours LED
- Dual solid state diode design
- Built in reflex reflector
- Amperage draw is lower than incandescent lights
- Non-corrosive construction
- Environmentally sealed, durable and waterproof design
- 2-Wire plug electrical connections



Part Number	Description	Packaging	Master Carton
73862	LED Clearance/Side Marker Light with Reflector, Amber	Blister Card	4
73863	LED Clearance/Side Marker Light with Reflector, Red	Blister Card	4



73846



73845

LED CLEARANCE/SIDE MARKER LIGHTS

- Polycarbonate base and lens
- Long life 100,000 + hours LED
- Stylish four bulls eye design
- Non corrosion ABS acrylic construction
- Environmentally sealed, durable and waterproof design
- 2 in. x 4 in. rectangular shape
- 2-Wire plug electrical connections



Part Number	Description	Packaging	Master Carton
73846	LED Clearance/Side Marker Light, Amber	Blister Card	4
73845	LED Clearance/Side Marker Light, Red	Blister Card	4



73844



73843

### LED "BEEHIVE" CLEARANCE/SIDE MARKER LIGHTS

- 2 in. diameter
- Semi recessed beehive clearance and marker
- Long life 100,000 + hours LED
- Amperage draw is lower than incandescent lights
- Non-corrosive construction
- Environmentally sealed, durable and waterproof design
- Fits 2.75 in. hole
- 2-Wire plug electrical connections



Part Number	Description	Packaging	Master Carton
73844	LED Beehive Clearance/Side Marker Light, Amber	Blister Card	3
73843	LED Beehive Clearance/Side Marker Light, Red	Blister Card	3



73881



73882

### LED ROUND SEALED CLEARANCE/SIDE MARKER LIGHTS

- 2.5 in. diameter
- Long life 100,000 + hours with 13 LEDs
- Amperage draw is lower than incandescent lights
- Non-corrosive construction
- Solid state design
- Environmentally sealed, durable and waterproof design
- Grommet and plug
- Fits 2.781 in. hole
- Accepts industry standard 2 prong plug



Part Number	Description	Packaging	Master Carton
73881	LED Round Clearance/Side Marker Light, Amber	Blister Card	4
73882	LED Round Clearance/Side Marker Light, Red	Blister Card	4



86052



86053

### LED ROUND SEALED CLEARANCE/SIDE MARKER LIGHTS

- 2.5 in. diameter
- Long life 100,000 + hours with 4 LEDs
- Amperage draw is lower than incandescent lights
- Non-corrosive construction
- Solid state design
- Environmentally sealed, durable and waterproof design
- Grommet and plug
- Fits 2.7825 in. hole
- Accepts industry standard 2 prong plug



Part Number	Description	Packaging	Master Carton
86052	LED Round Clearance/Side Marker Light, Amber	Blister Card	3
86053	LED Round Clearance/Side Marker Light, Red	Blister Card	3

CLEARANCE/SIDE MARKER LIGHTS



86042

86043

**ROUND SEALED CLEARANCE/SIDE MARKER LIGHTS WITH REFLECTOR**

- 2.5 in. diameter
- Features reflector optics, eliminating the need of separate vehicle reflector
- Environmentally sealed, durable and waterproof design
- Fits 2.781 in. mounting hole
- Mounts with round rubber grommet
- Accepts industry standard 2 prong plug



Part Number	Description	Packaging	Master Carton
86042	Round Clearance/Side Marker Light with Reflector, Amber	Blister Card	4
86043	Round Clearance/Side Marker Light with Reflector, Red	Blister Card	4



73877

73878

**ROUND SEALED CLEARANCE/SIDE MARKER LIGHT KITS**

- 2.5 in. diameter
- Complete light kit
- Lens sonically sealed to base housing
- Easy installation in rubber mounting grommet
- Designed for 12 volt systems
- Accepts industry standard 2 prong plug

Part Number	Description	Packaging	Master Carton
73877	Round Clearance/Side Marker Light Kit, Amber	Blister Card	6
73878	Round Clearance/Side Marker Light Kit, Red	Blister Card	6



73873



73874

**OBLONG SLIM LINE CLEARANCE/SIDE MARKER LIGHTS**

- 3.5 in. x 1.125 in. oblong
- Slim line styling
- Designed for 12 volt systems
- Snap on lens
- Fits 2.75 in. mounting hole
- Single wire design, grounds through mounting hardware

Part Number	Description	Packaging	Master Carton
73873	Oblong Slim Line Clearance/Side Marker Light, Amber	Blister Card	4
73874	Oblong Slim Line Clearance/Side Marker Light, Red	Blister Card	4



73801



73802

### OBLONG CLEARANCE/SIDE MARKER LIGHTS WITH REFLEX LENS

- 4 in. x 2 in. oblong
- Designed for 12 volt systems
- Snap on lens
- Non-corrosive construction
- Built-in drain hole

Part Number	Description	Packaging	Master Carton
73844	LED Beehive Clearance/Side Marker Light, Amber	Blister Card	3
73843	LED Beehive Clearance/Side Marker Light, Red	Blister Card	3



73804



73803

### OBLONG DUAL BULB CLEARANCE/SIDE MARKER LIGHTS

- 4 in. x 2 in. oblong
- Designed for 12 volt systems
- Snap on lens
- Non-corrosive construction
- Built-in drain hole

Part Number	Description	Packaging	Master Carton
73804	Dual Bulb Oblong Clearance/Side Marker Light, Amber	Blister Card	4
73803	Dual Bulb Oblong Clearance/Side Marker Light, Red	Blister Card	4



73839



73838

### RECTANGULAR SEALED CLEARANCE/SIDE MARKER LIGHTS

- 1.25 in. x 2.5 in. rectangular
- Compact design
- Chrome plated base
- Non-corrosive construction
- Grounds through mounting screw with single wire hook up

Part Number	Description	Packaging	Master Carton
73839	Rectangular Clearance/Side Marker Light, Amber	Blister Card	4
73838	Rectangular Clearance/Side Marker Light, Red	Blister Card	4



73807



73808

### HEAVY DUTY RECTANGULAR CLEARANCE/SIDE MARKER LIGHTS

- 2 in. x 4.625 in. rectangular
- Armored style light
- Designed for 12 volt systems
- Non-corrosive construction
- Single wire design

Part Number	Description	Packaging	Master Carton
73807	Heavy Duty Rectangular Clearance/Side Marker Light, Amber	Blister Card	3
73808	Heavy Duty Rectangular Clearance/Side Marker Light, Red	Blister Card	3



CLEARANCE/SIDE MARKER LIGHTS



8604900



8608200

**STUD MOUNT CLEARANCE/SIDE MARKER LIGHTS**



- 2.175 in. x 1.125 in. rectangular
- Designed for 12 volt systems
- Non-corrosive construction
- Snap on lens
- Environmentally sealed, durable and waterproof design
- Single wire design, grounds through mounting hardware

Part Number	Description	Packaging	Master Carton
8604900	Stud Mount Clearance/Side Marker Light, Amber	Blister Card	4
8608200	Stud Mount Clearance/Side Marker Light, Red	Blister Card	4

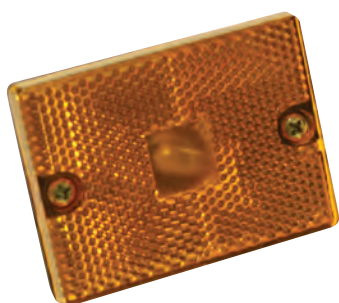

73812

**STUD MOUNT CLEARANCE/SIDE MARKER LIGHT WITH REFLECTIVE LENS**

- 2.875 in. x 2.5 in. rectangular
- Designed for 12 volt systems
- Non-corrosive construction
- Grounds through stud for quicker wiring

Part Number	Description	Packaging	Master Carton
73812	Stud Mount Clearance/Side Marker Light with Reflective Lens, Amber	Blister Card	3



73805



73806

**MINI CLEARANCE/SIDE MARKER LIGHTS**

- 3.125 in. x 2.75 in. rectangular
- Designed for 12 volt systems
- Non-corrosive construction
- Snap on lens
- Built-in drain hole

Part Number	Description	Packaging	Master Carton
73805	Mini Clearance/Side Marker Light, Amber	Blister Card	4
73806	Mini Clearance/Side Marker Light, Red	Blister Card	4



86009

**CAB TEAR DROP MARKER LIGHT**

- 2.125 in. x 5.5 in.
- Interchanges with competitive models
- Molded of corrosion impact resistant thermo form plastic
- Grounds through mounting hardware

Part Number	Description	Packaging	Master Carton
86009	Cab Tear Drop Marker Light, Amber	Blister Card	3



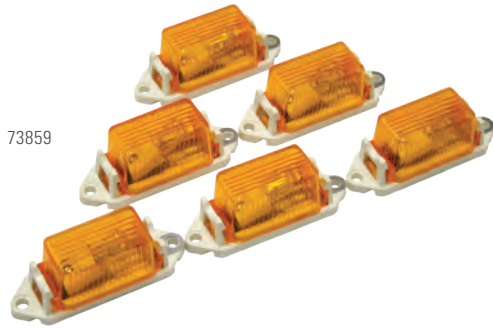

73859

**RUNNING LIGHT KIT**

- 3.125 in. x 2.75 in. rectangular
- 6 Amber lights on white bases
- Provides a custom appearance
- Install on running boards, front, side or back of vehicle
- Great dress up accessory and add visibility
- Easy snap on lens
- Hardware included

Part Number	Description	Packaging	Master Carton
73859	Running Light Kit, 6 Amber Lights	Clamshell	3



73852

**LED ID LIGHT BARS**

- Submersible identification bars for over 80 in. applications
- Environmentally sealed, durable and waterproof design
- Long life 100,000 plus + LED
- Red replaceable LED sealed lights
- Light snaps on-off for easy installation



8608900

Part Number	Description	Packaging	Master Carton
73852	LED ID Light Bar, Black Polycarbonate Bar, Red Mounts on 16" Centers	Blister Card	3
8608900	LED ID Light Bar, Stainless Steel Bar, Red Mounts on 8-1/2" Centers	Blister Card	3



86012

**ID LIGHT BARS**

- Submersible identification bars for over 80 in. applications
- Lights pre-wired for easier installation
- Grounds through mounting hardware



86019

Part Number	Description	Packaging	Master Carton
86012	ID Light Bar, Black Polycarbonate Bar, Red Mounts on 16" Centers	Blister Card	3
86019	ID Light Bar, Stainless Steel Bar, Red Mounts on 8-1/2" Centers	Blister Card	3



73851

**MINI ID LIGHT BARS**

- Economical submersible identification bars for over 80 in. applications
- Painted steel bracket bar
- Grounds through mounting hardware
- Light snaps on-off for easy installation



Part Number	Description	Packaging	Master Carton
73851	Mini ID Light Bar, Painted Steel Bar, Red Mounts on 16" Centers	Blister Card	3

## LICENSE PLATE LIGHTS

- Quick and easy installation
- Chrome plated steel light
- Grounds through unit featuring single wire hook up

73837



Part Number	Description	Packaging	Master Carton
73837	Snap-In License Plate Light, White Lens (2 Units Required for Legal License Illumination)	Clamshell	4
73890	Surface Mount License Plate Light, Clear Lens	Clamshell	3
86013	Stud Mount License Plate Light, Clear Lens	Clamshell	3

73890



86013



## RECTANGULAR INTERIOR DOME LIGHT WITH SWITCH

- Push button on-off switch for easy operation
- Light comes with base mounting gasket
- Designed for 12 volt systems

73894



Part Number	Description	Packaging	Master Carton
73894	Rectangular Interior Dome Light with Switch, Clear Lens	Blister Card	3

## INTERIOR LIGHT WITH SWITCH

- Rocker on-off switch for easy operation
- Metal reflective base for increased light
- Designed for 12 volt systems

73813



Part Number	Description	Packaging	Master Carton
73813	Interior Light with Switch	Blister Card	3

## INTERIOR LIGHT

- Rugged chrome plated steel housing
- Hooded shield to prevent upward glare
- Ideal floor illuminating light
- Designed for 12 volt systems

73815



Part Number	Description	Packaging	Master Carton
73815	Interior Light	Blister Card	4



8611100



8611200

### LED MAGNETIC BASE WORK LIGHTS

LED work lights perfect for exterior use in AG, horse, livestock, RV, industrial and racing applications. Environmentally sealed design with 19 in. extended heavy-duty coiled cord. Magnet base, with protective film, secures in high vibration conditions in a vertical or horizontal position.

- Simple plug-in power adapter for 12V outlet
- Features separate on/off switch with indicator
- Environmentally sealed design with aluminum housing
- Stainless steel mounting stud
- High power, true white, 10W light emission

Part Number	Description	Packaging	Master Carton
8611100	Round LED Magnetic Base Work Light	Litho Box	2
8611200	Rectangle LED Magnetic Base Work Light	Litho Box	2



8609700



8609800

### LED UTILITY LIGHTS

- Environmentally sealed design with aluminum housing
- Stainless steel mounting stud
- High power, true white, 10W light emission
- Designed for 9 – 36 Volt applications
- Features 8 high-output LED diodes

Part Number	Description	Packaging	Master Carton
8609700	Round LED Utility Light	Litho Box	2
8609800	Rectangle LED Utility Light	Litho Box	2

### ROUND TRACTOR/UTILITY LIGHT

- Featuring trapezoidal light beam pattern
- Simple stud post mounting
- Shock resistant rubber housing
- Designed for off road applications
- Adjustable mounting bracket
- Grounds through unit featuring single wire hook up



73840

Part Number	Description	Packaging	Master Carton
73840	Round Tractor/Utility Light	Bulk	2



7065300



### LED LIGHTED HITCH STEP

- Slip-resistant tread surface with raised edges, stays in place while you tow
- Durable high-grade aluminum alloy with black powder-coat finish for extended durability
- Easily connects into OEM vehicle's wiring system via US car OEM style plug-in harness
- Ultra bright LEDs illuminate the area behind the vehicle
- Three function switch for operating different lighting features
- One-tool assembly; no drilling required
- Mounts to Standard and InterLock® 2 in. ball mounts

Part Number	Description	Packaging	Master Carton
7065300	Tow and Go Lighted Hitch Step with LEDs, Stainless Steel Mounting Hardware and Adapter Included	Litho Box	2

EMERGENCY LIGHTS



73814

**LED ROTATING WARNING LIGHT**

- Sealed lens enclosure
- Go-Glo™ LED Indicator plug
- Magnetic shock mount base
- Over 120 flashes per minute
- Dust and water resistant

Part Number	Description	Packaging	Master Carton
73814	LED Rotating Warning Light	Litho Box	16

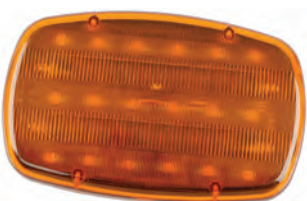

86024



86025

**LED MAGNETIC EMERGENCY LIGHTS**

- Bright wireless LED warning light
- 2 active setting; flash or constant illumination
- Strong magnetic mount
- Option built-in self standing mount for ground use
- Solid-state weather tight construction
- Operates on 4 AA batteries (sold separately)
- Gasket seal on lens

Part Number	Description	Packaging	Master Carton
86024	LED Magnetic Emergency Light, Amber	Litho Box	3
86025	LED Magnetic Emergency Light, Red	Litho Box	3



PD110200

**POD HAZARD**

- Nine different illumination modes, including S.O.S safety mode to alert passing motorists
- Illuminate anything, anywhere with the 350 Lumens lamp and integrated red LED Warning lights
- Durable and weather resistant, easy grip plastic housing is compact (2 in. tall), easy to use and easy to store in the glove box
- Mounts to almost anything with its multiple mounting options including magnet, swivel hook, permanent base, or option for added hook and loop
- Use in the rain or snow
- Visible from 1/4 mile away in daylight conditions
- Use on a trailer, RV, vehicle or as an extra light source in a garage or workshop
- Requires 3 AAA Alkaline batteries per POD (not included)



PD110101

Part Number	Description	Packaging	Master Carton
PD110200	POD Hazard Multi-Use LED Light, (2 Pack)	Clamshell	3
PD110700	POD Hazard Multi-Use LED Light, Countertop Display, (3 Pack)	Litho Box	6
PD110101	POD Hazard Multi-Use LED Light, (1 Pack)	Clamshell	6
PD110302	POD Hazard Multi-Use LED Light Club Pack, Includes: (3) POD Hazard Lights, (9) AAA Batteries, and (1) Compact Storage Bag	Clamshell	6



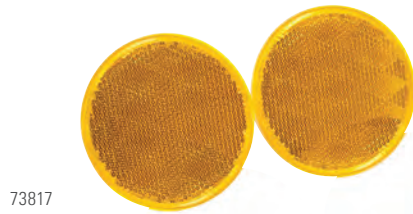

73817



73820

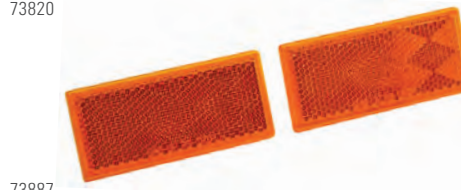

73887



86011

86010

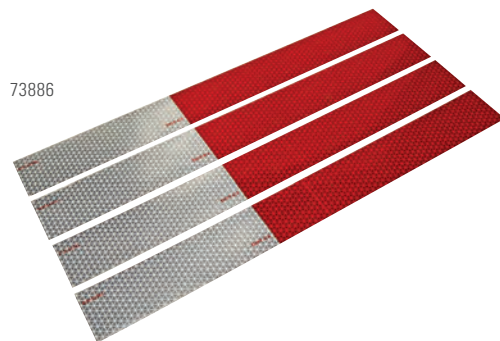

73886

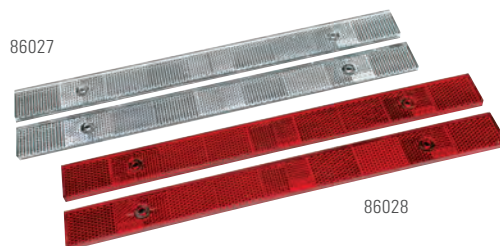

86027

86028

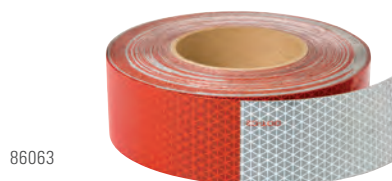

86063

## QUICK MOUNT REFLEX REFLECTORS

- Highly reflective diamond pattern
- Stick-on reflectors will mount on any clean surface
- Durable acrylic construction
- Conforms to FMVSS No. 108
- Includes 2 reflectors

Part Number	Shape	Color	Size (in.)	Packaging	Master Carton
73817	Round	Amber	3-3/16	Blister Card	8
73818	Round	Red	3-3/16	Blister Card	8
73819	Oblong	Amber	4-3/8 x 1-7/8	Blister Card	8
73820	Oblong	Red	4-3/8 x 1-7/8	Blister Card	8
73887	Rectangle	Amber	3-1/8 x 1-3/8	Blister Card	8
73888	Rectangle	Red	3-1/8 x 1-3/8	Blister Card	8

## ALUMINUM REFLEX REFLECTORS

- Low-profile oval housing constructed of rustproof aluminum
- Ideal for safety applications
- 3 in. diameter acrylic lens

Part Number	Description	Packaging	Master Carton
86010	Round Aluminum Reflex Reflector, Amber	Blister Card	12
86011	Round Aluminum Reflex Reflector, Red	Blister Card	12

## CONSPICUITY REFLECTIVE STRIPS

Designed to be detected and reflect light the longest sight distance possible. Very flexible for an easy, stick-on application. Great for wherever extra visibility is desired for safety or to just be noticed.

- Provides longer sight detection distance
- Withstands high-pressure washing and resists edge lift
- Complies to DOT requirements
- 2 in. x 18 in.

Part Number	Description	Packaging	Master Carton
73886	Conspicuity Reflective Strips, (4 Pack)	Blister Card	12

## CONSPICUITY REFLECTORS

- Adhesive will mount on any clean surface, DOT-C Rated
- 1 in. x 12 in.

Part Number	Description	Packaging	Master Carton
86027	Conspicuity Reflector, Clear	Blister Card	12
86028	Conspicuity Reflector, Red	Blister Card	12

## CONSPICUITY REFLECTIVE TAPE ROLL

- Adhesive will mount on any clean surface, DOT-C Rated
- 2 in. x 150 ft.

Part Number	Description	Packaging	Master Carton
86063	Conspicuity Reflective Tape Roll	Blister Card	1



**LIGHTED RECEIVER TUBE COVERS AND EMBLEMS**



**LIGHTED RECEIVER TUBE COVERS**

REESE® Towpower offers a variety of LED-lighted hitch covers that provide low illumination with taillights on and high illumination when the brakes are applied. When not illuminated, the hitch cover is in the standard vehicle logo colors. This is a great way to customize your ride with a different look than the other vehicles on the road. Our logo hitch covers are fully licensed and ready to shine. Unique one-of-a-kind lighted hitch covers display standard logos at daytime, then glow at night.

- Fits 1-1/4 in. and 2 in. hitches
- Long life: LED light powered
- LOW illumination with taillights, HIGH illumination with brakes
- Officially licensed and patented
- Plug & Play features allows for quick and easy installation

Part Number	Description	Packaging	Master Carton
<b>Chrome Finish</b>			
86061	GMC Lighted Tube Cover	Display Card	3
86062	Chevrolet Bow Tie Lighted Tube Cover	Display Card	3
86065	Ford Lighted Tube Cover	Display Card	3
86066	RAM Lighted Tube Cover	Display Card	3
86523	Skull Lighted Tube Cover	Display Card	3
<b>Black Finish</b>			
86530	Chevrolet Bow Tie Lighted Tube Cover	Display Card	3
86532	Ford Lighted Tube Cover	Display Card	3
86531	RAM Lighted Tube Cover	Display Card	3
86529	Skull Lighted Tube Cover	Display Card	3



**LIGHTED LOGO EMBLEMS**

- Long life: LED-light powered, LOW illumination with tail lights, HIGH illumination with brake lights
- Officially licensed and patented
- Complete installation kit
- Chrome finish

Part Number	Description	Packaging	Master Carton
<b>Black Finish</b>			
86618	Chevrolet Lighted Logo Emblem	Bulk	24
86619	RAM Lighted Logo Emblem	Bulk	24
86620	Ford Lighted Logo Emblem	Bulk	24



8612000

### LED TAILGATE LIGHT BAR

The REESE® Towpower Multi-Function Tail Light Bar includes high-output LEDs that span the width of your vehicle. At 60 in. long, you can illuminate the tail light, turn signals, brake lights, and backup lights in a new, aesthetically pleasing appearance. This creates a unique look for the back of your vehicle while adding additional lighting when backing up. Installation couldn't be easier.

- 4 functions – tail, turn, brake and backup
- Pre-Wired 4-Flat connection, weather resistant
- Simple snap/click assembly, hardware included

Part Number	Description	Packaging	Master Carton
8612000	LED Tailgate Light Bar, 60"	Blister Card	4



Tail Light



Brake and Turn Lights



Backup Light



86104

### LED FLEXIBLE LIGHT STRIPS

- Cut to length, 54 diodes per strip
- Easy termination of wires
- Offered in 36 in. strips
- Backed with 3M adhesive

Part Number	Description	Packaging	Master Carton
8610400	LED Light Strip, Red	Blister Card	4
8610600	LED Light Strip, Amber	Blister Card	4
8610700	LED Light Strip, White	Blister Card	4



8609000

8609600

### LED STROBE STRIPS

Professional Series High Power LED Amber Strobe Light offers an adjustable mounting bracket to handle various mounting angles. Designed for rugged use it features a variety of flashing modes.

- 7 Optional flashing modes
- Bright easy to see long life LED amber light
- Dirt and moisture resistant
- Durable rust resistant aluminum housing
- Operating temperature: -20C to + 55C

Part Number	Description	Packaging	Master Carton
8609000	LED Strobe Light, Amber	Litho Box	4
8609600	LED Strobe Light, Clear	Litho Box	4



8609444



8609244



8609344

**LAST CHANCE**

**LIGHTED LOGO EMBLEMS**

Part Number	Description	Substitute Part Number	Packaging	Master Carton
<b>Chrome Finish</b>				
8609244 †	Chevrolet Lighted Logo Emblem		Bulk	1
8609344 †	RAM Lighted Logo Emblem		Bulk	1
8609444 †	Ford Lighted Logo Emblem		Bulk	1

† = Available while supplies last

NOTES

Lined area for notes, consisting of multiple horizontal dashed lines.



# TRAILER AND VEHICLE ACCESSORIES

REESE® Towpower manufactures a comprehensive line of trailer and vehicle accessory products for recreational vehicles including boats, ATV's and motorcycles. We pioneered the technology that has set the standard for today's most advanced towing systems. Whether you're hauling lumber and bricks to a job site or loading up your snowmobile and heading for the mountains, REESE® Towpower has a diverse line of towing products to safely get you where you're going. We cater to the towing needs of everyone from recreation enthusiasts to heavy-duty agriculture users.

At REESE® Towpower, we continue to innovate new ways to help you transport your gear more safely and efficiently. This dedication to superior quality is what sets us apart from the competition ... and what has made us the number one brand in the towing industry for decades.

## BREAKAWAY SYSTEMS

Push To Test.....	H-2
Switches.....	H-2

## TRAILER ACCESSORIES

Safety Chains.....	H-3
Safety Cables.....	H-3
Tow Hooks.....	H-3
Spare Tire Carriers.....	H-4
Hitch Alignment Tool.....	H-5
Pullers.....	H-6
Hoists.....	H-6
Wheel Chocks.....	H-7

DISCONTINUED PRODUCTS.....	H-9
----------------------------	-----

## WHEEL PROTECTION

Wheel Bearing Kits.....	H-4
Plastic Fenders.....	H-5

## VEHICLE ACCESSORIES

Adjustable Tow Bars.....	H-4
Wide Angle Mirrors.....	H-4
LED Roadside Warning Device.....	H-5
Trailer Alignment Tool.....	H-5

## MARINE TRAILER ACCESSORIES

Motor Support Brackets.....	H-7
Canoe Loader.....	H-7
Marine Grade Carpeting.....	H-7
Tie Downs.....	H-8





50-85-320

### PUSH TO TEST BREAKAWAY SYSTEMS

This REESE® Towpower trailer breakaway system features a push-to-test button that instantly indicates the charge level of the battery. Breakaway systems are designed to apply the brakes if the trailer becomes disconnected from the tow vehicle's hitch while in motion. This type of device is required in many States and Provinces as a safety precaution.

- Push to Test: LED's indicate fully charged or recharge
- Built in battery charger charges battery when plugged into the tow vehicle
- Breakaway Switch with 7.5 in. or 48 in. lead wires
- 5 Amp/hr Battery
- Activates trailer brakes upon separation of trailer and tow vehicle
- For use on 1, 2, or 3 axle trailers equipped with electric brakes
- 2 or 3 mounting options
- Note: Make sure battery is fully charged prior to towing



85062

Part Number	Description	Packaging	Master Carton
50-85-315	Push to Test Breakaway System for 1 to 3 Axle Trailers with Electric Brakes, 2 Mounting Options, Includes Battery Box, 5 Amp Battery with Push to Test LED Test Meter and 7.5" Breakaway Switch	Bulk	10
85062	Push to Test Breakaway System for 1 to 3 Axle Trailers with Electric Brakes, 2 Mounting Options, Includes Battery Box, 5 Amp Battery with Push to Test LED Test Meter and 7.5" Breakaway Switch	Boxed	2
50-85-320	Push to Test Breakaway System with ABCD charger for 1 to 3 Axle Trailers with Electric Brakes, 3 Mounting Options, Includes Battery Box, 5 Amp Battery with Push to Test LED Test Meter, and 48" Breakaway Switch	Bulk	10
5085115	Optional Post Mount Bracket	Bulk	48

NOTE: 3 and 4 axle trailers require minimum 5 Amp-hr battery. For optimal performance, replacement of breakaway electrical components is recommended every 3 to 5 years.



8507311

8506300

### BREAKAWAY SWITCHES

This REESE® Towpower trailer breakaway switch features an LED indicator to confirm the switch is actively functioning. The nylon coated lanyard keeps rust from running down the side of the trailer. Breakaway switches are part of the system that is designed to apply the brakes if the trailer becomes disconnected from the tow vehicle's hitch while in motion. This type of device is required in many States and Provinces as a safety precaution. Emergency use only, not to be used to lock brakes when parked or stored.

- Weather resistant sealed switch
- Scratch resist nylon coated cable
- 48 in. cable to easily reach you tow vehicle
- Strong rust resistant nylon push in plug
- Metal swivel mounting bracket
- Weld able mounting is desired
- Weather-tight O-ring seal
- Switch securely riveted to mounting bracket

Part Number	Description	Packaging	Master Carton
8507311	Breakaway Switch with LED Test Light	Clamshell	3
8506300	Breakaway Switch	Clamshell	3

**SAFETY CHAINS**

- Safety chains are required by law in most states
- Bright zinc finish



7007700

Part Number	Description	Capacity (lbs.)	Length (in.)	Packaging	Master Carton
7025700	Safety Chain with 2 Quick Link Ends	2,000	72	Plastic Shroud	2
74059	Safety Chain with 2 Quick Link Ends	5,000	72	Plastic Shroud	2
7007700	Safety Chain with 2 "S" Hook Ends	2,000	72	Plastic Shroud	2
7007800	Safety Chain with 2 Quick Link Ends	5,000	72	Plastic Shroud	2
72786	Safety Chain with 1 Quick Link End and 1 U-Bolt End	5,000	36	Plastic Shroud	2
7007600	Safety Chain with 1 Quick Link End and 1 U-Bolt End	5,000	36	Plastic Shroud	2

*† = Available While Supplies Last*



7007500

**SAFETY CABLES**

- Zinc coated hooks with spring loaded safety latch
- Vinyl coating protects against rust

Part Number	Description	Capacity (lbs.)	Length (in.)	Packaging	Master Carton
7007500	Heavy-Duty Forged Safety Cables (2 Pack)	5,000	40	Plastic Shroud	3



7007900

7008000

**QUICK LINKS**

- For use with safety chains or as tie-downs
- Chrome finish

Part Number	Description	Capacity (lbs.)	Size (in.)	Packaging	Master Carton
7007900	Quick Links (2 Pack)	5,000	5/16	Plastic Shroud	6
7008000	Quick Links (2 Pack)	3,500	1/4	Plastic Shroud	6



7007400

**TOW HOOK**

- Black powder coating for ultimate corrosion resistance
- Perfect for off road use
- Includes lock washer, nuts and bolts

Part Number	Description	Capacity (lbs.)	Packaging	Master Carton
7007400	Black Bolt-On Tow Hook	10,000	Bulk	3

72791



### WHEEL BEARING KITS

- For use on boat, utility, snowmobile and RV trailers
- Permits easy lubrication for longer life
- Keeps water and dirt out
- Easy to install

Part Number	Description	Hub Diameter (in.)	Packaging	Master Carton
72791	Wheel Bearing Kit, 1"	-	Boxed	6
74176	Wheel Bearing Protector Set	1.781	Clamshell	2
74177	Wheel Bearing Protector Set	1.980	Clamshell	2

† = Available While Supplies Last

74177



### SPARE TIRE CARRIERS

- Mounts to most RV, marine and utility trailer frames
- Heavy-duty 1/2 in. diameter construction
- Bright zinc finish

7016300

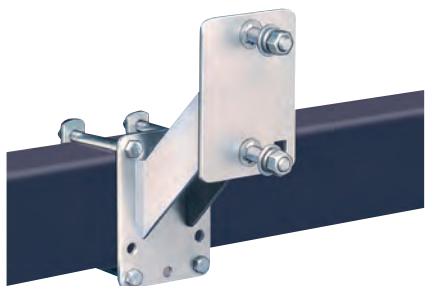

Part Number	Description	Rim Size (in.)	Lugs	Packaging	Master Carton
74247	Economy Spare Tire Carrier	8, 9, 12, 13, 14 and 15	4 and 5	Clamshell	6
7016300	High Mount Spare Tire Carrier		4 and 5	Clamshell	4

† = Available While Supplies Last

7014200



### ADJUSTABLE TOW BARS

- For use with cars and light trucks
- Includes 2 in. coupler and one set of universal bumper brackets
- Base plate may be required
- Safety chains required by law in most states
- Limited lifetime warranty

74344



Part Number	Description	Capacity (lbs.)	Packaging	Master Carton
7014200	Adjustable Tow Bar, Split Rail	5,000	Litho Box	1
74344	Adjustable Tow Bar, Solid Rail	5,000	Litho Box	1

7044000



### WIDE ANGLE MIRRORS

- Wide angle convex mirrors
- Helps reduce dangerous blind spots
- Weather resistant
- Easy to install
- Adhesive back

Part Number	Description	Packaging	Master Carton
7044000	Wide Angle Mirrors, 2" Diameter, (2 Pack)	Blister Card	6



5085

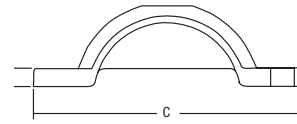
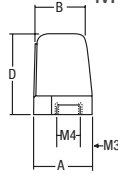
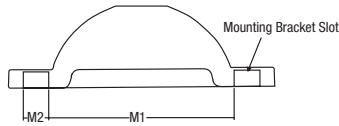

### PLASTIC FENDERS

- High density polyethylene (HDPE) fenders
- Injection molded
- Corrosion proof
- Impact resistant, 300 lbs. capacity
- Molded-in color is "scratch proof"
- Built-in fender skirt
- Integral step pad
- Handles temperature extremes
- Mounting slots

Part Number	Tire Size (in)	Measurements (See Diagram)										Packaging	Master Carton
		A (in.)	B (in.)	C (in.)	D (in.)	E (in.)	F (in.)	M (1) (in.)	M (2) (in.)	M (3) (in.)	M (4) (in.)		
508573	13	9.000	7.700	40.00	12.00	—	2.750	28.00	4.000	2.120	3.750	Bulk	1
508574	14	9.700	8.000	43.40	12.75	—	3.000	30.00	4.000	2.120	3.750	Bulk	1



PD110700

### POD HAZARD MULTI-USE LED ROADSIDE WARNING DEVICE

- Whether it's a flat tire, a warning light, or an overheated engine, vehicle trouble can occur at any time, and you'll want to do everything possible to keep yourself, and the ones you love as safe as possible
- Be prepared. Be seen with the POD Hazard
- When you need extra light at home, in the garage, at a camp site or simply in the yard, POD Hazard's ultra-bright utility light is ready when you are. Simply hang it, prop it up, or aim it, and it's ready to provide you with more than 350 lumens of light

Part Number	Description	Packaging	Master Carton
PD110200	POD HAZARD Multi-Use LED Roadside Warning Device, Batteries Sold Separately, (2 Pack)	Clamshell	3
PD110700	POD HAZARD Counter Top Display, Includes (3) PD110200, Batteries Sold Separately	Litho Box	6
PD110101	POD HAZARD, Batteries Sold Separately, (1 Pack)	Clamshell	6
PD110302	POD HAZARD, Club Pack, Includes (3) PD110200 and Batteries	Clamshell	6



7012900

### SOLO HITCH ALIGNMENT SYSTEM

- Convenient one-person hitch alignment system
- Magnetic base for fast, easy location
- Rods adjust up to 42 in.
- Align trailer and hitch on first attempt
- Bright optic yellow balls

Part Number	Description	Packaging	Master Carton
7012900	Solo Hitch Alignment System	Clamshell	3



7067000



### CABLE PULLERS

- All steel construction
- Drop forged hooks with spring action safety latches
- Twin-drive gear and pawl
- Heavy-duty steel cable with swivel yoke
- Easy thumb-control lever release
- Non-slip rubber grip handle

Part Number	Description	Pull Length (ft.)	Capacity (lbs.)	Packaging	Master Carton
7067000	2.5-Ton Cable Puller - Double Line, Steel Gear and Pawl	6	5,000	Litho Box	2

7067100



### WEBBING PULLER

- Twin-drive gear and pawl
- Heavy-duty polyester webbing, plus swivel yoke
- Easy thumb-control lever release
- Non-slip rubber grip handle

Part Number	Description	Pull Length (ft.)	Capacity (lbs.)	Packaging	Master Carton
7067100	1-Ton Webbing Puller, Aluminum Gear and Pawl	8	2,000	Litho Box	2

7067200



### ROPE HOIST

- Perfect for hunting, boating, farming, the shop, and so much more
- Strong, long-lasting, durable rope

Part Number	Description	Rope Length (ft.)	Capacity (lbs.)	Packaging	Master Carton
7067200	1/2-Ton Rope Hoist	50	1,000	Litho Box	4

7067400



### CHAIN HOISTS

- Forged 360° swivel hooks
- Mechanical safety brake load
- Protective steel housing
- Portable for indoor or outdoor use

Part Number	Description	Capacity (lbs.)	Pull Chain (ft.)	Lift (ft.)	Packaging	Master Carton
7067300	1 Ton Chain Hoist	2,000	8-1/2	10	Litho Box	1
7067400	3 Ton Chain Hoist	6,000	8-1/2	10	Litho Box	1





7015500

### MOTOR SUPPORT BRACKETS

- Shock absorbing
- Load meter identifies downward force absorbed by bracket
- Protects motor lower unit from road vibration and rough surfaces
- Black powder coated for rust protection
- Reinforced molded poly V-block for extra strength and durability
- Easily removable for storage

Part Number	Description	Packaging	Master Carton
7015500	Adjustable Motor Support Bracket	Litho Box	6
7015600	Motor Support Bracket	Litho Box	6



7016000

### MARINE GRADE CARPETING

- Marine grade carpeting allows the do-it-yourselfer to replace worn and dirty carpet on bunk trailers
- Protects your boat by reducing scratching on the hull and keeps it in like-new condition

Part Number	Description	Packaging	Master Carton
7016000	Black Bunk Carpeting, 8 in. x 12 ft.	Sleeve	4



7018100

### CANOE LOADER

- Allows one person to quickly load and unload a canoe or kayak
- Simply and quickly mounts to trailer hitch
- Includes adapter mount that allows towing while using this canoe loader
- Features adjustable hardware
- Fits most cars, trucks and suvs

Part Number	Description	Packaging	Master Carton
7018100	Canoe Loader	Boxed	1



7000100

### WHEEL CHOCKS

- Reduces the risk of trailer roll
- Fits most trailer wheels

Part Number	Description	Packaging	Master Carton
7000100	Wheel Chock, up to 17" Wheels	Litho Box	6
7074300	Heavy Duty Wheel Chock, up to 31-1/2" Wheels	Display Label	1
7000300	Trailer Jack Caster Wheel Chock, up to 8" Casters	Display Label	6



7000300



2060000

### BOW TIE DOWNS

- Coated steel hooks protect boat's finish
- For use in combination with a gunwale or transom tie down
- 1 in. webbing with S hooks
- Includes 2 tie downs



Part Number	Description	Capacity (lbs.)	Length (in.)	Packaging	Master Carton
2060100	Bow Tie Downs, (2 Pack)	300/900	36	Clamshell	4
2060000	Bow Tie Downs, (2 Pack)	400/1,200	36	Clamshell	4



2061300

### GUNWALE TIE DOWNS

- Coated steel hooks protect boat's finish
- Contoured release button provides a smooth release every time
- 2 in. webbing with S hooks



Part Number	Description	Capacity (lbs.)	Length (in.)	Packaging	Master Carton
2061300	Gunwale Tie Down	833/2,500	13	Plastic Shroud	3
2061400	Gunwale Tie Down	833/2,500	16	Plastic Shroud	3



2060300

### TRANSOM TIE DOWNS

- Lock in place to eliminate slippage
- Protective coating prevents scratches
- 2 in. webbing with S hooks
- Includes 2 tie downs



Part Number	Description	Capacity (lbs.)	Length (in.)	Packaging	Master Carton
2060400	Transom Tie Downs, (2 Pack)	833/2,500	24	Plastic Shroud	4



2060400

### RETRACTABLE TRANSOM TIE DOWNS

- Strap retracts for easy storage when not in use
- Easily bolt onto trailer with included hardware
- 2 in. webbing with S hooks
- Includes 2 tie downs



Part Number	Description	Capacity (lbs.)	Length (in.)	Packaging	Master Carton
2060200	Retractable Transom Tie Downs, (2 Pack)	600/1,800	43	Plastic Shroud	3
2060300	Retractable Transom Tie Downs, (2 Pack)	833/2,500	43	Plastic Shroud	3



7075300

**LAST CHANCE**

**SAFETY CHAINS**

Part Number	Description	Substitute Part Number	Packaging	Master Carton
7075300†	Safety Chain with 2 Carabiner Safety Hooks		Clamshell	4



72790

**LAST CHANCE**

**WHEEL BEARING KITS**

Part Number	Description	Substitute Part Number	Packaging	Master Carton
72790†	Wheel Bearing Kit, 1-1/4"		Boxed	6
7036700†	Wheel Bearing Protector Set		Clamshell	6



7036700

**LAST CHANCE**

**SPARE TIRE CARRIERS**

Part Number	Description	Substitute Part Number	Packaging	Master Carton
7019200†	Spare Tire Carrier with Lock		Clamshell	6

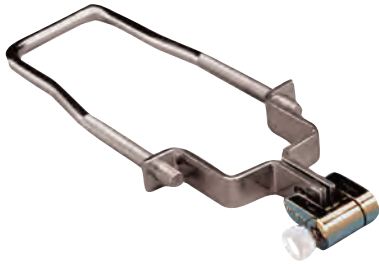

7019200

**LAST CHANCE**

**WIDE ANGLE MIRRORS**

Part Number	Description	Substitute Part Number	Packaging	Master Carton
7043700†	Wide Angle Mirrors, 3" Diameter, (2 Pack)		Blister Card	6



7043700



† = Available while supplies last

NOTES

Lined area for notes, consisting of multiple horizontal dashed lines.



# WARRANTIES AND PRODUCT INDEX

All products are covered by warranty for a minimum of one (1) year. Some products have longer warranty coverage periods. Please review the information on the following pages for warranty details across the product line.

Find products quickly by using our index. Look up product information, page numbers and fitments by part number. All part numbers are listed numerically.

## WARRANTIES

Limited Lifetime Warranty .....	I-2
Limited Warranties .....	I-2

<b>PRODUCT INDEX</b> .....	I-35 - I-40
----------------------------	-------------

## PRODUCT APPLICATION INDEX

Class I Receivers .....	I-3 - I-6
Class II Receivers .....	I-6 - I-8
Class III Receivers .....	I-8 - I-15
Class IV Receivers .....	I-8 - I-15
Class III/IV Multi-Fit Receivers .....	I-15 - I-18
Class V Receivers .....	I-18 - I-20
Class V Heavy Duty Receivers .....	I-20
Front Mounted Receivers .....	I-20 - I-22
Brake Control Harnesses .....	I-22 - I-24
T-Connectors .....	I-24 - I-30
Tow Harnesses .....	I-30 - I-32
6-Way and 7-Way Connectors .....	I-32 - I-33



# CLASS I RECEIVER HITCH INDEX

PART NO.	YEARS	MAKE/MODEL	REC SIZE	IN
<b>CLASS I RECEIVER</b>				
<b>77001†</b>	88-90	Pontiac Grand Prix Except SE & Turbo	1-1/4	40
	88-93	Oldsmobile Cutlass Supreme 2 Dr. FWD	1-1/4	40
	88-94	Buick Regal 2 Dr.	1-1/4	40
	90-94	Chevrolet Lumina Except Z-34	1-1/4	40
	91-93	Pontiac Grand Prix Except Turbo	1-1/4	40
	91-94	Buick Regal 4 Dr., Except GS/Limited	1-1/4	40
	92-97	Oldsmobile Cutlass Supreme 4 Dr. FWD	1-1/4	40
<b>77002†</b>	03-04	Mercury Marauder	1-1/4	25
	79-82	Ford LTD	1-1/4	25
	79-82	Mercury Marquis Sedan	1-1/4	25
	79-82	Mercury Marquis Wagon	1-1/4	25
	80-83	Lincoln Mark VI	1-1/4	25
	81-02	Lincoln Town Car	1-1/4	25
	83-11	Mercury Grand Marquis	1-1/4	25
	83-86	Ford LTD Country Squire Wagon	1-1/4	25
	83-86	Mercury Grand Marquis Colony Park Wagon	1-1/4	25
	83-91	Ford LTD Crown Victoria	1-1/4	25
	83-91	Ford LTD Crown Victoria Wagon	1-1/4	25
	87-91	Mercury Colony Park Wagon	1-1/4	25
	92-09	Ford Crown Victoria	1-1/4	25
<b>77005</b>	93-02	Toyota Corolla Sedan	1-1/4	30
	93-97	GEO Prizm	1-1/4	30
	98-02	Chevrolet Prizm	1-1/4	30
<b>77013</b>	94-97	Honda Accord	1-1/4	30
<b>77014</b>	91-02	Saturn SL 4 Dr. Sedan	1-1/4	40
	91-02	Saturn SL1 4 Dr. Sedan	1-1/4	40
	91-02	Saturn SL2 4 Dr. Sedan	1-1/4	40
	91-92	Saturn SC 2 Dr. Coupe	1-1/4	40
	93-01	Saturn SW2 Wagon	1-1/4	40
	93-02	Saturn SC1 2 Dr. Coupe	1-1/4	40
	93-02	Saturn SC2 2 Dr. Coupe	1-1/4	40
	93-99	Saturn SW1 Wagon	1-1/4	40
<b>77015</b>	89-95	Suzuki Sidekick	1-1/4	20
	89-97	GEO Tracker	1-1/4	20
	96-98	Suzuki Sidekick Except Sport Model	1-1/4	20
	96-98	Suzuki X-90	1-1/4	20
	98-98	Chevrolet Tracker	1-1/4	20
<b>77016</b>	97-06	Jeep TJ (Canada Only)	1-1/4	15
	97-06	Jeep Wrangler	1-1/4	15
<b>77017</b>	86-03	Ford Taurus 4 Dr. Sedan	1-1/4	20
	86-03	Ford Taurus Wagon	1-1/4	20
	86-03	Mercury Sable Sedan	1-1/4	20
	86-03	Mercury Sable Wagon	1-1/4	20
	88-02	Lincoln Continental	1-1/4	20
	96-99	Ford Taurus 4 Dr. Sedan, Except SHO	1-1/4	20
<b>77019†</b>	90-93	Honda Accord	1-1/4	20
<b>77023</b>	02-06	Suzuki XL-7	1-1/4	15
	99-04	Chevrolet Tracker	1-1/4	15
	99-04	Suzuki Vitara	1-1/4	15
	99-05	Suzuki Grand Vitara	1-1/4	15
<b>77025</b>	92-00	Honda Civic	1-1/4	15
	97-01	Acura EL (Canada Only)	1-1/4	15
<b>77026</b>	02-10	Volkswagen Beetle Except Turbo S	1-1/4	30
	07-10	Volkswagen Golf City (Canada Only)	1-1/4	30
	98-01	Volkswagen Beetle	1-1/4	30
	99-06	Volkswagen Golf	1-1/4	30
<b>77028</b>	02-04	Infiniti I35	1-1/4	30
	95-03	Nissan Maxima Sedan	1-1/4	30
	96-01	Infiniti I30	1-1/4	30
<b>77029</b>	94-98	Ford Mustang	1-1/4	20
	99-04	Ford Mustang Except Cobra SVT	1-1/4	20
<b>77030†</b>	02-05	Hyundai Sonata	1-1/4	15
<b>77033</b>	02-05	Honda Civic Si	1-1/4	30
	02-06	Acura RSX	1-1/4	30
<b>77034</b>	03-04	Honda Element	1-1/4	25
	05-11	Honda Element Except SC	1-1/4	25
<b>77035</b>	97-04	Toyota Camry 4 Dr. Sedan	1-1/4	15
	99-03	Toyota Solara	1-1/4	15
<b>77039</b>	99-05	Volkswagen Passat 4 Dr. Sedan, Except 4 Motion & W8 Engine	1-1/4	40
	99-05	Volkswagen Passat Wagon, Except 4 Motion & W8 Engine	1-1/4	40
<b>77040†</b>	97-04	Oldsmobile Silhouette	1-1/4	30
	97-05	Chevrolet Venture	1-1/4	30
	97-98	Pontiac Trans Sport	1-1/4	30
	99-05	Pontiac Montana	1-1/4	30
<b>77044†</b>	02-05	KIA Rio	1-1/4	20
<b>77048</b>	03-06	Mitsubishi Outlander	1-1/4	40
<b>77049</b>	00-01	Chevrolet Cavalier	1-1/4	40
	03-05	Pontiac Sunfire	1-1/4	40

PART NO.	YEARS	MAKE/MODEL	REC SIZE	IN
<b>77049</b>	95-02	Chevrolet Cavalier Except Z-24	1-1/4	40
	95-99	Pontiac Sunfire Except GT	1-1/4	40
<b>77050</b>	03-07	Saturn Ion Except Redline & w/2.4 Liter Engine	1-1/4	35
<b>77051†</b>	03-06	Subaru Baja	1-1/4	20
<b>77052†</b>	00-01	Plymouth Neon	1-1/4	20
	00-05	Dodge Neon	1-1/4	20
<b>77053†</b>	00-05	Hyundai Accent	1-1/4	20
<b>77063</b>	94-01	Acura Integra	1-1/4	40
<b>77065†</b>	94-98	Volkswagen Jetta Jetta III	1-1/4	30
<b>77069†</b>	00-02	Pontiac Sunfire	1-1/4	40
	03-05	Chevrolet Cavalier LS Sport	1-1/4	40
	03-05	Chevrolet Cavalier Z-24 (Canada Only)	1-1/4	40
	95-02	Chevrolet Cavalier Z-24	1-1/4	40
	95-99	Pontiac Sunfire GT	1-1/4	40
<b>77076</b>	97-05	Chevrolet Malibu 4 Dr.	1-1/4	15
	97-99	Oldsmobile Cutlass 4 Dr., FWD	1-1/4	15
<b>77077†</b>	97-04	Buick Regal (App. starts with 97-1/2)	1-1/4	20
	97-08	Pontiac Grand Prix	1-1/4	20
<b>77080†</b>	99-03	Mazda Protege	1-1/4	20
<b>77082†</b>	00-05	Chevrolet Impala	1-1/4	20
<b>77089</b>	01-06	Hyundai Elantra	1-1/4	15
<b>77091</b>	02-07	Subaru Impreza Except WRX STi	1-1/4	30
	93-01	Subaru Impreza	1-1/4	30
<b>77092</b>	01-06	Chrysler Sebring Convertible	1-1/4	15
<b>77096</b>	05-06	Nissan X-Trail (Canada Only)	1-1/4	45
<b>77097</b>	04-09	Suzuki Swift+ 5 Dr. (Canada Only)	1-1/4	30
	04-11	Chevrolet Aveo 5 Dr. Hatchback	1-1/4	30
	05-07	Pontiac Wave 5 Dr. (Canada Only)	1-1/4	30
	08-08	Pontiac Wave5 (Canada Only)	1-1/4	30
	09-09	Pontiac G3 5 Dr.	1-1/4	30
	09-09	Pontiac G3 Wave 5 Dr. (Canada Only)	1-1/4	30
<b>77099†</b>	05-09	KIA Spectra Except Spectra5	1-1/4	20
<b>77106</b>	07-09	Volkswagen Jetta City Sedan (Canada Only)	1-1/4	30
	99-05	Volkswagen Jetta Sedan, Except Gas Turbo & Wagon	1-1/4	30
<b>77107</b>	96-05	Toyota RAV4	1-1/4	15
<b>77109</b>	97-03	Pontiac Grand Prix SE Sedan	1-1/4	30
	97-05	Buick Century Sedan	1-1/4	30
	98-02	Oldsmobile Intrigue	1-1/4	30
<b>77111†</b>	96-00	Hyundai Elantra	1-1/4	30
<b>77112</b>	93-01	Nissan Altima	1-1/4	20
<b>77113†</b>	00-00	Saturn LS	1-1/4	35
	00-00	Saturn LS1	1-1/4	35
	00-00	Saturn LS2	1-1/4	35
	01-02	Saturn L100	1-1/4	35
	01-02	Saturn L200	1-1/4	35
	01-02	Saturn L300	1-1/4	35
	03-03	Saturn LW200 Wagon	1-1/4	35
	03-03	Saturn LW300 Wagon	1-1/4	35
<b>77114</b>	00-04	Ford Focus Sedan	1-1/4	20
	00-06	Ford Focus ZX3 3 Dr. Hatchback, Except SVT & w/ Street Appearance Pkg.	1-1/4	20
	02-06	Ford Focus ZX5 5 Dr. Hatchback, Except SVT & w/ Street Appearance Pkg.	1-1/4	20
	05-07	Ford Focus Sedan, Except w/Street Appearance Pkg.	1-1/4	20
<b>77115</b>	00-02	Ford Focus Wagon (Built Before 11/2002)	1-1/4	20
	03-07	Ford Focus Wagon (Built After 11/2002)	1-1/4	20
<b>77116</b>	01-05	Honda Civic	1-1/4	15
<b>77119†</b>	02-03	Mazda Protege5	1-1/4	15
<b>77122</b>	05-06	Pontiac Pursuit 2 Dr. (Canada Only)	1-1/4	40
	05-06	Pontiac Pursuit 4 Dr. (Canada Only)	1-1/4	40
	05-10	Chevrolet Cobalt 2 Dr., Except SS	1-1/4	40
	05-10	Chevrolet Cobalt 4 Dr., Except SS	1-1/4	40
	07-09	Pontiac G5 Except GT	1-1/4	40
<b>77124†</b>	05-09	Ford Mustang Except GT/CS (California Special)/ Shelby GT/GT500	1-1/4	45
<b>77126</b>	00-06	Nissan Sentra	1-1/4	20
<b>77130</b>	06-12	Mitsubishi Eclipse	1-1/4	30
<b>77131</b>	04-08	Acura TL	1-1/4	35
<b>77132</b>	04-06	Saturn Ion Red Line	1-1/4	25
	05-07	Saturn Ion 3 w/2.4 Liter Engine	1-1/4	25
	05-10	Chevrolet Cobalt SS 2 Dr.	1-1/4	25
	05-10	Chevrolet Cobalt SS 4 Dr.	1-1/4	25
	06-11	Chevrolet HHR	1-1/4	25
	07-09	Pontiac G5 GT	1-1/4	25
	08-08	Chevrolet Cobalt Sport 2 Dr.	1-1/4	25
	08-08	Chevrolet Cobalt Sport 4 Dr.	1-1/4	25
	08-10	Chevrolet HHR SS	1-1/4	35

PART NO.	YEARS	MAKE/MODEL	REC SIZE	IN
77133	06-10	Hyundai Sonata	1-1/4	20
77135	01-10 05-09	Chrysler PT Cruiser Chrysler PT Cruiser Convertible	1-1/4	30
77136	06-11 06-11	Hyundai Accent 4 Dr. Sedan KIA Rio 4 Dr. Sedan	1-1/4	20
77139	06-11 06-11 06-15 06-15 06-15	Honda Civic Si, 2 Dr. Coupe Honda Civic Si, 4 Dr. Sedan Honda Civic 2 Dr. Coupe, Except Si Honda Civic 4 Dr. Sedan, Except Hybrid & Si Honda Civic Hybrid	1-1/4	30
77140†	06-13	Suzuki Grand Vitara Except 3 Dr Hatchback	1-1/4	20
77143	03-07 04-07 05-11 08-13 09-13	Cadillac CTS Cadillac CTS V Cadillac STS Cadillac CTS 4 Dr. Sedan Cadillac CTS V 4 Dr. Sedan	1-1/4	45
77144†	06-08	Acura TSX 4 Dr. Sedan	1-1/4	40
77145	07-07 08-12	Dodge Caliber Dodge Caliber Except SRT-4	1-1/4	15
77147	07-11	Honda CR-V	1-1/4	20
77148†	06-11	Hyundai Azera	1-1/4	20
77149	02-06	Honda CR-V	1-1/4	20
77150	06-10	Mazda 5	1-1/4	25
77152	03-08 04-08 06-06 06-09 06-09 07-09	Mazda 6 4 Dr. Sedan Mazda 6 5 Dr. Hatchback Lincoln Zephyr Ford Fusion Mercury Milan Lincoln MKZ	1-1/4	45
77153	07-08	Honda Fit	1-1/4	25
77154	06-08 06-10 09-10	KIA Optima (App. starts with 2006-1/2) KIA Magentis (Canada Only) KIA Optima	1-1/4	20
77156	04-11 05-10	Volvo S40 Sedan (App. starts with 2004-1/2) Volvo V50 Wagon, Except T5 R-Design	1-1/4	25
77159†	04-07	Mazda 6 Sport Wagon	1-1/4	25
77161	03-07 03-07	Honda Accord Coupe Honda Accord Sedan	1-1/4	25
77162	02-06 04-08	Nissan Altima Nissan Maxima	1-1/4	30
77164	97-01	Honda CR-V	1-1/4	20
77165	01-03 98-02 99-03	Acura CL 3.2 Honda Accord Sedan Acura TL 3.2	1-1/4	15
77166	07-12	Nissan Sentra	1-1/4	30
77167	06-11 07-10 07-11	KIA Rio5 5 Dr. Hatchback Hyundai Elantra 4 Dr. Sedan Hyundai Accent 3 Dr. Hatchback	1-1/4	25
77168	07-19 09-19	Nissan Altima Sedan Nissan Maxima	1-1/4	45
77169†	07-10 11-12	KIA Rondo KIA Rondo (Canada Only)	1-1/4	30
77170	07-11 07-12	Nissan Versa 4 Dr. Sedan Nissan Versa 5 Dr. Hatchback	1-1/4	25
77172†	08-13	Nissan Altima Coupe, Except SR Models	1-1/4	30
77176	08-11	Ford Focus	1-1/4	30
77178	08-11 09-13	Subaru Impreza 4 Dr. Sedan Subaru Forester	1-1/4	35
77179	04-09	Toyota Prius	1-1/4	30
77180†	08-09	Saturn Astra Hatchback	1-1/4	25
77181	06-11	Chevrolet Aveo 4 Dr. Sedan	1-1/4	20
77182†	08-10	Volvo C30	1-1/4	45
77183	03-08 03-13 09-10 14-14	Pontiac Vibe Toyota Matrix Pontiac Vibe Except GT Toyota Matrix (Canada Only)	1-1/4	15
77184†	96-00	Chrysler Sebring Convertible	1-1/4	30
77187	08-13 11-13	Scion xB Except Release Series Scion tC Except Release Series	1-1/4	15
77188	04-09 04-09 06-09 06-09	Mazda 3 4 Dr. Sedan, Except w/Grand Touring LED Taillights Mazda 3 5 Dr. Hatchback, Except w/Grand Touring LED Taillights Mazda 3 4 Dr. Sedan, w/Grand Touring LED Taillights Mazda 3 5 Dr. Hatchback, w/Grand Touring LED Taillights	1-1/4	35

PART NO.	YEARS	MAKE/MODEL	REC SIZE	IN
77189	07-11	Suzuki SX4 Crossover	1-1/4	40
77191	07-11 07-11 09-11	Toyota Yaris 3 Dr. Liftback Toyota Yaris 4 Dr. Sedan Toyota Yaris 5 Dr. Hatchback	1-1/4	20
77193†	08-09	Pontiac G8	1-1/4	45
77194	96-00	Honda Civic 3 Dr. Hatchback	1-1/4	20
77196	07-13	Volkswagen Eos	1-1/4	40
77197	06-09 06-09 07-09 10-13 10-13	Volkswagen GTI 2 Dr. Hatchback Volkswagen Rabbit Volkswagen GTI 4 Dr. Hatchback Volkswagen Golf 2 Dr. Hatchback, Except R Volkswagen Golf Hatchback (Canada Only), Except R	1-1/4	15
77198	09-13	Honda Fit	1-1/4	25
77199	05-10	Scion tC	1-1/4	30
77200	08-10	Scion xD	1-1/4	20
77203†	09-16	Audi A4 4 Dr. Sedan	1-1/4	25
77204	07-08 09-13	Infiniti G35 4 Dr. Sedan Infiniti G37 4 Dr. Sedan	1-1/4	45
77205	09-13	Mazda 6 4 Dr. Sedan	1-1/4	30
77206	06-09 06-09 07-09 07-09 07-09	Pontiac Solstice Pontiac Solstice Pontiac Solstice GXP Pontiac Solstice GXP Saturn Sky	1-1/4	40
77209	07-12	Mitsubishi Galant	1-1/4	30
77210	05-11 06-10	Audi A6 4 Dr. Sedan Audi A6 Quattro Avant Wagon	1-1/4	25
77221	06-10 07-10 09-17	Volkswagen Passat 4 Dr. Sedan, Except 4 Motion Volkswagen Passat Wagon, Except 4 Motion Volkswagen CC Except 4 Motion	1-1/4	35
77223	10-15	Chevrolet Camaro Except Convertible & w/Dealer Installed Ground Effects	1-1/4	15
77224	10-11 12-15	Honda Accord Crosstour Honda Crosstour	1-1/4	40
77226†	10-13	Acura ZDX	1-1/4	25
77229	11-13	Ford Fiesta 4 Dr. Sedan	1-1/4	15
77230	10-13 10-13	KIA Soul Except w/LED Taillights KIA Soul w/LED Taillights	1-1/4	40
77231	07-08 07-11	BMW 328xi Sedan BMW 328i Sedan	1-1/4	45
77233	09-13	Nissan Cube	1-1/4	45
77234	10-13	KIA Forte 4 Dr. Sedan	1-1/4	20
77236	10-15 12-17	Toyota Prius Except w/Plug-In Model Toyota Prius V	1-1/4	25
77238	11-14 11-14	Ford Mustang V6 Models Ford Mustang V8 Models	1-1/4	40
77239	10-11 10-12 10-12	Mercury Milan Ford Fusion Lincoln MKZ	1-1/4	20
77242	05-09	Ford Mustang Except GT/CS (California Special)/Shelby GT/GT500	1-1/4	45
77244	10-13 10-13	Mazda 3 4 Dr. Sedan, Except w/Grand Touring LED Taillights Mazda 3 4 Dr. Sedan, w/Grand Touring LED Taillights	1-1/4	20
77245	10-13 10-13	Mazda 3 5 Dr. Hatchback, Except w/Grand Touring LED Taillights Mazda 3 5 Dr. Hatchback, w/Grand Touring LED Taillights	1-1/4	15
77246	09-12	Hyundai Elantra Touring, 5 Dr.	1-1/4	25
77247	06-11 13-19	Acura CSX (Canada Only) Acura ILX Except Hybrid	1-1/4	30
77248	11-17	Nissan JUKE AWD, Except Nismo & Nismo RS	1-1/4	40
77249	05-14 09-14 10-14	Volkswagen Jetta 4 Dr. Sedan Volkswagen Jetta SportWagon Volkswagen Golf Wagon (Canada Only)	1-1/4	40
77251	12-17	Chevrolet Sonic 4 Dr. Sedan	1-1/4	20
77252	11-14	Mazda 2	1-1/4	30
77253	05-12	Toyota Avalon	1-1/4	40
77254	07-10 07-10 08-14 11-14 11-14	Chrysler Sebring Convertible Chrysler Sebring Except Convertible Dodge Avenger Chrysler 200 4 Dr. Sedan Chrysler 200 Convertible	1-1/4	15
77255	12-19	FIAT 500 Except Abarth	1-1/4	30

# CLASS I RECEIVER HITCH INDEX

PART NO.	YEARS	MAKE/MODEL	REC SIZE	IN
77256	12-14	Ford Focus 5 Dr. Hatchback, Except ST w/Center Exhaust	1-1/4	25
	12-18	Ford Focus Sedan	1-1/4	25
	15-18	Ford Focus 5 Dr. Hatchback, Except ST w/Center Exhaust Models & RS	1-1/4	25
77258†	91-98	Toyota Tercel Sedan	1-1/4	30
77259	95-00	Chevrolet Lumina	1-1/4	30
	95-99	Chevrolet Monte Carlo	1-1/4	30
77261†	01-04	KIA Magentis (Canada Only)	1-1/4	15
	01-06	KIA Optima	1-1/4	15
77262	12-17	Mazda 5	1-1/4	25
77264†	12-13	Volkswagen Beetle Except Convertible & Gas Turbo	1-1/4	20
77265	12-19	Chevrolet Sonic 5 Dr. Hatchback	1-1/4	20
77266	12-13	Volkswagen Beetle Gas Turbo, Except Convertible	1-1/4	30
77267	12-15	Volkswagen Passat 4 Dr. Sedan	1-1/4	30
	16-16	Volkswagen Passat Except SE & SEL	1-1/4	30
	16-16	Volkswagen Passat SE & SEL Only	1-1/4	30
	17-19	Volkswagen Passat	1-1/4	30
77268	12-13	Chevrolet Orlando (Canada Only)	1-1/4	35
77269	11-15	Chevrolet Cruze	1-1/4	15
	12-17	Buick Verano Except Turbo or w/Dual Exhaust	1-1/4	40
	16-16	Chevrolet Cruze Limited Only (Old Body Style)	1-1/4	15
77270	12-16	KIA Rio 5 Dr. Hatchback	1-1/4	30
77272	12-17	Hyundai Accent 4 Dr. Sedan	1-1/4	15
	12-17	Hyundai Accent 5 Dr. Hatchback	1-1/4	15
	12-17	KIA Rio 4 Dr. Sedan, Except S	1-1/4	15
77273	08-17	Mitsubishi Lancer 4 Dr. Sedan, Except Evolution, Ralliart & w/Dual Exhaust	1-1/4	25
	10-14	Mitsubishi Lancer 5 Dr. Hatchback, Except Ralliart & w/Dual Exhaust	1-1/4	25
77274†	08-16	Subaru Impreza 5 Dr. Wagon, Except WRX STi & w/Quad Exhaust Outlets	1-1/4	45
	13-15	Subaru XV Crosstrek Except Hybrid	1-1/4	45
	13-15	Subaru XV Crosstrek Hybrid	1-1/4	45
77275	12-17	Nissan Versa 4 Dr. Sedan	1-1/4	30
77276†	12-16	Subaru Impreza 4 Dr. Sedan, Except WRX & WRX STi	1-1/4	30
77277	12-17	Toyota Prius C	1-1/4	20
77278	13-16	Dodge Dart	1-1/4	20
77280	11-17	Nissan JUKE FWD, Except Nismo & Nismo RS	1-1/4	25
77281	13-15	Chevrolet Spark Except w/Ground Effects	1-1/4	25
77282	13-15	Chevrolet Spark LT w/Ground Effects	1-1/4	25
77284	13-18	Ford C-MAX	1-1/4	25
77285	13-19	Ford Fusion Except Sport	1-1/4	20
	13-19	Lincoln MKZ Except 3.0 Liter Engine	1-1/4	20
77287	08-16	Honda Accord Coupe	1-1/4	30
	08-17	Honda Accord Sedan	1-1/4	30
	09-14	Acura TL	1-1/4	45
	09-14	Acura TSX 4 Dr. Sedan	1-1/4	45
	13-15	Honda Accord Coupe, Except w/LED Taillights	1-1/4	30
	13-15	Honda Accord Sedan, Except w/LED Taillights	1-1/4	30
13-15	Honda Accord Sedan, w/LED Taillights	1-1/4	30	
77288†	13-14	Cadillac ATS	1-1/4	30
77289	11-16	Hyundai Elantra 4 Dr. Sedan	1-1/4	25
	13-14	Hyundai Elantra 2 Dr. Coupe	1-1/4	25
77290	14-18	KIA Forte 4 Dr. Sedan	1-1/4	20
77291	10-12	Volkswagen GTI Hatchback (Canada Only)	1-1/4	40
	10-14	Volkswagen GTI Hatchback	1-1/4	40
77292	13-17	Hyundai Elantra GT Except for Korean Manufactured Vehicles	1-1/4	25
77294	13-19	Nissan Sentra Except SR	1-1/4	35
77295	14-19	Mazda 6 4 Dr. Sedan	1-1/4	30
77296	14-17	Nissan Versa Note	1-1/4	30
77297	14-19	Ford Fiesta 4 Dr. Sedan	1-1/4	15
77298	07-14	Toyota Yaris 3 Dr. Liftback	1-1/4	20
	07-14	Toyota Yaris 5 Dr. Liftback, Except SE	1-1/4	20
77299	14-17	Mazda 3 4 Dr. Sedan	1-1/4	15
77300	03-13	Toyota Corolla	1-1/4	20
	14-19	Toyota Corolla Except Hatchback	1-1/4	20
77301	14-18	Mazda 3 5 Dr. Hatchback	1-1/4	30
77302	14-19	KIA Soul Except w/LED Taillights	1-1/4	40
77302	14-19	KIA Soul w/LED Taillights	1-1/4	40
77303	14-15	Mitsubishi Mirage	1-1/4	20
	17-17	Mitsubishi Mirage Except Mirage G4	1-1/4	20
	17-17	Mitsubishi Mirage Except Mirage G4	1-1/4	20
77304†	13-15	Scion FR-S	1-1/4	30
	13-16	Subaru BRZ	1-1/4	30

PART NO.	YEARS	MAKE/MODEL	REC SIZE	IN
77306	15-17	Chrysler 200 4 Dr. Sedan	1-1/4	20
77307	15-19	Honda Fit	1-1/4	25
77308	14-16	Scion tC Except Dual Exhaust	1-1/4	15
77309	14-19	Volkswagen Beetle Except R-Line & GSR	1-1/4	20
77310	14-15	Lexus IS250 Except Convertible	1-1/4	35
	14-19	Lexus IS350	1-1/4	35
77311	13-19	Cadillac ATS Except ATS-V	1-1/4	30
77312	15-18	Volkswagen Jetta 4 Dr. Sedan, Except Hybrid & TDI	1-1/4	40
77313	15-17	Volkswagen Golf	1-1/4	60
	16-17	Volkswagen GTI	1-1/4	60
77314	14-15	Cadillac CTS 4 Dr. Sedan	1-1/4	60
	16-19	Cadillac CTS 4 Dr. Sedan, Except CTS-V	1-1/4	60
77315	15-19	Toyota Yaris Except SE	1-1/4	25
77316	15-19	Ford Mustang	1-1/4	30
77317	15-19	Audi A3 Except Sportback e-tron	1-1/4	20
77318	14-17	Infiniti Q50	1-1/4	40
77319	16-19	Honda HR-V	1-1/4	35
77320	16-19	Mazda CX-3	1-1/4	25
77321	11-16	MINI Cooper Countryman Except John Cooper Works Model	1-1/4	70
	13-16	Scion FR-S	1-1/4	75
	13-19	Subaru BRZ	1-1/4	75
77322	13-16	Subaru BRZ	1-1/4	75
	17-19	Toyota 86	1-1/4	75
77323	00-05	Toyota Echo Except Hatchback	1-1/4	15
77324	15-15	BMW 550i GT	1-1/4	50
	15-16	BMW 528i	1-1/4	50
	15-16	BMW 528i xDrive	1-1/4	50
	15-16	BMW 535d	1-1/4	50
	15-16	BMW 535d xDrive	1-1/4	50
	15-16	BMW 535i	1-1/4	50
	15-16	BMW 535i xDrive	1-1/4	50
	15-16	BMW 550i	1-1/4	50
	15-16	BMW 550i GT xDrive	1-1/4	50
	15-16	BMW 550i xDrive	1-1/4	50
	15-17	BMW 535i GT	1-1/4	50
15-17	BMW 535i GT xDrive	1-1/4	50	
77325†	16-16	Honda Civic Sedan	1-1/4	65
77326	16-19	Chevrolet Camaro	1-1/4	50
77328	16-19	Chevrolet Spark	1-1/4	45
77329	15-19	Acura TLX	1-1/4	45
77330	16-19	Chevrolet Cruze (New Body Style)	1-1/4	80
77332	12-14	BMW 335i xDrive Sedan	1-1/4	50
	12-16	BMW 328d	1-1/4	50
	12-16	BMW 328d xDrive Sedan	1-1/4	50
	12-16	BMW 328d xDrive Sports Wagon	1-1/4	50
	12-16	BMW 328i Sedan	1-1/4	50
	12-17	BMW 320i	1-1/4	50
77333†	16-16	Honda Civic Coupe	1-1/4	65
	16-16	Honda Civic Sedan	1-1/4	65
77334	16-19	Chevrolet Volt	1-1/4	60
77335	16-16	Scion iA	1-1/4	30
	17-18	Toyota Yaris iA	1-1/4	30
77336	16-19	Honda Civic Coupe, Except Models w/Center Exhaust	1-1/4	65
	16-19	Honda Civic Hatchback, Except Models w/Center Exhaust	1-1/4	65
	16-19	Honda Civic Sedan, Except Models w/Center Exhaust	1-1/4	65
77939	17-17	Hyundai Elantra 4 Dr. Except Limited & Sport Models	1-1/4	50
	17-17	Hyundai Elantra 4 Dr. Limited Models Except Sport	1-1/4	50
77949	15-17	Volkswagen Golf SportWagen	1-1/4	60
77949	17-19	Volkswagen Golf Alltrack	1-1/4	60
77950	09-19	Audi A4 4 Dr. Sedan	1-1/4	25
77951	17-19	Chevrolet Cruze Hatchback	1-1/4	60
77952	16-16	Scion iM	1-1/4	40
77952	17-17	Toyota Corolla iM	1-1/4	40
77953	15-19	Mercedes-Benz C300 Sedan, Except Models w/ Sport Package	1-1/4	75
77955	16-17	Buick Cascada	1-1/4	15
77956	17-19	Chevrolet Bolt EV	1-1/4	20
77958	12-16	Tesla S	1-1/4	150
77959	08-19	Subaru Impreza 5 Dr. Wagon, Except WRX STi & w/Quad Exhaust Outlets	1-1/4	45

PART NO.	YEARS	MAKE/MODEL	REC SIZE	IN
77959	08-19	Subaru Impreza 5 Dr. Wagon, Except WRX STi & w/Quad Exhaust Outlets	1-1/4	20
	13-15	Subaru XV Crosstrek Except Hybrid	1-1/4	30
	13-15	Subaru XV Crosstrek Hybrid	1-1/4	30
77960	12-19	Subaru Impreza 4 Dr. Sedan, Except WRX & WRX STi	1-1/4	40
77961	11-19	Ford Fiesta 5 Dr. Hatchback	1-1/4	30
77962	18-18	Toyota C-HR	1-1/4	60
77963	17-17	Hyundai Ioniq Hybrid	1-1/4	30
77964	18-20	Hyundai Elantra Except GT & Sport	1-1/4	40
77965	11-16	Hyundai Sonata Hybrid	1-1/4	40
	11-19	Hyundai Sonata Except Hybrid	1-1/4	40
	11-19	KIA Optima	1-1/4	40
77966	16-19	Toyota Prius Except Prius Prime	1-1/4	45
	17-18	Toyota Prius Prime	1-1/4	45
77967	10-15	Toyota Prius Except w/Plug-In Model	1-1/4	40
	12-15	Toyota Prius Plug-In	1-1/4	40
	12-17	Toyota Prius V	1-1/4	25
77968	15-18	Subaru WRX STI	1-1/4	60
77969	14-18	FIAT 500L	1-1/4	45
77970	18-18	Hyundai Elantra GT Except Sport	1-1/4	45
77971	12-19	Toyota Prius C	1-1/4	20
77972	18-19	Honda Accord	1-1/4	60
77974	18-18	KIA Stinger	1-1/4	90
77975	15-18	Volkswagen Golf R	1-1/4	75
77976	18-18	Hyundai Kona	1-1/4	35
77977	16-18	Ford Focus RS	1-1/4	60
77978	19-19	Volkswagen Jetta	1-1/4	80
77979	18-19	Volkswagen GTI	1-1/4	80
77980	18-19	Nissan Kicks	1-1/4	45
77982	19-19	Mazda 3 Sedan	1-1/4	40
77983	20-20	Toyota Corolla Sedan	1-1/4	40
77984	19-19	Mazda 3 Hatchback	1-1/4	40
77985	20-20	KIA Soul	1-1/4	30
77990	14-18	KIA Forte 4 Dr. Sedan	1-1/4	20
<b>CLASS II RECEIVER</b>				
06004	89-95	Ford Thunderbird Except SC	1-1/4	40
	89-97	Mercury Cougar	1-1/4	40
	93-98	Lincoln Mark VIII	1-1/4	40
	96-97	Ford Thunderbird	1-1/4	40
06020	90-95	Subaru Legacy Wagon	1-1/4	20
	90-99	Subaru Legacy Coupe & Sedan	1-1/4	25
	96-99	Subaru Legacy Wagon, Except Outback	1-1/4	20
	96-99	Subaru Legacy Wagon, Outback	1-1/4	20
06021	97-06	Jeep TJ (Canada Only)	1-1/4	15
	97-06	Jeep Wrangler	1-1/4	15
06022†	95-00	Chevrolet Lumina	1-1/4	60
	95-99	Chevrolet Monte Carlo	1-1/4	60
06024	93-97	Volvo 850 Sedan	1-1/4	20
	94-97	Volvo 850 Wagon	1-1/4	20
	98-00	Volvo S70 Sedan	1-1/4	20
	98-00	Volvo V70 Wagon	1-1/4	20
	98-02	Volvo C70 Coupe	1-1/4	20
	98-04	Volvo C70 Convertible	1-1/4	20
06025	00-04	Toyota Avalon	1-1/4	20
06029†	02-05	KIA Sedona	1-1/4	20
06033†	86-97	Ford Aerostar Extended Body	1-1/4	30
	86-97	Ford Aerostar Standard Body	1-1/4	30
06037	85-94	Chevrolet Astro Standard Body	1-1/4	30
	85-94	GMC Safari Standard Body	1-1/4	30
	90-05	Chevrolet Astro Extended Body	1-1/4	30
	90-05	GMC Safari Extended Body	1-1/4	30
06061†	96-04	Nissan Pathfinder	1-1/4	20
	97-03	Infiniti QX4	1-1/4	20
06077	98-03	Toyota Sienna	1-1/4	15
06097	86-88	Chrysler New Yorker	1-1/4	40
	87-95	Chrysler LeBaron 2 Dr. Coupe	1-1/4	40
	88-90	Chrysler New Yorker FWD Sedan	1-1/4	40
	88-93	Dodge Dynasty	1-1/4	40
	89-95	Dodge Spirit	1-1/4	40
	89-95	Plymouth Acclaim	1-1/4	40
06097	90-93	Chrysler Imperial	1-1/4	40
	90-93	Chrysler New Yorker Fifth Ave. FWD	1-1/4	40
	90-93	Chrysler New Yorker Salon	1-1/4	40
	90-94	Chrysler LeBaron 4 Dr.	1-1/4	40
06099	96-14	Chevrolet Express 1500	1-1/4	15
	96-14	GMC Savana 1500	1-1/4	15
	96-17	GMC Savana 2500	1-1/4	15

PART NO.	YEARS	MAKE/MODEL	REC SIZE	IN
06099	96-17	GMC Savana 3500	1-1/4	15
	96-19	Chevrolet Express 2500	1-1/4	15
	96-19	Chevrolet Express 3500	1-1/4	15
06121	10-19	Ford Taurus 4 Dr. Sedan	1-1/4	30
06125	08-09	Buick Lucerne Super & Special Edition	1-1/4	25
	10-11	Buick Lucerne	1-1/4	25
06131	11-14	Mitsubishi RVR (Canada Only)	1-1/4	30
	11-19	Mitsubishi Outlander Sport Except PHEV	1-1/4	30
06132	10-15	Hyundai Tucson	1-1/4	20
	11-16	KIA Sportage	1-1/4	20
06133	10-12	Hyundai Santa Fe	1-1/4	15
	11-13	KIA Sorento EX V6, w/Factory Tow Package	1-1/4	15
	11-13	KIA Sorento Except SX V6 & EX V6 w/Factory Tow Package	1-1/4	15
	11-13	KIA Sorento SX V6	1-1/4	15
06135	03-03	Saab 9-3 Convertible	1-1/4	30
	99-02	Saab 9-3	1-1/4	30
06136	99-05	Saab 9-5	1-1/4	30
06137	04-14	Toyota Sienna	1-1/4	20
	15-20	Toyota Sienna Except SE	1-1/4	20
	15-20	Toyota Sienna SE	1-1/4	20
06138	09-16	Toyota Venza	1-1/4	20
06144	12-16	Honda CR-V	1-1/4	40
06147	13-19	Ford Escape	1-1/4	15
06150	09-13	Subaru Forester	1-1/4	35
06152†	13-19	Cadillac XTS	1-1/4	30
	14-14	Chevrolet Impala LT Except Impala Limited	1-1/4	40
	14-14	Chevrolet Impala LTZ Except Impala Limited	1-1/4	40
06153	10-13	Buick LaCrosse	1-1/4	25
	11-13	Buick Regal Except GS	1-1/4	20
	13-13	Chevrolet Malibu (Canada Only)	1-1/4	20
	13-13	Chevrolet Malibu Except LTZ & Canada Models	1-1/4	20
	13-13	Chevrolet Malibu LTZ Except Canada Models	1-1/4	20
06154	13-18	Lexus ES350 Except Hybrid	1-1/4	40
06155	14-18	Subaru Forester	1-1/4	30
06156	13-19	Ford Escape	1-1/4	60
	13-19	Ford Escape	1-1/4	20
06157†	92-94	Cadillac Eldorado	1-1/4	40
	92-97	Cadillac Seville	1-1/4	40
06158	13-18	Hyundai Santa Fe Sport (5 Passenger)	1-1/4	30
	14-15	KIA Sorento w/ I4 Engine	1-1/4	30
	14-15	KIA Sorento w/ V6 Engine	1-1/4	30
06160	12-19	Toyota Camry Including Hybrid	1-1/4	40
	13-18	Toyota Avalon	1-1/4	40
06161	14-19	Acura RLX	1-1/4	60
06162	08-13	Nissan Rogue Except Krom	1-1/4	15
	14-14	Nissan Rogue Select	1-1/4	15
	14-19	Nissan Rogue Except Sport	1-1/4	15
06163	14-14	Chevrolet Impala LS Except Impala Limited	1-1/4	30
	14-14	Chevrolet Impala LT Except Impala Limited	1-1/4	30
	14-14	Chevrolet Impala LTZ Except Impala Limited	1-1/4	30
06165	12-17	Hyundai Azera	1-1/4	20
	14-14	KIA Cadenza	1-1/4	20
06167†	14-14	Buick LaCrosse	1-1/4	30
06168	10-16	Buick LaCrosse	1-1/4	35
	11-17	Buick Regal	1-1/4	35
	13-15	Chevrolet Malibu Except LTZ & Canada Models	1-1/4	35
	13-19	Cadillac XTS	1-1/4	35
	14-15	Chevrolet Malibu LTZ Except Canada Models	1-1/4	35
	14-19	Chevrolet Impala Except Impala Limited	1-1/4	35
16-16	Chevrolet Malibu Limited, Except LTZ & Canada Models (Old Body Style)	1-1/4	35	
16-16	Chevrolet Malibu Limited, LTZ, Except Canada Models (Old Body Style)	1-1/4	35	
06169	13-16	Chevrolet Trax	1-1/4	40
	13-19	Buick Encore	1-1/4	40
	17-19	Chevrolet Trax Except LS	1-1/4	40
	17-19	Chevrolet Trax LS	1-1/4	40
06170	16-19	Chevrolet Malibu Except Premier (New Body Style)	1-1/4	80
	16-19	Chevrolet Malibu Premier (New Body Style)	1-1/4	80
06172	06-18	Toyota RAV4	1-1/4	20
06173	15-19	Lincoln MKC	1-1/4	45
06174	16-19	Mazda CX-9	1-1/4	30
06176	17-19	KIA Sportage Except SX & SX Turbo	1-1/4	30
06178	17-19	Lincoln Continental	1-1/4	50
06179	17-19	KIA Niro Except Plug-In-Hybrid	1-1/4	40



# CLASS II RECEIVER HITCH INDEX

PART NO.	YEARS	MAKE/MODEL	REC SIZE	IN
06180	18-19	GMC Terrain Except Diesel	1-1/4	35
	18-20	Chevrolet Equinox Except Premier or Models w/1.6L Diesel	1-1/4	35
	18-20	Chevrolet Equinox Premier, Except Models w/1.6L Diesel	1-1/4	35
06181	17-19	Chrysler Pacifica Hybrid (Needs Conversion Kit: 76046SK)	1-1/4	45
	17-19	Chrysler Pacifica Limited	1-1/4	45
	17-19	Chrysler Pacifica LX	1-1/4	45
	17-19	Chrysler Pacifica Touring	1-1/4	45
	17-19	Chrysler Pacifica Touring L	1-1/4	45
	17-19	Chrysler Pacifica Touring L Plus	1-1/4	45
	17-19	Chrysler Pacifica Touring Plus	1-1/4	45
06182	18-19	Honda Odyssey With Fuse Provisions	1-1/4	80
	18-19	Honda Odyssey Without Fuse Provisions	1-1/4	25
06183	17-19	Honda CR-V	1-1/4	20
06184	14-17	KIA Rondo (Canada Only)	1-1/4	25
06185	13-19	Mazda CX-5	1-1/4	20
	13-19	Mazda CX-5	1-1/4	30
06186	18-19	Volkswagen Atlas	1-1/4	25
06187	18-19	Toyota Camry Except Hybrid	1-1/4	40
	19-19	Toyota Avalon	1-1/4	40
06188	18-19	Volkswagen Tiguan 4 Motion	1-1/4	20
	18-19	Volkswagen Tiguan Except 4 Motion	1-1/4	20
06189	16-19	Chevrolet Malibu Except Premier (New Body Style)	1-1/4	80
	16-19	Chevrolet Malibu Premier (New Body Style)	1-1/4	80
	17-19	Buick LaCrosse	1-1/4	80
	18-19	Buick Regal Sportback	1-1/4	80
06190	18-18	Ford EcoSport	1-1/4	45
06191	19-19	Subaru Forester	1-1/4	30
06192	19-19	Toyota RAV4	1-1/4	35
06193	19-20	Acura RDX With +12V Power Provision	1-1/4	30
	19-20	Acura RDX Without +12V Power Provision	1-1/4	25
06194	20-20	Ford Explorer	1-1/4	0
06198	18-19	Buick Regal TourX	1-1/4	30
06220†	85-91	Pontiac 6000 Except AWD	1-1/4	40
	85-96	Oldsmobile Cutlass Ciera FWD	1-1/4	40
06227	85-94	Chevrolet Astro Standard Body	1-1/4	30
	85-94	GMC Safari Standard Body	1-1/4	30
	90-05	Chevrolet Astro Extended Body	1-1/4	30
	90-05	GMC Safari Extended Body	1-1/4	30
06249	97-05	Chevrolet Malibu 4 Dr.	1-1/4	20
	97-99	Oldsmobile Cutlass 4 Dr., FWD	1-1/4	20
06262	97-04	Buick Regal (App. starts with 97-1/2)	1-1/4	35
	97-08	Pontiac Grand Prix	1-1/4	35
06263	97-04	Buick Park Avenue	1-1/4	40
06264†	95-02	KIA Sportage	1-1/4	20
06265†	97-99	Cadillac DeVille	1-1/4	20
06276	01-03	Toyota Highlander	1-1/4	15
	99-03	Lexus RX300	1-1/4	15
06281†	02-04	Chrysler Concorde	1-1/4	30
	99-01	Chrysler LHS	1-1/4	30
06284†	02-04	Chrysler 300M Except Special	1-1/4	30
	99-01	Chrysler 300M	1-1/4	30
06287	00-04	Subaru Legacy Sedan, Except Outback	1-1/4	20
	00-04	Subaru Legacy Wagon, Except Outback	1-1/4	20
	00-04	Subaru Outback Sedan, Except Sport	1-1/4	20
	00-04	Subaru Outback Wagon, Except Sport	1-1/4	20
06298	00-05	Cadillac DeVille	1-1/4	20
	06-11	Cadillac DTS	1-1/4	20
06299	99-04	Oldsmobile Alero	1-1/4	20
	99-05	Pontiac Grand Am	1-1/4	20
06301	05-07	Ford Five Hundred	1-1/4	30
	05-07	Ford Freestyle	1-1/4	30
	05-07	Mercury Montego	1-1/4	30
	08-09	Ford Taurus 4 Dr. Sedan	1-1/4	30
	08-09	Ford Taurus X	1-1/4	30
	08-09	Mercury Sable Sedan	1-1/4	30
06306†	96-99	Oldsmobile 88	1-1/4	30
	96-99	Oldsmobile LSS	1-1/4	30
06306†	96-99	Pontiac Bonneville Except SLE/SSE/SSEi	1-1/4	30
	97-98	Oldsmobile Regency	1-1/4	30
06326	04-06	Lexus ES330 4 Dr.	1-1/4	15
	92-96	Toyota Camry	1-1/4	15
	95-99	Toyota Avalon	1-1/4	15
	97-03	Lexus ES300 4 Dr.	1-1/4	15
	97-06	Toyota Camry 4 Dr. Sedan	1-1/4	15
	99-03	Toyota Solara	1-1/4	15

PART NO.	YEARS	MAKE/MODEL	REC SIZE	IN	
06339	05-09	Hyundai Tucson	1-1/4	25	
	05-10	KIA Sportage 4 Cyl.	1-1/4	25	
	05-10	KIA Sportage 6 Cyl.	1-1/4	25	
06354†	93-97	Chrysler Concorde	1-1/4	40	
	93-97	Chrysler Intrepid (Canada Only)	1-1/4	40	
	93-97	Dodge Intrepid	1-1/4	40	
	93-97	Eagle Vision	1-1/4	40	
	94-96	Chrysler New Yorker	1-1/4	40	
	94-97	Chrysler LHS	1-1/4	40	
06355†	98-04	Chrysler Intrepid (Canada Only)	1-1/4	30	
	98-04	Dodge Intrepid	1-1/4	30	
06358	00-07	Chevrolet Monte Carlo Except SS Sport Appearance Pkg.	1-1/4	30	
06365	01-01	Ford Explorer 4 Dr.	1-1/4	15	
	01-03	Ford Explorer 2 Dr. Sport	1-1/4	15	
	91-00	Ford Explorer	1-1/4	15	
	91-94	Mazda Navajo	1-1/4	15	
	97-01	Mercury Mountaineer	1-1/4	15	
06366†	01-03	Isuzu Rodeo Sport 2 Dr., w/Door Mounted Spare	1-1/4	15	
	98-00	Isuzu Amigo w/Door Mounted Spare	1-1/4	15	
	98-01	Honda Passport w/Door Mounted Spare	1-1/4	15	
	98-01	Isuzu Rodeo w/Door Mounted Spare	1-1/4	15	
06367	92-95	Oldsmobile 88	1-1/4	40	
	92-95	Pontiac Bonneville Except SSE & SSEi	1-1/4	40	
	92-99	Buick LeSabre FWD	1-1/4	40	
06377	05-07	Subaru Legacy Sedan, Except Outback	1-1/4	25	
	05-07	Subaru Legacy Wagon, Except Outback	1-1/4	25	
	05-07	Subaru Outback Sedan, Except Sport	1-1/4	25	
	05-09	Subaru Outback Wagon, Except Sport	1-1/4	25	
	08-09	Subaru Legacy Sedan	1-1/4	25	
06378	05-10	Jeep Grand Cherokee Except SRT-8	1-1/4	90	
	06-10	Jeep Commander	1-1/4	20	
06384	05-09	Buick Allure (Canada Only)	1-1/4	30	
	05-09	Buick LaCrosse Except Super	1-1/4	30	
	97-05	Buick Century Sedan	1-1/4	30	
	98-02	Oldsmobile Intrigue	1-1/4	30	
06387	04-08	Toyota Solara	1-1/4	15	
06388†	04-07	Chevrolet Malibu Maxx LS	1-1/4	25	
	04-07	Chevrolet Malibu Maxx LT	1-1/4	25	
06389	00-13	Chevrolet Impala	1-1/4	30	
06391	02-07	Saturn Vue Except Redline	1-1/4	25	
	05-17	Chevrolet Equinox	1-1/4	25	
	06-09	Pontiac Torrent	1-1/4	25	
	10-17	GMC Terrain	1-1/4	25	
06393†	00-06	Lincoln LS	1-1/4	30	
06397	07-11	Toyota Camry 4 Dr. Sedan, Except Hybrid	1-1/4	45	
	07-11	Toyota Camry Hybrid 4 Dr. Sedan	1-1/4	45	
	07-12	Lexus ES350	1-1/4	45	
06398	99-17	Honda Odyssey	1-1/4	20	
06401	07-12	Mazda CX-7	1-1/4	40	
06409†	77-83	Buick Estate Wagon	1-1/4	30	
	77-90	Buick LeSabre Wagon	1-1/4	30	
	77-92	Oldsmobile Custom Cruiser Wagon	1-1/4	30	
	77-96	Chevrolet Caprice Wagon	1-1/4	30	
	83-86	Pontiac Parisienne Wagon	1-1/4	30	
	87-89	Pontiac Safari Wagon	1-1/4	30	
	91-96	Buick Roadmaster Estate Wagon	1-1/4	30	
	06411†	88-90	Pontiac Grand Prix Except SE & Turbo	1-1/4	60
		88-93	Oldsmobile Cutlass Supreme 2 Dr. FWD	1-1/4	60
88-94		Buick Regal 2 Dr.	1-1/4	60	
90-94		Chevrolet Lumina Except Z-34	1-1/4	60	
91-93		Pontiac Grand Prix Except Turbo	1-1/4	60	
91-94		Buick Regal 4 Dr., Except GS/Limited	1-1/4	60	
06417	05-11	Mazda Tribute	1-1/4	20	
	05-11	Mercury Mariner	1-1/4	20	
	05-12	Ford Escape	1-1/4	20	
06420	01-07	Volvo V70 Wagon	1-1/4	15	
	01-09	Volvo S60 Sedan	1-1/4	15	
	03-07	Volvo XC70 Wagon, AWD	1-1/4	15	
06428	07-10	Jeep Compass	1-1/4	15	
06428	07-10	Jeep Compass Rallye Edition	1-1/4	30	
	07-17	Jeep Patriot	1-1/4	15	
	07-17	Jeep Patriot	1-1/4	30	
	11-17	Jeep Compass (Old Body Style)	1-1/4	30	
06448†	07-17	Jeep Wrangler Except w/Right Hand Drive, Hard Rock Edition, 75th Anniversary Edition & vehicles with Mopar Off Road Bumper #82213654	1-1/4	20	
	07-17	Jeep Wrangler Right Hand Drive, Except Hard Rock Edition, 75th Anniversary Edition & vehicles with Mopar Off Road Bumper #82213654	1-1/4	20	



PART NO.	YEARS	MAKE/MODEL	REC SIZE	IN
06448†	18-18	Jeep Wrangler JK Except w/Right Hand Drive, Hard Rock Edition, 75th Anniversary Edition & vehicles with Mopar Off Road Bumper #82213654	1-1/4	20
	18-18	Jeep Wrangler JK Right Hand Drive, Except Hard Rock Edition, 75th Anniversary Edition & vehicles with Mopar Off Road Bumper #82213654	1-1/4	20
	18-19	Jeep Wrangler JL (New Body Style)	1-1/4	20
06457	01-05	Pontiac Aztek	1-1/4	40
	02-07	Buick Rendezvous	1-1/4	40
06463	05-09	Pontiac G6	1-1/4	30
06465	07-09	Acura RDX	1-1/4	15
06525	07-10	Ford Edge Except Sport	1-1/4	45
	07-10	Lincoln MKX	1-1/4	45
06526	07-10	Chrysler Sebring Except Convertible	1-1/4	30
	08-10	Dodge Avenger	1-1/4	30
06528	08-09	Saturn Vue	1-1/4	15
06529	08-12	Jeep Liberty	1-1/4	15
06550	08-16	Chrysler Town & Country	1-1/4	20
	08-19	Dodge Grand Caravan	1-1/4	20
	09-12	Volkswagen Routan	1-1/4	20
	12-15	RAM C/V Tradesman	1-1/4	20
	13-14	Volkswagen Routan (Canada Only)	1-1/4	20
06598	17-19	Jeep Compass (New Body Style)	1-1/4	40
06608	07-16	Volvo S80 Sedan	1-1/4	35
06614†	94-96	Cadillac DeVille	1-1/4	40
06616†	89-93	Cadillac DeVille	1-1/4	40
	89-93	Cadillac Fleetwood Coupe & Sedan, FWD	1-1/4	40
06617	98-04	Cadillac Seville	1-1/4	35
06625	09-17	Volkswagen Tiguan	1-1/4	20
06658	07-09	Saturn Aura	1-1/4	45
	08-12	Chevrolet Malibu Except LTZ	1-1/4	45
	08-12	Chevrolet Malibu LTZ	1-1/4	45
06659	09-14	Hyundai Genesis 4 Dr. Sedan	1-1/4	60
06663	09-16	Lincoln MKS	1-1/4	30
06669	10-19	Subaru Legacy Sedan	1-1/4	45
	10-19	Subaru Outback Wagon, Except Sport	1-1/4	45
06813	18-19	Subaru Crosstrek Except Hybrid	1-1/4	60
	18-19	Subaru Crosstrek Hybrid	1-1/4	60
	18-19	Subaru Impreza 5 Dr. Wagon, Except WRX STi & w/Quad Exhaust Outlets	1-1/4	60
06945†	13-13	Lexus GS350	1-1/4	60
06946	05-08	Dodge Magnum	1-1/4	30
	05-19	Chrysler 300	1-1/4	30
	05-19	Chrysler 300	1-1/4	40
	06-19	Dodge Charger	1-1/4	30
	08-19	Dodge Challenger Except Models w/Quad Tip Exhaust	1-1/4	30
06947	15-18	Jeep Renegade	1-1/4	30
06948†	13-16	Mazda CX-5	1-1/4	30
06949	16-18	Hyundai Tucson	1-1/4	30
06953	95-98	Honda Odyssey	1-1/4	30
	96-99	Isuzu Oasis	1-1/4	30
06954	84-01	Jeep Cherokee	1-1/4	30
	84-90	Jeep Wagoneer	1-1/4	30
06955	95-05	Chevrolet Blazer Downsize	1-1/4	15
	95-05	GMC Jimmy Downsize	1-1/4	15
	96-01	Oldsmobile Bravada	1-1/4	15
	99-01	Chevrolet Blazer Trailblazer	1-1/4	15
06958	83-90	GMC S15 w/Standard Bed & Step Bumper	1-1/4	35
	83-97	Chevrolet S10 w/Standard Bed & Step Bumper	1-1/4	35
	96-00	Isuzu Hombre w/Step Bumper	1-1/4	35
	98-04	Chevrolet S10	1-1/4	35
	98-04	GMC Sonoma	1-1/4	35
06961	93-98	Mercury Villager	1-1/4	15
	93-98	Nissan Quest	1-1/4	15
06966	99-04	Jeep Grand Cherokee	1-1/4	15
06967	03-03	Ford Windstar (Built After 11/2002)	1-1/4	30
	95-98	Ford Windstar	1-1/4	30
06967	99-03	Ford Windstar (Built Before 11/2002)	1-1/4	30
06968†	99-02	Mercury Villager	1-1/4	15
	99-02	Nissan Quest	1-1/4	15
06971†	02-07	Jeep Liberty	1-1/4	15
06976	00-05	Buick LeSabre	1-1/4	30
	00-05	Pontiac Bonneville	1-1/4	30
	01-03	Oldsmobile Aurora	1-1/4	30
	06-09	Buick Lucerne Except Super & Special Edition	1-1/4	30
06977	01-06	Chrysler Sebring 4 Dr.	1-1/4	60

PART NO.	YEARS	MAKE/MODEL	REC SIZE	IN	
06977	95-00	Chrysler Cirrus	1-1/4	60	
	95-06	Dodge Stratus 4 Dr.	1-1/4	60	
	96-00	Plymouth Breeze	1-1/4	60	
06988	04-07	Chevrolet Malibu 4 Dr.	1-1/4	40	
	06-07	Chevrolet Malibu SS 4 Dr.	1-1/4	50	
	08-08	Chevrolet Malibu Classic LS	1-1/4	40	
	08-08	Chevrolet Malibu Classic LT	1-1/4	40	
06989	04-07	Ford Freestar	1-1/4	25	
	04-07	Mercury Monterey	1-1/4	25	
06991	00-05	Mercury Sable Sedan	1-1/4	40	
	00-05	Mercury Sable Wagon	1-1/4	40	
	00-06	Ford Taurus 4 Dr. Sedan	1-1/4	40	
	00-06	Ford Taurus Wagon	1-1/4	40	
06992	05-07	Chrysler Town & Country w/Stow & Go Seats	1-1/4	25	
	05-07	Dodge Grand Caravan w/Stow & Go Seats	1-1/4	25	
06993†	10-11	Buick LaCrosse AWD	1-1/4	25	
	10-12	Buick LaCrosse FWD	1-1/4	20	
	11-13	Buick Regal Except Turbo	1-1/4	20	
06996†	96-04	Acura RL 3.5	1-1/4	30	
<b>CLASS III/IV RECEIVER</b>					
33001	93-98	Mercury Villager	2	15	
	93-98	Nissan Quest	2	15	
33008†	98-03	Toyota Sienna	2	30	
33013†	96-02	Toyota 4Runner	2	30	
33015	95-02	GMC Jimmy Downsize	2	15	
	95-05	Chevrolet Blazer Downsize	2	15	
	96-01	Oldsmobile Bravada	2	15	
	96-01	Chevrolet Blazer Trailblazer	2	15	
33017†	99-02	Mercury Villager	2	15	
	99-02	Nissan Quest	2	15	
33019	00-04	Nissan Xterra	2	15	
33020†	01-05	Ford Explorer Sport Trac	2	15	
33022	93-98	Toyota T100	2	45	
33023†	92-95	Toyota 4Runner	2	40	
33028	01-06	Mitsubishi Montero Except Montero Sport	2	25	
33031	02-05	Ford Explorer 4 Dr.	2	20	
	02-05	Mercury Mountaineer	2	20	
	03-05	Lincoln Aviator	2	20	
33036†	97-06	Jeep TJ (Canada Only)	2	15	
	97-06	Jeep Wrangler	2	15	
33037†	01-06	Hyundai Santa Fe	2	35	
33038	02-06	Suzuki XL-7	2	15	
	99-04	Chevrolet Tracker	2	15	
	99-04	Suzuki Vitara	2	15	
	99-04	Suzuki Grand Vitara	2	15	
	99-05	Suzuki Grand Vitara	2	15	
33039†	01-04	Ford Escape	2	35	
	01-04	Mazda Tribute	2	35	
33040	91-97	Isuzu Rodeo	2	45	
	94-97	Honda Passport	2	45	
33041	02-03	Isuzu Axiom w/Under Vehicle Spare	2	20	
	98-02	Honda Passport w/Under Vehicle Spare	2	15	
	98-04	Isuzu Rodeo w/Under Vehicle Spare, Except w/3.5L	2	15	
33042	73-91	Chevrolet Blazer Full Size	2	30	
	73-91	GMC Jimmy Full Size	2	30	
	75-86	Chevrolet Blazer K5	2	30	
33043†	92-02	Isuzu Trooper	2	40	
	96-99	Acura SLX	2	40	
33044	97-04	Mitsubishi Montero Sport	2	20	
33045†	01-03	Chrysler Voyager	2	30	
	04-07	Chrysler Town & Country Except w/Stow & Go Seats	2	30	
	04-07	Dodge Caravan Except w/Stow & Go Seats	2	30	
	04-07	Dodge Grand Caravan Except w/Stow & Go Seats	2	30	
	96-00	Plymouth Grand Voyager	2	30	
	96-00	Plymouth Voyager	2	30	
	96-03	Chrysler Town & Country	2	30	
	96-03	Dodge Caravan	2	30	
	96-03	Dodge Grand Caravan	2	30	
	33047	03-04	Mercury Marauder	2	30
		79-82	Ford LTD	2	30
79-82		Mercury Marquis Sedan	2	30	
80-83		Lincoln Mark VI	2	30	
81-11		Lincoln Town Car	2	30	
83-11		Mercury Grand Marquis	2	30	
83-91		Ford LTD Crown Victoria	2	30	
92-09	Ford Crown Victoria	2	30		
33048†	88-94	Nissan D21	2	30	
	95-97	Nissan Pickup	2	30	
	98-04	Nissan Frontier	2	30	

# CLASS III/IV RECEIVER HITCH INDEX

PART NO.	YEARS	MAKE/MODEL	REC SIZE	IN
33049	00-06	Toyota Tundra	2	20
33050	96-04 97-03	Nissan Pathfinder Infiniti QX4	2	20
33052	97-02 98-02	Ford Expedition Lincoln Navigator	2	20
33053	83-90 83-97 96-97	GMC S15 w/Standard Bed & Step Bumper Chevrolet S10 w/Standard Bed & Step Bumper Isuzu Hombre w/Step Bumper	2	45
33060	96-05	Toyota RAV4	2	20
33061	01-05 02-07	Pontiac Aztek Buick Rendezvous	2	55
33062	02-05	KIA Sedona	2	30
33066	91-97 96-97	Toyota Land Cruiser Lexus LX450	2	30
33070†	04-14 15-20 15-20	Toyota Sienna Toyota Sienna Except SE Toyota Sienna SE	2	30
33072	03-03 03-09 03-09 04-05 06-08	Dodge Ram 1500 (Built After 11/2002) Dodge Ram 2500 Dodge Ram 3500 Dodge Ram 1500 Except Daytona/Hemi Sport Quad Cab/Ram Rumble Bee/SRT-10 Dodge Ram 1500	2	20
33073	03-14	Volvo XC90	2	25
33075	04-06 04-07 06-08 07-09	Lexus RX330 Toyota Highlander Lexus RX400h Hybrid Lexus RX350	2	20
33079	04-09	Nissan Quest	2	20
33080	04-05	Mitsubishi Endeavor	2	20
33082	04-09 07-09	Dodge Durango Chrysler Aspen	2	50
33086	04-09	Cadillac SRX Except w/Sport Package Fascia	2	60
33089	03-06 03-06	Dodge Sprinter 2500 w/41" Wide Frames, Except 118" Wheelbase & Factory Metal Step Platform Freightliner Sprinter 2500 w/41" Wide Frames, Except 118" Wheelbase & Factory Metal Step Platform	2	20
33090†	05-15	Toyota Tacoma Except X-Runner	2	30
33092	05-10 06-09 11-11	Dodge Dakota Mitsubishi Raider RAM Dakota	2	20
35365	78-95 78-95 78-95 79-95 79-95 79-95 96-96 96-96	Chevrolet G10 Chevrolet G20 Chevrolet G30 GMC G1500 GMC G2500 GMC G3500 Chevrolet G30 Classic & Sport Full Size w/Lo-Mount Taillights GMC G3500 Vandura & Rally Full Size w/Lo-Mount Taillights	2	30
36025	71-72 71-80 71-80 71-80 71-89 71-89 75-79 75-96 75-96 75-96 77-93 78-96 80-83 80-86 80-86 80-86 81-93	Dodge W300 Dodge D200 Dodge D300 Dodge W200 Dodge D100 Dodge W100 Ford F-100 Ford F-150 Ford F-250 Ford F-350 Dodge W150 Ford Bronco Ford F-100 Except w/Custom Fascia Ford F-150 Except w/Custom Fascia Ford F-250 Except w/Custom Fascia Ford F-350 Except w/Custom Fascia Dodge W250	2	30
36025	86-93 86-93 86-93 86-93 92-96 97-97 97-97	Dodge D150 Dodge D250 Dodge D350 Dodge W350 Ford F-150 Flareside, w/Rear Fascia Ford F-250 Heavy Duty Ford F-350 Heavy Duty	2	30
36047	87-04 92-96	Dodge Dakota Ford F-150 Flareside, w/Rear Fascia	2	30
36099	00-03 04-04 04-04	Ford F-150 SuperCrew Ford F-150 Heritage Flareside Ford F-150 Heritage Styleside	2	20

PART NO.	YEARS	MAKE/MODEL	REC SIZE	IN
36099	97-03 97-03 97-99	Ford F-150 Flareside Ford F-150 Styleside Ford F-250 Styleside	2	20
37004	96-14 96-14 96-17 96-17 96-19 96-19	Chevrolet Express 1500 GMC Savana 1500 GMC Savana 2500 GMC Savana 3500 Chevrolet Express 2500 Chevrolet Express 3500	2	20
37012	01-01 01-03 95-00 97-01	Ford Explorer 4 Dr. Ford Explorer 2 Dr. Sport Ford Explorer Mercury Mountaineer	2	40
37016	01-07 01-07 03-07 03-07 99-02 99-02 99-04 99-04	Chevrolet Silverado 1500 HD GMC Sierra 1500 HD Chevrolet Silverado 1500 (Classic) GMC Sierra 1500 (Classic) Chevrolet Silverado 1500 GMC Sierra 1500 Chevrolet Silverado 2500 GMC Sierra 2500	2	20
37053	02-07	Jeep Liberty	2	20
37070	94-94 94-94 94-94 95-98 95-98 95-98 99-03 99-03 99-03	Dodge Van, B150 Except w/Factory Step Bumper Dodge Van, B250 Except w/Factory Step Bumper Dodge Van, B350 Except w/Factory Step Bumper Dodge Van, B1500 Except w/Factory Step Bumper Dodge Van, B2500 Except w/Factory Step Bumper Dodge Van, B3500 Except w/Factory Step Bumper Dodge Van, Ram 1500 Except w/Factory Step Bumper Dodge Van, Ram 2500 Except w/Factory Step Bumper Dodge Van, Ram 3500 Except w/Factory Step Bumper	2	25
37074	92-00 92-94 92-99 92-99 92-99 92-99 92-99 92-99 92-99 95-00 99-00 99-00	GMC Yukon Chevrolet Blazer Full Size Chevrolet Suburban C1500 Chevrolet Suburban C2500 Chevrolet Suburban K1500 Chevrolet Suburban K2500 GMC Suburban C1500 GMC Suburban C2500 GMC Suburban K1500 GMC Suburban K2500 Chevrolet Tahoe Cadillac Escalade GMC Yukon Denali	2	30
37081	63-65 63-65 63-65 63-66 63-66 63-79 63-86 63-86 63-86 63-86 63-86 63-96 63-96 67-78 67-78 67-78 67-78 67-78 67-78 67-78 67-80 67-80 67-80 67-89 68-80 68-80	GMC 1000 Series w/Deep Drop Bumper GMC 1500 Series w/Deep Drop Bumper GMC 2500 Series w/Deep Drop Bumper GMC 3000 w/Deep Drop Bumper GMC 3500 w/Deep Drop Bumper Ford F-100 w/Deep Drop Bumper Chevrolet C10 w/Deep Drop Bumper Chevrolet C20 w/Deep Drop Bumper Chevrolet C30 w/Deep Drop Bumper Chevrolet K10 w/Deep Drop Bumper Chevrolet K20 w/Deep Drop Bumper Ford F-250 w/Deep Drop Bumper Ford F-350 w/Deep Drop Bumper GMC C15 w/Deep Drop Bumper GMC C25 w/Deep Drop Bumper GMC C35 w/Deep Drop Bumper GMC K15 w/Deep Drop Bumper GMC K25 w/Deep Drop Bumper GMC K35 w/Deep Drop Bumper Dodge W200 w/Deep Drop Bumper Dodge W300 w/Deep Drop Bumper Dodge W100 w/Deep Drop Bumper Dodge D200 w/Deep Drop Bumper Dodge D300 w/Deep Drop Bumper	2	40
37081	68-89 69-70 73-86 74-81 74-88 75-96 77-93 77-93 78-86 79-86	Dodge D100 w/Deep Drop Bumper International 1000D w/Deep Drop Bumper Chevrolet K30 w/Deep Drop Bumper Plymouth Trailduster w/Deep Drop Bumper, Except w/Skid Shield Dodge Ramcharger w/Deep Drop Bumper, Except w/Skid Shield Ford F-150 w/Deep Drop Bumper Dodge D150 w/Deep Drop Bumper Dodge W150 w/Deep Drop Bumper Ford Bronco w/Deep Drop Bumper GMC C1500 w/Deep Drop Bumper GMC C2500 w/Deep Drop Bumper	2	40

PART NO.	YEARS	MAKE/MODEL	REC SIZE	IN	
<b>37081</b>	79-86	GMC C3500 w/Deep Drop Bumper	2	40	
	79-86	GMC K1500 w/Deep Drop Bumper	2	40	
	79-86	GMC K2500 w/Deep Drop Bumper	2	40	
	79-86	GMC K3500 w/Deep Drop Bumper	2	40	
	79-91	Ford F-100 w/Deep Drop Bumper, Except w/ Custom Fascia	2	40	
	80-83	Ford F-150 w/Deep Drop Bumper, Except w/ Custom Fascia	2	40	
	80-86	Ford F-250 w/Deep Drop Bumper, Except w/ Custom Fascia	2	40	
	80-86	Ford F-350 w/Deep Drop Bumper, Except w/ Custom Fascia	2	40	
	80-86	Dodge D250 w/Deep Drop Bumper	2	40	
	81-93	Dodge D350 w/Deep Drop Bumper	2	40	
	81-93	Dodge W250 w/Deep Drop Bumper	2	40	
	81-93	Dodge W350 w/Deep Drop Bumper	2	40	
	81-93	Chevrolet C2500 Crew Cab, w/Deep Drop Bumper	2	40	
	88-91	Chevrolet C3500 Crew Cab, w/Deep Drop Bumper	2	40	
	88-91	Chevrolet K2500 Crew Cab, w/Deep Drop Bumper	2	40	
	88-91	Chevrolet K3500 Crew Cab, w/Deep Drop Bumper	2	40	
	88-91	GMC C2500 Crew Cab, w/Deep Drop Bumper	2	40	
	88-91	GMC C3500 Crew Cab, w/Deep Drop Bumper	2	40	
	88-91	Ford F Super Duty Cab & Chassis, w/34" Wide Frames & 161" Wheelbase & w/Deep Drop Bumper	2	40	
	94-01	Dodge Ram 1500 w/Deep Drop Bumper	2	40	
	94-02	Dodge Ram 2500 w/Deep Drop Bumper	2	40	
	94-02	Dodge Ram 3500 w/Deep Drop Bumper	2	40	
	97-97	Ford F-250 Heavy Duty, w/Deep Drop Bumper	2	40	
	97-97	Ford F-350 Heavy Duty, w/Deep Drop Bumper	2	40	
	99-00	Ford F-350 Super Duty Cab & Chassis, w/34" Wide Frames & w/Deep Drop Bumper	2	40	
	<b>37084</b>	02-03	Dodge Ram 1500 (Built Before 11/2002)	2	20
	<b>37087</b>	63-65	GMC 1000 Series w/8' Bed	2	45
		63-65	GMC 1500 Series w/8' Bed	2	45
		63-65	GMC 2500 Series w/8' Bed	2	45
		63-66	GMC 3000 w/8' Bed	2	45
		63-66	GMC 3500 w/8' Bed	2	45
		63-72	Ford F-100	2	45
		63-74	Ford F-250	2	45
		63-74	Ford F-350	2	45
		63-86	Chevrolet C10 w/8' Bed	2	45
63-86		Chevrolet C20 w/8' Bed	2	45	
63-86		Chevrolet C30 w/8' Bed	2	45	
63-86		Chevrolet K10 w/8' Bed	2	45	
63-86		Chevrolet K20 w/8' Bed	2	45	
67-74		GMC C15/C1500 w/8' Bed	2	45	
67-78		GMC C25 w/8' Bed	2	45	
67-78		GMC C35 w/8' Bed	2	45	
67-78		GMC K15 w/8' Bed	2	45	
67-78		GMC K25 w/8' Bed	2	45	
68-78		GMC K35 w/8' Bed	2	45	
69-70		International 1000D	2	45	
69-70		International 1100D	2	30	
69-70		International 1200D	2	30	
69-70		International 1300D	2	30	
69-71		International 1500D	2	30	
71-73		International 1010	2	30	
71-73		International 1110	2	30	
71-73		International 1210	2	30	
71-73		International 1310	2	30	
73-86		Chevrolet K30 w/8' Bed	2	45	
74-74		International 100	2	30	
74-75		International 150	2	30	
74-75		International 200	2	30	
75-78		GMC C15 w/8' Bed	2	45	
79-86		GMC C1500 w/8' Bed	2	45	
79-86		GMC C2500 w/8' Bed	2	45	
79-86		GMC C3500 w/8' Bed	2	45	
79-86		GMC K1500 w/8' Bed	2	45	
79-86		GMC K2500 w/8' Bed	2	45	
79-86		GMC K3500 w/8' Bed	2	45	
88-91		Chevrolet C2500 Crew Cab w/8' Bed	2	45	
88-91		Chevrolet C3500 Crew Cab w/8' Bed	2	45	
88-91		Chevrolet K2500 Crew Cab w/8' Bed	2	45	
88-91		Chevrolet K3500 Crew Cab w/8' Bed	2	45	
88-91		GMC C2500 Crew Cab w/8' Bed	2	45	
88-91		GMC C3500 Crew Cab w/8' Bed	2	45	
99-00		Ford F-350 Super Duty Cab & Chassis, w/34" Wide Frames	2	45	
<b>37088</b>		99-00	Ford F-350 Super Duty Cab & Chassis, w/34" Wide Frames	2	60
		99-17	Ford F-450 Super Duty Cab & Chassis, w/34" Wide Frames	2	60
		99-17	Ford F-550 Super Duty Cab & Chassis, w/34" Wide Frames	2	60

PART NO.	YEARS	MAKE/MODEL	REC SIZE	IN
<b>37090</b>	04-05	Ford F-150	2	30
	06-06	Lincoln Mark LT (Built Before 8/2005)	2	30
<b>37092</b>	04-15	Nissan Titan	2	15
<b>44006</b>	01-03	Chrysler Voyager	2	30
	04-07	Chrysler Town & Country Except w/Stow & Go Seats	2	30
	04-07	Dodge Caravan Except w/Stow & Go Seats	2	30
	04-07	Dodge Grand Caravan Except w/Stow & Go Seats	2	30
	96-00	Plymouth Grand Voyager	2	30
	96-00	Plymouth Voyager	2	30
	96-03	Chrysler Town & Country	2	30
	96-03	Dodge Caravan	2	30
	96-03	Dodge Grand Caravan	2	30
	<b>44007</b>	00-03	Ford F-150 SuperCrew	2
04-04		Ford F-150 Heritage Flareside	2	20
04-04		Ford F-150 Heritage Styleside	2	20
97-03		Ford F-150 Flareside	2	20
97-03		Ford F-150 Styleside	2	20
97-99		Ford F-250 Styleside	2	20
<b>44010</b>	90-05	Chevrolet Astro Extended Body	2	30
	90-05	GMC Safari Extended Body	2	30
<b>44011</b>	78-95	Chevrolet G10	2	45
	78-95	Chevrolet G20	2	45
	78-95	Chevrolet G30	2	45
	79-95	GMC G1500	2	45
	79-95	GMC G2500	2	45
	79-95	GMC G3500	2	45
	96-96	Chevrolet G30 Classic & Sport Full Size w/Lo-Mount Taillights	2	45
	96-96	GMC G3500 Vandura & Rally Full Size w/Lo-Mount Taillights	2	45
<b>44026</b>	80-83	Ford F-100 Except w/Custom Fascia	2	30
	80-86	Ford F-150 Except w/Custom Fascia	2	30
	80-86	Ford F-250 Except w/Custom Fascia	2	30
	80-86	Ford F-350 Except w/Custom Fascia	2	30
	87-96	Ford F-150	2	30
87-96	Ford F-250	2	30	
87-96	Ford F-350	2	30	
97-97	Ford F-250 Heavy Duty	2	30	
97-97	Ford F-350 Heavy Duty	2	30	
<b>44027</b>	75-02	Ford E-150 Econoline	2	30
	75-02	Ford E-250 Econoline	2	30
	75-83	Ford E-100 Econoline	2	30
<b>44028</b>	96-03	GMC Savana 2500	2	30
	96-14	Chevrolet Express 1500	2	30
	96-14	GMC Savana 1500	2	30
	96-17	GMC Savana 3500	2	30
	96-19	Chevrolet Express 2500	2	30
	96-19	Chevrolet Express 3500	2	30
<b>44051</b>	95-04	Toyota Tacoma (App. starts with 95-1/2)	2	40
<b>44054</b>	00-06	Toyota Tundra	2	20
<b>44062</b>	98-00	Isuzu Hombre w/Step Bumper	2	20
	98-04	Chevrolet S10	2	20
	98-04	GMC Sonoma	2	20
<b>44064</b>	98-03	Dodge Durango	2	20
<b>44067</b>	01-01	Ford Explorer 4 Dr.	2	45
	01-03	Ford Explorer 2 Dr. Sport	2	45
	91-00	Ford Explorer	2	45
	91-94	Mazda Navajo	2	45
	97-01	Mercury Mountaineer	2	45
<b>44076</b>	01-03	Toyota Highlander	2	15
	99-03	Lexus RX300	2	15
<b>44082</b>	02-07	Jeep Liberty	2	20
<b>44088</b>	84-01	Jeep Cherokee	2	40
	84-90	Jeep Wagoneer	2	40
<b>44089</b>	01-07	Toyota Sequoia Except Models w/OEM Hitch	2	25
<b>44092</b>	99-04	Jeep Grand Cherokee	2	20
<b>44093</b>	93-93	Jeep Grand Wagoneer	2	20
	93-98	Jeep Grand Cherokee	2	20
<b>44094</b>	78-80	Dodge Van, B100	2	30
	78-80	Dodge Van, B200	2	30
	78-80	Dodge Van, B300	2	30
	81-94	Dodge Van, B150	2	30
	81-94	Dodge Van, B250	2	30
	81-94	Dodge Van, B350	2	30
	95-98	Dodge Van, B1500	2	30
	95-98	Dodge Van, B2500	2	30
	95-98	Dodge Van, B3500	2	30
	99-03	Dodge Van, Ram 1500	2	30
	99-03	Dodge Van, Ram 2500	2	30
	99-03	Dodge Van, Ram 3500	2	30

# CLASS III/IV RECEIVER HITCH INDEX

PART NO.	YEARS	MAKE/MODEL	REC SIZE	IN	
44098	95-05	Chevrolet Blazer Downsize	2	20	
	95-05	GMC Jimmy Downsize	2	20	
	96-01	Oldsmobile Bravada	2	20	
	99-01	Chevrolet Blazer Trailblazer	2	20	
44100	01-01	Ford Explorer 4 Dr.	2	20	
	01-03	Ford Explorer 2 Dr. Sport	2	20	
	91-00	Ford Explorer	2	20	
	91-94	Mazda Navajo	2	20	
	97-01	Mercury Mountaineer	2	20	
	44101	83-92	Ford Ranger Except GT	2	20
93-11		Ford Ranger	2	20	
94-08		Mazda B3000	2	20	
94-09		Mazda B2300	2	20	
94-09		Mazda B4000	2	20	
98-01		Mazda B2500	2	20	
44102		02-04	Dodge Dakota Except Quad Cab	2	30
	87-01	Dodge Dakota	2	30	
44103	94-01	Dodge Ram 1500	2	20	
	94-02	Dodge Ram 2500	2	20	
	94-02	Dodge Ram 3500	2	20	
	95-01	Dodge Ram 4000	2	15	
	44105	88-00	Chevrolet C3500 Regular & Extended Cabs	2	25
88-00		Chevrolet K3500 Regular & Extended Cabs	2	25	
88-00		GMC C2500	2	25	
88-00		GMC C3500	2	25	
88-00		GMC K2500	2	25	
88-00		GMC K3500	2	25	
88-99		Chevrolet C1500	2	25	
88-99		Chevrolet C2500 Regular & Extended Cabs	2	25	
88-99		Chevrolet K1500	2	25	
88-99		Chevrolet K2500 Regular & Extended Cabs	2	25	
88-99		GMC C1500	2	25	
88-99		GMC K1500	2	25	
92-00		Chevrolet C2500 Crew Cab	2	25	
92-00		Chevrolet C3500 Crew Cab	2	25	
92-00		Chevrolet K2500 Crew Cab	2	25	
92-00		Chevrolet K3500 Crew Cab	2	25	
44129		04-07	Ford Freestar	2	30
		04-07	Mercury Monterey	2	30
44131	04-05	Ford F-150	2	30	
	06-06	Lincoln Mark LT (Built Before 8/2005)	2	30	
44132	96-04	Nissan Pathfinder	2	20	
	97-03	Infiniti QX4	2	20	
44141	99-07	Ford F-250 Super Duty Except Cab & Chassis	2	20	
	99-07	Ford F-350 Super Duty Except Cab & Chassis	2	20	
44148	88-94	Nissan D21	2	30	
	95-97	Nissan Pickup	2	30	
	98-04	Nissan Frontier	2	30	
44152†	87-95	Nissan Pathfinder	2	40	
44173	04-09	Dodge Durango	2	30	
	07-09	Chrysler Aspen	2	30	
44174	99-17	Honda Odyssey	2	15	
44175	04-06	Dodge Durango	2	20	
44176	05-07	Chrysler Town & Country w/Stow & Go Seats	2	25	
	05-07	Dodge Grand Caravan w/Stow & Go Seats	2	25	
44177	06-10	Hummer H3	2	25	
44178	00-06	BMW X5	2	60	
44525	05-07	Ford Five Hundred	2	30	
	05-07	Ford Freestyle	2	30	
	05-07	Mercury Montego	2	30	
	08-09	Ford Taurus 4 Dr. Sedan	2	30	
	08-09	Ford Taurus X	2	30	
	08-09	Mercury Sable Sedan	2	30	
44526	05-19	Nissan Frontier	2	30	
	09-12	Suzuki Equator	2	30	
44528	06-14	Honda Ridgeline	2	20	
44529	05-15	Nissan Xterra	2	30	
44530	04-10	Volkswagen Touareg	2	90	
44531	04-10	BMW X3	2	100	
44534	06-07	Mercedes-Benz ML500 Except w/Adaptive Variable Suspension	2	50	
	06-09	Mercedes-Benz ML350 Except w/Adaptive Variable Suspension	2	50	
	07-08	Mercedes-Benz ML320 CDI Except w/Adaptive Variable Suspension	2	50	
	08-11	Mercedes-Benz ML550 Except w/Adaptive Variable Suspension	2	50	
	10-11	Mercedes-Benz ML350 Except BlueTEC or w/ Adaptive Variable Suspension	2	50	
	10-11	Mercedes-Benz ML450 Hybrid, Except w/ Adaptive Variable Suspension	2	50	

PART NO.	YEARS	MAKE/MODEL	REC SIZE	IN
44535	06-07	Subaru B9 Tribeca	2	35
	08-10	Subaru Tribeca	2	35
44536	03-03	Dodge Ram 1500 (Built After 11/2002)	2	25
	03-09	Dodge Ram 2500	2	25
	03-09	Dodge Ram 3500	2	25
	04-05	Dodge Ram 1500 Except Daytona/Hemi Sport Quad Cab/Ram Rumble Bee/SRT-10	2	25
	06-08	Dodge Ram 1500	2	25
44537	06-14	KIA Sedona 118.9" Long Wheelbase	2	20
	07-09	Hyundai Entourage	2	20
44538	01-05	Pontiac Aztek	2	40
	02-07	Buick Rendezvous	2	40
44542	06-10	Ford Explorer w/1-1/4" Receivers	2	25
	06-10	Mercury Mountaineer w/1-1/4" Receivers	2	25
44543	06-13	Suzuki Grand Vitara Except 3 Dr Hatchback	2	20
44545	07-14	Toyota FJ Cruiser	2	30
44546	98-07	Lexus LX470	2	20
	98-07	Toyota Land Cruiser	2	20
44547	06-07	Mercedes-Benz R500	2	25
	06-07	Mercedes-Benz R500 w/Panoramic Roof Package	2	50
	06-12	Mercedes-Benz R350	2	25
	06-12	Mercedes-Benz R350 w/Panoramic Roof Package	2	50
	07-08	Mercedes-Benz R320 CDI	2	25
	07-08	Mercedes-Benz R320 CDI w/Panoramic Roof Package	2	50
	09-09	Mercedes-Benz R320 BlueTEC	2	25
	09-09	Mercedes-Benz R320 BlueTEC w/Panoramic Roof Package	2	50
44548	03-09	Lexus GX470	2	35
	03-09	Toyota 4Runner	2	35
44549	07-09	Hyundai Santa Fe	2	20
44552	06-08	Ford F-150	2	20
	06-08	Lincoln Mark LT (Built After 8/2005)	2	20
44553	00-03	Mazda MPV w/Ground Effects	2	20
	04-06	Mazda MPV	2	20
44554	07-12	Mazda CX-7	2	40
44557	07-17	Jeep Wrangler Except w/Right Hand Drive, Hard Rock Edition, 75th Anniversary Edition & vehicles with Mopar Off Road Bumper #82213654	2	20
		Jeep Wrangler Right Hand Drive, Except Hard Rock Edition, 75th Anniversary Edition & vehicles with Mopar Off Road Bumper #82213654		
	18-18	Jeep Wrangler JK Except w/Right Hand Drive, Hard Rock Edition, 75th Anniversary Edition & vehicles with Mopar Off Road Bumper #82213654	2	20
		Jeep Wrangler JK Right Hand Drive, Except Hard Rock Edition, 75th Anniversary Edition & vehicles with Mopar Off Road Bumper #82213654		
18-19	Jeep Wrangler JL (New Body Style)	2	20	
	Jeep Wrangler JL (New Body Style)			
44558	03-09	KIA Sorento	2	15
44559	07-11	Dodge Nitro	2	20
44561	06-08	Mitsubishi Endeavor	2	25
44563	01-03	Chevrolet Silverado 1500 HD	2	15
	01-03	GMC Sierra 1500 HD	2	15
	03-07	Chevrolet Silverado 1500 (Classic)	2	15
	03-07	GMC Sierra 1500 (Classic)	2	15
	05-07	Chevrolet Silverado 1500 HD (Classic)	2	15
	05-07	GMC Sierra 1500 HD (Classic)	2	15
	99-04	Chevrolet Silverado 2500	2	15
	99-04	GMC Sierra 2500	2	15
	99-13	Chevrolet Silverado 1500	2	15
99-13	GMC Sierra 1500	2	15	
44564	01-03	Chevrolet Silverado 1500 HD	2	15
	01-03	GMC Sierra 1500 HD	2	15
	03-07	Chevrolet Silverado 1500 (Classic)	2	15
44564	03-07	GMC Sierra 1500 (Classic)	2	15
	05-07	Chevrolet Silverado 1500 HD (Classic)	2	15
	05-07	GMC Sierra 1500 HD (Classic)	2	15
	99-04	Chevrolet Silverado 2500	2	15
	99-04	GMC Sierra 2500	2	15
	99-13	Chevrolet Silverado 1500	2	15
99-13	GMC Sierra 1500	2	15	
44565	97-06	Jeep TJ (Canada Only)	2	15
	97-06	Jeep Wrangler	2	15
44566	04-08	Chrysler Pacifica	2	45
44568	07-19	Toyota Tundra (See Footnote CP)	2	20
44569	07-09	Saturn Outlook	2	25
	07-16	GMC Acadia	2	25
	08-17	Buick Enclave	2	25
	09-17	Chevrolet Traverse	2	25
	17-17	GMC Acadia Limited	2	25



PART NO.	YEARS	MAKE/MODEL	REC SIZE	IN
44570	07-09	Suzuki XL-7	2	30
44572	07-15	Mazda CX-9	2	15
44573	07-12	Hyundai Veracruz	2	30
44574	05-06	Pontiac Montana SV6	2	40
	05-07	Buick Terraza	2	40
	05-07	Saturn Relay	2	40
	05-08	Chevrolet Uplander	2	40
	07-09	Pontiac Montana SV6 (Canada Only)	2	40
	09-09	Chevrolet Uplander (Canada Only)	2	40
	97-04	Oldsmobile Silhouette	2	40
	97-05	Chevrolet Venture	2	40
	97-98	Pontiac Trans Sport	2	40
	99-05	Pontiac Montana	2	40
44575	07-11	Honda CR-V	2	25
44576	07-09	Dodge Sprinter 2500 144" & 170" Wheelbase, Except w/Factory Step Bumper	2	20
	07-09	Dodge Sprinter 3500 144" & 170" Wheelbase, Except w/Factory Step Bumper	2	20
	07-13	Freightliner Sprinter 2500 144" & 170" Wheelbase, Except w/Factory Step Bumper	2	20
	07-13	Freightliner Sprinter 3500 144" & 170" Wheelbase, Except w/Factory Step Bumper	2	20
	07-17	Mercedes-Benz Sprinter 144" & 170" Wheelbase, Except w/Factory Step Bumper	2	20
	10-19	Mercedes-Benz Sprinter 2500 144" & 170" Wheelbase, Except w/Factory Step Bumper	2	20
	10-19	Mercedes-Benz Sprinter 3500 144" & 170" Wheelbase, Except w/Factory Step Bumper	2	20
44577	01-02	Chevrolet Silverado 3500	2	20
	01-02	GMC Sierra 3500	2	20
	01-10	Chevrolet Silverado 2500 HD	2	20
	01-10	GMC Sierra 2500 HD	2	20
	03-07	Chevrolet Silverado 2500 HD (Classic)	2	20
	03-07	Chevrolet Silverado 3500 (Classic)	2	20
	03-07	GMC Sierra 2500 HD (Classic)	2	20
	03-07	GMC Sierra 3500 (Classic)	2	20
	07-10	Chevrolet Silverado 3500 HD	2	20
	07-10	GMC Sierra 3500 HD	2	20
44578	07-10	KIA Sedona 113.8" Short Wheelbase	2	25
44579	07-10	Mitsubishi Outlander	2	25
	11-13	Mitsubishi Outlander Except Outlander Sport	2	25
44580	08-09	Saturn Vue	2	15
	12-15	Chevrolet Captiva Sport	2	15
44581	05-07	Subaru Legacy Sedan, Except Outback	2	25
	05-07	Subaru Legacy Wagon, Except Outback	2	25
	05-07	Subaru Outback Sedan, Except Sport	2	25
	05-09	Subaru Outback Wagon, Except Sport	2	25
	08-09	Subaru Legacy Sedan	2	25
44582	05-09	Hyundai Tucson	2	25
	05-10	KIA Sportage 4 Cyl.	2	25
	05-10	KIA Sportage 6 Cyl.	2	25
44583	03-07	Nissan Murano	2	30
44584	07-09	Acura RDX	2	30
44585	08-12	Jeep Liberty	2	20
44586	08-16	Chrysler Town & Country	2	20
	08-19	Dodge Grand Caravan	2	20
	09-12	Volkswagen Routan	2	20
	12-15	RAM C/V Tradesman	2	20
	13-14	Volkswagen Routan (Canada Only)	2	20
44587	08-13	Toyota Highlander Except w/Full Size 19" Spare Tire	2	25
44589	01-06	Acura MDX Except w/Full Size Spare Tire	2	30
	03-08	Honda Pilot	2	30
44590	07-18	BMW X5 Except M Sport Package	2	75
44591	07-09	Dodge Sprinter 2500 w/Factory Step Bumper Excluding Models w/30-3/8" Frame Width	2	30
	07-09	Dodge Sprinter 3500 w/Factory Step Bumper Excluding Models w/30-3/8" Frame Width	2	30
	07-13	Freightliner Sprinter 2500 w/Factory Step Bumper Excluding Models w/30-3/8" Frame Width	2	30
	07-13	Freightliner Sprinter 3500 w/Factory Step Bumper Excluding Models w/30-3/8" Frame Width	2	30
	07-17	Mercedes-Benz Sprinter w/Factory Step Bumper Excluding Models w/30-3/8" Frame Width	2	30
	10-19	Mercedes-Benz Sprinter 2500 w/Factory Step Bumper Excluding Models w/30-3/8" Frame Width	2	30
	10-19	Mercedes-Benz Sprinter 3500 w/Factory Step Bumper Excluding Models w/30-3/8" Frame Width	2	30
44593	04-12	Chevrolet Colorado	2	25
	04-12	GMC Canyon	2	25
	06-06	Isuzu i-280	2	25

PART NO.	YEARS	MAKE/MODEL	REC SIZE	IN
44593	06-06	Isuzu i-350	2	25
	07-08	Isuzu i-290	2	25
	07-08	Isuzu i-370	2	25
44594	07-13	Acura MDX Except w/Full Size Spare Tire or w/Rear Sport Bumper Option	2	35
44596	08-14	Nissan Armada	2	15
44600	09-14	Nissan Murano Except w/Aero Kit & CrossCab-riole	2	35
44601	09-10	Dodge Journey	2	25
	11-19	Dodge Journey w/LED Taillights	2	25
	12-19	Dodge Journey Except w/LED Taillights	2	25
44602	08-19	Toyota Sequoia	2	40
44603	03-03	Dodge Ram 1500 (Built After 11/2002)	2	20
	03-09	Dodge Ram 2500	2	20
	03-09	Dodge Ram 3500	2	20
	04-05	Dodge Ram 1500 Except Daytona/Hemi Sport Quad Cab/Ram Rumble Bee/SRT-10	2	20
	06-10	Dodge Ram 1500	2	20
	11-18	RAM 1500	2	20
	19-19	RAM 1500 (Classic)	2	20
44604	09-16	Toyota Venza	2	20
44607	09-13	Subaru Forester	2	35
44611	09-17	Volkswagen Tiguan	2	20
44612	03-04	Honda Element	2	30
	05-10	Honda Element SC	2	35
	05-11	Honda Element Except SC	2	30
44621	98-01	Honda Passport w/Door Mounted Spare	2	15
	98-01	Isuzu Rodeo w/Door Mounted Spare	2	15
44622	97-02	Ford Expedition	2	15
	98-02	Lincoln Navigator	2	15
44629	10-17	Volvo XC60	2	45
44631	10-19	Subaru Legacy Sedan	2	45
	10-19	Subaru Outback Wagon, Except Sport	2	45
44632	10-19	Ford Taurus 4 Dr. Sedan	2	30
44633	10-15	Lexus RX350 Except F Sport	2	30
	10-15	Lexus RX450h Hybrid	2	30
44634	10-13	Ford Transit Connect	2	20
44636	09-19	Ford Flex	2	30
	10-17	Lincoln MKT	2	30
44638	10-16	Cadillac SRX	2	15
44639	10-12	Hyundai Santa Fe	2	15
	11-13	KIA Sorento EX V6, w/Factory Tow Package	2	15
	11-13	KIA Sorento Except SX V6 & EX V6 w/Factory Tow Package	2	15
	11-13	KIA Sorento SX V6	2	15
44640	08-14	Land Rover LR2	2	20
44641	09-10	Ford Edge Sport	2	45
44643	02-06	Honda CR-V	2	30
44644	10-19	Lexus GX460	2	15
44645	09-14	Ford F-150	2	20
44650	11-13	Jeep Grand Cherokee Except w/OEM Tow Hook	2	20
	11-13	Jeep Grand Cherokee w/OEM Tow Hook	2	40
	14-19	Jeep Grand Cherokee Except w/OEM Tow Hook or ECODiesel Engine	2	20
	14-19	Jeep Grand Cherokee w/OEM Tow Hook, Except w/ECODiesel Engine	2	40
44652	03-14	Ford E-350 Econoline Super Duty	2	20
	75-02	Ford E-350 Econoline	2	20
	75-14	Ford E-150 Econoline	2	20
	75-14	Ford E-250 Econoline	2	20
	75-83	Ford E-100 Econoline	2	20
44653	11-14	Chevrolet Silverado 2500 HD	2	20
	11-14	Chevrolet Silverado 3500 HD	2	20
	11-14	GMC Sierra 2500 HD	2	20
	11-14	GMC Sierra 3500 HD	2	20
44654	09-17	Audi Q5	2	30
44655	04-05	Ford F-150	2	30
	06-06	Lincoln Mark LT (Built Before 8/2005)	2	30
44656	92-00	GMC Yukon	2	30
	92-94	Chevrolet Blazer Full Size	2	30
	92-99	Chevrolet Suburban C1500	2	30
	92-99	Chevrolet Suburban C2500	2	30
	92-99	Chevrolet Suburban K1500	2	30
	92-99	Chevrolet Suburban K2500	2	30
	92-99	GMC Suburban C1500	2	30
	92-99	GMC Suburban C2500	2	30
	92-99	GMC Suburban K1500	2	30
	92-99	GMC Suburban K2500	2	30
	95-00	Chevrolet Tahoe	2	30



# CLASS III/IV RECEIVER HITCH INDEX

PART NO.	YEARS	MAKE/MODEL	REC SIZE	IN	
44656	99-00	Cadillac Escalade	2	30	
	99-00	GMC Yukon Denali	2	30	
44657	01-02	Chevrolet Silverado 2500 HD	2	20	
	01-02	Chevrolet Silverado 3500	2	20	
	01-02	GMC Sierra 2500 HD	2	20	
	01-02	GMC Sierra 3500	2	20	
	03-07	Chevrolet Silverado 2500 HD (Classic)	2	20	
	03-07	Chevrolet Silverado 3500 (Classic)	2	20	
	03-07	GMC Sierra 2500 HD (Classic)	2	20	
	03-07	GMC Sierra 3500 (Classic)	2	20	
44661	07-10	Jeep Compass	2	15	
	07-10	Jeep Compass Rallye Edition	2	30	
	07-17	Jeep Patriot	2	15	
	07-17	Jeep Patriot	2	30	
	11-17	Jeep Compass (Old Body Style)	2	30	
44662	11-19	Dodge Durango	2	20	
	14-19	Jeep Grand Cherokee EcoDiesel	2	20	
44663	11-16	Nissan Quest	2	35	
	12-19	Nissan NV1500	2	20	
	12-19	Nissan NV2500	2	20	
	12-19	Nissan NV3500	2	20	
44665	11-14	Subaru Tribeca	2	30	
44666	10-15	Hyundai Tucson	2	20	
	11-16	KIA Sportage	2	20	
44668	00-06	Chevrolet Suburban 1500 w/Amber Turn Signals	2	15	
	00-06	Chevrolet Suburban 2500 w/Amber Turn Signals	2	15	
	00-06	Chevrolet Tahoe w/Amber Turn Signals	2	15	
	00-06	GMC Yukon w/Amber Turn Signals	2	15	
	00-06	GMC Yukon XL 1500	2	15	
	00-06	GMC Yukon XL 2500	2	15	
	01-02	GMC Yukon Denali w/Amber Turn Signals	2	15	
	01-02	GMC Yukon XL 1500 Denali	2	15	
	02-02	Cadillac Escalade	2	15	
	02-02	Cadillac Escalade EXT	2	15	
	02-06	Chevrolet Avalanche 1500	2	15	
	02-06	Chevrolet Avalanche 2500	2	15	
	44670	08-13	Toyota Highlander	2	40
	44672	11-14	Ford Edge Sport	2	45
	44673	00-03	Ford F-150 SuperCrew	2	20
04-04		Ford F-150 Heritage Flareside	2	20	
04-04		Ford F-150 Heritage Styleside	2	20	
97-03		Ford F-150 Flareside	2	20	
97-03		Ford F-150 Styleside	2	20	
97-99		Ford F-250 Styleside	2	20	
99-07		Ford F-250 Super Duty Except Cab & Chassis	2	20	
99-07		Ford F-350 Super Duty Except Cab & Chassis	2	20	
44674		04-04	Nissan Pathfinder Armada	2	15
		04-10	Infiniti QX56	2	15
	05-07	Nissan Armada	2	15	
44675	12-16	Honda CR-V	2	40	
44680	05-11	Mazda Tribute	2	25	
	05-11	Mercury Mariner	2	25	
	05-12	Ford Escape	2	25	
44681	13-19	Ford Escape	2	15	
44684	13-15	BMW X1 w/Panoramic Moonroof	2	60	
44685	84-95	Toyota Pickup Except T-100	2	60	
44687	11-17	BMW X3	2	90	
44689	13-18	Hyundai Santa Fe Sport (5 Passenger)	2	30	
	14-15	KIA Sorento w/ I4 Engine	2	30	
	14-15	KIA Sorento w/ V6 Engine	2	30	
44690	10-15	Mercedes-Benz GLK350	2	20	
44691	13-18	Hyundai Santa Fe (6/7 Passenger)	2	30	
44692	09-12	Infiniti FX35	2	40	
44692	09-13	Infiniti FX50	2	40	
	13-13	Infiniti FX37	2	40	
	14-19	Infiniti QX70	2	40	
44694	13-19	Ford Escape	2	60	
44695	10-18	Acura RDX	2	30	
44698†	14-14	Jeep Cherokee Except Trailhawk	2	20	
	15-16	Jeep Cherokee Except Trailhawk & V6 Models	2	20	
44701	14-15	Jeep Cherokee Trailhawk	2	30	
44702	14-19	Ford Transit Connect	2	15	
44703	14-19	Chevrolet Silverado 1500 LD (Old Body Style)	2	20	
	14-19	GMC Sierra 1500 LD (Old Body Style)	2	20	
44705	14-18	Subaru Forester	2	25	
44706	14-19	RAM ProMaster 1500 Except w/Extended Body	2	45	
	14-19	RAM ProMaster 2500 Except w/Extended Body	2	45	
	14-19	RAM ProMaster 3500 Except w/Extended Body	2	45	

PART NO.	YEARS	MAKE/MODEL	REC SIZE	IN
44707	14-15	Mitsubishi Outlander Except Outlander Sport	2	30
	16-19	Mitsubishi Outlander Except Outlander Sport or PHEV	2	30
44709	15-19	KIA Sedona	2	20
44710	14-19	Toyota Highlander	2	30
44711	13-17	Nissan NV200	2	30
	15-17	Chevrolet City Express	2	30
44712	08-13	Nissan Rogue Except Krom	2	15
	14-14	Nissan Rogue Select	2	15
	14-19	Nissan Rogue Except Sport	2	15
44716	99-04	Jeep Grand Cherokee	2	75
44719	15-19	Ford Transit-150 Except Cab & Chassis and the Cutaway	2	25
	15-19	Ford Transit-250 Except Cab & Chassis and the Cutaway	2	25
	15-19	Ford Transit-350 Except Single Rear Wheel w/148" Wheelbase or Cab & Chassis and the Cutaway	2	25
44720	15-19	Ford Transit-350 Single Rear Wheel w/148" Wheelbase, Except Cab & Chassis and the Cutaway	2	25
	02-05	Mercedes-Benz ML500	2	30
	03-05	Mercedes-Benz ML350	2	30
	98-02	Mercedes-Benz ML320	2	30
44723	01-04	Ford Escape	2	35
	01-04	Mazda Tribute	2	35
44733	98-03	Dodge Durango	2	30
44738	03-03	Dodge Ram 1500 (Built After 11/2002)	2	20
	03-09	Dodge Ram 2500	2	20
	03-09	Dodge Ram 3500	2	20
	04-05	Dodge Ram 1500 Except Daytona/Hemi Sport Quad Cab/Ram Rumble Bee/SRT-10	2	20
	06-08	Dodge Ram 1500	2	20
44746	05-15	Toyota Tacoma Except X-Runner	2	30
44748	05-10	Jeep Grand Cherokee Except SRT-8	2	90
	06-10	Jeep Commander	2	20
44749	15-17	Chevrolet Silverado 3500 HD	2	30
	15-17	GMC Sierra 3500 HD	2	30
	15-19	Chevrolet Silverado 2500 HD	2	30
	15-19	GMC Sierra 2500 HD	2	30
44750	16-19	KIA Sorento w/ I4 Engine	2	40
	16-19	KIA Sorento w/ V6 Engine	2	40
	19-19	Hyundai Santa Fe	2	40
44754	15-19	Ford F-150	2	30
44755	11-17	Audi Q5	2	60
	15-17	Porsche Macan	2	60
44756	15-19	Lincoln MKC	2	45
44757	15-19	Chevrolet Colorado	2	35
	15-19	GMC Canyon	2	35
44758	07-16	Audi Q7	2	70
	11-17	Volkswagen Touareg	2	70
	11-18	Porsche Cayenne	2	70
44761	15-19	Nissan Murano	2	15
44762	15-17	Lexus NX200t	2	35
44763†	15-16	Jeep Renegade	2	30
44764	07-14	Ford Edge Except Sport	2	55
	07-15	Lincoln MKX	2	55
44765	14-19	Jeep Cherokee	2	60
	14-19	Jeep Cherokee	2	20
44766	15-15	Ford Edge Titanium Model Only	2	30
	15-18	Ford Edge Except Sport & Titanium Models	2	30
	19-19	Ford Edge Except Titanium Models	2	30
44767	15-19	Ford F-150	2	30
44769	13-18	Audi Q3	2	50
44770	15-17	RAM ProMaster City	2	60
44777	15-19	Mercedes-Benz GLA250	2	90
	17-17	Infiniti QX30 Except Sport Model	2	90
44778	14-19	Acura MDX Except w/Full Size Spare Tire	2	20
	16-19	Honda Pilot	2	20
44779	12-19	Land Rover Range Rover Evoque Excluding Autobiography	2	45
44780	16-18	Hyundai Tucson	2	30
44781	15-17	Land Rover Range Rover Sport	2	45
44782	11-18	RAM 1500	2	40
	19-19	RAM 1500 (Classic)	2	40

PART NO.	YEARS	MAKE/MODEL	REC SIZE	IN
44784	15-18	Ford Edge Except Sport & Titanium Models	2	45
	15-18	Ford Edge Titanium and Sport Models Only	2	45
	16-18	Lincoln MKX	2	45
	19-19	Ford Edge Except Titanium Models	2	30
	19-19	Lincoln Nautilus	2	45
44785	06-18	Toyota RAV4	2	20
44786	04-14	Toyota Sienna	2	30
	15-20	Toyota Sienna Except SE	2	30
	15-20	Toyota Sienna SE	2	30
44999	08-10	Volvo V70 Wagon	2	70
	08-16	Volvo XC70	2	70
	11-18	Volvo S60 Sedan	2	70
	15-17	Volvo V60 (App. starts with 2015-1/2)	2	70
76326	19-20	Chevrolet, Silverado 1500, All Styles	2	60
	19-20	GMC, Sierra 1500, All Styles	2	60
76328	19-20	RAM, 1500, All Styles	2	15
76332	2020	Subaru, Legacy, Sedan	2	40
	2020	Subaru, Outback, Wagon	2	40
76333	2020	Subaru, Outback, Wagon	2	40
76336	18-20	Lexus, RX350L, All Styles	2	45
	14-20	Toyota, Highlander, All Styles	2	45
76420	2020	Hyundai, Palisade, All Styles	2	30
	2020	KIA, Telluride, All Styles	2	30
84014†	16-19	Volvo XC90	2	90
84015	16-19	Mercedes-Benz Metris	2	20
84016	14-19	Chevrolet Silverado 1500 LD (Old Body Style)	2	25
	14-19	GMC Sierra 1500 LD (Old Body Style)	2	25
84018	16-19	BMW X1	2	40
84019	16-19	FIAT 500x	2	45
84020	16-19	Mazda CX-9	2	30
84021	15-18	Jeep Renegade	2	40
84022	17-19	Cadillac XT5 Except Platinum	2	20
84023	17-19	GMC Acadia	2	90
	19-19	Chevrolet Blazer	2	90
	20-20	Cadillac XT6	2	0
84025	11-17	Honda Odyssey	2	80
84026	17-19	Jaguar F-Pace	2	90
84028	02-07	Saturn Vue Except Redline	2	30
	05-17	Chevrolet Equinox	2	30
	06-09	Pontiac Torrent	2	30
	10-17	GMC Terrain	2	30
84031	13-13	Infiniti JX35	2	25
	13-19	Nissan Pathfinder	2	25
	14-19	Infiniti QX60	2	25
84034	11-19	Ford Explorer	2	45
84046	17-19	Chrysler Pacifica Hybrid (Needs Conversion Kit: 76046SK)	2	45
	17-19	Chrysler Pacifica Limited	2	45
	17-19	Chrysler Pacifica LX	2	45
	17-19	Chrysler Pacifica Touring	2	45
	17-19	Chrysler Pacifica Touring L	2	45
	17-19	Chrysler Pacifica Touring L Plus	2	45
	17-19	Chrysler Pacifica Touring Plus	2	45
84050	14-19	RAM ProMaster 1500 All Models	2	45
	14-19	RAM ProMaster 2500 All Models	2	45
	14-19	RAM ProMaster 3500 All Models	2	45
84074	17-19	KIA Sportage Except SX & SX Turbo	2	25
84076	17-18	Audi Q7	2	60
84078	16-17	Nissan NP300 Navara International Only	2	30
84080	16-18	Buick Envision	2	45
84082	16-19	Mercedes-Benz GLC300 SUV, Except P03 Premium Package	2	65
	16-19	Mercedes-Benz GLC300 SUV, with P03 Premium Package	2	65
84084	13-15	Subaru XV Crosstrek Except Hybrid	2	20
	16-17	Subaru Crosstrek Except Hybrid	2	20
	16-17	Subaru Crosstrek Hybrid	2	20
84098	11-17	Mitsubishi RVR (Canada Only)	2	30
	11-19	Mitsubishi Outlander Sport Except PHEV	2	20
84104†	07-17	Jeep Wrangler Except w/Right Hand Drive	2	20
	07-17	Jeep Wrangler Right Hand Drive	2	20
	18-18	Jeep Wrangler JK Except w/Right Hand Drive	2	20
	18-18	Jeep Wrangler JK Right Hand Drive	2	20
	18-19	Jeep Wrangler JL (New Body Style)	2	20
84112	11-14	Toyota Sienna	2	60
	15-20	Toyota Sienna Except SE	2	60
	15-20	Toyota Sienna SE	2	60

PART NO.	YEARS	MAKE/MODEL	REC SIZE	IN
84114	15-16	Mitsubishi L200 w/Factory Step Bumper	2	45
	15-16	Mitsubishi Triton w/Factory Step Bumper	2	45
84116	14-17	Volvo XC60	2	30
84128	17-19	Honda CR-V	2	20
84134	13-18	Toyota RAV4	2	20
	13-18	Toyota RAV4	2	45
84136	15-19	Ford F-150	2	30
84138	13-19	Mazda CX-5	2	20
84141	12-15	Mercedes-Benz ML350 Except w/Active Curve System	2	40
	16-19	Mercedes-Benz GLE350 Except w/Active Curve System	2	40
84143	16-17	Tesla X	2	75
84144	17-19	Jeep Compass (New Body Style)	2	40
84145	05-08	Dodge Magnum	2	30
	06-19	Dodge Charger	2	30
	08-19	Dodge Challenger Except Models w/Quad Tip Exhaust	2	30
84154	17-17	Nissan Titan Except Titan XD or Models w/ Factory 7-Way Wiring	2	30
	17-17	Nissan Titan w/ Factory 7-Way Wiring Except Titan XD	2	30
84156	14-19	Toyota Highlander	2	45
84170	18-19	Honda Odyssey With Fuse Provisions	2	80
	18-19	Honda Odyssey Without Fuse Provisions	2	80
84171	18-19	Honda Odyssey With Fuse Provisions	2	80
	18-19	Honda Odyssey Without Fuse Provisions	2	80
84176	18-19	Volkswagen Atlas	2	25
84177	17-17	Nissan Qashqai	2	45
	17-19	Nissan Rogue Sport	2	45
84182	14-18	Subaru Forester	2	60
84183	18-18	Audi SQ5	2	90
	18-19	Audi Q5	2	90
84184	18-19	Buick Enclave	2	75
	18-19	Chevrolet Traverse	2	75
84190	16-19	Volvo XC90	2	45
84192	18-19	Volkswagen Tiguan 4 Motion	2	40
84192	18-19	Volkswagen Tiguan Except 4 Motion	2	40
84194	16-19	Volvo XC90	2	65
	18-19	Volvo XC60	2	65
84196	11-19	Dodge Durango	2	90
84199	18-18	Alfa Romeo Stelvio Except Quadrifoglio	2	80
84200	18-18	BMW X2	2	80
84201	19-19	Toyota RAV4	2	35
84209	18-19	Subaru Crosstrek Except Hybrid	2	60
	18-19	Subaru Crosstrek Hybrid	2	60
	18-19	Subaru Impreza 5 Dr. Wagon, Except WRX STi & w/Quad Exhaust Outlets	2	60
84217	18-19	GMC Terrain Diesel	2	70
	18-20	Chevrolet Equinox Diesel	2	70
84225	09-10	Dodge Journey	2	90
	11-19	Dodge Journey w/LED Taillights	2	90
	12-19	Dodge Journey Except w/LED Taillights	2	90
84226	11-19	BMW X3	2	75
84227	10-19	Subaru Outback Wagon, Except Sport	2	45
84238	16-19	Toyota Tacoma	2	20
84240	19-19	Infiniti QX50	2	20
84244	18-19	Mitsubishi Eclipse Cross	2	20
84245	19-19	Volvo XC40	2	70
84253	19-19	Subaru Ascent	2	60
84260	18-19	Land Rover Range Rover Velar	2	80
84266	19-19	Cadillac XT4	2	80
84268	19-20	Acura RDX With +12V Power Provision	2	25
	19-20	Acura RDX Without +12V Power Provision	2	25
84271	19-19	Subaru Forester	2	30
84275	19-19	Ford Ranger	2	20
84288	19-19	BMW X5 Except M Sport Package	2	90
84290	19-19	Honda Passport	2	20
84300	19-19	Buick Envision	2	25
84320	20-20	Ford Explorer	2	40
84330	18-19	Jaguar E-Pace	2	90
84403	20-20	Hyundai Palisade	2	30
84403	20-20	KIA Telluride	2	30
84419	18-19	GMC Terrain Except Diesel	2	35
	18-20	Chevrolet Equinox Except Premier or Models w/1.6L Diesel	2	35

# CLASS III/IV RECEIVER HITCH INDEX

PART NO.	YEARS	MAKE/MODEL	REC SIZE	IN
84419	18-20	Chevrolet Equinox Premier, Except Models w/1.6L Diesel	2	35
84540	16-19	Lexus RX350	2	20
	16-19	Lexus RX450h	2	40
84790	13-16	Ford Ranger	2	30
84791	16-17	Toyota Hilux	2	45
84808†	13-13	Volkswagen Amarok (International Only)	2	30
84914	14-14	Toyota Hilux SW4	2	15
84999	15-19	Chevrolet Colorado	2	35
	15-19	GMC Canyon	2	35
96522	88-00	Chevrolet C3500 w/Aftermarket Roll Pan	2	40
	88-00	Chevrolet K3500 w/Aftermarket Roll Pan	2	40
	88-00	GMC C2500 w/Aftermarket Roll Pan	2	40
	88-00	GMC C3500 w/Aftermarket Roll Pan	2	40
	88-00	GMC K2500 w/Aftermarket Roll Pan	2	40
	88-00	GMC K3500 w/Aftermarket Roll Pan	2	40
	88-99	Chevrolet C1500 w/Aftermarket Roll Pan	2	40
	88-99	Chevrolet C2500 w/Aftermarket Roll Pan	2	40
	88-99	Chevrolet K1500 w/Aftermarket Roll Pan	2	40
	88-99	Chevrolet K2500 w/Aftermarket Roll Pan	2	40
	88-99	GMC C1500 w/Aftermarket Roll Pan	2	40
	88-99	GMC K1500 w/Aftermarket Roll Pan	2	40
96524	88-00	Chevrolet C3500 Regular & Extended Cabs	2	20
	88-00	Chevrolet K3500 Regular & Extended Cabs	2	20
	88-00	GMC C2500	2	20
	88-00	GMC C3500	2	20
	88-00	GMC K2500	2	20
	88-00	GMC K3500	2	20
	88-99	Chevrolet C1500	2	20
	88-99	Chevrolet C2500 Regular & Extended Cabs	2	20
	88-99	Chevrolet K1500	2	20
	88-99	Chevrolet K2500 Regular & Extended Cabs	2	20
	88-99	GMC C1500	2	20
	88-99	GMC K1500	2	20
	92-00	Chevrolet C2500 Crew Cab	2	20
	92-00	Chevrolet C3500 Crew Cab	2	20
	92-00	Chevrolet K2500 Crew Cab	2	20
	92-00	Chevrolet K3500 Crew Cab	2	20
96528	88-00	Chevrolet C3500 Regular & Extended Cabs, w/10" Deep Drop Bumper	2	20
	88-00	Chevrolet K3500 Regular & Extended Cabs, w/10" Deep Drop Bumper	2	20
	88-00	GMC C2500 w/10" Deep Drop Bumper	2	20
	88-00	GMC C3500 w/10" Deep Drop Bumper	2	20
	88-00	GMC K2500 w/10" Deep Drop Bumper	2	20
	88-00	GMC K3500 w/10" Deep Drop Bumper	2	20
	88-99	Chevrolet C1500 w/10" Deep Drop Bumper	2	20
	88-99	Chevrolet C2500 Regular & Extended Cabs, w/10" Deep Drop Bumper	2	20
	88-99	Chevrolet K1500 w/10" Deep Drop Bumper	2	20
	88-99	Chevrolet K2500 Regular & Extended Cabs, w/10" Deep Drop Bumper	2	20
	88-99	GMC C1500 w/10" Deep Drop Bumper	2	20
	88-99	GMC K1500 w/10" Deep Drop Bumper	2	20
	92-00	Chevrolet C2500 Crew Cab w/10" Deep Drop Bumper	2	20
	92-00	Chevrolet C3500 Crew Cab w/10" Deep Drop Bumper	2	20
	92-00	Chevrolet K2500 Crew Cab w/10" Deep Drop Bumper	2	20
	92-00	Chevrolet K3500 Crew Cab w/10" Deep Drop Bumper	2	20
96543	01-06	Hyundai Santa Fe	2	35
<b>CLASS III/IV MULTI-FIT RECEIVER</b>				
37034	00-03	Ford F-150 SuperCrew	2	25
	00-06	Toyota Tundra	2	30
	01-03	Chevrolet Silverado 1500 HD	2	25
	01-03	GMC Sierra 1500 HD	2	25
	03-07	Chevrolet Silverado 1500 (Classic)	2	25
	03-07	GMC Sierra 1500 (Classic)	2	25
	04-04	Ford F-150 Heritage Flareside	2	25
	04-04	Ford F-150 Heritage Styleside	2	25
	05-07	Chevrolet Silverado 1500 HD (Classic)	2	25
	05-07	GMC Sierra 1500 HD (Classic)	2	25
	71-80	Dodge D200	2	25
	71-80	Dodge D300	2	25
	71-80	Dodge W200	2	25
	71-80	Dodge W300	2	25
37034	71-89	Dodge D100	2	25
	71-89	Dodge W100	2	25
	75-79	Ford F-100	2	35
	75-96	Ford F-150	2	35
	75-96	Ford F-250	2	35

PART NO.	YEARS	MAKE/MODEL	REC SIZE	IN
37034	75-96	Ford F-350	2	35
	77-93	Dodge D150	2	25
	77-93	Dodge W150	2	25
	80-83	Ford F-100 Except w/Custom Fascia	2	35
	80-86	Ford F-150 Except w/Custom Fascia	2	35
	80-86	Ford F-250 Except w/Custom Fascia	2	35
	80-86	Ford F-350 Except w/Custom Fascia	2	35
	81-85	Dodge W250	2	25
	81-93	Dodge D250	2	25
	81-93	Dodge W350	2	25
	86-93	Dodge D350	2	25
	88-00	Chevrolet C3500 Regular & Extended Cabs	2	40
	88-00	Chevrolet K3500 Regular & Extended Cabs	2	40
	88-00	GMC C2500	2	40
	88-00	GMC C3500	2	40
	88-00	GMC K2500	2	40
	88-00	GMC K3500	2	40
	88-99	Chevrolet C1500	2	40
	88-99	Chevrolet C2500 Regular & Extended Cabs	2	40
	88-99	Chevrolet K1500	2	40
	88-99	Chevrolet K2500 Regular & Extended Cabs	2	40
	88-99	GMC C1500	2	40
	88-99	GMC K1500	2	40
	92-00	Chevrolet C2500 Crew Cab	2	40
	92-00	Chevrolet C3500 Crew Cab	2	40
	92-00	Chevrolet K2500 Crew Cab	2	40
	92-00	Chevrolet K3500 Crew Cab	2	40
	94-01	Dodge Ram 1500	2	40
	94-02	Dodge Ram 2500	2	40
	94-02	Dodge Ram 3500	2	40
	97-03	Ford F-150 Flareside	2	25
	97-03	Ford F-150 Styleside	2	25
	97-97	Ford F-250 HD	2	35
	97-97	Ford F-350 Heavy Duty	2	35
	97-99	Ford F-250 Styleside	2	25
	99-02	Chevrolet Silverado 1500	2	25
	99-02	GMC Sierra 1500	2	25
	99-04	Chevrolet Silverado 2500	2	25
	99-04	Ford F-250 Super Duty Except Cab & Chassis	2	30
	99-04	Ford F-350 Super Duty Except Cab & Chassis	2	30
	99-04	GMC Sierra 2500	2	25
37041	01-01	Ford Explorer 4 Dr.	2	30
	01-03	Ford Explorer 2 Dr. Sport	2	30
	03-14	Chevrolet Express 4500	2	35
	03-14	Ford E-250 Econoline Except E-250 Super Wagon Cargo Van	2	20
	03-14	GMC Savana 4500	2	35
	91-00	Ford Explorer	2	30
	91-00	Ford Explorer	2	25
	91-94	Mazda Navajo	2	25
	92-00	Ford E-350 Econoline	2	20
	92-02	Ford E-250 Econoline	2	20
	92-14	Ford E-150 Econoline	2	20
	95-05	Chevrolet Blazer Downsize	2	30
	95-05	GMC Jimmy Downsize	2	30
	96-01	Oldsmobile Bravada	2	30
	96-14	Chevrolet Express 1500	2	35
	96-14	Chevrolet Express 2500	2	35
	96-14	Chevrolet Express 3500	2	35
	96-14	GMC Savana 1500	2	35
	96-14	GMC Savana 2500	2	35
	96-14	GMC Savana 3500	2	35
	97-01	Mercury Mountaineer	2	30
	99-01	Chevrolet Blazer Trailblazer	2	30
37042	00-06	Chevrolet Suburban w/Amber Turn Signals	2	30
	00-06	Chevrolet Tahoe w/Amber Turn Signals	2	30
	00-06	GMC Yukon w/Amber Turn Signals	2	30
	00-06	GMC Yukon XL 1500	2	30
	01-02	GMC Yukon Denali w/Amber Turn Signals	2	30
	01-02	GMC Yukon XL 1500 Denali	2	30
	01-03	Chrysler Voyager	2	40
	01-04	Ford Escape	2	60
	01-04	Mazda Tribute	2	60
	02-04	Dodge Dakota Except Quad Cab	2	35
	02-07	Jeep Liberty	2	35
	03-03	Ford Windstar (Built After 11/2002)	2	40
	04-07	Chrysler Town & Country Except w/Stow & Go Seats	2	40
	04-07	Dodge Caravan Except w/Stow & Go Seats	2	40
	04-07	Dodge Grand Caravan Except w/Stow & Go Seats	2	40
	82-93	Dodge Ramcharger	2	30
	82-96	Ford Bronco	2	30
	83-04	Chevrolet S10 w/Standard Bed & Step Bumper	2	30
	83-04	GMC S15 & Sonoma w/Standard Bed & Step Bumper	2	40

# CLASS III/IV MULTI-FIT RECEIVER HITCH INDEX

PART NO.	YEARS	MAKE/MODEL	REC SIZE	IN	
<b>37042</b>	83-97	Ford Ranger Except w/Rear Fascia	2	40	
	84-00	Plymouth Voyager	2	30	
	84-00	Plymouth Voyager	2	40	
	84-01	Jeep Cherokee	2	35	
	84-01	Jeep Cherokee	2	45	
	84-90	Ford Bronco II	2	30	
	84-95	Dodge Caravan Short Wheelbase, 2 WD	2	40	
	86-87	Nissan Pickup (App. starts with 86-1/2)	2	30	
	86-97	Ford Aerostar Extended Body	2	40	
	87-00	Plymouth Grand Voyager	2	40	
	87-00	Plymouth Grand Voyager	2	30	
	87-01	Dodge Dakota	2	35	
	87-95	Dodge Grand Caravan Long Wheelbase, 2 WD	2	30	
	88-97	Nissan Pickup	2	30	
	90-05	Chevrolet Astro Extended Body	2	65	
	90-05	GMC Safari Extended Body	2	65	
	90-09	Mazda B-Series	2	30	
	90-09	Mazda B-Series	2	40	
	90-95	Chrysler Town & Country 2 WD Long Wheelbase	2	40	
	91-95	Plymouth Grand Voyager Long Wheelbase, 2 WD	2	30	
	92-00	GMC Yukon	2	30	
	92-94	Chevrolet Blazer Full Size	2	30	
	92-99	Chevrolet Suburban	2	30	
	92-99	GMC Suburban	2	30	
	93-98	Jeep Grand Cherokee	2	35	
	95-00	Chevrolet Tahoe	2	30	
	96-03	Chrysler Town & Country	2	40	
	96-03	Dodge Caravan	2	40	
	96-03	Dodge Grand Caravan	2	40	
	96-14	Chevrolet Express Van	2	30	
	96-14	GMC Savana Van	2	30	
	98-00	Isuzu Hombre w/Step Bumper	2	40	
	98-04	Nissan Frontier	2	35	
	98-11	Ford Ranger Except Flareside or w/Rear Fascia	2	40	
	99-00	GMC Yukon Denali	2	30	
	99-03	Ford Windstar (Built Before 11/2002)	2	40	
	<b>37051†</b>	01-01	Ford Explorer 4 Dr.	2	30
		01-03	Ford Explorer 2 Dr. Sport	2	30
		03-14	Ford E-250 Econoline Except E-250 Super Wagon	2	20
		91-00	Cargo Van	2	30
91-00		Ford Explorer	2	25	
91-94		Ford Explorer	2	25	
92-02		Mazda Navajo	2	20	
92-02		Ford E-250 Econoline	2	20	
92-14		Ford E-350 Econoline	2	20	
95-02		Ford E-150 Econoline	2	30	
95-05		GMC Jimmy Downsized	2	30	
96-01		Chevrolet Blazer Downsize	2	30	
96-14		Oldsmobile Bravada	2	35	
96-14		Chevrolet Express 1500	2	35	
96-14		Chevrolet Express 2500	2	35	
96-17		GMC Savana 1500	2	35	
96-17		GMC Savana 2500	2	35	
96-18		GMC Savana 3500	2	35	
97-01		Chevrolet Express 3500	2	30	
99-01		Mercury Mountaineer Chevrolet Blazer Trailblazer	2	30	
<b>37069</b>	00-03	Ford F-150 SuperCrew	2	25	
	00-06	Toyota Tundra	2	35	
	01-03	Chevrolet Silverado 1500 HD	2	25	
	01-03	GMC Sierra 1500 HD	2	25	
	03-07	Chevrolet Silverado 1500 (Classic)	2	25	
	03-07	GMC Sierra 1500 (Classic)	2	25	
	04-04	Ford F-150 Heritage Flareside	2	25	
	04-04	Ford F-150 Heritage Styleside	2	25	
	05-07	Chevrolet Silverado 1500 HD (Classic)	2	25	
	05-07	GMC Sierra 1500 HD (Classic)	2	25	
	71-80	Dodge D200	2	25	
	71-80	Dodge D300	2	25	
	71-80	Dodge W200	2	25	
	71-80	Dodge W300	2	25	
	71-89	Dodge D100	2	25	
	71-89	Dodge W100	2	25	
	75-05	Ford F-150	2	35	
	75-05	Ford F-150	2	45	
	75-79	Ford F-100	2	35	
	75-96	Ford F-250	2	35	
	75-96	Ford F-350	2	35	
	77-93	Dodge D150	2	25	
	77-93	Dodge W150	2	25	
	80-83	Ford F-100 Except w/Custom Fascia	2	35	
	80-86	Ford F-150 Except w/Custom Fascia	2	35	
	80-86	Ford F-250 Except w/Custom Fascia	2	35	
	80-86	Ford F-350 Except w/Custom Fascia	2	35	
	81-93	Dodge D250	2	25	
	81-93	Dodge D350	2	25	
	<b>37069</b>	81-93	Dodge W250	2	25
		81-93	Dodge W350	2	25
		88-00	Chevrolet C3500 Regular & Extended Cabs	2	40
		88-00	Chevrolet K3500 Regular & Extended Cabs	2	40
		88-00	GMC C2500	2	40
		88-00	GMC C3500	2	40
		88-00	GMC K2500	2	40
		88-00	GMC K3500	2	40
		88-99	Chevrolet C1500	2	40
		88-99	Chevrolet C2500 Regular & Extended Cabs	2	40
		88-99	Chevrolet K1500	2	40
88-99		Chevrolet K2500 Regular & Extended Cabs	2	40	
88-99		GMC C1500	2	40	
88-99		GMC K1500	2	40	
92-00		Chevrolet C2500 Crew Cab	2	40	
92-00		Chevrolet C3500 Crew Cab	2	40	
92-00		Chevrolet K2500 Crew Cab	2	40	
92-00		Chevrolet K3500 Crew Cab	2	40	
94-01		Dodge Ram 1500	2	40	
94-02		Dodge Ram 2500	2	40	
94-02		Dodge Ram 3500	2	40	
97-03		Ford F-150 Flareside	2	25	
97-03		Ford F-150 Styleside	2	25	
97-97		Ford F-250 Heavy Duty	2	35	
97-97		Ford F-350 Heavy Duty	2	35	
97-99		Ford F-250 Styleside	2	25	
99-02		Chevrolet Silverado 1500	2	25	
99-02		GMC Sierra 1500	2	25	
99-04		Chevrolet Silverado 2500	2	25	
99-04		Ford F-250 Super Duty Except Cab & Chassis	2	30	
99-04		Ford F-350 Super Duty Except Cab & Chassis	2	30	
99-04		GMC Sierra 2500	2	25	
<b>37094</b>		00-03	Ford F-150 SuperCrew	2	25
		00-06	Toyota Tundra	2	30
		01-06	Chevrolet Silverado 1500 HD	2	25
		01-06	GMC Sierra 1500 HD 6.6 ft. Bed	2	25
		04-04	Ford F-150 Heritage Flareside	2	25
		04-04	Ford F-150 Heritage Styleside	2	25
		07-07	Chevrolet Silverado 1500 (Classic)	2	25
		07-07	Chevrolet Silverado 1500 HD (Classic)	2	25
	07-07	GMC Sierra 1500 (Classic)	2	25	
	07-07	GMC Sierra 1500 HD 6.6 ft. Bed (Classic)	2	25	
	71-81	Dodge D200	2	25	
	71-89	Dodge D100	2	25	
	71-93	Dodge D150	2	25	
	71-93	Dodge D250	2	25	
	73-79	Ford F-100	2	35	
	73-96	Ford F-250	2	35	
	73-96	Ford F-350	2	35	
	75-75	Dodge D300	2	25	
	75-80	Dodge W200	2	25	
	75-81	Dodge W300	2	25	
	75-89	Dodge W100	2	25	
	75-96	Ford F-150	2	35	
	77-93	Dodge W150	2	25	
	78-81	Dodge D400	2	25	
	78-81	Dodge D450	2	25	
	79-82	Dodge D50	2	25	
	80-83	Ford F-100 Except w/Custom Fascia	2	35	
	80-86	Ford F-150 Except w/Custom Fascia	2	35	
	80-86	Ford F-350 Except w/Custom Fascia	2	35	
	81-93	Dodge D350	2	25	
81-93	Dodge W250	2	25		
81-93	Dodge W350	2	25		
88-00	Chevrolet C15 2 Dr. Regular & Extended Cabs w/6 ft. Bed	2	40		
88-00	Chevrolet C15 2 Dr. Regular & Extended Cabs w/8 ft. Bed	2	40		
88-00	Chevrolet C1500 2 Dr. Regular & Extended Cabs w/6 ft. Bed	2	40		
88-00	Chevrolet C1500 2 Dr. Regular & Extended Cabs w/8 ft. Bed	2	40		
88-00	Chevrolet C2500 2 Dr. Regular & Extended Cabs w/6 ft. Bed	2	40		
88-00	Chevrolet C2500 2 Dr. Regular & Extended Cabs w/8 ft. Bed	2	40		
88-00	Chevrolet C35 2 Dr. Regular & Extended Cabs w/6 ft. Bed	40			
88-00	Chevrolet C35 2 Dr. Regular & Extended Cabs w/8 ft. Bed	40			
88-00	Chevrolet C3500 2 Dr. Regular & Extended Cabs w/6 ft. Bed	40			
88-00	Chevrolet C3500 2 Dr. Regular & Extended Cabs w/8 ft. Bed	40			
88-00	Chevrolet C3500HD 2 Dr. Regular & Extended Cabs w/6 ft. Bed	40			



# CLASS III/IV MULTI-FIT RECEIVER HITCH INDEX

PART NO.	YEARS	MAKE/MODEL	REC SIZE	IN
<b>37094</b>	88-00	Chevrolet C3500HD 2 Dr. Regular & Extended Cabs w/8 ft. Bed	2	40
	88-00	Chevrolet K1500 2 Dr. Regular & Extended Cabs w/6 ft. Bed	2	40
	88-00	Chevrolet K1500 2 Dr. Regular & Extended Cabs w/8 ft. Bed	2	40
	88-00	Chevrolet K2500 2 Dr. Regular & Extended Cabs w/6 ft. Bed	2	40
	88-00	Chevrolet K2500 2 Dr. Regular & Extended Cabs w/8 ft. Bed	2	40
	88-00	Chevrolet K3500 2 Dr. Regular & Extended Cabs w/6 ft. Bed	2	40
	88-00	Chevrolet K3500 2 Dr. Regular & Extended Cabs w/8 ft. Bed	2	40
	88-00	GMC C1500 2 Dr. Regular & Extended Cabs w/6 ft. Bed	2	40
	88-00	GMC C2500 2 Dr. Regular & Extended Cabs w/6 ft. Bed	2	40
	88-00	GMC C3500 2 Dr. Regular & Extended Cabs w/6 ft. Bed	2	40
	88-00	GMC C3500 2 Dr. Regular & Extended Cabs w/8 ft. Bed	2	40
	88-00	GMC C5000 2 Dr. Regular & Extended Cabs w/6 ft. Bed	2	40
	88-00	GMC C7000 2 Dr. Regular & Extended Cabs w/6 ft. Bed	2	40
	88-00	GMC K2500 2 Dr. Regular & Extended Cabs w/6 ft. Bed	2	40
	88-00	GMC K2500 2 Dr. Regular & Extended Cabs w/8 ft. Bed	2	40
	88-00	GMC K3500 2 Dr. Regular & Extended Cabs w/6 ft. Bed	2	40
	88-00	GMC K3500 2 Dr. Regular & Extended Cabs w/8 ft. Bed	2	40
	88-99	GMC C1500 2 Dr. Regular & Extended Cabs w/8 ft. Bed	2	40
	88-99	GMC C2500 2 Dr. Regular & Extended Cabs w/8 ft. Bed	2	40
	88-99	GMC K1500 2 Dr. Regular & Extended Cabs w/6 ft. Bed	2	40
	88-99	GMC K1500 2 Dr. Regular & Extended Cabs w/8 ft. Bed	2	40
	92-00	Chevrolet C1500 4 Dr. Crew Cab w/8 ft. Bed	2	40
	92-00	Chevrolet C2500 4 Dr. Crew Cab w/8 ft. Bed	2	40
	92-00	Chevrolet C35 4 Dr. Crew Cab w/8 ft. Bed	2	40
	92-00	Chevrolet C3500 4 Dr. Crew Cab w/8 ft. Bed	2	40
	92-00	Chevrolet C3500HD 4 Dr. Crew Cab w/8 ft. Bed	2	40
	92-00	Chevrolet K3500 4 Dr. Crew Cab w/8 ft. Bed	2	40
	92-00	GMC C2500 4 Dr. Crew Cab w/8 ft. Bed	2	40
	92-00	GMC C3500 4 Dr. Crew Cab w/8 ft. Bed	2	40
	92-00	GMC K2500 4 Dr. Crew Cab w/8 ft. Bed	2	40
	92-00	GMC K3500 4 Dr. Crew Cab w/8 ft. Bed	2	40
	92-99	Chevrolet K1500 4 Dr. Crew Cab w/8 ft. Bed	2	40
	92-99	Chevrolet K2500 4 Dr. Crew Cab w/8 ft. Bed	2	40
	92-99	GMC C1500 4 Dr. Crew Cab w/8 ft. Bed	2	40
	92-99	GMC K1500 4 Dr. Crew Cab w/8 ft. Bed	2	40
	94-01	Dodge Ram 1500	2	40
	94-02	Dodge Ram 2500	2	40
	94-02	Dodge Ram 3500	2	40
	95-01	Dodge Ram 4000	2	40
	97-03	Ford F-150 Flareside	2	25
	97-03	Ford F-150 Styleside	2	25
	97-97	Ford F-250 Heavy Duty	2	35
	97-97	Ford F-350 Heavy Duty	2	35
	97-99	Ford F-250 Styleside	2	25
99-04	Chevrolet Silverado 2500	2	25	
99-04	Ford F-250 Super Duty Except Cab & Chassis	2	30	
99-04	Ford F-350 Super Duty Except Cab & Chassis	2	30	
99-04	GMC Sierra 2500	2	25	
99-06	Chevrolet Silverado 1500	2	25	
99-06	GMC Sierra 1500	2	25	
<b>37096</b>	00-03	Ford F-150 SuperCrew	2	40
	01-06	Chevrolet Silverado 1500 HD	2	35
	01-06	Chevrolet Silverado 2500 HD	2	40
	01-06	GMC Sierra 1500 HD 6.6 ft. Bed	2	35
	01-06	GMC Sierra 2500 HD	2	40
	02-02	Dodge Ram 2500/3500	2	45
	04-04	Ford F-150 Heritage	2	40
	04-05	Ford F-150 SuperCrew, 5.5 ft. Bed	2	50
	07-07	Chevrolet Silverado 1500 (Classic)	2	35
	07-07	Chevrolet Silverado 1500 HD (Classic)	2	35

PART NO.	YEARS	MAKE/MODEL	REC SIZE	IN	
<b>37096</b>	07-07	Chevrolet Silverado 2500 HD (Classic)	2	40	
	07-07	GMC Sierra 1500 (Classic)	2	35	
	07-07	GMC Sierra 1500 HD 6.6 ft. Bed (Classic)	2	35	
	07-07	GMC Sierra 2500 HD (Classic)	2	40	
	87-96	Ford F-150	2	120	
	87-96	Ford F-250	2	120	
	87-96	Ford F-350	2	120	
	88-00	Chevrolet C/K Series 2 Dr. Regular & Extended Cabs w/6 ft. Bed	2	90	
	88-00	Chevrolet C/K Series 2 Dr. Regular & Extended Cabs w/8 ft. Bed	2	90	
	88-00	GMC C/K Series 2 Dr. Regular & Extended Cabs w/6 ft. Bed	2	90	
	88-00	GMC C/K Series 2 Dr. Regular & Extended Cabs w/8 ft. Bed	2	90	
	92-00	Chevrolet C/K Series 4 Dr. Crew Cab w/8 ft. Bed	2	90	
	92-00	GMC C/K Series 4 Dr. Crew Cab w/8 ft. Bed	2	90	
	94-01	Dodge Ram	2	45	
	97-03	Ford F-150 Flareside	2	40	
	97-03	Ford F-150 Styleside	2	40	
	97-97	Ford F-250 Heavy Duty	2	120	
	97-97	Ford F-350 Heavy Duty	2	120	
	97-99	Ford F-250 Styleside	2	40	
	99-04	Ford F-250 Super Duty Except Cab & Chassis	2	40	
	99-04	Ford F-350 Super Duty Except Cab & Chassis	2	40	
	99-06	Chevrolet Silverado 1500	2	35	
	99-06	GMC Sierra 1500	2	35	
	<b>37152</b>	00-06	Chevrolet Suburban 1500 w/Amber Turn Signals	2	30
		00-06	Chevrolet Suburban 2500 w/Amber Turn Signals	2	30
		00-06	Chevrolet Tahoe w/Amber Turn Signals	2	30
		00-06	GMC Yukon w/Amber Turn Signals	2	30
		00-06	GMC Yukon XL 1500	2	30
		00-06	GMC Yukon XL 2500	2	30
		01-02	GMC Yukon Denali w/Amber Turn Signals	2	30
		01-02	GMC Yukon XL 1500 Denali	2	30
		01-03	Chrysler Voyager	2	40
		01-04	Ford Escape	2	60
		01-04	Mazda Tribute	2	60
02-04		Dodge Dakota Except Quad Cab	2	35	
02-07		Jeep Liberty	2	35	
03-03		Ford Windstar (Built After 11/2002)	2	40	
04-07		Chrysler Town & Country Except w/Stow & Go Seats	2	40	
04-07		Dodge Caravan Except w/Stow & Go Seats	2	40	
04-07		Dodge Grand Caravan Except w/Stow & Go Seats	2	40	
82-93		Dodge Ramcharger	2	30	
82-96		Ford Bronco	2	30	
83-90		GMC S15 w/Standard Bed & Step Bumper	2	40	
83-97		Chevrolet S10 w/Standard Bed & Step Bumper	2	30	
83-97		Ford Ranger Except w/Rear Fascia	2	40	
84-00		Plymouth Voyager	2	30	
84-00		Plymouth Voyager	2	40	
84-01		Jeep Cherokee	2	35	
84-01		Jeep Cherokee	2	45	
84-90		Ford Bronco II	2	30	
84-95		Dodge Caravan Short Wheelbase, 2 WD	2	40	
86-87		Nissan D21 (App. starts with 86-1/2)	2	30	
86-97		Ford Aerostar Extended Body	2	40	
87-00		Plymouth Grand Voyager	2	30	
87-00		Plymouth Grand Voyager	2	40	
87-01		Dodge Dakota	2	35	
87-93		Dodge Grand Caravan Long Wheelbase, 2 WD	2	30	
88-94		Nissan D21	2	30	
90-05		Chevrolet Astro Extended Body	2	65	
90-05		GMC Safari Extended Body	2	65	
90-93		Mazda B2200	2	30	
90-93		Mazda B2600	2	30	
90-95		Chrysler Town & Country 2 WD Long Wheelbase	2	40	
91-95		Dodge Caravan C/V Short Wheelbase, 2 WD	2	30	
91-95		Plymouth Grand Voyager Long Wheelbase, 2 WD	2	30	
92-00		GMC Yukon	2	30	
92-94		Chevrolet Blazer Full Size	2	30	
92-99	Chevrolet Suburban C1500	2	30		
92-99	Chevrolet Suburban C2500	2	30		
92-99	Chevrolet Suburban K1500	2	30		
92-99	Chevrolet Suburban K2500	2	30		
92-99	GMC Suburban C1500	2	30		
92-99	GMC Suburban C2500	2	30		
92-99	GMC Suburban K1500	2	30		
92-99	GMC Suburban K2500	2	30		
93-98	Jeep Grand Cherokee	2	35		
94-08	Mazda B3000	2	40		
94-09	Mazda B2300	2	40		
94-09	Mazda B4000	2	40		
94-95	Dodge Grand Caravan Long Wheelbase, 2 WD, Except LE	2	30		



PART NO.	YEARS	MAKE/MODEL	REC SIZE	IN
<b>37152</b>	95-00	Chevrolet Tahoe	2	30
	95-97	Nissan Pickup	2	30
	96-03	Chrysler Town & Country	2	40
	96-03	Dodge Caravan	2	40
	96-03	Dodge Grand Caravan	2	40
	96-14	Chevrolet Express 1500	2	30
	96-14	GMC Savana 1500	2	30
	96-17	GMC Savana 2500	2	30
	96-17	GMC Savana 3500	2	30
	96-19	Chevrolet Express 2500	2	30
	96-19	Chevrolet Express 3500	2	30
	98-00	Isuzu Hombre w/Step Bumper	2	40
	98-01	Mazda B2500	2	40
	98-04	Chevrolet S10	2	30
	98-04	GMC Sonoma	2	40
	98-04	Nissan Frontier	2	35
	98-11	Ford Ranger Except Flareside or w/Rear Fascia	2	40
	99-00	GMC Yukon Denali	2	30
	99-03	Ford Windstar (Built Before 11/2002)	2	40
	<b>CLASS V RECEIVER</b>			
<b>45702</b>	80-86	Ford F-250 Except w/Custom Fascia	2	45
	80-86	Ford F-350 Except w/Custom Fascia	2	45
	87-96	Ford F-250	2	45
	87-96	Ford F-350	2	45
	97-97	Ford F-250 Heavy Duty	2	45
	97-97	Ford F-350 Heavy Duty	2	45
<b>45705</b>	71-80	Dodge D200	2	45
	71-80	Dodge D300	2	45
	71-80	Dodge W200	2	45
	71-80	Dodge W300	2	45
	81-93	Dodge D250	2	45
	81-93	Dodge W250	2	45
	81-93	Dodge W350	2	45
	86-93	Dodge D350	2	45
	94-98	Dodge Ram 2500	2	45
	94-98	Dodge Ram 3500	2	45
<b>45706</b>	88-00	Chevrolet C3500 Regular & Extended Cabs	2	45
	88-00	Chevrolet K3500 Regular & Extended Cabs	2	45
	88-00	GMC C2500	2	45
	88-00	GMC C3500	2	45
	88-00	GMC K2500	2	45
	88-00	GMC K3500	2	45
	88-99	Chevrolet C2500 Regular & Extended Cabs	2	45
	88-99	Chevrolet K2500 Regular & Extended Cabs	2	45
	92-00	Chevrolet C2500 Crew Cab	2	45
	92-00	Chevrolet C3500 Crew Cab	2	45
	92-00	Chevrolet K2500 Crew Cab	2	45
	92-00	Chevrolet K3500 Crew Cab	2	45
<b>45707</b>	96-17	GMC Savana 2500	2	45
	96-17	GMC Savana 3500	2	45
	96-19	Chevrolet Express 2500	2	45
	96-19	Chevrolet Express 3500	2	45
<b>45708</b>	08-15	Ford F-450 Super Duty Except Cab & Chassis	2	50
	99-16	Ford F-250 Super Duty Except Cab & Chassis	2	50
	99-16	Ford F-350 Super Duty Except Cab & Chassis	2	50
<b>45709</b>	03-10	Dodge Ram 2500	2	95
	03-10	Dodge Ram 3500	2	95
	11-18	RAM 2500	2	95
	11-18	RAM 3500	2	95
<b>45710</b>	11-14	Chevrolet Silverado 2500 HD	2	60
	11-14	Chevrolet Silverado 3500 HD	2	60
	11-14	GMC Sierra 2500 HD	2	60
	11-14	GMC Sierra 3500 HD	2	60
<b>45711</b>	15-17	Chevrolet Silverado 3500 HD	2	60
	15-17	GMC Sierra 3500 HD	2	60
	15-19	Chevrolet Silverado 2500 HD	2	60
	15-19	GMC Sierra 2500 HD	2	60
<b>45712†</b>	99-04	Chevrolet Silverado 2500	2	20
	99-04	GMC Sierra 2500	2	20
<b>45713</b>	99-02	Dodge Ram 2500	2	30
	99-02	Dodge Ram 3500	2	30
<b>45714</b>	99-04	Ford F-250 Super Duty w/Deep Drop Bumper	2	20
	99-04	Ford F-350 Super Duty w/Deep Drop Bumper	2	20
<b>45715</b>	00-02	Chevrolet Suburban 2500 w/Amber Turn Signals	2	50
	00-06	GMC Yukon XL 2500	2	50
<b>96901</b>	88-00	Chevrolet C2500 Regular & Extended Cabs	2	30
	88-00	Chevrolet C3500 Regular & Extended Cabs	2	30
	88-00	Chevrolet K2500 Regular & Extended Cabs	2	30
	88-00	Chevrolet K3500 Regular & Extended Cabs	2	30
	88-00	GMC C2500	2	30
	88-00	GMC C3500	2	30
	88-00	GMC K2500	2	30
	88-00	GMC K3500	2	30

PART NO.	YEARS	MAKE/MODEL	REC SIZE	IN	
<b>96901</b>	88-99	Chevrolet C1500	2	30	
	88-99	Chevrolet K1500	2	30	
	88-99	GMC C1500	2	30	
	88-99	GMC K1500	2	30	
	92-00	Chevrolet C2500 Crew Cab	2	30	
	92-00	Chevrolet C3500 Crew Cab	2	30	
	92-00	Chevrolet K2500 Crew Cab	2	30	
	92-00	Chevrolet K3500 Crew Cab	2	30	
	<b>96902</b>	67-80	Dodge W200	2	40
		67-80	Dodge W300	2	40
67-89		Dodge W100	2	40	
68-80		Dodge D200	2	40	
68-89		Dodge D100	2	40	
71-80		Dodge D300	2	40	
77-93		Dodge D150	2	40	
77-93		Dodge W150	2	40	
81-93		Dodge D250	2	40	
81-93		Dodge D350	2	40	
81-93		Dodge W250	2	40	
81-93		Dodge W350	2	40	
<b>96904</b>	80-83	Ford F-100 Except w/Custom Fascia	2	30	
	80-86	Ford F-150 Except w/Custom Fascia	2	30	
	80-86	Ford F-250 Except w/Custom Fascia	2	30	
	80-86	Ford F-350 Except w/Custom Fascia	2	30	
	87-96	Ford F-150	2	30	
	87-96	Ford F-250	2	30	
	87-96	Ford F-350	2	30	
	97-97	Ford F-250 Heavy Duty	2	30	
<b>96906</b>	03-14	Ford E-350 Econoline Super Duty	2	30	
	92-02	Ford E-350 Econoline	2	30	
	92-14	Ford E-150 Econoline	2	30	
	92-14	Ford E-250 Econoline	2	30	
<b>96913</b>	19-19	RAM 1500 (New Body Style)	2	30	
<b>96920</b>	00-03	Ford F-150 SuperCrew	2	30	
	04-04	Ford F-150 Heritage Flareside	2	30	
	04-04	Ford F-150 Heritage Styleside	2	30	
	97-03	Ford F-150 Flareside	2	30	
	97-03	Ford F-150 Styleside	2	30	
<b>96922</b>	99-04	Ford F-250 Super Duty Except Cab & Chassis	2	15	
	99-04	Ford F-350 Super Duty Except Cab & Chassis	2	15	
<b>96923</b>	94-01	Dodge Ram 1500	2	35	
	94-02	Dodge Ram 2500	2	35	
	94-02	Dodge Ram 3500	2	35	
<b>96926</b>	00-02	Ford E-350 Econoline	2	30	
	00-14	Ford E-150 Econoline	2	30	
	00-14	Ford E-250 Econoline	2	30	
	03-14	Ford E-350 Econoline Super Duty	2	30	
<b>96929</b>	03-03	Dodge Ram 1500 (Built After 11/2002)	2	35	
	03-10	Dodge Ram 2500	2	35	
	03-10	Dodge Ram 3500	2	35	
	04-05	Dodge Ram 1500 Except Daytona/Hemi Sport Quad Cab/Ram Rumble Bee/SRT-10	2	35	
	06-08	Dodge Ram 1500	2	35	
	11-18	RAM 2500	2	35	
<b>96930</b>	00-06	Chevrolet Suburban 1500 w/Amber Turn Signals	2	35	
	00-06	Chevrolet Suburban 2500 w/Amber Turn Signals	2	35	
	00-06	GMC Yukon XL 1500	2	35	
	00-06	GMC Yukon XL 2500	2	35	
	01-02	GMC Yukon XL 1500 Denali	2	35	
	<b>96931</b>	99-16	Ford F-250 Super Duty Except Cab & Chassis	2	30
99-16		Ford F-350 Super Duty Except Cab & Chassis	2	30	
<b>96932</b>	01-03	Chevrolet Silverado 1500 HD	2	20	
	01-03	GMC Sierra 1500 HD	2	20	
	03-07	Chevrolet Silverado 1500 (Classic)	2	20	
	03-07	GMC Sierra 1500 (Classic)	2	20	
	05-07	Chevrolet Silverado 1500 HD (Classic)	2	20	
	05-07	GMC Sierra 1500 HD (Classic)	2	20	
	99-02	Chevrolet Silverado 1500	2	20	
<b>96932</b>	99-04	Chevrolet Silverado 2500	2	20	
	99-04	GMC Sierra 2500	2	20	
<b>96933</b>	06-08	Ford F-150	2	20	
	06-08	Lincoln Mark LT (Built After 8/2005)	2	20	
<b>96935</b>	07-19	Toyota Tundra (See Footnote CP)	2	30	
<b>96936</b>	01-07	Chevrolet Silverado 3500 Cab & Chassis, w/34" Wide Frames (Classic)	2	30	
	01-07	GMC Sierra 3500 Cab & Chassis, w/34" Wide Frames (Classic)	2	30	
	07-10	Dodge Ram 3500 Cab & Chassis, w/34" Wide Frames	2	30	

# CLASS V RECEIVER HITCH INDEX

PART NO.	YEARS	MAKE/MODEL	REC SIZE	IN	
96936	07-17	Chevrolet Silverado 3500 HD Cab & Chassis, w/34" Wide Frames	2	30	
	07-20	GMC Sierra 3500 HD Cab & Chassis, w/34" Wide Frames	2	30	
	08-09	Sterling Truck Bullet 45 w/34" Wide Frames	2	30	
	08-09	Sterling Truck Bullet 55 w/34" Wide Frames	2	30	
	08-10	Dodge Ram 4500 Cab & Chassis, w/34" Wide Frames	2	30	
	08-10	Dodge Ram 5500 Cab & Chassis, w/34" Wide Frames	2	30	
	11-12	RAM 3500 Cab & Chassis, w/34" Wide Frames	2	30	
	11-12	RAM 4500 Cab & Chassis, w/34" Wide Frames	2	30	
	11-12	RAM 5500 Cab & Chassis, w/34" Wide Frames	2	30	
	96938	01-07	Chevrolet Silverado 3500 Cab & Chassis, w/34" Wide Frames (Classic)	2	40
		01-07	GMC Sierra 3500 Cab & Chassis, w/34" Wide Frames (Classic)	2	40
07-17		Chevrolet Silverado 3500 HD Cab & Chassis, w/34" Wide Frames	2	40	
07-20		GMC Sierra 3500 HD Cab & Chassis, w/34" Wide Frames	2	40	
63-65		GMC 1000 Series	2	40	
63-65		GMC 1500 Series	2	40	
63-65		GMC 2500 Series	2	40	
63-66		GMC 3000	2	40	
63-66		GMC 3500	2	40	
63-84		Chevrolet C10	2	40	
63-84		Chevrolet C20	2	40	
63-84		Chevrolet C30	2	40	
63-84		Chevrolet K10	2	40	
63-84		Chevrolet K20	2	40	
67-74		GMC C15/C1500	2	40	
67-78		GMC C25	2	40	
67-78		GMC C35	2	40	
67-78		GMC K15	2	40	
67-78		GMC K25	2	40	
68-78		GMC K35	2	40	
73-84		Chevrolet K30	2	40	
75-78		GMC C15	2	40	
79-84		GMC C1500	2	40	
79-84		GMC C2500	2	40	
79-84		GMC C3500	2	40	
79-84		GMC K1500	2	40	
79-84		GMC K2500	2	40	
79-84		GMC K3500	2	40	
85-00		GMC C2500 w/34" Wide Frames	2	40	
85-00		GMC C3500 w/34" Wide Frames	2	40	
85-00		GMC K2500 w/34" Wide Frames	2	40	
85-00		GMC K3500 w/34" Wide Frames	2	40	
85-86		Chevrolet C10 w/34" Wide Frames	2	40	
85-86		Chevrolet C20 w/34" Wide Frames	2	40	
85-86		Chevrolet C30 w/34" Wide Frames	2	40	
85-86		Chevrolet K10 w/34" Wide Frames	2	40	
85-86		Chevrolet K20 w/34" Wide Frames	2	40	
85-86		Chevrolet K30 w/34" Wide Frames	2	40	
85-99		GMC C1500 w/34" Wide Frames	2	40	
85-99		GMC K1500 w/34" Wide Frames	2	40	
88-91		Chevrolet C2500 Crew Cab	2	40	
88-91		Chevrolet C3500 Crew Cab	2	40	
88-91		Chevrolet K2500 Crew Cab	2	40	
88-91		Chevrolet K3500 Crew Cab	2	40	
99-00		Ford F-350 Super Duty Cab & Chassis, w/34" Wide Frames	2	40	
96942		11-14	Chevrolet Silverado 2500 HD	2	20
		11-14	Chevrolet Silverado 3500 HD	2	20
	11-14	GMC Sierra 2500 HD	2	20	
	11-14	GMC Sierra 3500 HD	2	20	
96943	99-17	Ford F-450 Super Duty Cab & Chassis, w/34" Wide Frames	2	40	
	99-17	Ford F-550 Super Duty Cab & Chassis, w/34" Wide Frames	2	40	
	99-19	Ford F-350 Super Duty Cab & Chassis, w/34" Wide Frames	2	40	
96944	01-02	Chevrolet Silverado 3500	2	25	
	01-02	GMC Sierra 3500	2	25	
	01-10	Chevrolet Silverado 2500 HD	2	25	
	01-10	GMC Sierra 2500 HD	2	25	
	03-07	Chevrolet Silverado 2500 HD (Classic)	2	25	
	03-07	Chevrolet Silverado 3500 (Classic)	2	25	
	03-07	GMC Sierra 2500 HD (Classic)	2	25	
	03-07	GMC Sierra 3500 (Classic)	2	25	
	07-10	Chevrolet Silverado 3500 HD	2	25	
	07-10	GMC Sierra 3500 HD	2	25	
96945	00-02	Ford E-350 Econoline	2	30	
	00-14	Ford E-150 Econoline	2	30	

PART NO.	YEARS	MAKE/MODEL	REC SIZE	IN
96945	00-14	Ford E-250 Econoline	2	30
	03-14	Ford E-350 Econoline Super Duty	2	30
96946	96-14	Chevrolet Express 1500	2	35
	96-14	GMC Savana 1500	2	35
	96-17	GMC Savana 2500	2	35
	96-17	GMC Savana 3500	2	35
	96-19	Chevrolet Express 2500	2	35
	96-19	Chevrolet Express 3500	2	35
	96947	01-07	Chevrolet Silverado 3500 Cab & Chassis, w/34" Wide Frames (Classic)	2
01-07		GMC Sierra 3500 Cab & Chassis, w/34" Wide Frames (Classic)	2	35
03-09		Chevrolet Kodiak C4500 Cab & Chassis, w/34" Wide Frames	2	35
03-09		Chevrolet Kodiak C5500 Cab & Chassis, w/34" Wide Frames	2	35
03-09		GMC C4500 Topkick Cab & Chassis, w/34" Wide Frames	2	35
03-09		GMC C5500 Topkick Cab & Chassis, w/34" Wide Frames	2	35
07-10		Dodge Ram 3500 Cab & Chassis, w/34" Wide Frames	2	35
07-17		Chevrolet Silverado 3500 HD Cab & Chassis, w/34" Wide Frames	2	35
07-20		GMC Sierra 3500 HD Cab & Chassis, w/34" Wide Frames	2	35
08-09		Sterling Truck Bullet 45 w/34" Wide Frames	2	35
08-09		Sterling Truck Bullet 55 w/34" Wide Frames	2	35
08-10		Dodge Ram 4500 Cab & Chassis, w/34" Wide Frames	2	35
08-10		Dodge Ram 5500 Cab & Chassis, w/34" Wide Frames	2	35
11-12		RAM 3500 Cab & Chassis, w/34" Wide Frames	2	35
11-12		RAM 4500 Cab & Chassis, w/34" Wide Frames	2	35
11-12		RAM 5500 Cab & Chassis, w/34" Wide Frames	2	35
63-65		GMC 1000 Series	2	35
63-65		GMC 1500 Series	2	35
63-65		GMC 2500 Series	2	35
63-66		GMC 3000	2	35
63-66		GMC 3500	2	35
63-84		Chevrolet C10	2	35
63-84		Chevrolet C20	2	35
63-84		Chevrolet C30	2	35
63-84		Chevrolet K10	2	35
63-84		Chevrolet K20	2	35
67-74		GMC C15/C1500	2	35
67-78		GMC C25	2	35
67-78		GMC C35	2	35
67-78		GMC K15	2	35
67-78		GMC K25	2	35
68-78		GMC K35	2	35
73-84		Chevrolet K30	2	35
75-78	GMC C15	2	35	
79-84	GMC C1500	2	35	
79-84	GMC C2500	2	35	
79-84	GMC C3500	2	35	
79-84	GMC K1500	2	35	
79-84	GMC K2500	2	35	
79-84	GMC K3500	2	35	
85-00	GMC C2500 w/34" Wide Frames	2	35	
85-00	GMC C3500 w/34" Wide Frames	2	35	
85-00	GMC K2500 w/34" Wide Frames	2	35	
85-00	GMC K3500 w/34" Wide Frames	2	35	
85-86	Chevrolet C10 w/34" Wide Frames	2	35	
85-86	Chevrolet C20 w/34" Wide Frames	2	35	
85-86	Chevrolet C30 w/34" Wide Frames	2	35	
85-86	Chevrolet K10 w/34" Wide Frames	2	35	
85-86	Chevrolet K20 w/34" Wide Frames	2	35	
85-86	Chevrolet K30 w/34" Wide Frames	2	35	
85-99	GMC C1500 w/34" Wide Frames	2	35	
85-99	GMC K1500 w/34" Wide Frames	2	35	
88-91	Chevrolet C2500 Crew Cab	2	35	
88-91	Chevrolet C3500 Crew Cab	2	35	
88-91	Chevrolet K2500 Crew Cab	2	35	
88-91	Chevrolet K3500 Crew Cab	2	35	
99-09	Chevrolet Kodiak C6500 Cab & Chassis, w/34" Wide Frames	2	35	
99-09	Chevrolet Kodiak C7500 Cab & Chassis, w/34" Wide Frames	2	35	
99-09	Chevrolet Kodiak C8500 Cab & Chassis, w/34" Wide Frames	2	35	
99-09	GMC C6500 Topkick Cab & Chassis, w/34" Wide Frames	2	35	

PART NO.	YEARS	MAKE/MODEL	REC SIZE	IN
96947	99-09	GMC C7500 Topkick Cab & Chassis, w/34" Wide Frames	2	35
	99-17	Ford F-450 Super Duty Cab & Chassis, w/34" Wide Frames	2	35
	99-17	Ford F-550 Super Duty Cab & Chassis, w/34" Wide Frames	2	35
	99-19	Ford F-350 Super Duty Cab & Chassis, w/34" Wide Frames	2	35
96948	11-18	RAM 1500	2	30
	19-19	RAM 1500 (Classic)	2	30
96950	15-17	Chevrolet Silverado 3500 HD	2	60
	15-17	GMC Sierra 3500 HD	2	60
	15-19	Chevrolet Silverado 2500 HD	2	60
	15-19	GMC Sierra 2500 HD	2	60
96952	13-17	RAM 4500 Cab & Chassis, w/34" Wide Frames	2	45
	13-17	RAM 5500 Cab & Chassis, w/34" Wide Frames	2	45
<b>CLASS V HEAVY DUTY RECEIVER</b>				
45007†	96-17	GMC Savana 2500	2-1/2	45
	96-17	GMC Savana 3500	2-1/2	45
	96-19	Chevrolet Express 2500	2-1/2	45
	96-19	Chevrolet Express 3500	2-1/2	45
45009†	99-04	Chevrolet Silverado 2500	2-1/2	20
	99-04	GMC Sierra 2500	2-1/2	20
45012†	99-04	Ford F-250 Super Duty w/Deep Drop Bumper	2-1/2	20
	99-04	Ford F-350 Super Duty w/Deep Drop Bumper	2-1/2	20
45013†	00-02	Chevrolet Suburban 2500 w/Amber Turn Signals	2-1/2	50
	00-06	GMC Yukon XL 2500	2-1/2	50
45014†	99-00	Ford F-350 Super Duty Cab & Chassis, w/34" Wide Frames	2-1/2	60
	99-17	Ford F-450 Super Duty Cab & Chassis, w/34" Wide Frames	2-1/2	60
	99-17	Ford F-550 Super Duty Cab & Chassis, w/34" Wide Frames	2-1/2	60
45022†	01-02	Chevrolet Silverado 3500	2-1/2	25
	01-02	GMC Sierra 3500	2-1/2	25
	01-10	Chevrolet Silverado 2500 HD	2-1/2	25
	01-10	GMC Sierra 2500 HD	2-1/2	25
	03-07	Chevrolet Silverado 2500 HD (Classic)	2-1/2	25
	03-07	Chevrolet Silverado 3500 (Classic)	2-1/2	25
	03-07	GMC Sierra 2500 HD (Classic)	2-1/2	25
	03-07	GMC Sierra 3500 (Classic)	2-1/2	25
	07-10	Chevrolet Silverado 3500 HD	2-1/2	25
	07-10	GMC Sierra 3500 HD	2-1/2	25
45288†	03-03	Dodge Ram 1500 (Built After 11/2002)	2-1/2	35
	03-05	Dodge Ram 2500	2-1/2	35
	03-05	Dodge Ram 3500	2-1/2	35
	04-05	Dodge Ram 1500 Except Daytona/Hemi Sport Quad Cab/Ram Rumble Bee/SRT-10	2-1/2	35
	06-08	Dodge Ram 1500	2-1/2	35
	06-10	Dodge Ram 2500 Except Mega Cab	2-1/2	35
	06-10	Dodge Ram 3500 Except Mega Cab	2-1/2	35
	11-18	RAM 2500 Except Mega Cab	2-1/2	35
	11-18	RAM 3500 Except Mega Cab	2-1/2	35
	45293†	01-02	Chevrolet Silverado 3500	2-1/2
01-02		GMC Sierra 3500	2-1/2	25
01-10		Chevrolet Silverado 2500 HD 8 ft. Bed	2-1/2	25
01-10		GMC Sierra 2500 HD 8 ft. Bed	2-1/2	25
03-07		Chevrolet Silverado 2500 HD 8 ft. Bed (Classic)	2-1/2	25
03-07		Chevrolet Silverado 3500 (Classic)	2-1/2	25
03-07		GMC Sierra 3500 (Classic)	2-1/2	25
07-07		GMC Sierra 2500 HD 8 ft. Bed (Classic)	2-1/2	25
07-10		Chevrolet Silverado 3500 HD	2-1/2	25
07-10		GMC Sierra 3500 HD	2-1/2	25
45299†	03-10	Dodge Ram 2500	2-1/2	95
	03-10	Dodge Ram 3500	2-1/2	95
	11-18	RAM 2500	2-1/2	95
	11-18	RAM 3500	2-1/2	95
45300†	11-14	Chevrolet Silverado 2500 HD	2-1/2	60
	11-14	Chevrolet Silverado 3500 HD	2-1/2	60
	11-14	GMC Sierra 2500 HD	2-1/2	60
	11-14	GMC Sierra 3500 HD	2-1/2	60
45716†	99-00	Ford F-350 Super Duty Cab & Chassis, w/34" Wide Frames	2-1/2	60
	99-17	Ford F-450 Super Duty Cab & Chassis, w/34" Wide Frames	2-1/2	60
	99-17	Ford F-550 Super Duty Cab & Chassis, w/34" Wide Frames	2-1/2	60
45717	01-02	Chevrolet Silverado 3500	2-1/2	25
	01-02	GMC Sierra 3500	2-1/2	25
	01-10	Chevrolet Silverado 2500 HD	2-1/2	25
	01-10	GMC Sierra 2500 HD	2-1/2	25
	03-07	Chevrolet Silverado 2500 HD (Classic)	2-1/2	25
	03-07	Chevrolet Silverado 3500 (Classic)	2-1/2	25

PART NO.	YEARS	MAKE/MODEL	REC SIZE	IN
45717	03-07	GMC Sierra 2500 HD (Classic)	2-1/2	25
	03-07	GMC Sierra 3500 (Classic)	2-1/2	25
	07-10	Chevrolet Silverado 3500 HD	2-1/2	25
	07-10	GMC Sierra 3500 HD	2-1/2	25
45718	03-03	Dodge Ram 1500 (Built After 11/2002)	2-1/2	35
	03-05	Dodge Ram 2500	2-1/2	35
	03-05	Dodge Ram 3500	2-1/2	35
	04-05	Dodge Ram 1500 Except Daytona/Hemi Sport Quad Cab/Ram Rumble Bee/SRT-10	2-1/2	35
	06-08	Dodge Ram 1500	2-1/2	35
	06-10	Dodge Ram 2500 Except Mega Cab	2-1/2	35
	06-10	Dodge Ram 3500 Except Mega Cab	2-1/2	35
	11-18	RAM 2500 Except Mega Cab	2-1/2	35
	11-18	RAM 3500 Except Mega Cab	2-1/2	35
	45719	01-02	Chevrolet Silverado 3500	2-1/2
01-02		GMC Sierra 3500	2-1/2	25
01-10		Chevrolet Silverado 2500 HD 8 ft. Bed	2-1/2	25
01-10		GMC Sierra 2500 HD 8 ft. Bed	2-1/2	25
03-07		Chevrolet Silverado 2500 HD 8 ft. Bed (Classic)	2-1/2	25
03-07		Chevrolet Silverado 3500 (Classic)	2-1/2	25
03-07		GMC Sierra 3500 (Classic)	2-1/2	25
07-07		GMC Sierra 2500 HD 8 ft. Bed (Classic)	2-1/2	25
07-10		Chevrolet Silverado 3500 HD	2-1/2	25
07-10		GMC Sierra 3500 HD	2-1/2	25
<b>FRONT MOUNT RECEIVER</b>				
65001	91-07	Ford E-150 Econoline	2	20
	91-07	Ford E-250 Econoline		
	91-07	Ford E-350 Econoline Inc. RV Cutaway		
	00-02	Ford E-450 Econoline Super Duty Stripped RV Cutaway		
65003	94-01	Dodge Ram 1500	2	30
	94-02	Dodge Ram 2500		
94-02	Dodge Ram 3500			
65004	95-05	Chevrolet Blazer Downsize	2	30
	94-04	Chevrolet S10		
	99-01	Chevrolet Blazer Trailblazer		
	95-05	GMC Jimmy Downsize		
	94-04	GMC Sonoma		
	96-00	Isuzu Hombre		
65005	88-00	Chevrolet C3500 2 Dr. Regular & Extended Cabs	2	40
	88-00	Chevrolet K3500 2 Dr. Regular & Extended Cabs	2	40
	88-00	GMC C2500 2 Dr. Regular & Extended Cabs	2	40
	88-00	GMC C3500 2 Dr. Regular & Extended Cabs	2	40
	88-99	Chevrolet C1500 2 Dr. Regular & Extended Cabs	2	40
	88-99	Chevrolet C2500 2 Dr. Regular & Extended Cabs	2	40
	88-99	Chevrolet K1500 2 Dr. Regular & Extended Cabs	2	40
	88-99	Chevrolet K2500 2 Dr. Regular & Extended Cabs	2	40
	88-99	GMC C1500 2 Dr. Regular & Extended Cabs	2	40
	88-99	GMC K1500 2 Dr. Regular & Extended Cabs	2	40
	92-00	Chevrolet K2500 4 Dr. Crew Cab	2	40
	92-00	Chevrolet K3500 4 Dr. Crew Cab	2	40
	92-00	GMC K2500 4 Dr. Crew Cab	2	40
	92-00	GMC K3500 4 Dr. Crew Cab	2	40
	92-00	GMC Yukon	2	40
	92-94	Chevrolet Blazer Full Size	2	40
92-99	Chevrolet Suburban C1500	2	40	
92-99	Chevrolet Suburban C2500	2	40	
92-99	Chevrolet Suburban K1500	2	40	
92-99	Chevrolet Suburban K2500	2	40	
92-99	GMC K1500 4 Dr. Crew Cab	2	40	
92-99	GMC Suburban C1500	2	40	
92-99	GMC Suburban C2500	2	40	
92-99	GMC Suburban K1500	2	40	
92-99	GMC Suburban K2500	2	40	
95-00	Chevrolet Tahoe	2	40	
65008	93-93	Jeep Grand Wagoneer	2	25
	93-98	Jeep Grand Cherokee	2	25
65009	84-01	Jeep Cherokee Downsize	2	30
	84-90	Jeep Wagoneer	2	30
	86-92	Jeep Comanche	2	30
65014	92-97	Ford F-250 Styleside	2	25
	92-97	Ford F-350 Styleside	2	25
65015	92-97	Ford F-250	2	25
	92-97	Ford F-350	2	25
65016	96-03	Chevrolet Express 1500 Inc. RV Cutaway	2	35
	96-03	Chevrolet Express 2500 Inc. RV Cutaway	2	35
	96-03	Chevrolet Express 3500 Inc. RV Cutaway	2	35
	96-03	GMC Savana 1500 Inc. RV Cutaway	2	35
	96-03	GMC Savana 2500 Inc. RV Cutaway	2	35

# FRONT MOUNT RECEIVER HITCH INDEX

PART NO.	YEARS	MAKE/MODEL	REC SIZE	IN	
65017	89-97	Ford Ranger	2	35	
	91-94	Ford Explorer	2	35	
	91-94	Mazda Navajo	2	35	
	94-97	Mazda B2300	2	35	
	94-97	Mazda B3000	2	35	
	94-97	Mazda B4000	2	35	
65021†	88-00	Chevrolet C3500 2 Dr. Regular & Extended Cabs	2	30	
	88-00	GMC C2500 2 Dr. Regular & Extended Cabs	2	30	
	88-00	GMC C3500 2 Dr. Regular & Extended Cabs	2	30	
	88-99	Chevrolet C1500 2 Dr. Regular & Extended Cabs	2	30	
	88-99	Chevrolet C2500 2 Dr. Regular & Extended Cabs	2	30	
	88-99	GMC C1500 2 Dr. Regular & Extended Cabs	2	30	
	92-00	Chevrolet C2500 4 Dr. Crew Cab	2	30	
	92-00	Chevrolet C3500 4 Dr. Crew Cab	2	30	
	92-00	GMC C2500 4 Dr. Crew Cab	2	30	
	92-00	GMC C3500 4 Dr. Crew Cab	2	30	
	92-99	Chevrolet C1500 4 Dr. Crew Cab	2	30	
	92-99	Chevrolet Suburban C1500	2	30	
	92-99	Chevrolet Suburban C2500	2	30	
	92-99	Chevrolet Suburban K1500	2	30	
	92-99	Chevrolet Suburban K2500	2	30	
	92-99	GMC C1500 4 Dr. Crew Cab	2	30	
	92-99	GMC Suburban C1500	2	30	
	92-99	GMC Suburban C2500	2	30	
	92-99	GMC Suburban K1500	2	30	
	92-99	GMC Suburban K2500	2	30	
	65022	00-05	Ford Excursion	2	40
99-07		Ford F-250 Super Duty	2	40	
99-07		Ford F-350 Super Duty	2	40	
99-07		Ford F-350 Super Duty Cab & Chassis, w/34" Wide Frames	2	40	
99-07		Ford F-450 Super Duty Cab & Chassis, w/34" Wide Frames	2	40	
65023	00-06	Chevrolet Suburban 1500	2	20	
	00-06	Chevrolet Tahoe 1500 Series	2	20	
	00-06	GMC Yukon 1500	2	20	
	00-06	GMC Yukon XL 1500	2	20	
	01-06	GMC Yukon Denali 1500	2	30	
	01-06	GMC Yukon XL 1500 Denali	2	30	
	99-07	Chevrolet Silverado 1500	2	20	
	99-07	GMC Sierra 1500 Except Denali (Classic)	2	20	
	65024	01-01	Mazda B2500	2	35
		01-05	Ford Ranger	2	35
01-05		Mazda B3000	2	35	
01-05		Mazda B4000	2	35	
02-05		Mazda B2300	2	35	
65025		04-04	Ford F-150 Heritage	2	20
	97-02	Ford Expedition	2	20	
	97-03	Ford F-150	2	20	
	97-99	Ford F-250 Styleside	2	20	
	98-02	Lincoln Navigator	2	20	
	65028	00-06	Chevrolet Suburban 2500	2	20
00-06		GMC Yukon XL 2500	2	20	
01-07		Chevrolet Silverado 1500 HD	2	20	
01-07		Chevrolet Silverado 2500 HD	2	20	
01-07		Chevrolet Silverado 3500	2	20	
01-07		GMC Sierra 1500 HD	2	20	
01-07		GMC Sierra 2500 HD	2	20	
01-07		GMC Sierra 3500	2	20	
99-04		Chevrolet Silverado 2500	2	20	
99-04		GMC Sierra 2500	2	20	
65029†		00-03	Dodge Durango 4 WD	2	25
		00-04	Dodge Dakota 4 WD	2	25
65030†	01-03	Ford Explorer 2 Dr. Sport	2	25	
	01-05	Ford Explorer Sport Trac	2	25	
65031	00-06	Toyota Tundra	2	40	
	01-07	Toyota Sequoia	2	40	
65032†	02-05	Ford Explorer 4 Dr.	2	30	
	02-05	Mercury Mountaineer	2	30	
65033	02-05	Dodge Ram 1500	2	25	
65041	01-04	Toyota Tacoma	2	30	
65043	04-08	Ford F-150	2	20	
	06-08	Lincoln Mark LT	2	20	
65046	03-09	Dodge Ram 2500	2	40	
	03-09	Dodge Ram 3500	2	40	
65048	87-06	Jeep Wrangler	2	25	
	87-95	Jeep YJ (Canada Only)	2	25	
	97-06	Jeep TJ (Canada Only)	2	25	

PART NO.	YEARS	MAKE/MODEL	REC SIZE	IN
65049	08-16	Ford F-250 Super Duty	2	20
	08-16	Ford F-350 Super Duty	2	20
	08-16	Ford F-350 Super Duty Cab & Chassis	2	20
	08-16	Ford F-450 Super Duty	2	20
	08-16	Ford F-450 Super Duty Cab & Chassis	2	20
	08-16	Ford F-550 Super Duty Cab & Chassis	2	20
65050	07-10	Chevrolet Silverado 2500 HD	2	40
	07-10	Chevrolet Silverado 3500 HD	2	40
	07-10	GMC Sierra 2500 HD	2	40
	07-10	GMC Sierra 3500 HD	2	40
65051†	07-17	Toyota Tundra	2	25
65052	07-13	Chevrolet Avalanche Except Z71	2	25
	07-13	Chevrolet Silverado 1500	2	25
	07-13	GMC Sierra 1500	2	25
	07-14	Chevrolet Suburban 1500 Except Z71	2	25
	07-14	Chevrolet Tahoe Except Z71	2	25
	07-14	GMC Yukon	2	25
65053	08-14	Ford E-150 Econoline	2	40
	08-14	Ford E-250 Econoline	2	40
	08-14	Ford E-350 Econoline Super Duty	2	50
	08-17	Ford E-350 Econoline Super Duty RV Cutaway	2	50
65057	10-10	Dodge Ram 2500 4 WD	2	40
	11-12	RAM 2500 4 WD	2	40
65060	10-10	Dodge Ram 3500	2	30
	11-12	RAM 3500	2	30
65061	09-14	Ford F-150	2	30
	10-13	Lincoln Mark LT (Mexico Only)	2	30
65062	09-10	Dodge Ram 1500	2	35
	11-18	RAM 1500	2	35
	19-19	RAM 1500 (Classic)	2	35
65063	10-10	Dodge Ram 2500	2	30
	10-10	Dodge Ram 3500	2	30
	10-10	Dodge Ram 4500 Cab & Chassis	2	30
	10-10	Dodge Ram 5500 Cab & Chassis	2	30
	11-18	RAM 2500	2	30
	11-18	RAM 3500	2	30
	11-18	RAM 4500 Cab & Chassis	2	30
	11-18	RAM 5500 Cab & Chassis	2	30
65064	14-19	Chevrolet Silverado 1500 LD (Old Body Style)	2	25
	14-19	GMC Sierra 1500 LD (Old Body Style)	2	25
	15-19	Chevrolet Suburban	2	25
	15-19	Chevrolet Tahoe	2	25
	15-19	GMC Yukon	2	25
65065	09-15	Nissan Titan 4 WD Only	2	45
	15-19	Ford F-150	2	30
65067	15-19	Ford F-150	2	30
65069	07-17	Jeep Wrangler	2	40
	18-18	Jeep Wrangler JK	2	40
65070	05-19	Toyota Tacoma	2	35
65071	15-16	Chevrolet Colorado	2	30
	15-16	GMC Canyon	2	30
65072	16-16	Nissan Titan XD	2	25
65073	17-17	Honda Ridgeline	2	35
65074	14-19	Toyota 4Runner Except Limited	2	20
65075	05-12	Nissan Pathfinder	2	35
	05-19	Nissan Frontier	2	35
	09-12	Suzuki Equator Sport & RMZ-4 Models	2	35
65076	17-19	Ford F-250 Super Duty	2	30
	17-19	Ford F-350 Super Duty	2	30
	17-19	Ford F-450 Super Duty	2	30
65077	17-17	Nissan Titan Except Titan XD & 4 WD Models	2	60
65078	11-17	Chevrolet Silverado 3500 HD	2	45
	11-17	Chevrolet Silverado 3500 HD	2	35
	11-17	GMC Sierra 3500 HD Except Denali	2	35
	11-17	GMC Sierra 3500 HD Except Denali	2	45
	11-19	Chevrolet Silverado 2500 HD	2	35
65078	11-19	Chevrolet Silverado 2500 HD	2	45
	11-19	GMC Sierra 2500 HD Except Denali	2	35
	11-19	GMC Sierra 2500 HD Except Denali	2	45
65079	18-19	Jeep Wrangler JL (New Body Style)	2	35
	20-20	Jeep Gladiator	2	35
65080	07-19	Toyota Sequoia	2	20
	07-19	Toyota Tundra	2	20
65081	19-19	RAM 1500 (New Body Style), Except with Factory Tow Hooks	2	50
65082	19-19	Chevrolet Silverado 1500	2	25



PART NO.	YEARS	MAKE/MODEL	REC SIZE	IN	
<b>65083</b>	2020	Chevrolet, Silverado 2500 HD, All Styles	2	30	
	2020	Chevrolet, Silverado 3500 HD, All Styles	2	30	
	2020	GMC, Sierra 2500 HD, All Styles	2	30	
	2020	GMC, Sierra 3500 HD, All Styles	2	30	
<b>BRAKE CONTROL HARNESS: 1-PLUG</b>					
<b>74437</b>	94-96	Ford Bronco		5	
	92-08	Ford E-150 Econoline		5	
	92-08	Ford E-250 Econoline		5	
	92-08	Ford E-350 Econoline		5	
	92-08	Ford E-350 Econoline RV Cutaway, w/Factory Tow Prep Plug		5	
	03-08	Ford E-450 Econoline Super Duty RV Cutaway, w/Factory Tow Prep Plug		5	
	00-02	Ford E-450 Econoline Super Duty Stripped RV Cutaway, w/Factory Tow Prep Plug		5	
	00-05	Ford Excursion		5	
	97-12	Ford Expedition		5	
	07-10	Ford Explorer Sport Trac w/Factory Tow Package		5	
	02-19	Ford Explorer w/Factory Tow Package		5	
	94-08	Ford F-150		5	
	04-04	Ford F-150 Heritage		5	
	94-96	Ford F-250		5	
	97-97	Ford F-250 Heavy Duty		5	
	97-99	Ford F-250 Styleside		5	
	99-04	Ford F-250 Super Duty		5	
	94-96	Ford F-350		5	
	97-97	Ford F-350 Heavy Duty		5	
	99-04	Ford F-350 Super Duty		5	
	99-04	Ford F-450 Super Duty Cab & Chassis		5	
	99-04	Ford F-550 Super Duty Cab & Chassis		5	
	09-11	Ford Flex w/Factory Tow Package		5	
	95-03	Ford Windstar w/Factory Tow Package		5	
	05-09	Land Rover LR3		5	
	10-15	Land Rover LR4		5	
	05-15	Land Rover Range Rover		5	
	12-17	Land Rover Range Rover Evoque		5	
	03-05	Lincoln Aviator w/Factory Tow Package		5	
	06-08	Lincoln Mark LT		5	
	10-11	Lincoln MKT w/Factory Tow Package		5	
	98-12	Lincoln Navigator		5	
	02-10	Mercury Mountaineer w/Factory Tow Package		5	
	<b>74438</b>	02-02	Cadillac Escalade		5
		02-02	Cadillac Escalade EXT		5
		02-02	Chevrolet Avalanche 1500		5
		02-02	Chevrolet Avalanche 2500		5
		99-02	Chevrolet Silverado 1500		5
		01-02	Chevrolet Silverado 1500 HD		5
		99-02	Chevrolet Silverado 2500		5
		01-02	Chevrolet Silverado 2500 HD		5
		01-02	Chevrolet Silverado 3500		5
		00-02	Chevrolet Suburban 1500 w/Amber Turn Signals		5
		00-02	Chevrolet Suburban 2500 w/Amber Turn Signals		5
		00-02	Chevrolet Tahoe w/Amber Turn Signals		5
		00-02	Chevrolet Tahoe w/Amber Turn Signals		5
		99-02	GMC Sierra 1500		5
01-02		GMC Sierra 1500 HD		5	
99-02		GMC Sierra 2500		5	
01-02		GMC Sierra 2500 HD		5	
01-02		GMC Sierra 3500		5	
01-02		GMC Yukon Denali w/Amber Turn Signals		5	
00-02		GMC Yukon w/Amber Turn Signals		5	
00-02		GMC Yukon XL 1500		5	
01-02		GMC Yukon XL 1500 Denali		5	
00-02		GMC Yukon XL 2500		5	
<b>74439</b>		07-09	Chrysler Aspen w/Factory Tow Package		5
		97-10	Dodge Dakota w/Factory Tow Package Dodge		5
		98-09	Durango w/Factory Tow Package		5
		95-09	Dodge Ram 1500		5
	95-09	Dodge Ram 2500		5	
	95-09	Dodge Ram 3500		5	
	11-11	RAM Dakota w/Factory Tow Package		5	
	<b>85340</b>	03-06	Cadillac Escalade		5
03-06		Cadillac Escalade ESV		5	
03-06		Cadillac Escalade EXT		5	
03-06		Chevrolet Avalanche 1500		5	
03-06		Chevrolet Avalanche 2500		5	
03-06		Chevrolet Silverado 1500		5	
03-06		Chevrolet Silverado 1500		5	
07-07		Chevrolet Silverado 1500 (Classic)		5	
03-06		Chevrolet Silverado 1500 HD		5	
07-07		Chevrolet Silverado 1500 HD (Classic)		5	
03-04		Chevrolet Silverado 2500		5	
03-06		Chevrolet Silverado 2500 HD		5	
07-07		GMC Sierra 2500 HD (Classic)		5	
07-07		GMC Sierra 3500		5	
03-06		GMC Sierra 3500 (Classic)		5	
03-06		GMC Yukon		5	
03-06		GMC Yukon Denali		5	
03-06		GMC Yukon XL 1500		5	
03-06		GMC Yukon XL 1500 Denali		5	
07-07		GMC Yukon XL 2500		5	
03-06	Chevrolet Silverado 3500		5		

PART NO.	YEARS	MAKE/MODEL	REC SIZE	IN	
<b>85340</b>	07-07	Chevrolet Silverado 3500 (Classic)		5	
	03-06	Chevrolet Suburban 1500		5	
	03-06	Chevrolet Suburban 2500		5	
	03-06	Chevrolet Tahoe		5	
	03-06	GMC Sierra 1500		5	
	07-07	GMC Sierra 1500 (Classic)		5	
	03-06	GMC Sierra 1500 HD		5	
	07-07	GMC Sierra 1500 HD (Classic)		5	
	03-04	GMC Sierra 2500		5	
	03-06	GMC Sierra 2500 HD		5	
	07-07	GMC Sierra 2500 HD (Classic)		5	
	03-06	GMC Sierra 3500		5	
	07-07	GMC Sierra 3500 (Classic)		5	
	03-06	GMC Yukon		5	
	03-06	GMC Yukon Denali		5	
	03-06	GMC Yukon XL 1500		5	
	03-06	GMC Yukon XL 1500 Denali		5	
	03-06	GMC Yukon XL 2500		5	
	03-07	Hummer H2		5	
	<b>BRAKE CONTROL HARNESS: 2-PLUG</b>				
	<b>78050</b>	03-06	Cadillac Escalade		5
		03-06	Cadillac Escalade ESV		5
		03-06	Cadillac Escalade EXT		5
		03-06	Chevrolet Avalanche 1500		5
		03-06	Chevrolet Avalanche 2500		5
		03-06	Chevrolet Silverado 1500		5
07-07		Chevrolet Silverado 1500 (Classic)		5	
03-06		Chevrolet Silverado 1500 HD		5	
07-07		Chevrolet Silverado 1500 HD (Classic)		5	
03-04		Chevrolet Silverado 2500		5	
03-06		Chevrolet Silverado 2500 HD		5	
07-07		Chevrolet Silverado 2500 HD (Classic)		5	
03-06		Chevrolet Silverado 3500		5	
07-07		Chevrolet Silverado 3500 (Classic)		5	
03-06		Chevrolet Suburban 1500		5	
03-06		Chevrolet Suburban 2500		5	
03-06		Chevrolet Tahoe		5	
03-06		GMC Sierra 1500		5	
07-07		GMC Sierra 1500 (Classic)		5	
03-06		GMC Sierra 1500 HD		5	
07-07		GMC Sierra 1500 HD (Classic)		5	
03-06		GMC Sierra 2500		5	
03-06		GMC Sierra 2500 HD		5	
07-07		GMC Sierra 2500 HD (Classic)		5	
03-06		GMC Sierra 3500		5	
07-07		GMC Sierra 3500 (Classic)		5	
03-06		GMC Yukon		5	
03-06		GMC Yukon Denali		5	
03-06		GMC Yukon XL 1500		5	
03-06		GMC Yukon XL 1500 Denali		5	
03-06	GMC Yukon XL 2500		5		
03-07	Hummer H2		5		
<b>7805011</b>	03-06	Cadillac Escalade		5	
	03-06	Cadillac Escalade ESV		5	
	03-06	Cadillac Escalade EXT		5	
	03-06	Chevrolet Avalanche 1500		5	
	03-06	Chevrolet Avalanche 2500		5	
	03-06	Chevrolet Silverado 1500		5	
	07-07	Chevrolet Silverado 1500 (Classic)		5	
	03-06	Chevrolet Silverado 1500 HD		5	
	07-07	Chevrolet Silverado 1500 HD (Classic)		5	
	03-04	Chevrolet Silverado 2500		5	
	03-06	Chevrolet Silverado 2500 HD		5	
	07-07	Chevrolet Silverado 2500 HD (Classic)		5	
	03-06	Chevrolet Silverado 3500		5	
	07-07	Chevrolet Silverado 3500 (Classic)		5	
	03-06	Chevrolet Suburban 1500		5	
	03-06	Chevrolet Suburban 2500		5	
	03-06	Chevrolet Tahoe		5	
	03-06	GMC Sierra 1500		5	
	07-07	GMC Sierra 1500 (Classic)		5	
	03-06	GMC Sierra 1500 HD		5	
07-07	GMC Sierra 1500 HD (Classic)		5		
03-04	GMC Sierra 2500		5		
03-06	GMC Sierra 2500 HD		5		
07-07	GMC Sierra 2500 HD (Classic)		5		
07-07	GMC Sierra 3500		5		
03-06	GMC Sierra 3500 (Classic)		5		
03-06	GMC Yukon		5		
03-06	GMC Yukon Denali		5		
03-06	GMC Yukon XL 1500		5		
03-06	GMC Yukon XL 1500 Denali		5		
03-07	GMC Yukon XL 2500		5		
		Hummer H2		5	



# INDEX

## BRAKE CONTROL HARNESS INDEX

PART NO.	YEARS	MAKE/MODEL	REC SIZE	IN
<b>78051</b>	07-09	Chrysler Aspen w/Factory Tow Package		5
	97-10	Dodge Dakota w/Factory Tow Package		5
	98-09	Dodge Durango w/Factory Tow Package		5
	95-09	Dodge Ram 1500		5
	95-09	Dodge Ram 2500		5
	95-09	Dodge Ram 3500		5
	11-11	RAM Dakota w/Factory Tow Package		5
<b>7805111</b>	07-09	Chrysler Aspen w/Factory Tow Package		5
	97-10	Dodge Dakota w/Factory Tow Package		5
	98-09	Dodge Durango w/Factory Tow Package		5
	95-09	Dodge Ram 1500		5
	95-09	Dodge Ram 2500		5
	95-09	Dodge Ram 3500		5
	11-11	RAM Dakota w/Factory Tow Package		5
<b>78052</b>	02-02	Cadillac Escalade		5
	02-02	Cadillac Escalade EXT		5
	02-02	Chevrolet Avalanche 1500		5
	02-02	Chevrolet Avalanche 2500		5
	99-02	Chevrolet Silverado 1500		5
	01-02	Chevrolet Silverado 1500 HD		5
	99-02	Chevrolet Silverado 2500		5
	01-02	Chevrolet Silverado 2500 HD		5
	01-02	Chevrolet Silverado 3500		5
	00-02	Chevrolet Suburban 1500 w/Amber Turn Signals		5
	00-02	Chevrolet Suburban 2500 w/Amber Turn Signals		5
	00-02	Chevrolet Tahoe w/Amber Turn Signals		5
	99-02	GMC Sierra 1500		5
	01-02	GMC Sierra 1500 HD		5
	<b>78053</b>	07-09	Saturn Outlook w/Factory 7-Way	
07-17		GMC Acadia w/Factory 7-Way		5
08-17		Buick Enclave w/Factory 7-Way		5
09-17		Chevrolet Traverse w/Factory 7-Way		5
17-17		GMC Acadia Limited w/Factory 7-Way		5
<b>78054</b>		00-02	Ford E-450 Econoline Super Duty Stripped RV Cutaway, w/Factory Tow Prep Plug	
	00-05	Ford Excursion		5
	02-10	Mercury Mountaineer w/Factory Tow Package		5
	02-19	Ford Explorer w/Factory Tow Package		5
	03-05	Lincoln Aviator w/Factory Tow Package		5
	03-08	Ford E-450 Econoline Super Duty RV Cutaway, w/Factory Tow Prep Plug		5
	04-04	Ford F-150 Heritage		5
	05-09	Land Rover LR3		5
	05-15	Land Rover Range Rover		5
	06-08	Lincoln Mark LT		5
	07-10	Ford Explorer Sport Trac w/Factory Tow Package		5
	09-11	Ford Flex w/Factory Tow Package		5
	10-11	Lincoln MKT w/Factory Tow Package		5
	10-15	Land Rover LR4		5
	12-17	Land Rover Range Rover Evoque		5
	92-08	Ford E-150 Econoline		5
	92-08	Ford E-250 Econoline		5
	92-08	Ford E-350 Econoline		5
	92-08	Ford E-350 Econoline RV Cutaway, w/Factory Tow Prep Plug		5
	94-08	Ford F-150		5
	94-96	Ford Bronco		5
	94-96	Ford F-250		5
	94-96	Ford F-350		5
	95-03	Ford Windstar w/Factory Tow Package		5
	97-12	Ford Expedition		5
	97-97	Ford F-250 Heavy Duty		5
	97-97	Ford F-350 Heavy Duty		5
	97-99	Ford F-250 Styleside		5
	98-12	Lincoln Navigator		5
	99-04	Ford F-250 Super Duty		5
	99-04	Ford F-350 Super Duty		5
	99-04	Ford F-450 Super Duty Cab & Chassis		5
99-04	Ford F-550 Super Duty Cab & Chassis		5	
<b>7805411</b>	00-02	Ford E-450 Econoline Super Duty Stripped RV Cutaway, w/Factory Tow Prep Plug		5
	00-05	Ford Excursion		5
	02-10	Mercury Mountaineer w/Factory Tow Package		5
	02-19	Ford Explorer w/Factory Tow Package		5
	03-05	Lincoln Aviator w/Factory Tow Package		5
	03-08	Ford E-450 Econoline Super Duty RV Cutaway, w/Factory Tow Prep Plug		5
	04-04	Ford F-150 Heritage		5
	05-09	Land Rover LR3		5
	05-15	Land Rover Range Rover		5
	06-08	Lincoln Mark LT		5
	07-10	Ford Explorer Sport Trac w/Factory Tow Package		5
	09-11	Ford Flex w/Factory Tow Package		5
	10-11	Lincoln MKT w/Factory Tow Package		5
	10-15	Land Rover LR4		5

PART NO.	YEARS	MAKE/MODEL	REC SIZE	IN
<b>7805411</b>	12-17	Land Rover Range Rover Evoque		5
	92-08	Ford E-150 Econoline		5
	92-08	Ford E-250 Econoline		5
	92-08	Ford E-350 Econoline		5
	92-08	Ford E-350 Econoline RV Cutaway, w/Factory Tow Prep Plug		5
	94-08	Ford F-150		5
	94-96	Ford Bronco		5
	94-96	Ford F-250		5
	94-96	Ford F-350		5
	95-03	Ford Windstar w/Factory Tow Package		5
	97-12	Ford Expedition		5
	97-97	Ford F-250 Heavy Duty		5
	97-97	Ford F-350 Heavy Duty		5
	97-99	Ford F-250 Styleside		5
	98-12	Lincoln Navigator		5
	99-04	Ford F-250 Super Duty		5
	99-04	Ford F-350 Super Duty		5
99-04	Ford F-450 Super Duty Cab & Chassis		5	
99-04	Ford F-550 Super Duty Cab & Chassis		5	
<b>78055</b>	03-07	Lexus LX470		5
	03-09	Lexus GX470		5
	03-13	Toyota 4Runner		5
	03-14	Toyota Tundra		5
	03-15	Toyota Land Cruiser		5
	03-19	Toyota Sequoia		5
	07-15	Toyota Tacoma		5
	08-15	Lexus LX570		5
	10-15	Lexus GX460		5
	<b>78056</b>	04-04	Nissan Pathfinder Armada	
04-13		Infiniti QX56		5
04-17		Nissan Titan Except Titan XD		5
05-15		Nissan Armada		5
05-15		Nissan Frontier		5
05-15		Nissan Xterra w/Factory Tow Package		5
05-17		Nissan Pathfinder		5
13-15		Nissan NV1500		5
13-15		Nissan NV2500		5
13-15		Nissan NV3500		5
<b>78057</b>	06-17	Honda Ridgeline w/Factory Tow Package		5
	09-17	Honda Pilot w/Factory Tow Package		5
<b>78059</b>	08-16	Ford F-250 Super Duty		20
	08-16	Ford F-350 Super Duty		20
	08-16	Ford F-350 Super Duty Cab & Chassis		20
	08-16	Ford F-450 Super Duty		20
	08-16	Ford F-450 Super Duty Cab & Chassis		20
	08-16	Ford F-550 Super Duty Cab & Chassis		20
	08-16	Ford E-350 Econoline Super Duty RV Cutaway, w/Factory Tow Prep Plug		20
	09-11	Ford E-450 Econoline Super Duty RV Cutaway, w/Factory Tow Prep Plug		20
	09-14	Ford E-150 Econoline		20
	09-14	Ford E-250 Econoline		20
09-14	Ford E-350 Econoline Super Duty		20	
13-14	Ford Expedition		20	
13-14	Lincoln Navigator		20	
<b>78060</b>	05-07	Ford F-250 Super Duty		5
	05-07	Ford F-350 Super Duty		5
	05-07	Ford F-350 Super Duty Cab & Chassis		5
	05-07	Ford F-450 Super Duty Cab & Chassis		5
	05-07	Ford F-550 Super Duty Cab & Chassis		5
<b>78124</b>	09-19	Ford F-150		20
	12-15	Lincoln MKT w/Factory Tow Package		20
	12-16	Ford Flex w/Factory Tow Package		20
	15-17	Ford Expedition		20
	15-17	Lincoln Navigator		20
	17-18	Ford F-550 Super Duty		20
	17-19	Ford F-250 Super Duty		20
	17-19	Ford F-350 Super Duty		20
	17-19	Ford F-450 Super Duty		20
	17-19	Ford F-550 Super Duty		20
<b>85064</b>	09-11	KIA Borrego		5
<b>85066</b>	10-10	Dodge Ram 1500		5
	10-10	Dodge Ram 2500		5
	10-10	Dodge Ram 3500		5
	11-12	RAM 1500		5
	11-12	RAM 2500		5
	11-12	RAM 3500		5
<b>85067</b>	11-19	Dodge Durango w/Factory Tow Package		5
	11-19	Jeep Grand Cherokee w/Factory Tow Package		5
	17-19	Chrysler Pacifica w/Factory 7-Way		5
<b>8507000</b>	14-18	Chevrolet Silverado 1500		5
	14-19	GMC Sierra 1500 LD (Old Body Style)		5
	15-16	Chevrolet Tahoe		5
	15-16	GMC Yukon		5

PART NO.	YEARS	MAKE/MODEL	REC SIZE	IN
8507000	15-17	Chevrolet Suburban		5
	15-18	Cadillac Escalade		5
	15-19	Chevrolet Silverado 2500 HD		5
	15-19	Chevrolet Silverado 3500 HD		5
	15-19	GMC Sierra 2500 HD		5
	15-19	GMC Sierra 3500 HD		5
8507400	14-19	Jeep Cherokee		5
8507500	13-14	RAM 1500		10
	13-14	RAM 2500		10
	13-14	RAM 3500		10
8507600	13-14	RAM 1500		45
	13-14	RAM 2500		45
	13-14	RAM 3500		45
8507700	13-19	RAM 1500 (Classic)		30
	13-21	RAM 2500		30
	13-21	RAM 3500		30
	19-19	RAM 1500 (New Body Style)		30
8507800	15-17	Toyota Tundra		5
	16-17	Toyota Tacoma		5
85083	15-19	RAM 1500 (Classic)		5
	15-21	RAM 2500		5
	15-21	RAM 3500		5
8508400	14-16	Toyota 4Runner		10
8509000	04-16	Freightliner SL		5
	04-16	Freightliner XC		5
<b>T-CONNECTOR</b>				
118743	15-19	BMW, X5, All Styles		45
118815	19-20	Volkswagen, Arteon, All Styles		45
118817	2020	Lincoln, Aviator, All Styles		10
118819	2020	Hyundai, Sonata, All Styles		45
118822	2020	Mazda, CX-30, All Styles		45
118823	18-20	BMW, X3, All Styles		45
74178	85-86	Chevrolet Blazer K5 Full Size		5
	85-86	Chevrolet C10		5
	85-86	Chevrolet C20		5
	85-86	Chevrolet C30		5
	85-86	Chevrolet K10		5
	85-86	Chevrolet K20		5
	85-86	Chevrolet K30		5
	85-86	Chevrolet Suburban C10		5
	85-86	Chevrolet Suburban C20		5
	85-86	Chevrolet Suburban K10		5
	85-86	Chevrolet Suburban K20		5
	85-86	GMC C1500		5
	85-86	GMC C2500		5
	85-86	GMC C3500		5
	85-86	GMC K1500		5
	85-86	GMC K2500		5
	85-86	GMC K3500		5
	85-86	GMC Suburban C1500		5
	85-86	GMC Suburban C2500		5
	85-86	GMC Suburban K1500		5
	85-86	GMC Suburban K2500		5
	85-90	GMC S15		5
	85-91	GMC Jimmy Full Size		5
	85-97	Chevrolet S10		5
	87-88	Chevrolet Suburban R10		5
	87-88	Chevrolet Suburban R20		5
	87-88	Chevrolet Suburban V10		5
	87-88	Chevrolet Suburban V20		5
	87-91	Chevrolet Blazer Full Size		5
	87-91	GMC Suburban R1500		5
	87-91	GMC Suburban R2500		5
	87-91	GMC Suburban V1500		5
	87-91	GMC Suburban V2500		5
	88-91	Chevrolet C2500 Crew Cab		5
	88-91	Chevrolet C3500 Crew Cab		5
	88-91	Chevrolet K2500 Crew Cab		5
	88-91	Chevrolet K3500 Crew Cab		5
	88-91	GMC C2500 Crew Cab		5
	88-91	GMC C3500 Crew Cab		5
	88-91	GMC K2500 Crew Cab		5
	88-91	GMC K3500 Crew Cab		5
	89-91	Chevrolet Suburban R1500		5
	89-91	Chevrolet Suburban R2500		5
	89-91	Chevrolet Suburban V1500		5
	89-91	Chevrolet Suburban V2500		5
	91-91	GMC Syclone		5
	91-97	GMC Sonoma		5
96-97	Isuzu Hombre		5	
74179	86-92	Ford Ranger		5

PART NO.	YEARS	MAKE/MODEL	REC SIZE	IN
74180	99-00	Cadillac Escalade		5
	92-94	Chevrolet Blazer Full Size		5
	92-99	Chevrolet Suburban C1500		5
	92-99	Chevrolet Suburban C2500		5
	92-99	Chevrolet Suburban K1500		5
	92-99	Chevrolet Suburban K2500		5
	95-00	Chevrolet Tahoe		5
	92-99	GMC Suburban C1500		5
	92-99	GMC Suburban C2500		5
	92-99	GMC Suburban K1500		5
	92-99	GMC Suburban K2500		5
	92-00	GMC Yukon		5
	99-00	GMC Yukon Denali		5
74181	87-96	Ford F-150		5
	87-96	Ford F-250		5
	87-96	Ford F-350		5
	97-97	Ford F-250 Heavy Duty		5
	97-97	Ford F-350 Heavy Duty		5
	74182	86-93	Dodge D150	
86-93		Dodge D250		5
86-93		Dodge D350		5
86-93		Dodge Ramcharger		5
86-93		Dodge W150		5
86-93		Dodge W250		5
86-93		Dodge W350		5
87-93		Dodge D350 Cab & Chassis		5
87-93		Dodge W350 Cab & Chassis		5
87-94		Dodge Dakota		5
94-02		Dodge Ram 3500, Cab & Chassis		5
94-94		Dodge Ram 1500		5
94-94		Dodge Ram 2500		5
94-94	Dodge Ram 3500		5	
74187	03-10	Dodge Dakota		10
	06-09	Mitsubishi Raider		10
	11-11	RAM Dakota		10
	91-95	Chrysler Town & Country		10
	91-95	Dodge Caravan		10
	91-95	Dodge Grand Caravan		10
	91-95	Plymouth Grand Voyager		10
	91-95	Plymouth Voyager		10
74205	97-01	Toyota Camry 4 Dr. Sedan		5
74206	97-01	Jeep Cherokee		20
74207	07-09	Pontiac Montana (Canada Only)		10
	97-04	Oldsmobile Silhouette		10
	97-05	Chevrolet Venture		10
	97-98	Pontiac Trans Sport		10
	99-05	Pontiac Montana		10
74216	98-00	Isuzu Hombre		5
	98-04	Chevrolet S10		5
	98-04	GMC Sonoma		5
74217	01-03	Isuzu Rodeo Sport		15
	98-00	Isuzu Amigo		15
	98-02	Honda Passport		15
	98-04	Isuzu Rodeo		15
74218	96-04	Nissan Pathfinder		20
	97-03	Infiniti QX4		20
	98-01	Nissan Altima		20
74219	98-04	Nissan Frontier		5
	98-98	Mercury Villager		5
	98-98	Nissan Quest		5
74223	98-06	Jeep TJ (Canada Only)		15
	98-06	Jeep Wrangler		15
74224	98-02	Chrysler Concorde		15
	98-04	Chrysler Intrepid (Canada Only)		15
	98-04	Dodge Intrepid		15
	99-04	Chrysler 300M		15
	99-99	Chrysler LHS		15
74225	98-99	Lexus LX470		5
	98-99	Toyota Land Cruiser		5
74424	93-99	Ford Ranger		5
	94-97	Mazda B2300		5
	02-09	Mazda B2300		5
	98-01	Mazda B2500		5
	94-08	Mazda B3000		5
	94-09	Mazda B4000		5
74425	73-74	Chevrolet Blazer Full Size		5
	75-84	Chevrolet Blazer K5 Full Size		5
	73-84	Chevrolet C10		5
	73-84	Chevrolet C20		5
	73-84	Chevrolet C30		5
	73-84	Chevrolet K10		5
	77-84	Chevrolet K20		5

# T-CONNECTOR INDEX

PART NO.	YEARS	MAKE/MODEL	REC SIZE	IN
74425	77-84	Chevrolet K30		5
	73-84	Chevrolet Suburban C10		5
	73-84	Chevrolet Suburban C20		5
	73-84	Chevrolet Suburban K10		5
	73-84	Chevrolet Suburban K20		5
	75-78	GMC C15		5
	73-74	GMC C15/C1500		5
	79-84	GMC C1500		5
	75-78	GMC C25		5
	67-74	GMC C25/C2500		5
	79-84	GMC C2500		5
	75-78	GMC C35		5
	73-74	GMC C35/C3500		5
	79-84	GMC C3500		5
	73-84	GMC Jimmy Full Size		5
	67-74	GMC K15		5
	75-78	GMC K15		5
	79-84	GMC K1500		5
	73-74	GMC K25		5
	75-78	GMC K25		5
	79-84	GMC K2500		5
	67-74	GMC K35		5
	77-78	GMC K35		5
	79-84	GMC K3500		5
	73-74	GMC Suburban C15		5
	75-78	GMC Suburban C15		5
	79-84	GMC Suburban C1500		5
	75-78	GMC Suburban C25		5
	79-84	GMC Suburban C2500		5
	73-74	GMC Suburban K15		5
	75-78	GMC Suburban K15		5
	79-84	GMC Suburban K1500		5
	73-74	GMC Suburban K25		5
75-78	GMC Suburban K25		5	
79-84	GMC Suburban K2500		5	
74427	84-91	Chevrolet Blazer S10 Downsize, 2 Dr.		20
	84-91	GMC S15 Jimmy Downsize, 2 Dr.		20
74428	92-97	Ford Crown Victoria		20
	92-97	Mercury Grand Marquis		20
	94-04	Ford Mustang Except Cobra SVT 99-04		20
74430	93-94	Dodge Van, B150		5
	93-94	Dodge Van, B250		5
	93-94	Dodge Van, B350		5
	95-98	Dodge Van, B1500		5
	95-98	Dodge Van, B2500		5
95-98	Dodge Van, B3500		5	
74475	95-03	Dodge Dakota		5
	95-01	Dodge Ram 1500		5
	95-01	Dodge Ram 2500		5
	02	Dodge Ram 2500		5
	95-01	Dodge Ram 3500		5
	02	Dodge Ram 3500		5
	95-01	Dodge Ram 4000		5
74477	92-97	Isuzu Rodeo		5
	94-97	Honda Passport		5
74487	91-96	Buick Roadmaster		10
	91-96	Chevrolet Caprice		10
	94-96	Chevrolet Impala SS		10
74489	97	Jeep TJ (Canada Only)		10
	91-95	Jeep Wrangler		10
	97	Jeep Wrangler		10
74491	91-92	Oldsmobile Custom Cruiser Wagon		10
	91-96	Buick Roadmaster Estate Wagon		10
	91-96	Chevrolet Caprice Wagon		10
74494	86-94	Nissan D21 (App. starts with 86-1/2)		10
	87-95	Nissan Pathfinder		10
74657	96-99	Ford Taurus 4 Dr. Sedan		10
	96-99	Mercury Sable Sedan		10
74658	96-00	Chrysler Town & Country		20
	96-00	Dodge Caravan		20
	96-00	Dodge Grand Caravan		20
	96-00	Plymouth Grand Voyager		20
	96-00	Plymouth Voyager		20
98-03	Dodge Durango		20	
74660	97-99	Acura CL		10
	01-03	Acura CL		10
	94-01	Acura Integra		10
	01-06	Acura MDX		10
	96-01	Acura RL		10
	96-03	Acura TL		10
	94-02	Honda Accord 4 Dr. Sedan		10
	93-97	Honda Civic Del Sol		10
	97-06	Honda CR-V		10
	03-04	Honda Element		10

PART NO.	YEARS	MAKE/MODEL	REC SIZE	IN
74660	95-04	Honda Odyssey		5
	03-08	Honda Pilot		10
	01	Honda Prelude		10
	96-99	Isuzu Oasis		10
74661	92-02	Isuzu Trooper		5
	96-99	Acura SLX		5
74663	96-02	Toyota 4Runner		20
74665	00-03	Ford Excursion		10
	00-03	Ford F-150 SuperCrew		10
	00-03	Ford Focus Wagon (Built Before 11/2002)		10
	00-03	Ford Ranger		10
	01-03	Ford Explorer 2 Dr. Sport		10
	02-03	Ford Explorer 4 Dr.		10
	02-03	Ford Explorer Sport Trac		10
	02-03	Mercury Mountaineer		10
	03-04	Lincoln Aviator		10
	04-04	Ford F-150 Heritage Flareside		10
	95-02	Ford E-150 Econoline		10
	95-02	Ford E-250 Econoline		10
	95-02	Ford E-350 Econoline		10
	97-03	Ford Expedition		10
	97-03	Ford F-150 Flareside		10
	97-97	Ford Aerostar Extended Body		10
97-97	Ford Aerostar Standard Body		10	
97-99	Ford Escort 4 Dr. Sedan		10	
97-99	Mercury Tracer 4 Dr. Sedan		10	
98-03	Ford Escort ZX2		10	
98-03	Lincoln Navigator		10	
74666	95-98	Ford Windstar		20
74668	94-98	Jeep Grand Cherokee		45
74669	92-96	Ford Bronco		5
74690	01-07	Toyota Highlander Except Hybrid		20
	06-11	Hyundai Azera		20
74691	04-06	Scion xB		20
74692	07-12	Hyundai Santa Fe		20
	10-13	KIA Forte 4 Dr. Sedan		20
74693	07-17	Jeep Wrangler Except w/Right Hand Drive & Limited Edition		10
	18-18	Jeep Wrangler JK Except w/Right Hand Drive & Limited Edition		10
74694	06-13	Chevrolet Impala		10
74695	02-07	Saturn Vue		20
74696	06-11	Buick Lucerne		10
	10-11	Buick Lucerne		10
74697	09-14	Acura TSX 4 Dr. Sedan		15
	08-12	Honda Accord Coupe		15
	08-12	Honda Accord Sedan		15
	06-17	Honda Civic 4 Dr. Sedan, Except Hybrid & Si		15
	07-13	Honda Fit		15
	04-09	Mazda 3 4 Dr. Sedan, Except w/Grand Touring LED Taillights		15
	04-09	Mazda 3 5 Dr. Hatchback, Except w/Grand Touring LED Taillights		15
	10-13	Mazda 3 4 Dr. Sedan, Except w/Grand Touring LED Taillights		15
	10-13	Mazda 3 5 Dr. Hatchback, Except w/Grand Touring LED Taillights		15
	07-12	Mitsubishi Galant		15
74699	11-13	Ford Fiesta 4 Dr. Sedan		10
	06-09	Ford Fusion		10
	10-12	Ford Fusion		10
74701	07-13	Acura MDX		10
74702	07-10	Jeep Grand Cherokee		20
	11-13	Jeep Grand Cherokee		20
74703	05-07	Ford Escape		
	05-06	Mazda Tribute		
74704	07-11	Honda CR-V		
74705	07	Dodge Caliber		
	07-10	Jeep Compass		
07	Jeep Patriot			
74708	07-10	Kia Rondo		
	11-12	Kia Rondo (Canada Only)		
74709	07-09	Chevrolet Equinox		
	07-09	Pontiac Torrent		
	07-09	Suzuki XL-7 w/Factory Tow Package		
74710	07-10	Hyundai Elantra 4 Dr. Sedan		
	06-09	Hyundai Sonata		
	09-10	Kia Optima		
74711	07-09	Saturn Outlook		
74713	06-07	Honda Accord 2 Dr. Coupe		

PART NO.	YEARS	MAKE/MODEL	REC SIZE	IN
74714	06-17	Honda Civic 2 Dr. Coupe, Except Si		10
74715	05-10	Honda Odyssey		20
74716	04-07	Chevrolet Malibu LS 4 Dr. Sedan		15
	04-07	Chevrolet Malibu LT 4 Dr. Sedan		15
	04-07	Chevrolet Malibu Maxx LS		15
	04-07	Chevrolet Malibu Maxx LT		15
	05-09	Pontiac G6		15
	06-07	Chevrolet Malibu SS 4 Dr. Sedan		15
	08-08	Chevrolet Malibu Classic LS		15
	08-08	Chevrolet Malibu Classic LT		15
74717	03-07	Cadillac CTS		45
	04-07	Cadillac CTS V		45
74718	03-05	Honda Accord 2 Dr. Coupe		10
74720	08-09	Saturn Vue		45
	12-15	Chevrolet Captiva Sport		45
74721	07-10	Chrysler Sebring		45
	07-10	Chrysler Sebring Convertible		45
74722	08-10	Dodge Avenger		45
74724	95-00	Ford Explorer		45
	01	Ford Explorer 4 Dr.		45
	97-01	Mercury Mountaineer		45
74885	95-01	Ford Explorer w/Factory Tow Package		
	98-99	Ford Ranger w/Factory Tow Package		
	98-01	Mazda B2500 w/Factory Tow Package		
	98-01	Mazda B3000 w/Factory Tow Package		
	98-01	Mazda B4000 w/Factory Tow Package		
	97-01	Mercury Mountaineer w/Factory Tow Package		
74886	96-99	Chevrolet Express 1500 w/Factory Tow Package		
	00-02	Chevrolet Express 1500 w/Factory Tow Package		
	03	Chevrolet Express 1500 w/Factory Tow Package		
	96-99	Chevrolet Express 2500 w/Factory Tow Package		
	00-02	Chevrolet Express 2500 w/Factory Tow Package		
	03	Chevrolet Express 2500 w/Factory Tow Package		
	96-99	Chevrolet Express 3500 w/Factory Tow Package		
	00-02	Chevrolet Express 3500 w/Factory Tow Package		
	03	Chevrolet Express 3500 w/Factory Tow Package		
	96-99	GMC Savana 1500 w/Factory Tow Package		
	00-02	GMC Savana 1500 w/Factory Tow Package		
	03	GMC Savana 1500 w/Factory Tow Package		
	96-99	GMC Savana 2500 w/Factory Tow Package		
	00-02	GMC Savana 2500 w/Factory Tow Package		
	03	GMC Savana 2500 w/Factory Tow Package		
	96-99	GMC Savana 3500 w/Factory Tow Package		
	00-02	GMC Savana 3500 w/Factory Tow Package		
	03	GMC Savana 3500 w/Factory Tow Package		
74887	00-00	Toyota Tundra		10
74888	99-00	Dodge Van, Ram 1500		5
	99-00	Dodge Van, Ram 2500		5
	99-00	Dodge Van, Ram 3500		5
74889	99-04	Jeep Grand Cherokee		10
74893	97-03	Ford F-150 w/Factory 4-Flat		
	04	Ford F-150 Heritage w/Factory 4-Flat		
	97-99	Ford F-250 Styleside, w/Factory 4-Flat		
74894	99-01	Ford F-250 Super Duty w/Factory 4-Flat		
	99-01	Ford F-350 Super Duty w/Factory 4-Flat		
	99-01	Ford F-450 Super Duty w/Factory 4-Flat		
	99-01	Ford F-550 Super Duty w/Factory 4-Flat		
74896	02-06	Suzuki XL-7		5
	89-98	Suzuki Sidekick		5
	96-97	GEO Tracker		5
	98-04	Chevrolet Tracker		5
	99-04	Suzuki Vitara		5
	99-05	Suzuki Grand Vitara		5
74897	00-04	Nissan Xterra w/Factory Tow Package		
78000	04-07	Chrysler Town & Country		20
	04-07	Dodge Caravan		20
	04-07	Dodge Grand Caravan		20
78001	04-12	Chevrolet Colorado		10
	04-12	GMC Canyon		10
	06-06	Isuzu i-280		10
	06-06	Isuzu i-350		10
	07-08	Isuzu i-290		10
	07-08	Isuzu i-370		10
78003	04-08	Chrysler Pacifica		25
78004	04-10	Toyota Sienna		20
78005	08-10	Volvo V70 Wagon, Except w/Optional Power Operated Tailgate		45
78008	03-08	Pontiac Vibe		15
78009	07-12	GMC Acadia		15

PART NO.	YEARS	MAKE/MODEL	REC SIZE	IN
78010	09-10	Pontiac Vibe		45
	09-13	Toyota Matrix		45
	11-13	Scion xB		45
78011	07-09	KIA Amanti		10
	11-19	KIA Optima		10
78012	07-16	Volvo S80 Sedan		45
78018	06-12	Suzuki Grand Vitara		20
	07-11	Suzuki SX4 Crossover		20
78019	08-11	Ford Focus		15
78020	09-13	Toyota Corolla		45
78022	04-07	Ford Freestar		45
	04-07	Mercury Monterey		45
78023	00-02	Toyota Echo		20
	03-08	Toyota Matrix		20
78024	03-03	Toyota Corolla		15
78025	96-00	Toyota RAV4		20
78026	01-05	Toyota RAV4		20
78027	04-09	Dodge Durango		45
	07-09	Chrysler Aspen		45
78028	05-06	Chevrolet Equinox		10
	06-06	Pontiac Torrent		10
78029	03-14	Chevrolet Express 1500		20
	03-14	GMC Savana 1500		20
	03-20	Chevrolet Express 2500		20
	03-20	Chevrolet Express 3500		20
	03-20	GMC Savana 2500		20
	03-20	GMC Savana 3500		20
78031	05-06	Jeep Grand Cherokee		20
78032	05-07	Ford Five Hundred		10
	05-07	Ford Freestyle		10
78033	08-13	Cadillac CTS 4 Dr. Sedan		15
78034	05-09	Hyundai Tucson		30
78035	05-06	Pontiac Pursuit 4 Dr. (Canada Only)		10
	05-10	Chevrolet Cobalt 4 Dr.		10
	05-10	Chevrolet Cobalt SS 4 Dr.		10
	08-08	Chevrolet Cobalt Sport 4 Dr.		10
78037	06-08	Honda Ridgeline		10
78038	05-10	KIA Sportage 6 Cyl.		5
78039	05-08	Dodge Magnum		45
78040	05-07	Chrysler 300 Except 300 C		10
	06-10	Dodge Charger		10
	08-14	Dodge Challenger		10
78042	05-07	Chrysler 300 C		15
	08-10	Chrysler 300		15
78043	05-10	Chevrolet Cobalt 2 Dr.		15
	05-10	Chevrolet Cobalt SS 2 Dr.		15
	06-11	Chevrolet HHR		15
	07-09	Pontiac G5 2 Dr.		15
	07-09	Pontiac G5 GT 2 Dr.		15
	08-08	Chevrolet Cobalt Sport 2 Dr.		15
	08-10	Chevrolet HHR SS		15
78044	06-10	Jeep Commander		15
78046	06-14	KIA Sedona		45
	07-09	Hyundai Entourage		45
	14	Kia Sedona		45
78047	05-14	Volvo XC90		20
78048	06-12	Toyota RAV4		45
	08-10	Toyota Sequoia		45
78062	04-07	Toyota Highlander		20
78064	00-09	Subaru Outback Wagon, Except Sport		10
	05-07	Subaru Legacy Wagon		10
	06-07	Subaru B9 Tribeca		10
	08-14	Subaru Tribeca		10
	96-99	Subaru Legacy Wagon, Outback		10
	98-08	Subaru Forester		10
78066	08-12	Buick Enclave		10
	08-12	Chevrolet Malibu Except LTZ		10
78067	08-13	Toyota Highlander		20
	14-19	Toyota Highlander		20
78068	08-09	Ford Taurus X		15
78069	08-09	Ford Taurus 4 Dr. Sedan		10
	08-09	Mercury Sable Sedan		10
78070	08-12	Ford Escape Except Vehicles w/Back Up Sensors		
78086	09-09	Dodge Journey		45
78087	09-20	Ford Flex		15
78088	01-06	Hyundai Santa Fe		15
	09-12	Hyundai Elantra Touring 5 Dr.		15

# T-CONNECTOR INDEX

PART NO.	YEARS	MAKE/MODEL	REC SIZE	IN
78092	09-21	Subaru Forester		15
	10-20	Subaru Outback Wagon, Except Sport		15
	13-15	Subaru XV Crosstrek Except Hybrid		15
	16-21	Subaru Crosstrek Except Hybrid		15
78093	04-09	Nissan Quest		45
78094	07-20	Nissan Altima Sedan		45
	08-13	Nissan Altima Coupe		45
	04-08	Nissan Maxima		45
	09-14	Nissan Maxima		45
	07-12	Nissan Sentra		45
78095	09-12	Lincoln MKS		45
	11-13	Ford Fiesta 5 Dr. Hatchback		45
78098	08-11	Subaru Impreza 4 Dr. Sedan		45
78099	07-11	Honda Element		45
78100	08-10	Scion xB		45
78106	04-06	Lexus RX330		45
	07-09	Lexus RX350		45
	10-12	Lexus RX350		45
78108	07-08	Infiniti G35 4 Dr. Sedan		45
	08-13	Nissan Rogue Except Krom		45
	09-13	Infiniti G37 4 Dr. Sedan		45
	14-14	Nissan Rogue Select		45
	14-19	Nissan Rogue		45
78109	07-11	Toyota Camry Hybrid 4 Dr. Sedan		45
	09-16	Toyota Venza		45
	10-11	Toyota Camry 4 Dr. Sedan, Except Hybrid		45
	11-12	Toyota Avalon		45
	14-19	Mitsubishi Outlander Except Outlander Sport or PHEV		45
78111	05-09	Buick LaCrosse		10
78112	09-13	Mazda 6 4 Dr. Sedan		45
85093	15-20	Ford Transit-350 Except Single Rear Wheel		
85249	97-09	Ford E-150 Econoline w/Factory 7-Way		
	01-03	Ford Explorer 2 Dr. Sport, w/Factory 7-Way		
	05-10	Ford Explorer 4 Dr., w/Factory 7-Way		
	97-03	Ford F-150 w/Factory 7-Way		
	04-20	Ford F-150 w/Factory 7-Way		
	04	Ford F-150 Heritage w/Factory 7-Way		
	11-12	GMC Sierra Denali HD, w/Factory 7-Way		
85243	00-03	Ford Taurus 4 Dr. Sedan	10	
	00-03	Mercury Sable Sedan	10	
85245	01-03	Chrysler Town & Country	15	
	01-03	Chrysler Voyager	15	
	01-03	Dodge Caravan	15	
	01-03	Dodge Grand Caravan	15	
85246	00-02	Chevrolet Express 1500	10	
	00-02	Chevrolet Express 2500	10	
	00-02	Chevrolet Express 3500	10	
	00-02	GMC Savana 1500	10	
	00-02	GMC Savana 2500	10	
	00-02	GMC Savana 3500	10	
85247	01-02	Toyota Tundra	10	
85248	01-07	Lexus LX470		
	08-11	Lexus LX570		
	01-03	Lexus RX300		
	01-02	Toyota 4Runner		
	01-03	Toyota Highlander		
01-02	Toyota Land Cruiser			
85249	01-02	Toyota Sequoia		
85250	89-95	Toyota Pickup Except T-100	10	
	95-04	Toyota Tacoma (App. starts with 95-1/2)	10	
85252	01-06	Mitsubishi Montero Except Montero Sport	20	
85253	01-03	Dodge Van, Ram 1500	5	
	01-03	Dodge Van, Ram 2500	5	
	01-03	Dodge Van, Ram 3500	5	
85261	01-05	Pontiac Aztek	20	
	02-07	Buick Rendezvous	20	
85262	02-20	Cadillac Escalade	5	
	03-20	Cadillac Escalade ESV	5	
	15-21	Chevrolet Silverado 2500 HD	5	
85266	02-05	KIA Sedona	25	
85315	03-06	Mitsubishi Outlander	25	
85317	03-06	KIA Sorento	5	
85318	02-06	Toyota Camry 4 Dr. Sedan	5	
85342	08-12	Buick Enclave w/Factory 7-Way		
	04-07	Buick Rainier w/Factory 7-Way		
	02-20	Cadillac Escalade w/Factory 7-Way		
	03-20	Cadillac Escalade ESV w/Factory 7-Way		
	02-11	Cadillac Escalade EXT w/Factory 7-Way		

PART NO.	YEARS	MAKE/MODEL	REC SIZE	IN
85342	07-11	Chevrolet Avalanche w/Factory 7-Way		
	02-06	Chevrolet Avalanche 1500 w/Factory 7-Way		
	02-06	Chevrolet Avalanche 2500 w/Factory 7-Way		
	99-01	Chevrolet Blazer Downsize, w/Factory 7-Way		
	99-01	Chevrolet Blazer Trailblazer w/Factory 7-Way		
85344	05-06	Pontiac Montana SV6		15
	05-07	Buick Terraza		15
	05-07	Saturn Relay		15
	05-08	Chevrolet Uplander		15
	07-09	Pontiac Montana SV6 (Canada Only)		15
09-09	Chevrolet Uplander (Canada Only)		15	
85701	03-08	Mazda 6 4 Dr. Sedan		45
	04-08	Mazda 6 5 Dr. Hatchback		45
	07-09	Toyota Camry 4 Dr. Sedan, Except Hybrid		45
	07-12	Mazda CX-7		45
	07-14	Toyota FJ Cruiser		45
	12-19	Toyota Camry Including Hybrid		45
	14-14	Mazda 3 5 Dr. Hatchback		45
	14-17	Mazda 3 4 Dr. Sedan		45
	14-19	Toyota Corolla Except Hatchback		45
85702	07-10	Scion tC		15
85703	07-12	Lexus ES350		45
85704	04-08	Acura TL		10
85705	10-20	Lexus RX350 w/Factory Tow Package		
	10-18	Lexus RX450h Hybrid, w/Factory Tow Package		
85706	10-17	Ford Mustang		45
85708	10-18	Lexus RX350 With Factory Tow Prep Package		20
	10-18	Lexus RX450h Hybrid		20
	18-18	Lexus RX350L With Factory Tow Prep Package		20
85709	04-06	Chevrolet Aveo 4 Dr. Sedan		15
	04-11	Chevrolet Aveo 5 Dr. Hatchback		15
	09-09	Pontiac G3 5 Dr.		15
85710	10-11	Chevrolet Camaro		15
85712	09-12	Volkswagen Routan		20
85713	09-12	Nissan Cube		45
85716	10-17	Chevrolet Equinox		45
	10-17	GMC Terrain		45
85717	10-10	Dodge Journey		10
85718	08	Toyota Hilux		10
	10-12	Toyota Hilux		10
	93-98	Toyota T100		10
	05-08	Toyota Tacoma		10
	09-15	Toyota Tacoma		10
85719	10-16	Buick LaCrosse		45
85720	11-14	Toyota Sienna		45
	15-20	Toyota Sienna SE		45
85721	07-09	Acura RDX		15
	10-12	Acura RDX		15
	10-11	Honda Accord Crosstour		15
	12	Honda Crosstour		15
85722	10-15	Hyundai Tucson		30
	16-18	Hyundai Tucson		30
85723	10-13	Acura ZDX		30
85724	11-13	Buick Regal		45
85725	04-11	Toyota Prius		25
	12-12	Toyota Prius 4 Dr. Sedan, Except w/Plug-In Model		25
85726	11-13	Kia Sorento Base I4		45
	11-13	Kia Sorento EX I4		45
	11-13	Kia Sorento EX V6, Except w/Factory Tow Package		45
85727	11-13	Kia Sorento LX I4		45
	10-14	Lincoln MKT		45
85728	10-12	Lexus HS250h Hybrid		20
85729	07-12	Hyundai Santa Fe w/Factory Tow Package		
85730	10-16	Cadillac SRX w/Factory Tow Package		
85732	11-15	Chevrolet Cruze		45
	16-16	Chevrolet Cruze Limited Only (Old Body Style)		45
85733	04-10	Volkswagen Touareg		45
85734	10-14	Subaru Legacy Sedan		45
85735	00-05	Chevrolet Impala		25
85738	09-12	Ford E-150 Econoline w/Factory 4-Flat (Prepped Class I Towing Package)		
	09-12	Ford E-250 Econoline w/Factory 4-Flat (Prepped Class I Towing Package)		
	09-12	Ford E-350 Econoline Super Duty w/Factory 4-Flat (Prepped Class I Towing Package)		



PART NO.	YEARS	MAKE/MODEL	REC SIZE	IN
85939	09-12	Ford E-150 Econoline w/Factory 7-Way (Prepped Class II Towing Package)		
	09-12	Ford E-250 Econoline w/Factory 7-Way (Prepped Class II Towing Package)		
	09-12	Ford E-350 Econoline Super Duty w/Factory 7-Way (Prepped Class II Towing Package)		
85740	10-14	Lexus GX460		
	10-11	Toyota 4Runner		
85741	88-00	Chevrolet C3500 Except 88-91 Crew Cab		5
	88-00	Chevrolet K3500 Except 88-91 Crew Cab		5
	88-00	GMC C2500 Except 88-91 Crew Cab		5
	88-00	GMC C3500 Except 88-91 Crew Cab		5
	88-00	GMC K2500 Except 88-91 Crew Cab		5
	88-00	GMC K3500 Except 88-91 Crew Cab		5
	88-99	Chevrolet C1500 Except 88-91 Crew Cab		5
	88-99	Chevrolet C2500 Except 88-91 Crew Cab		5
	88-99	Chevrolet K1500 Except 88-91 Crew Cab		5
	88-99	Chevrolet K2500 Except 88-91 Crew Cab		5
	88-99	GMC C1500 Except 88-91 Crew Cab		5
	88-99	GMC K1500 Except 88-91 Crew Cab		5
	85742	11-14	Ford Edge	
85743	04-08	Mitsubishi Endeavor		30
	10-11	Mitsubishi Endeavor		
85744	07-11	Toyota Yaris 4 Dr. Sedan		45
85745	07-13	Mitsubishi Outlander Except Outlander Sport		45
85746	11-15	Lincoln MKX		45
85747	11-17	Honda Odyssey		30
85750	02-07	Jeep Liberty		45
85751	11-16	KIA Sportage		45
85754	11-14	Mazda 2		45
	06-10	Mazda 5		45
	12-20	Mazda 5		45
	07-15	Mazda CX-9		
85755	11-17	Nissan JUKE		45
85757	05-20	Nissan Frontier		30
85758	10-14	Mitsubishi Lancer 5 Dr. Hatchback, Except Ralliart & w/Dual Exhaust		45
	12-17	Mitsubishi Lancer 4 Dr. Sedan, Except Evolution, Ralliart & w/Dual Exhaust		45
	11-20	Mitsubishi Outlander Sport Except PHEV		45
	11-20	Mitsubishi RVR (Canada Only)		45
85761	11-13	Hyundai Elantra 4 Dr. Sedan		45
	13-14	Hyundai Elantra 2 Dr. Coupe		45
85764	11-17	Jeep Compass (Old Body Style)		45
85766	10-12	Lincoln MKZ		45
85768	07-12	Nissan Versa 5 Dr. Hatchback		45
85769	12-18	FIAT 500		45
85770	11-13	Nissan Quest		45
85771	12-18	Ford Focus Sedan		45
	16-18	Ford Focus RS		45
85772	12-14	Ford Focus 5 Dr. Hatchback, Except ST w/Center Exhaust		45
	13-14	Ford Focus 5 Dr. Hatchback		45
85773	11-11	Chrysler 200 4 Dr. Sedan		45
	11-11	Chrysler 200 Convertible		45
	11-11	Dodge Avenger		45
85774	08-14	Ford E-150 Econoline		45
	08-14	Ford E-250 Econoline		45
	08-14	Ford E-350 Econoline Super Duty		45
	07-10	Ford Edge		45
	08-12	Ford Escape		45
	07-10	Lincoln MKX		45
	05-07	Mercury Mariner		45
85775	08-10	Chrysler Town & Country		45
	08-10	Dodge Grand Caravan		45
	08-12	Dodge Caliber		45
	08-17	Jeep Patriot		45
	11-13	Dodge Durango		45
85776	12-19	Nissan NV1500		45
	12-19	Nissan NV2500		45
	12-19	Nissan NV3500		45
85778	06-11	Cadillac DTS		45
84779	10-17	Chevrolet Equinox w/Factory Tow Package		
	10-17	GMC Terrain w/Factory Tow Package		
85784	12-15	Chevrolet Camaro		30
85785	12-12	Chevrolet Orlando (Canada Only)		45
85787	07	Dodge Nitro		45
	08-11	Dodge Nitro		45
	08-12	Jeep Liberty		45

PART NO.	YEARS	MAKE/MODEL	REC SIZE	IN
85788	10-10	Hyundai Sonata		45
	11-14	Hyundai Sonata Except Hybrid		45
85791	12-16	Honda CR-V		45
85792	06-10	Volkswagen Passat 4 Dr. Sedan		45
85793	13-16	Mazda CX-5		45
85794	12-17	KIA Rio 5 Dr. Hatchback		45
	12-17	KIA Rio 4 Dr. Sedan		45
85795	13-16	Ford Escape		45
85796	11-19	Dodge Journey w/LED Taillights		45
85797	12-17	Buick Verano		45
85798	12-17	Hyundai Accent 4 Dr. Sedan		45
85799	13-16	Dodge Dart		25
85800	12-16	Subaru Impreza 5 Dr. Wagon, Except WRX STi		45
85801	13-19	Ford Fusion		45
85802	13-15	Chevrolet Spark		45
85803	13-13	Chevrolet Malibu Except LTZ & Canada Models		45
85804	13-18	Acura RDX		15
85805	13-18	Hyundai Santa Fe Sport (5 Passenger)		45
85806	05-20	Nissan Frontier		
85809	12-19	Dodge Journey Except w/LED Taillights		45
85810	11-14	Volkswagen Jetta 4 Dr. Sedan		45
	15-18	Volkswagen Jetta 4 Dr. Sedan, Except Hybrid & TDI		45
85811	12-14	Chrysler 200 4 Dr. Sedan		45
	12-14	Chrysler 200 Convertible		45
	12-14	Dodge Avenger		45
85812	13-19	Cadillac ATS		25
85813	12-16	Subaru Impreza 4 Dr. Sedan, Except WRX & WRX STi		45
85814	13-18	Toyota Avalon		45
	13-18	Toyota RAV4		45
85815	13-18	Toyota RAV4		
	13-18	Hyundai Santa Fe (6/7 Passenger)		
	13-18	Hyundai Santa Fe Sport w/Factory Tow Package (5 Passenger)		
	14-18	Hyundai Santa Fe Sport (5 Passenger) w/Factory Tow Package		
	07-12	Hyundai Veracruz		
	15-21	Kia Sedona		
	07-09	Kia Sorento w/Factory Tow Package		
11-13	Kia Sorento LX V6 w/Factory Tow Package			
14-20	Kia Sorento w/ V6 Engine			
85816	10-12	Ford Transit Connect		45
	13	Ford Transit Connect		45
85817	13-20	Nissan Sentra		45
	14-20	Nissan Versa Note		45
85818	14-19	KIA Sorento w/ I4 Engine		45
85820	13-16	Buick Encore		45
85821	14-20	Mazda 6 4 Dr. Sedan		45
85822	14-20	Chevrolet Impala Except Impala Limited		45
85823	13-19	Lincoln MKZ		45
85824	13-20	Lexus ES300h Hybrid		45
	13-18	Lexus ES350		45
85825	09-12	Infiniti FX35		45
	09-13	Infiniti FX50		45
	13-13	Infiniti FX37		45
85826	14-18	KIA Forte 4 Dr. Sedan		45
85827	12-17	Hyundai Azera		45
85828	13-17	Honda Accord Coupe, Except w/LED Taillights		45
	13-15	Honda Accord Sedan, Except w/LED Taillights		45
85829	13-20	Nissan NV200		45
	15-20	Chevrolet City Express		45
85831	10-20	Ford Taurus 4 Dr. Sedan		45
	13-16	Lincoln MKS		45
	20-21	Ford Explorer		45
85832	11-14	Chrysler 300		25
	11-14	Chrysler 300 C		25
85833	13-13	Chevrolet Malibu (Canada Only), Except LTZ		45
	14-15	Chevrolet Malibu Except LTZ		45
	16-19	Chevrolet Malibu Limited, Except LTZ (Old Body Style)		45
85834	14-18	Jeep Cherokee		45
85835	13-15	Honda Crosstour		15
85836	13-17	Buick Enclave		20
85838	14-19	Dodge Durango		45

# T-CONNECTOR INDEX

PART NO.	YEARS	MAKE/MODEL	REC SIZE	IN
85839	14-14	Scion tC		45
85840	14-19	Ford Fiesta 5 Dr. Hatchback		45
85842	13-19	Acura ILX		45
85843	10-19	KIA Soul w/LED Taillights		45
85844	15-18	Chrysler 200 4 Dr. Sedan		45
85845	14-17	Buick Regal		45
85848	15-20	Jeep Renegade		45
85849	09-14	Nissan Murano Except CrossCabriolet		20
85850	13-15 16-19	Chevrolet Malibu LTZ Except Canada Models Chevrolet Malibu Limited LTZ, Except Canada Models (Old Body Style)		45 45
85853	12-20	Toyota Prius V		45
85855	14-21	Ford Transit Connect		45
85858	14-21 14-21 14-21	RAM ProMaster 1500 All Models RAM ProMaster 2500 All Models RAM ProMaster 3500 All Models		45 45 45
85860	14-20	Acura MDX		20
85862	12-18 12-18	Chevrolet Sonic 4 Dr. Sedan Chevrolet Sonic 5 Dr. Hatchback		45 45
85864	15-17	Hyundai Sonata Except Hybrid		45
85865	14-20	Cadillac CTS 4 Dr. Sedan		45
85866	15-20	Toyota Sienna Except SE		45
85867	15-20 15-20	Lexus NX300h Lexus NX200t		45 45
85868	15-20	Nissan Murano Except CrossCabriolet		20
85869	15-17	Volvo V60 (App. starts with 2015-1/2)		45
85870	15-20	Dodge Charger		30
85871	13-16 17-21	Chevrolet Trax Chevrolet Trax LS		45 45
85872	15-20	Toyota Yaris		45
85874	05-10	Volkswagen Jetta 4 Dr. Sedan		45
85875	15-18	Ford Edge Except Sport & Titanium Models		45
85877	15-19 18-20	Chevrolet Silverado 2500 HD Volkswagen Atlas Except Cross Sport, w/Factory 7-Way		5 5
85878	14-20	Infiniti QX60		
85879	12-19 15-20	Volkswagen Passat Volkswagen Golf Except Sportwagen Models		45 45
85880	15-20	Dodge Challenger		30
85882	11-17	Volkswagen Touareg		45
85883	14-21	Infiniti QX60		30
85884	15-20	Subaru Legacy		45
85885	14-20	Infiniti Q50		45
85886	16-20	Honda HR-V		0
85887	15-19	Ford Focus 5 Dr. Hatchback, Except RS		45
85888	12-20 18-20	Volkswagen Tiguan Volkswagen Tiguan Limited		45 45
85889	15-18	Ford Edge Titanium and Sport Models Only		45
85893	16-21	Nissan Maxima		45
85894	15-20	Chrysler 300		20
85895	16-16	Hyundai Elantra 4 Dr. Limited Models Only		45
85896	12-20	Toyota Prius C		25
85897	15-20 14 15-20	Land Rover Range Rover w/Factory Tow Package Land Rover Range Rover Sport Land Rover Range Rover Sport		10 10 10
85898	16-18 17-20	Lincoln MKX Lincoln Continental		45 45
85900	14-20 14-20 14-20	RAM ProMaster 1500 All Models RAM ProMaster 2500 All Models RAM ProMaster 3500 All Models		
85902	17-21 16-21	Volvo S90 Volvo XC90		20 20
85903	16-17	Honda Accord Sedan		45
85904	17-17	Hyundai Elantra 4 Dr. Limited Models		45
85905	17-20 17-20 17-20 17-20	Chrysler Pacifica Limited Chrysler Pacifica Touring L Chrysler Pacifica Touring L Plus Chrysler Pacifica Touring Plus		45 45 45 45
85907	16-18 16-17 16 16 16 16	BMW 320i BMW 320i xDrive BMW 328d BMW 328d xDrive BMW 328i BMW 328i GT xDrive		45 45 45 45 45 45

PART NO.	YEARS	MAKE/MODEL	REC SIZE	IN
85907	16 16 16-20 16-20 16-20	BMW 328i xDrive BMW 330e BMW 330i BMW 340i BMW 340i xDrive		45 45 45 45 45
85908	13-18	Volkswagen CC		45
85909	17-18	Ford Escape		45
85910	16-20	BMW X1		45
85912	17-20 19-20 17-20	Cadillac XT5 Chevrolet Blazer GMC Acadia		
85913	16-20	Mitsubishi Outlander Except Outlander Sport or PHEV		
85914	16-20	Mazda CX-9 w/Factory Tow Package		
85915	16-18	Chevrolet Camaro		45
85916	16-20	Buick Envision		15
85917	16-21	Chevrolet Malibu Except Premier (New Body Style)		45
85918	17-21 20-21 19-21 17-21	Cadillac XT5 Cadillac XT6 Chevrolet Blazer GMC Acadia		
85920	16-19	Chevrolet Cruze (New Body Style)		45
85921	17-21 17-21	Chrysler Pacifica LX Chrysler Pacifica Touring		45 45
85922	15-20	RAM ProMaster City		45
85923	16-20	FIAT 500X		45
85924	14-20 14-20 14-20 14-20	Freightliner Sprinter 2500 Freightliner Sprinter 3500 Mercedes-Benz Sprinter 2500 Mercedes-Benz Sprinter 3500		45 45 45 45
85925	07-09 07-09 07-13 07-13 07-09 10-13 10-13	Dodge Sprinter 2500 Dodge Sprinter 3500 Freightliner Sprinter 2500 Freightliner Sprinter 3500 Mercedes-Benz Sprinter Mercedes-Benz Sprinter 2500 Mercedes-Benz Sprinter 3500		45 45 45 45 45 45 45
85926	16-21	Toyota Tacoma		45
85927	15-20	Land Rover Discovery Sport		45
85928	12-13 14-20	Volkswagen Beetle Volkswagen Beetle		45 45
85929	17-20	Hyundai Elantra 4 Dr. Except Limited Models		45
85930	16-21	Chevrolet Spark		45
85931	16-17	Honda Accord Coupe		45
85932	17-21	KIA Sportage		45
85933	16-19	Toyota Prius Except Prius Prime		45
85934	16-20	Mazda CX-3		45
85935	16-19	Volkswagen Passat Except SE & SEL		45
85936	15-20	Ford Transit-350		45
85937	16-16	Honda Civic Coupe		45
85938	17-19	Chevrolet Volt		45
85939	16-16 17-20	Scion iA Toyota Yaris iA		45 45
85940	16-16 17-18 19-19	Scion iM Toyota Corolla iM Toyota Corolla Hatchback		45 45 45
85941	16-17 17-17	Volkswagen Golf SportWagen Volkswagen Golf Alltrack		45 45
85942	16-20	Nissan Altima Sedan		45
85943	16-19	Honda Civic Sedan		45
85944	14-21	Jeep Grand Cherokee		45
85946	17-18	Chevrolet Cruze Hatchback		45
85947	17-20	Infiniti QX30		45
85948	10-20	Volvo XC60		45
85949	16-20	Chevrolet Malibu Premier (New Body Style)		45
85950	17-20	Honda CR-V		30
85951	16-19	Volkswagen Passat SE & SEL Only		45
85952	17-21	Buick Encore		45
85954	18-21	Chevrolet Equinox Except Premier		45
85955	16-19	Acura TLX		45
85956	16-20	Cadillac CT6		25



# TOW HARNESS INDEX

PART NO.	YEARS	MAKE/MODEL	REC SIZE	IN	
<b>74682</b>	97-19	Ford F-150 Styleside, w/Factory 7-Way	10	10	
	00-19	Ford F-150 SuperCrew, w/Factory 7-Way	10	10	
	97-99	Ford F-250 Styleside, w/Factory 7-Way	10	10	
	99-19	Ford F-250 Super Duty w/Factory 7-Way	10	10	
	99-19	Ford F-350 Super Duty w/Factory 7-Way	10	10	
	99-15	Ford F-450 Super Duty w/Factory 7-Way	10	10	
	99-11	Ford F-550 Super Duty w/Factory 7-Way	10	10	
	09-19	Ford Flex w/Factory 7-Way	10	10	
	00-11	Ford Ranger w/Factory 7-Way	10	10	
	07-12	GMC Acadia w/Factory 7-Way	10	10	
	04-12	GMC Canyon w/Factory 7-Way	10	10	
	02-09	GMC Envoy w/Factory 7-Way	10	10	
	99-01	GMC Jimmy Downsize, w/Factory 7-Way	10	10	
	07-07	GMC Sierra 1500 (Classic), w/Factory 7-Way	10	10	
	07-07	GMC Sierra 1500 HD (Classic), w/Factory 7-Way	10	10	
	01-06	GMC Sierra 1500 HD w/Factory 7-Way	10	10	
	99-18	GMC Sierra 1500 w/Factory 7-Way	10	10	
	07-07	GMC Sierra 2500 HD (Classic), w/Factory 7-Way	10	10	
	11-12	GMC Sierra 2500 HD Denali HD, w/Factory 7-Way	10	10	
	01-19	GMC Sierra 2500 HD w/Factory 7-Way	10	10	
	99-04	GMC Sierra 2500 w/Factory 7-Way	10	10	
	07-07	GMC Sierra 3500 (Classic), w/Factory 7-Way	10	10	
	07-19	GMC Sierra 3500 HD w/Factory 7-Way	10	10	
	01-06	GMC Sierra 3500 w/Factory 7-Way	10	10	
	01-17	GMC Yukon Denali w/Amber Turn Signals, w/Factory 7-Way	10	10	
	00-17	GMC Yukon w/Amber Turn Signals, w/Factory 7-Way	10	10	
	01-19	GMC Yukon XL 1500 Denali w/Factory 7-Way	10	10	
	00-11	GMC Yukon XL 1500 w/Factory 7-Way	10	10	
	00-13	GMC Yukon XL 2500 w/Factory 7-Way	10	10	
	03-09	Hummer H2 w/Factory 7-Way	10	10	
	06-10	Hummer H3 w/Factory 7-Way	10	10	
	09-10	Hummer H3T w/Factory 7-Way	10	10	
	04-12	Infiniti QX56 w/Factory 7-Way	10	10	
	03-08	Isuzu Ascender w/Factory 7-Way	10	10	
	11-15	Jeep Grand Cherokee w/Factory 7-Way	10	10	
	09-12	Jeep Liberty w/Factory 7-Way	10	10	
	09-11	KIA Borrego w/Factory 7-Way	10	10	
	10-11	Lexus GX460 w/Factory 7-Way	10	10	
	03-05	Lincoln Aviator w/Factory 7-Way	10	10	
	06-08	Lincoln Mark LT w/Factory 7-Way	10	10	
	10-12	Lincoln MKT w/Factory 7-Way	10	10	
	98-11	Lincoln Navigator w/Factory 7-Way	10	10	
	00-10	Mercury Mountaineer w/Factory 7-Way	10	10	
	05-14	Nissan Armada w/Factory 7-Way	10	10	
	04-04	Nissan Pathfinder Armada w/Factory 7-Way	10	10	
	04-14	Nissan Titan w/Factory 7-Way	10	10	
	99-04	Oldsmobile Bravada w/Factory 7-Way	10	10	
	11-17	RAM 1500 w/Factory 7-Way	10	10	
	11-19	RAM 2500 w/Factory 7-Way	10	10	
	11-17	RAM 3500 w/Factory 7-Way	10	10	
	05-09	Saab 9-7X w/Factory 7-Way	10	10	
	07-09	Saturn Outlook w/Factory 7-Way	10	10	
	10-11	Toyota 4Runner w/Factory 7-Way	10	10	
	09-12	Toyota Tacoma w/Factory 7-Way	10	10	
	10-13	Toyota Tundra w/Factory 7-Way	10	10	
	<b>7468211</b>	08-12	Buick Enclave w/Factory 7-Way	10	10
		04-07	Buick Rainier w/Factory 7-Way	10	10
		03-15	Cadillac Escalade ESV w/Factory 7-Way	10	10
		02-11	Cadillac Escalade EXT w/Factory 7-Way	10	10
		02-16	Cadillac Escalade w/Factory 7-Way	10	10
02-06		Chevrolet Avalanche 1500 w/Factory 7-Way	10	10	
02-06		Chevrolet Avalanche 2500 w/Factory 7-Way	10	10	
02-06		Chevrolet Avalanche w/Factory 7-Way	10	10	
07-11		Chevrolet Blazer Downsize, w/Factory 7-Way	10	10	
99-01		Chevrolet Blazer Trailblazer w/Factory 7-Way	10	10	
99-01		Chevrolet Colorado w/Factory 7-Way	10	10	
04-12		Chevrolet Silverado 1500 (Classic), w/Factory 7-Way	10	10	
07-07		Chevrolet Silverado 1500 HD (Classic), w/Factory 7-Way	10	10	
07-07		Chevrolet Silverado 1500 HD w/Factory 7-Way	10	10	
01-06		Chevrolet Silverado 1500 LD (Old Body Style) w/Factory 7-Way	10	10	
01-06		Chevrolet Silverado 1500 w/Factory 7-Way	10	10	
99-18		Chevrolet Silverado 2500 HD (Classic), w/Factory 7-Way	10	10	
07-07		Chevrolet Silverado 2500 HD w/Factory 7-Way	10	10	
01-19		Chevrolet Silverado 2500 w/Factory 7-Way	10	10	
99-18		Chevrolet Silverado 2500 w/Factory 7-Way	10	10	
07-07		Chevrolet Silverado 2500 HD (Classic), w/Factory 7-Way	10	10	
01-19		Chevrolet Silverado 2500 HD w/Factory 7-Way	10	10	
99-04		Chevrolet Silverado 2500 w/Factory 7-Way	10	10	
07-07		Chevrolet Silverado 3500 (Classic), w/Factory 7-Way	10	10	

PART NO.	YEARS	MAKE/MODEL	REC SIZE	IN
<b>7468211</b>	07-19	Chevrolet Silverado 3500 HD w/Factory 7-Way	10	10
	01-06	Chevrolet Silverado 3500 w/Factory 7-Way	10	10
		Chevrolet Suburban 1500 w/Amber Turn Signals, w/Factory 7-Way	10	10
	00-14	Chevrolet Suburban 2500 w/Amber Turn Signals, w/Factory 7-Way	10	10
	00-13	Chevrolet Tahoe w/Amber Turn Signals, w/Factory 7-Way	10	10
	02-09	Chevrolet TrailBlazer w/Factory 7-Way	10	10
	09-12	Chevrolet Traverse w/Factory 7-Way	10	10
	09-09	Chrysler Aspen w/Factory 7-Way	10	10
	09-09	Dodge Durango w/Factory 7-Way	10	10
	09-10	Dodge Ram 1500 w/Factory 7-Way	10	10
	10-10	Dodge Ram 2500 w/Factory 7-Way	10	10
	10-10	Dodge Ram 3500 w/Factory 7-Way	10	10
	97-09	Ford E-150 Econoline w/Factory 7-Way	10	10
	97-09	Ford E-250 Econoline w/Factory 7-Way	10	10
	97-09	Ford E-350 Econoline w/Factory 7-Way	10	10
	00-05	Ford Excursion w/Factory 7-Way	10	10
	97-15	Ford Expedition w/Factory 7-Way	10	10
	00-03	Ford Explorer 2 Dr. Sport, w/Factory 7-Way	10	10
	00-10	Ford Explorer 4 Dr., w/Factory 7-Way	10	10
	07-10	Ford Explorer Sport Trac w/Factory 7-Way	10	10
	11-19	Ford Explorer w/Factory 7-Way	10	10
	97-19	Ford F-150 Flareside, w/Factory 7-Way	10	10
	04-04	Ford F-150 Heritage Flareside, w/Factory 7-Way	10	10
	04-04	Ford F-150 Heritage Styleside, w/Factory 7-Way	10	10
	97-19	Ford F-150 Styleside, w/Factory 7-Way	10	10
	00-19	Ford F-150 SuperCrew, w/Factory 7-Way	10	10
	97-99	Ford F-250 Styleside, w/Factory 7-Way	10	10
	99-19	Ford F-250 Super Duty w/Factory 7-Way	10	10
	99-19	Ford F-350 Super Duty w/Factory 7-Way	10	10
	99-15	Ford F-450 Super Duty w/Factory 7-Way	10	10
	99-11	Ford F-550 Super Duty w/Factory 7-Way	10	10
	09-19	Ford Flex w/Factory 7-Way	10	10
	00-11	Ford Ranger w/Factory 7-Way	10	10
	07-12	GMC Acadia w/Factory 7-Way	10	10
	04-12	GMC Canyon w/Factory 7-Way	10	10
	02-09	GMC Envoy w/Factory 7-Way	10	10
	99-01	GMC Jimmy Downsize, w/Factory 7-Way	10	10
	07-07	GMC Sierra 1500 (Classic), w/Factory 7-Way	10	10
	07-07	GMC Sierra 1500 HD (Classic), w/Factory 7-Way	10	10
	01-06	GMC Sierra 1500 HD w/Factory 7-Way	10	10
	99-18	GMC Sierra 1500 w/Factory 7-Way	10	10
	07-07	GMC Sierra 2500 HD (Classic), w/Factory 7-Way	10	10
	11-12	GMC Sierra 2500 HD Denali HD, w/Factory 7-Way	10	10
	01-19	GMC Sierra 2500 HD w/Factory 7-Way	10	10
	99-04	GMC Sierra 2500 w/Factory 7-Way	10	10
	07-07	GMC Sierra 3500 (Classic), w/Factory 7-Way	10	10
	07-19	GMC Sierra 3500 HD w/Factory 7-Way	10	10
	01-06	GMC Sierra 3500 w/Factory 7-Way	10	10
	01-17	GMC Yukon Denali w/Amber Turn Signals, w/Factory 7-Way	10	10
	00-17	GMC Yukon w/Amber Turn Signals, w/Factory 7-Way	10	10
	01-19	GMC Yukon XL 1500 Denali w/Factory 7-Way	10	10
	00-11	GMC Yukon XL 1500 w/Factory 7-Way	10	10
	00-13	GMC Yukon XL 2500 w/Factory 7-Way	10	10
	03-09	Hummer H2 w/Factory 7-Way	10	10
	06-10	Hummer H3 w/Factory 7-Way	10	10
	09-10	Hummer H3T w/Factory 7-Way	10	10
	04-12	Infiniti QX56 w/Factory 7-Way	10	10
	03-08	Isuzu Ascender w/Factory 7-Way	10	10
	11-15	Jeep Grand Cherokee w/Factory 7-Way	10	10
	09-12	Jeep Liberty w/Factory 7-Way	10	10
09-11	KIA Borrego w/Factory 7-Way	10	10	
10-11	Lexus GX460 w/Factory 7-Way	10	10	
03-05	Lincoln Aviator w/Factory 7-Way	10	10	
06-08	Lincoln Mark LT w/Factory 7-Way	10	10	
10-12	Lincoln MKT w/Factory 7-Way	10	10	
98-11	Lincoln Navigator w/Factory 7-Way	10	10	
00-10	Mercury Mountaineer w/Factory 7-Way	10	10	
05-14	Nissan Armada w/Factory 7-Way	10	10	
04-04	Nissan Pathfinder Armada w/Factory 7-Way	10	10	
04-14	Nissan Titan w/Factory 7-Way	10	10	
99-04	Oldsmobile Bravada w/Factory 7-Way	10	10	
11-17	RAM 1500 w/Factory 7-Way	10	10	
11-19	RAM 2500 w/Factory 7-Way	10	10	
11-17	RAM 3500 w/Factory 7-Way	10	10	
05-09	Saab 9-7X w/Factory 7-Way	10	10	
07-09	Saturn Outlook w/Factory 7-Way	10	10	
10-11	Toyota 4Runner w/Factory 7-Way	10	10	
09-12	Toyota Tacoma w/Factory 7-Way	10	10	
10-13	Toyota Tundra w/Factory 7-Way	10	10	



PART NO.	YEARS	MAKE/MODEL	REC SIZE	IN
74885	95-01	Ford Explorer w/Factory Tow Package		5
	98-99	Ford Ranger w/Factory Tow Package		5
	98-01	Mazda B2500 w/Factory Tow Package		5
	98-01	Mazda B3000 w/Factory Tow Package		5
	98-01	Mazda B4000 w/Factory Tow Package		5
	97-01	Mercury Mountaineer w/Factory Tow Package		5
74886	96-03	Chevrolet Express 1500 w/Factory Tow Package		5
	96-03	Chevrolet Express 2500 w/Factory Tow Package		5
	96-03	Chevrolet Express 3500 w/Factory Tow Package		5
	96-03	GMC Savana 1500 w/Factory Tow Package		5
	96-03	GMC Savana 2500 w/Factory Tow Package		5
	96-03	GMC Savana 3500 w/Factory Tow Package		5
74893	04-04	Ford F-150 Heritage w/Factory 4-Flat		5
	97-03	Ford F-150 w/Factory 4-Flat		5
	97-99	Ford F-250 Styleside, w/Factory 4-Flat		5
74894	99-01	Ford F-250 Super Duty w/Factory 4-Flat		5
	99-01	Ford F-350 Super Duty w/Factory 4-Flat		5
	99-01	Ford F-450 Super Duty w/Factory 4-Flat		5
	99-01	Ford F-550 Super Duty w/Factory 4-Flat		5
74897	00-04	Nissan Xterra w/Factory Tow Package		5
78063	04-04	Ford F-150 w/Factory 4-Flat		5
78070	08-12	Ford Escape Except Vehicles w/Back Up Sensors		5
	08-11	Mazda Tribute		5
	08-11	Mercury Mariner		5
85092	15-19	Ford Transit-150 Ford Transit-250		90
	15-19	Ford Transit-350 Single Rear Wheel w/148 Wheelbase		90
	15-19	Wheelbase		45
85093	15-19	Ford Transit-350 Except Single Rear Wheel w/148 Wheelbase		90
85248	01-07	Lexus LX470		10
	08-11	Lexus LX570		10
	01-03	Lexus RX300		10
	01-02	Toyota 4Runner		10
	01-03	Toyota Highlander		10
	01-02	Toyota Land Cruiser		10
85249	01-02	Toyota Sequoia		5
8550900	07-08	Chrysler Aspen w/Factory 7-Way		10
	04-08	Chrysler Pacifica w/Factory 7-Way		10
	00-09	Dodge Dakota w/Factory 7-Way		10
	00-08	Dodge Durango w/Factory 7-Way		10
	00-08	Dodge Ram 1500 w/Factory 7-Way		10
	00-09	Dodge Ram 2500 w/Factory 7-Way		10
	00-09	Dodge Ram 3500 w/Factory 7-Way		10
	03-09	Dodge Sprinter 2500 w/Factory 7-Way		10
	03-09	Dodge Sprinter 3500 w/Factory 7-Way		10
	01-03	Dodge Van, Ram 1500 w/Factory 7-Way		10
	01-03	Dodge Van, Ram 2500 w/Factory 7-Way		10
	01-03	Dodge Van, Ram 3500 w/Factory 7-Way		10
	03-09	Freightliner Sprinter 2500 w/Factory 7-Way		10
	03-09	Freightliner Sprinter 3500 w/Factory 7-Way		10
	06-10	Jeep Commander w/Factory 7-Way		10
	00-10	Jeep Grand Cherokee w/Factory 7-Way		10
05-08	Jeep Liberty w/Factory 7-Way		10	
06-09	Mitsubishi Raider w/Factory 7-Way		10	
8551000	03-06	Toyota Tundra w/Factory 7-Way		10
85705	10-18	Lexus RX350 w/Factory Tow Package Lexus		5
	18-18	RX350L w/Factory Tow Package		5
	10-18	Lexus RX450h Hybrid, w/Factory Tow Package		5
85729	07-12	Hyundai Santa Fe w/Factory Tow Package		25
85730	10-16	Cadillac SRX w/Factory Tow Package		5
85738	09-12	Ford E-150 Econoline w/Factory 4-Flat (Prepped Class I Towing Package)		10
	09-12	Ford E-250 Econoline w/Factory 4-Flat (Prepped Class I Towing Package)		10
	09-12	Ford E-350 Econoline Super Duty w/Factory 4-Flat (Prepped Class I Towing Package)		10
85739	09-12	Ford E-150 Econoline w/Factory 7-Way (Prepped Class II Towing Package)		10
	09-12	Ford E-250 Econoline w/Factory 7-Way (Prepped Class II Towing Package)		10
	09-12	Ford E-350 Econoline Super Duty w/Factory 7-Way (Prepped Class II Towing Package)		10
85740	10-14	Lexus GX460		10
	10-11	Toyota 4Runner		10
85763	05-19	Nissan Frontier w/Factory Tow Package		5
	05-07	Nissan Pathfinder		5
	05-15	Nissan Xterra w/Factory Tow Package		5
	09-12	Suzuki Equator w/Factory Tow Package		5
85779	10-17	Chevrolet Equinox w/Factory Tow Package		15
	10-17	GMC Terrain w/Factory Tow Package		15

PART NO.	YEARS	MAKE/MODEL	REC SIZE	IN
85780	09-11	Honda Pilot		20
	09-14	Honda Ridgeline		10
85786	12-15	Honda Pilot		30
85806	05-19	Nissan Frontier		30
	05-07	Nissan Pathfinder		30
	08-12	Nissan Pathfinder Except w/Factory 4-Flat		30
	05-15	Nissan Xterra		30
85807	09-12	Suzuki Equator		30
	05-19	Nissan Frontier w/Factory Tow Package		5
	05-07	Nissan Pathfinder		5
	08-12	Nissan Pathfinder Except w/Factory 4-Flat		5
	05-15	Nissan Xterra w/Factory Tow Package		5
85815	09-12	Suzuki Equator w/Factory Tow Package		5
	13-17	Hyundai Santa Fe (6/7 Passenger)		20
85815	14-18	Hyundai Santa Fe Sport (5 Passenger) w/Factory Tow Package		20
	13-18	Hyundai Santa Fe Sport w/Factory Tow Package (5 Passenger)		20
	19-19	Hyundai Santa Fe XL w/Factory Tow Package		20
	07-12	Hyundai Veracruz		20
	15-19	KIA Sedona		20
	11-13	KIA Sorento EX V6, w/Factory Tow Package KIA		20
	11-13	Sorento LX V6		20
	11-13	KIA Sorento LX V6 w/Factory Tow Package KIA		20
	11-13	Sorento SX V6		20
	14-19	KIA Sorento w/ V6 Engine		20
	07-09	KIA Sorento w/Factory Tow Package		20
85873	11-19	Ford Explorer		20
85878	14-15	Infiniti QX60		30
	13-19	Nissan Pathfinder		30
85899	08-12	Buick Enclave		25
	09-12	Chevrolet Traverse		25
85900	14-18	RAM ProMaster 1500 All Models		60
	14-19	RAM ProMaster 2500 All Models RAM ProMaster		60
	14-19	3500 All Models		60
85912	17-19	Cadillac XT5		10
	19-19	Chevrolet Blazer		10
	17-19	GMC Acadia		10
85913	16-18	Mitsubishi Outlander Except Outlander Sport or PHEV		25
85914	16-19	Mazda CX-9 w/Factory Tow Package		25
85918	19-19	Chevrolet Blazer		10
	17-19	GMC Acadia		10
	17-19	Cadillac XT5		10
85960	05-17	Nissan Frontier (Canada Only)		30
	05-07	Nissan Pathfinder (Canada Only)		30
	08-12	Nissan Pathfinder Except w/Factory 4-Flat (Canada Only)		30
	05-15	Nissan Xterra (Canada Only)		30
85961	09-12	Suzuki Equator (Canada Only)		30
	05-17	Nissan Frontier w/Factory Tow Package (Canada Only)		5
85961	05-07	Nissan Pathfinder (Canada Only)		5
	08-12	Nissan Pathfinder Except w/Factory 4-Flat (Canada Only)		5
	05-15	Nissan Xterra w/Factory Tow Package (Canada Only)		5
85962	09-12	Suzuki Equator w/Factory Tow Package (Canada Only)		5
	18-19	Chevrolet Equinox w/ Tow Prep Package		15
85962	18-19	GMC Terrain w/ Tow Prep Package		15
85963	18-19	Buick Enclave		15
	18-19	Chevrolet Traverse		15
85978	16-19	Toyota Tacoma		90
85979	11-16	Chrysler Town & Country		90
	11-19	Dodge Grand Caravan		90
	12-15	RAM C/V Tradesman		90
85981	15-19	Ford F-150		25
85983	16-19	Honda Pilot		30
85985	15-17	Lincoln MKC		45
85987	14-19	Ford Fiesta 4 Dr. Sedan		45
89530	19-19	Honda Passport		25
89534	20-20	KIA Soul Except w/LED Taillights		45
<b>6-WAY AND 7-WAY CONNECTORS</b>				
85219	08-12	Buick Enclave w/Factory 7-Way		10
	04-07	Buick Rainier w/Factory 7-Way		10
	03-15	Cadillac Escalade ESV w/Factory 7-Way		10
	02-11	Cadillac Escalade EXT w/Factory 7-Way		10
	02-16	Cadillac Escalade w/Factory 7-Way		10
	02-06	Chevrolet Avalanche 1500 w/Factory 7-Way		10



# 6-WAY / 7-WAY CONNECTOR INDEX

PART NO.	YEARS	MAKE/MODEL	REC SIZE	IN	
<b>6-WAY AND 7-WAY CONNECTORS</b>					
<b>85219</b>	02-06	Chevrolet Avalanche 2500 w/Factory 7-Way	10	10	
	07-11	Chevrolet Avalanche w/Factory 7-Way	10	10	
	99-01	Chevrolet Blazer Downsize, w/Factory 7-Way	10	10	
	99-01	Chevrolet Blazer Trailblazer w/Factory 7-Way	10	10	
	04-12	Chevrolet Colorado w/Factory 7-Way	10	10	
	07-07	Chevrolet Silverado 1500 (Classic), w/Factory 7-Way	10	10	
	07-07	Chevrolet Silverado 1500 HD (Classic), w/Factory 7-Way	10	10	
	01-06	Chevrolet Silverado 1500 HD w/Factory 7-Way	10	10	
	07-19	Chevrolet Silverado 1500 LD (Old Body Style) w/Factory 7-Way	10	10	
	99-06	Chevrolet Silverado 1500 w/Factory 7-Way	10	10	
	07-07	Chevrolet Silverado 2500 HD (Classic), w/Factory 7-Way	10	10	
	01-19	Chevrolet Silverado 2500 HD w/Factory 7-Way	10	10	
	99-04	Chevrolet Silverado 2500 w/Factory 7-Way	10	10	
	07-07	Chevrolet Silverado 3500 (Classic), w/Factory 7-Way	10	10	
	07-19	Chevrolet Silverado 3500 HD w/Factory 7-Way	10	10	
	01-06	Chevrolet Silverado 3500 w/Factory 7-Way	10	10	
	00-14	Chevrolet Suburban 1500 w/Amber Turn Signals, w/Factory 7-Way	10	10	
	00-13	Chevrolet Suburban 2500 w/Amber Turn Signals, w/Factory 7-Way	10	10	
	00-11	Chevrolet Tahoe w/Amber Turn Signals, w/Factory 7-Way	10	10	
	02-09	Chevrolet TrailBlazer w/Factory 7-Way	10	10	
	09-12	Chevrolet Traverse w/Factory 7-Way	10	10	
	09-09	Chrysler Aspen w/Factory 7-Way	10	10	
	09-09	Dodge Durango w/Factory 7-Way	10	10	
	09-10	Dodge Ram 1500 w/Factory 7-Way	10	10	
	10-10	Dodge Ram 2500 w/Factory 7-Way	10	10	
	10-10	Dodge Ram 3500 w/Factory 7-Way	10	10	
	97-09	Ford E-150 Econoline w/Factory 7-Way	10	10	
	97-09	Ford E-250 Econoline w/Factory 7-Way	10	10	
	97-09	Ford E-350 Econoline w/Factory 7-Way	10	10	
	00-05	Ford Excursion w/Factory 7-Way	10	10	
	97-15	Ford Expedition w/Factory 7-Way	10	10	
	01-03	Ford Explorer 2 Dr. Sport, w/Factory 7-Way	10	10	
	00-10	Ford Explorer 4 Dr., w/Factory 7-Way	10	10	
	<b>8551511</b>	00-11	Chevrolet Tahoe w/Amber Turn Signals, w/Factory 7-Way	10	10
		00-11	GMC Yukon XL 1500 w/Factory 7-Way	10	10
		00-13	Chevrolet Suburban 2500 w/Amber Turn Signals, w/Factory 7-Way	10	10
		00-13	GMC Yukon XL 2500 w/Factory 7-Way	10	10
		00-14	Chevrolet Suburban 1500 w/Amber Turn Signals, w/Factory 7-Way	10	10
		00-17	GMC Yukon w/Amber Turn Signals, w/Factory 7-Way	10	10
		01-06	Chevrolet Silverado 1500 HD w/Factory 7-Way	10	10
		01-06	Chevrolet Silverado 3500 w/Factory 7-Way	10	10
		01-06	GMC Sierra 1500 HD w/Factory 7-Way	10	10
		01-06	GMC Sierra 3500 w/Factory 7-Way	10	10
		01-17	GMC Yukon Denali w/Amber Turn Signals, w/Factory 7-Way	10	10
		01-19	Chevrolet Silverado 2500 HD w/Factory 7-Way	10	10
		01-19	GMC Sierra 2500 HD w/Factory 7-Way	10	10
		01-19	GMC Yukon XL 1500 Denali w/Factory 7-Way	10	10
02-06		Chevrolet Avalanche 1500 w/Factory 7-Way	10	10	
02-06		Chevrolet Avalanche 2500 w/Factory 7-Way	10	10	
02-09		Chevrolet TrailBlazer w/Factory 7-Way	10	10	
02-09		GMC Envoy w/Factory 7-Way	10	10	
02-11		Cadillac Escalade EXT w/Factory 7-Way	10	10	
02-16		Cadillac Escalade w/Factory 7-Way	10	10	
03-08		Isuzu Ascender w/Factory 7-Way	10	10	
03-09		Hummer H2 w/Factory 7-Way	10	10	
03-11		Cadillac Escalade ESV w/Factory 7-Way	10	10	
04-07		Buick Rainier w/Factory 7-Way	10	10	
04-12		Chevrolet Colorado w/Factory 7-Way	10	10	
04-12		GMC Canyon w/Factory 7-Way	10	10	
05-09		Saab 9-7X w/Factory 7-Way	10	10	
06-10		Hummer H3 w/Factory 7-Way	10	10	
07-07		Chevrolet Silverado 1500 (Classic), w/Factory 7-Way	10	10	
07-07		Chevrolet Silverado 1500 HD (Classic), w/Factory 7-Way	10	10	
07-07		Chevrolet Silverado 2500 HD (Classic), w/Factory 7-Way	10	10	
07-07		Chevrolet Silverado 3500 (Classic), w/Factory 7-Way	10	10	
07-07		GMC Sierra 1500 (Classic), w/Factory 7-Way	10	10	

PART NO.	YEARS	MAKE/MODEL	REC SIZE	IN
<b>8551511</b>	07-07	GMC Sierra 1500 HD (Classic), w/Factory 7-Way	10	10
	07-07	GMC Sierra 2500 HD (Classic), w/Factory 7-Way	10	10
	07-07	GMC Sierra 3500 (Classic), w/Factory 7-Way	10	10
	07-09	Saturn Outlook w/Factory 7-Way	10	10
	07-11	Chevrolet Avalanche w/Factory 7-Way	10	10
	07-12	GMC Acadia w/Factory 7-Way	10	10
	07-19	Chevrolet Silverado 1500 LD (Old Body Style) w/Factory 7-Way	10	10
	07-19	Chevrolet Silverado 3500 HD w/Factory 7-Way	10	10
	07-19	GMC Sierra 3500 HD w/Factory 7-Way	10	10
	08-12	Buick Enclave w/Factory 7-Way	10	10
	09-10	Hummer H3T w/Factory 7-Way	10	10
	09-12	Chevrolet Traverse w/Factory 7-Way	10	10
	11-12	GMC Sierra 2500 HD Denali HD, w/Factory 7-Way	10	10
	99-01	Chevrolet Blazer Downsize, w/Factory 7-Way	10	10
	99-01	Chevrolet Blazer Trailblazer w/Factory 7-Way	10	10
	99-01	GMC Jimmy Downsize, w/Factory 7-Way	10	10
	99-04	Chevrolet Silverado 2500 w/Factory 7-Way	10	10
	99-04	GMC Sierra 2500 w/Factory 7-Way	10	10
	99-04	Oldsmobile Bravada w/Factory 7-Way	10	10
	99-06	Chevrolet Silverado 1500 w/Factory 7-Way	10	10
99-18	GMC Sierra 1500 w/Factory 7-Way	10	10	

**NOTES**

Dotted lines for notes

# PRODUCT INDEX

PART NO.	DESCRIPTION	PAGE NUMBER
06195	Insta-Hitch™ II	A-2
06280	Drawbar Kit	B-5
06474	Drawbar	B-5
0700900	Loading Ramp - Standard	E-14
1040100	Cargo Carrier - Trailer Hitch Mount	E-6
1040200	Cargo Carrier Bi-Fold Ramp	E-6
1041000	Roof Top Cargo Carrier	E-4
1041100	Cargo Carrier Bag	E-4
1041500	Cargo Carrier - Trailer Hitch Mount	E-5
1043000	Rainproof Cargo Carrier Bag	E-6
11003	Trailer Hitch Extension	B-12
11004	Trailer Hitch Extension	B-12
11006	Trailer Hitch Extension	B-12
11021	Trailer Hitch Receiver Tube	B-11
11080	2 Combo Bar	B-11
118001	4-Flat Connector Harness - Vehicle End	C-7
118002	4-Flat Connector Harness - Vehicle End	C-7
118030	7-Way Connector - Vehicle End	C-12
118031	7-Way Connector - Trailer End	C-12
118033	4-Flat Connector Harness - Trailer End	C-7
118044	4-Flat Connector Harness - Loop	C-8
118045	4-Flat Connector Harness - Loop	C-8
118136	Towing Electrical Mount Bracket (1 of 2)	C-15
118140	Towing Electrical Mount Bracket (1 of 2)	C-15
118192	4-Flat Connector Harness - Trailer End	C-8
118601	Trailer Connector Adapter - 4 to 4-Flat	C-19
118710	Trailer Connector Adapter - 7 to 4-Flat	C-19
119250	Zero Contact Universal ModuLite	C-6
119251	Zero Contact Universal ModuLite	C-6
1390100	Cargo Carrier Bag	E-4
1390200	Courtesy Cover / Mat	E-4
1390600	Ratcheting Cargo Bar	E-16
1390800	Universal Pet Barrier	E-16
1391100	Expandable Car Top Bag	E-4
1391300	Roof Top Cargo Carrier	E-3
1391400	Roof Rack Cross Bars	E-3
1392200	Vehicle Trunk Organizer	E-16
1393100G	4 Bike Carrier - Trailer Hitch Mount	E-7
1393700	Cargo Net	E-6
1394400	Cargo Carrier - Roof Rack	E-3
1394500	Cargo Carrier - Trailer Hitch Mount	E-5
1394900	Kayak Carrier - Roof Rack	E-8
1395800	Cargo Carrier - Trailer Hitch Mount	E-5
1395900	Cross Bars 48" Adjustable	E-3
15058	Trailer Hitch Pin	B-20
16210C	Trailer Hitch Clip	B-20
20117	Trailer Wire Plug Tester	C-16
20136	Trailer Connector Adapter - 4 to 5-Flat	C-8
20141	Trailer Connector Adapter - 7 to 5-Flat	C-19
20147	7-Way Connector Harness - Vehicle End	C-11
20250	4-Flat Connector Harness - Vehicle End	C-7
20252	4-Flat Connector Harness - Vehicle End	C-7
2060000	Cambuckle Tie Down Strap	E-19, H-8
2060200	Ratchet Tie Down Strap	E-19, H-8
2060300	Ratchet Tie Down Strap	E-15, H-8
2060400	Cambuckle Tie Down Strap	E-19, H-8
2061300	Ratchet Tie Down Strap	E-19, H-8
2061400	Ratchet Tie Down Strap	E-19, H-8
21141	Trailer Hitch Adjustable Ball Mount	B-10
21171	Trailer Hitch Ball Mount	B-6
21175	Trailer Hitch Ball Mount	B-6
21186	Trailer Hitch Ball Mount	B-6
21330	Class V Trailer Hitch Ball Mount	B-8
21331	Class V Trailer Hitch Ball Mount	B-8
21332	Class V Trailer Hitch Ball Mount	B-8
21342	Class IV Trailer Hitch Ball Mount	B-6
21344	Class IV Trailer Hitch Ball Mount	B-6
21345	Class IV Trailer Hitch Ball Mount	B-6
21347	Class III Trailer Hitch Ball Mount	B-6
21511	Dual-Ball Trailer Hitch Ball Mount	B-8
21514	Tri-Ball Trailer Hitch Ball Mount	B-9
21518	Dual-Ball Trailer Hitch Ball Mount	B-8

PART NO.	DESCRIPTION	PAGE NUMBER
21536	Trailer Hitch Starter Ball Mount Kit	B-6
21542	Trailer Hitch Starter Ball Mount Kit	B-6
21543	Trailer Hitch Starter Ball Mount Kit	B-6
21556	Trailer Hitch Starter Ball Mount Kit	B-6
21790	Trailer Hitch Ball Mount	B-7
21791	Trailer Hitch Ball Mount	B-7
21792	Trailer Hitch Ball Mount	B-7
21793	Trailer Hitch Ball Mount	B-7
21794	Trailer Hitch Ball Mount	B-7
21900	Trailer Hitch Ball Mount	B-7
21901	Trailer Hitch Ball Mount	B-7
3592011	Class I Trailer Hitch Drawbar Kit	B-5
3594011	Class I Trailer Hitch Drawbar Kit	B-5
37041	Class III Trailer Hitch	A-5
37042	Class III Trailer Hitch	A-5
37094	Class IV Trailer Hitch	A-5
37096	Class III Trailer Hitch	A-5
38186	Pintle Hook Mounting Plate	B-14
4210	Lunette Ring Lock	B-14
45018	Trailer Hitch Extension	B-12
45156	Pintle Hook Mounting Plate	B-14
45292	Trailer Hitch Extension	B-12
45294	Pintle Hook Mounting Plate	B-14
49802	License Plate Holder	A-6
5085115	Post Mount Bracket Kit	C-14, H-2
508573	Trailer Fender	H-5
508574	Trailer Fender	H-5
50-85-315	Breakaway System	C-14, H-2
50-85-320	Breakaway System	C-14, H-2
5443	License Plate Holder	A-6
55003	Trailer Hitch Coupler Lock	B-23
58109	Trailer Hitch Ball Reducer Bushing	B-26
58117	Trailer Hitch Ball Grease	B-26
58184	Trailer Hitch Ball Reducer Bushing	B-26
63120	Eclipse™ Bike Carrier	E-8
63124	Eclipse™ Bike Carrier	E-8
63134	2 Bike Carrier - Trailer Hitch Mount	E-7
63135	Replacement Part - Bike Carrier	E-7
63138	4 Bike Carrier - Trailer Hitch Mount	E-7
63153	Cargo Carrier - Trailer Hitch Mount	E-5
63155	Cargo Carrier - Trailer Hitch Mount	E-5
63251	Fifth Wheel Trailer Hitch King Pin Lock	B-24
63604	Cargo Carrier Bag	E-6
6495	Winch Mounting Plate	A-6
6502	Cargo Carrier - Trailer Hitch Mount	E-5
6715	Trailer Hitch Spare Tire Carrier	A-6
6758	Trailer Hitch Work Step	A-6
6771	Trailer Hitch Skid Shield	A-6
7000100	Trailer Accessories	H-7
7000300	Wheel Chock	H-7
7000600	Trailer Hitch Tube Cover	B-25
7004700	Dual Fit Trailer Coupler	F-5
7004800	Dual Fit Trailer Coupler	F-5
7004900	Dual Fit Trailer Coupler	F-7
7005000	Dual Fit Trailer Coupler	F-7
7005100	Trailer Hitch Starter Ball Mount Kit	B-5
7005200	Trailer Hitch Starter Ball Mount Kit	B-5
7005300	Trailer Coupler Lock	B-23
7005600	Trailer Hitch Towing Lock	B-23
7005800	Trailer Coupler Lock	B-23
7006000	Trailer Hitch Towing Lock	B-20
7006100	Trailer Hitch and Coupler Lock	B-20
7006400	Trailer Hitch Towing Lock	B-20
7006500	Trailer Hitch Towing Lock	B-20
7006600	Trailer Coupler Lock	B-23
7006700	Trailer Hitch Towing Pin	B-20
7006800	Trailer Hitch Pin and Clip	B-19
7007100	Trailer Hitch Pin and Clip	B-20
7007400	Tow Hook	H-3
7007500	Trailer Hitch Safety Cable	H-3
7007600	Trailer Hitch Safety Chain	H-3
7007700	Trailer Hitch Safety Chain	H-3

PART NO.	DESCRIPTION	PAGE NUMBER
7007800	Trailer Hitch Safety Chain	H-3
7007900	Trailer Hitch Safety Chain Link	H-3
7008000	Trailer Hitch Safety Chain Link	H-3
7008100	Class I Trailer Hitch Ball	B-4
7008200	Class II Trailer Hitch Ball	B-4
7008300	Class IV Trailer Hitch Ball	B-4
7008400	Class I Trailer Hitch Ball	B-4
7008500	Class II Trailer Hitch Ball	B-4
7008600	Class IV Trailer Hitch Ball	B-4
7008700	Class I Trailer Hitch Ball	B-4
7009100	Trailer Hitch Pin and Clip	B-19
7009200	Trailer Hitch Pin and Clip	B-19
7009300	Trailer Hitch Towing Lock	B-22
7010100	Trailer Hitch Towing Lock	B-22
7010200	Trailer Hitch and Coupler Lock	B-22
7010500	Trailer Hitch Pin and Clip	B-19
7010600	Trailer Hitch Pin and Clip	B-19
7011300	Class IV Trailer Hitch Ball	B-4
7011400	Class IV Trailer Hitch Ball	B-4
7012900	Trailer Hitch Alignment System	B-26, H-5
7013100	Trailer Hitch Ball Cover	B-26
7013700	Lunette Ring	B-14
7014200	Tow Bar - Split Rail	H-4
7014500	Trailer Hitch Towing Lock	B-20
7014700	Trailer Hitch Towing Lock	B-24
7015500	Outboard Motor Support Bracket	H-7
7015600	Outboard Motor Support Bracket	H-7
7016000	Marine Carpet	H-7
7016300	Spare Tire Carrier	H-4
7016900	Trailer Winch	F-6
7017000	Trailer Winch	F-6
7017200	Trailer Winch Strap	F-6, F-7
7018100	Canoe Loader - Trailer Hitch Mount	E-8, H-7
7019200†	Spare Tire Carrier	H-9
7019400	Trailer Winch	F-6
7020500	Trailer Hitch Adapter	B-11
7021200	Trailer Hitch Towing Lock	B-20
7021300	Comfort Grip R-Pin Cotter Clips (3 pack)	B-19
7021500	Replacement Part - Pintle Hook Ball	B-13
7021600	Replacement Part - Pintle Hook Ball	B-13
7021700	Replacement Part - Pintle Hook Ball	B-13
7021800	Adjustable Ball Mount	B-10
7022400	Tri-Ball Trailer Hitch Ball Mount	B-9
7022900	Trailer Hitch Adapter	B-11
7024000	Pintle Hook Combination	B-15
7024100	Pintle Hook Combination	B-15
7024200	Pintle Hook Combination	B-15
7024300	Pintle Hook	B-15
7024400	Trailer Hitch Tow Hook	B-15
7024500	Trailer Hitch Tow Eye	B-15
7024600	Trailer Hitch Tow Ring	B-16
7025700	Trailer Hitch Safety Chain	H-3
7028100	Class V Trailer Hitch Ball Mount	B-8
7028200	Class V Trailer Hitch Ball Mount	B-8
7028400	Class V Trailer Hitch Ball	B-3
7028500	Class V Trailer Hitch Ball	B-3
7028636	Class V Trailer Hitch Ball	B-3
7028700	Trailer Hitch Adapter	B-11
7028900	Class I Trailer Hitch Ball	B-3
7030200	Trailer Hitch Towing Lock	B-21
7030300	Trailer Hitch Towing Lock	B-21
7030400	Trailer Hitch Towing Lock	B-21
7030500	Trailer Coupler Lock	B-21
7030600	Trailer Hitch and Coupler Lock	B-21
7031300	Trailer Hitch Adjustable Ball Mount	B-10
7031400	Tri-Ball Trailer Hitch Ball Mount	B-9
7031500	Trailer Coupler Lock	B-22
7031600	Trailer Hitch Towing Lock	B-24
7031700	Clevis Mount Pin	B-16
7033100	Trailer Hitch Pin and Clip	B-19
7033200	Trailer Hitch Towing Lock	B-22
7033300	Trailer Hitch Towing Lock	B-22

PART NO.	DESCRIPTION	PAGE NUMBER
7033400	Farm Multi-Jack	F-4
7033600	Portable Electric Winch	F-6
7033830	Cable Lock	B-24
7033920	Hitch Ball	B-3
7036400	Powered A-Frame Jack, 2500 lbs.	F-2
7036700†	Spare Tire Carrier	H-9
7036800	Class I Trailer Hitch Ball	B-3
7039000	Trailer Hitch Towing Lock	B-22
7039100	Trailer Hitch Towing Lock	B-22
7039200	Interlock Towing Starter Kit	B-6
7039300	Interlock Towing Starter Kit	B-6
7039800	Tri-Ball Trailer Hitch Ball Mount	B-9
7042100	Trailer Coupler Lock	B-23
7042900	Trailer Jack	F-2
7043000	Trailer Hitch Starter Ball Mount Kit	B-6
7043120	Trailer Hitch Starter Ball Mount Kit	B-6
7043200	Trailer Hitch Starter Ball Mount Kit	B-6
7043700	Towing Mirror Set - Blind Spot	H-9
7044000	Towing Mirror Set - Blind Spot	H-4
7044900	Replacement Part - Pintle Chain Assy	B-14
7050900	Trailer Coupler Pin and Chain	F-5
7051500	Trailer Hitch Tube Cover	B-25
7052500	Trailer Hitch Adapter	B-11
7054430	Trailer Hitch Towing Lock	B-21
7054530	Trailer Hitch and Coupler Lock	B-21
7054630	Trailer Hitch Towing Lock	B-21
7054700	Truck Bed Rack	E-9
7054900	Ladder Rack Conduit Carrier	E-9
7055200	Truck Bed Top Rail Kit	E-17
7057030	Trailer Hitch Towing Lock	B-21
7057130	Trailer Hitch Towing Lock	B-21
7057230	Trailer Hitch Towing Lock	B-21
7057330	Trailer Coupler Lock	B-21
7057430	Trailer Coupler Lock	B-21
7057730	Trailer Hitch Pin and Clip	B-19
7057830	Trailer Hitch Towing Lock	B-21
7060100	Trailer Hitch Extension	B-11
7060200	Trailer Hitch Step	B-18
7060400	Class IV Trailer Hitch Ball	B-4
7060600	Trailer Hitch Ball Mount	B-7
7060700	Trailer Hitch Ball Mount	B-7
7060800	Trailer Hitch Ball Mount	B-7
7060900	Farm Multi-Jack	F-4
7061200	Class IV Trailer Hitch Ball	B-4
7061500	Farm Multi-Jack Handle Holder	F-4
7061700	Truck Bed Rack Protective Glides	E-17
7062800	Trailer Hitch Ball Mount	B-7
7062900	Trailer Hitch Ball Mount	B-7
7063000	Truck Bed Load Stop Kit	E-17
7063200	Trailer Hitch Ball Mount	B-7, B-8
7063300	Trailer Hitch Ball Mount	B-7, B-8
7063400	Class V Trailer Hitch Ball	B-4
7063500	Truck Bed Rack	E-17
7063930	Trailer Hitch Pin	B-19
7064100	Farm Multi-Jack Repair Kit	F-4
7064200	UTV Multi-Jack	F-4
7064600	Trailer Winch	F-7
7064800	Trailer Winch	F-6
7065000	UTV/ATV 3-Way Trailer Hitch	B-17
7065100	UTV/ATV 3-Way Trailer Hitch	B-17
7065300	Trailer Hitch Step	B-18, G-16
7065500	Trailer Hitch Tow Ring	B-17
7065700	Trailer Hitch Ball Mount	B-7
7066900	Trailer Coupler Lock	B-23
7067000	Ratchet Cable Puller	H-6
7067200	Chain Hoist	H-6
7067300	Chain Hoist	H-6
7067400	Chain Hoist	H-6
7067900	Trailer Hitch Ball Mount	B-7
7068000	Trailer Hitch Ball Mount	B-7
7068100	Trailer Hitch Ball Mount	B-7
7068300	Trailer Hitch Ball Mount	B-7

# PRODUCT INDEX

PART NO.	DESCRIPTION	PAGE NUMBER
7068800	Trailer Hitch Ball Mount	B-9
7068900	Tri-Ball Trailer Hitch Ball Mount	B-10
7070700	Trailer Hitch Towing Lock	B-21
7070800	Trailer Hitch Towing Lock	B-21
7071000	Class IV Trailer Hitch Ball	B-4
7071100	Class II Trailer Hitch Ball	B-4
7071200	Class II Trailer Hitch Ball	B-4
7071300	Sport Utility Jack	F-4
7073930	Trailer Hitch Ball Wrench	B-26
7074000	Ball Mount Storage	B-17
7074100	Trailer Hitch Step	B-18
7074300	Wheel Chock	H-7
7074630	Trailer Hitch Tube Cover	B-25
7075300†	Trailer Hitch Safety Chain	H-9
7076100	Marine and Recreational Jacks	F-3
7076300	Marine and Recreational Jacks	F-3
7076600	Marine and Recreational Jacks	F-3
7076800	Marine and Recreational Jacks	F-4
7077900	Trailer Weld-On Jack - 2,000 lbs	F-3
7078100	Trailer Weld-On Jack - 2,000 lbs	F-3
7078300	Trailer Weld-On Jack - 2,000 lbs	F-3
7078500	Trailer Weld-On Jack - 2,000 lbs	F-3
7078700	Marine and Recreational Jacks	F-3
7078900	Trailer Jack	F-3
7079000	Trailer Weld-On Jack - 5,000 lbs	F-3
7079200	Trailer Weld-On Jack - 5,000 lbs	F-3
7079500	Trailer Weld-On Jack - 5,000 lbs	F-3
7079900	HD Square Trailer Jacks - 12,000 lbs	F-4
7080100	Trailer Jack	F-4
7080200†	A-Frame Trailer Jack - 2,000 lbs	F-4
7080300	A-Frame Trailer Jack - 2,000 lbs	F-4
7080500	Trailer Hitch Starter Ball Mount Kit	B-6
7081000	Trailer Hitch Starter Ball Mount Kit	B-6
7081300	Trailer Hitch Ball Mount	B-7
7081400	Trailer Hitch Towing Lock	B-22
7081500	Trailer Hitch Towing Lock	B-21
7081600	Trailer Hitch Pin	B-19
7086100	Trailer Hitch Ball Mount	B-27
7088200	Trailer Hitch Adapter	B-11
7088300	Coupler Lock	B-23
7088800	Trailer Hitch Adapter	B-11
7089244	Clevis Ball Mount	B-16
7089344	Trailer Hitch Hook & Shackle	B-9
7089444	Trailer Hitch Ball Mount	B-10
7089500	Trailer Hitch Ball Mount	B-8
7089600	Trailer Hitch Ball Mount	B-8
7089700	Trailer Hitch Ball Mount	B-8
7089800	Trailer Hitch Ball Mount	B-8
7090200	Trailer Hitch Pin and Clip	B-19
7090600	Trailer Hitch Adapter	B-11
7090800	Trailer Hitch Ball Mount	B-6
7090900	Trailer Hitch Ball Mount	B-6
7091200	Hitch Ball	B-3
7092100	Trailer Hitch Pin and Clip	B-19
7092330	Trailer Hitch Towing Lock	B-22
7092400	Trailer Hitch Ball Mount	B-6
7092500	Trailer Hitch Ball Mount	B-6
7094300	Tri-Ball Mount	B-9
7095620	Tactical Tri-Ball Trailer Hitch Ball Mount	B-9
72783	Trailer Coupler Lock	B-23
72786	Trailer Hitch Safety Chain	H-3
72790	Trailer Wheel Bearing Protector	H-9
72791	Trailer Wheel Bearing Protector	H-4
73803	Clearance Light	G-12
73804	Clearance Light	G-12
73805	Mini Clearance Light	G-13
73806	Mini Clearance Light	G-13
73807	Marker Clearance Light	G-12
73808	Marker Clearance Light	G-12
73812	Marker Light	G-13
73813	Marker Light	G-15
73814	Rotating Warning Light	G-17

PART NO.	DESCRIPTION	PAGE NUMBER
73815	Interior Light	G-15
73817	Round Reflector	G-18
73818	Round Reflector	G-18
73819	Oblong Reflector	G-18
73820	Oblong Reflector	G-18
73821	Combination Park & Turn Light	G-7
73822	Recessed Tail Light	G-6
73823	Round Tail Light	G-6
73824	Tail Light Assembly	G-4
73825	Tail Light Assembly	G-4
73826	Tail Light Assembly	G-5
73827	Tail Light Assembly	G-5
73828	Tail Light Assembly	G-6
73829	Tail Light Assembly	G-4
73830	Tail Light Assembly	G-6
73831	Tail Light Assembly	G-6
73832	Tail Light Assembly	G-4
73833	Tail Light Assembly	G-5
7383411	Tail Light Kit	G-4
73837	License Plate Lights	G-15
73838	Mini Clearance Light	G-12
73839	Mini Clearance Light	G-12
73840	Tractor Light	G-16
73841	Running Board Light	G-8
73842	Running Board Light	G-8
73843	Behive Clearance Light	G-10, G-12
73844	Behive Clearance Light	G-10, G-12
73845	Tail Light Assembly	G-9
73846	Tail Light Assembly	G-9
73847	Tail Light Assembly	G-8
73848	Running Board Light	G-8
73849	Tail Light Lens Repair Kit	G-4
73851	Light Bar	G-14
73852	Light Bar	G-14
73853	Tail Light Assembly	G-2
73854	Tail Light Assembly	G-2
73855	Tail Light Assembly	G-2
73856	Tail Light Assembly	G-2
73857	Tail Light Kit	G-2
73858	Tail Light Kit	G-2
73859	Side Marker Light Set	G-14
73862	Side Marker Light / Fog Light Assembly	G-9
73863	Side Marker Light / Fog Light Assembly	G-9
73864	Tail Light Kit	G-7
73867	Tail Light Kit	G-5
73871	Tail Light Assembly	G-7
73873	Side Marker Light	G-11
73874	Side Marker Light	G-11
73877	Side Marker Light	G-11
73878	Side Marker Light	G-11
73881	Side Marker Light	G-10
73882	Side Marker Light	G-10
73883	Tail Light Kit	G-6
73884	Tail Light Assembly	G-3
73885	Tail Light Assembly	G-3
73886	Reflector Assembly	G-18
73887	Reflector Assembly	G-18
73888	Reflector Assembly	G-18
73890	License Light Bulb	G-15
73894	Dome Light	G-15
74006	Hitch Ball - Packaged	B-3
74008	Hitch Ball - Packaged	B-27
74020	Hitch Ball - Packaged	B-3
7402136	Class IV Trailer Hitch Ball	B-3
74024	Hitch Ball - Packaged	B-27
74026	Hitch Ball - Packaged	B-3
74040	Pole Tongue Coupler	F-5
74042	Pole Tongue Coupler	F-5
74051	Wiring Kit	C-7
74059	Trailer Hitch Safety Chain	H-3
74115	Pintle Hook Combination	B-13
74116	Pintle Hook Combination	B-13



PART NO.	DESCRIPTION	PAGE NUMBER
74117	Pintle Hook Combination	B-13
74118	Pintle Hook	B-14
74119	Pintle Hook	B-14
74123	4-Flat Connector - Car End	C-7
74124	4-Flat Connector - Trailer End	C-7
74125	4-Flat Connector - Loop	C-8
74126	7-Way Connector - Car End	C-12
74127	7-Way Connector - Trailer End	C-12
74128	Mounting Bracket	C-15
74129	6-Way Connector - Car End	C-10
74130	6-Way Connector - Trailer End	C-10
74131	4-Way Round Connectors	C-9
74132	Mounting Bracket	C-15
74176	Trailer Wheel Bearing Protector	H-4
74177	Trailer Wheel Bearing Protector	H-4
74183	Prewired Adapter	C-10
74184	Prewired Adapter	C-13
74247	Spare Tire Carrier	H-4
74280	Pole Tongue Coupler	F-5
74281	Pintle Hook Mounting Plate	B-14
74294	Hitch Ball - Packaged	B-3
74307	Class III Trailer Hitch Ball	B-4
74308	Class IV Trailer Hitch Ball	B-4
74309	Class IV Trailer Hitch Ball	B-4
74326	Trailer Jack Caster	F-2, F-4
74329	Trailer Winch	F-6
74337	Trailer Winch	F-6
74338	Trailer Coupler	F-5
74342	Trailer Hitch Ball Wrench	B-26
74344	Tow Bar - Adjustable	H-4
74377	Trailer Brake Control - Timed	D-5
74378	Trailer Brake Control - Timed	D-4
74407	A-Frame Trailer Jack	F-2
74410	Marine and Recreational Jacks	F-2
74412	Marine and Recreational Jacks	F-2
74413	Marine and Recreational Jacks	F-2
74414	Marine and Recreational Jacks	F-2
74415	Marine and Recreational Jacks	F-2
74418	Trailer Winch	F-6
74437	Trailer Brake Control Harness	D-6
74438	Trailer Brake Control Harness	D-6
74439	Trailer Brake Control Harness	D-6
74514	Receiver Tube Cover	B-25
7452700	Loading Ramp - Arched	E-10
74529	Trailer Winch	F-6
7453700	Loading Ramp - Standard	E-12
7454000	Loading Ramp - Center Fold	E-13
7454300	Loading Ramp - Center Fold	E-10
7454500	Loading Ramp - Heavy Duty	E-10
7454600	Loading Ramp	E-12
7454700	Loading Ramp - Tri-Fold	E-10
7455000	Loading Ramp	E-14
74556	Trailer Winch	F-6
74605	Plug to Plug Adapter	C-19
74606	Trailer Connector Adapter - 4 to 4-Flat	C-19
74607	Trailer Connector Adapter - 7 to 4-Flat	C-19
74608	6-Way Connector - Car & Trailer End	C-10
74611	4-Way Round Connectors	C-9
74613	4-Way Round Connectors	C-9
74633	4-Way Circuit Tester	C-16
74636	4-Flat Connector - Loop	C-8
74641	Storage Box	C-16
74642	Trailer Brake Control - Timed	D-4
74645	Plug to Plug Adapter	C-19
74676	4-Flat Connector Harness - Trailer End	C-8
74679	Trailer Connector Adapter - 7 to 7-Way	C-19
74681	Trailer Connector Adapter - 7 to 12v	C-19
74682	Tow Harness Wiring Package	C-3, C-12
74684	4-Flat Connector Harness - Loop	C-8
74685	Trailer Connector Adapter - 7 to 4-Flat	C-19
74686	Trailer Connector Adapter - 7 to 4-Flat	C-18
74687	4-Flat Connector Harness - Loop	C-8

PART NO.	DESCRIPTION	PAGE NUMBER
74689	4-Flat Connector Harness - Loop	C-8
74783	Trailer Coupler	F-5
7479636	Trailer Coupler	F-5
7479736	Trailer Coupler	F-5
77993	Insta-Hitch™ I	A-2
77994	Insta-Hitch™ I	A-2
77995	Insta-Hitch™ I	A-2
78007	Trailer Connector Adapter - 7 to 4-Flat	C-18
78050	Trailer Brake Control Harness	D-6
78051	Trailer Brake Control Harness	D-6
78052	Trailer Brake Control Harness	D-6
78053	Trailer Brake Control Harness	D-6
78054	Trailer Brake Control Harness	D-6
78055	Trailer Brake Control Harness	D-6
78056	Trailer Brake Control Harness	D-6
78057	Trailer Brake Control Harness	D-6
78058	4-Flat Connector Harness - Vehicle End	C-7
78059	Trailer Brake Control Harness	D-6
78060	Trailer Brake Control Harness	D-6
78082	4-Flat Connector Harness - Trailer End	C-8
78090	4-Flat Connector Harness - Vehicle End	C-7
78091	4-Flat Connector Harness - Loop	C-8
78096	Towing Electrical Mount Bracket	C-15
78103	Wiring Kit	C-6
78114	4-Flat Connector Harness - Vehicle End	C-7
78115	4-Flat Connector Harness - Trailer End	C-7
78116	Trailer Connector Adapter - 7 to 4-Flat	C-17
78117	Trailer Connector Adapter - 7 to 4-Flat	C-17
78118	Trailer Connector Adapter - 7 to 5-Flat	C-17
78119	Trailer Connector Adapter - 7 to 5-Flat	C-18
78124	Trailer Brake Control Harness	D-6
80305	Trailer Hitch Extension	B-12
80306	Trailer Hitch Extension	B-12
80307	Trailer Hitch Extension	B-12
8040900	Clevis Trailer Hitch Ball Mount	B-16
81378	Class II Step Bumper Trailer Hitch	A-5
84326	Step Bumper Receiver	A-2
84328	Professional Receiver	A-2
84332	Professional Receiver	A-2
84333	Professional Receiver	A-2
84336	Professional Receiver	A-2
84420	Professional Receiver	A-2
85060	Brake Control Wiring Kit	D-5
85062	Breakaway System	C-14, H-2
8506300	Breakaway System	C-14, H-2
85064	Trailer Brake Control Harness	D-6
85065†	Trailer Brake Control - Proportional	D-11
85066	Trailer Brake Control Harness	D-6
85067	Trailer Brake Control Harness	D-6
85067	Trailer Brake Control Harness	D-6
8506300	Breakaway System	C-14, H-2
8506911	Brake Control Wiring Kit	D-5
8507111	Trailer Brake Control - Timed	D-4
8507311	Breakaway System	C-14, H-2
8507400	Trailer Brake Control Harness	D-6
8507500	Trailer Brake Control Harness	D-6
8507600	Trailer Brake Control Harness	D-11
8507700	Trailer Brake Control Harness	D-11
8507800	Trailer Brake Control Harness	D-6
8507900	Taillight Converter	C-5
8508211	Trailer Brake Control - Proportional	D-3
85083	Trailer Brake Control Harness	D-6
8508400	Trailer Brake Control Harness	D-6
8508700	Trailer Brake Control - Proportional	D-5
8509000	Trailer Brake Control Harness	D-6
85100	Brake Control Wiring Kit	D-6
85131	Brake Control Wiring Kit	D-6
85132	Brake Control Wiring Kit	D-6
85133	Brake Control Wiring Kit	D-6
85137	Brake Control Wiring Kit	D-6
85205	Wire	C-16
85206	4-Way Round Connectors	C-9

# PRODUCT INDEX

PART NO.	DESCRIPTION	PAGE NUMBER
85208	2-Flat Connector Harness	C-16
85209	7-Way Connector - Car & Trailer End	C-13
85211	4-Flat Connector - Car End	C-8
85212	Plug to Plug Adapter	C-19
85213	5-Flat Connector - Car End	C-9
85214	5-Flat Connector Harness - Trailer End	C-9
85215	5-Flat Connector - Loop	C-9
85216	Plug to Plug Adapter	C-19
85217	4-Flat Connector - Car End	C-7
85218	4-Flat Cover	C-16
85219	7-Way Connector - Car End	C-11
85232	Plug to Plug Adapter	C-19
85275	4-Flat Connector - Trailer End	C-7
85277	4-Flat Connector - Loop	C-7
85281	Mounting Bracket (2 of 2)	C-15
85282	Mounting Bracket (2 of 2)	C-15
85283	Mounting Bracket (2 of 2)	C-15
85285	Mounting Box	C-15
85307	4-Flat Connector - Loop	C-8
85340	Trailer Brake Control Harness	D-6
85342	Trailer Connector Adapter - 7 to 6-Way	C-9
85343	Trailer Connector Adapter - 7 to 4-Flat	C-13
85350	Trailer Connector Adapter - 7 to 6-Way	C-18
85353	4-Flat Connector Harness - Trailer End	C-7
85355	Trailer Wire Circuit Tester	C-16
85357	Trailer Connector Adapter - 6 to 4-Flat	C-17
85360	Trailer Connector Adapter - 7 to 5-Flat	C-18
8536200	Trailer Connector Adapter - 7 to 6-Way	C-19
8536511	7-Way Connector - Vehicle End	C-12
8536700	Trailer Connector Adapter - 7 to 4-Flat	C-19
8536800	Trailer Connector Adapter - 7 to 4-Flat	C-19
8536900	Trailer Connector Adapter - 6 to 4-Flat	C-19
85475	7-Way Connector - Vehicle End	C-11
85476	6-Way Connector - Vehicle End	C-10
85477	6-Way Connector - Trailer End	C-10
85478	7-Way Connector - Trailer End	C-11
85479	6-Way Connector Harness Kit	C-10
85484	Trailer Wire Circuit Tester	C-16
85489	Quick Splice Terminal	C-16
8549100	7-Way Connector Harness - Trailer End	C-13
8549411	7-Way Connector - Trailer End	C-13
8549711	7-Way Connector - Vehicle End	C-13
8550111	7-Way Connector - Vehicle End	C-11
8550511	4-Flat Connector Harness - Vehicle End	C-7
8550811	4-Flat Connector Harness - Trailer End	C-7, C-8
8550900	Tow Harness Wiring Package	C-3, C-12
8551000	Tow Harness Wiring Package	C-3, C-12
8551111	Trailer Connector Adapter - 7 to 5-Flat	C-9
8551200	Trailer Light Power Module	C-5
8551300	Trailer Light Power Module	C-5
8551400	Trailer Light Power Module	C-6
8551511	7-Way Connector - Vehicle End	C-11
8551700	4-Flat Connector Harness - Trailer End	C-7
8552200	4-Flat Connector - Loop	C-8
8552500	4-Flat Connector - Trailer End	C-8
8552600	4-Flat Connector - Loop	C-8
86006	Tail Light Kit	G-2
86009	Side Marker Light / Fog Light Assembly	G-13
86010	Reflector Assembly	G-18
86011	Reflector Assembly	G-18
86012	ID Light Bar	G-14
86013	License Light Bulb	G-15
86014	Tail Light Kit	G-3
86015	Side Marker Light Reflector	G-8
86019	ID Light Bar	G-14
86024	Auxiliary Light	G-17
86025	Auxiliary Light	G-17
86027	Conspicuity Reflectors	G-18
86028	Conspicuity Reflectors	G-18
86035	Tail Light Kit	G-3
86036	Tail Light Kit	G-3
86037	Tail Light Assembly	G-2

PART NO.	DESCRIPTION	PAGE NUMBER
86038	Tail Light Assembly	G-2
86040	Tail Light Kit	G-7
86042	Side Marker Light / Fog Light Assembly	G-11
86043	Side Marker Light / Fog Light Assembly	G-11
86046	Tail Light Assembly	G-3
8604900	Side Marker Light	G-13
86052	Side Marker Light	G-10
86053	Side Marker Light	G-10
86054	Tail Light Assembly	G-5
86055	Tail Light Assembly	G-5
86056	Tail Light Assembly	G-3
86061	Trailer Hitch Tube Cover	B-25, G-19
86062	Trailer Hitch Tube Cover	B-25, G-19
86063	Reflective Conspicuity Tape	G-18
86065	Trailer Hitch Tube Cover	B-25, G-19
86066	Trailer Hitch Tube Cover	B-25, G-19
86078	Back Up Light Set	G-3
8608200	Side Marker Light	G-13
8608500	Side Marker Light	G-9
8608600	Side Marker Light	G-9
8608711	Side Marker Light Reflector	G-8
8608900	Side Marker Light	G-14
8609000	Strobe Light Kit	G-20
8609244	Tailgate Lighted Emblem	G-21
8609344	Tailgate Lighted Emblem	G-21
8609444	Tailgate Lighted Emblem	G-21
8609600	Strobe Light Kit	G-20
8609700	Utility Light	G-16
8609800	Utility Light	G-16
8609900	Pedestal Mount Taillight	G-7
8610000	Pedestal Mount Taillight	G-7
8610100	Parking / Clearance Light Assembly	G-9
8610200	Parking / Clearance Light Assembly	G-9
8610300	Parking / Clearance Light Assembly	G-9
8610400	Multi Purpose Light Bulb	G-20
8610600	Multi Purpose Light Bulb	G-20
8610700	Multi Purpose Light Bulb	G-20
8610911	Tail Light Assembly	G-3
8611100	Worklight	G-16
8611200	Worklight	G-16
8612000	Tail Light Assembly	G-20
86523	Trailer Hitch Tube Cover	B-25, G-19
86529	Trailer Hitch Tube Cover	B-25, G-19
86530	Trailer Hitch Tube Cover	B-25, G-19
86531	Trailer Hitch Tube Cover	B-25, G-19
86532	Trailer Hitch Tube Cover	B-25, G-19
86618	Tailgate Lighted Emblem	G-19
86619	Tailgate Lighted Emblem	G-19
86620	Tailgate Lighted Emblem	G-19
8692000	4-Flat Connector - Trailer End	C-16
902501	Trailer Brake Control - Proportional	D-11
902502	Brake Control	D-2
90255	Hand Held Remote	D-2
9030C	Trailer Brake Control - Proportional	D-3
90885C	Trailer Brake Control - Proportional	D-3
90920	Brake Control	D-2
9420800	Anchor Tie Down	E-21
9424000	Trunk Organizer Storage Net	E-16
9424100	Bungee Cargo Net	E-6
9424200	Bungee Cargo Net	E-6
9424700	Cambuckle Tie Down Strap	E-17
9425300	Ratchet Tie Down Strap	E-18
9425900	Ratchet Tie Down Strap	E-18
9426001	Ratchet Tie Down Strap	E-18
9426200	Ratchet Tie Down Strap	E-18
9426300	Tow Strap with Hooks	E-22
9426400	Tow Strap with Loops	E-22
9426500	Tow Strap with Hooks	E-22
9427100	Bungee Cargo Net	E-6
9427200	Bungee Cargo Net	E-6
9427300	Ratchet Tie Down Strap	E-18
9428900	Bungee Cord	E-20

PART NO.	DESCRIPTION	PAGE NUMBER
9429000	Bungee Cord	E-22
9429300	Tie Down Tarp Strap	E-21
9429700	Ratchet Tie Down Strap	E-18
9429800	Anchor Tie Down	E-21
9436100	Bungee Cord	E-20
9481300	Bungee Cord	E-20
9481800	Tie Down Tarp Strap	E-21
9485500	Ratchet Tie Down Strap	E-18
9510500	Ratchet Tie Down Strap	E-18
9511800	Ratchet Tie Down Strap	E-18
9514600	Ratchet Tie Down Strap	E-19
9515000	Loading Ramp - Arched Center Fold	E-10
9515200	Loading Ramp - Center Fold	E-13
9515300	Loading Ramp - Telescoping	E-12
9515400	Loading Ramp - Extruded	E-11
9515500	Loading Ramp - Straight	E-10
9515600	Loading Ramp - Straight Extruded	E-11
9515700	Loading Ramp - Center Fold	E-11
9515800	Loading Ramp - Arched	E-11
9515900	Loading Ramp - Arched Center Fold	E-11
9516000	Loading Ramp - Straight Extruded	E-13
9516400	Loading Ramp - Arched	E-11
9517100	Loading Ramp - Standard	E-14
9517300	Loading Ramp - Standard	E-14
9517500	Loading Ramp - Adjustable	E-14
9517700	Loading Ramp - Adjustable	E-14
9517800	Loading Ramp Kits	E-9
9518000	Loading Ramp Carrying Handle	E-15
9518200	Loading Ramp Security Strap	E-15
9518300	Loading Ramp Carrying Strap	E-15
9521000	Ratchet Tie Down Strap	E-18
9521400	Ratchet Tie Down Strap	E-18
9523500	Ratchet Tie Down Strap	E-23
9523600	Tie Down Anchor	E-23
9523700	Tie Down Anchor	E-23
9524200	Tie Down Tarp Strap	E-21
9524600	Tie Down Tarp Strap	E-21
9524900	Tie Down Tarp Strap	E-21
9526900	Cable Tie	E-21
9528000	Bungee Cord	E-20
9528200	Bungee Cord	E-20
9531500	Bungee Cord	E-20
9532100	Bungee Cord - Fat Strap	E-20
9533700	Tow Strap with Hooks	E-22
9535000	E-Track	E-23
9535100	E-Track	E-23
9535200	E-Track	E-23
9535300	Tie Down Anchor	E-23
9535400	Tie Down Anchor	E-23
9535700	Ratchet Tie Down Strap	E-23
9535900	Ratchet Tie Down Strap	E-23
9544600	Ratchet Tie Down Strap	E-22
9544900	Ratchet Tie Down Strap	E-22
9545400	Trailer Winch Strap	E-20
9545500	Trailer Winch Strap	E-20
9547800	Cambuckle Tie Down Strap	E-18
9548300	Toggle Balls	E-21
9549000	Tie Down Anchor	E-22
9549100	Tie Down Anchor	E-22
9549400	Tie Down Anchor	E-21
9560100	Ratchet Tie Down Strap	E-18
E338050303	A-Frame Trailer Coupler	F-5
E438050303	A-Frame Trailer Coupler	F-5
PD110101	POD Hazard	G-17, H-5
PD110200	POD Hazard	G-17, H-5
PD110302	POD Hazard	G-17, H-5
PD110700	POD Hazard	G-17, H-5

# **REESE**TOWPOWER

Whether you're hauling lumber and bricks to a job site or loading up your snowmobile and heading for the mountains, REESE® Towpower has a diverse line of towing products to safely get you where you're going. We cater to the towing needs of everyone from recreation enthusiasts to heavy-duty agriculture users. We manufacture the largest selection of receiver hitches, ball mounts and hitch balls, trailer and hitch locks, couplers, jacks and winches, and electrical and lighting components that meet and exceed industry standards.

At REESE® Towpower, we continue to innovate new ways to help you transport your gear more efficiently and more safely. This dedication to superior quality is what sets us apart from the competition ... and what has made us the number one brand in the towing industry for decades.

