



RB100-HP

Voltage: 12.8V | Capacity: 100 Ah | Energy: 1280 Wh | Group: 31

LITHIUM IRON PHOSPHATE BATTERY **LiFePO₄**

ELECTRICAL SPECIFICATIONS

Nominal Voltage	12.8 V
Nominal Capacity	100 Ah
Reserve Capacity @ 25 A	240 min
Resistance	≤30 mΩ @ 50% SOC
Efficiency	99%
Self Discharge	<3% per Month
Maximum Batteries Connected in Series	1 (Single Battery Only)

DISCHARGE SPECIFICATIONS

Maximum Continuous Discharge Current	100 A
Maximum Discharge Current	800 Amps
Lithium Marine Cranking Amp (MCA)	Up to 800 Amps for 8 seconds @ 20°F (-6.7°C)
Discharge Over-Current Protection	1000 A ±100 A (2.2 ±1 ms)
Recommended Low Voltage Disconnect	11.0 V
Discharge Under-Voltage Protection	9.2 V (2.3 ±0.08 vpc) (4.2 ±0.5 s)
Reconnect Voltage	10.0 V (2.5 ±0.1 vpc)
Short Circuit Protection Response Time	200-600 μs

TEMPERATURE SPECIFICATIONS

Discharge Temperature	-4 to 140°F (-20 to 60°C)
Charge Temperature*	-4 to 130°F (-20 to 55°C)
Recommended Storage Temperature	23 to 95 °F (-5 to 35°C)
BMS High Temperature Cut-Off	176 °F (80°C)
Reconnect Temperature	122 °F (50°C)

*Refer to charge currents below 32°F (0°C)

MECHANICAL SPECIFICATIONS

Dimensions (L x W x H)	13 x 6.8 x 8.4" 329 x 172 x 214 mm
Weight	29.8 lbs (13.5 kg)
Terminal Type	M8 x 1.25 x 12mm
Terminal Torque	80 - 100 in-lbs (9 - 11 N-m)
Case Material	ABS
Enclosure Protection	IP67
Cell Type - Chemistry	Cylindrical - LiFePO ₄

CHARGE SPECIFICATIONS

Maximum Continuous Charge Current	5 A - 50 A
Maximum Battery Charger Output	100 Amps
Peak Charge Acceptance	165 Amps for up to 1 minute
Maximum Engine Alternator Size	150 Amps
Maximum Charge Current 14 to 32°F (-10 to 0°C)	<0.1 C (10 Amps)
Maximum Charge Current -4 to 14°F (-20 to -10°C)	<0.05 C (5 Amps)
Recommended Charge Voltage	14.4 - 14.8 V
BMS Charge Voltage Cut-Off	15.4 V (3.85 ±0.025 vpc) (1 ±0.2 s)
Reconnect Voltage	14.6 V (3.65 ±0.05 vpc)
Balancing Voltage	14.4 V (3.6 ±0.025 vpc)

COMPLIANCE SPECIFICATIONS

Certifications	UN 38.3 & CE (battery) UL1642 (cells) (File# MH62098) IEC62133 (cells)
Shipping Classification	UN 3480, CLASS 9

DIMENSIONAL SPECIFICATIONS

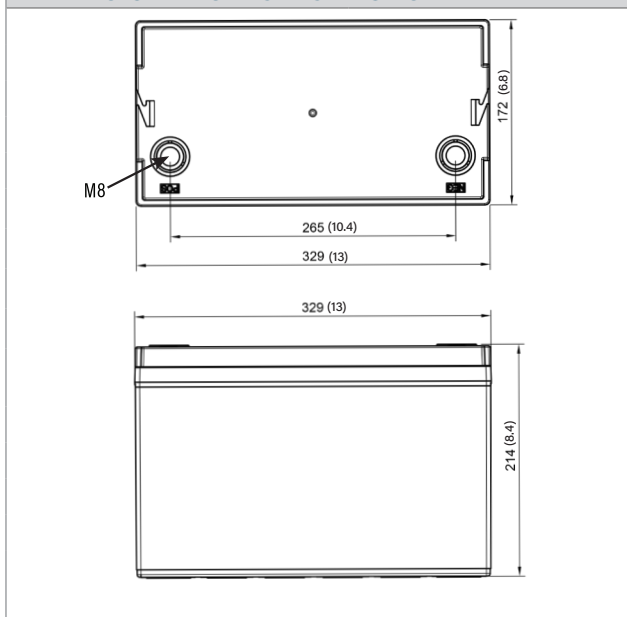



RB100-HP

Voltage: 12.8V | Capacity: 100 Ah | Energy: 1280 Wh | Group: 31

LITHIUM IRON PHOSPHATE BATTERY **LiFePO4**

PERFORMANCE CHARACTERISTICS

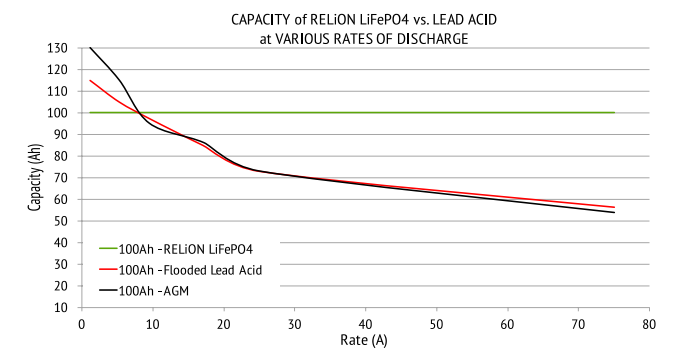
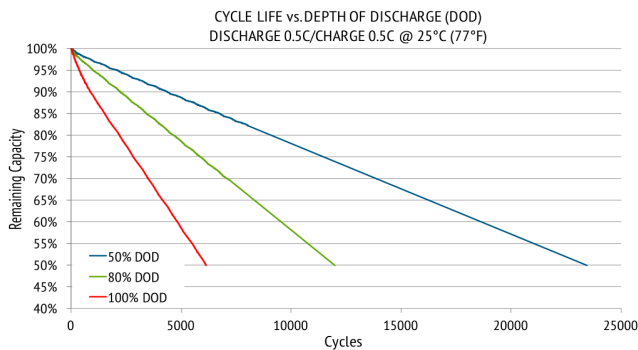
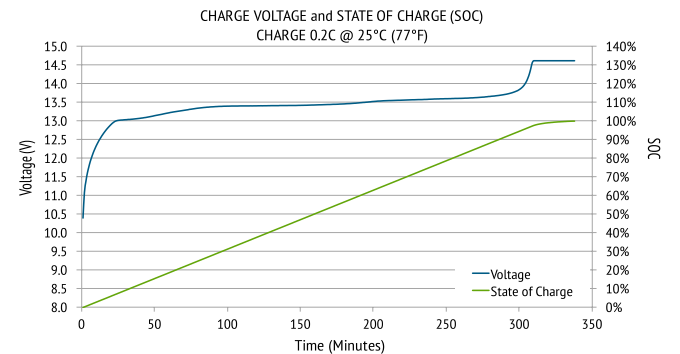
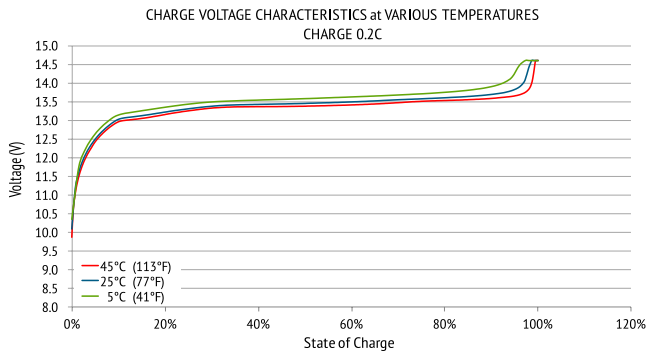
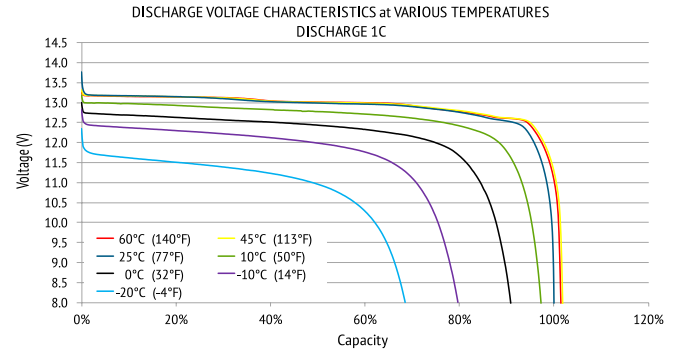
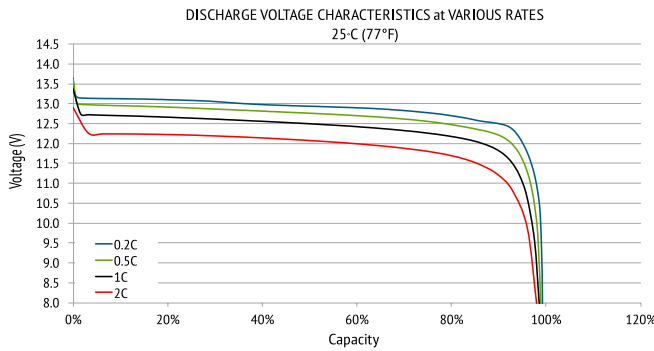

reliombattery.com

+1.803.547.7288 • TOLL FREE: (855) 931-2466 | 1433 Dave Lyle Blvd • Rock Hill, SC 29730

UN38.3

