



# PRODUCT CATALOG

Over 20 years of innovation in design and manufacturing inspired by a vision to make every experience on the water unforgettable.





THE ORIGATION OF EVERY ROSWELL PRODUCT IS A MOMENT ON THE WATER THAT WE BELIEVED COULD BE MADE EVEN BETTER.

EACH NEW DESIGN IS DRIVEN BY THE SAME PASSION PEOPLE AROUND THE WORLD CHASE TO LAKES, RIVERS, AND OCEANS TO CREATE EXPERIENCES THAT DEFINE THEM.

THOSE EXPERIENCES HAVE INSPIRED 20 YEARS OF INNOVATION, FORMING OUR DNA OUT OF A VISION THAT HAS SEEN HUMBLE BEGINNINGS BECOME SOMETHING SO MUCH MORE THAN THE PRODUCTS WE BUILD.

ROSWELL IS A MOVEMENT THAT MARCHES FORWARD WITHOUT COMPROMISE TO MAKE EVERY SECOND ON THE WATER UNFORGETTABLE.





# ROSWELL.

MADE IN THE AMERICAS.

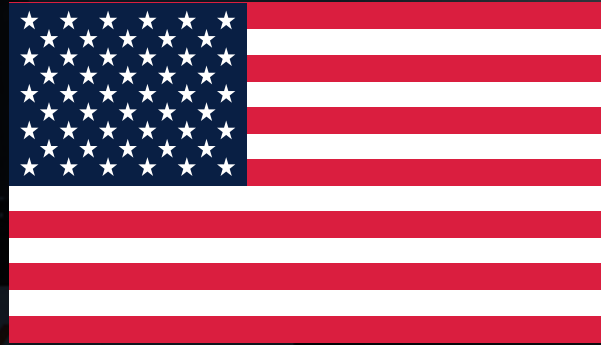

Partnering with the world's leading boat builders, Roswell Marine has become a stamp of excellence and a proven solution for premium marine audio, towers, board racks, lighting and accessories featured on boats that set the highest standard in the industry.

Stepping through the doors of Roswell Global headquarters in Rockledge, Florida, our progressive vision consumes you at every corner. Modern workspaces flow into a state-of-the-art manufacturing facility with capabilities that maintain our culture of endless possibilities with a continuous look into the future. Our expanding operations in the USA include everything from distribution to all major product fabrication, paint, assembly, CNC, and beyond.

Throughout our facilities we can do MIG and TIG welding, pipe bending, and metal extrusions, along with deep drawing and die casting in addition to rotational and injection molding. Among our many finish options we offer anodizing, custom paint, and chemfilm treatment. Our 3 and 5-axis Mazak CNC machines and PALLETECH Automation System have enhanced our ability to manage large and speedy fulfillments with lights out operation. A mantra of innovation and quality without compromise drives a united and committed team that gives product transformation from concept to completion an entirely new meaning.

## ROSWELL OEM PARTNERS

**NAUTIQUE**

**CENTURION**

**MOOMBA**

**BENNINGTON**

**CHAPARRAL  
BOATS**

**MONTEREY  
BOATS**

**COBALT BOATS**



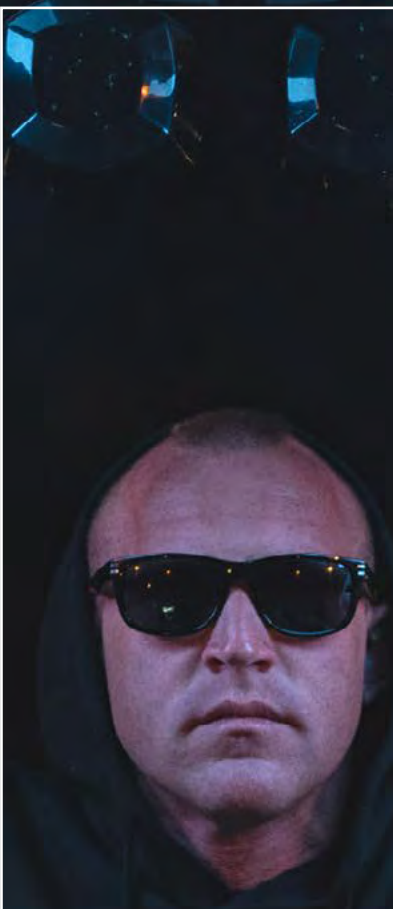
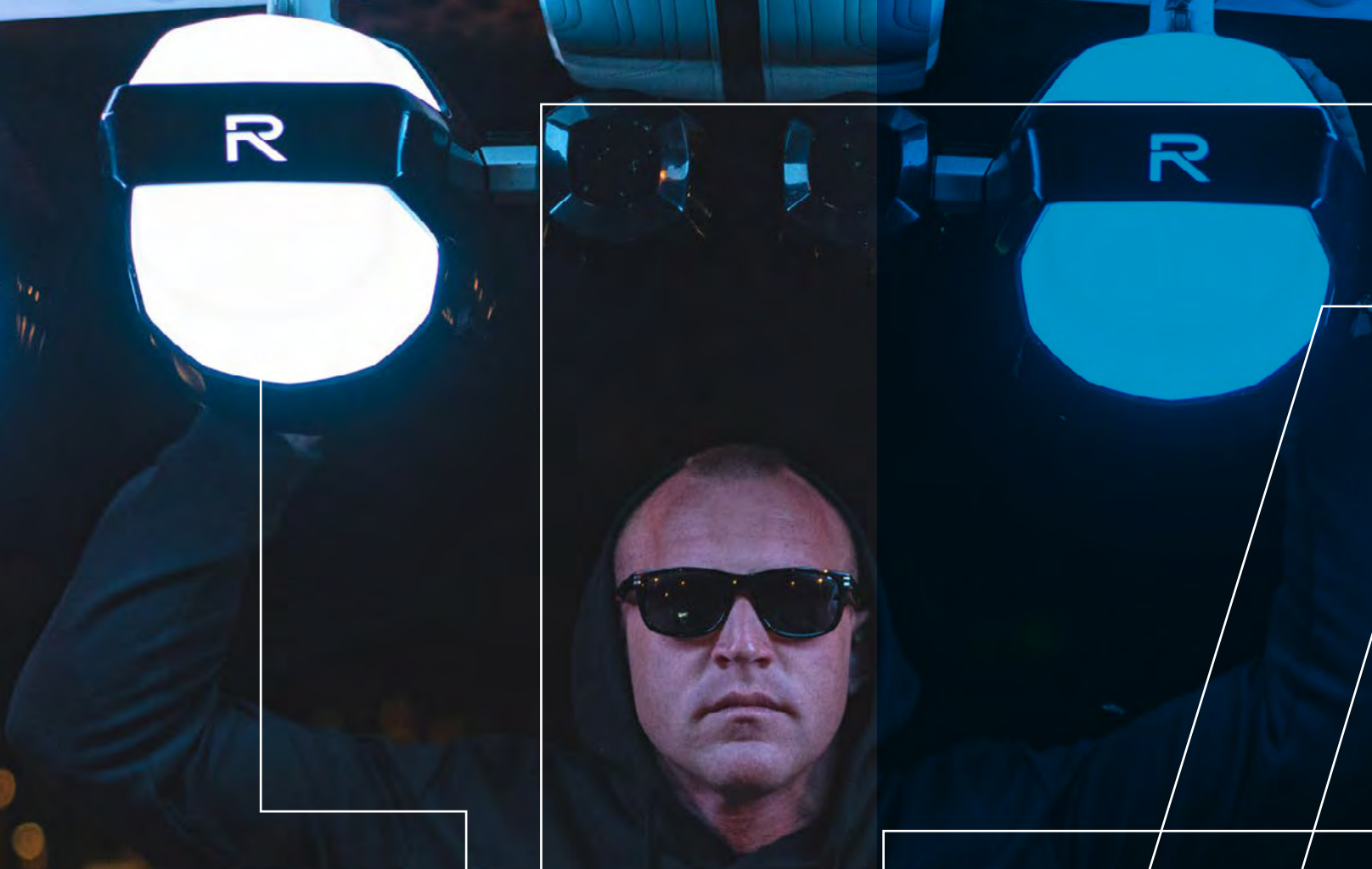

# ROSWELL

## RIDERS

- Rusty Malinoski
- David O'Caomh
- Cory Teunissen
- Hudson Haynie
- Jimmy LaRiche
- Shawn Watson
- Grant Korgan
- Ashley Kidd
- Ryan Dodd
- Zahra Kell





# ROSWELL, 2020 PRODUCTS

WE AT ROSWELL ENJOY SHARING OUR PASSION FOR WATER SPORTS AND OUR VISION FOR UNFORGETTABLE ON-WATER EXPERIENCES. WE'VE POURED OUR BLOOD, SWEAT, AND TEARS INTO THIS YEAR'S OFFERING, AND WE'RE PROUD TO INTRODUCE ROSWELL'S PRODUCT LINEUP! LET ROSWELL BRING YOU THE BEST PRODUCT AND CUSTOMER EXPERIENCE TO DATE.



# AVIATOR PRO



# AVIATOR



Adjustable Telescoping center section.

Built-in mounting blocks for swivel board racks and fixed racks.

Patented cam latch & weight-assist system.

OEM style foot mount



Adjustable Telescoping center section with mounting location for Roswell Anchor Light

Built-in mounting blocks for swivel board racks and fixed racks.

Patented cam latch & weight-assist system.

Billet aluminum feet and 316 stainless steel mounting hardware.



## AVAILABLE OPTIONS:

- **C910-3116** (Narrow - White)
- **C910-3117** (Narrow - Black)
- **C910-3112** (Wide - White)
- **C910-3113** (Wide - Black)
- **B931-1003** (Custom Paint: Single Color)
- **B931-1003S** (Custom Paint: Specialty Color)

## SPECIFICATIONS

<b>Mounting Hardware:</b>	316 stainless steel
<b>Tower Tubing Size:</b>	2.375 inches   6.03 cm
<b>Center Section Tubing Size:</b>	3 inches   7.62 cm
<b>Narrow Tower Width:</b>	80 - 92 inches   203.2 - 233.68 cm
<b>Wide Tower Width:</b>	86 - 104 inches   218.44 - 264.16 cm
<b>Tower Materials:</b>	T5 6061 aluminum   SCHED 40

## AVAILABLE OPTIONS:

- **C910-3150** (Narrow - White)
- **C910-3151** (Narrow - Black)
- **C910-3108** (Wide - White)
- **C910-3109** (Wide - Black)
- **B931-1003** (Custom Paint: Single Color)
- **B931-1003S** (Custom Paint: Specialty Color)

## SPECIFICATIONS

<b>Mounting Hardware:</b>	316 stainless steel
<b>Tower Tubing Size:</b>	2.375 inches   6.03 cm
<b>Center Section Tubing Size:</b>	3 inches   7.62 cm
<b>Narrow Tower Width:</b>	80 - 92 inches   203.2 - 233.68 cm
<b>Wide Tower Width:</b>	86 - 104 inches   218.44 - 264.16 cm
<b>Tower Materials:</b>	T5 6061 aluminum   SCHED 40

## FEATURES

- Designed to work with Aviator Soft Top
- Telescoping center section with brushed anodized finish
- Roswell USCG approved Anchor Light included
- Pre-wired for lights and speakers
- Forward folding universal tower

### UPGRADE: AVIATOR PRO 4.5" RISERS

- **C710-0094**(Black)
- **C710-0095**(White)



Our Aviator Pro Wake Tower Riser is designed to give you 4.5 inches of more headroom in the boat so you can fit more Roswell Tower Speakers!

## FEATURES

- Designed to work with Aviator Soft Top
- Brushed anodized telescoping center section finish
- Universal low-profile mounting system
- Pre-wired for lights and speakers
- Forward folding universal tower

### UPGRADE: R1 PRO TOWER SPEAKERS

- **C920-1910**

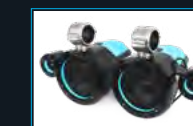

Experience a new age of audio with the revolutionary patent-pending R1 Pro Tower Speakers and command your senses of sight and sound with unmatched acoustic clarity.



# CAM RT



# AREA 53



- Adjustable Telescoping center section with mounting location for Roswell Anchor Light
- Built-in mounting blocks for (1) pair of R 6.5" or Classic Unison Tower Speakers
- Built-in mounting blocks for swivel or fixed board racks
- Patented cam latch system
- Billet aluminum feet and 316 stainless steel mounting hardware



- Adjustable Telescoping center section with mounting tab for Roswell Anchor Light
- Built-in mounting blocks for fixed board racks
- Optionally folds forward
- Optionally folds backward



## AVAILABLE OPTIONS:

- C910-3120** (Narrow - Brushed/Anodized)
- C910-3121** (Narrow - Black)
- C910-3130** (Wide - Brushed/Anodized)
- C910-3131** (Wide - Black)
- **B931-1003** (Custom Paint: Single Color)
- **B931-1003S** (Custom Paint: Specialty Color)

## SPECIFICATIONS

- Mounting Hardware:** 316 stainless steel
- Tower Tubing Size:** 1.9 inches | 4.83 cm
- Center Section Tubing Size:** 2.375 inches | 6.03 cm
- Narrow Tower Width:** 78 - 92 inches | 198.12 - 233.68 cm
- Wide Tower Width:** 90 - 104 inches | 228.6 - 264.16 cm
- Tower Materials:** T5 6061 aluminum | SCHED 40

## AVAILABLE OPTIONS:

- C910-1700** (Brushed/Anodized)
- C910-1701** (Black)
- **B931-1003** (Custom Paint: Single Color)
- **B931-1003S** (Custom Paint: Specialty Color)

## SPECIFICATIONS

- Mounting Hardware:** 316 stainless steel
- Tower Tubing Size:** 2.375 inches | 6.03 cm
- Center Section Tubing Size:** 3 inches | 7.62 cm
- Tower Width:** 76 - 102 inches | 193.04 - 259.08 cm
- Tower Materials:** T5 6061 aluminum | SCHED 40

## FEATURES

- Modular forward folding universal tower
- Pull strings for routing audio/12V wiring
- Simplified low-profile mounting system
- Designed to work with Sun Top Bimini
- Saltwater friendly (*Brushed Anodized*)

### UPGRADE: TRITON STRAPLESS BOARD RACK

#### C910-1730



Our Patented Triton Strapless Board Rack's telescopic arms can be adjusted to have smaller or larger gaps to account for width changes of kids wakeboards vs. large surfboards.

## FEATURES

- All new super lightweight design (*approximately 50lbs*)
- Easy to fold (*can be setup to fold forwards or backwards*)
- Pull strings for routing audio/12V wiring
- Designed to work with Area 53 Bimini
- Top mount or side mount

### UPGRADE: R6.5" TOWER SPEAKERS

#### C920-1902



When versatility called the all-new Roswell R 6.5 answered. Featuring a Mylar tweeter and integrated RGB LEDs. This speaker looks as good as it sounds in any setting.



# TOWER DIMENSIONS

Aviator Pro



Aviator

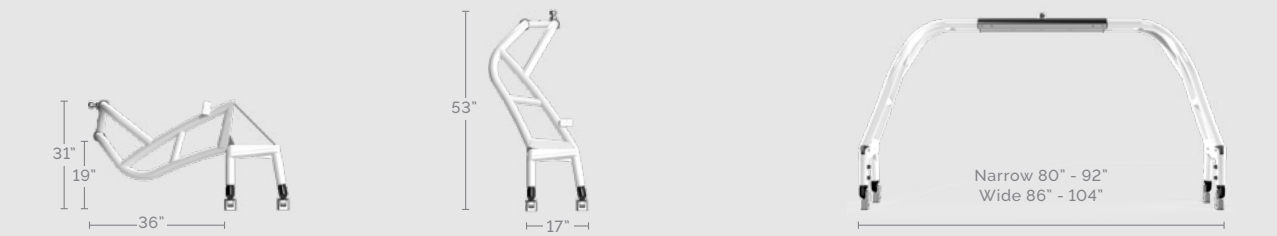

CAM RT

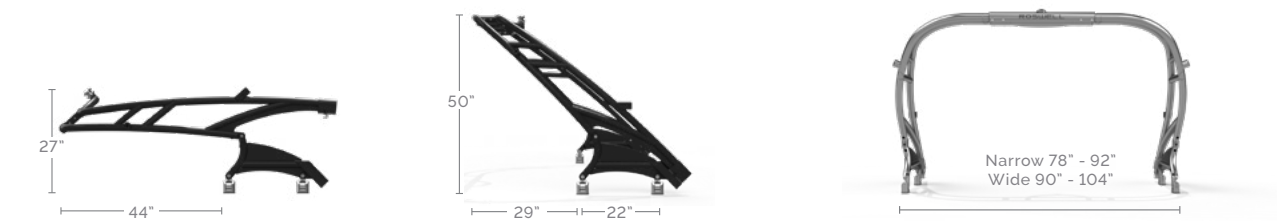

Area 53

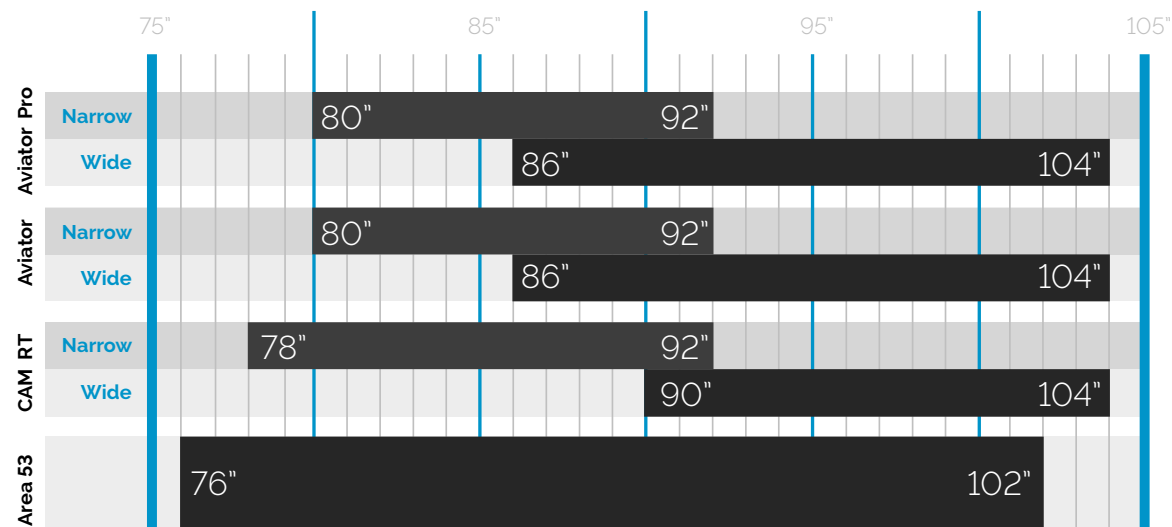
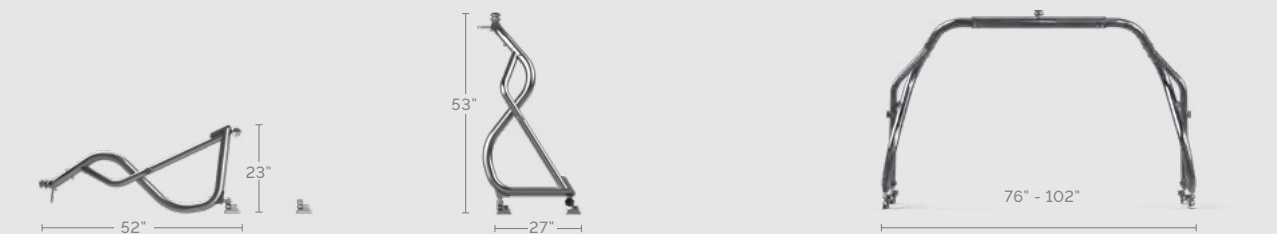

# BIMINIS

## AVIATOR SOFT TOP

C910-2025 (Narrow)  
C910-2026 (Wide)

- 69" coverage length
- Brushed anodized aluminum frame
- Easily collapsible and stored on tower
- 316 stainless steel hardware
- Storage boot included
- Narrow bimini works with tower widths 80"-90"
- Wide bimini works with tower widths 90"-104"
- Compatible with Aviator Tower



## SUN TOP

C910-2027 (Narrow)  
C910-2028 (Wide)

- 64" coverage length
- Brushed anodized aluminum frame
- Easily collapsible and stored on tower
- 316 stainless hardware
- Built-in storage boot
- Narrow bimini works with tower widths 78"-92"
- Wide bimini works with tower widths 90"-104"
- Compatible with CAM RT and AVX XL towers only



## AREA 53 BIMINI

C910-1740 (Narrow)  
C910-1741 (Wide)

- 50" coverage length
- Brushed anodized aluminum frame
- Easily collapsible and stored on tower
- 316 stainless steel hardware
- Storage boot included
- Narrow bimini works with tower widths 76"- 88"
- Wide bimini works with tower widths 88"- 102"





# TRITON STRAPLESS BOARD RACK C910-1730

The award-winning, patented Roswell Triton has given boards of all shapes and sizes around the world peace of mind knowing that the days of chattering across the water at high speeds are over. Vertical orientation and telescopic grab arms make loading boards a breeze and direct water droplets outside of the boat and away from your head. EVA foam prevents scratches and dings with tine slots large enough for boards up to 2.75" thick. No matter what you do or what they say, once you try this rack you'll never go back.

Designed to provide a secure fit of kid or adult boards of any shape

Telescopic grab arms designed to fit boards at a maximum of 23 inches wide

Durable Sandblasted / Anodized finish

10mm SeaDek® closed-cell EVA foam for ultimate protection of fragile boards

Tine slots accommodate boards up to 2.75 inches thick

Hard duro Thermoplastic polyurethane wakeboard groove

Adjustable telescopic arms can be adjusted on the fly



\* Patented

## FEATURES

- 10mm SeaDek® Protects your fragile hand-shaped surf boards
- Billet aluminum tines & crossbars can hold two surfboards, two wakeboards or one of each
- Stainless steel hardware
- Compatible with all Roswell after-market towers and swivels
- Dual density board protection
- Vertical board orientation allows wet boards to drip outside of your boat
- Board orientation provides improved ergonomics for inserting and removing boards

## SPECIFICATIONS

<b>Tine Spread:</b>	10.0 inches   25.4 cm
<b>Tine Gaps:</b>	2.75 inches   6.98 cm
<b>Max Board Width:</b>	23.0 inches   58.42 cm
<b>Materials:</b>	6061 aluminum   SeaDek® closed cell EVA foam   Hard duro TPU
<b>Mounting Hardware:</b>	316 Stainless Steel

# BOARD RACKS

## OVERMOLDED ELITE SERIES

All overmolded Elite Series racks are saltwater friendly featuring a brushed anodized backing plate with black RWA logo medallion and integrated webbed Bungee Strap with Loop (C710-0105). The overmolded tines offer the most protection in the industry for your equipment.

### ELITE BOARD RACK

C910-2030 (Complete Rack)  
C910-2036 (Tines)



- Holds two wakeboards
- Wakeboard gap: 1.15 inches
- Tine spread: 10 inches
- Saltwater friendly

### ELITE SURF / WAKE

C910-2031 (Complete Rack)  
C910-2037 (Tines)



- Holds one surfboard & one wakeboard
- Surfboard gap: 2.375 inches
- Wakeboard gap: 1.15 inches
- Tine spread: 10 inches
- Saltwater friendly

C910-2038

### ELITE DUAL SURF

C910-2032 (Complete Rack)  
(Tines)



- Holds two surfboards
- Surfboard gap: 2.75 inches
- Tine spread: 10 inches
- Saltwater friendly

### ELITE SURF XL

C910-2035 (Complete Rack)  
C910-2038 (Tines)



- Holds two large style surfboards
- Surfboard gap: 2.75 inches
- Tine spread: 29 inches
- Saltwater friendly

## BRUSHED ANODIZED & CLEAR COAT ELITE SERIES

All other racks feature either a brushed anodized or clear coat finish with black RWA logo medallion and integrated webbed bungee strap with loop. Additional product details are listed below including product function and tine dimensions.



### ELITE SKI

C910-2034 (Complete Rack)  
\*Tines not sold separately

- Holds one pair of water skis
- Water ski gap: 1 inch
- Tine spread: 29 inches
- Brushed clear coated ski tines
- Machined clear coat



### ELITE KNEE / WAKE

C910-2040 (Complete Rack)  
C810-0103 (Tines)

- Holds one kneeboard & one wakeboard
- Kneeboard gap: 5 inches
- Wakeboard gap: 1.15 inches
- Tine spread: 10 inches
- Billet aluminum
- Saltwater friendly



### ELITE KNEEBOARD

C910-2033 (Complete Rack)  
C910-2039 (Tines)

- Holds one kneeboard
- Kneeboard gap: 5 inches
- Tine spread: 10 inches
- Billet aluminum
- Saltwater friendly



BUNGEE W/ LOOP  
C710-0105



BUNGEE W/ CLIP  
C710-0104



ELITE BACKING PLATE  
C810-0101



# TOWER ACCESSORIES

BOARD RACK SWIVELS, CLAMPS, & ADAPTERS



# TOWER ACCESSORIES

MARINE AUDIO CLAMPS, & ADAPTERS



**SI SWIVEL**  
C910-0062

- **3 Locking positions**
- Machined from billet aluminum with a brushed anodized finish
- Easy pull manual locking pin
- Includes adapter plate for Universal Clamp
- Anti-vibration rubber dampener
- To lock or unlock you must compress dampeners
- **Saltwater friendly**



**MAG SWIVEL**  
C910-0049

- **2 Locking positions**
- Machined from billet aluminum with a brushed anodized finish
- When used with clamp, Swivel Clamp Adapter required for level swivel motion
- Swivel Clamp Adapter not required with Roswell Tower Mounting Block
- To lock or unlock you must compress dampeners
- **Saltwater friendly**



**360 ADJUSTABLE RACK ADAPTER**  
C910-20026

- **Includes:** 1x large and 1x small plastic insert
- machined billet aluminum with a sandblasted anodized finish
- 360° of rotational mounting positions
- Fits round & square tubing sizes of 1" to 2.5"
- Compatible with most Roswell products
- **Saltwater friendly**



**360 FLAT MOUNT SPEAKER ADAPTER**  
C920-20025

- Machined from billet aluminum with a brushed clear anodized finish
- **Saltwater friendly**



**ROTATIONAL SPEAKER ADAPTER**  
C820-0900

- Machined from billet aluminum with a sandblast anodized finish
- Mount speakers at desired angle
- Low profile mounting hardware included
- Ask your Authorized Roswell Sales Rep. about adapter compatibility



**FIXED SPEAKER ADAPTERS**

- C820-0901 (Nautique G-Series)
- C820-0902 (Nautique GS-Series)
- C920-0022 (MC Adapter)
- C910-20144 (Supreme F-Series)

- Machined from billet aluminum with a brushed clear anodized finish
- **Saltwater friendly**



**BOARD RACK ADAPTERS**  
C810-0102 (Malibu/Axis)  
C810-0106 (Supra FX One)

- Machined from billet aluminum with a brushed clear anodized finish
- Compatible with Roswell swivels and board racks
- C810-0102 Compatible with: Malibu G3 & G4 Towers, Axis Wakeboard Towers
- C810-0106 Compatible with: Supra FX One Towers
- **Saltwater friendly**



**SWIVEL CLAMP ADAPTER**  
C910-0053

- Machined from billet aluminum with a brushed anodized finish
- Easily level your clamped swivel board rack
- Accurate degrees of rotation
- Compatible with Roswell clamp and swivels
- **Saltwater friendly**



**FIXED TRITON RACK ADAPTER**  
C810-0100

- Machined from billet aluminum with a sandblast anodized finish
- Compatible with all Roswell board racks
- Most cost effective way to mount Triton rack to many Roswell towers
- **Saltwater friendly**



**360° 3" UNIVERSAL CLAMP**  
C920-0747

- **Includes:** 1.9, 2.375", 3" plastic inserts
- **Available for purchase:** 2", 2.25", 2.5", 2.85" plastic inserts
- Machined from billet aluminum with a sandblasted clear anodized finish
- Compatible with most Roswell Tower Speakers
- External set screws allow for 360° rotational mounting positions
- **Saltwater friendly**



**3" UNIVERSAL CLAMP**  
C910-0047

- **Includes:** 1.9, 2.375", 3" plastic inserts
- **Available for purchase:** 2", 2.25", 2.5", 2.85" plastic inserts
- Machined from billet aluminum with a sandblasted clear anodized finish
- Compatible with all Roswell Products
- **Saltwater friendly**



**UNIVERSAL CLAMP**  
C910-0023

- **Includes:** 1.9", 2.375" plastic inserts
- **Available for purchase:** 1.6", 2.0", 2.5" plastic inserts
- Cast aluminum with a brushed clear coated finish
- Compatible with most Roswell products



**3" CLAMP INSERTS**  
C910-0050 (1.9") C910-0051 (2.5")  
C910-0060 (2") C910-0056 (2.85")  
C910-0055 (2.25") B910-0403 (3")  
B910-0401 (2.375")



**3" CLAMP INSERTS**  
C910-0050 (1.9") C910-0051 (2.5")  
C910-0060 (2") C910-0056 (2.85")  
C910-0055 (2.25") B910-0403 (3")  
B910-0401 (2.375")



**UNIVERSAL CLAMP INSERTS**  
C910-0035 (1.6") B710-0404 (2.375")  
B710-0403 (1.9") C910-0037 (2.5")  
C910-0036 (2")



# R1 PRO TOWER SPEAKERS C920-1910

Realizing a dream in developing the perfect blend of power and clarity, the tower speaker has been redefined with the all-new patent-pending Roswell R1 Pro. Matching their masterpiece of sound with a visual symphony created by the world's first RGB LED light-permeable speaker housing, when Roswell set out to shoot for the stars they created one. The R1 Pro is a mission accomplished in delivering the new flagship of the R1 Audio line to introduce an experience that consumes your senses of sight and sound.

**Machined billet** Roswell 360° 3" Universal Clamp with 1.90", 2.375" and 3" adapters

**Deutsch Wiring Harness** included for water-tight connection & easy installation

**\*Industry First:** Patent-pending integrated RGB LED illuminates speaker and translucent housing to create your desired visual atmosphere

**Side-mounted 1" Compression Tweeter** with integrated protection circuit

**Klippel® tested and certified** to guarantee acoustic performance



\* Patented

## SPECIFICATIONS

**Continuous Power (RMS):** 200 Watts  
**Peak Power (RMS):** 400 Watts  
**Sensitivity:** **Woofer:** 95 dB @ 1W/1M  
**Tweeter:** 103 dB @ 1W/1M  
**Freq. Response (±1 dB):** 60Hz - 20 kHz  
**Impedance:** 4Ω

## DIMENSIONS

**Nominal Diameter:** **Speaker:** 8 in | 20.32 cm  
**Tweeter:** 1 in | 2.54 cm  
**Total Width:** 15.48 in | 39.32 cm  
**Total Depth:** 13.35 in | 33.91 cm  
**Hanging Distance:** 12.25 in | 31.12 cm  
(clamp center to lowest point)

# R1 MARINE AUDIO

- **(R1 8") Power:** 100W RMS | 200W PEAK
- **(R1 6.5") Power:** 80W RMS | 160W PEAK
- **(R1 8") Speaker:** R1 8" component-style
- **(R1 6.5") Speaker:** R1 6.5" component-style
- Integrated RGB LED backlight the cone to create your desired visual atmosphere
- Klippel® tested and certified to guarantee acoustic performance
- Deutsch wiring harness included for water-tight connection
- Coaxially mounted 1" silk dome tweeter
- Concealed integrated 12 dB/OCT crossover network
- Locking trim ring conceals all mounting hardware
- **2-Year Warranty**
- **Extreme saltwater and UV resistance**



R1 8" IN-BOAT

C920-1610 (White Grill)  
C920-1611 (Black Grill)



R1 6.5" IN-BOAT

C920-1600 (White Grill)  
C920-1601 (Black Grill)



R1 8" TOWER SPEAKER

C920-1710 (White Grill)  
C920-1711 (Black Grill)



R1 8" x 6.5" VAMP SPINS

C920-1823 (Black Grill)

- Power: 160W RMS | 320W PEAK
- Speaker: R1 8" & R1 6.5" component-style



R1 6.5" x 6.5" VAMP SPINS

C920-1821 (Black Grill)

- Power: 160W RMS | 320W PEAK
- Speaker: Two R1 6.5" component-style

### UPGRADE: RGB REMOTE & CONTROLLER

#### C920-1620

Take full control of the RGB LED's in the R1 series in-boat speakers, subwoofers, and tower speakers with this easy-to-use remote and controller. Choose from any of 20 pre-programmed colors and patterns along with 15 modes that actually react to your music.





# R 7.7" IN-BOAT

C920-1912

The versatile R Series line has expanded with the new Roswell R 7.7 to deliver more power and range to the audio family fit for any application on the water and beyond. This popular new size gives more people than ever access to our high-quality Roswell R Series sound in a direct replacement for their current 7.7" speakers.



Integrated RGB LEDs backlight the cone to create your desired visual atmosphere

3/4" tweeter

Injection-molded plastic with UV inhibitors for marine durability

\*\* Available Spring 2020

## FEATURES

- Klippel® tested and certified to guarantee acoustic performance
- Concealed integrated 6 dB/OCT crossover network
- Deutsch wiring harness included for water-tight connection

## SPECIFICATIONS

**Power:** 80W RMS | 160W PEAK  
**Speaker:** 7.7" Component Style  
**Tweeter:** 3/4"  
**Warranty:** 2 Year

# MARINE AUDIO



## R 6.5" IN-BOAT SPEAKER

C920-1902 (Anthracite Grill)

- **Power:** 60W RMS | 120W PEAK
- **Speaker:** 6.5" component-style



## R 7.7" IN-BOAT SPEAKER

C920-1912 (Anthracite Grill)

- **Power:** 80W RMS | 160W PEAK
- **Speaker:** 7.7" component-style



## R 6.5" TOWER SPEAKER

C920-1702 (Anthracite Grill)

- **Power:** 60W RMS | 120W PEAK
- **Speaker:** 6.5" component-style



## 6510 CLASSIC IN-BOAT

C920-3032 (White Grill)  
 C920-3030 (Black Grill)

- **Power:** 75W RMS | 150W PEAK
- **Speaker:** RMA 6.5" coaxial



## CLASSIC VAMP SPINS

C920-1824 (Black Grill)

- **Power:** 125W RMS | 250W PEAK
- **Speaker:** RMA 6.5" & 5.25" coaxial



## CLASSIC UNISON

C920-3031 (Black Grill)

- **Power:** 75W RMS | 150W PEAK
- **Speaker:** RMA 6.5" coaxial



# SUBWOOFERS & ACCESSORIES

# R1 STACKABLE MARINE AMPS

Roswell R1 Amps serve up the perfect stack with an integrated solution for multi-amp installation. Create your masterpiece of sound and make the most out of tight spaces with this secure, stylish mounting option.



RMA 12"  
C920-1811 (Black Grill)

R1 12"  
C920-1810 (White Grill)

RMA 10"  
C920-1801 (Black Grill)

R1 10"  
C920-1800 (White Grill)  
C920-1802 (Anthracite Grill)

- **Power:** 500W RMS | 1,000W PEAK
- **(R1 12")** Integrated RGB LED backlight the cone to create your desired visual atmosphere
- **(R1 12")** Press fit inserts hide installation hardware providing a clean finished look
- Dual 3" voice coils
- Dual spider ensures linear excursion
- Integrated impedance switch allows you to easily select series or parallel voice coil configurations.
- Klippel® tested and certified to guarantee acoustic performance
- Klippel® optimized motor structure for maximum power handling and sound quality
- Custom machined wire terminals allow for rock-solid wire connections
- **Extreme salt and UV resistance**

- **Power:** 250W RMS | 500W PEAK
- **(R1 10")** Integrated RGB LED backlight the cone to create your desired visual atmosphere
- **(R1 10")** Press fit inserts hide installation hardware which provides a clean finished look
- Klippel® tested and certified to guarantee acoustic performance
- Klippel® optimized motor structure for maximum power handling and sound quality
- Custom machined wire terminals allow for rock-solid wire connections
- **Extreme salt and UV resistance**



COMPARTMENT VENT  
C920-0211

R1 10" SUB ENCLOSURE  
C820-1805

R1 12" SUB ENCLOSURE  
C820-1815

- Made from marine grade materials
- Simple installation

- Made from marine grade materials
- Simple installation

- Made from marine grade materials
- Simple installation

## R1 AMP SPACERS

C920-1830



## R1 900.6

C920-1836SD

- Ch 1-6 calibrated crossover: **(FULL/HPF/LPF)**
- Bridgeable 6-channel design
- 2 Ohm Stable at 165 watts per channel
- Switchable Differential RCA inputs minimize interference and induced noise
- Conformal-coated PCBs



## R1 650.4

C920-1834SD

- Ch 1-4 calibrated crossover: **(FULL/HPF/LPF)**
- Bridgeable 4-channel design
- 2 Ohm Stable at 165 watts per channel
- Switchable Differential RCA inputs minimize interference and induced noise
- Nickel-plated wire terminals



## R1 550.2

C920-1832SD

- Ch 1-2 calibrated crossover: **(FULL/HPF/LPF) + Subsonic**
- 2 Ohm Stable at 275 watts per channel
- Switchable differential RCA inputs minimize interference and induced noise
- Phase control
- Nickel-plated wire terminals



## R1 1000.1

C920-1831SD

- Low-pass and subsonic filters (12 dB/oct.)
- Bass boost control (0-18dB @ 45Hz)
- Full 0-180° phase control
- Switchable Differential RCA inputs minimize interference and induced noise
- Space-saving Stackable Design





# AUDIO PACKAGES

# POWER RATINGS



## 6510 IN-BOAT PACKAGE

**C920-2550** (Black Grill)  
**C920-2551** (White Grill)

- (2) pr. 6510 6.5" In-Boat Speakers
- (1) Cybox Bluetooth Receiver
- (1) RMA 650.4 Amplifier
- (1) Dual Zone Volume Control
- (2) 2M 2 Channel RCA cable

## R1 IN-BOAT PACKAGE

**C920-2557** (Black Grill)  
**C920-2556** (White Grill)

- (2) pr. R1 6.5" In-Boat Speakers
- (1) Cybox Bluetooth Receiver
- (1) Dual Zone Volume Control
- (1) R1 650.4 Amplifier
- (1) RGB Remote & Controller
- (2) 2M 2 Channel RCA cable

## R IN-BOAT PACKAGE

**C920-2553** (Anthracite Grill)

- (2) pr. R 6.5" In-Boat Speakers
- (1) Cybox Bluetooth Receiver
- (1) Dual Zone Volume Control
- (1) R1 650.4 Amplifier
- (1) RGB Remote & Controller
- (2) 2M 2 Channel RCA cable



## R1 10" PACKAGE

**C920-2558** (White Grill)  
**C920-2559** (Anthracite Grill)

- (1) R1 10" Subwoofer
- (1) R1 550.2 Amplifier



## RMA 10" PACKAGE

**C920-2552** (Black Grill)

- (1) RMA 10" Subwoofer
- (1) R1 550.2 Amplifier

In-Boat Speakers					
Speaker	Continuous Power (RMS Method)	Peak Power (RMS Method)	Sensitivity	Frequency Response (+/- 3 dB)	Impedance Ω
R1 6.5"	80W	160W	90 dB @ 1W/1M	60 Hz - 20 kHz	4Ω
R1 8"	100W	200W	90 dB @ 1W/1M	50 Hz - 20 kHz	4Ω
R 6.5"	60W	120W	87 dB @ 1W/1M	69 Hz - 20 kHz	4Ω
R 7.7"	80W	160W	88 dB @ 1W/1M	55 Hz - 20 kHz	4Ω
6510 Classic	75W	150W	88 dB @ 1W/1M	70 Hz - 20 kHz	4Ω

Tower Speakers					
Speaker	Continuous Power (RMS Method)	Peak Power (RMS Method)	Sensitivity	Frequency Response (+/- 3 dB)	Impedance Ω
R1 Pro	200W	400W	Woofer: 95 dB @ 1W/1M Tweeter: 103 dB @ 1W/1M	60 Hz - 20 kHz	4Ω
R1 8"	100W	200W	90 dB @ 1W/1M	50 Hz - 20 kHz	4Ω
R1 6.5" x 6.5" Vamp Spins	160W	320W	90 dB @ 1W/1M	60 Hz - 20kHz	2Ω
R1 8" x 6.5" Vamp Spins	160W	320W	90 dB @ 1W/1M	50 Hz - 20 kHz	2Ω
R 6.5"	60W	120W	87 dB @ 1W/1M	69 Hz - 20 kHz	4Ω
Classic Unison	75W	150W	88 dB @ 1W/1M	70 Hz - 20 kHz	4Ω
Classic Vamp Spins	125W	250W	89 dB @ 1W/1M	80 Hz - 20 kHz	2Ω

Marine Subwoofers					
Speaker	Continuous Power (RMS Method)	Peak Power (RMS Method)	Sensitivity	Frequency Response (+/- 3 dB)	Impedance Ω
R1 10" Subwoofer	250W	500W	88 dB @ 1W/1M	35 Hz - 300 Hz	4Ω
RMA 10" Subwoofer	250W	500W	88 dB @ 1W/1M	35 Hz - 300 Hz	4Ω
R1 12" Subwoofer	500W	1,000W	88 dB @ 1W/1M	32 Hz - 250 Hz	Dual 4Ω
RMA 12" Subwoofer	500W	1,000W	88 dB @ 1W/1M	32 Hz - 250 Hz	Dual 4Ω

Marine Amplifiers							
Speaker	Continuous Power (RMS Method)	Input Sensitivity	HPF/LPF (High/Low Pass Filter)	Frequency Response (+/- 1 dB)	Bass EQ	Subsonic Filter	Phase Control
R1 900.6	100W x 6 @ 4Ω 165W x 6 @ 2Ω Bridged: 300W x 3 @ 4Ω	0.2 - 10.0V	HPF/LPF: 30Hz - 300Hz	10 Hz - 25 kHz	0 -18dB @ 45Hz	-	-
R1 650.4	100W x 4 @ 4Ω 165W x 4 @ 2Ω Bridged: 300W x 2 @ 4Ω	0.2 - 10.0V	HPF/LPF: 30Hz - 300Hz	10 Hz - 25 kHz	0 -18dB @ 45Hz	-	-
R1 550.2	165W x 2 @ 4Ω 275W x 2 @ 2Ω Bridged: 550W x 1 @ 4Ω	0.2 - 10.0V	HPF/LPF: 30Hz - 300Hz	10 Hz - 25 kHz	0 -18dB @ 45Hz	10Hz - 55 Hz	0-180°
R1 1000.1	400W x 1 @ 4Ω 675W x 1 @ 2Ω 1000W x 1 @ 1Ω	0.2 - 10.0V	LPF: 30Hz - 300Hz	10 Hz - 400 Hz	0 -18dB @ 45Hz	10Hz - 55 Hz	0-180°



# SPEAKER & AMP DIMENSIONS

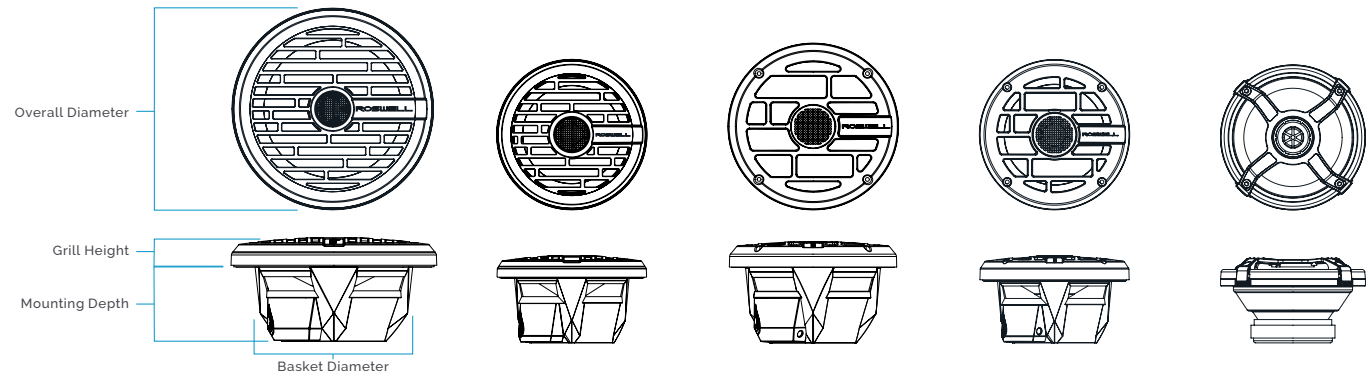

	R1 8"	R1 6.5"	R7.7"	R6.5"	6510 Classic
Nominal Diameter	8 in 20.32 cm	6.5 in 16.51 cm	7.7 in 19.56 cm	6.5 in 16.51 cm	6.5 in 16.51 cm
Overall Diameter	9.21 in 23.4 cm	6.81 in 17.3 cm	7.72 in 19.61 cm	6.75 in 17.15 cm	6.90 in 17.53 cm
Basket Diameter	7.075 in 18.0 cm	5.25 in 13.35 cm	6.26 in 15.9 cm	5.25 in 13.35 cm	5.55 in 14.1 cm
Mounting Depth	3.325 in 8.45 cm	3.00 in 7.60 cm	3.46 in 8.79 cm	3.00 in 7.60 cm	2.87 in 7.30 cm
Grill Height	1.50 in 3.80 cm	1.20 in 3.00 cm	1.22 in 3.10 cm	1.07 in 2.72 cm	1.07 in 2.72 cm

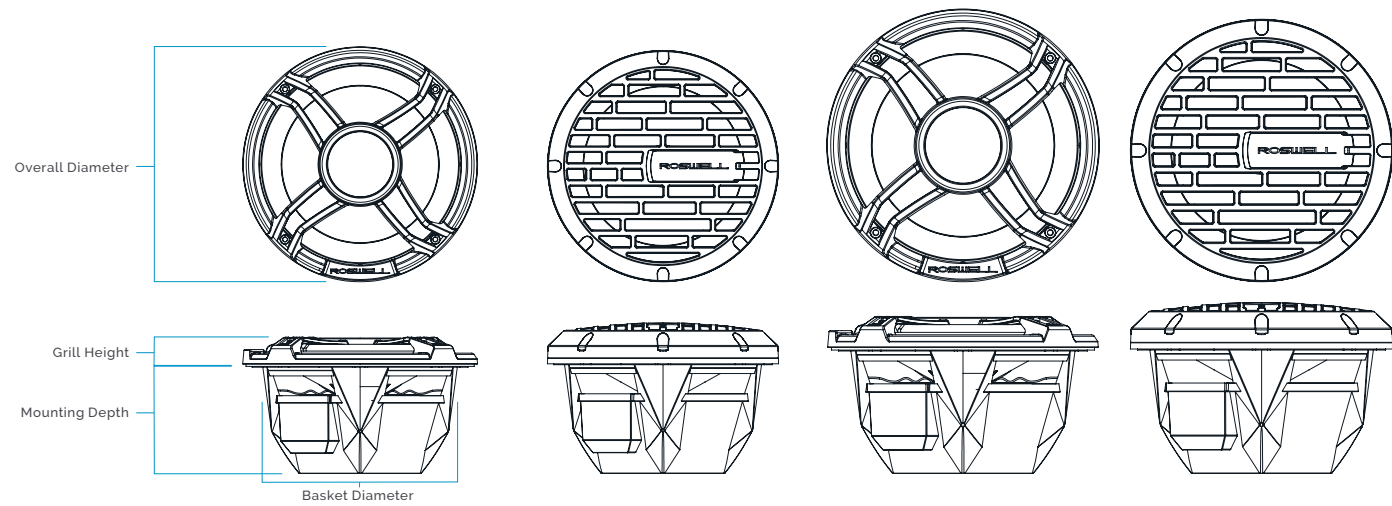

	RMA 10"	R1 10"	RMA 12"	R1 12"
Nominal Diameter	10 in 25.4 cm	10 in 25.4 cm	12 in 30.48 cm	12 in 30.48 cm
Overall Diameter	11.16 in 28.35 cm	10.85 in 27.5 cm	13.16 in 33.43 cm	12.80 in 32.5 cm
Basket Diameter	9.25 in 23.5 cm	9.25 in 23.5 cm	11.20 in 28.5 cm	11.20 in 28.5 cm
Mounting Depth	5.08 in 12.9 cm	5.08 in 12.9 cm	6.38 in 16.2 cm	6.38 in 16.2 cm
Grill Height	1.43 in 3.64 cm	1.94 in 4.90 cm	1.56 in 4.03 cm	2.12 in 5.40 cm

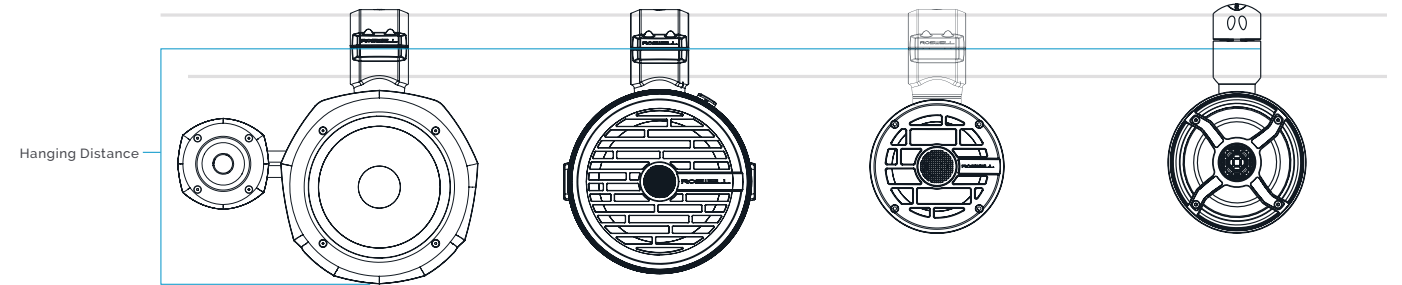

	R1 Pro	R1 8"	R1 6.5"	Classic Unison
Nominal Diameter	Woofer: 8 in (20.32 cm) Tweeter: 1 in (2.54 cm)	8 in 20.32 cm	6.5 in 16.51 cm	6.5 in 16.51 cm
Total Width	15.48 in 39.32 cm	9.875 in 25.1 cm	6.975 in 17.7 cm	7.25 in 18.42 cm
Total Depth	13.35 in 33.91 cm	13.575 in 34.5 cm	8.915 in 22.7 cm	8.93 in 22.68 cm
Hanging Distance (From center to lowest point)	12.25 in 31.12 cm	11.50 in 29.21 cm	9.59 in 24.36 cm	9.86 in 25.4 cm

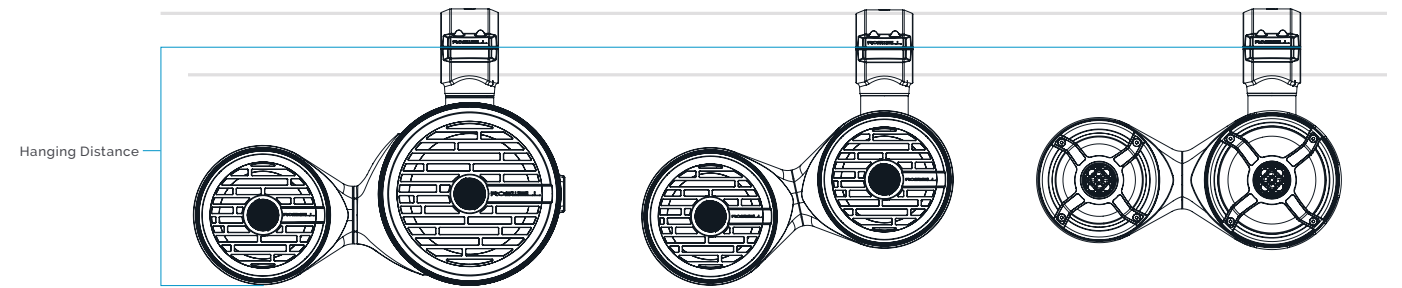

	8" x 6.5" R1 Vamp Spin	6.5" x 6.5" R1 Vamp Spin	Classic Vamp Spins
Nominal Diameter	Mounted Speaker: 8 in (20.32 cm) Spin Speaker: 6.5 in (16.51 cm)	Mounted Speaker: 6.5 in (16.51 cm) Spin Speaker: 6.5 in (16.51 cm)	Mounted Speaker: 6.5 in (16.51 cm) Spin Speaker: 5.25 in (13.34 cm)
Total Width	19.30 in 49.0 cm	16.40 in 41.64 cm	15.90 in 40.4 cm
Total Depth	13.575 in 34.5 cm	9.0625 in 23.02 cm	13.575 in 34.5 cm
Hanging Distance (From center to lowest point)	12.26 in 31.14 cm	12.57 in 31.93 cm	10.62 in 26.97 cm

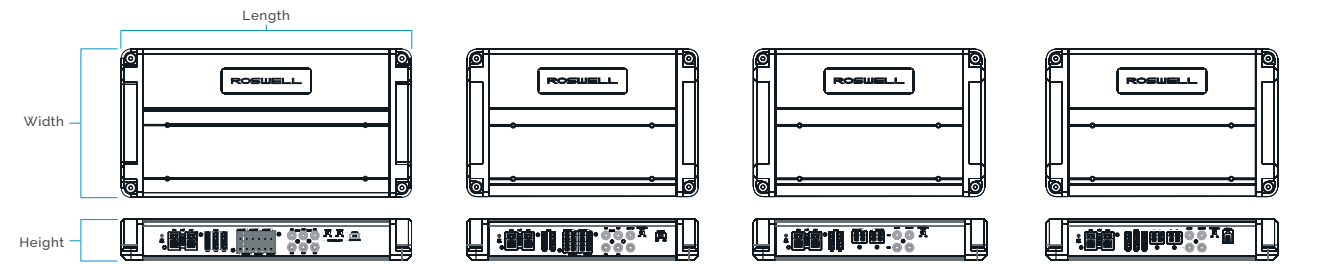

	R1 950.6	R1 650.4	R1 550.2	R1 1000.1
H x W x L (Inches)	1.90 x 7.0625 x 13.67	1.90 x 7.0625 x 11.125	1.90 x 7.0625 x 11.125	1.90 x 7.0625 x 11.125
H x W x L (Centimeters)	4.83 x 17.94 x 34.74	4.83 x 17.94 x 28.26	4.83 x 17.94 x 28.26	4.83 x 17.94 x 28.26



# AUDIO ACCESSORIES

# MARINE AMP WIRING KIT

C920-0033



## CYBOX BLUETOOTH INTERFACE

C920-0013

- Bluetooth® 4.0 – supports aptX®, A2DP, and AVRCP audio profiles
- Can connect directly to amplifiers or be used as an auxiliary input
- Three 3.5mm output jacks
- Integrated voltage selection switch to reduce voltage for use as an aux input



## DUAL ZONE VOLUME CONTROL

C920-0300

- Independent volume control for 2 zones
- Simple installation
- Dual logarithmic pots for intuitive response
- Connects with 6 nickel-plated female RCA connectors
- Quad-shielded cable for the ultimate in noise rejection



## RGB REMOTE & CONTROLLER

C920-1620

- RF Control (requires 2 AAA batteries)
- Conformal Coated PCBs for marine durability
- 20 standard LED modes
- 15 music-responsive LED modes
- Powers up to 430 watts of RGB LED's



## DISTRIBUTION BLOCK 1-IN-2 OUT

C720-0540 (Fused)  
C720-0541 (Ground)

- (1) 1/0 input with 4 AWG reducer
- (2) 4 AWG outputs with 8 AWG reducers
- High-impact plastic base and cover



## DISTRIBUTION BLOCK 1-IN-4 OUT

C720-0542 (Fused)  
C720-0543 (Ground)

- (3) 1/0 inputs with 4 AWG reducers
- (4) 4 AWG outputs with 8 AWG reducers
- High-impact plastic base and cover



## 5M 6-CHANNEL RCA CABLE

C920-0325

- 5 meter length (16.5 ft)
- Carry signal to up to 3 amps direct from the head unit, or pair with our Dual Zone Control
- Quad-shielded cable for the ultimate in marine durability and noise rejection
- Labeled RCA connectors for easy identification



## TOWER WIRING HARNESS

C910-5021

- 8 Insulated color coded 16 gauge
- Copper wires - 15ft (4.5m) included
- Full body protection insulation
- Male and female Speakon connections
- 316 stainless steel mounting hardware
- Quick connects

## WHAT'S IN THE BOX:

- (1) 1 In 2 Out Fused Distribution Block
- (1) 1 In 2 Out Ground Distribution Block
- (1) ANL Single Fuse Holder
- (2) 4 Gauge Ring Terminal [3/8" Hole]
- (1) 4 AWG Power Wire [15 Feet]
- (1) 4 AWG Ground Wire [15 Feet]
- (1) 16 Blue Wire [15 Feet]
- (2) RCA Y-Splitter (1F to 2M)
- (2) RCA Y-Splitter (1M to 2F)
- (2) 2-Meter 2-Channel RCA Cable
- (1) 40 Amp Mini ANL Fuse
- (1) 50 Amp Mini ANL Fuse
- (1) 80 Amp Mini ANL Fuse
- (1) 80 Amp ANL Fuse
- (1) 100 Amp ANL Fuse
- (1) 150 Amp ANL Fuse
- (12) 4" Cable Tie
- (10) #8 x 1/2" Flat PHIL SS



# LIGHTING



## L6 UNDERWATER LIGHT

**C910-00015** (Blue)  
**C910-00016** (White)

- 6 LED's per light
- 1-year limited warranty



## NIGHTVISION 4

**C910-1722**

- 4x articulating 3W HP LED lamps
- Blue lens LED courtesy light
- Polycarbonate LED lenses



## ANCHOR LIGHT

**C910-0018**

- Brushed clear anodized finish
- All-round LED light
- Mounts easily to tower
- Fits 1.9" & 2.325" tubing
- USCG approved



## 6.5" LED NIGHT RINGS

**C920-0016** (Clear)  
**C920-0018** (Red)  
**C920-0019** (Blue)

- **Inner Diameter:** 5.625 inches | 14.3 cm
- **Outer Diameter:** 6.82 inches | 17.3 cm
- **Mounting Diameter:** 6.125 inches | 15.56 cm
- **Thickness:** 0.2 inches | 0.5 cm



\* Made in the USA

## NIGHTWAVE

**C910-0015** (Blue)  
**C910-0016** (White)

NightWave (/nīt . wāv/) - A disruption on a body of water in the form of a swell with no light present, until now. Roswell lights up the water again with new and improved underwater LED's. With over 3,000 lumens saturating the water, you're no longer looking for the wave. It's looking for you.

# ACCESSORIES



## DEFLECTOR

**C910-1750**

- High density foam float block in case of accidental release
- Universal suction cup mount requires no drilling or hull modifications
- Increased suction cup foot print versus competitors
- Billet aluminum suction cup block
- Superior suction power



## ROSWELL MIRROR & MOUNT

**C910-0061** (Mirror/Mount Combo)  
**C910-0044** (Mirror Only)  
**C910-0059** (Mount Only)

- Asymmetrical design with wide viewing angle
- Thumb grip area for mirror adjustment
- Large ergonomic handle to secure mirror in desired position
- Adjustable mounting clamp fits most windshield headers
- Soft rubber padding prevents damage to windshield
- Articulating mirror arm for optimal positioning
- Quick fold for use with boat cover



## SEAHORSE HANGER

**C910-0901**

- Fits 1.9" - 2.25" & 2.375" - 3" tubing sizes
- Easy to snap on and remove from your tower
- Rubber grips prevent tower damage and provide grip
- You can hang anything you can hook to it weighing up to 10lbs
- Floats so you won't lose it in the water



## ELITE MIRROR ARM

**C910-0038**

- Includes: 1.9" and 2.375" clamp inserts
- Available for purchase: 1.6", 2.0", & 2.5" clamp inserts
- Dual articulation points
- Three way adjustable swivel
- Brushed and clear coated aluminum finish
- Roswell machined logo



## ROPE HOOKS

**C910-0019**

- Neatly stores your tow rope
- Rotates for ease of rope removal
- Lock rope in place to prevent unraveling
- Fits tubing sizes from 1.9" to 3"
- No need to drill holes



## STEP PAD

**C910-0052** (Grey)  
**C910-0054** (Brown)

- Durable and shock absorbent
- 16" length x 3" width
- Provides added traction
- SeaDek® non-absorbent EVA foam

## FEATURES

- Water cooled housing with electronic thermal micro-controller
- Low/over voltage protection
- Reverse polarity protected
- 1 year limited warranty
- Overheat protection

## SPECIFICATIONS

<b>LED Colors:</b>	White, Blue
<b>LED Life:</b>	~50,000 hours
<b>Lumen Output:</b>	3,000
<b>Low Power Draw:</b>	1.99 Amps
<b>Voltage Range:</b>	12v - 30v
<b>Housing Material:</b>	Anodized Billet Aluminum



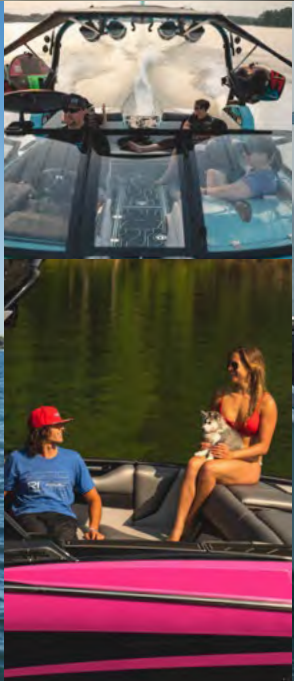



# ROSWELL.

2020 PRODUCT

CENTURION  
& *SUPREME*  
BOATS





# CENTURION

DROPZONE AUTO TOWER & BIMINI

# CENTURION

DROPZONE AUTO TOWER & BIMINI

## INDUSTRY FIRSTS:

- Integrated Safety Circuit
- Integrated Drying Hooks
- Manual ByPass Power Tower
- Patent Pending Floating-Point Actuators
- Custom Water-Drop Extruded Construction



\*Centurion Boat Exclusive

## AWARD-WINNING INNOVATION

Roswell Marine has revolutionized powered folding tower design with the patent-pending DropZone Auto Tower created exclusively for Centurion Boats. This approach escapes traditional actuator placement in which the mechanism is mounted within the tower foot causing the need for a large housing that limits styling and obstructs view. This innovative method flips the script on traditional powered tower design resulting in smooth operation and less wear on each component.

The DropZone's innovation doesn't stop at function alone. The configuration of the tower has made way for a sleek design that steps forward in style, strength, and safety. The waterdrop extruded construction provides the DropZone with 40% more strength and pinch points have been removed near the latch for safer operation. Leaving no stone unturned, Roswell's patented Weight Assist allows users to configure the tower for manual operation in the event of power loss. The addition of integrated courtesy lighting, surf-side tow points, and rope hangers pulls together a package that discovers new possibilities in tower design.

## DROPZONE AUTO TOWER

- **Audio Option:** CoverFire Marine Surround Sound Audio System
- Powered by Rowell's Patent-Pending Floating Point Tower Technology
- Three Tow Heads (Port, Center, Starboard)
- Color Matched Custom Fiberglass Accent Panels
- **Board Rack Options:** Patented Bombshell
- Patented Cam Latch and Weight Assist for Easy Folding and to Prevent Tower Vibration
- Integrated Grab Handles, Rope Hangers, and Courtesy Lights
- Custom Lighted Side Accent Plates with Centurion Logo



## DROPZONE BIMINI

- Includes Two Integrated Surf Pockets for Extra Board Storage
- Large - Approx. 36.4 Sq. Ft.
- XXL - Approx. 51.4 Sq. Ft.
- Bi-Fold Design Enhances Function & Style
- Can Be Locked in Folded Position for Greater Stability
- Integrated Fabric Vents Reduce Stress on Bimini Frame





# CENTURION

MAXIMUS TOWER & BIMINI

# CENTURION

MAXIMUS TOWER & BIMINI



## MAXIMUS TOWER

- **Audio Options:** Downfire, Spark
- **2-Tone Vacuum-Infused Fiberglass Side Panels - Offered by Centurion**
- **Integrated LED Accent Lighting**
- **Board Rack Options:** Swivel, Fixed, or Patented Bombshell
- **Patented Cam Latch and Weight Assist for Easy Folding and to Prevent Tower Vibration**
- **Integrated Board Rack Mounts**



## STYLE AND FUNCTION READY FOR FLIGHT

Exclusive to Centurion Boats, the Roswell Maximus Tower features a winged design that blends unique styling with function that keeps you ready for to take flight. Roswell's patented weight assist system makes folding the tower back and out of the way with one person effortless when you need to get low. Lock the tower back into place with our patented cam-latch for extreme rigidity and strength.

## MAXIMUS BIMINI

- **Standard - Approx. 36.1 Sq. Ft.**
- **Large - Approx. 46.2 Sq. Ft.**
- **Easily Accessible Integrated Surf Pockets Hold 2 Surfboards**
- **Integrated Bimini Provides Maximum Shade While Easily Folding Up and Storing On Tower**
- **Custom Bimini Clips Exclusive to Roswell Bimini Design**
- **Integrated Bimini Mounts**





# SUPREME

F-SERIES TOWER & BIMINI



# SUPREME

F-SERIES TOWER & BIMINI

## F-SERIES TOWER

- **Board Rack Options:** Swivel or Patented Bombshell
- Patented Cam Latch and Weight Assist for Easy Folding and to Prevent Tower Vibration
- Forward-Folding Design Allows for Easier Rear Entry When Folded
- USCG Approved Anchor Light with Integrated Tow Point
- Integrated LED Accent Lighting
- Laser Etched Anodized Aluminum Accent Plates
- Integrated Board Rack & Bimini Mounts



## THE EVOLUTION OF STRENGTH & STYLE

The release of the 2020 Supreme fleet demanded a step forward from the gunnel to the sky and the F-Series Tower by Roswell Marine will bring your boating experience to a place that makes Top Gun pilots say "great balls of fire." This forward-folding design utilizes our patented weight-assist system for simple single-person operation that makes configuring your tower for any situation an afterthought. Featuring the patented Roswell Cam-Latch, the F-Series Tower keeps you locked & loaded with unmatched rigidity, strength, and style.

## F-SERIES BIMINI

- Easily Accessible Integrated Surf Pockets Hold 2 Surfboards
- Bimini is approximately 43.6 Sq. Ft.
- Bimini Arms Lock in the Deployed & Folded Positions
- Integrated Bimini Provides Maximum Shade While Easily Folding Up and Storing On Tower
- Custom Bimini Clips Exclusive to Roswell Bimini Design







# COVERFIRE

MARINE SURROUND SOUND AUDIO SYSTEM



## BANG YOUR HEAD TO THE MUSIC, NOT ON THE SPEAKERS.

The all-new Centurion CoverFire Marine Surround Sound Audio System will create enough thunder to make Zeus and your neighbors jealous. This system is fitted with two pairs of R1 8" and 1 pair of R1 6.5" speakers directed to all areas of your boat. With integrated accent lighting to guide your path to unforgettable summer nights and a stunning fiberglass accent panel, The CoverFire has taken audio design into new territories. Available in black or white exclusively on the DropZone Auto Tower, this system is designed to seamlessly integrate with the tower and maximize headroom. The dual-zone volume knob gives you the ability to customize your experience on the fly for the times you need to keep it all business up front with a party in the back.

• **CoverFire:** 560 Watts RMS | 1120 Watts Peak

• **R1 8" In-Boats:** 100 Watts RMS | 200 Watts Peak

• **R1 12" Sub:** 500 Watts RMS | 1,000 Watts Peak

• **CoverFire:** Available on DropZone Auto Tower Only

• **R1 8" In-Boats:** 6 Speakers (8 Speakers - Ri257)

• **R1 12" Sub:** Available on All Models with 316 Stainless Custom Grill

**Total System Output**  
Fi21, Fi23, Fi25, Ri217, Ri237

1,660 Watts RMS | 3,320 Watts Peak

**Total System Output**  
Ri257

1,860 Watts RMS | 3,720 Watts Peak

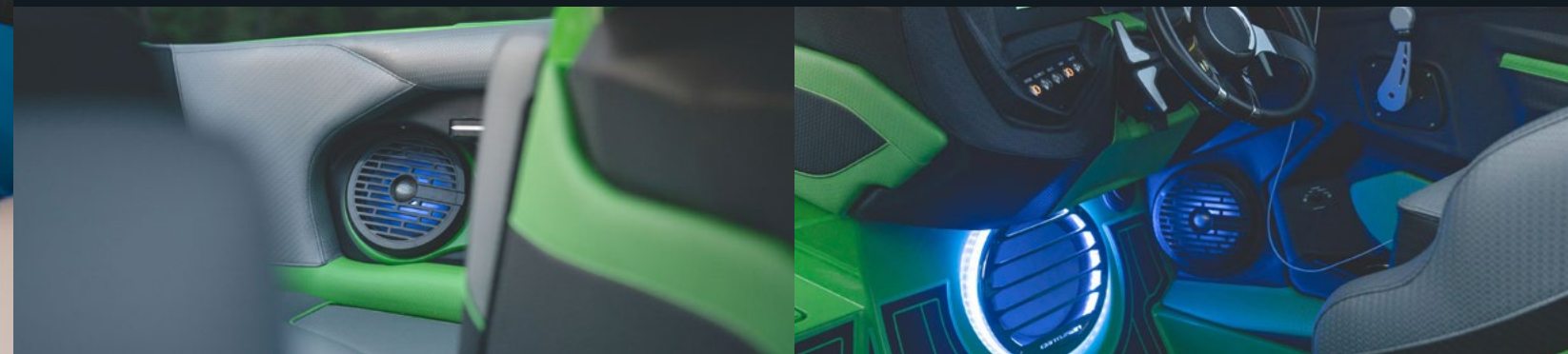



# DOWNFIRE

MARINE SURROUND SOUND AUDIO SYSTEM



## THERE'S NOWHERE TO HIDE

The DOWNFIRE Marine Surround Sound Audio System was designed through a Centurion/Roswell collaboration to explore a new way to deliver music on the water. While traditional marine audio systems only sound good in one spot on the boat, the DOWNFIRE delivers a symphony of sound to the entire crew with nowhere to hide. Developed exclusively for Centurion, the DOWNFIRE uniquely angles and tunes each speaker individually to create an amazing audio experience no matter where you're sitting. The dual-zone volume knob gives you the ability to customize your experience on the fly for the times you need to keep it all business up front with a party in the back.

- **DownFire:** 700 Watts RMS | 1,400 Watts Peak
- **R1 8" In-Boats:** 100 Watts RMS | 200 Watts Peak
- **R1 12" Sub:** 500 Watts RMS | 1,000 Watts Peak
- **DownFire:** Available with Maximus Tower Only
- **R1 8" In-Boats:** 6 Speakers (8 Speakers - Ri257)
- **R1 12" Sub:** Available on All models with 316 Stainless Custom Grill

### Total System Output

Fi21, Fi23, Fi25, Ri217, Ri237, Vi22, Vi24

1,600 Watts RMS | 3,200 Watts Peak

### Total System Output

Ri257

1,800 Watts RMS | 3,600 Watts Peak



NEW FOR 2020: R1 8" TOWER SPEAKERS

## AUDIO IGNITED

The Spark Marine Audio System was designed to keep your day cranking with high quality sound that never quits. R1 8" Tower Speakers blast your session with 100 Watts of power and clarity cranking from LED accented housings that add the perfect touch of style and class. R1 8" in-boats and R1 12" subs fill your arena of sound to deliver a punch that would make Don King return. R1 stackable marine amplifiers power this hard hitting system with calibrated crossover controls, differential RCA inputs, fully conformal-coated PCB's, and nickel-plated marine-grade wire terminals ensuring a sound so clean, astronauts could use them in preparation for space flight.

- **R1 8" Tower Speaker:** 100 Watts RMS | 200 Watts Peak
- **R1 8" In-Boats:** 100 Watts RMS | 200 Watts Peak
- **R1 12" Sub:** 500 Watts RMS | 1,000 Watts Peak
- **R1 8" Tower Speaker:** One Pair - Available on All Models
- **R1 8" In-Boats:** 6 Speakers (8 Speakers - Ri257)
- **R1 12" Sub:** Available on All Models with ABS Grill

### Total System Output

Fi21, Fi23, Fi25, Ri217, Ri237, Vi22, Vi24

1,300 Watts RMS | 3,200 Watts Peak

### Total System Output

Ri257

1,500 Watts RMS | 3,000 Watts Peak





# CENTURION

STACKABLE R1 MARINE AMPLIFIERS

# CENTURION

STACKABLE R1 MARINE AMPLIFIERS



Lit logo power indicator lets you know your amp is receiving power

Marine-grade durability

Stackable Class-D design

## R1 650.4

- Ch 1-4 calibrated crossover: **(FULL/HPF/LPF)**
- Bridgeable 4-channel design
- 2 Ohm Stable at 165 watts per channel
- Switchable differential RCA inputs minimize interference and induced noise
- Conformal-coated PCBs



Continuous Power: <b>100W x 4 @ 4Ω</b>	Input Sensitivity: <b>0.2-10.0V</b>
<b>165W x 4 @ 2Ω</b>	HPF/LPF: <b>30-300Hz</b>
Bridged Power: <b>300W x 2 @ 4Ω</b>	Frequency Response: <b>10Hz - 25kHz</b>
	Bass EQ: <b>0-18 dB @ 45Hz</b>

## R1 550.2

- Built-in crossovers: **(FULL/BPF/HPF) + Subsonic**
- Bridgeable 2-channel design
- 2 Ohm Stable at 275 watts per channel
- Switchable differential RCA inputs minimize interference and induced noise
- Phase Control
- Conformal-coated PCBs



Continuous Power: <b>165W x 2 @ 4Ω</b>	Input Sensitivity: <b>0.2-10.0V</b>
<b>275W x 2 @ 2Ω</b>	HPF/LPF: <b>30-300Hz</b>
Bridged Power: <b>550W x 1 @ 4Ω</b>	Frequency Response: <b>10Hz - 25kHz</b>
	Bass EQ: <b>0-18 dB @ 45Hz</b>

## R1 1000.1

- Low-pass and subsonic filters **(12 dB/oct.)**
- Bass boost control **(0-18dB @ 45Hz)**
- Full 0-180° phase control
- Switchable differential RCA inputs minimize interference and induced noise
- Conformal-coated PCBs



Continuous Power: <b>400W @ 4Ω</b>	Input Sensitivity: <b>0.2-10.0V</b>
<b>675W @ 2Ω</b>	LPF: <b>30-300Hz</b>
<b>1,000W @ 1Ω</b>	Frequency Response: <b>10Hz - 400Hz</b>
	Bass EQ: <b>0-18 dB @ 45Hz</b>



## DUAL ZONE VOLUME CONTROL

- Independent volume control for 2 zones
- Simple installation
- Dual logarithmic pots for intuitive response
- Connects with 6 gold-plated female RCA connectors
- Quad-shielded cable for the ultimate in noise rejection



# CENTURION | SUPREME

BOMBSHELL BOARD RACKS

# CENTURION | SUPREME

BOMBSHELL BOARD RACKS



## BUILT FOR BATTLE

Available with all 2020 Centurion and Supreme towers, Roswell Marine's Patented Bombshell Racks offer maximum protection for your payload with looks that knock em' dead every time. Adjustable Telescoping Arms eliminate board chatter in hostile waters keeping you locked and loaded for every session. Taking protection to the next level, Bombshell Board Racks encase your weapon of choice in GatorStep to eliminate casualties.

- Telescoping Arms Securely Hold Boards in Place
- Adjustable For Boards 14" to 23" Wide
- 2.75" Maximum Thickness
- Complete Board Protection Utilizing GatorStep
- Direct Mount with Mag Swivel
- Angled Outward to Maximize Visibility

---

<b>Tine Spread:</b>	10.0 inches   25.4 cm
<b>Wake Tine Gap:</b>	1.15 inches   2.92 cm
<b>Surf Tine Gap:</b>	2.75 inches   6.99 cm
<b>Materials:</b>	6061 Billet Aluminum   Overmolded TPU
<b>Mounting Hardware:</b>	316 Stainless Steel

---





# CENTURION | SUPREME

SWIVEL & FIXED BOARD RACKS



# CENTURION | SUPREME

SWIVEL & FIXED BOARD RACKS



## OVERMOLDED FOR PROTECTION.

All swivel and fixed board racks are overmolded for protection to stay saltwater and board friendly, Each rack features a brushed anodized backing plate and integrated webbed bungee strap with loop.

### SWIVEL:

- Swivel Attachment Allows You to Rotate Racks Inward 180 Degrees for Safe Storage and Docking
- Soft TPU Board Protection
- Durable Sandblasted / Anodized Components
- Accommodate 1 Surfboard and 1 Wakeboard
- Only Works on Lower Tower Mount



### FIXED:

- Centurion Fixed Rack Adapter Gives Rack Clearance
- Soft TPU Board Protection
- Durable Sandblasted / Anodized Components
- Tine Slots Accommodate 1 Surf and 1 Wakeboard
- Only Works on Upper Tower Mount



---

<b>Tine Spread:</b>	10.0 inches		25.4 cm
<b>Wake Tine Gap:</b>	1.15 inches		2.92 cm
<b>Surf Tine Gap:</b>	2.75 inches		6.99 cm
<b>Materials:</b>	6061 aluminum		Overmolded TPU
<b>Mounting Hardware:</b>	316 Stainless Steel		

---







# ROSWELL.

2020 Platinum Audio Upgrade Options



Cobalt's pursuit of excellence in every category takes your experience on the water to the next level with Roswell Marine audio and accessories. Purpose-built to last in freshwater and saltwater environments, enhance every moment with products specifically designed and tuned to perfection for your boat.



COBALT BOATS





# R Series



## PLATINUM ROSWELL AUDIO PACKAGE

Cobalt's Platinum Roswell Audio Upgrade Package will ensure that your R Series sounds as good as it looks. Multiple configurations have been developed to optimize the placement of each award-winning Roswell R1 Audio component, giving you the ability to customize your experience and create the sound system of your dreams.

- **R1 Pro Tower Speakers:** 200W RMS | 400W PEAK
- **R1 8" Tower Speakers:** 100W RMS | 200W PEAK
- **R1 6.5" In-Boat Speakers:** 80W RMS | 160W PEAK
- **R1 8" In-Boat Speakers:** 100W RMS | 200W PEAK
- **R1 10" Subwoofer:** 250 WATTS RMS | 500W PEAK
- **R1 12" Subwoofer:** 500W RMS | 1000W PEAK
- **Integrated RGB LED** to create your desired visual atmosphere
- Tweeter carefully engineered to have good on and off-axis response, ensuring crisp, clear highs
- Klippel® tested and certified to guarantee acoustic performance
- Injection-molded plastic with UV inhibitors for marine durability
- **Extreme salt and UV resistance**

## OPTIONAL

(2 pr.) R1 8" Tower Speakers (Black or White)

\*\* Not available on R35 & R6 models



## R6 STANDARD

(2 pr.) Award-Winning R1 Pro Tower Speakers

\*\* Available exclusively on R6





# SC & A Series



## PLATINUM ROSWELL AUDIO PACKAGE

Cobalt's Platinum Roswell Audio Upgrade Package will ensure the sound system in your SC or A series has the same elegant, yet aggressive look and performance as the boat itself. Featuring configurations that allow you to create a masterpiece with the Roswell R1 Audio line, consume your crew with full, rich sound from every angle. The addition of 4 8" R1 Cobalt Tower Speakers will elevate your soundstage to bring the Roswell audio experience to friends and family being towed behind the boat or relaxing at your favorite sandbar.

- **R1 8" Tower Speakers:** 100W RMS | 200W PEAK
- **R1 6.5" In-Boat Speakers:** 80W RMS | 160W PEAK
- **R1 8" In-Boat Speakers:** 100W RMS | 200W PEAK
- **R1 10" Subwoofer:** 250 WATTS RMS | 500W PEAK
- **R1 12" Subwoofer:** 500W RMS | 1000W PEAK
- **Integrated RGB LED** to create your desired visual atmosphere
- Tweeter carefully engineered to have good on and off-axis response, ensuring crisp, clear highs
- Klippel® tested and certified to guarantee acoustic performance
- Injection-molded plastic with UV inhibitors for marine durability
- **Extreme salt and UV resistance**



## OPTIONAL

(2 pr.) R1 8" Tower Speakers (Black or White)





## COBALT ELITE BOARD RACK

**NOTE:** Standard on all surf models & optional on any models with a tower.

The Cobalt Elite swivel board rack is an excellent addition to any Cobalt tower to provide additional storage space for one surf board and one wake board. The Swivel uses high-strength magnets to secure the locking mechanism at the end of it's rotation, eliminating rattling and ensuring that the rack remains securely in position while traveling.

- **Surf Tine Gap:** 2.75 inches / 6.98 cm
- **Wake Tine Gap:** 1.15 inches / 2.92 cm
- **Tine Spread:** 10 inches / 25.4 cm



## COBALT TRITON BOARD RACK

**NOTE:** Optional on all models with a tower.

Roswell's award-winning, patented Cobalt Triton Board Rack is the perfect solution to provide additional storage space for boards. The swivel uses high-strength magnets to secure the locking mechanism at the end of it's rotation, eliminating rattling and ensuring that the rack remains securely in position while traveling.

- Painted finish available in black or white
- Vertical Tine slots accomodate boards up to 2.75" thick with soft EVA Foam to protect boards
- Telescopic arm can be adjusted so that dedicated slots have smaller or larger gaps **to account for width changes of kids wakeboards vs. large surfboards up to 23" wide**
- Vertical board orientation allows wet boards to drip outside your boat





**MOOMBA**

# ROSWELL, 2020 PRODUCT





THE ORIGINATION OF EVERY ROSWELL PRODUCT IS A MOMENT ON THE WATER THAT WE BELIEVED COULD BE MADE EVEN BETTER.

EACH NEW DESIGN IS DRIVEN BY THE SAME PASSION PEOPLE AROUND THE WORLD CHASE TO LAKES, RIVERS, AND OCEANS TO CREATE EXPERIENCES THAT DEFINE THEM.

THOSE EXPERIENCES HAVE INSPIRED 20 YEARS OF INNOVATION, FORMING OUR DNA OUT OF A VISION THAT HAS SEEN HUMBLE BEGINNINGS BECOME SOMETHING SO MUCH MORE THAN THE PRODUCTS WE BUILD.

ROSWELL IS A MOVEMENT THAT MARCHES FORWARD WITHOUT COMPROMISE TO MAKE EVERY SECOND ON THE WATER UNFORGETTABLE.





# WAKE TOWER & BIMINIS



## OPTIONS

	Makai	Craz Pro	Mojo	Craz	Mondo	Max	Helix	Kaiyen
PRO TOWER W/ FOLD ASSIST (BLACK)	S	S	N/A	N/A	N/A	N/A	N/A	O
PRO APPEARANCE UPGRADE W/ MOOMBA BACKLIGHT (6 COLORS)	O	S	N/A	N/A	N/A	N/A	N/A	O
PRO PREMIUM TOWER BIMINI WITH ARMS AND SURF STORAGE	O	S	N/A	N/A	N/A	N/A	N/A	O
A3 TOWER W/ FOLD ASSIST (BLACK)	N/A	N/A	N/A	N/A	N/A	S	S	S
A3 TOWER W/ FOLD ASSIST (BLACK OR WHITE)	N/A	N/A	S	S	S	N/A	N/A	O
A3 APPEARANCE UPGRADE W/ MOOMBA BACKLIGHT (6 COLORS)	N/A	N/A	O	O	O	N/A	N/A	O
A3 PREMIUM TOWER BIMINI W/ BILLET ARMS & SURF STORAGE	N/A	N/A	O	O	O	O	O	O

## FUNCTION & STYLE

For 20 years Roswell Marine has led the charge in tower design with a focus on innovative function and style. A passion born behind the boat inspires new technology that integrates features to make your experience on the water better. Sharing a vision with Moomba that's committed to the core, our towers and biminis are here to make a statement, and ensure your ride is unforgettable.



# PRO TOWER & BIMINI



## MOOMBA PRO TOWER & BIMINI

The Moomba Pro Tower by Roswell Marine is suited for royalty, crowning the Moomba Makai and Moomba Craze Pro with the option to add an additional touch of class to the all-new Moomba Kaiyen. Complete with an adjustable weightless folding mechanism, bridge and garage block fold stops, swivel board racks and an integrated bimini, this tower is an evolution of excellence. LED tower accent lighting, GatorStep covered panels, and surf-side tow points add thoughtful touches to this perfect package. Add your own personal style with the Contrast option, for 6 color choices on tower base fairings and bimini arms to further customize your new Moomba.

\*Available on the Moomba Makai, Kaiyen, & Craze Pro

## FEATURES

- Patented Cam Latch and Weight Assist System for Easy Folding & to Prevent Tower Vibration
- Built-In Mounting Blocks for Swivel Board Racks and Fixed Racks
- 3 Tow-Head Points (Top-Left, Center, Top-Right)
- Pre-Wired for Lights & Speakers
- Accent Lighting & Side Plates
- Dual Surf-Pockets for Added Storage
- Custom Bimini Arms for Added Accents



# A3 TOWER & BIMINI

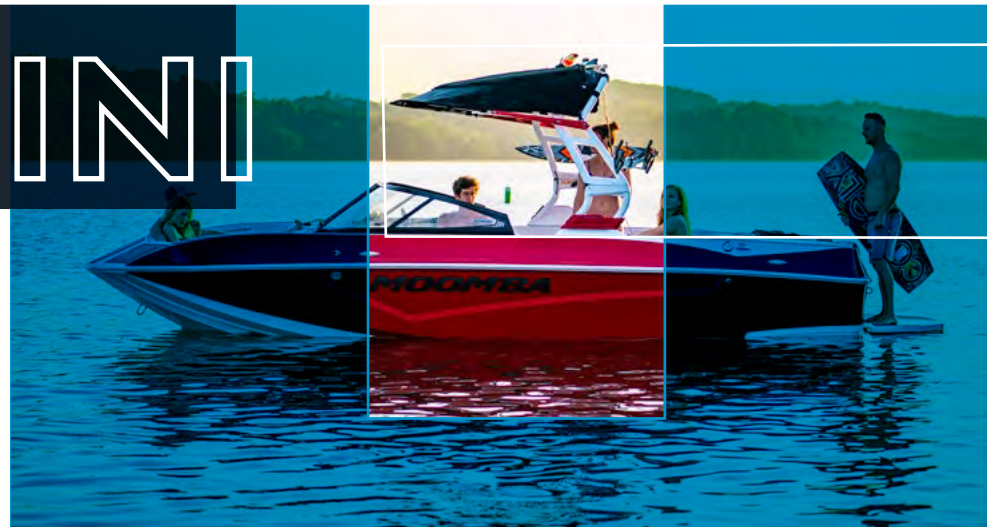

## MOOMBA A3 TOWER AND BIMINI

The Moomba A3 tower by Roswell Marine is loaded with innovative features in a design that defines progression while entering into the category of legends. Our patented Weight Assist System and Cam Latch makes raising and lowering this forward folding tower effortless, leaving you the ability to add accessories while maintaining one person operation. Integrated mounting options give you the choice between fixed and swivel board racks along with additional storage for surfers with the A3 Bimini option. Choose the A3 appearance upgrade to add your personal touch of style with 6 accent color options that make a statement on the water with a tower that leaves no choice but to follow its lead.

\*Available only on Moomba Mojo, Craze, Mondo, Max, Kaiyen, & Helix

## FEATURES

- Patented Cam Latch and Handle System for Easy Folding & to Prevent Tower Vibration
- Built-in Mounting Blocks for Swivel Board Racks & Fixed Racks
- Patented Weight Assist System
- Pre-Wired for Lights & Speakers
- Dual Surf-Pockets for Added Storage
- Custom Accent Upgrade to Add Custom Colors to Bimini Arms & Tower Feet







# TRITON BOARD RACKS



## TRITON STRAPLESS BOARD RACKS

No board rack has done what the Triton has done, in the time it has done it. This award-winning patent-pending design has given boards of all shapes and sizes around the world peace of mind knowing that the days of chattering across the water at high speeds are over. Vertical orientation and telescopic grab arms make loading boards a breeze and direct water droplets outside of the boat and away from your head. EVA foam prevents scratches and dings with tine slots large enough for boards up to 2.75" thick. No matter what you do or what they say, once you try this rack you'll never go back.

## FEATURES

- 10mm EVA Foam for Ultimate Board Protection
- Billet Aluminum Tines & Crossbars Can Hold Two Surfboards, Two Wakeboards or One of Each
- Adjustable, Telescopic Grab Arms Designed to Fit Boards at a Maximum of 23 Inches Wide
- Hard Duro Thermoplastic Polyurethane Wakeboard Groove
- Vertical Board Orientation Provides Improved Ergonomics & Allows Wet Boards to Drip Outside of Your Boat



- **Tine Spread:** 10.0 in | 25.4 cm
- **Tine Gaps:** 2.75 in | 6.99 cm
- **Max Board Width:** 23.0 in | 58.42 cm

- **Materials:** 6061 Aluminum | EVA Foam | Hard Duro Soft TPU
- **Mounting Hardware:** 316 Stainless Steel



# ELITE BOARD RACKS



## ELITE SURF/WAKE RACKS

The Elite Surf/Wake Racks by Roswell Marine were built to last with a durable overmolded design that will ensure your boards are cruising in comfort and style. Dedicated slots hold one wakeboard up to 1.15 inches thick and one surfboard up to 2.75 inches thick. Bring them on board with the optional quick release swivel and keep your cockpit clutter free with racks that make sure the only things you leave hanging when you're out on the water are your boards.



## ELITE SURF/WAKE RACKS

- Holds One Surfboard & One Wakeboard
- Elite Backing Plate with Bungee Hook
- Durable Overmolded Tines
- Webbed Bungee Strap with Loop

## QUICK RELEASE SWIVEL

- Machined from Billet Aluminum with a Brushed Anodized Finish
- 2 Locking Positions:  
**90° out of boat and 90° into boat**
- To Lock or Unlock You Must Compress Dampeners

- **Tine Surf Gap:** 2.75 in | 6.99 cm
- **Tine Wake Gap** 1.15 in | 2.92 cm

- **Board Rack Materials:** 6061 Aluminum | Overmolded TPU
- **Board Rack Mounting Hardware:** 316 Stainless Steel



**NAUTIQUE**

# ROSWELL, 2020 PRODUCT



All of Roswell's Nautique designed accessories are purpose-built to last in a marine environment, whether it's fresh or saltwater. Each component has been designed and tested to ensure your accessories will last for years.



# NAUTIQUE

TELESCOPING FLIGHT CONTROL TOWER  
IN COLLABORATION WITH ROSWELL MARINE



Industry First Telescoping Tower Design



# STANDARD:

SAN G23 Paragon

---

Introducing our next innovation in tower design and manufacturing with the all-new patent-pending Nautique Telescoping Flight Control Tower. This industry-first design raises and lowers the tower vertically to give users the ability to operate the boat safely and comfortably while adjusting to any preferred operating position.

Designed for the all-new Super Air Nautique G23 Paragon, dynamic angles blend function and style along with an actuated all-around light and integrated dock logo projection lighting for an added touch of class.

*Nautique Telescoping Flight Control Tower is manufactured in the U.S.A. at Roswell Marine headquarters in Rockledge, FL.*





# NAUTIQUE

## TELESCOPING FLIGHT CONTROL TOWER IN COLLABORATION WITH ROSWELL MARINE

Roswell's positive engagement system provides extreme strength and stiffness with fail-safe retraction to ensure positional integrity. The touch of a button powers four actuators housed within sliding sections on each side, configured for staggered articulation to raise and lower the tower at twice the overall height.



- Patent-Pending Electronic Telescoping Raising and Lowering
- Nautique Boats Exclusive
- GoPro Ready Swivel Pylon
- Dock Logo Projection Lighting
- Integrated Awareness Camera
- Actuated All-Around Light
- Manufactured in the USA



# NAUTIQUE

TELESCOPING FLIGHT CONTROL TOWER BIMINI  
IN COLLABORATION WITH ROSWELL MARINE

## SUN PROTECTION & STORAGE

The integrated bimini remains mounted and deployed in all positions for convenience and increased protection from the elements.

---



- Lowers to Cockpit for Overhead Clearance & Protection from the Elements
- Oversized Coverage
- Integrated Storage Pockets
- Integrated Surf Pockets Hold 2 Surf Board



# NAUTIQUE

STRAPLESS BOARD RACKS

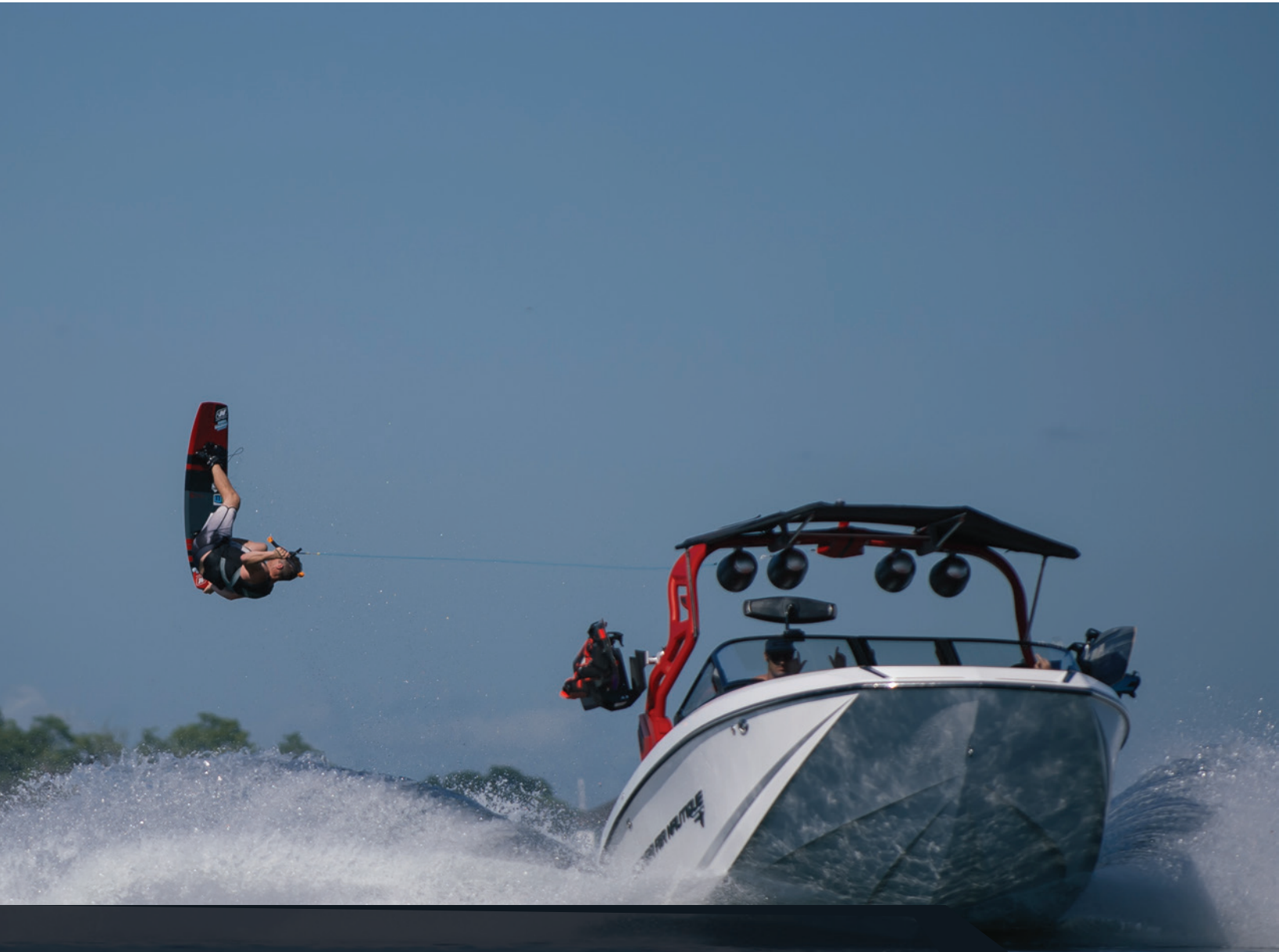

## ONE SIZE FITS ALL

We set out to create a rack that didn't discriminate. A rack that's easier to use than ever before. A rack that looks and works completely different than anything out there.



# STANDARD:

SAN G23 Paragon

# OPTIONAL:

Super Air Nautique GS20    Super Air Nautique 230  
Super Air Nautique GS22    Super Air Nautique G21  
Super Air Nautique GS24    Super Air Nautique G23  
Super Air Nautique 210    Super Air Nautique G25

## HOLD ON TIGHT

The patented Nautique Strapless Board Racks are saltwater friendly, featuring an overmolded design for durability and board protection. Taking the next step in board rack design, verticle orientation and integrated telescopic grab-arms eliminate board chatter while underway securing boards up to 23 inches wide.



- Swivel Attachment Allows You to Rotate Racks Inward 180 Degrees for Safe Storage and Docking
- Vertical Board Orientation and Grab Head Design Decreases the Frequency of Rope Catching when Picking Up Riders
- Telescopic Arm Can Be Independently Adjusted so That Dedicated Slots Have Smaller or Larger Gaps to Account for Wakeboards and Surfboards up to 23 Inches Wide
- Vertical Board Orientation Allows Wet Boards to Drip Outside of Your Boat
- Provides a Secure Fit for Boards of Any Shape & Size
- Board Rack Orientation Provides Improved Ergonomics for Inserting and Removing Boards
- Soft TPU Board Protection with Durable Sandblasted / Anodized Components

**Tine Spread:** 10.0 inches | 25.4 cm

**Tine Gaps:** 2.75 inches | 6.99 cm

**Max Board Width:** 23.0 inches | 58.42 cm

**Materials:** 6061 Aluminum | Overmolded Soft TPU

**Mounting Hardware:** 316 Stainless Steel



# NAUTIQUE

DUAL SURF RACK





# STANDARD:

Super Air Nautique GS20    Super Air Nautique 230  
Super Air Nautique GS22    Super Air Nautique G21  
Super Air Nautique GS24    Super Air Nautique G23  
Super Air Nautique 210    Super Air Nautique G25

## OVERMOLDED FOR PROTECTION.

All Standard Rotating Board Racks are overmolded for protection to stay saltwater and board friendly, Each rack features a brushed anodized backing plate with the Nautique logo and integrated webbed bungee strap with loop.



- Swivel Attachment Allows You to Rotate Racks Inward 180 Degrees for Safe Storage and Docking
- Soft TPU Board Protection
- Durable Sandblasted / Anodized Components
- Fits Boards of Any Shape & Size up to 2.75 Inches Thick
- Double Overhead Crossbars Provide a More Rigid Assembly
- Three Separate Hooking Points to Accommodate Various Board Widths
- Saltwater Friendly

**Tine Spread:** 10.0 inches | 25.4 cm  
**Surf Tine Gap:** 2.75 inches | 6.99 cm

**Materials:** 6061 aluminum | Overmolded soft TPU  
**Mounting Hardware:** 316 Stainless Steel



# NAUTIQUE

PREMIUM OVERSIZED MIRROR





# OPTIONS:

(Optional) Ski Nautique 200

(Standard) G21 | G23 | G25 | SAN G23 Paragon

(Optional) 210 | 230

(Optional) GS-Series

## CAN YOU SEE ME NOW?

The Nautique Premium Oversized Mirror displays a symmetrical design and features a wide viewing angle with a hand grip area for easy adjustments. The large ergonomic knob locks the mirror in position making sure you always have an eye on the action.



- Wide Viewing Area
- Exclusive Mounting Clamp Fits All Nautique Windshield Headers
- Plastic Inserts Provide a Secure Fit While Protecting Your Windshield Header
- Articulating Mirror Provides Optimal Positioning
- Quick Fold for Use with Boat Cover
- Locks in Upright and Folded Positions
- Cast Aluminum Clamp
- **Ski Bracket:** Standard on All Ski Nautique Models, This Low Profile Bracket Gives You the Perfect Viewing Angle Throughout the Entire Course
- **SAN Bracket:** Standard with All G-series Nautique Models, this High-Profile Mount Allows You to Keep Your Eyes Forward without Losing Track of Your Riders

- Symmetrical design with Wide Viewing Angle
- Thumb Grip Area for Mirror Adjustment
- Large Ergonomic Handle to Secure Mirror in Desired Position

Our website offers you a wide variety of t-tops & bimini tops at affordable prices.