



a xylem brand

Panel Switch

INSTRUCTION MANUAL

 CAUTION



Disconnect power from the system before working on the unit to avoid personal injury, damage to the surrounding environment and/or damage to the unit.

CE

CAUTION

Always install proper fuse size to prevent damage to product should a short occur. Failure to install proper fuse could increase risk of pump malfunction potentially resulting in personal injury and/or fire hazard.

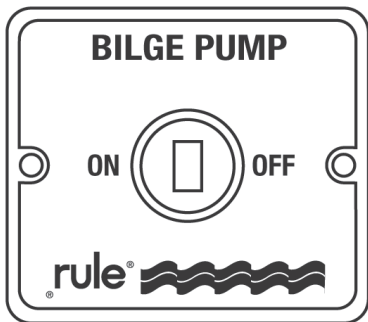

MODEL 49

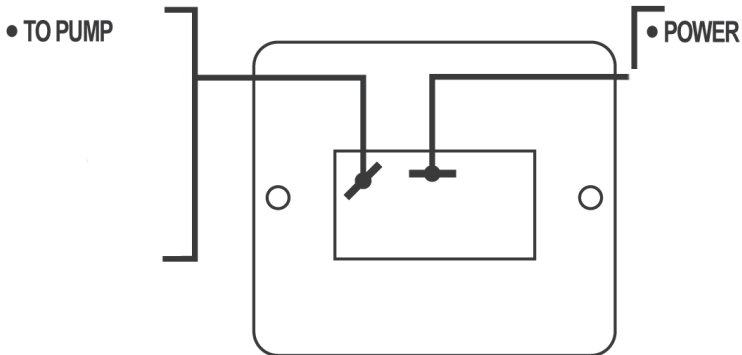

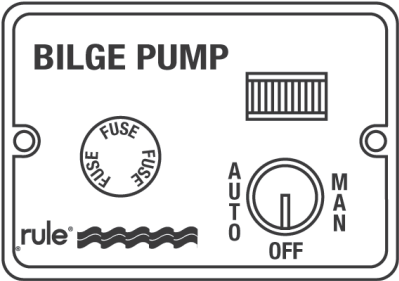

MODEL 41 (12V)
MODEL 42 (24V, 32V)

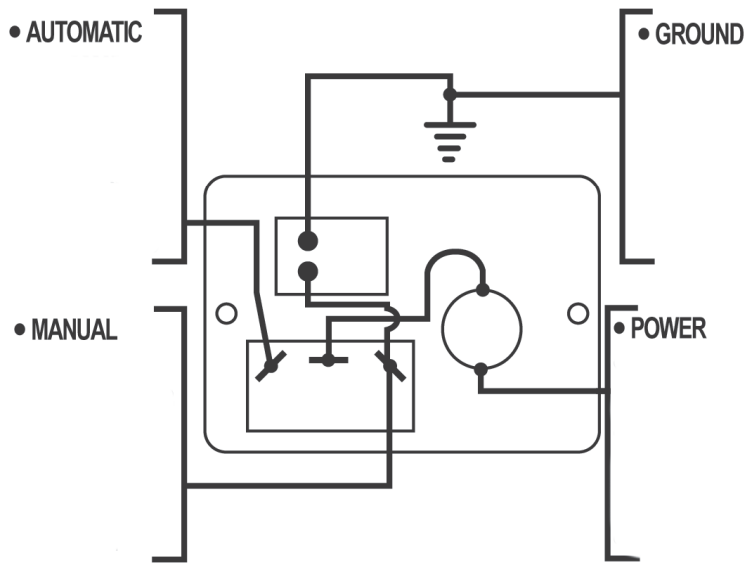

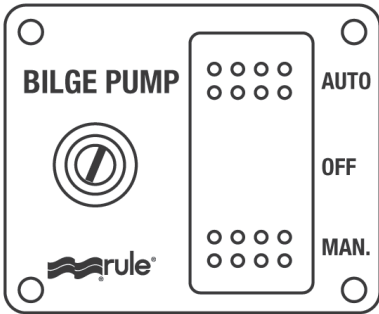

MODEL 43 (12V)
MODEL 44 (24V, 32V)

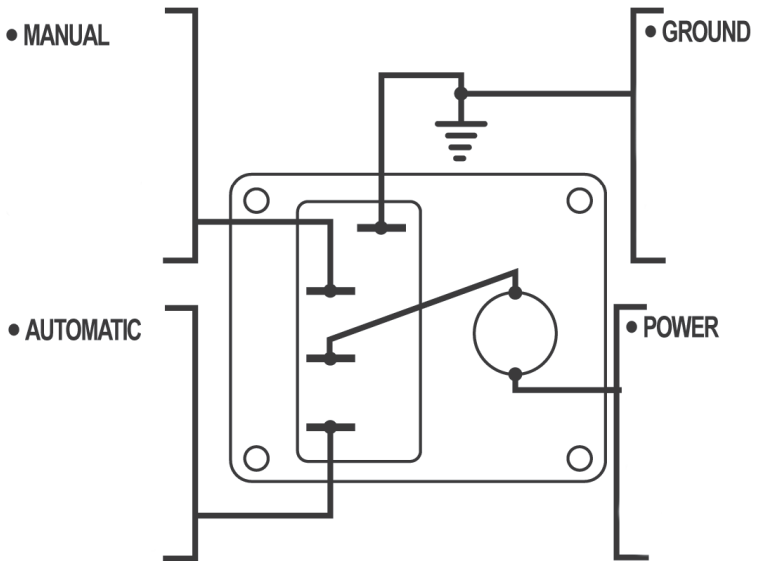

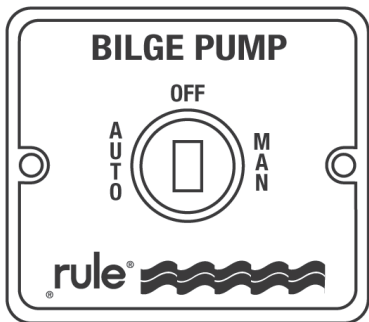

MODEL 45

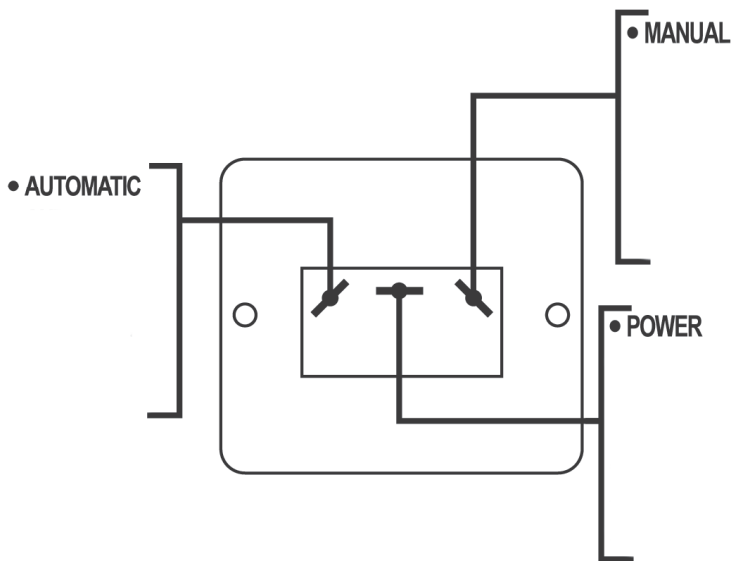

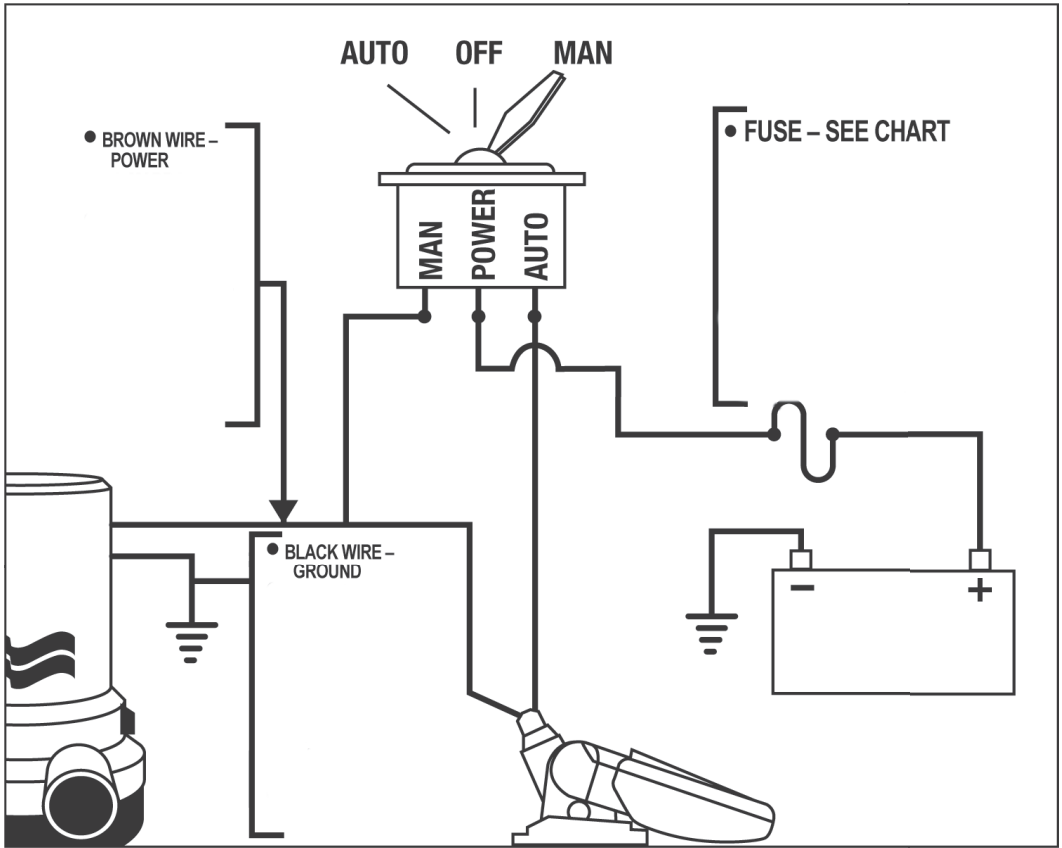

Feel the difference with Rule Pumps.

Check out the collection of boat plumbing we offer.