



a xylem brand

Standard Bilge Pump

INSTRUCTION MANUAL

⚠ WARNING



This pump is designed for use with fresh water and salt water **ONLY**. Use with any other hazardous, caustic, or corrosive material could result in damage to the pump and the surrounding environment, possible exposure to hazardous substances and injury.

CE

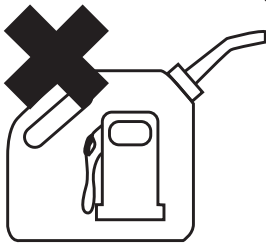
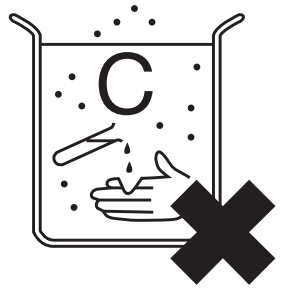



CE Logo

When this product carries a CE mark, it conforms to one or more of the following standards:

EN 61000-6-1:2001 EN 61000-6-3:2007

Following the Provisions of the Electromagnetic Compatibility Directive 2004/108/EC

ISO 8846 / Electrical Devices Protection Against

Ignition of Surrounding Flammable Gases

ISO 8849:2003 / Electrically Operated Bilge Pumps

ISO 10133 / Electrical Systems - Extra Low Voltage D.C. Installations Following the Provisions of the Recreation Craft Directive 94/25/EEC



Disconnect power from the system before working on the unit to avoid personal injury, damage to the surrounding environment and/ or damage to the unit.

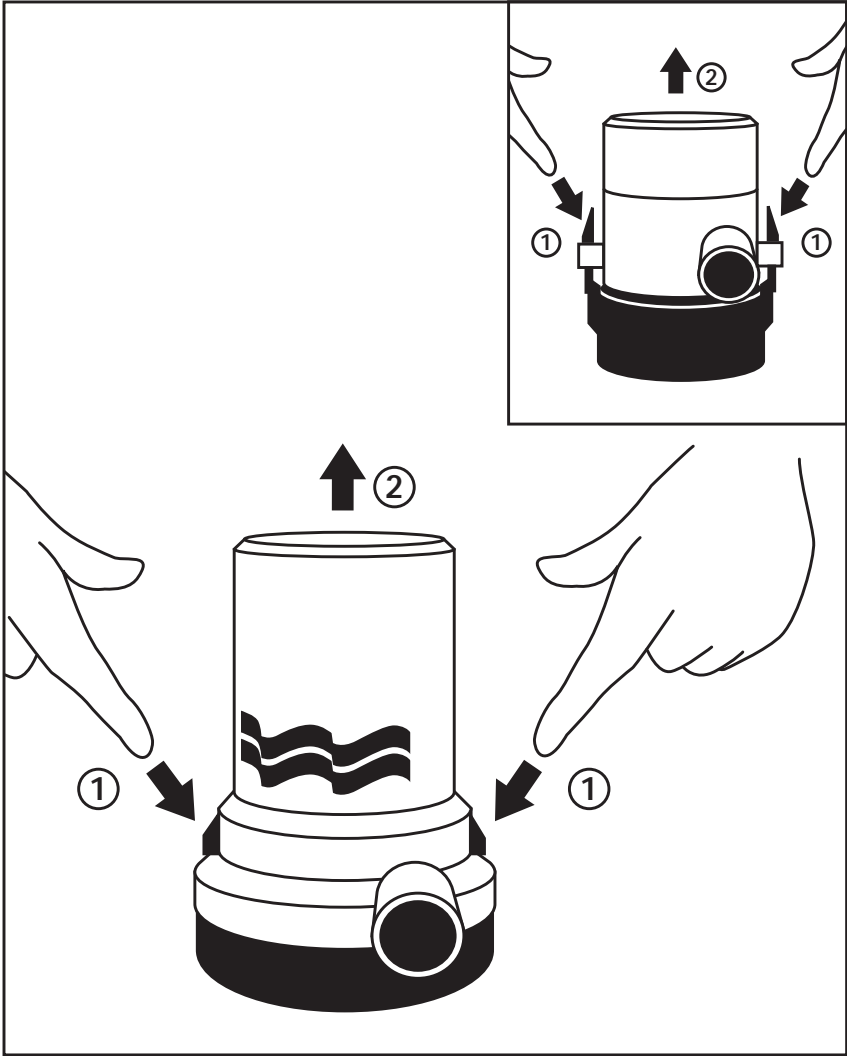

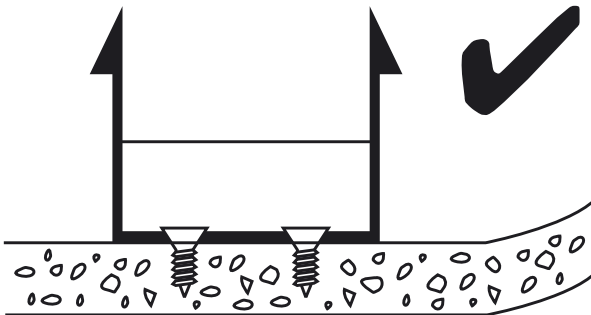
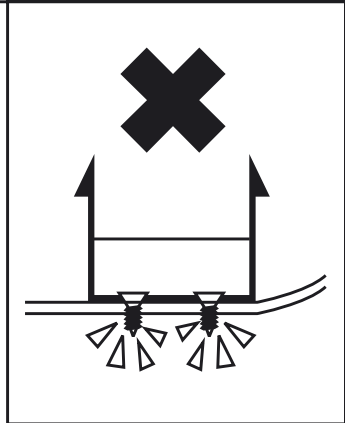
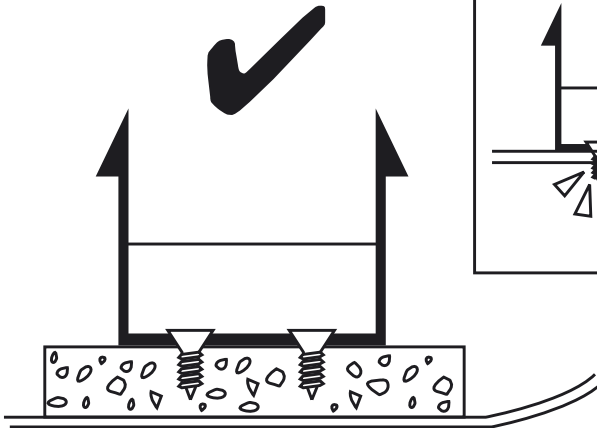

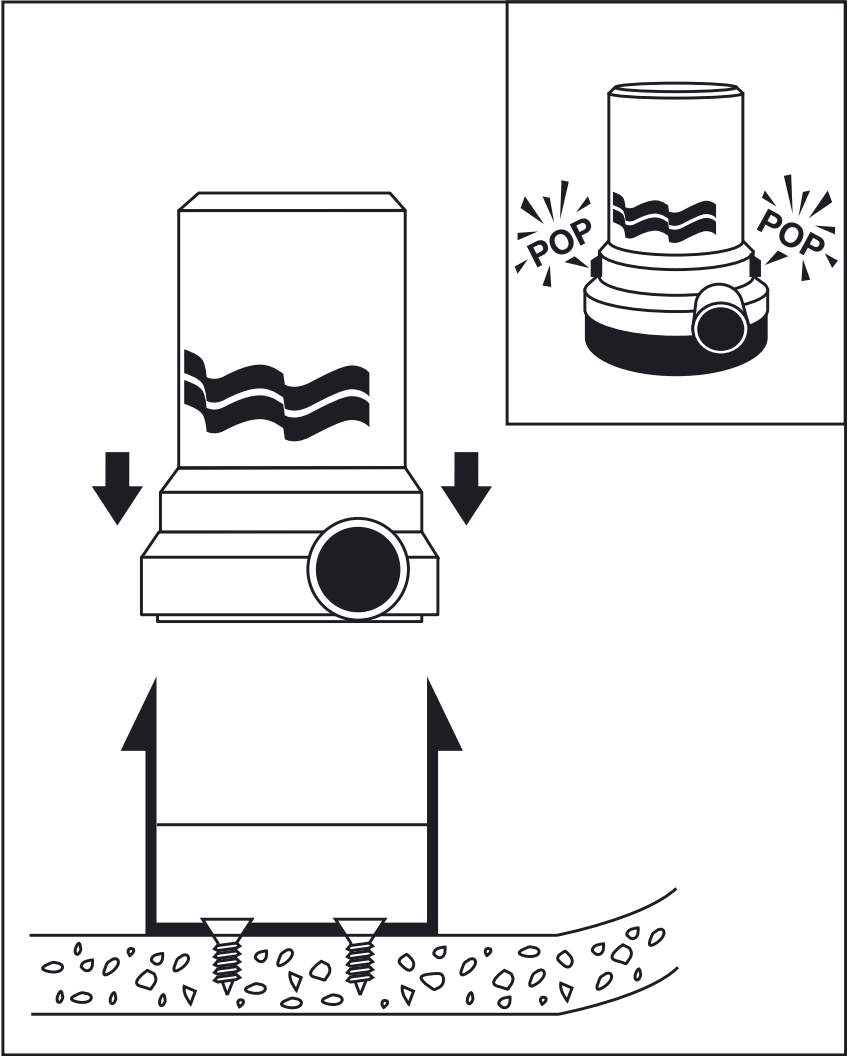

Rated Flow	Open Flow Output @ 0ft/0m (0 kPa) GPH (LPH)	Open Flow Output @ 3.35ft/1m (10 kPa) GPH (LPH)	Open Flow Output @ 6.7ft/2m (20 kPa) GPH (LPH)
360	360 (1362)	265 (1003)	190 (719)
500	500 (1892)	360 (1362)	260 (984)
700	700 (2649)	562 (2127)	330 (1249)
800	800 (3028)	615 (2328)	425 (1608)
1000	1000 (3785)	725 (2744)	450 (1703)
1100	1100 (4164)	860 (3255)	550 (2081)
1500	1500 (5678)	1200 (4542)	680 (2574)
2000	2000 (7570)	1620 (6132)	1300 (4921)
3700	3700 (14006)	2900 (10977)	2450 (9274)
4000	4000 (15142)	3527 (13351)	2952 (11174)
8000	8000 (30283)	7050 (26687)	5984 (22651)
Note: Output is based on 10 hour break-in period and at 13.6V (12V models) or 27.2V (24V models)			

Pump Performance - Large RULE Pumps

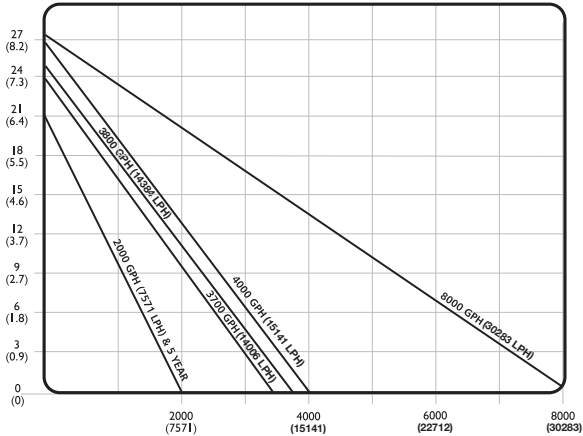

Pump Performance - Small RULE Pumps

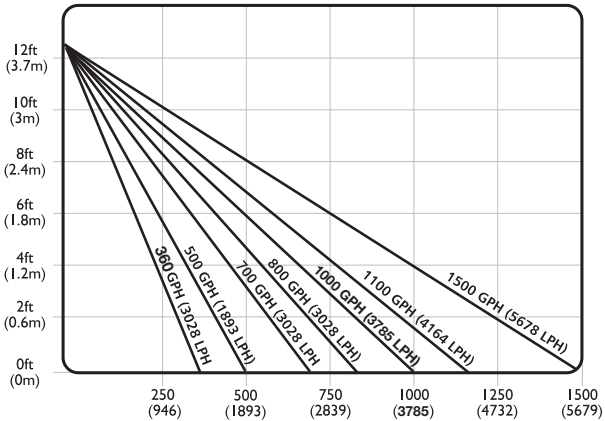

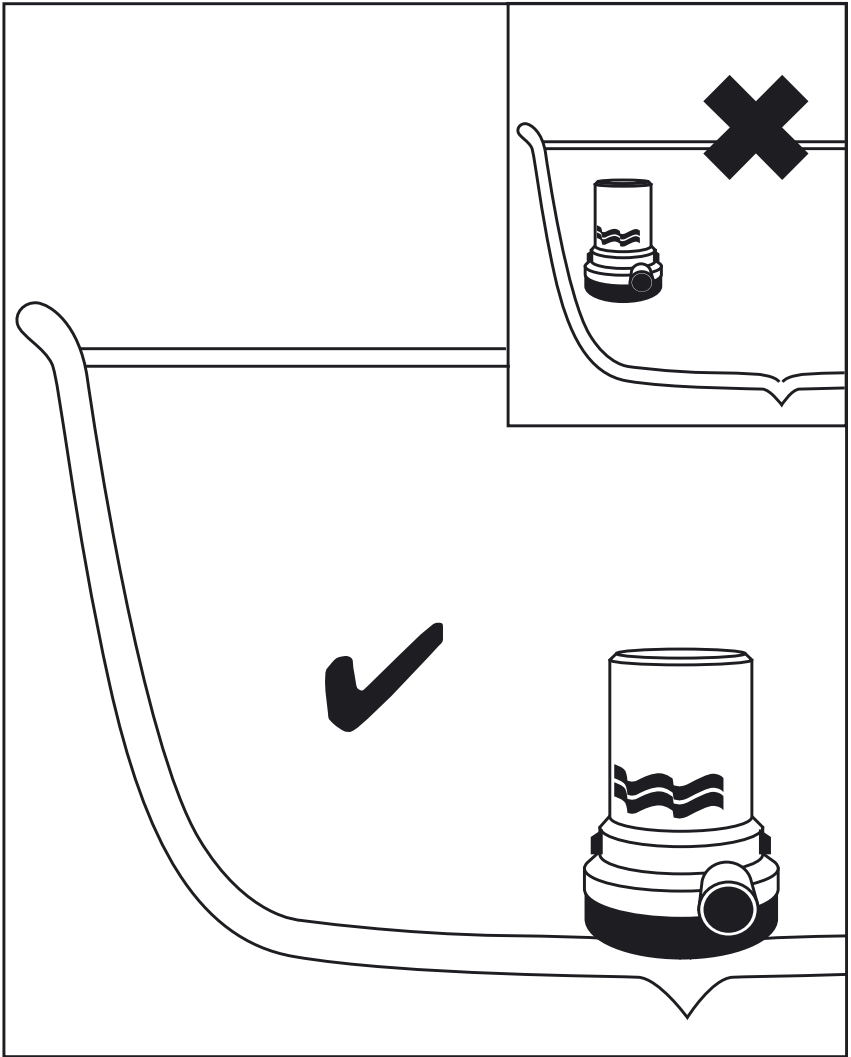

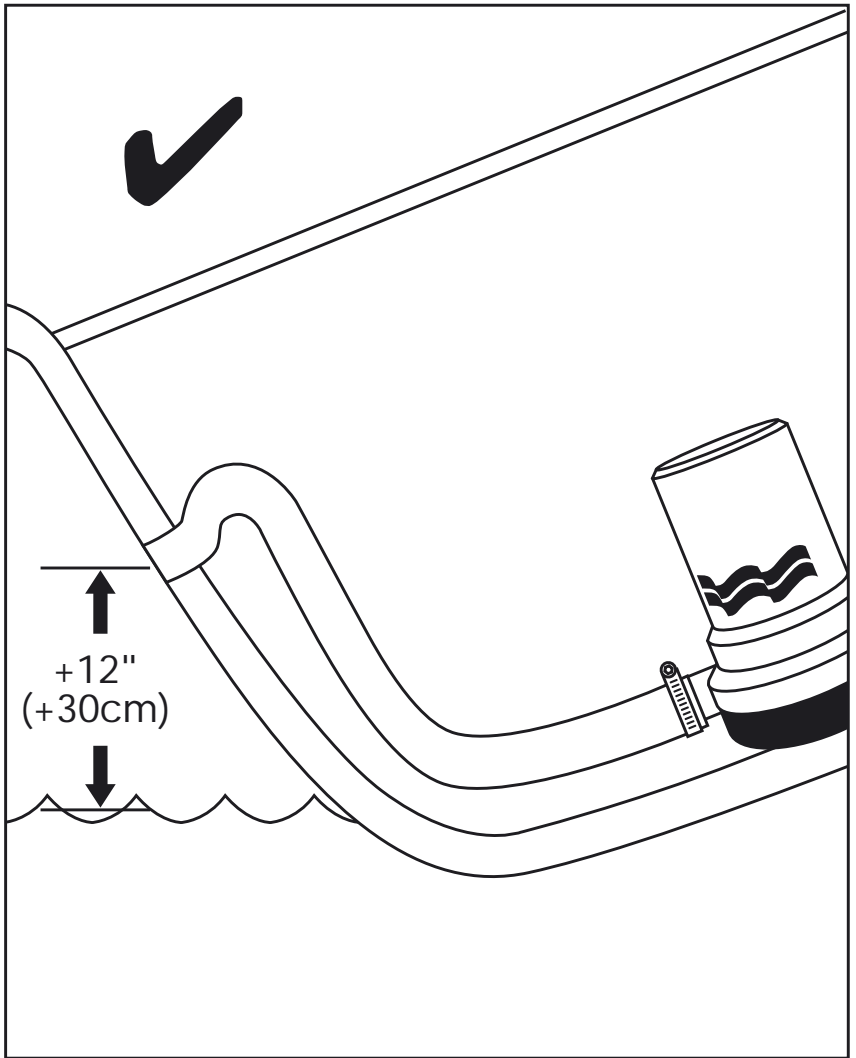

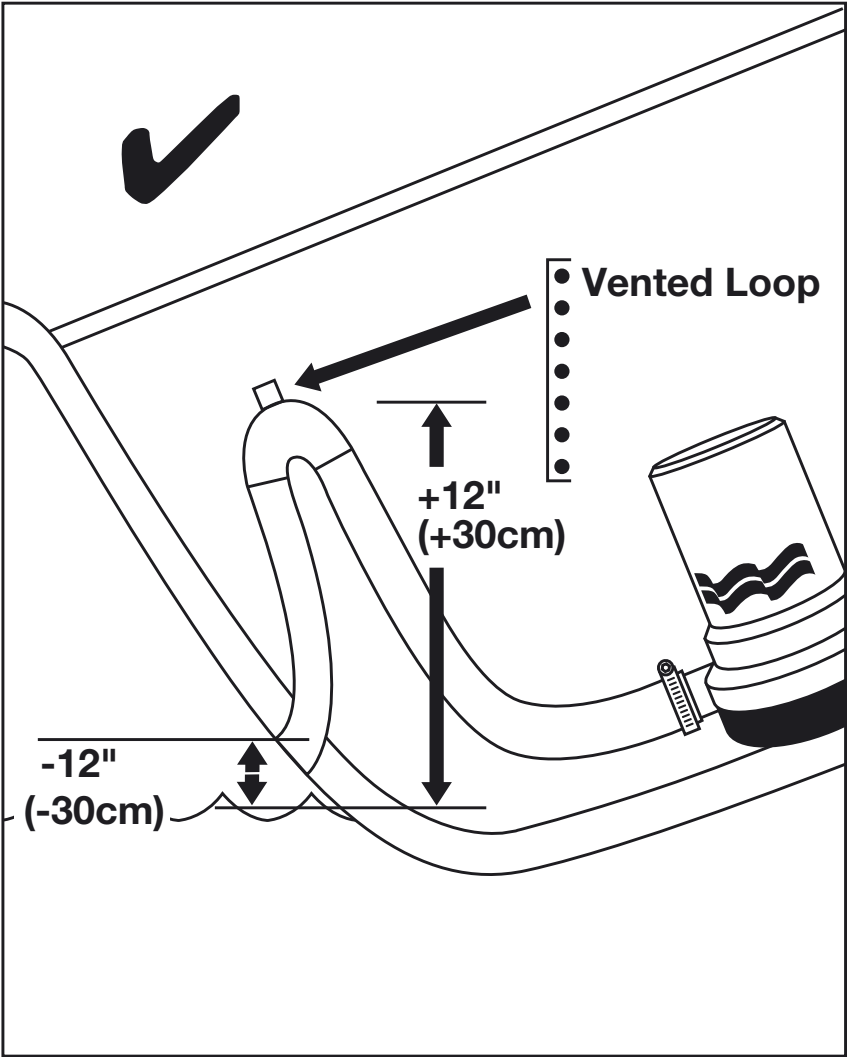

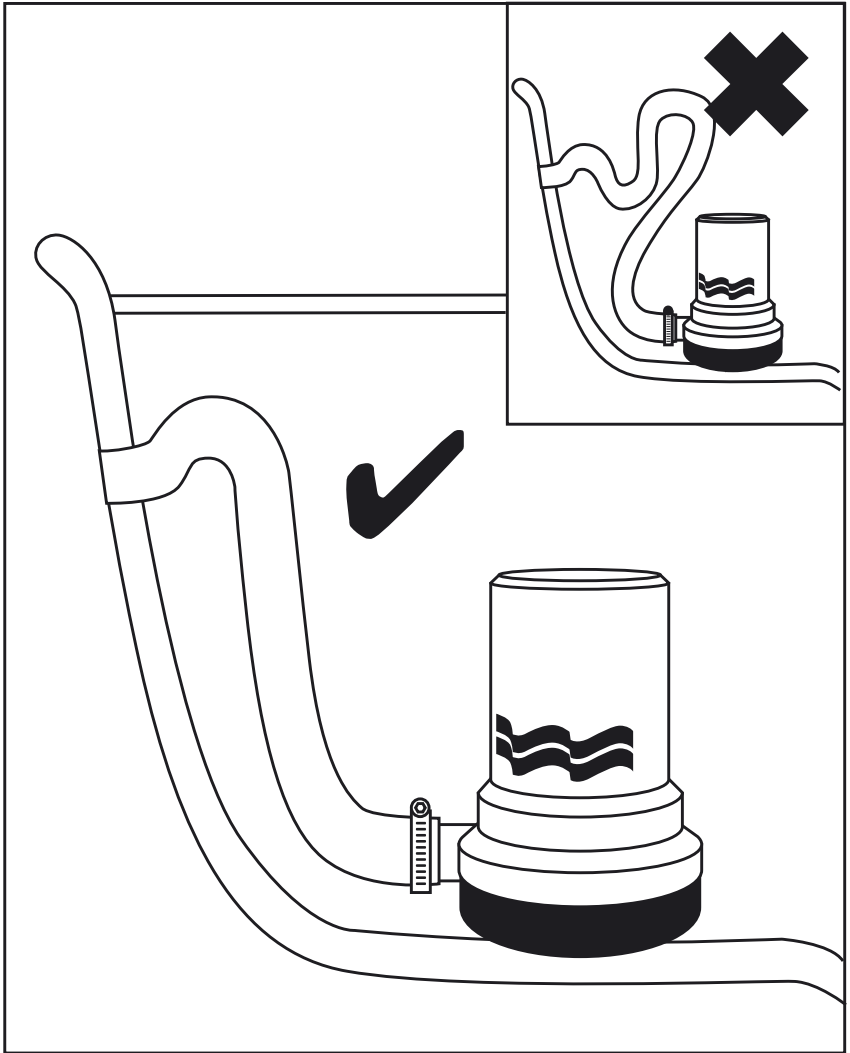

 No Check Valve

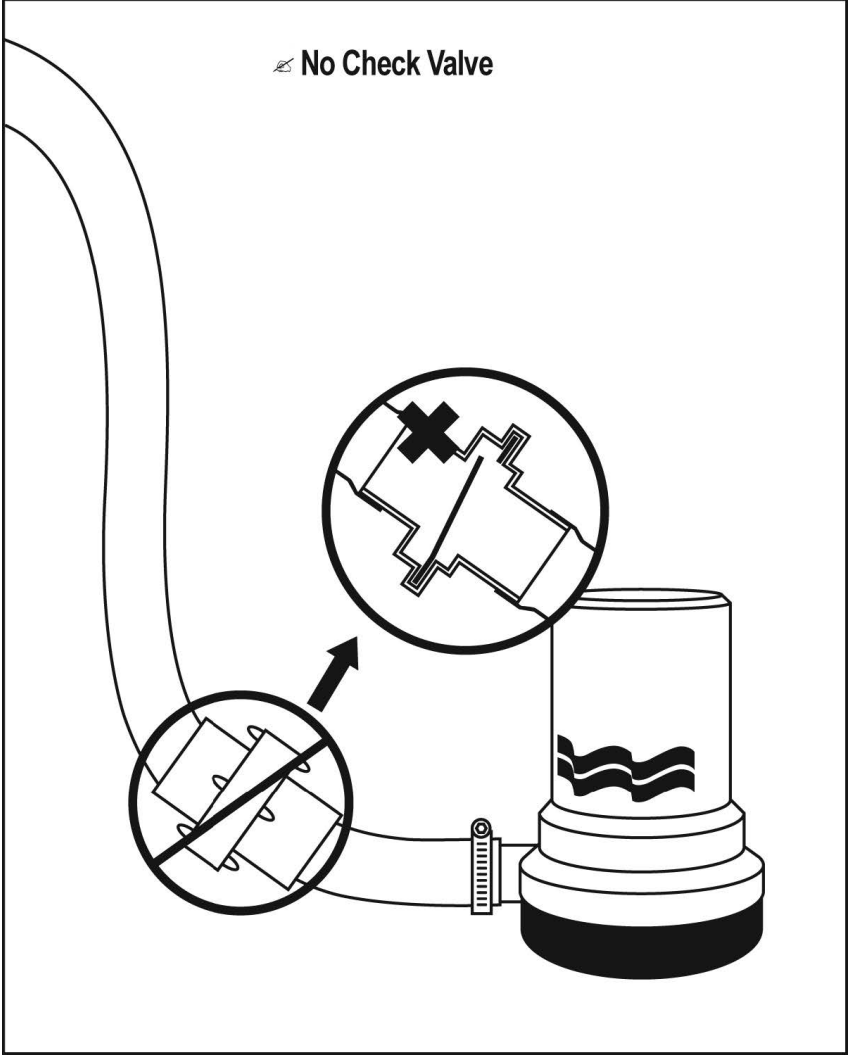

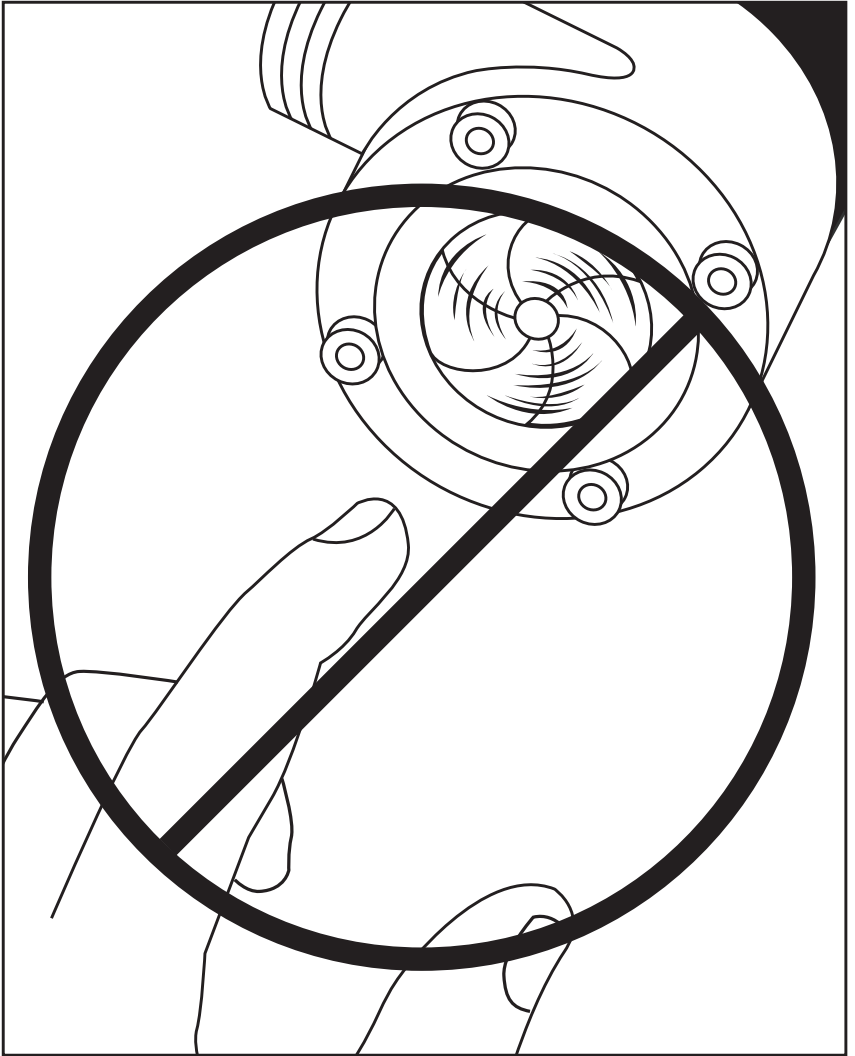

CAUTION



Keep all wire connections above the highest water level. Wires must be joined with butt connectors and a marine grade sealant to prevent wire corrosion.

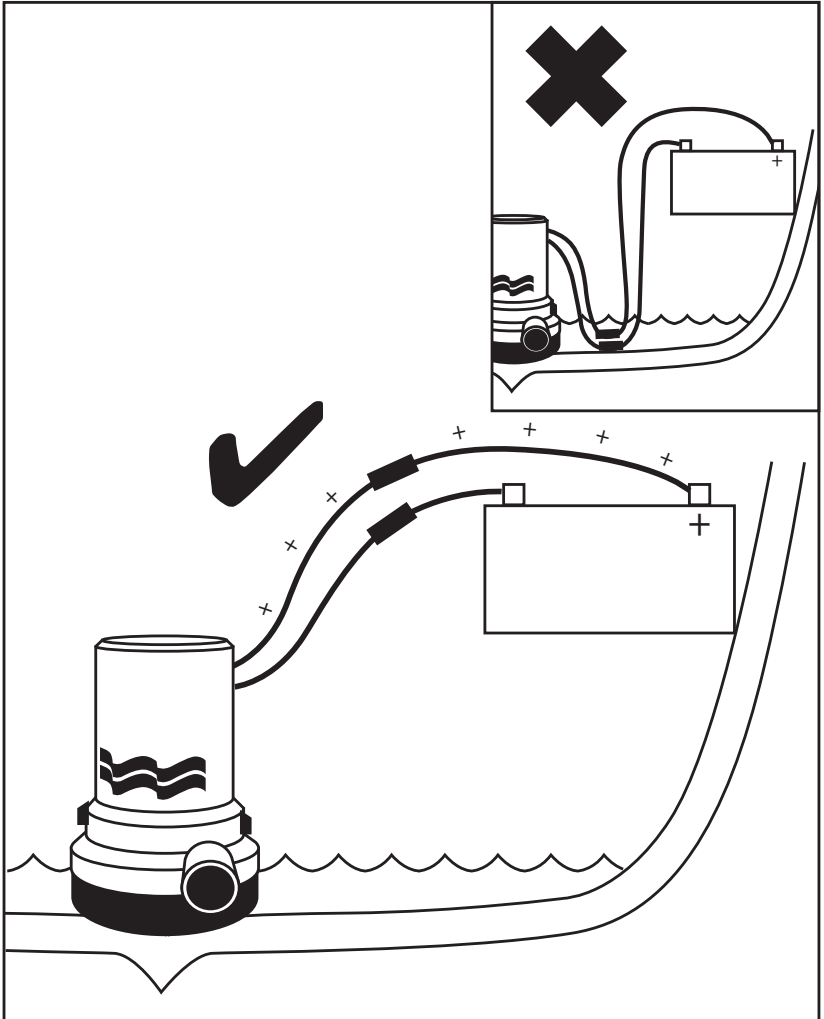

A	B	C	D	E	F
GPH (LPH)	Model	Volts	Amps (Volts)	Amps (Volts)	Fuse Size

A	B	C	D	E	F
8000(30280)	174D	12DC	15.5 (2ea)	20.0 (2ea)	25(2ea)
4000(15140)	56D	12DC	15.5 (12v)	20.0 (13.6v)	25
4000(15140)	56D-24	24DC	6.9 (24v)	10.0 (27.2v)	15
4000(15140)	56D-32	32DC	5.0 (32v)	7.5 (36.3v)	10
3700(14010)	13A	12DC	15.5 (12v)	20.0 (13.6v)	25
3700(14010)	14A	12DC	15.5 (12v)	20.0 (13.6v)	25
3700(14010)	16A	24DC	6.9 (24v)	10.0 (27.2v)	15
3700(14010)	15A	32DC	5.0 (32v)	7.5 (36.3v)	10
2000(7571)	09	12DC	8.4 (12v)	12.0 (13.6v)	15
2000(7571)	10	12DC	8.4 (12v)	12.0 (13.6v)	15
2000(7571)	11	32DC	3.1 (32v)	5.0 (36.3v)	5
2000(7571)	12	24DC	4.0 (24v)	6.0 (27.2v)	7.5
1500(5678)	02	12DC	4.8 (12v)	7.0 (13.6v)	10
1500(5678)	02-6	12DC	4.8 (12v)	7.0 (13.6v)	10

A	B	C	D	E	F
1500(5678)	03	24DC	2.3 (24v)	3.5 (27.2v)	3
1500(5678)	04	12DC	4.8 (12v)	7.0 (13.36)	10
1100(4164)	27D	12DC	3.3 (12v)	5.0 (13.6v)	5
1100(4164)	27D-6	12DC	3.3 (12v)	5.0 (13.6v)	5
1100(4164)	28D	24DC	1.3 (24v)	2.0 (27.2v)	3
1100(4164)	27DC	12DC	3.3 (12v)	5.0 (13.6v)	5
1000(3785)	20A	12DC	2.9 (12v)	4.0 (13.6v)	5
800(3028)	20F	12DC	2.8 (12v)	4.0 (13.6v)	5
800(3028)	20R	12DC	2.8 (12v)	4.0 (13.6v)	5
800(3028)	21R	24DC	1.3 (24v)	2.0 (27.2v)	3
800(3028)	20RC	12DC	2.8 (12v)	4.0 (13.6v)	5
500(1893)	26D	24DC	0.9 (24v)	1.3 (27.2v)	1.5
500(1893)	25D	12DC	1.9 (12v)	2.5 (13.6v)	3
500(1893)	25D-6	12DC	1.9 (12v)	2.5 (13.6v)	3
500(1893)	25D-6WC	12DC	1.9 (12v)	2.5 (13.6v)	3
500(1893)	25DC	12DC	1.9 (12v)	2.5 (13.6v)	3
360(1363)	24	12DC	2.1 (12v)	2.5 (13.6v)	3
360(1363)	24-6DC	12DC	1.9 (12v)	2.5 (13.6v)	3

⚠ CAUTION



Always install proper fuse size to prevent damage to product should a short occur. Failure to install proper fuse could increase risk of pump malfunction potentially resulting in personal injury and/or fire hazard.

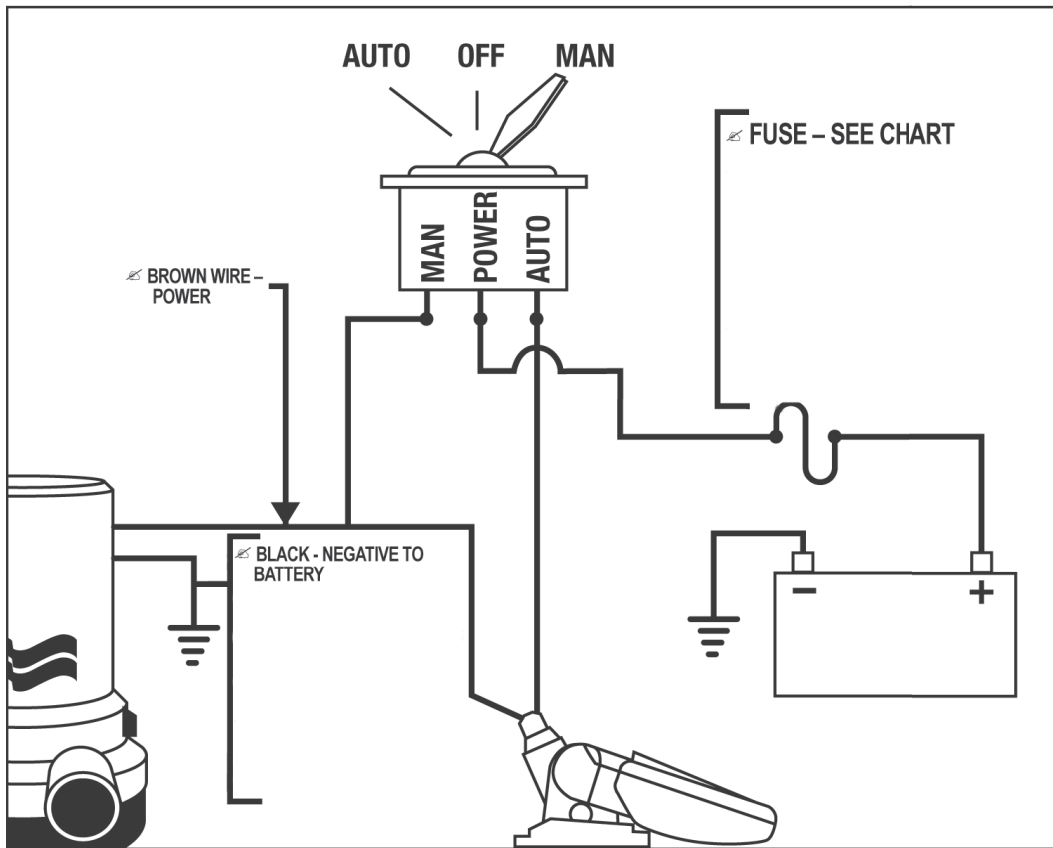

Learn more about other boat plumbing by [Rule Pumps](#) on our website.