



THE QUALITY CHOICE

MARINE ACCESSORIES CATALOG



2018

New KITE FISHING ROD HOLDER



- 3 Flared 1 3/4" diameter rod holders
- Fits most gunnel rod holders

Item#	Material	Case
50-89381	304 Stainless Steel	1

New PADDLE HOLDER



- Mount paddle vertically or horizontal
- Includes 2 nylon brackets and 4 stainless steel screws

Item#	Case
50-71031	12

New OUTBOARD REPLACEMENT FILTER



Optimax/Verado outboard cartridge filter. Replaces Mercury 35-8MM0060041, 8MM0020349, 884380T, Sierra 7981, Parker 31871 and Marpac FF020100 filters

Item#	Micron	Case
50-20981	2	12

New ADJUSTABLE ENGINE FLUSHER



- Telescoping aluminum pole with large rubber cup
- Adjust from 18.5" - 31"

Item#	Length	Case
50-18331	18.5" - 31"	10

New 3 SPOKE STAINLESS STEEL STEERING WHEEL WITH TURNING KNOB



- 304 Stainless steel
- Fits standard 3/4" tapered shafts
- Stainless steel center cap included
- Finger grip and large turning knob

Item#	Dia.	Case
50-28611	13 1/2"	5

New UNIVERSAL GASOLINE AND DIESEL FUEL FILTER



- 8X more total surface area than the 479735 and FEP735 filters
- Clear housing to ensure proper fuel filter maintenance

Item#	Description	Micron	Case
50-20411	1/4" Barb	74	20
50-20421	3/16" Barb	74	20

New WATER SKI ROPE WITH DOUBLE HANDLE



- 16 strand
- Great for beginning Salom Skiers
- Sure grip rubber handles
- Meets SWIA/AWSA requirements
- UV protected
- Rope keeper included

Item#	Length	Sections	Tensile Strength	Case
50-86729	75'	1	1600 lbs.	6

New 4-SECTION WAKEBOARD ROPE



- 16 strand
- 15" EVA grip handle w/floats
- 6" trick handle
- Meets WSIA/AWSA requirements
- UV protected
- Rope keeper included

Item#	Length	Sections	Tensile Strength	Case
50-86723	70'	4 Floatable (5', 35', 10', 10' & 10')	1200 lbs.	6

New 3-SECTION WAKEBOARD ROPE



- 16 strand
- 15" EVA grip handle
- 6" trick handle
- Meets WSIA/AWSA requirements
- UV protected
- Rope keeper included

Item#	Length	Sections	Tensile Strength	Case
50-86724	65'	3 (45', 10' & 10')	1200 lbs.	6

New 5-SECTION REFLECTIVE WAKEBOARD ROPE



- 16 strand w/ reflective tracer
- 15" EVA grip handle
- Meets WSIA/AWSA requirements
- UV protected
- Rope keeper included

Item#	Length	Sections	Tensile Strength	Case
50-86726	75'	5 (45', 10', 10', 5' & 5')	1500 lbs.	6

New 1-SECTION WATER SKI ROPE



- 16 strand
- Foam over aluminum handle
- Meets SWIA/AWSA requirements
- UV protected
- Rope keeper included

Item#	Length	Sections	Tensile Strength	Case
50-86727	75'	1	1000 lbs.	6

New 1-SECTION MULTI-USE SKI ROPE



- 16 strand
- EVA Radius Rubber handle for comfort grip
- For skiing, wake or knee boarding
- Meets SWIA/AWSA requirements
- UV protected
- Rope keeper included

Item#	Length	Sections	Tensile Strength	Case
50-86728	75'	1	1200 lbs.	6

New 1-SECTION WATER SKI ROPE



- 16 strand
- Sure grip rubber handles
- For skiing, wake or knee boarding
- Meets SWIA/AWSA requirements
- UV protected
- Rope keeper included

Item#	Length	Sections	Tensile Strength	Case
50-86731	75'	1	1600 lbs.	6

New 3-SECTION WATER SKI ROPE



- 16 strand
- EVA Radius Rubber handle for comfort grip
- For skiing, wake or knee boarding
- Meets SWIA/AWSA requirements
- UV protected
- Rope keeper included

Item#	Length	Sections	Tensile Strength	Case
50-86733	75'	3 (45', 15' and 15')	1600 lbs.	6

New 4-SECTION WATER SKI ROPE



- 16 strand
- EVA Radius Rubber handle for comfort grip
- For skiing, wake or knee boarding
- Meets SWIA/AWSA requirements
- UV protected
- Rope keeper included

Item#	Length	Sections	Tensile Strength	Case
50-86734	75'	4 (40', 10', 10' and 15')	1600 lbs.	6

New 1-SECTION WATERSPORTS ROPE



- 16 strand
- EVA Radius handle for comfort grip
- For skiing, wake or knee boarding
- Meets SWIA/AWSA requirements
- UV protected
- Rope keeper included

Item#	Length	Sections	Tensile Strength	Case
50-86736	75'	1	2,000 lbs.	6

New 1-RIDER TUBE TOW ROPE



- 16 strand
- Meets WSIA/AWSA requirements
- UV protected
- Reusable storage keeper included

Item#	Length	Tensile Strength	Max Load	Case
50-86737	50'	1600 lbs.	170 lbs.	6

New 4-RIDER BUNGEE TUBE TOW ROPE



- 16 strand
- Bungee absorbs sudden jerk
- Meets WSIA/AWSA requirements
- UV protected
- Reusable storage keeper included

Item#	Length	Tensile Strength	Max Load	Case
50-86738	50'	4100 lbs.	680 lbs.	6

New REFLECTIVE TUBE TOW ROPE



86739



86741



86743

- 16 strand w/ reflective tracer
- Meets WSIA/AWSA requirements
- UV protected
- Reusable storage keeper included

Item#	Length	Riders	Tensile Strength	Max Load	Case
50-86739	60'	2	2300 lbs.	340 lbs.	6
50-86741	60'	4	2300 lbs.	680 lbs.	6
50-86743	60'	6	6000 lbs.	1020 lbs.	6

New TUBE TOW ROPE



86746



86744

- 16 strand
- Meets WSIA/AWSA requirements
- UV protected
- Reusable storage keeper included

Item#	Length	Riders	Tensile Strength	Max Load	Case
50-86746	60'	2	2300 lbs.	340 lbs.	6
50-86744	60'	4	4100 lbs.	680 lbs.	6

New EXTRA STRENGTH TOW HARNESS



- For boats without pylon or ski eye
- Use to pull skier, boarders and up to a 5 rider tube
- 6" float to keep 12' attachment floating
- Meets WSIA/AWSA requirements
- UV protected
- Tensile strength 4100 lbs.

Item#	Case
50-86748	6

New SUPER HEAVY DUTY BOAT TOW HARNESS



- For boats without pylon or ski eye
- Includes heavy duty hooks
- Use to pull skier, boarders and up to a 5 rider tube
- 6" float to keep 16' attachment floating
- Meets WSIA/AWSA requirements
- UV protected
- Tensile strength 4100 lbs.

Item#	Case
50-86749	6

New SELF-CENTERING BOAT TOW HARNESS



- For boats without pylon or ski eye
- Use to pull skier, boarders and towables
- 2 Riders
- Pulley glides on rope
- 6" float to keep 12' attachment floating
- Meets WSIA/AWSA requirements
- UV protected
- Tensile strength 3000 lbs.

Item#	Case
50-86751	6

New 2-SECTION TUBE TOW ROPE



- 16 strand
- Floatable sections
- Meets WSIA/AWSA requirements
- UV protected
- Reusable storage keeper included

Item#	Length	Riders	Sections	Tensile Strength	Max Load	Case
50-86766	60'	2	10' & 50'	2300 lbs.	340 lbs.	6
50-86767	60'	4	10' & 50'	4000 lbs.	680 lbs.	6

New TUBE ROPE CONNECT



- Easily attach and detach tube ropes to towables.
- Use with up to 4 riders
- High strength plastic connector
- Meets WSIA/AWSA requirements
- UV protected
- Tensile strength 4000 lbs.

Item#	Case
50-86759	6

New TOW HARNESS



- For boats without pylon or ski eye
- Ideal for pulling skier, boards or 1 rider tubes
- 6" float to keep 12' attachment floating
- Meets WSIA/AWSA requirements
- UV protected

Item#	Size	Tow Capacity	Case
50-86761	12'	2300 lbs.	6

New ANCHOR BUNGEE ANCHOR LINE



- Stretches from 14' - 50'
- Used for boat mooring and to pull boats away from shore into safer water
- Floating heavy duty 16 strand rope
- UV protected
- Tensile strength 2500 lbs.

Item#	Case
50-40521	6

New PWC SAND ANCHOR WITH BUOY



Made of heavy duty laminate material. Includes: buoy, snap hook and 10' of polyethylene line. Holds approximately 30 pounds of sand or rock.

Item#	Case
50-41171	12

New PWC DOCK LINE



- 16-strand
- Floats
- Attach to ski, bow eyes and mooring rings
- 10" loop at ends
- UV protected
- Tensile strength 2000 lbs.

Item#	Length	Case
50-40531	7'	6

New TOW ROPE FOR PWC



- 16-strand
- Floats
- Snap hooks at ends
- UV protected
- Tensile strength 2000 lbs.
- Includes re-usable keeper

Item#	Size	Case
50-40541	3/8" x 20'	6

New WHISTLE



Audible signal device. Clips easily to life vests or doubles as a floating key chain.

Item#	Color	Case
50-11726	Red	12
50-11727	Yellow	12

New VINYL WATER SKI FLAG



Vinyl, bright orange flag attached to a 24" PVC pole. Conforms to AZ, CA, CO, ID, MO, NE, NM, OR, TX, UT and WA laws.

Item#	Length	Color	Case
50-78343	24"	Orange	12

New ULTIMATE LANYARD



- 4 Keys
- Fit: Sea Doo, Yamaha, Kawasaki, Honda, Polaris, Tiger Shark and Wet Jet

Item#	Description
50-11721	Red/Black
50-11723	Purple/Yellow
50-11724	Blue/Silver

New NYLON WATERSPORTS FLAG



Nylon flag is attached to a PVC pole. It conforms to AZ, CA, CO, ID, MO, NE, NM, OR, TX, UT & WA laws. Recommended everywhere for safety.

Item#	Length	Color	Case
50-78344	24"	Orange	12

New DELUXE NYLON WATERSPORTS FLAG



Watersports flags are required by law in AZ, CA, CO, ID, MO, NE, NM, NJ, OR, TX, UT & WA. 4' Black shaft is made of PVC. An EVA foam grip ensures a comfortable and secure hold. The oversized nylon flag resists fading.

Item#	Length	Color	Case
50-78346	4'	Orange	12

New NYLON SKIER DOWN FLAG WITH SUCTION CUP



Features the giant 3 1/4" suction cup, rated at 60 lbs. Durable nylon flag mounted to a PVC pole. Attaches to any smooth surface. Mounts vertically or horizontally. Conforms to AZ, CA, CO, ID, MO, NE, NM, OR, TX, UT and WA laws.

Item#	Length	Color	Case
50-78349	24"	Orange	12

New FOOT AIR PUMP

- For Inflatable Boats, Toys, Towables, Air Beds, Balls, and more
- High Volume air flow
- Inflates or deflates quickly
- Comes with various valves and 4.5' hose
- ½ liter per stroke @ 2 PSI

Item#	Case	
50-86993	12	
Repl. Parts	Description	Case
50-86973	Hose and Adapters	1

New 12V ELECTRIC AIR PUMP

- For Inflatable Boats, Toys, Towables, Air Bed, Balls, and more
- Inflates or Deflates Quickly
- Comes with various valves, 2' Inflator hose and 10' power cord
- Draws 22 Amps at 1.0 PSI

Item#	Volts	Case
50-86981	12	12
Repl. Parts	Description	Case
50-86969	Hose and Adapters	1

New 120V ELECTRIC AIR PUMP

- For Inflatable Boats, Toys, Towables, Air Beds, Balls, and more
- Inflates or deflates quickly
- Comes with various valves, 2' hose and 10' power cord
- Draws 3.5 Amps at 2.2 PSI

Item#	Volts	Case
50-86983	120	12
Repl. Parts	Description	Case
50-86969	Hose and Adapters	1

New 120V SUPER ELECTRIC AIR PUMP

- For Inflatables Boats, Toys, Towables, Air Beds, Balls and more
- Inflates or deflates quickly
- Comes with various valves, 2' hose and 10' power cord
- Draws 1.6 Amps at .78 PSI

Item#	Volts	Case
50-86986	120	12
Repl. Parts	Description	Case
50-86976	Hose and Adapters	1

New 12V HIGH PRESSURE AIR PUMP

- For Inflatable Boats, Toys, Towables, Air Beds, Balls, and more
- Inflates or deflates quickly
- Comes with various valves, 2' hose and 9' power cord with Battery Clips and Pressure Release Valve
- 2.3 PSI Inflator/Deflator

Item#	Volts	Case
50-86987	12	12
Repl. Parts	Description	Case
50-86977	Hose and Adapters	1

New 120V MAX AIR PUMP

- For Inflatable Boats, Toys, Towables, Air Beds, Balls, and more
- High Volume air flow
- Inflates or deflates quickly
- Comes with various valves, 2' hose and 10' power cord
- Draws 7 Amps at 3 PSI

Item#	Volts	Case
50-86988	120	4
Repl. Parts	Description	Case
50-86978	Hose and Adapters	1

New 120V SUPER AIR PUMP

- For Inflatable Boats, Toys, Towables, Air Bed, Balls, and more
- High Volume air flow
- Inflates or Deflates Quickly
- Comes with various valves and 2' Inflator hose and 10' power cord
- Draws 6 Amps at 2.5 PSI

Item#	Volts	Case
50-86989	120	12
Repl. Parts	Description	Case
50-86979	Hose and Adapters	1

New WATER GUN

- Quick-filling
- Constructed of high-impact thermoplastics
- Range of up to 60'
- Floats on top of the water

Item#	Length	Case
50-86871	12"	6
50-86881	18"	6
50-86891	24"	6

New DOUBLE ACTION PUMP

- Double action works on both up and down strokes
- Inflates and Deflates
- Provides up to 15 PSI pressure
- Includes a 50" accordian style hose with 4 nozzles to fit most valves
- Use for rubber boats, inflatable mattresses, watertoys and more

Item#	Case	
50-86991	6	
Repl. Parts	Description	Case
50-86971	Hose and Adapters	1

New 8-SECTION WATER SKI ROPE

- 16 strand
- Diamond grip rubber handle
- Full length finger protection
- Excellent for slalom courses
- Meets SWIA/AWSA requirements
- UV protected
- Rope keeper included

Item#	Length	Sections	Tensile Strength	Case
50-86763	75'	8 Colored	1600 lbs.	6

New 3-SECTION WAKESURFING ROPE

- 16 strand
- Extra large braid rope
- Sure grip rubber handles
- Meets SWIA/AWSA requirements
- UV protected
- Tensile strength 1200 lbs.
- Rope keeper included

Item#	Length	Sections	Case
50-86764	16'	3	6

New NEW JERSEY SKI FLAG W/ SUCTION CUP



Required by law in New Jersey. Attach it to windshields, boat finishes and PWC's with the included suction cup.

Item#	Length	Color	Case
50-78339	48"	Orange	12

New KEYHOLE LIFE VEST - CANADA ONLY



99685



99695

- Heavy duty adjustable waist belts with quick-release buckle
- One size fits most
- Lightweight soft PE foam for comfort
- Collar with old an unconscious person's face out of the water
- Ultra durable 210D nylon outer & inner shell

Item#	Size	Weight	Chest	Color	Case
50-99685	Adult	41kg. +	76 - 32cm	Red	12
50-99695	Adult	41kg. +	76 - 32cm	Red	2

New SEA BEAST TUBE



(Continued)

- Tuff Shell Full Nylon Cover w/Zipper
- Heavy-Gauge PVC Bladder
- Double Webbing Foam Handles with Knuckle Guards
- EVA Foam Pad
- Reinforced Towing System
- Speed Valve for Fast Inflation and Deflation
- Zippered Valve Cover
- Tapered Construction is Higher in the Front Than Back to Prevent Submerging and Give the Rider Wild Wake Action

Item#	Riders	Size	Case
50-86911	1 (170 lbs.)	50" x 48"	4
50-86921	1-2 (340 lbs.)	60" x 56"	3
50-86931	1-3 (510 lbs.)	75" x 62"	2

New SEA SERPENT TUBE



- Heavy Duty Partial Nylon Cover
- Heavy-Gauge PVC Bladder
- Double Webbing Foam Handles with Knuckle Guards
- Flat Foam Handles
- Reinforced Towing System
- Speed Valve for Fast Inflation and Deflation
- Zippered Valve Cover
- Arrow Shape Construction for Stability and More Control
- Drain Vent

Item#	Riders	Size	Case
50-86901	1 (170 lbs.)	50" x 48"	4

New GENERAL PURPOSE VEST - CANADA ONLY



99575



99585



99545



99555

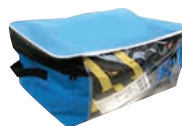

99605

- Ultra durable 210D nylon outer & inner shell
- Segmented PE foam hinge on the back provides extra comfort
- More environmentally friendly, ultra comfortable PE foam inner
- Oversized armholes for increased mobility
- ULC/D.O.T. Approved
- Quick-release buckles with adjustable webbing for safety and great fit
- Built-in drain holes
- **Child Sizes Include:** Segmented pillow for comfort & crotch strap for safety & for a secure fit

Item#	Size	Weight	Chest	Color	Case
50-99575	Child	14 - 27kg	-	Blue	12
50-99585	Adult	41kg. +	91 - 132cm	Blue	12
50-99595	Adult XL	41kg. +	102 - 152cm	Blue	12
50-99615	Adult 4 Pk.	41kg. +	91 - 132cm	Blue	12
50-99545	Child	14 - 27kg	-	Red	12
50-99555	Adult	41kg. +	91 - 132cm	Red	12
50-99565	Adult XL	41kg. +	102 - 152cm	Red	12
50-99605	Adult 4 Pk.	41kg. +	91 - 132cm	Red	12

New 4-BELT SKI VEST - CANADA ONLY



99655 99625

- Ultra durable 210D nylon outer & inner shell
- Oversized armholes for increased mobility
- Quick release buckles with adjustable belt for a great fit
- ULC/D.O.T. Approved
- Personal water craft key holder for safety
- More environmentally friendly PE foam inner provide ultra comfort
- Build-in drain holes

Item#	Size	Weight	Chest	Color	Case
50-99655	S/M	41kg. +	81 - 102cm	Blue	12
50-99665	L/XL	41kg. +	102 - 122cm	Blue	12
50-99675	2XL/3XL	41kg. +	127 - 152cm	Blue	2
50-99625	S/M	41kg. +	81 - 102cm	Red	12
50-99635	L/XL	41kg. +	102 - 122cm	Red	12
50-99645	2XL/3XL	41kg. +	127 - 152cm	Red	12

New SCREW ANCHOR SYSTEM



Perfect for anchoring a PWC in sand and mud in shallow water. Anchor is attached to a 10' line. Includes float and storage bag.

Item#	Case
50-41192	1

New STAINLESS STEEL PLOW ANCHOR



Stainless Steel quick setting design provides stability and high holding power. Perfect for sand, pebble, rock, grass, kelp and coral bottoms.

Item#	Weight	Boat Size	Case
50-43840	14 lbs.	20-30'	1
50-43850	22 lbs.	30-40'	1
50-43860	35 lbs.	40-50'	1
50-43870	44 lbs.	40-50'	1

New PVC COATED SLIP-RING ANCHOR

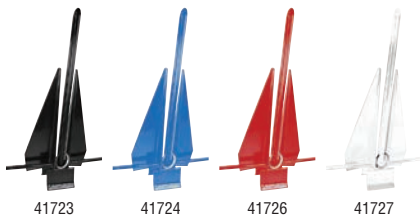

41723 41724 41726 41727

Provides protection to boat finishes form scratches and abrasions.

Item#	Weight	Boat Size	Color	Case
50-41723	8 lbs.	Up to 24'	Black	4
50-41724	8 lbs.	Up to 24'	Blue	4
50-41726	8 lbs.	Up to 24'	Red	4
50-41727	8 lbs.	Up to 24'	White	4

New RICHTER ANCHOR



Unique combination of river and grapnel anchors features the ease of retrieval of a slip ring anchor when buried or tangled.

Item#	Anchor Weight	Boat Size	Case	Color
50-41450*	14 lbs.	To 18'	2	Black
50-41460	18 lbs.	To 24'	2	Black
50-41470	25 lbs.	To 32'	2	Black

New FOLD-AND-HOLD ANCHOR



Sets quickly in any bottom surface. Retrieves easily. Folds flat for storage. Hot dipped galvanized. Storage bag included.

Item#	Weight	Material	For	Case
50-43770	13 lbs.	Galvanized	Personal Watercraft	1
50-43780	19 lbs.	Galvanized	Offshore/Sport 18'-30', Cabin Cruiser to 24'	1
50-43790	25 lbs.	Galvanized	Offshore/Sport to 40', Cabin Cruiser to 32'	1

New PWC FLUKE ANCHOR KIT



Vinyl coated fluke anchor is ideal for PWC and small boats. Includes 25' line and storage bag. Anchor approximately 1 3/4 lbs.

Item#	Weight	Case
50-41160	Approx. 1 3/4 lbs.	6

New BEACH SPIKE



Ideal for securing you boat or PWC to shore. Self-driving hammer action. Galvanized with rubber coated handle for protection.

Item#	Size	Boat Size	Case
50-43810	Small	up to 22'	1
50-43820	Large	up to 30'	1

New BUNGEE/STRETCH DOCK LINE



- Absorbs shock to boats, cleats docks, etc.
- Includes foam protectors to prevent chafing
- Plastic adjustments at each end for quick docking
- Two (2) lines included

Item#	Length	Case
50-42461	6' - Stretches to 9'	6
50-42471	4' - Stretches to 5.5'	6
50-42481	4' - Stretches to 7'	6

New SOFT ROPE SHACKLE



In Use

Used in place of metal shackles. Will not damage paintwork, corrode or rust. Made of UHMWPE - has both the highest abrasion resistance and highest impact strength of any plastic.

43311: Dimension: .25" x 3.15" (equivalent: 3/8" metal shackle)
43321: Dimension: .55" X 5.9" (equivalent: 3/4" metal shackle)

Not recommended for use where personal safety is involved.

Item#	Break Strength	Case
50-43311	6,500 lbs.	12
50-43321	33,000 lbs.	12

New LED FLOOD BEAM WORK LIGHT



Heavy duty design with powder coated die cast aluminum housing, polycarbonate lens and stainless steel mounting hardware. IP69K Rating: Highest designation available for water ingress testing, offering increased reliability and service life when subjected to severe environmental conditions or cleaning methods.

Item#	LEDs	LED Color	Lumens	Shape	Size	Volts	Case
50-51601	4	White	670	Round	3.27" W x 5.70" H x 2.36" D	12/24	2
50-51631	3	White	325	Square / Compact	2.75" W x 5.17" H x 1.69" D	12/24	10
50-51621	1	White	549	Square / Compact	2" W x 3" H x 2.5" D	12/24	10
50-51611	9	White	252	Square	4.94" W x 6.94" H x 2.38" D	12/24	3
50-51651	4	White	2240	Square	4.19" W x 6.5" H x 3" D	12/24	2
50-51661	9	White	1492	Square / Wide Angle	4" W x 5" H x 2.25" D	12/24	3
50-51641	6	White	720	Rectangular	6" W x 4.5" H x 2.4" D	12/24	5

New LED SPOT/FLOOD LIGHT BAR



Heavy duty aluminum housing and polycarbonate lens. Dual power use with 12VDC and 24VDC systems. IP65 rated for dust and water resistance. Hard wired.

Item#	LEDs	LED Color	Lumens	Size	Case
50-51681	24	White	2717	13.58"W x 3.15"H x 3.46"D	1
50-51671	40	White	4521	21.26"W x 3.07"H x 3.39"D	1

New LED SURFACE MOUNT AREA LIGHT



- Integrated On/Off switch
- 316 Stainless Steel
- Hidden fasteners for a clean appearance
- 2 Mounting screws hidden behind the cover
- Can be mounted on 1" bar with round bar adapter (sold separately)

Item#	Color	LED Color	Lumens	Case
50-03131	Stainless Steel	White	220	10
Opt. Accy.	Description			Case
50-03151	1" Round Bar Mount Adapter			10

New LED WAKETOWER ALL-ROUND NAVIGATION LIGHT



- Designed to provide years of safe boating
- Twist-lock base for easy installation and hidden fasteners
- TecSeal Urethane Potting - Guaranteed Circuit Board Protection
- Excellent UV Resistance
- Meets ABYC A-16
- 360° Visibility
- Power draw: 100mA
- Includes TPE mounting gasket

Item#	Color	Visibility	Size	Case
50-03141	Black	USCG 2NM	2.5" Dia x 1.2"	12

New WATER DRAGON LED UNDERWATER LIGHT



- Anodized die-cast aluminum body
- Thermal overheat protection
- Operates at 9-30VDC
- TecSeal Urethane Potting - Guaranteed Circuit Board Protection
- Mounts with 2 screws with approximately 5/8" hole

Item#	Lumens	LEDs	LED Color	Bezel	Case
50-03561	375	3	White	Black Plastic	10
50-03571	1500	3	White	Stainless Steel	10
50-03591	2700	6	White	Stainless Steel	10
50-03611	5500	12	White	Stainless Steel	10
50-03581	1500	3	Blue	Stainless Steel	10
50-03601	2700	6	Blue	Stainless Steel	10
50-03621	5500	12	Blue	Stainless Steel	10

New MINI PUSH TO RESET CIRCUIT BREAKER



Push to reset, single pole circuit breakers are calibrated and tested. A proven "Snap-Acting" bi-metallic thermal sensing mechanism is used to interrupt current flow. Manual push to reset reinstates current flow. Max panel thickness 1/4" w/ 3/8" hole. 1/2" W x 1 1/2" H x 7/8" D.

Item#	Amps	Case
50-13381	5	12
50-13391	10	12
50-13401	15	12
50-13411	20	12
50-13421	30	12

New MARINE SURGE SUPPRESSION



First line of defense for protecting sensitive on-board marine electronics. Protect your investment with the most advanced Surge Protective Device available on the market today. The hybrid design mitigates electrical surges and filters out ringing transients that can cause both immediate and long-term damage to your marine electronics.

- ISO 9001 Certified Manufacturing Facility by NOA
- Parallel wired to protect your electrical panel, without draining your boat's batteries
- Robust 2 kA per mode Peak Surge Current Rating
- Voltage Responsive Circuitry™ protects your electrical system from impulse surges
- Frequency Responsive™ filters out ringing transients, which disrupt and damage sensitive electronics
- All models are encapsulated for a superior watertight seal and vibration resistance
- Compact size can be installed virtually anywhere in your electrical system

Item#	Case
50-19931	10

New BI-COLOR BOW LIGHT COMBO WITH TASK LIGHT



- USCG certified for vessels under 12 meter (39.4')
- 3/4" Diameter anodized aluminum tube
- 225° Visibility-12V
- Includes 3-pin base # 08331
- Pole will fit Attwood 910257 & Perko 1045300DP bases

Item#	Description	Length	Case	
50-02061	Light & Base	12.8" w/o base	12	
Repl. Parts	Description	Material	Length	Case
50-02051	Light Only		12.8"	12
50-08331	Base Only	Chrome plated cover w/ plastic insert		12

New BI-COLOR BOW LIGHT WITH TASK LIGHT



- USCG certified for vessels under 12 meter (39.4')
- 3/4" Anodized aluminum tube
- 225° Visibility-12V
- **Fits:** Seachoice 3-pin base #08331, Attwood base 910257, Perko base 1045300DP

Item#	Description	Length	Case
50-02051	Light Only	12.8"	12

New SPARE 3-PIN LIGHT BASE ASSEMBLY



- Plug-in type, waterproof snap-on cover
- Mounts with # 8 screws.
- **Fits:** Seachoice® 02051, Attwood® 5095107 and Perko® 1211DP2, 1212DP and 1421DP pole lights

Item#	Description	Material	Case
50-08331	Base Only	Chrome plated cover w/ plastic insert	12

New TYPE III 4-BELT SKI VEST



85340

85380

Stylish performance watersports vest with features that set it apart. Increased durability and soft foam allows for maximum mobility. This dual sized vest is perfect for skiing, wakeboarding, boating, fishing or cruising.

- **Coast Guard Type:** USCG Type III
- **Flotation Material:** Lightweight foam
- **Shell:** 200 Denier oxford fabric
- **Closure:** 2" Nylon and D-ring

Item#	Size	Weight	Chest	Color	Case
50-85340	S/M	90 lbs. & Up	32" to 40"	Blue	6
50-85350	L/XL	90 lbs. & Up	40" to 52"	Blue	6
50-85360	2XL/3XL	90 lbs. & Up	50" to 60"	Blue	6
50-85370	3XL/4XL	90 lbs. & Up	60" to 70"	Blue	6
50-85380	S/M	90 lbs. & Up	32" to 40"	Red	6
50-85390	L/XL	90 lbs. & Up	40" to 52"	Red	6
50-85400	2XL/3XL	90 lbs. & Up	50" to 60"	Red	6
50-85410	3XL/4XL	90 lbs. & Up	60" to 70"	Red	6

New TYPE V INFLATABLE WAIST BELT



- Convertible personal flotation device
- 24g CO2 cylinder for Halkey Roberts 840 inflator
- MANUAL activation with a back up Oral Inflation Tube
- Comfortable and lightweight
- Ideal for recreational boating, fishing and other non-watersport activities
- U.S. Coast Guard approved

Item#	Color	Case
50-85490	Black	6

New RESCUE LINE THROW BAG



50' Rescue line to throw to person in trouble. Bright, high-visibility yellow UV resistant polyester bag.

Item#	Case
50-45441	12

New BAILER SAFETY KIT



Includes 4 items: 50' of buoyant heaving line, bailer, pea-less whistle and watertight LED flashlight (batteries not included). Contents required by Canadian Coast Guard for vessels up to 8 meters.

Item#	Case
50-45431	6

New LED WATERPROOF TRAILER LIGHT SET



- Designed for 12V marine trailer application
- Sealed, waterproof design
- Passenger & driver sides included
- Traditional style fits many applications
- Stud mount lights mount on 2" centers
- Acrylic lens, plastic housing
- Includes mounting hardware

Item#	Size	Case
50-51551	5.063" W x 4.563" H x 2.875" D	2

New LED LOW PROFILE COMBINATION TAIL LIGHT SET

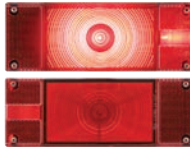

- Designed for 12V marine trailer application
- Sealed, waterproof construction
- Passenger & driver sides included
- Universal mount
- Hard wired, with separate ground wire
- Acrylic lens and plastic housing

Item#	Size	Case
50-51561	8" W x 2.875" H x 2.813 D	2

New LED LOW PROFILE WATERPROOF IDENTIFICATION LIGHT BAR



- Sonically sealed
- Only 5/8" thick
- 11 Diodes
- Surface mount on 1 1/8" centers
- Polycarbonate lens and housing
- Meets SAE S2T216 for over 80" wide vehicles w/ built-in reflex meeting SAE A
- Hard wired with separate ground wire

Item#	Size	Case
50-51571	15" W x 1.375" H x .625" D	6

New LED ULTRATHIN WATERPROOF IDENTIFICATION LIGHT BAR



- For Over 80" applications
- Sonically sealed
- Only 5/8" thick
- 3 Diodes
- Polycarbonate lens and housing

Item#	Size	Case
50-51581	15" W x 1.375" H x .625" D	6

New 5-FLAT TO 7-ROUND COIL CORD ADAPTOR



Converts tow vehicle 7-way round blade connector to 5-way flat pin connector.

Item#	Case
50-51591	1

New CLEVIS PIN



Corrosion resistant plating.
53271: Fits Class II Receivers & Ball Mounts

Item#	Size	Case
50-53261	3/8" x 4 3/4"	60
50-53271	1/2" x 4 3/4"	60
50-53281	5/8" x 4 3/4"	60
50-53291	3/4" x 4 3/4"	60

New CLASS III / IV DUAL HITCH EXTENDER



Extend your trailer hitch receiver opening and get an extra receiver with the same piece. This dual hitch extension gives you (2) 2" receivers so you can tow a trailer and use an accessory at the same time. Black powder coated steel resists rust.

- Provides an additional 2" receiver so you can tow a trailer and mount an accessory at the same time
- Bottom receiver lets you tow a trailer or flat tow a vehicle
- Top receiver is for hitch-mounted accessories only
- Extends trailer hitch receiver opening to avoid obstacles
- Get extra clearance for your trailer
- Mount your bike rack without having to remove your rear-mounted spare tire

Item#	Tongue Capacity	Tow Capacity	Case
50-53351	400 lbs.	4,000 lbs.	1

New CLASS II HITCH EXTENDER



53331



53341

- Prevents hitting trailer or propane tanks when making sharp turns
 - Extends hitch (measurement is from center to center of hitch pin)
 - Black powder coated finish
 - Using a 2" hitch extender will reduce your hitch's over all capacity by 1/3
- Use only one extension, do not cut, weld, or modify. Do not exceed 65% of hitch rating.

Item#	Length	Tongue Capacity	Tow Capacity	Case
50-53331	8" x 2"	350 lbs.	3,500 lbs.	1
50-53341	14" x 2"	350 lbs.	3,500 lbs.	1

New 6 TON PINTLE HOOK



All-steel construction with black powder coat finish resists corrosion. Solid shank fits 2" receiver tubes.

Item#	GTW	GVW	Ball	Case
50-53361	12,000 lbs.	2,400 lbs.	2" (7,000 lbs.)	1
50-53371	12,000 lbs.	2,400 lbs.	2 5/16" (12,000 lbs.)	1

New RECEIVER MOUNT HOOK



Fits 2" x 2" hitch receivers. Black powder coated. Do not exceed vehicle towing capacity.

Item#	Tow Capacity	Case
50-53251	10,000 lbs.	1

New TOW & TRAILER VALET



This easy-turning, multidirectional heavy-duty valet has an integrated drive function. The Tow & Trailer Valet takes the place of your ordinary trailer jack and takes the hassle out of hooking up and moving your trailer. Simply turn the crank that powers the drive system and direct your trailer with the steering handle. Features: Dual 8" pneumatic wheels, steering handle and automatic brake system.

- Lift: 10"
- Bracket height: 14" retracted - 24" extended
- Tongue weight capacity: 500 lbs.

Item#	Wheel
50-53301	8"

New JACK FOOT



Jack foot fits on your round tube A-frame jack with a 2 1/4" outer tube. Attaches to 2" inner tube with the included pin and clip. Corrosion-resistant, zinc-plated finish.

Item#	Max Load	Height	Case
50-53321	2,000 lbs.	8 1/2"	1

New SIDE MOUNT SPARE TIRE CARRIER



- Heavy duty steel construction
- Offset provides increased ground clearance
- Fits most tongue and trailer frames
- Use for 8", 10", 12", 13", 14" & 15" tires
- Fits 4-lug and 5-lug wheels
- Fits 4" and 4.5" bolt hole patterns
- Mounts on up to 4" x 5" tube
- Mounts on up to 3" x 5" channel
- Mounts on up to 3" x 5" angle at upright

Item#	Case
50-53881	10

New BATTERY CHARGER AND MAINTAINER



148383

14384

- 3-stage, smart charger technology prevents overcharging
- Smart automatic switching technology can be safely connected to the vehicle for long periods of time
- Direct wall plug-in design keeps the work area clutter free
- Spark-resistant reverse hookup protection
- Alligator clips included
- CEC certified

Item#	Volts	Amps	Case
50-14383	12	0.5	12
50-14384	12-24	4-8	8

Opt. Accy.	Description	Length	Size	Case
50-14386	16 AWG Harness w/Ring Terminals	19.5"	15 Amp	12

New AGC GLASS FUSES



Item#	Amps	Pack	Case
50-11343	½	5	5
50-11344	1	5	5
50-11346	2	5	5
50-11347	4	5	5
50-11348	5	5	5
50-11349	7½	5	5
50-11351	10	5	5
50-11353	15	5	5
50-11354	20	5	5
50-11356	25	5	5
50-11357	30	5	5

New AGC GLASS FUSE ASSORTMENT



11359 11358

Item#	Includes	Pack	Case
50-11359	1 ea. ½, 1, 1½, 2, 3 Amp	5	5
50-11358	1 ea. 5, 10, 15, 20, 30 Amp	5	5

New AGC FUSE VALUE PACK



Item#	Includes	Pack	Case
50-11361	5 ea. 5, 10, 15, 20, 30 Amp	25	5
50-11363	10 ea. 5, 10, 15, 20, 25, 30 Amp; & Tester	60	3

New ATC BLADE FUSES

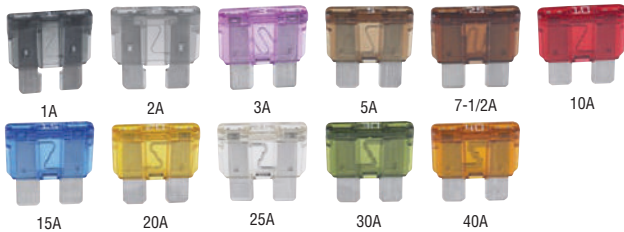

Item#	Amps	Pack	Case
50-11369	1	5	5
50-11371	2	5	5
50-11373	3	5	5
50-11374	5	5	5
50-11376	7½	5	5
50-11377	10	5	5
50-11378	15	5	5
50-11379	20	5	5
50-11381	25	5	5
50-11383	30	5	5
50-11384	40	5	5

New ATC FUSE VALUE PACK



Item#	Includes	Pack	Case
50-11388	5 ea. 5, 10, 15, 20, 30 Amp	25	5
50-11389	7 ea. 5, 10, 15, 20, 25, 30 Amp; & Tester	42	3

New ATC BLADE FUSE ASSORTMENT



11387 11386

Item#	Includes	Pack	Case
50-11387	1 ea. 1, 2, 3, 5, 7½ Amp	5	5
50-11386	1 ea. 10, 15, 20, 25, 30 Amp	5	5

New ATC INDICATING FUSES



Item#	Amps	Pack	Case
50-11397	10	2	5
50-11398	15	2	5
50-11399	20	2	5
50-11401	25	2	5
50-11403	30	2	5

New ATC INDICATING FUSE ASSORTMENT



Item#	Includes	Pack	Case
50-11404	1 ea. 10, 15, 20, 25, 30 Amp	5	5

New ATC INDICATING FUSE VALUE PACK



Item#	Includes	Pack	Case
50-11406	5 ea. 5, 10, 15, 20, 30 Amp	25	5

New ATM BLADE FUSES

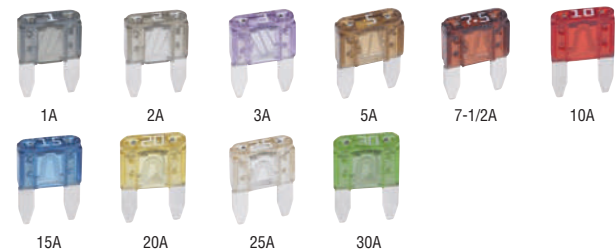

Item#	Amps	Pack	Case
50-11413	1	5	5
50-11414	2	5	5
50-11416	3	5	5
50-11417	5	5	5
50-11418	7½	5	5
50-11419	10	5	5
50-11421	15	5	5
50-11423	20	5	5
50-11424	25	5	5
50-11426	30	5	5

New ATM FUSE VALUE PACK



Item#	Includes	Pack	Case
50-11431	5 ea. 5, 10, 15, 20, 30 Amp	25	5
50-11433	7 ea. 5, 10, 15, 20, 25, 30 Amp; & Fuse Puller-Tester	42	3

New ATM INDICATING FUSES



Item#	Amps	Pack	Case
50-11441	10	2	5
50-11443	15	2	5
50-11444	20	2	5
50-11446	25	2	5
50-11447	30	2	5

New ATM INDICATING FUSE VALUE PACK



Item#	Includes	Pack	Case
50-11449	5 ea. 5, 10, 15, 20, 30 Amp	25	5

New ATM INDICATING FUSE ASSORTMENT



Item#	Includes	Pack	Case
50-11448	1 ea. 10, 15, 20, 25, 30 Amp	5	5

New ATM FUSE ASSORTMENT

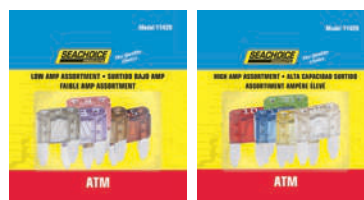

Item#	Includes	Pack	Case
50-11429	1 ea. 2, 3, 4, 5, 7½ Amp	5	5
50-11428	1 ea. 10, 15, 20, 25, 30 Amp	5	5



SEACHOICE PRODUCTS INTRODUCES NEW PRODUCTS FREQUENTLY

SO BE SURE TO CHECK BACK WITH US IN THE FUTURE.

JUST TURN THE PAGE FOR MORE GREAT PRODUCTS.



Anchoring 78-85

Anodes..... 77-78

Covers, Tops & Hardware 108-110

Boatyard & Maintenance 103-107

Electrical Equipment 10-25

Electronics Accessories..... 25-28

Fasteners..... 47-57

Fishing Accessories 68-71

Fuel Accessories & Ventilation 72-76

General Accessories 33-38

Hardware..... 58-68

Lighting..... 1-9

Merchandising Aids 112

Mooring 111

Motor Accessories 100

Plumbing 28-32

Safety Equipment 38-45

Steering Accessories..... 100-102

Trailer Accessories 86-99

Water Sports Accessories 46

BI-COLOR BOW LIGHT - STAINLESS



1-mile visibility for sail or powerboats under 39'. With Red & Green Lenses. Black plastic base. 20 points, 225°. Supplied with prewired brass socket and bulb. Pre-drilled holes to accommodate three #4 screws.

Item#	Housing	Mount	Material	Base	Height	Case
05071	Stainless	Horizontal	Stainless Steel	2 3/8" O.D.	1 3/8"	12
Repl. Parts	Description			Pack	Case	
09911	Festoon Bulb 10W (PKO 71)			1 pr.	12	

BI-COLOR BOW LIGHT - CHROME/BRASS



Meets CE and USCG requirements for 1NM visibility for sail or powerboats under 39'. Meets ABYC A-16 requirements. Meets NMMA Certification Procedure. With Red & Green Lenses. 12V DC - 8 CP lamp included. Pre-drilled with two countersunk holes to accommodate #4 screws. Black plastic base.



Item#	Housing	Mount	Base	Height	Case
05031	Chrome Plated Brass	Horizontal	2 3/8" O.D.	1 3/8"	12
Repl. Parts	Description			Pack	Case
09911	Festoon Bulb 10W (PKO 71)			1 pr.	12

LED BI-COLOR BOW LIGHT - ZAMAK



With Red & Green Lenses. 1-mile visibility for sail or powerboats under 39'. Pre-drilled with countersunk holes to accommodate #8 screws.



Item#	Housing	Mount	Base	Height	Case
02031	Zamak	Horizontal	2 3/4" L x 2 1/2" W	1 3/8"	6

BI-COLOR BOW LIGHT - ZAMAK



Meets ABYC Standard A-16. With Red & Green Lenses. 1-mile visibility for sail or powerboats under 39'. 12V DC - 6 CP lamp included. Pre-drilled with two countersunk holes to accommodate #8 screws.

Item#	Housing	Mount	Base	Height	Case
04981	Zamak	Horizontal	2 3/4" L x 2 1/2" W	1 3/8"	12
Repl. Parts	Description			Pack	Case
09901	Bulb - DC Bayonet Base 7.5W (GE 90)			1 pr.	12

LED BI-COLOR BOW LIGHT - STAINLESS

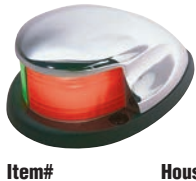

With Red & Green Lenses. 2-mile visibility for sail or powerboats under 66'. Black plastic base. Screw size is 8.



Item#	Housing	Base	Height	Case
02041	Stainless	3 1/4" L x 2 5/16" W	1- 3/8"	6

BI-COLOR BOW LIGHT- ZAMAK



Meets CE and USCG requirements for 2NM visibility for sail or powerboats under 66'. Meets ABYC A-16 requirements. With Red & Green Lenses. Black plastic base. Screw size is 8.



Item#	Housing	Mount	Base	Height	Case
04921	Chrome Plated Zamak	Horizontal	3 1/4" L x 2 5/16" W	1 3/8"	6
Repl. Parts	Description			Pack	Case
09911	Festoon Bulb 10W (PKO 71)			1 pr.	12

STREAMLINE BI-COLOR BOW LIGHT - STAINLESS



With Red & Green Lenses. Back plastic base. Screw size is 8.

Item#	Housing	Mount	Base	Height	Case
04971	Stainless	Horizontal	3 1/4" L x 2 5/16" W	1 3/8"	6
Repl. Parts	Description			Pack	Case
09911	Festoon Bulb 10W (PKO 71)			1 pr.	12

LED BI-COLOR BOW LIGHT - CHROME/ZAMAK



With Red & Green Lenses. 1-mile visibility for sail or powerboats under 39'. Pre-drilled with countersunk holes to accommodate #8 screws. Black plastic base.



Item#	Housing	Mount	Base	Height	Case
02021	Chrome Plated Zamak	Horizontal	4" L x 3 1/8" W	1 3/8"	6

BI-COLOR BOW LIGHT - CHROME/ZAMAK



Meets USCG requirements for 1NM visibility for sail or powerboats under 39'. Meets ABYC A-16 requirements. Meets NMMA Certification Procedure. With Red & Green Lenses. 12V DC - 8 CP. Pre-drilled with two countersunk holes to accommodate #8 screws. Black plastic base.

Item#	Housing	Mount	Base	Height	Case
05021	Chrome Plated Zamak	Horizontal	4" L x 3 1/8" W	1 3/4"	12
Repl. Parts	Description			Pack	Case
09911	Festoon Bulb 10W (PKO 71)			1 pr.	12
09831	LED Bulb, 4SMD			1	12

BI-COLOR BOW LIGHT - CHROME/ZINC



Meets CE and USCG requirements for 1NM visibility for sail or powerboats under 39'. Meets ABYC A-16 requirements. Meets NMMA Certification Procedure. With Red & Green Lenses. 12V DC - 8 CP lamp included. Pre-drilled with two countersunk holes to accommodate #8 screws. Black plastic base.



Item#	Housing	Mount	Base	Height	Case
05011	Chrome Plated Zamak	Horizontal	4" x 3 1/8"	1 3/4"	12
Repl. Parts	Description			Pack	Case
09911	Festoon Bulb 10W (PKO 71)			1 pr.	12

BI-COLOR BOW LIGHT



04901



04911

Meets CE and USCG requirements for 2NM visibility for sail or powerboats under 66'. With Red & Green Lenses. Plastic casing with ultrasonically welded lenses gasketed to the base. Pre-drilled with two countersunk holes to accommodate #8 screws.



Item#	Housing	Base	Height	Case	
04901	Black	3 1/2" L x 2 1/4" W	1 3/8"	12	
04911	White	3 1/2" L x 2 1/4" W	1 3/8"	12	
Repl. Parts	Description			Pack	Case
09911	Festoon Bulb 10W (PKO 71)			1 pr.	12
09831	LED Bulb, 4SMD			1	12



BI-COLOR BOW LIGHT STOW-A-WAY - CHROME/ZAMAK



With Red & Green Lenses. 1-mile visibility for sail or powerboats under 39'. 12V DC - 6 CP. Pre-drilled with three countersunk holes to accommodate #8 screws. Non-corrosive plastic socket.

Item#	Housing	Base	Height	Case
05091	Triple Chrome Plated Zamak	1 7/8" x 4	10"	8
Repl. Parts	Description	Pack	Case	
09901	Bulb - DC Bayonet Base 7.5W (GE 90)	1 pr.	12	

SIDE LIGHT - STAINLESS



With Red & Green Lenses pair. 1-mile visibility for sail or power boats under 39'. Individual red and green sidelights. 10 points, 112.5°. Supplied with prewired brass sockets and bulbs. Pre-drilled holes to accommodate 3 #4 screws for each light. Sold as a pair.

Item#	Housing	Mount	Base	Height	Pack	Case
05121	Stainless	Vertical	2 1/4" O.D.	1 3/8"	1 pr.	12
Repl. Parts	Description	Pack	Case			
09901	Bulb - DC Bayonet Base 7.5W (GE 90)	1 pr.	12			

SIDE LIGHT - CHROME/BRASS



Meets CE and USCG requirements for 1NM visibility for sail or powerboats under 39'. Meets ABYC A-16 requirements. This pair meets NMMA Certification Procedure. With Red & Green Lenses pair. 12V DC - 8 CP lamp included. Pre-drilled with two countersunk holes to accommodate #4 screws. Black plastic base.



Item#	Mount	Base	Height	Pack	Case
05131	Vertical	4 1/4" L x 2 3/8" W	7/8"	1 pr.	12
Repl. Parts	Description	Pack	Case		
09911	Festoon Bulb 10W (PKO 71)	1 pr.	12		

LED SIDE LIGHT - STAINLESS



Meets USCG requirements for 2NM. Meets ABYC A-16 Requirements. 112°. Red and green bulbs.



Item#	Housing	Mount	Base	Height	Pack	Case
02151	Stainless	Flush	7 3/4" L x 2 3/8" W	2 1/2"	1 pr.	12

SIDE LIGHT - STAINLESS



Meets USCG requirements for 2NM. Meets USCG requirements for navigation lights. Meets ABYC A-16 requirements. Accepted by NMMA. With Red & Green Lenses pair. 112° Red and green lens. Bulb can be replaced from inside the boat.

Item#	Housing	Mount	Base	Height	Pack	Case
05151	Stainless	Flush	7 3/4" L x 2 3/8" W	2 1/2"	1 pr.	12
Repl. Parts	Description	Fits	Pack	Case		
05141	Replacement Socket	Post 2010 Models	12			
09901	Bulb - DC Bayonet Base 7.5W (GE 90)		1 pr.	12		
05171	Replacement Socket	Early Models	12			
05161	Replacement Lens		1 pr.	12		

LED CLASSIC SIDE LIGHT



03221 03211

Meets USCG requirements for 1NM. Meets ABYC A-16 requirements.

Size: 2 1/2" W x 2 1/4" D x 2 3/4" H"



Item#	Type	LED Color	Housing	Case
03221	Starboard	Green	Plastic	6
03211	Port	Red	Plastic	6

LED CLASSIC TRANSOM LIGHT



Meets USCG requirements for 1NM Meets ABYC A-16 requirements.

Size: 2 1/2" W x 2 1/4" D x 2 3/4" H.

Item#	Housing	Case
03231	Plastic	6



LED TRANSOM LIGHT



02381

LIGHT

Meets USCG 2NM requirements.

Clear lens. 12V DC. Flush 304 stainless steel with plastic body.



Item#	Description	Size	Fastener	Case
02361	Rectangular	4 5/8" x 2 5/8" x 3/4" D	#10	12
02381	Round	3" dia.	#8	12

TRANSOM LIGHT - STAINLESS FLANGE

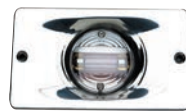

05361

05381

Meets USCG requirements for 2NM visibility for sail for powerboats under 66'. Meets ABYC Standard A-16.

Clear lens. 12V DC - 6 CP lamp included. Flush 304 stainless steel with plastic body and socket.

Replacement Part Guide: 09931, 09841 for Model 05361 09901 for Model 05381

Item#	Description	Size	Fastener	Case
05361	Rectangular	5 1/8" x 3 1/16" x 1" D	#10	12
05381	Round	3" dia.	#8	12
Repl. Parts	Description	Pack	Case	
09931	Festoon Bulb 10W (PKO 70)	1 pr.	12	
09901	Bulb - DC Bayonet Base 7.5W (GE 90)	1 pr.	12	
09841	LED 4SMD Festoon Bulb	1	12	

TRANSOM LIGHT - STAINLESS FLANGE



12 point 135°. Flange made of 304 polished stainless steel with clear plastic lens. Supplied with rubber mounting pad. 3" diameter, 1 3/4" deep. Use #8 screws.

Item#	Description	Mount	Size	Fastener	Case
05391	Round	Vertical	3" dia.	# 8	12
Repl. Parts	Description	Pack	Case		
09931	Festoon Bulb 10W (PKO 70)	1 pr.	12		

STERN LIGHT - CHROME/BRASS



Meets CE and USCG requirements for 2NM visibility for sail or powerboats under 66'. Meets ABYC A-16 requirements. Meets NMMA Certification Procedure.



Clear lens. 12V DC - 8 CP lamp included. Pre-drilled with three countersunk holes. Housing is chrome plated brass with black plastic base.

Item#	Housing	Mount	Size	Base	Fastener	Case
05251	Chrome Plated Brass	Horizontal	1 1/2" H	2 3/8" O.D.	#4	12
Repl. Parts	Description	Pack	Case			
09911	Festoon Bulb 10W (PKO 71)	1 pr.	12			

LED ALL-ROUND LIGHT



Stainless Steel Tubing, 12V. Black base 2 1/2" L x 1 1/2" W. Pre-drilled with countersunk holes to accommodate #8 screws.



Item#	Height	Case	
02941	24"	6	
02931	48"	6	
Repl. Parts	Description	Pack	Case
02501	LED Double Bayonet (GE 90 & 1004)	1	12

TELESCOPING ALL-ROUND WHITE LIGHT



Meets CE and USCG requirements for 2NM visibility for use on sail or powerboats under 66'. Meets NMMA Certification Procedure. Clear globe. 12V DC - 6 CP lamp included. Base length 3 3/4", 1 1/2" W. Pre-drilled to accommodate #8 screws. Base is chrome plated zinc.



Item#	Height	Case		
05471	23 1/8"	6		
Repl. Parts	Description	Size	Pack	Case
09901	Bulb - DC Bayonet Base 7.5W (GE 90)		1 pr.	12
08551	Clear Fresnel Globe	2 1/2"		12

ALL-ROUND WHITE LIGHT



Meets CE and USCG requirements for 2NM visibility for sail or powerboats under 66'. Meets NMMA certification procedure.

12V DC-15 CP lamp included. Pre-drilled to accommodate #8 screws. Stow-A-Way base length: 3 1/4" x 1 - 5/8". Base is chrome plated zinc.



Item#	Height	Globe	Case	
05611	22 3/8"	White translucent	6	
05591	22"	Clear	6	
Repl. Parts	Description	Size	Pack	Case
08511	Translucent White Globe	3"		12
09901	Bulb - DC Bayonet Base 7.5W (GE 90)		1 pr.	12
09951	Bulb 12W (GE 1004)		1 pr.	12
08551	Clear Fresnel Globe	2 1/2"		12
08261	Spare Base			12

LED ALL-ROUND LIGHT



Aluminum Tubing, 12V. Includes chrome plated zinc base. Pre-drilled with countersunk holes to accommodate #8 screws. Tubing also fits Seachoice base 08251.



Item#	Height	Case
02951	24"	6
02961	48"	6

STOW-A-WAY ALL-ROUND WHITE LIGHT



2-mile visibility for sail or powerboats under 66'. Stainless steel pole with white translucent globe. 12V DC - 15 CP lamp included. Chrome plated zinc base size is 3 3/4" L x 1 1/2" W. Drilled to accommodate 3 #8 screws.

Item#	Height	Case	
05631	22"	6	
Repl. Parts	Description	Pack	Case
09951	Bulb 12W (GE 1004)	1 pr.	12

ALL-ROUND WHITE LIGHT



Meets ABYC Standard A-16. 2-mile visibility for sail or powerboats under 39'.

Anti-glare globe. 12V DC - 15 CP lamp included. Base is die-cast zamak with Perma-Plate® chrome finish and is pre-drilled and countersunk to accommodate #10 screws. Poles are 3/4" anodized aluminum. Base fits Attwood 7100 and 5100 series.

Item#	Description	Height	Case	
05571	Stow-A-Way w/Base	24"	6	
05691	Spare Pole Light	24"	8	
05721	Spare Pole Light	36"	6	
05701	Spare Pole Light	48"	6	
Repl. Parts	Description	Size	Pack	Case
09991	Bulb, Wedge Base 10W (906)		1 pr.	12
08521	Anti-Glare Globe	2 1/2"		12
08271	Spare Base			12

LED ALL-ROUND LIGHT WITH LOCKING BASE



Meets USCG 2NM requirements. Black Plastic Base. 360° 6 LED lights. Pre-drilled to accommodate #8 screws.



Item#	Height	Case
02911	24"	6

LED ALL-ROUND LIGHT WITH LOCKING BASE



Meets USCG 2NM requirements. Chrome plated zamak base. 360° 6 LED lights. Pre-drilled to accommodate #8 screws.



Item#	Height	Case
02921	24"	6



LED TELESCOPING ALL-ROUND LIGHT WITH LOCKING BASE



Meets USCG 2NM requirements. Chrome Plated Base. 360° 6 LED lights. Pre-drilled to accommodate #8 screws.



Item# 02901	Height 24"	Case 6
-----------------------	----------------------	------------------

ALL-ROUND "REDUCED GLARE" REPLACEMENT LIGHT



Meets CE and USCG requirements for 2NM visibility for sail or powerboats under 66'. The "Reduced Glare" design focuses the beam of light above the operator's line of sight, which limits glare and improves overall night vision. Fits Seachoice base 08261 and Perko bases 1046, 1059 and 1060.



Item# 05761	Height 48"	Case 6	
Repl. Parts 09991	Description Bulb, Wedge Base 10W (906)	Pack 1 pr.	Case 12

PLUG-IN TYPE SPARE LIGHT BASE ASSEMBLY



The cover swivels and the socket is made of durable plastic. Mounts with #10 screws. Made of zamak with chrome plated finish.

Replaces: Seachoice 0825.
Fits: Seachoice 0557, 0569, 0570, 0572.
Attwood® Series 5100, 5110, 7100.

Item# 08271	Description Spare Base	Case 12
-----------------------	----------------------------------	-------------------

SPARE LIGHT BASE ASSEMBLY



Chrome Plated



Black Nylon

Plug-in type, waterproof snap-on cover. Mounts with #8 screws.

Replaces: Seachoice 0826.
Fits: Seachoice 0291, 0292, 0293, 0294, 0295, 0296, 0547, 0559, 0561.
Perko® 1311, 1330, 1611, 1630.

Item# 08281	Material Chrome Plated Zamak w/ Rubber Cover	Case 12
08291	Black Nylon Plastic w/ Rubber Cover	12

SPARE LIGHT BASE ASSEMBLY



Plug-in type, waterproof snap-on cover. Mounts with #8 screws. Made of zamak with a chrome plated finish and has a black rubber cover.

Fits: Seachoice 05591 and 05611.
Perko® 1330 and 1630 Series.

Item# 08261	Description Spare Base	Case 12
-----------------------	----------------------------------	-------------------

RUBBER STORAGE CLIP



Perfect solution for storing pole lights, boat hooks, gaffs, boat mops, etc. Made of molded black rubber, these clips will accommodate diameters of 3/4" to 1".

Item# 72051	Size 2" x 1 5/8"	Pack 1 pr.	Case 12
-----------------------	----------------------------	----------------------	-------------------

MASTHEAD ALL-ROUND WHITE LIGHT - STAINLESS



Fixed mount 360° clear lens. 1 1/2" H x 2 5/16" D. Mounting Hole: 3/4".

Item# 05981	Mount Horizontal	Case 12	
Repl. Parts 09901	Description Bulb - DC Bayonet Base 7.5W (GE 90)	Pack 1 pr.	Case 12

MASTHEAD AND ALL-ROUND WHITE LIGHT



Meets CE and USCG requirements for 3NM visibility for sail or powerboats under 66'. Meets NMMA Certification Procedure. Clear lens. Two 12V DC - 8 CP lamps included. Light and base made of UV resistant black polycarbonate.



Item# 05991	Mount Fixed	Height 3 1/4"	Base 1" x 2 5/8"	Case 12
Repl. Parts 09911	Description Festoon Bulb 10W (PKO 71)	Pack 1 pr.	Case 12	
09831	LED Bulb, 4SMD	1	12	

ALL-ROUND LIGHT



05851



05861

2NM Visibility. Meets ABYC, NMMA, R.I.N.A. requirements. Approved for Boats to 66'. Constructed of UV resistant fiberglass reinforced ABS plastic with UV resistant plexiglass lens. Lights are completely gasketed and seawater proof. Tube made of aluminum. Complete with 12V-10W bulb. Mounts with #6 STS PH screws.



Item# 05851	Height 4"	Case 12	
05861	8"	12	
Repl. Parts 09931	Description Festoon Bulb 10W (PKO 70)	Pack 1 pr.	Case 12
09911	Festoon Bulb 10W (PKO 71)	1 pr.	12

LED ALL-ROUND LIGHT



02851



02861

Meets USCG requirements for 2NM. 360° 6 LED lights. Pre-drilled to accommodate #8 screws.



Item# 02851	Height 4"	Case 6
02861	7 1/2"	6

FOLD-DOWN MASTHEAD AND ALL-ROUND WHITE LIGHT



3-mile visibility for sail or powerboats under 66'. Anodized aluminum 3/4" tube with clear lenses. Two 12V DC 8 CP lamps included. Chrome plated zinc base. Pre-drilled to accommodate 2 #8 screws. Two plastic adapters included for flat or "V" mount.

Item# 05961	Mount Vertical	Height 10 1/2"	Base 2 5/32" L x 5/8" W	Case 12
Repl. Parts 09911	Description Festoon Bulb 10W (PKO 71)	Pack 1 pr.	Case 12	
09831	LED Bulb, 4SMD	1	12	

DELUXE FOLD-DOWN MASTHEAD AND ALL-ROUND WHITE LIGHT



Meets CE and USCG requirements for 3NM visibility for sail or powerboats under 66'. Meets NMMA Certification Procedure. Plastic adapters to fit flat or "V" mount. Clear lens. Two 12V DC - 8 CP lamps included. Pre-drilled holes to accommodate #8 screws. 3/4" aluminum tube. Base is black plastic.



Item#	Mount	Height	Base	Case
05931	Horizontal	12 5/8"	2" x 1 1/2"	12
05971	Vertical "V" Type	12 5/8"	2 1/4" x 5/8"	10
Repl. Parts	Description	Pack	Case	
09911	Festoon Bulb 10W (PKO 71)	1 pr.	12	
09831	LED Bulb, 4SMD	1	12	

FOLD-DOWN LED ALL-ROUND LIGHT



Meets USCG requirements for 2NM. 360° 6 LED lights. Pre-drilled to accommodate #8 screws.



Item#	Height	Case
02871	9"	6
02881	24"	6

SPARE GLOBE



For All-Round Lights

08511: Fits Perko Series 1134, 1137, 1400, 1401, 1403, 1404, 1611; Fits Seachoice Series 05611 · OD: 1 1/16" · ID: 1 1/2"

08521: Fits Attwood Series 7100, 7101, 7105; Fits Seachoice Series 05571, 05691, 05701 · ID: 1 1/2"

08551: Fits Perko Series 1311, 1330; Fits Seachoice Series 05471, 05591 · OD: 2" · ID: 1 1/2"

Item#	Description	Size	Case
08511	Translucent White Globe	3"	12
08521	Anti-Glare Globe	2 1/8"	12
08551	Clear Fresnel Globe	2 1/2"	12

LED PORTABLE BATTERY OPERATED NAVIGATION LIGHT KIT



Lightweight and small this kit includes a quick release tab for quick and easy removal. Water and shock resistant, they feature rubber seals and booted switches for durability. The versatile C-clamp mount allows for horizontal or vertical attachment. **Includes:** red/green LED bow light, white LED stern light, quick release light mounts, pole, two C-clamps, and hardware. Requires 3 "AAA" batteries per light (not included).

For nighttime operation of small boats and tenders w/o 12V systems. Not intended to meet U.S.C.G. regulations. Not for use on boats that can exceed seven knots.

Item#	Mount	Color	Case
06261	C-Clamp	Gray	3

LED PORTABLE BATTERY OPERATED NAVIGATION LIGHT



Each light requires (2) "D" cell batteries.
06221: Bow Light: Red/Green portable bow light with adjustable clamp for horizontal surfaces.
06201: Bow Suction: Red/Green portable bow light with durable, heavy duty suction cup.
06251: Stern Suction: Durable, heavy duty suction cup. Ideal for ski boats, sailboats and boaters who do not want an attachment method that might mar the surface.
06231: Stern Light: 24" Pole light with adjustable clamp. Easily mounts to transom.

Item#	Type	Color	Case
06221	Bow Light	Grey	12
06201	Bow Suction	Grey	12
06251	Stern Suction	Grey	12
06231	Stern Light 24"	Grey	3

Repl. Parts	Description	Pack	Case
02511	LED Bulb	1	12

PORTABLE BATTERY OPERATED NAVIGATION LIGHT



Each light is fitted with a 3W incandescent bulb and requires (2) "D" cell batteries. LED replacement bulb fits all models shown.

06121: Bow Light: Red/Green bow light with adjustable clamp for horizontal surfaces.
06101: Bow Suction: Red/Green light with durable, heavy duty suction cup.
06151: Stern Suction: Durable, heavy duty suction cup. Ideal for ski boats, sailboats and boaters who do not want an attachment method that might mar the surface.
06131: Stern Light: 24" Pole light with adjustable clamp. Easily mounts to transom

Item#	Type	Color	Case
06121	Bow Light	Grey	12
06101	Bow Suction	Grey	12
06151	Stern Suction	Grey	12
06131	Stern Light 24"	Grey	3

Repl. Parts	Description	Pack	Case
09921	Bulb 3W	1	12
02511	LED Bulb	1	12

New WATERPROOF LED SPOTLIGHT

- Durable water-resistant design
- Housing is strong ABS material
- Cree LED
- 3 Light Modes: 100% / 50% / Flash
- Floats
- Uses 4 AA batteries (not included)
- Folding hanger on top of the light and wrist strap on handle



Item#	Color	Volts	Watts	Case
08091	Yellow/Black	12	5	10

New LED MAGNETIC C.O.B. STRIP WORKLIGHT

CHIP ON BOARD LED is a group of LED chips that make an intense bright light. The light is wide and much brighter than standard LED's. Purchase 12 and receive a display box. 180° Rotating clip with magnet and flip-up hook allows the light to be mounted anywhere for handsfree use. Constructed of tough water resistant ABS plastic case. LED life is over 110,000 hours and includes (3) AAA batteries.



Item#	Color	Lumens	Case
08101	Yellow	120	12

New INSPECTION LED FLASHLIGHT

- Precision machined high-strength aluminum alloy case
- Anodized inside and out for improved corrosion resistance and durability
- Cree LED
- Uses 2 AAA batteries (included)
- Water resistant
- Beam Distance: 50 Meters
- Impact Resistant: 1.5m



Item#	Color	Lumens	Case
08131	Black	150	6

New LED FOCUSABLE ALUMINUM FLASHLIGHT

08184

08151

08161



Features high quality super bright Cree LED's. Focus from spotlight mode to a wide beam with the variable slide focus head. The 5 light modes (100%-50%-30%-flash-sos) come in handy for any circumstance. Models come in various sizes for convenience. Batteries included.

Item#	Color	Lumens	Size	Batteries	Case
08141	Black & Blue	300	5"	3 AAA	20
08151	Black & Blue	600	8.5"	3 C	10
08161	Black & Blue	800	10"	3 D	8

30-DAY LED FLASHLIGHT

Water and Shock-resistant. Bright clean light up to 300 lumens - runs 30 days continuously on "low" and runs 16 hours continuously on "high". Lifetime LED is unbreakable and never needs replacing. Tough anodized aircraft-grade aluminum with rubberized casing for a sure grip. High, low, and SOS flashing modes. Moonbeam technology lens casts a broad, clear beam. Lifetime Limited Warranty. Runs on (3) D Alkaline batteries (not included).

Item#	Batteries	Case
46601	3 D	3

WEATHERPROOF FLASHLIGHT

Heavy duty plastic. Powered by (2) "D" cell batteries (not included). Guaranteed for life!

Item#	Batteries	Case
08171	2 D	6

New LED C.O.B. ROUND WORKLIGHT

Hook Feature

CHIP ON BOARD LED is a group of LED chips that make an intense bright light. The light is wide and much brighter than standard LED's.



- 150 lumens light from the latest COB LED
- Magnet on the back for attaching to metal surfaces
- Built-in adjustable hanging hook
- Adjust the angle of the light head
- Includes (3) AAA batteries

Item#	Case
08111	20

EQ3™ GLO LED HEADLAMP

Easily converts from a headlamp to a clip light. Steady-on and flashing modes. The bezel glows in the dark and has a built-in rotary switch for On, Off, SOS Flashing. 21 lumens. Runs for 8 hours in steady-on mode; 14 hours in flashing mode. Lithium coil cell battery (included). The case is constructed of high-impact ABS plastic with a comfortable headstrap and a magnifier lens that provides a focused beam. Lifetime limited warranty.



Item#	Size	Case
46611	1.9" H x 1.2" D	12

PICO 1.0™ MICRO SAFETY LIGHT DISPLAY JAR

Assorted Colors



So small you can always have a light with you.

- Unbreakable LED provides 10 lumens of light for up to 15 hours
- Carabiner clip makes it easy to attach to zipper or key chain
- Durable anodized aluminum housing
- Easy twist on/off operation - Aggressive knurling provides a good grip in the wet or cold. The bezel end is anodized in a contrast color to indicate the switch location.
- Includes 1 set of LR41 batteries

Item#	Color	Batteries	Pack	Case
46630	Assorted	LR41	50	1

New TEARDROP LED MINI-LANTERN

08191



08201

- Portable, durable and lightweight
- Loop hanger
- Weather resistant
- 100,000 Hours bulb life
- White light
- 3 light modes: 100% / 50% / Flashing
- Batteries included



Item#	Color	Case
08191	Green	50
08201	Orange	50

30-DAY LED LANTERN

30 Days of continuous use in "Low" mode, 32 hours of continuous use in "High" mode. 4-mode electronic switch (press button - High, Medium, Low, and SOS flashing). Powered by (3) D-cell alkaline batteries (not included). The rubberized housing is water and impact resistant. The removable globe and built in recessed hook, at the lantern's base, could be used for hanging the lantern as an area light. Lifetime limited warranty.



Item#	Size	Case
46621	7.25" H X 4.25" D	3

CHARTLIGHT/CIGARETTE LIGHTER



12V. Quick connect wires. Plate Size: 2" x 1 1/2". Clearance behind dash: 2 1/4". 10A @ 12V.

Item#	Description	Case
15101	Stainless steel	12
15111	Chrome plated	12
Opt. Accy.	Description	Case
15121	Replacement Socket	12

ACCESSORY PLUG AND SOCKET



Nickel plated phosphor bronze and nylon. Will accept all other cigarette lighter type units. Equipped with weather seal cover and gasket. 10A @ 12V.

Item#	Description	Size	Case
15001	Plug & Socket		12
15011	Socket Only	2 1/4" L x 1 1/4" W x 1 5/8" D	10
15021	Plug Only		12

DUAL POWER OUTLET



Converts any 12V cigarette lighter socket to dual power outlet. LED light indicates power. Fuse included.

Item#	Case
15061	8

ACCESSORY SOCKET WITH BATTERY CLIP



Brass and plastic construction accessory plug for use directly with the battery. Accepts most type cigarette lighter plugs. 12V.

Item#	Length	Amps	Case
15031	12" of 18 gauge wire	50	12

COILED EXTENSION CORD



- Used to add extra length to spotlight and accessory cords
- 12V-5A
- 150W
- 10' black coiled extension cord

Item#	Case
15051	12

LED SPOT LIGHT



- 8 super LEDs for maximum illumination
- Each super LED produces 85 lumens
- 12V, 11W
- Housing Size: 4 3/8" W x 4" H
- Fastens with a 1/4" bolt
- Includes adjustable stainless steel bracket and clamp mount for up to 1" tubing



Item#	Material	Case
03501	Cast Aluminum	6

SPREADER LIGHT



- Made of stainless steel
- 55W
- Bracket dimensions: 5 3/8" x 3/4"

Item#	Size	Volts	Case
07491	4 3/8" OD x 2 1/2"	12	10
Repl. Parts	Description	Pack	Case
07641	Halogen 35W Bulb, 35W	1 Ea.	12
07631	Halogen Bulb, 55W	1 Ea.	12

HALOGEN FLOODLIGHT



Rigid nylon, fiber filled housing with 304 stainless steel mounting bracket and hardware. 55W halogen beam. Fastens with 1/4" screws. Draws 4 to 5 amps.

Item#	Description	Size	Volts	Case
07521	Halogen	4 1/2" x 6 7/8"	12	20
Repl. Parts	Description	Pack	Case	
07631	Halogen Bulb, 55W	1 Ea.	12	

FLUORESCENT CABIN LIGHT



Silver anodized aluminum base plate with opal diffuser. Black plastic end covers, top mounted rocker switches. Electronic ballast with low current consumption - comes complete with fluorescent tube. 12V.

Item#	Description	Size	Amps	Case
06401	Single Bulb, 4W	9" L x 3" W x 1" H	.45	12
06411	Single Bulb, 8W	15" L x 3" W x 1" H	.6	8
06421	Double Bulb, 8W	15" L x 3" W x 1" H	1.2	8
Repl. Parts	Description	Pack	Case	
06440	F8T5 Bulb, 8W Fluorescent	Bulk	12	
06430	F4T5 Bulb, 4W Fluorescent	Bulk	12	

DAY OR NIGHT VISION DOME LIGHT

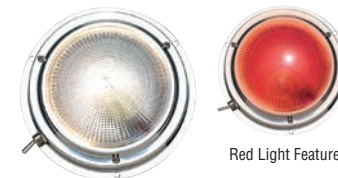

Red Light Feature

Highly polished stainless steel cabin light. Two illumination features: Bright white and red. The red light is ideal for night time use. Heavy duty clear pattern glass lens. Built in stainless steel toggle switch. 15W/12V. 12V-6 CP bulb supplied. Fasten with #6 screws.

Repl. Parts
09871: fits 06641
09881: fits 06651

Item#	Dia.	OD	Height	Case
06641	4"	5 1/2"	1 3/8"	12
06651	5"	6 3/4"	2"	12
Repl. Parts	Description	Pack	Case	
09971	Bulb - DC Bayonet Base 25/8W (GE 1157)	1 pr.	12	
09901	Bulb - DC Bayonet Base 7.5W (GE 90)	1 pr.	12	
09871	Red Bulb DC Bayonet Base 12V - 10W	1	12	
09881	Red Bulb DC Bayonet Base 12V - 15W	1	12	

LED DOME LIGHT



Highly polished stainless steel bright white LED cabin light. Heavy duty festoon clear pattern glass lens. Built in stainless steel toggle switch. 12V, 24 Bulb. Fasten with #6 screws.



Item#	Dia.	OD	Height	Lumens	Case
03281	4"	5 1/2"	1 3/8"		12
03291	5"	6 3/4"	2"	648	12



DOME LIGHT



Highly polished stainless steel bright white cabin light. Heavy duty festoon clear pattern glass lens. Built in stainless steel toggle switch. 15W/12V. 12V-6 CP bulb supplied. Fasten with #6 screws.

Item#	Dia.	OD	Height	Case
06621	4"	5 1/2"	1 3/8"	12
06631	5"	6 3/4"	2"	12
Repl. Parts	Description	Pack	Case	
09901	Bulb - DC Bayonet Base 7.5W (GE 90)	1 pr.	12	

LED COURTESY INTERIOR LIGHT



12V. 4 LED lights. Pre-drilled to accommodate #6 screws. 3" Dia. x 5/8" D. Packed with both chrome and white bezels.



Item#	Bezel	LED Color	Case
03101	(1) Chrome (1) White	White	6
03111	(1) Chrome (1) White	Red	6
03121	(1) Chrome (1) White	Blue	6

LED FIXED UTILITY LIGHT



Molded plastic. Dimensions: 2 1/4" x 2 1/4" x 1 3/16". Installed in 1 3/4" diameter opening.



Item#	Color	Case
08031	Black	6
08041	White	6

FIXED UTILITY LIGHT



Molded plastic. Includes 12V-3W bulb. Dimensions: 2 1/4" x 2 1/4" x 1 3/16". Installed in 1 3/4" diameter opening.

Item#	Color	Case	
08011	Black	12	
08021	White	12	
Repl. Parts	Description	Pack	Case
09891	Festoon Bulb	1 pr.	12

COMPARTMENT LIGHT



Chrome plated plastic hood. Plastic base plate. Dimensions: 2 1/2" x 1 3/16" x 1". Fasten with #8 screws.

Item#	Mount	Case	
08081	Vertical	12	
Repl. Parts	Description	Pack	Case
09891	Festoon Bulb	1 pr.	12

LED BAITWELL/COURTESY LIGHT



Totally waterproof so it can be mounted underwater. Neoprene sealing gasket included. Bright 3-element LED bulb.

Item#	Hole	Size	Case
05461	3/8"	1/4" H x 1" dia.	12
05451	1"	3/8" H x 1 3/4" dia.	12

COURTESY LIGHT



Clean-looking, functional and totally submersible waterproof light. Allows for a wide variety of uses in livewells, baitwells, storage lockers, rod lockers, swim platforms and stepwells. 4W 12V DC.

Item#	Description	Hole	Case
05421	Rear Mount	1"	12
Repl. Parts	Description	Pack	Case
09961	Bulb - Wedge Base 4W (GE 194)	1 pr.	12
09821	LED 13SMD T10 Wedge	1	12

LED UNDERWATER LIGHT STRIP



Waterproof. 12V DC. Pre-drilled to accommodate #8 screws (included).



Item#	Lumens	Watts	LEDs	LED Color	Size	Case
03031	12	0.36	6	Blue	4" L x 1/2" W	6
03401	12	0.36	6	Green	4" L x 1/2" W	6
03061	12	0.36	6	Red	4" L x 1/2" W	6
03001	12	0.36	6	White	4" L x 1/2" W	6
03041	20	0.48	10	Blue	6" L x 1/2" W	6
03411	20	0.48	10	Green	6" L x 1/2" W	6
03071	20	0.48	10	Red	6" L x 1/2" W	6
03011	20	0.48	10	White	6" L x 1/2" W	6
03051	24	0.72	12	Blue	8" L x 1/2" W	6
03421	24	0.72	12	Green	8" L x 1/2" W	6
03081	24	0.72	12	Red	8" L x 1/2" W	6
03021	24	0.72	12	White	8" L x 1/2" W	6

BAYONET SOCKET



Double Contact. 1" body.

Item#	Description	Case	
08301	Brite Steel with 6" Wire Lead (Compatible w/ 09981)	12	
08321	Chrome Plated Brass with 4" Wire Lead	12	
Repl. Parts	Description	Pack	Case
09971	Bulb - DC Bayonet Base 25/8W (GE 1157)	1 pr.	12
09901	Bulb - DC Bayonet Base 7.5W (GE 90)	1 pr.	12

REPLACEMENT BULBS



SEACHOICE APPLICATION CHART

Bulb No. Applications

- 02501: 02941, 02931, 04981, 05071, 05091, 05471, 05611, 05611, 05631, 05691, 06621, 06631 (Perko: 0455 & 1611)
- 02511: 06121, 06131, 06101, 06151
- 06430: 06401
- 06440: 06411, 06421
- 07631: 07521
- 07641: 07521 & Halogen 35W Bulb
- 09821: 05421 & Trailer Side Lights
- 09831: 05011, 05031, 05131, 05251, 05851, 05861, 05931, 05971, 05991
- 09841: 05361, 05391 (Perko: 946)
- 09871: 06641
- 09881: 06651
- 09891: 08011, 08021, 08081
- 09901: 04981, 05071, 05121, 05151, 05381, 05981 (Perko: 0455)
- 09911: 05011, 05031, 05251, 05861, 05931, 05971, 05991
- 09921: 06121, 06131
- 09931: 05361, 05391
- 09951: 05471, 05611, 05691, 06621, 06631
- 09961: 05421 & Trailer Side Lights
- 09971: 51401, 51421, 51431
- 09981: 1157 LED
- 09991: 05701, 05571, 05691 (Old Style)

Item#	Description	Pack	Case
02501	LED Double Bayonet (GE 90 & 1004)	1	12
02511	LED Bulb	1	12
06430	F4T5 Bulb, 4W Fluorescent	Bulk	12
06440	F8T5 Bulb, 8W Fluorescent	Bulk	12
07631	Halogen Bulb, 55W	1 Ea.	12
07641	Halogen 35W Bulb, 35W	1 Ea.	12
09821	LED 13SMD T10 Wedge	1	12
09831	LED Bulb, 4SMD	1	12
09841	LED 4SMD Festoon Bulb	1	12
09871	Red Bulb DC Bayonet Base 12V - 10W	1	12
09881	Red Bulb DC Bayonet Base 12V - 15W	1	12
09891	Festoon Bulb	1 pr.	12
09901	Bulb - DC Bayonet Base 7.5W (GE 90)	1 pr.	12
09911	Festoon Bulb 10W (PKO 71)	1 pr.	12
09921	Bulb 3W	1	12
09931	Festoon Bulb 10W (PKO 70)	1 pr.	12
09951	Bulb 12W (GE 1004)	1 pr.	12
09961	Bulb - Wedge Base 4W (GE 194)	1 pr.	12
09971	Bulb - DC Bayonet Base 25/8W (GE 1157)	1 pr.	12
09981	LED Bulb, 25/8W	1 Ea.	12
09991	Bulb, Wedge Base 10W (906)	1 pr.	12



AMORPHOUS SOLAR PANELS



Amorphous panels work in all daylight conditions helping you to harness the Sun's Energy! Water resistant, shock and rust resistant. Works with cars, SUVs, boats, ATVs and more. Maintenance-free operation. Plugs into 12V DC power port or connects directly to battery. **Optional Solar Controller 14381 is recommended for panels 9 watts and larger.**

- Voltage Indicator: Blue LED indicates panel is active and absorbing power from the sun
- Includes: alligator clips (connect to battery), voltage indicator, 12V DC plug, brackets to mount the solar panel in a fixed position and tilting rods for adjustable positions (Model 14351 has tilting rods only).

Item#	Volts	Size	Watts	Case
14351	12	12½" L x 4" W x 1" D	2	10
14361	12	12½" L x 12½" W x 1" D	6	6
14371	12	24.4" L x 8.3" W x 1" D	9	6

SEMI-FLEX SOLAR PANELS



14451 14461

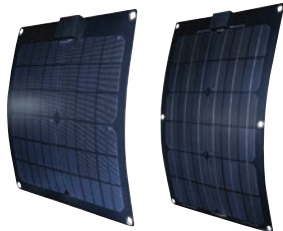

14471 14481 / 14491

Monocrystalline panels are the most efficient solution over all models at converting sunlight to electricity. Since these panels are more efficient you need fewer of them and, if you have limited space, these may be a great option. Works with cars, SUVs, boats, ATVs and more. Weather, water and corrosion resistant. Wafer thin, lightweight and unbreakable with a protective plastic film coating. Can mold to a curved surface and is flexible up to 20°. Temporary installation with included suction cups.

14451, 14461: Includes: alligator clips (connect to battery), 12V DC plug, suction cups. Features a blue LED light on the control box indicating voltage production.
14471, 14481, 14491: Include suction cups only. **Solar Charge Controller required** (sold separately - Model 14401)

Item#	Volts	Size	Watts	Case
14451	12	5.08" x 11.26" x 0.07"	3	6
14461	12	7.09" x 13.31" x 0.07"	5	4
14471	12	14.65" x 14.65" x 0.07"	15	4
14481	12	11.13" x 22.2" x 0.07"	25	10
14491	12	33.5" x 23.25" x 0.07"	50	10

Opt. Accy.	Description	Volts	Amps	Case
14401	Solar Controller	12 / 24	30	6

MONOCRYSTALLINE SOLAR PANEL CHARGING KIT

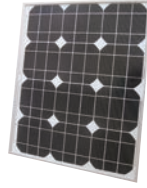

Monocrystalline panels are the most efficient solution over all models at converting sunlight to electricity. Since these panels are more efficient you need fewer of them and if you have limited space, these may be a great option. Ideal for RVs, trucks, boats, cars, generators and more. Maintenance-free, easy to use and offer years of renewable and free energy. Provides up to 6.7 Amps of charging. Kit includes: 12' (3.6m) extension wire, alligator clips and mounting bracket & screws.
Solar Controller required (sold separately - Model 14401). The Solar Charge Controller will protect your 12 Volt Lead-Acid or Gel-Cell battery from being overcharged by the solar panel.

Item#	Volts	Size	Watts	Case
14421	12	30.5" H x 26.4" L x 1.4" W	80	1
Opt. Accy.	Description	Volts	Amps	Case
14401	Solar Controller	12 / 24	30	6

SOLAR CONTROLLER - 10AMP



- Protects solar panels and batteries
- Regulates and protects 12 volt batteries from overcharging and discharging
- Maintenance-free
- For use with solar panels that are 9 watts and larger
- Handles up to 10 amps (120 watts) of array current
- For use with gel-cell and lead-acid batteries
- 25" lead wires
- Compact, easy to use and easy to mount

Item#	Description	Volts	Amps	Case
14381	Solar Controller	12	10	40

SOLAR PANEL CHARGE CONTROLLER



- For use with SEACHOICE model 14341 solar panels and combinations of 14331 solar panels
- 4A maximum capacity
- Prevents excessive discharge and overcharging of batteries

Item#	Description	Volts	Amps	Case
14391*	Charge Controller	12	Up to 4	12

MINI LITHIUM-ION JUMP-STARTER



Case w/ contents

Jump starts most engines up to 6L V8 and gives a FAST charge for electronic devices. Patented technology keeps the battery charged longer and ready to provide power when needed. LCD display for easy to read operation. Expect 8-10 years of battery life under normal conditions. Built in LED flash light (3 Modes - High, slow flash, fast flash). Features Smart Cables which protect against reverse polarity, short circuit, overheating and over discharge.

- **Charging Times:** 110V Wall Charger (4 hrs) & 12V Auto Charger (8 hrs)
- **Cycle Life:** 1,000 Cycles @ 80% depth of discharge
- **Temperature Range:** -4°F to +140°F, (-20°C to +60°C)
- **Includes:** Jump-Starter, Smart Cables, 4-in-1 Mobile Adapter, Car Charger, Laptop Adapters, AC Power Adapter and Zipper Case

Item#	Volts	Amps	Size	Weight	Case
15091	9V-14.4V	600	6.25" L x 3" W x 1.25" H	1 lb.	10

LITHIUM-ION JUMP-STARTER



Case w/ contents

Works on 12V systems on gas engines up to V10 and diesel up to 4.0L and gives a FAST charge for electronic devices. Patented technology keeps the battery charged longer and ready to provide power when needed. LCD display for easy to read operation. Expect 8-10 years of battery life under normal conditions. Built in LED flash light (3 Modes - High, slow flash, fast flash). Features 8 gauge Smart Cables which protect against reverse polarity, short circuit, overheating and over discharge.

- **Charging Times:** 110V Wall Charger (4 hrs) & 12V Auto Charger (8 hrs)
- **Cycle Life:** 1,000 Cycles @ 80% depth of discharge
- **Temperature Range:** -4°F to +140°F, (-20°C to +60°C)
- **Includes:** Jump-Starter, Smart Cables, 4-in-1 Mobile Adapter, Car Charger, Laptop Adapters, AC Power Adapter and Hard Plastic Case.

Item#	Volts	Amps	Size	Weight	Case
15081	9V-14.4V	1000	7" L x 3.5" W x 1.4" H	1.8 lbs.	10

New BATTERY DISCONNECT SWITCH



2 Hole

4 Hole

- Poly housing is rust and corrosion proof
- Key and cover prevent corrosion

Item#	Mount	Amps	Case
11571	2 Holes	200 Continuous 1,000 Inter.	12
11581	4 Holes	200 Continuous 1,000 Inter.	12

MAIN BATTERY SWITCH



Ignition protected. Use as main disconnect switch. Red plastic housing with large black plastic knob. For use with systems under 50V - 250A continuous / 360A intermittent. Made in the USA.



Item#	Size	Case
11551	5 1/4" Dia. x 2 5/8"	12

BATTERY SELECTOR SWITCH



Ignition protected. For use with two or more batteries. For systems under 50V. Permits selection between batteries for starting and charging or operation of both in parallel. 250A continuous / 360A intermittent. Made in the USA.



Item#	Size	Pack	Case
11500	5 1/4" Dia. x 2 5/8"	Bulk	12
11501	5 1/4" Dia. x 2 5/8"		12

BATTERY SELECTOR SWITCH



Ignition protected. Four position without lock. For use with two or more batteries. For systems under 50V. Permits selection between batteries for starting and charging or operation of both in parallel. 160A continuous / 210A intermittent.

Item#	Size	Case
11591	5 1/4" Dia. x 2 5/8"	12

COMPACT MAIN BATTERY SWITCH



With removable side panels for easy wiring. Ignition protected. Use as main disconnect switch. Red plastic housing with large black plastic knob. For use with systems under 50V - 315A continuous / 450A intermittent. Made in the USA.



Item#	Size	Case
11561	4" x 4" x 3 1/8"	12

COMPACT BATTERY SELECTOR SWITCH



With removable side panels for easy wiring. For use with two or more batteries. For systems under 50V. Permits selection between batteries for starting and charging or operation of both in parallel. 315A continuous / 450A intermittent. Made in the USA.



Item#	Size	Case
11531	4" x 4" x 3 1/8"	12

CIRCUIT TESTER



Used to locate grounds, open circuits and shorts. Can be used with 6V or 12V systems. 36" wire with alligator clips.

Item#	Case
15041	12

BATTERY BOX



Meets ABYC standard E-10 and USCG spec 183.420. Black molded high density polyethylene. Protects battery and area around battery from acid spills. Lid is designed to allow easy access around battery cables and wires. Complete with hold down strap and mounting hardware.

Item#	Fits	Size	Case
22060	Group 24	10 1/2" L x 7 1/4" W x 10" H	6
22080	Group 27	14" L x 7 1/4" W x 10" H	3

BATTERY TRAY WITH HOLD DOWN STRAP

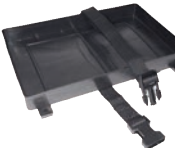

Meets USCG regulations for keeping batteries in place. Poly hold down strap with positive locking quick connect buckle make changing battery quick and easy. Mounts with #10 pan head screws.

Item#	Fits	Size	Fastener	Case
22031	Group 24	11" L x 7" W x 1 1/8" H	4	12
22051	Group 27	12 1/4" L x 7 1/4" W x 1 1/8" H	4	12
22011	Group 29, 31	13" L x 7 1/8" W x 1" H	8	12

Repl. Parts	Description	Size	Case
78961	Black w/ Blk plastic Buckle	1 1/2" x 32"	12
78981	Black w/ Blk plastic Buckle	1 1/2" x 42"	12
78951	Black w/ S.S. Buckle	1 1/2" x 62"	12

BATTERY TRAY



Meets USCG regulations for keeping batteries in place. Complete with stainless steel hold down rods, nuts & washers.

Item#	Fits	Size	Case
22021	Group 24	ID: 11" x 7 1/8" x 1 1/4"	12
22041	Group 27	ID: 12 5/8" x 7 1/4" x 1 1/4"	12
22071	Group 29	ID: 13" x 7 1/8" x 1"	12



PREMIUM BATTERY TRAY



Complete with stainless steel hold down rods. **Will not fit Exide® batteries.**

Item#	Fits	Size	Case
21961	Group 24	ID: 10 ³ / ₈ " x 6 ¹³ / ₁₆ " x 1 ¹ / ₂ "	12
21981	Group 27	ID: 11 ¹ / ₈ " x 6 ¹³ / ₁₆ " x 1 ¹ / ₂ "	12
21991	Group 29	ID: 13 ¹ / ₈ " x 6 ⁷ / ₈ " x 1 ¹ / ₂ "	12
21971	Group 31	ID: 12 ¹⁵ / ₁₆ " x 6 ³ / ₄ " x 1 ¹ / ₂ "	12

BATTERY OR TIE-DOWN STRAP



Polypropylene webbing. Ideal for securing battery boxes and other equipment. Replacement for 22031, 22051 and 22011.

78981: Includes brackets and stainless steel screws.

Item#	Description	Size	Case
78981	Black w/ Blk plastic Buckle	1 ¹ / ₂ " x 42"	12
78961	Black w/ Blk plastic Buckle	1 ¹ / ₂ " x 32"	12
78951	Black w/ S.S. Buckle	1 ¹ / ₂ " x 62"	12

BATTERY TERMINAL - POST TOP STYLE

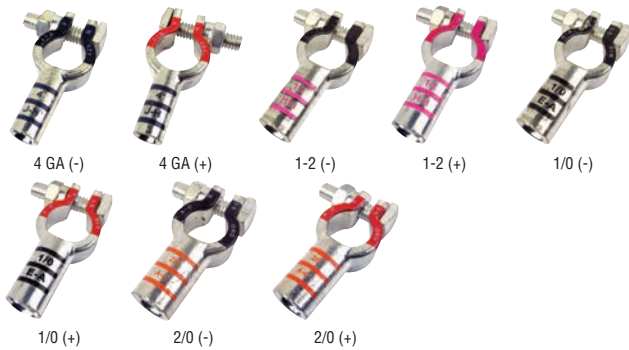

Environmentally friendly, 100% copper battery terminal. The post top design is manufactured with the highest quality C11000 ETP copper and is completely lead free and RoHS compliant – making it exempt from CA Proposition 65 requirements.

- Maximum conductivity (101% IACS at 68F)
- Tin plated for corrosion resistance
- Provided with nut and bolt installed
- Exceeds SAE standard J-1811
- Color coded, die coded

Item#	Description	Cable Size	Material	Case
63541	Negative	4	Copper	10
63551	Positive	4	Copper	10
63601	Negative	1-2	Copper	10
63611	Positive	1-2	Copper	10
63561	Negative	1/0	Copper	10
63571	Positive	1/0	Copper	10
63581	Negative	2/0	Copper	10
63591	Positive	2/0	Copper	10

BATTERY TERMINAL - CLAMP STYLE, COATED



Quick and simple way to repair battery cable ends. No crimping tool needed. Epoxy coating aids in polarity identification and corrosion resistance. 3/8" positive stud and 5/16" negative stud. Fits all standard battery posts.

Item#	Description	Cable Size	Material	Color	Case
62731	Positive	6 to 1 gauge	Epoxy Coated Lead Alloy	Red	10
62721	Negative	6 to 1 gauge	Epoxy Coated Lead Alloy	Black	10

BATTERY TERMINAL - CLAMP STYLE



Fits positive or negative posts. Made from 100% recycled lead. Clamp holds cable or strap. Removable plate for easy assembly. Threaded clamp avoids pull-out.

Item#	Description	Cable Size	Material	Pack	Case
13721	Universal	6 to 1 gauge	Lead Alloy	2	12
13720	Universal	6 to 1 gauge	Lead Alloy	10	1

BATTERY TERMINAL - WING NUT, COATED



Epoxy coating aids in polarity identification and corrosion resistance. 3/8" positive stud and 5/16" negative stud. Fits all standard battery posts.

Item#	Description	Material	Pack	Case
13661	Pos & Neg	Epoxy Coated. Lead Alloy.	1 pr.	12

BATTERY TERMINAL - WING NUT

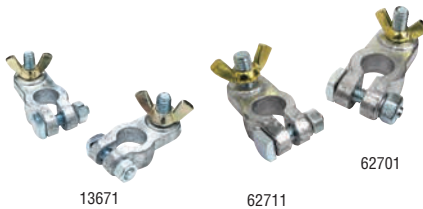

Converts standard battery post terminals to a marine stud connector. Allows for easy removal of connector from battery. Plated wing nuts. 3/8" Positive stud and 5/16" negative stud. Fits all standard battery posts.

Item#	Description	Material	Pack	Case
13671	Pos & Neg	Lead Alloy	2	12
13730	Universal	Lead Alloy	10	1
62711	Positive	Cast Lead Alloy	1	10
62701	Negative	Cast Lead Alloy	1	10

BATTERY TERMINAL COVER



Contains 1 red and 1 black protector boot. **Marine:** Accommodates battery terminals w/ wing nut. **Standard:** Accommodates battery terminals w/o wing nut.

Item#	Type	Cable Size	Fits	Pack	Case
13681	Marine	2-2/0	13671, 13661	1 pr.	12
13701	Marine	4 & 6	13671, 13661	1 pr.	12
13641	Standard	2-2/0		1 pr.	12
13691	Standard	4 & 6		1 pr.	12

COAXIAL ANTENNA CABLE ASSEMBLY



RG58U white coaxial cable with PL259 fittings on both ends. Lengths to fit most applications.

Item#	Size	Case
19781	5' Cable w/ Fittings	12
19761	10' Cable w/ Fittings	12
19771	20' Cable w/ Fittings	12

PLASTIC WIRE COVER



Gives boat that finished look. Covers unsightly wire pass-thru holes. Made of durable black plastic that will not corrode. Covers holes up to 1 1/4" in diameter.

Item#	Hole	Pack	Case
16251	Up to 1 1/4"	1 pr.	12

CABLE THRU HULL FITTING



Watertight thru hull fitting. Self attaching. No additional hardware required. Accepts single or double cable. 2" maximum hull.

Item#	Description	Color	Hole	Case
17921	1/4" Slot, 1 1/4" Flange	White	3/4"	12
17991	3/32" Slot, 1 1/2" Flange	White	1"	12
17901	1/4" Slot, 1 1/4" Flange	Black	3/4"	12
17971	3/32" Slot, 1 1/2" Flange	Black	1"	12

CABLE OUTLET



Watertight chrome plated brass. Threaded cap and rubber gasket. For complete waterproofing of cable. Use #6 screws.

Item#	Size	Base	Case
10011	Outlet: 1/4"	1 1/4" dia.	12
10021	Outlet: 5/16"	1 1/4" dia.	12
10031	Outlet: 3/8"	1 1/2" dia.	12

ELECTRICAL TAPE



Black vinyl electrical tape. Flame retardant. 7 mil. roll. UL listed.

Item#	Size	Case
14001	3/4" x 60"	12



SILICONE SELF-FUSING TAPE



Ideal for almost any application requiring a waterproof seal.

- Center ridge line facilitates uniform application of tape
- An excellent insulator with high dielectric strength (400 volts per mil)
- Revolutionary alternative to heat shrink tubing
- Begins curing immediately - completely cures within 24 hours
- Forms a permanent moisture tight seal
- Ideal for high temperature applications (-65° F to +500° F)
- No adhesive residue upon removal
- Seamless self-fusing silicone tape
- Salt water resistant

Item#	Color	Size	Case
61471	Black	1" x 10'	10
61481	Red	1" x 10'	10
61461	White	1" x 10'	10
61491	Yellow	1" x 10'	10

LIQUID ELECTRICAL TAPE

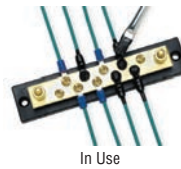

Forms a protective dielectric coating on electrical connections. Seals out moisture, prevents corrosion. Adheres to all metal, plastic, vinyl, rubber, and composite surfaces. Stops screws from loosening due to vibration. Safe and easy to use and is fast drying. Applicator brush built into cap.

Item#	Size	Color	Case
14201	4 oz.	Black	12
Canada Only			
14205	4 oz.	Black	12

BATTERY CLIP



For use with all battery operated electrical devices. Copper plated. 1" jaw opening. 3" long.

Item#	Amps	Pack	Case
13651	50	1 pr.	12

CABLE TIES



The Mounting style accommodates # 8 screw.

Item#	Size	Color	Max Load	Pack	Case
Standard					
14131	4"	UV Black	18 lbs.	100	25
14071	4"	UV Black	18 lbs.	1000	10
14241	4"	Natural	18 lbs.	25	10
14251	6"	Natural	50 lbs.	25	25
14141	6"	UV Black	50 lbs.	100	25
14261	8"	Natural	50 lbs.	25	25
14101	8"	UV Black	50 lbs.	25	25
14111	8"	UV Black	50 lbs.	100	25
14121	8"	UV Black	50 lbs.	1000	10
14271	11"	Natural	50 lbs.	25	25
14151	11"	UV Black	50 lbs.	100	25
14081	11"	UV Black	50 lbs.	500	10
14281	14"	Natural	50 lbs.	25	25
14191	14"	UV Black	50 lbs.	100	25
14211	14"	UV Black	120 lbs.	100	25
14091	14"	UV Black	50 lbs.	500	10
Mounting					
14291	8"	Natural	50 lbs.	25	25
14161	8"	UV Black	50 lbs.	25	25
14171	8"	UV Black	50 lbs.	100	25
14181	8"	UV Black	50 lbs.	1000	10



STAINLESS STEEL CUSHION CLAMPS



Resistant to oils, acids and salt water. All clamps have a #10 stud size. Temperature range form -50° to 300°F. 304 Stainless Steel.

Item#	Size	Pack	Case
23201	1/4"	10	10
23211	5/16"	10	10
23221	3/8"	10	10
23231	1/2"	10	10
23241	5/8"	10	10
23251	3/4"	10	10
23261	1"	10	10
23271	1 1/4"	10	10
23281	1 1/2"	10	10
23291	1 3/4"	10	10
23301	2"	10	10
23311	2 1/2"	10	10
23321	3"	10	10

MOLDED MARINE CONNECTOR



Polarized 2 contact connector. For marine and automotive use. Molded ABS interiors. Protected by PVC caps. For 6V, 12V and 24V applications. 10A @ 12V.

Item#	Description	Case
13801	Round	12

DECK CONNECTOR



Water-tight chrome plated brass. 1 1/2" dia. chrome plated brass flange with waterproof plastic snap-on cover. Two pin double contact socket and plug. Plug has protective black plastic boot. Fasten with #4 screws. 3A @ 12V.

Item#	Case
10121	12

DECK CONNECTOR



Water-tight chrome plated brass. Brass double contacts supplied complete with black plastic threaded knurled cap and chain. Insures positive watertight fitting. Fasten with #6 screws. Flange diameter 1 1/2". Overall length: 2 3/4". 3A @ 12V.

Item#	Case
10161	12

304 STAINLESS STEEL POWER SOCKET



- 12V
- Fasteners included
- Stamped 304 stainless steel mounting plate

Item#	Fastener	Case
15131	#8 Screws	12

ACCESSORY PLUG AND SOCKET



Item#	Description	Size	Case
15001	Plug & Socket		12
15011	Socket Only	2 1/4" L x 1 1/4" W x 1 5/8" D	10
15021	Plug Only		12

DUAL USB POWER ADAPTER



- Use with: Mobile Phones, iPad, iPod and Phones, MP3/4, Digital Camera, etc.
- LED indication light
- Plugs into most cigarette lighters or 12V accessory outlets to allow use of up to 2 USB devices



Item#	Input	Output	Case
15071	12-24V	5V DC/2 Amps	12

DUAL POWER OUTLET



Converts any 12V cigarette lighter socket to dual power outlet. LED light indicates power. Fuse included.

Item#	Case
15061	8

ACCESSORY SOCKET WITH BATTERY CLIP



Brass and plastic construction accessory plug for use directly with the battery. Accepts most type cigarette lighter plugs. 12V.

Item#	Length	Amps	Case
15031	12' of 18 gauge wire	50	12

COILED EXTENSION CORD



- Used to add extra length to spotlight and accessory cords
- 12V-5A
- 150W
- 10' black coiled extension cord

Item#	Case
15051	12

TERMINAL BLOCK

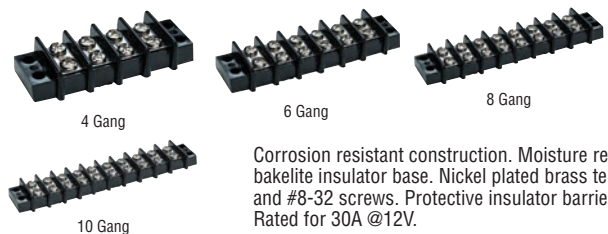

Corrosion resistant construction. Moisture repellent bakelite insulator base. Nickel plated brass terminals and #8-32 screws. Protective insulator barrier strips. Rated for 30A @ 12V.

Item#	Gang	Size	Case
13561	4	4"L x 1 5/16"W x 1 1/16"H	12
13571	6	4 3/8"L x 1 5/16"W x 1 1/16"H	12
13581	8	5 1/2"L x 1 5/16"W x 1 1/16"H	12
13591	10	6 5/8"L x 1 5/16"W x 1 1/16"H	12

TERMINAL BLOCK



Molded plastic base with brass hardware. 30A @ 12V.

Item#	Gang	Size	Case
13501	4	3"L x 1 1/2"W x 3/16"H	12
13531	6	4 1/2"L x 1 1/2"W x 3/16"H	12

TERMINAL BLOCK



Corrosion resistant construction. Moisture repellent bakelite insulator base. Solid brass bus bar. Brass 1/4" dia. stud terminals and hex nuts. Brass #8-32 terminal screws.

Item#	Gang	Size	Case
13631	10	5 3/4" L x 1 1/4" W x 1 1/2" H	12

FUSE AND JUNCTION BLOCK



4 Gang



6 Gang

Heavy duty base. Brass fuse clips and contacts with #8-32 screws. For SFE 20A or 3AG series fuse.

Item#	Gang	Size	Case
13351	4	2 3/4" L x 2 3/4" W x 5/8" H	12
13361	6	4 1/4" L x 2 3/4" W x 5/8" H	12

FUSE AND TERMINAL BLOCK



4 Gang



6 Gang



8 Gang

Heavy duty molded base. Brass clips and contacts with common buss bar. Use SFE 20A or 3AG series fuse. Each buss bar has one #8-32 x 3/4" stud with two hex nuts.

Item#	Gang	Size	Case
13431	4	3 1/2" L x 3" W x 3/4" H	12
13441	6	4 1/2" L x 3 1/4" W x 7/8" H	12
13451	8	6" L x 3 1/4" W x 7/8" H	12

ATO/ATC FUSE BLOCK



13301



13311

Heavy duty black plastic molded base with ground bar. 30A @ 12V DC.

Item#	Gang	Size	Case
13301	6	3 3/4" L x 3 5/16" W x 1 3/16" H	12
13311	10	5" L x 3 5/16" W x 1 3/16" H	12

FUSE HOLDER



Panel mount. Square face panel mount fuse holder. Accepts up to 10A fuses.

Item#	Case
12611	12

FUSE HOLDER



Panel mount. For 1/4" x 1/4" fuses. (fuses not included), with bayonet-type knob spring pressure contact. Complete with gasket and nut. For panels through 5/16".

Item#	Pack	Case
12600	Bulk	25
12601		12

FUSE HOLDER



In-Line, heavy duty holder with 4 1/2" of orange wire leads. Fuse included.

Item#	Gauge	Fuse	Case
12651	12	30A	12

FUSE HOLDER



Fuse Holder w/ Spare



Fuse Holder

Watertight In-Line. Molded of heat resistant non-breakable plastic. "Push together" type is watertight.

12701, 12711, 12721: Has spare fuse compartment. Supplied with two nickel plated brass fuses.
12731, 12741, 12751: Supplied with nickel plated brass fuse. Fits 1/4" x 1/4" fuses. 8" Wire

Item#	Description	Gauge	Fuse	Case
12701	Holder w/spare	16	10A	12
12711	Holder w/spare	14	20A	12
12721	Holder w/spare	10	30A	12
12731	Holder	16	10A	12
12751	Holder	14	20A	12
12741	Holder	10	30A	12

FUSE HOLDER



In-Line, heavy duty. Accommodates a variety of sizes. 6V and 12V application. Fuse not included.

Item#	Gauge	Fuse	Case
12661	16	20A	12

IN-LINE WATERPROOF FUSE HOLDER



Watertight. Yellow neoprene fuse holder is waterproof and is to be used with AGC fuse. Sold in pairs.

Item#	Fuse	Pack	Case
12681	20A	1 pr.	12

IN-LINE FUSE HOLDER/ATO-ATC



Water resistant. Easy to install, easy to change ATO-ATC fuse holder. Used in most recreational vehicles. Comes with cap to seal out moisture. Brass electrical contacts. Fuse included.

Item#	Gauge	Fuse	Case
12761	16	10A	12
12771	12	30A	12

ATO/ATC FUSE HOLDER



Water tight. Extra heavy duty weatherproof fuse holder with wire leads for easy hook-up. Fuse not included.

Item#	Gauge	Fuse	Case
12671	12	Up to 30A	12

LED SWITCH PANEL



12321

12331

12341

12321: Contains (1) 4A, (1) 6A, (1) 8A, and (1) 10A
12331: Contains (2) 5A, (2) 6A, (1) 8A, and (1) 10A
12341: Contains (1) 4A, (2) 5A, (2) 6A, (2) 8A, and (1) 10A

Item#	Gang	Size	Case
12321	4	4 1/4" L x 4" W x 1 1/4" D	12
12331	6	6 1/4" L x 4" W x 1 1/4" D	12
12341	8	8 1/4" L x 4" W x 1 1/4" D	12

- Molded black plastic
- 12V
- Pre-drilled with countersunk holes to accommodate #8 screws



Repl. Parts	Description	Size	Volts	Case
13231	Circuit Breaker	5 Amp		12
12461	Repl. LED Rocker Switch		12	12
13251	Circuit Breaker	8 Amp		12
13241	Circuit Breaker	6 Amp		12
13261	Circuit Breaker	10 Amp		12



BREAKER PANEL



- Lighted waterproof rocker switches
- Made of 5052 aluminum and powder coat finish
- Pre-wired with reset breakers and clear boots
- Tinned copper wire
- UL rated

Note: Replacement circuit breakers - see series 13091 thru 13151.

12491: Includes 1-5A, 1-10A, 1-15A, 1-20A breakers and 20 labels
12501: Includes 2-5A, 2-15A, 2-20A breakers and 27 labels

Item#	Gang	Size	Case
12491	4	5 1/4" x 7 1/2"	6
12501	6	5 1/4" x 7 1/2"	6

Repl. Parts	Description	Positions	Color	Type	Terminals	Case
12961		On/Off	Black	SPST	3	12
12371	1 pr. Clear Breaker Boots					12

AC/DC PANEL BREAKER



Single Pole. Circuit breakers are magnetic hydraulic and are designed for marine use.

- UL and CSA approved
- Current: AC/DC
- Delay: Medium
- Actuator: Single/White

Item#	Amps	Rating	Case
13101	10	65V DC/227V AC	12
13121	15	65V DC/227V AC	12
13141	20	65V DC/227V AC	12
13161	30	65V DC/227V AC	12
13181	40	65V DC/125V AC	12
13201	50	65V DC/125V AC	12

CIRCUIT BREAKER



Push to reset. Calibrated and tested. Single pole circuit breakers. A proven "Snap-Acting" bi-metallic thermal sensing mechanism used to interrupt current flow. Manual push to reset reinstates current flow. Max panel thickness 1/4", 3/8" hole. 1/2" W x 1 3/8" H x 1 3/16" D.



Item#	Amps	Case
13091	5	12
13111	10	12
13131	15	12
13151	20	12
13171	30	12

Opt. Accy.	Description	Case
12371	1 pr. Clear Breaker Boots	12

MANUAL CIRCUIT BREAKER



- 12/24V DC
- Type III manual reset
- Plastic body with molded mounting brackets
- Two 10/32 threaded studs
- Push to reset
- Ideal for trolling motor installation

Item#	Amps	Case
13051	20	12
13061	30	12
13071	40	12
13081	50	12

Opt. Accy.	Description	Case
13711	Breaker Bracket	12

INDICATOR LIGHT



Red indicator lights with 6" leads. Use as 14V warning light
09851: For use as warning light in panels
09861: Use as visual warning of engine/bilge problems

Item#	Description	Size	Case
09851	LED	1/4"	12
09861	Incandescent (with 4V bulb)	5/16"	12

3 POSITION MAGNETO IGNITION SWITCH



3 Positions: Off - Ignition - Start. "Push to Choke." Includes two keys.

- Stem Width: 1 3/16"
- Ignition: 15 Amps @ 12V
- Solenoid: 30 Amps @ 12V
- Choke: 7 Amps @ 12V"

11831 Wires: Red = 12V+, Purple = ignition, Black/Magenta = ground, Black/Yellow = magneto, Yellow/Black = choke

Item#	Material	Max Panel Thickness	Terminals	Case
11821	Polypropylene	5/8"	6 Screw	12
11831	Polypropylene	5/8"	6 Wire	12

3 POSITION HEAVY DUTY IGNITION STARTER SWITCH

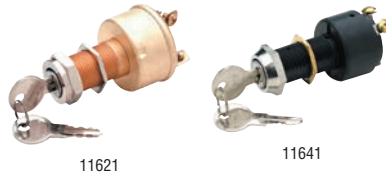

3 Position: Off - Ignition - Start. 15A @ 12V DC. Chrome plated brass face nut and brass back-up nut. Supplied with two keys. Stainless steel springs.

11621: Mounting stem 1 1/2"L, 1 3/8" - 24 thread dia.
11641: Mounting stem 1 7/16"L, 1 3/8" - 20 thread dia. Overall Dimensions: 3 1/4"L; 1 7/16" dia.

Item#	Material	Max Panel Thickness	Terminals	Case
11621	Brass	To 1"	3	12
11641	Plastic	To 1 1/8"	3	12

4 POSITION STARTER SWITCH



4 Position: Acc.-Off-Ignition-Start. Includes two keys and a boot.

- Stem Width: 1 3/16"
- Ignition: 15 Amps @ 12V
- Solenoid: 13 Amps @ 12V
- Accessory: 15 Amps @ 12V

Item#	Material	Max Panel Thickness	Terminals	Case
11801	Polypropylene	1 1/8"	4 Screw	12

JOHNSON/EVINRUDE IGNITION STARTER SWITCH



Position: Off - Ignition - Start. Replacement for OMC 393301. Pollak 33-105. Fits most OMC inboard/outboard powered boats. 20A @ 12V DC. "Push To Choke." Supplied with two keys. Overall Size: 2 7/64" L; 1 2 9/64" dia.

Item#	Material	Max Panel Thickness	Terminals	Pack	Case
11650	Delrin®	To 1/4"	6	Bulk	12
11651	Delrin®	To 1/4"	6		12

UNIVERSAL KILL SWITCH AND LANYARD



50" coil type lanyard. Black nylon casing. 5A @ 12V.

Switch w/Coil Lanyard

Item#	Description	Case
11681	Switch w/ Coil Lanyard	12
Repl. Parts	Description	Case
11691	Replacement Coil Lanyard	12
11671	Replacement Lanyard w/ 7 Keys	12

HORN SWITCH



Momentary "On-Off"

Heavy duty push button switch. Black plastic button, chrome plated brass housing. 1 1/2" dia. switch. Overall width is 2 5/8". Center to center holes 2 1/16" apart.

Item#	Amps	Case
11711	5	12

HORN SWITCH



Red push button switch used for horn button or any momentary function. Mounts in 1/2" hole and used on panels up to 1/4" thick.

Item#	Case
11701	12

PUSH BUTTON STARTER/HORN SWITCH



2 Position: Off - Momentary On. Normally "Off"
Heavy duty. Fits panels up to 1" thick. Insulated. 25A @ 6V DC. 15A @ 12V DC. Supplied with chrome plated brass face nut, brass washer and back-up nut. Stainless steel springs. 2 7/8" Length. Mounting stem 1 1/4" L, 5/8" D - 32 thread.

Item#	Case
11781	12

MOMENTARY PUSH BUTTON SWITCH



11751

11761

11771

2 Position: Off - Momentary On. Normally "Off" S.P.S.T.

Heavy duty. 6V - 36V DC. Non-corrosive construction.

11751: Momentary push button switch. Polyester body and silver contacts with special moisture proof rubber cap. 30A @ 12V DC. 50A @ 6V DC. Insulated. Chrome plated brass fittings included.

11761: Plasticized body sealed against moisture & dirt. Black moisture repellent rubber button cover. Two 18 gauge wire leads, 12" L. Mounting stem 1 5/16" L, 5/8" - 32 thread dia.

11771: Gasket sealed case protects against moisture and dust. Molded plastic insulator with protective barrier between terminals. Black moisture repellent rubber button cover. Silver contacts. Mounting stem 1 3/8" L, 5/8" - 32 thread dia.

Item#	Max Panel Thickness	Case
11751	1"	12
11761	1/2"	12
11771	1"	12

BILGE PUMP SWITCH



19371

19381

Ideal for bilge pump applications
3 Position: On - Off - Mom
On 3 Blade type terminals. Single pole. Water resistant plastic housing.

Item#	Description	Volts	Amps	Size	Case
19371	Switch w/bilge pump faceplate	12	20	Stem: 1 1/16" L Diameter: 1 5/32"	12
19381	Rocker switch	12	15	1" x 1 1/16" Cut-out size: 2 7/32" x 1 29/64"	12

TOGGLE SWITCH

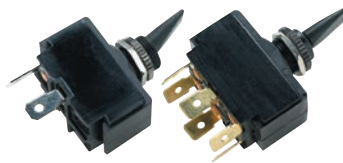

2 Terminal

6 Terminal

Black plastic paddle and locking ring with lever seal and knurled cap nut. Sealed to resist water penetration. Requires 1 5/32" mounting hole. Fits panels through 1/4".

12001: Ideal for lights, blower, pump, etc.
12011: Ideal for starter, horn or choke.
12021: Ideal for running & anchor lights, wipers, manual/auto bilge pumps.
12031: Ideal for trim tabs.

Item#	Positions	Terminals	Rating	Case
12001	2 - On/Off	2	15A @ 12V DC 10A @ 24V DC	12
12011	2 - Off/ Mom. On	2	15A @ 12V DC 10A @ 24V DC	12
12021	3 - On/Off/On	6	15A @ 12V DC 10A @ 24V DC	12
12031	Mom On/Off/ Mom On	6	15A @ 12V DC 10A @ 24V DC	12

ILLUMINATED TOGGLE SWITCH

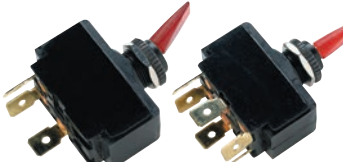

3 Terminals

6 Terminals

Red plastic paddle that illuminates when under load. Complete with locking ring and knurled cap nut. Sealed to resist water penetration. Requires 1 5/32" mounting hole. Fits panels through 1/4".

12201: Ideal for lights, blower, pump, etc.
12211: Ideal for starter, horn or choke.
12221: Ideal for running & anchor lights, wipers, manual/auto bilge pumps.
12231: Ideal for use with trim tabs

Item#	Positions	Terminals	Rating	Case
12201	2 - On/Off	3	16A @ 12V DC	12
12211	2 - Off/Mom On	3	16A @ 12V DC	12
12221	3 - On/Off/On	6	16A @ 12V DC	12
12231	3 - Mom On/Off/Mom On	6	15A @ 12V DC	12

TOGGLE BOOT SEAL



12391

12401

Fits standard toggle switches with 1 5/32" - 32 mounting stem. Accommodates toggle handles through 1 1/16" L. Protects against moisture and dirt. Completely covers toggle handle. Brass threads.

Item#	Color	Pack	Case
12361	Black	1 pr.	12
12391	Black	1	12
12401	Grey	1	12



TOGGLE SWITCH

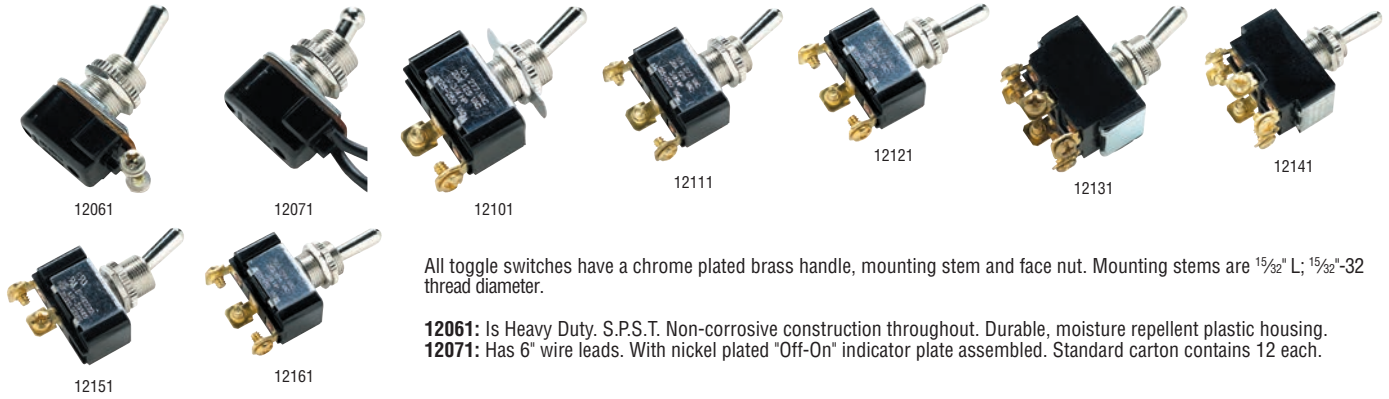

All toggle switches have a chrome plated brass handle, mounting stem and face nut. Mounting stems are 1⁵/₃₂" L; 1⁵/₃₂"-32 thread diameter.

12061: Is Heavy Duty. S.P.S.T. Non-corrosive construction throughout. Durable, moisture repellent plastic housing.
12071: Has 6" wire leads. With nickel plated "Off-On" indicator plate assembled. Standard carton contains 12 each.

Item#	Positions	Terminals	Max Panel Thickness	Rating	Case
12061	2 - Off/On (SPST)	2 Screw	1/4"	10A @ 12V DC Lamp Load - 3A @ 250V AC - 6A @ 125V AC 15A @ 12V DC Inductive Load	12
12071	2 - Off/On (SPST)	6" Wire Leads	3/8"	35A @ 6V DC 20A @ 12V DC, 3A @ 250V AC - 6A @125V AC	12
12101	2 - Off/On (SPST)	2 Screw	3/8"	25A @ 12V DC, 10A @ 250V AC - 20A @125V AC	12
12111	2 - On/On (SPST)	3 Screw	3/8"	25A @ 12V DC, 10A @ 250V AC - 20A @ 125V AC	12
12121	3 - On/Off/On (SPST)	3 Screw	3/8"	25A @ 12V DC, 10A @ 250V AC - 20A @ 125V AC	12
12131	2 - On/On (DPDT)	6 Screw	3/8"	25A @ 12V DC, 10A @ 250V AC - 20A @ 125V AC	12
12141	3 - On/Off/On (DPDT)	6 Screw	3/8"	25A @ 12V DC, 10A @ 250V AC - 20A @ 125V AC	12
12151	2 - Off/ Mom On (SPST)	2 Screw	3/8"	25A @ 12V DC, 25A@ 6 & 12V DC Inductive Load 20A @ 6 & 12V DC Lamp Load	12
12161	3 - Mom On/Off/Mom On (SPST)	3 Screw	3/8"	25A @ 12V DC, 25A@ 6 & 12V DC Inductive Load 20A @ 6 & 12V DC Lamp Load	12

CONTURA® ROCKER SWITCH



Sealed front panel components give these switches complete protection against dust and prolonged spray and submersion. Switches are ignition protected, vibration, shock, moisture and salt spray resistant. Base is made of durable polyester while actuator is of a polycarbonate material. Rated 20A @ 12V, 15A @ 125VAC and 10A @ 250VAC. Requires .830"W x 1.45"L holes.

Item#	Positions	Color	Type	Terminals	Case
Non-Illuminated					
12811	On/Off	White	SPST	2	12
12891	Mom/Off	White	SPST	2	12
12931	Mom/Off/Mom	White	SPST	3	12
12851	On/Off/On	White	DPDT	6	12
12951	Mom On/Off/Mom On	White	DPDT	6	12
12801	On/Off	Black	SPST	2	12
12881	Mom/Off	Black	SPST	2	12
12921	Mom/Off/Mom	Black	SPST	3	12
12841	On/Off/On	Black	DPDT	6	12
12941	Mom On/Off/Mom On	Black	DPDT	6	12
Illuminated					
12971	On/Off	White	SPST	3	12
13011	Mom/Off/On	White	DPST	4	12
12991	On/Off/On	White	DPDT	7	12
13031	On1/Off/On1&2	White	DPDT	7	12
12961	On/Off	Black	SPST	3	12
13001	Mom/Off/On	Black	DPST	4	12
12981	On/Off/On	Black	DPDT	7	12
13021	On1/Off/On1&2	Black	DPDT	7	12

ROCKER SWITCH



Rated 16A @ 12V. Requires .86" x 1.45" cut out.

Item#	Positions	Color	Type	Terminals	Case
Non-Illuminated					
10811	On/Off	White	SPST	2	12
10891	Mom/Off	White	SPST	2	12
10931	Mom/Off/Mom	White	SPST	3	12
10851	On/Off/On	White	DPDT	6	12
10951	Mom On/Off/Mom On	White	DPDT	6	12
10801	On/Off	Black	SPST	2	12
10881	Mom/Off	Black	SPST	2	12
10921	Mom/Off/Mom	Black	SPST	3	12
10841	On/Off/On	Black	DPDT	6	12
10941	Mom On/Off/Mom On	Black	DPDT	6	12
Illuminated					
10971	On/Off	White	SPST	3	12
11011	Mom/Off/On	White	DPST	5	12
10991	On/Off/On	White	DPDT	5	12
10961	On/Off	Black	SPST	3	12
11001	Mom/Off/On	Black	DPST	5	12
10981	On/Off/On	Black	DPDT	5	12

ROCKER SWITCH



- Snap mount thermo-plastic housing
- 12V - 15A
- Fits panels up to 1/4" thick
- Overall size: 1 3/4" x 1 3/8"
- Cut-out size: 1" x 3/4". With plug-in type terminals

Item#	Positions	Terminals	Case
12411	On/Off	2	12
12421	On (Red)/Off	3	12
12431	On-Off-On	6	12
12441	On (Red)/Off/On (Red)	6	12

PUSH-PULL SWITCH



Switches with spade connections make installation quick and easy. Chrome plated brass face nut, washer and back-up nut. Chrome plated plastic knob. Stainless steel springs. Available in the two most popular styles.

11931: 2 Position: Off-On. Chrome plated brass face nut, washer and back-up nut. Chrome plated plastic knob. Stainless steel springs.

11941: 3 Position: Off-On - On. First "On" energizes one circuit. Second "On" energizes both circuits. Brass hex back-up nut, brass washer, chrome plated brass face nut. Chrome plated plastic knob.

Item#	Positions	Circuits	Rating	Panel Thickness	Case
11931	Off - On	1	25A @ 6V DC 15A @ 12V DC	1"	12
11941	Off - On #1 On Both #1, #2	2	25A @ 6V DC 15A @ 12V DC	1"	12

PUSH-PULL SWITCH

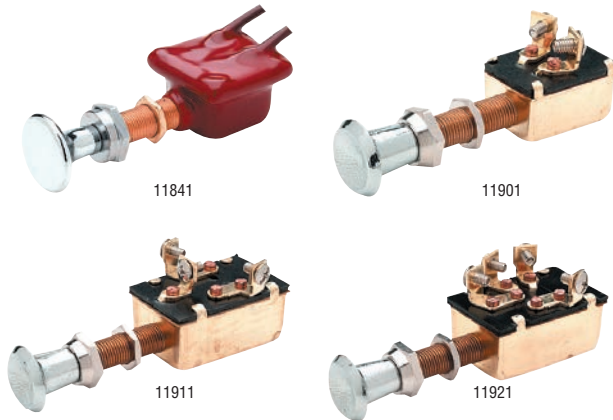

Heavy Duty. All push-pull switches have mounting stems: 1 1/4" L x 3/8" dia.

11841: 2 Position: Off - On. One circuit. Normally "Off" S.P.S.T. Non-corrosive construction. Plasticized body sealed against moisture and dirt. Two 18 gauge insulated copper wire leads, 12" L. Chrome plated brass knob and face nut.

11901: 2 Position: Off - On. Chrome plated brass face nut, washer and back-up nut. Chrome plated plastic knob. Stainless steel springs.

11911: 3 Position: Off - On #1 - On On Both #1, #2. First "On" energizes one circuit. Second "On" energizes both circuits. Brass hex back-up nut, brass washer, chrome plated brass face nut. Chrome plated plastic knob.

11921: 3 Position: Off - On #1 - On #2. Two separate circuits. Suited for anchor lights and a separate circuit for running lights. Brass hex back-up nut, brass washer. Chrome plated plastic knob.

Item#	Positions	Circuits	Rating	Panel Thickness	Case
11841	Off - On	1	6-36VDC - 10A @ 12VDC	5/8"	12
11901	Off - On	1	25A @ 6VDC - 1" 15A @ 12VDC		12
11911	Off - On - On Both #1, #2	2	25A @ 6VDC - 1" 15A @ 12VDC		12
11921	Off - On #1 - On #2	2	25A @ 6VDC - 1" 15A @ 12VDC		12

3-TO-1 HEAT SHRINK BUTT CONNECTOR

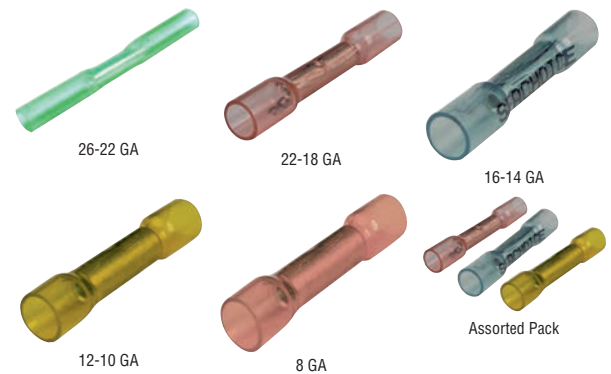

Marine grade heat shrinkable butt splices. 99.9% Pure copper with seamless tube, tin plated. Proprietary nylon/polyolefin 3:1 shrink ratio tubing with adhesive lining provides maximum clarity for wire inspection purposes, faster shrink times and improved abrasion resistance. Simply insert the wire, crimp and heat shrink for a complete environmental seal.

Item#	Wire Range	Color	Pack	Case
60171	26-22	Green	25	10
62761	26-22	Green	1000	1
62251	22-18	Red	3	10
60181	22-18	Red	25	10
61151	22-18	Red	100	1
62771	22-18	Red	500	1
62261	16-14	Blue	3	10
60191	16-14	Blue	25	10
61161	16-14	Blue	100	1
62781	16-14	Blue	500	1
62271	12-10	Yellow	3	10
60201	12-10	Yellow	25	10
61171	12-10	Yellow	100	1
62281	8	Red	2	10
60211	8	Red	25	10
Assorted Pack				
62291	22-18, 16-14, 12-10	Red, Blue, Yellow	10	5



STEP DOWN 3-TO-1 HEAT SHRINK BUTT CONNECTOR



Marine grade and designed for connecting different wire gauges. The gauge is marked on each end of the connector and also displays a corresponding color band. 99.9% Pure copper with seamless tube, tin plated. Proprietary nylon/polyolefin 3:1 shrink ratio tubing with adhesive lining provides maximum clarity for wire inspection purposes, faster shrink times and improved abrasion resistance. Simply insert the wire, crimp and heat shrink for a complete environmental seal.

Item#	Wire Range	Color	Pack	Case
61401	22-18 to 16-14	Blue	10	10
61431	22-18 to 16-14	Blue	100	10
61411	16-14 to 12-10	Yellow	10	10
61441	16-14 to 12-10	Yellow	100	10
61421	12-10 to 8	Red	10	10
61451	12-10 to 8	Red	100	10

VINYL INSULATED BUTT CONNECTOR



Voltage: 600
Max Temp: 75°C / 167°F

Item#	Wire Range	Color	Pack	Case
60601	22-16	Red	100	10
60781	22-16	Red	500	10
60611	16-14	Blue	100	10
60791	16-14	Blue	500	10
60621	12-10	Yellow	100	10

NYLON INSULATED BUTT CONNECTOR



Voltage: 600
Max Temp: 105°C / 189°F

Item#	Wire Range	Color	Pack	Case
67901	22-18	Red	7	10
67911	22-18	Red	25	10
67921	22-18	Red	100	10
67931	16-14	Blue	7	10
67941	16-14	Blue	25	10
67951	16-14	Blue	100	10
67961	16-14	Blue	500	10
67971	12-10	Yellow	7	10
67981	12-10	Yellow	25	10
67991	12-10	Yellow	100	10

3-TO-1 HEAT SHRINK RING TERMINAL



Marine grade heat shrinkable ring terminals. 99.9% Pure copper with brazed seam barrel, tin plated. Proprietary nylon/polyolefin 3:1 shrink ratio tubing with adhesive lining provides maximum clarity for wire inspection purposes, faster shrink times and improved abrasion resistance. Simply insert the wire, crimp and heat shrink for a complete environmental seal.

Item#	Wire Range	Stud	Color	Pack	Case
60141	22-18	#6	Red	25	10
62301	22-18	#8	Red	3	10
60151	22-18	#8	Red	25	10
62311	22-18	#10	Red	3	10
60161	22-18	#10	Red	25	10
63431	22-18	1/4"	Red	25	10
63441	22-18	5/16"	Red	25	10
63451	22-18	3/8"	Red	25	10
60091	16-14	#6	Blue	25	10
62321	16-14	#8	Blue	3	10
60101	16-14	#8	Blue	25	10
63821	16-14	#8	Blue	100	1
62331	16-14	#10	Blue	3	10
60111	16-14	#10	Blue	25	10
63811	16-14	#10	Blue	100	1
60121	16-14	1/4"	Blue	25	10
62341	16-14	5/16"	Blue	3	10
60081	16-14	5/16"	Blue	25	10
62351	16-14	3/8"	Blue	3	10
60131	16-14	3/8"	Blue	25	10
62361	12-10	#8	Yellow	3	10
60031	12-10	#8	Yellow	25	10
62371	12-10	#10	Yellow	3	10
60041	12-10	#10	Yellow	25	10
60051	12-10	1/4"	Yellow	25	10
62381	12-10	5/16"	Yellow	3	10
60061	12-10	5/16"	Yellow	25	10
62391	12-10	3/8"	Yellow	3	10
60071	12-10	3/8"	Yellow	25	10

VINYL INSULATED RING TERMINAL



Voltage: 600
Max Temp: 75°C / 167°F

Item#	Wire Range	Stud	Color	Pack	Case
60631	22-18	#10	Red	100	10
60641	16-14	#6	Blue	100	10
60651	16-14	#8	Blue	100	10
60661	16-14	#10	Blue	100	10
60671	16-14	1/4"	Blue	100	10
60681	16-14	5/16"	Blue	100	10
60691	16-14	3/8"	Blue	100	10
60701	12-10	#10	Yellow	100	10
60711	12-10	1/4"	Yellow	100	10
60721	12-10	5/16"	Yellow	100	10
60731	12-10	3/8"	Yellow	100	10
60741	12-10	1/2"	Yellow	100	10

NYLON INSULATED RING TERMINAL



22-18 GA

16-14 GA

12-10 GA



Voltage: 600
Max Temp: 105°C / 221°F

Item#	Wire Range	Stud	Color	Pack	Case
60801	22-18	#8	Red	6	20
60811	22-18	#8	Red	100	10
60821	22-18	#10	Red	6	20
60831	22-18	#10	Red	25	20
60841	16-14	#6	Blue	25	20
60851	16-14	#8	Blue	6	20
60861	16-14	#8	Blue	100	10
60871	16-14	#10	Blue	6	20
60881	16-14	#10	Blue	25	20
60891	16-14	#10	Blue	100	10
60901	16-14	1/4"	Blue	5	20
60911	16-14	1/4"	Blue	100	10
60921	16-14	5/16"	Blue	5	20
60931	16-14	5/16"	Blue	100	10
60941	16-14	3/8"	Blue	5	20
60951	16-14	3/8"	Blue	100	10
60961	12-10	#8	Yellow	5	20
60971	12-10	#8	Yellow	100	10
60981	12-10	#10	Yellow	5	20
60991	12-10	#10	Yellow	100	10
61001	12-10	1/4"	Yellow	4	20
61011	12-10	5/16"	Yellow	4	20
61021	12-10	5/16"	Yellow	100	10
61031	12-10	3/8"	Yellow	4	20
61041	12-10	3/8"	Yellow	100	10
61051	12-10	1/2"	Yellow	3	20
61061	8	#10	Red	2	20
61071	8	1/4"	Red	2	20
61081	8	5/16"	Red	2	20
67761	8	5/16"	Red	25	10
61091	8	3/8"	Red	2	20
67771	8	3/8"	Red	25	10
61101	8	1/2"	Red	1	20
61111	6	1/4"	Blue	1	20
61121	6	3/8"	Blue	1	20
61131	4	1/4"	Yellow	1	20

COOL SEAL® BUTT SPLICE

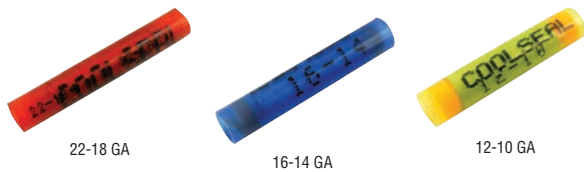

22-18 GA

16-14 GA

12-10 GA



Cool Seal is a heat-less, solderless terminal, it utilizes revolutionary anaerobic sealant technology that installs in a fraction of the time of comparable heat seal connectors. Simply strip the wire and crimp, activating the sealant, to create an environmentally sealed connection. The innovative new sealant prevents the ingress of moisture and air, the nylon insulation provides maximum abrasion and puncture resistance, while the seamless, 99.9% ETP, copper connector offers optimal electrical conductivity. Requiring no heat, the Cool Seal will reduce overall costs by eliminating the need for torches or heat guns, reducing the installation time, and improving productivity.

Item#	Wire Range	Color	Pack	Case
63501	22-18	Red	25	1
63511	16-14	Blue	25	1
63521	12-10	Yellow	25	1

BRAZED NON-INSULATED BUTT SPLICE



Marine grade, 99.9% pure copper, with a tin plated brazed seam tube.

Item#	Wire Range	Pack	Case
60221	#8 AWG	50	10
60231	#6 AWG	25	10
60241	#4 AWG	25	10
60251	#2 AWG	5	10

SEAMLESS BUTT SPLICE

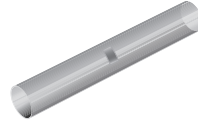

Marine grade, 99.9% pure copper. Tin plated for corrosion resistance.

Item#	Wire Range	Pack	Case
61571	22-18	25	10
61611	22-18	100	1
61601	22-18	1000	1
61581	16-14	25	10
61631	16-14	100	1
61621	16-14	1000	1
61591	12-10	25	10
61641	12-10	100	1

INSULATED HEAT SHRINK BULLET TERMINALS



22-18 Male

22-18 Female

16-14 Male

16-14 Female

Item#	Size	Wire Range	Connection	Color	Pack	Case
61701	.156" (Bullet)	22-18	Male	Red	25	10
61711	.180" (Bullet)	22-18	Male	Red	25	10
61721	.156" (Bullet)	22-18	Female	Red	25	10
61731	.180" (Bullet)	22-18	Female	Red	25	10
61741	.156" (Bullet)	16-14	Male	Blue	25	10
61751	.180" (Bullet)	16-14	Male	Blue	25	10
61761	.156" (Bullet)	16-14	Female	Blue	25	10
61771	.180" (Bullet)	16-14	Female	Blue	25	10

VINYL INSULATED QUICK DISCONNECT TERMINALS

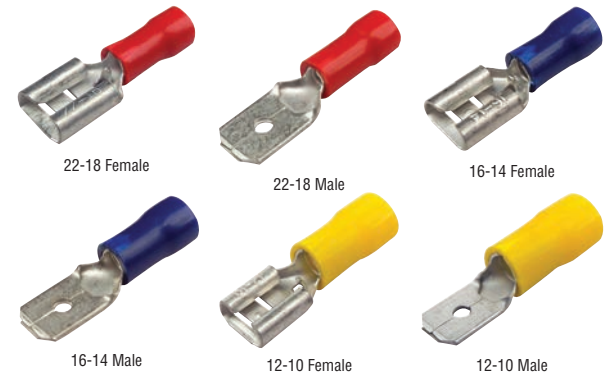

22-18 Female

22-18 Male

16-14 Female

16-14 Male

12-10 Female

12-10 Male

Item#	Wire Range	Connection	Color	Pack	Case
67801	22-18	Female	Red	100	10
67811	22-18	Male	Red	100	10
67821	16-14	Female	Blue	100	10
67831	16-14	Male	Blue	100	10
67841	12-10	Female	Yellow	100	10
67851	12-10	Male	Yellow	100	10



3-TO-1 HEAT SHRINK INSULATED DISCONNECT



Marine grade heat shrinkable quick disconnect terminals. 99.9% Pure copper with butted seam barrel, tin plated. Clear polyolefin 3:1 shrink ratio tubing with adhesive lining provides maximum clarity for wire inspection purposes. Simply insert the wire, crimp and heat shrink for a complete environmental seal.

Item#	Wire Range	Connection	Color	Pack	Case
60271	22-18	Female	Red	25	10
60281	22-18	Male	Red	25	10
60291	16-14	Female	Blue	25	10
60301	16-14	Male	Blue	25	10
60311	12-10	Female	Yellow	25	10
60321	12-10	Male	Yellow	25	10

3-TO-1 HEAT SHRINK TUBING WITH SEALANT

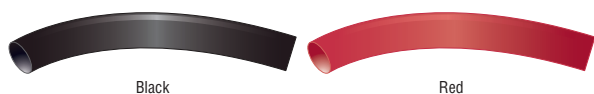

Marine grade, flexible polyolefin heat shrinkable tubing. 3:1 shrink ratio with adhesive liner. Flame retardant. Once installed, provides a complete environmental seal to prevent corrosion, enhance insulation and improve abrasion resistance. - 55°C to 110°C operating temp. **3" Lengths are Clam Packed. 1 1/2" Lengths are Poly Bagged.**

Item#	Size	Color	Pack	Case
62031	1/8" x 3"	Black	3	10
62041	3/16" x 3"	Black	3	10
62051	1/4" x 3"	Black	3	10
62061	3/8" x 3"	Black	3	5
62641	1/2" x 1 1/2"	Black	2	10
62071	1/2" x 3"	Black	3	5
62651	3/4" x 1 1/2"	Black	2	10
62211	3/4" x 3"	Black	3	5
62661	1" x 1 1/2"	Black	2	10
62101	1/8" x 3"	Red	3	5
62111	3/16" x 3"	Red	3	5
62121	1/4" x 3"	Red	3	5
62131	3/8" x 3"	Red	3	5
62671	1/2" x 1 1/2"	Red	2	10
62141	1/2" x 3"	Red	3	5
62681	3/4" x 1 1/2"	Red	2	10
62691	1" x 1 1/2"	Red	2	10

3-TO-1 HEAT SHRINK TUBING WITH SEALANT ASSORTMENT PACKS

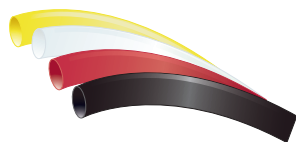

Marine grade, flexible polyolefin heat shrinkable tubing. 3:1 shrink ratio with adhesive liner. Flame retardant. Once installed, provides a complete environmental seal to prevent corrosion, enhance insulation and improve abrasion resistance. - 55°C to 110°C operating temperature.

62201: Assorted Sizes

62191 & 62221: Assorted Colors

Item#	Size	Color	Pack	Case
62201	1/8", 3/16", 1/4", 3/8", 1/2" (x 3")	Black	5	5
62191	3/8" x 3"	(1) Blk, Red & Wht. (2) Yel	5	5
62221	3/4" x 3"	(1) Blk, Red, Wht & Yel	4	5

3-TO-1 HEAT SHRINK TUBING WITH SEALANT - 48"

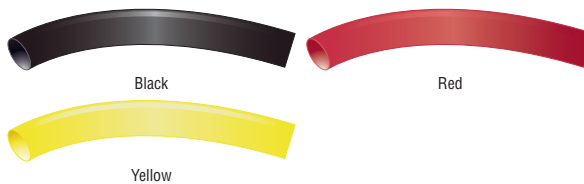

Marine grade, flexible polyolefin heat shrinkable tubing. 3:1 shrink ratio with adhesive liner. Flame retardant. Once installed, provides a complete environmental seal to prevent corrosion, enhance insulation and improve abrasion resistance. - 55°C to 110°C operating temperature.

Item#	Size	Color	Case
60441	3/16" x 48"	Black	5
60451	1/4" x 48"	Black	5
62611	3/8" x 48"	Black	5
60461	1/2" x 48"	Black	5
60471	3/4" x 48"	Black	5
60481	1" x 48"	Black	5
60341	3/16" x 48"	Red	5
60351	1/4" x 48"	Red	5
62601	3/8" x 48"	Red	5
60361	1/2" x 48"	Red	5
60371	3/4" x 48"	Red	5
60331	1" x 48"	Red	5
61501	3/16" x 48"	Yellow	5
61511	1/4" x 48"	Yellow	5
61521	1/2" x 48"	Yellow	5
61531	3/4" x 48"	Yellow	5
61541	1" x 48"	Yellow	5

HEAT SHRINK VINYL SLEEVES



Vinyl heat shrinkable tubing. 2:1 Shrink ratio. Provides additional insulation and abrasion resistance.

Item#	Size	Color	Pack	Case
60381	3/16" x 6"	Black	7	10
60391	1/4" x 6"	Black	7	10
60401	3/8" x 6"	Black	5	10
60411	1/2" x 6"	Black	4	10
60421	3/4" x 6"	Black	3	10

TINNED COPPER BATTERY CABLE TERMINALS



Marine grade, 99.9% pure copper, tin plated battery lugs. Seamless pad provides ultimate performance in strength, conductivity and corrosion resistance. UL Listed / CSA Certified.



Item#	Cable Size	Fastener	Pack	Case
62561	8	1/4"	2	10
63891	8	1/4"	25	1
62551	8	5/16"	2	10
63851	8	5/16"	25	1
62541	8	3/8"	2	10
63861	8	3/8"	25	1
62531	6	1/4"	2	10
63901	6	1/4"	25	1
62521	6	5/16"	2	10
63871	6	5/16"	25	1
62511	6	3/8"	2	10
60591	6	3/8"	25	1
62501	4	1/4"	2	10
63911	4	1/4"	25	1
62491	4	5/16"	2	10
60581	4	5/16"	25	1
62481	4	3/8"	2	10
60571	4	3/8"	25	1
63921	2	1/4"	25	1
62471	2	5/16"	2	10
60561	2	5/16"	25	1
62461	2	3/8"	2	10
60551	2	3/8"	25	1
63931	1	1/4"	25	1
62451	1	5/16"	2	10
63941	1	5/16"	25	1
62441	1	3/8"	2	10
60541	1	3/8"	25	1

Continued...

Item#	Cable Size	Fastener	Pack	Case
63951	1/0	1/4"	25	1
62431	1/0	5/16"	2	10
63881	1/0	5/16"	25	1
62421	1/0	3/8"	2	10
60531	1/0	3/8"	25	1
63961	2/0	1/4"	25	1
62411	2/0	5/16"	2	10
60491	2/0	5/16"	25	1
62401	2/0	3/8"	2	10
60521	2/0	3/8"	25	1
63971	3/0	1/4"	25	1
63981	3/0	5/16"	25	1
60511	3/0	3/8"	25	1
63991	4/0	1/4"	25	1
63401*	4/0	5/16"	25	1
64001	4/0	3/8"	25	1
60501	4/0	3/8"	25	1

64 PIECE HEAVY DUTY BATTERY TERMINAL KIT WITH TOOLS



21 Compartment box: 18 1/2" W x 3" H x 13 1/8" D.

Tools Included:

- Professional Hammer Crimp Tool
- Professional Heavy Duty Butane Torch (w/o fuel)
- Rotary Cable Stripper

Qty.	Item #	Description	Specs
1	61241	Hammer Crimp Tool	6 GA. - 4/0, Range
1	61271	Pro Torch	Brass
1	61261	Cable Stripper	8 GA. - 4/0, Range
2	62641	Heat Shrink Sleeve	1/2" x 1 1/2", BLK
2	62651	Heat Shrink Sleeve	3/4" x 1 1/2", BLK
2	62661	Heat Shrink Sleeve	1" x 1 1/2", BLK
2	62671	Heat Shrink Sleeve	1/2" x 1 1/2", RD
2	62681	Heat Shrink Sleeve	3/4" x 1 1/2", RD
2	62691	Heat Shrink Sleeve	1" x 1 1/2", RD
2	60501	Tinned Batt. Term.	4/0, 3/8" stud
3	60511	Tinned Batt. Term.	3/0, 3/8" stud
4	60521	Tinned Batt. Term.	2/0, 3/8" stud
4	60531	Tinned Batt. Term.	1/0, 3/8" stud
5	60541	Tinned Batt. Term.	1 GA., 3/8" stud
5	60551	Tinned Batt. Term.	2 GA., 3/8" stud
5	60561	Tinned Batt. Term.	2 GA., 5/16" stud
6	60571	Tinned Batt. Term.	4 GA., 3/8" stud
6	60581	Tinned Batt. Term.	4 GA., 5/16" stud
6	60591	Tinned Batt. Term.	6 GA., 3/8" stud
1	62701	Lead Marine Term.	3/16" Nut, Neg.
1	62711	Lead Marine Term.	3/8" Nut, Pos.
1	62721	Lead Emer. Post Top	6 GA. - 2/0, BLK
1	62731	Lead Emer. Post Top	7 GA. - 2/0, RD

Item#	Case
61322	1

78 PIECE HEAT SHRINK TERMINAL KIT WITH TOOLS



13 Compartment box: 13 1/8" W x 2 1/4" H x 8 3/8" D.

Tools Included:

- Ratcheting Crimp Tool
- Ultra Shrink Jet Flameless Butane Heat Tool w/o fuel
- 7 In 1 Wire Stripper And Cutting Tool

Qty.	Item #	Description	Specs
1	61221	Crimp Tool	22-10 GA. Range
1	61231	Heat Tool	Flameless
1	61281	7 in 1 Tool	18-10
5	60201	Butt Splice	12-10, YL
10	60191	Butt Splice	16-14, BL
10	60181	Butt Splice	22-18, RD
10	60151	Ring Term.	22-18, RD, #8 stud
10	60161	Ring Term.	22-18, RD, #10 stud
10	60101	Ring Term.	16-14, BL, #8 stud
10	60111	Ring Term.	16-14, BL, #10 stud
5	60041	Ring Term.	12-10, YL, #10 stud
5	60051	Ring Term.	12-10, YL, 1/4" stud
5	60071	Ring Term.	12-10, YL, 3/8" stud

Item#	Case
61302	1

92 PIECE HEAT SHRINK TERMINAL KIT WITH TOOLS



13 Compartment box: 10 13/16" W x 1 3/4" H x 6 1/2" D.

Tools Included:

- Multi-Purpose Crimping Tool
- Turbo Lite II Mini Torch (w/o fuel)

Qty.	Item #	Description	Specs
1	61211	Crimping Tool	Multi-Purpose
1	61201	Mini Torch	-
5	60201	Butt Splice	12-10, YL
10	60191	Butt Splice	16-14, BL
10	60181	Butt Splice	22-18, RD
10	60151	Ring Term.	22-18, RD, #8 stud
10	60161	Ring Term.	22-18, RD, #10 stud
10	60101	Ring Term.	16-14, BL, #8 stud
10	60111	Ring Term.	16-14, BL, #10 stud
5	60041	Ring Term.	12-10, YL, #10 stud
5	60051	Ring Term.	12-10, YL, 1/4" stud
5	60071	Ring Term.	12-10, YL, 3/8" stud
5	60291	Insul. Disc.	16-14, BL, Female
5	60301	Insul. Disc.	16-14, BL, Male

Item#	Case
61312	1

120 PIECE CLEAR SEAL HEAT SHRINK TERMINAL KIT



18 Compartment box: 10 3/4" W x 1 1/8" H x 6 3/4" D.

Qty.	Item #	Description	Specs
10	60181	Butt Conn.	22-18, RD
10	60191	Butt Conn.	16-14, BL
5	60201	Butt Conn.	12-10, YL
10	60151	Ring Term.	22-18, RD, #8 stud
10	60161	Ring Term.	22-18, RD, #10 stud
10	60101	Ring Term.	16-14, BL, #8 stud
10	60111	Ring Term.	16-14, BL, #10 stud
10	60041	Ring Term.	12-10, YL, #10 stud
5	60051	Ring Term.	12-10, YL, 1/4" stud
5	60071	Ring Term.	12-10, YL, 3/8" stud
10	60271	Insul. Disc.	22-18, RD, Female
10	60291	Insul. Disc.	16-14, BL, Female
5	60311	Insul. Disc.	12-10, YL, Female
5	60281	Insul. Disc.	22-18, RD, Male
5	60301	Insul. Disc.	16-14, BL, Male
5	60321	Insul. Disc.	12-10, YL, Male

Item#	Case
60001	1

WATERPROOF WIRING KIT WITH ZIP-CASE & TOOLS



The Waterproof Wiring Kit is a convenient zippered soft-sided 9 compartment carrying case featuring the most popular assortment of heat shrink wiring terminals.

Turbo Lite II Mini Torch ships without fuel.

Qty.	Item #	Description	Specs
1	61221	Crimp Tool	22-10 Range
1	61281	7 in 1 Tool	18-10 Range
1	61201	Mini Torch	-
20	62251	Butt Splice	22-18, RD
20	62261	Butt Splice	16-14, BL
15	62271	Butt Splice	12-10, YL
20	62311	Ring Term.	22-18, RD, #10 stud
20	-	Ring Term.	16-14, BL, 1/4" stud
15	-	Ring Term.	12-10, YL, 1/4" stud

Item#	Case
61332	1



3-TO-1 HEAT SHRINK DISPLAY



Contains popular sizes of Heat Shrink - Butt Connectors, Ring Terminals and Tubing. Wire frame display includes: (1) Small Seachoice Sign, (2) Header Sign Clips, (24) 6" Plastic Wire Hooks and (24) Reorder Tags

62191: Contains (1) WH, BK, RD (2) YL Tubes
62221: Contains (1) YL, WH, BK, RD Tubes
62291: Contains (3) 22-18, (4) 16-14, (3) 12-10 GA Splices

Packs/Kit	Item #	Description	Specs
10	62031	Tubing w/sealant	1/8" x 3", BK
10	62041	Tubing w/sealant	3/16" x 3", BK
10	62051	Tubing w/sealant	1/4" x 3", BK
5	62061	Tubing w/sealant	5/8" x 3", BK
5	62071	Tubing w/sealant	1/2" x 3", BK
5	62191	Tubing w/sealant	3/8" x 3", Mixed Colors
5	62211	Tubing w/sealant	3/4" x 3", BK
4	62221	Tubing w/sealant	3/4" x 3", Mixed Colors
10	62251	Butt Splice	22-18
10	62261	Butt Splice	16-14
10	62271	Butt Splice	12-10
5	62291	Butt Splice	Mixed Gauges
10	62301	Ring Term.	22-18, #8 Stud
10	62311	Ring Term.	22-18, #10 Stud
10	62321	Ring Term.	16-14, #8 Stud
10	62331	Ring Term.	16-14, #10 Stud
10	62341	Ring Term.	16-14, 5/16" Stud
10	62351	Ring Term.	16-14, 3/8" Stud
10	62361	Ring Term.	12-10, #8 Stud
10	62371	Ring Term.	12-10, #10 Stud
10	62381	Ring Term.	12-10, 5/16" Stud
10	62391	Ring Term.	12-10, 3/8" Stud
2	61211	Crimping Tool	22-10, Multi-purp.
4	61201	Mini Torch	-

Item# **62002** Case 1

MULTI-PURPOSE CRIMP TOOL



- Features Include:**
- Comfort grips
 - Wire cutters
 - Spring loaded action for multiple crimps
 - Safety lock mechanism
 - Constructed with heavy duty steel
 - Color coded crimp nest for insulated terminals
 - Crimp nest for uninsulated terminals
 - 26 - 8 AWG Wire stripper/wire gauge
 - Cuts and re-threads 4-40, 6-32, 8-32 10-24 and 10-32 machine screws
 - Holes for wire bending and wire positioning
 - Weighs only 7 oz.

Item# **61211** Case 1

RATCHETING CRIMP TOOL



- Features Include:**
- UL listed & CSA certified for use with Crimp 'N Seal® heat shrink terminals 22-10 AWG
 - Precision dies are color-coded to industry standards for an accurate crimp each time
 - Ratchet mechanism ensures a proper crimp each time by not releasing until cycle is complete
 - Compound action delivers maximum crimp force with minimal effort
 - Cushion grip handles ease strain on hands

Item# **61221** Case 1

PROFESSIONAL HAMMER CRIMP TOOL



A convenient and durable tool for crimping lugs and terminals from 6 - 4/0 GA. Made of high strength steel, the hammer crimp tool features a V-shaped nest for a solid crimp each time with a simple swing of a hammer. The Terminal & Lug Size Guide lets you know the crimp is complete.

Item# **61241** Case 1

BENCH MOUNT HEAVY DUTY CRIMP TOOL



Can be securely and safely attached to any solid surface. Perfect for higher volume applications or repair shop work-stations.

- Provides added leverage for larger size cable
- Mounted tool helps prevent loss, damage, and theft of tool
- Length: 20"; Weight: 7.8 Lbs.

Item# **61291** Wire Range 6 GA. - 4/0 Case 1

HEAVY DUTY CRIMPING TOOL



- Features Include:**
- 6 GA. - 250 MCM Range, accommodates popular sizes
 - Diamond-shaped crimp completely compresses cable to form solid mass assuring low resistance connection
 - Compound action exerts five tons of force for complete crimps
 - Built-in dies, so there's no detached dies to purchase or lose
 - Rotating dies quickly adjust setting to accommodate various terminals and lugs
 - Comfortable grip improves your grip and eases hand fatigue
 - Length 25" Weight 5.9 Lbs. Color - Red & Black

Item# **61251** Case 1

7-in-1 WIRE STRIPPER AND CUTTING TOOL



- Features Include:**
- Strips 18-10 AWG Wire, stamped wire strip gauge enables consistent wire stripping every time
 - Precision Wire Cutting Tool, precision ground to cut small conductors
 - Steel Wire Cutting Tool, center hole for cutting fine steel wire
 - Crimps 18-14 AWG Insulated Terminals, completes the cut-strip-crimp process
 - Plier Nose, flat plier nose allows you to punch and twist knock outs
 - Wire Loop Slots, built in looping holes allows for convenient bending of eye loops into solid conductors
 - Stamped markings help to easily convert measurements
 - Cushion Grip Handles eases pressure on hands
 - "Open" Spring keeps tool in open position making wire insertion simpler

Item# **61281** Case 1

ROTARY CABLE STRIPPING TOOL



Features Include:

- 8 AWG – 4/0 Wire range
- Adjustable blade height adjust depth to match insulation thickness of cable

Item#
61261

Case
1

PROFESSIONAL HEAVY DUTY BUTANE POWER TORCH



This durable tool provides a dependable and powerful heat source for almost any application where a controlled flame is required. No shop should be without it.

Features Include:

- Brass and Steel Construction, no tool is tougher
- Dual Gas and Air Flame Controls adjust temperature and flame precision to fit your application
- 2500° F Torch output, one tool for every job
- Unique safety lock prevents accidents
- Removable Base for safe hands-free operation in both the vertical and horizontal position
- Tool ships with no fuel

Item#
61271

Size
3.9" L x 1.4" W x 5.4" H

Color
Black

Case
1

TURBO LITE II MINI TORCH



Provides a 2400°F pinpoint blue flame that easily handles applications such as heat shrink terminals and heat shrink tubing.

Features Include:

- Piezo waterproof /windproof ignition system-wet and windy environments are no problem
- Convenient twist flame adjustment-set the flame the way you want it
- Refillable translucent fuel tank takes the guess work out of when to refill
- Includes key ring
- Tool ships with no fuel

Item#
61201

Size
2.8" H x 0.8" W

Color
Charcoal

Case
1

ULTRA SHRINK JET - FLAMELESS BUTANE HEAT TOOL



The high output flameless heat gun designed for industrial applications where versatility and power are a must. The flameless tool is safe to use in environments where vapors may be present or flames are prohibited. Included deflector attachment evenly distributes heat

making heat shrink tubing installation faster. Leave the extension cords behind with this portable ergonomic heat tool.

Features Include:

- Automatic Piezo ignition system
- Deflector & stand attachments circulates heat evenly and provides safe hands-free option
- 1400° F Hot output the best tool for heavy duty flameless applications
- Tool ships with no fuel

Item#
61231

Size
7 1/2"

Color
Blue (Handle)

Case
1

ELECTRONICS ACCESSORIES

WATERPROOF DUAL-PORT USB CHARGER - PANEL MOUNT



Dual-port USB design allows user to charge two devices at the same time.

- Input Voltage: 12V DC
- Output Voltage: 5V/3A
- Port A: single 2.1A Fast Charger USB port
- Port B: single 1.0A Fast Charger USB port
- Compatible with any pad, MP3, GPS, or phone that charges from a USB port
- Applications: motorcycle, ATV, UTV, rigid inflatable boat, golf cart
- 70" Power cord
- Waterproof IP66 rated
- CE / FCC / RoHS certificated

Item#
20001

Case
6

MP3 ADAPTER - PANEL MOUNT



- Connect your MP3 Player, iPod® or satellite radio to your stereo
- Standard 3.5 mm jack and 4' extension-cable w/ RCA plugs
- Dashboard / Panel Mount with Waterproof Cover
- 4' - 3.5 mm Patch Cord included
- Easily installed in a 3/4" hole
- Can be installed on panels up to 1.25" thick
- Can be used as remote headphone jack

Item#
20011

Case
6

USB / AUX ACCESSORY EXTENSION CABLE



Provides easy access to your accessory inputs utilizing USB port or 3.5 mm jack. It features a waterproof panel / dash mount with rubber cover and 6.5' cable. Easily installed in 1 3/8" hole. Can be installed on panels up to 1" thick.

Item#
20021

Case
6

STEREO SPLASH COVER - PANEL MOUNT



The gasket-sealed lid on this splash cover prevents water entry into virtually any marine or spa stereo on the market. Accommodates any dual post, removable and DIN-style stereo. Contemporary styling makes it an attractive addition to the dashboard or wall. The lid lifts easily and stays open in multiple positions to maintain partial splash protection while allowing access to radio controls. Stainless steel mounting hardware (included) for corrosion protection.

Item#
20031

Case
6

UNDERDASH / OVERHEAD STEREO MOUNT



Designed to accommodate today's larger front panel format Marine stereos as well as older DIN style and Post mount. Made from heavy wall ABS plastic and has room for all the accessory cables found on the newest stereos. Accepts Poly Planar, Sony, Jensen, Marine AV and even Clarion CMD4. Stereo shown (not included).

Item#
20041

Size
10.450" D x 11.860" W x 4.323" H

Case
4



New HIGH-DEFINITION OMNIDIRECTIONAL TV MARINE ANTENNA



Round omnidirectional HDTV antenna with gain control amplifier for better reception while offshore and crystal clear TV viewing. Includes a 50' high grade marine cable. Frequency Range: VHF 47-230MHz / UHF 470-862MHz.

Item# 19740	Dia. 14"	Case 10
-----------------------	--------------------	-------------------

VHF EXTERNAL SPEAKER



White, water-resistant, cycolac case 5W speaker is compatible with all VHF radios. 4 ohms. Comes equipped with 9.5' cable, plug, stainless steel mounting bracket and hardware.

Item# 19751	Rating 5W	Size 5" x 5"	Case 10
-----------------------	---------------------	------------------------	-------------------

STAINLESS STEEL MICROPHONE CLIP



One-piece construction. 1" x 1 1/16". Features an integral spring pressure finger to hold the microphone in place. Fits all standard microphones on hailers, CBs and VHF radios.

Item# 19921	Material Stainless Steel	Case 12
-----------------------	------------------------------------	-------------------

NYLON MICROPHONE CLIP



One piece molded. No more rust or scratches. 1 1/8" x 1 1/8". Fits all standard microphones on hailers, CBs and VHF radios. Complete with stainless mounting screws. One per card.

Item# 19991	Material Black Nylon	Case 12
-----------------------	--------------------------------	-------------------

New VHF ANTENNAS

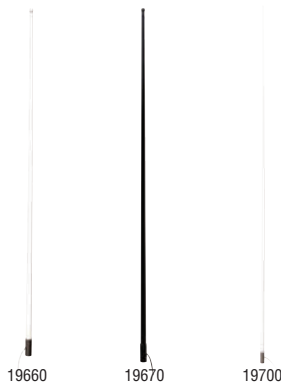

- Gain: 6 dB performance
- Frequency Range: 156-162 MHz
- Max Power 75 Watts
- 50 Ohms
- SWR: 1.4:1 AVG
- 6MHz Bandwidth

Internal brass tube radiator provides optimal signal performance. Includes: 15' dual-shield ultra-flexible L-195 low loss coaxial cable, ferrule, smooth white fiberglass radome and ProConnect (factory installed FME connector with a PL-259 adapter that eliminates large holes and crimping of connectors). Omnidirectional. Vertical Signal Polarization. DC Grounded. AIS band capable.

Item#	Length	Color	Ferrule	Pack	Case
19660	5'	White	316 SS	1	10
19670	5'	Black	316 SS	1	10
19680	5'	White	Nylon	1	10
19700	8'	White	316 SS	1	10
19702	8'	White	316 SS	25	1
19710	8'	White	Nylon	1	10

New DUAL BAND VHF & AM/FM ANTENNA



Includes: Two 15' L-195 cables, ferrule, smooth white gel coated fiberglass radome. Cable connectors come with ProConnect & Motorola type terminations for your VHF and AM/FM radio. ProConnect features factory installed FME connector with a PL-259 adapter. Eliminates large holes and crimping of connectors. No power supply required! Omnidirectional. Vertical Signal Polarization. DC Grounded. AIS band capable.

- 6 dB gain
- Max Power 75 Watts
- 50 Ohms
- SWR: 1.4:1 AVG
- 6MHz Bandwidth

Item#	Length	Color	Ferrule	Case
19720	5'	White	316 SS	15
19730	8'	White	316 SS	15

New VHF STAINLESS STEEL WHIP ANTENNAS



Internal brass tube radiator provides optimal signal performance. Includes: 15' of high grade marine L-195 cable featuring ProConnect. ProConnect features factory installed FME connector with a PL-259 adapter. Eliminates large holes and crimping of connectors. Omnidirectional. Machined stainless steel.

19610: Mounts with a 1" - 14 mounting adapter (included).
19640: Mounts with an "L" masthead bracket (included).

- Gain: 6 dB performance
- Frequency Range: 156-162 MHz
- Max Power 75 Watts
- 50 Ohms
- SWR: 1.4:1 AVG
- 6MHz Bandwidth

Item#	Length	Ferrule	Color	Case
19610	41.5"	316 SS	Stainless Steel	10
19640	40.5"	316 SS	Stainless Steel	10

NYLON ANTENNA RATCHET MOUNT



Hi-Impact super tough nylon. Weather resistant. Accepts all antennas with 1" - 14 threads. Comes with stainless steel hardware. Positive lockdown ratchet handle. Center to center 1 1/16" x 2 1/16".

Item#	Material	Pkg.	Case
19500	High Impact White Nylon	Bulk	12
19501	High Impact White Nylon	Card	12

ANTENNA RATCHET MOUNT

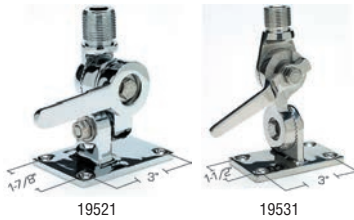

Four-way ratchet design available in either chrome plated cast polished brass or stainless steel. For mounting to deck or bulkhead. Has 3/32" access hole for cable. Standard 1" - 14 male thread.

19521: Base: 2 5/8" x 3 5/8". Center to center: 1 1/8" x 3"
19531: Base: 2 1/4" x 3 3/4". Center to center: 1 1/2" x 3"

Item#	Material	Case
19521	Chrome Plated Brass	12
19531	Stainless Steel	12

ANTENNA, ROD AND TOOL HOLDER

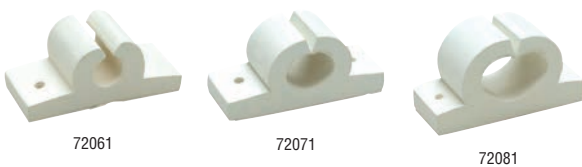

White rubber, flexible fishing rod and tool holder. Larger size will accommodate boat hooks and boarding ladders.

Item#	Size	Pack	Case
72061	3/8"	2 (Pr.)	12
72071	5/8"	2 (Pr.)	12
72081	1"	1 pr.	12

NYLON ANTENNA RAIL MOUNT



Fits rail tubing 7/8" or 1" and standard 1"-14 threaded antenna ferrules.

Item#	Material	Case
19561	White Nylon	10

STAINLESS STEEL ANTENNA RAIL MOUNT



Mount fits both 7/8" and 1" rails and standard 1"-14 threaded antenna ferrules.

Item#	Material	Case
19541	316 cast stainless steel	10

STAINLESS STEEL ANTENNA BASE



Fits antennas with standard 1"-14 threads. Ideal for TV, Loran, GPS and VHF antennas.

Item#	Size	Case
19581	4" Mounting Base	12

PLASTIC WIRE COVER



Gives boat that finished look. Covers unsightly wire pass-thru holes. Made of durable black plastic that will not corrode. Covers holes up to 1 1/4" in diameter.

Item#	Hole	Pack	Case
16251	Up to 1 1/4"	1 pr.	12

CABLE THRU HULL FITTING



Watertight thru hull fitting. Self attaching. No additional hardware required. Accepts single or double cable. 2" maximum hull.

Item#	Description	Color	Hole	Case
17921	1/4" Slot, 1 1/4" Flange	White	3/4"	12
17991	3/32" Slot, 1 1/2" Flange	White	1"	12
17901	1/4" Slot, 1 1/4" Flange	Black	3/4"	12
17971	3/32" Slot, 1 1/2" Flange	Black	1"	12

MOLDED CLAM SHELL



UV and weather resistant and great for routing cables, wire, etc.

Item#	Size	Color	Pack	Case
16161	1 1/16" x 1 11/16"	White	1 pr.	12
16171	2" x 2 3/8"	White	1 pr.	12
16181	1 7/16" x 1 11/16"	Black	1 pr.	12
16191	2" x 2 3/8"	Black	1 pr.	12

VENTILATOR



Great for routing cables.

Item#	Size	Screws	Case
Polished Stainless Steel			
16141	1 21/32" x 1 3/4" x 7/16"	#6	12
16151	2 7/32" x 2 1/8" x 1 5/32"	#6	12
16231	3 3/4" x 3 3/4" x 1 7/8"	#6	12
Chrome Plated Brass			
16101	1 9/16" x 1 1/2" x 1 5/32"	#4	12
16131	2" x 2 3/32" x 1 9/32"	#6	12
16201	3 3/4" x 3 3/4" x 1 7/8"	#6	12

CABLE OUTLET



Watertight chrome plated brass. Threaded cap and rubber gasket. For complete waterproofing of cable. Use #6 screws.

Item#	Size	Base	Case
10011	Outlet: 1/4"	1 1/4" dia.	12
10021	Outlet: 5/16"	1 1/4" dia.	12
10031	Outlet: 3/8"	1 1/2" dia.	12



New ANTENNA CONNECTORS

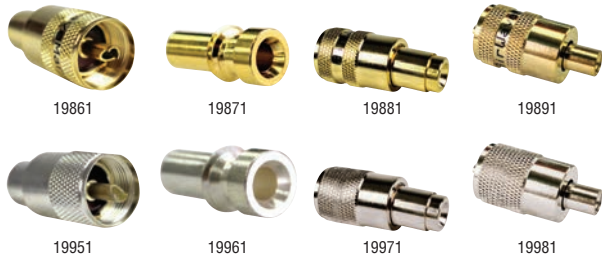

Gold Plated: Best for anti-corrosion and contact.
Silver Plated: Fights corrosion and increases contact quality.

Item#	Description	Fits	Case
Gold Plated			
19861	PL-259 (UHF)	RG-8	12
19871	UG-175 Reducer	RG-58/L-195	12
19881	PL-259 w/ UG-175	RG-58	12
19891	PL-258 (UHF)	RG-58	12
Silver Plated			
19951	PL-259 (UHF)	RG-8	12
19961	UG-175 Reducer	RG-58/L-195	12
19971	PL-259 w/ UG-175	RG-58	12
19981	PL-258 (UHF)	RG-58	12

New COAX CABLE WITH FME



Coaxial cable extension for VHF antennas fitted with ProConnect FME Connectors. Marine grade and highly durable L-195 cable type. ProConnect features factory installed FME connector with a PL-259 adapter. Eliminates large holes and crimping of connectors. 50 Ohms.

Item#	Description	Length	Case
19791	White	10'	25
19801	White	20'	25

COAXIAL ANTENNA CABLE ASSEMBLY



RG58U white coaxial cable with PL259 fittings on both ends. Lengths to fit most applications.

Item#	Size	Case
19781	5' Cable w/ Fittings	12
19761	10' Cable w/ Fittings	12
19771	20' Cable w/ Fittings	12

VHF ANTENNA CONNECTORS



Chrome Plated Brass

VHF CONNECTOR WITH ADAPTER
19811: PL259 (19821) with UG175 (19831) cable adapter; Use with RG58U cable.

COAXIAL CABLE PLUG - PL259
19821: Use with RG58U or 8X cable. Takes adapter plug UG175 (19831) or UG176 (19841).

COAXIAL CABLE ADAPTERS Both fit cable plug 19821 (PL259).
19831: Use with RG58U cable - UG175.
19841: Use with RG59U cable - UG176.

DOUBLE FEMALE CONNECTOR - PL258
19851: Attaches to PL259 (19821) cable plug.

Item#	Model #	Description	Case
19811	PL259 & UG175	Connector w/ Adapter	12
19821	PL259	VHF Male Connector	12
19831	UG175	Adapter for RG58U Cable	12
19841	UG176	Adapter for RG59U Cable	12
19851	PL258	Double Connector	12

PLUMBING

HANDY BILGE PUMP



- Self-Priming and easy to clean
- Made of rust and corrosion resistant plastic
- Packed in poly bag with rigid header card

Item#	GPM	Size	Case
19151	8	24" L x 1 1/2" Dia.	5

BILGE PUMP SWITCH



Ideal for bilge pump applications
 3 Position: On - Off - Mom
 On 3 Blade type terminals.
 Single pole. Water resistant plastic housing.

Item#	Description	Volts	Amps	Size	Case
19371	Switch w/bilge pump faceplate	12	20	Stem: 1/16" L Diameter: 15/32"	12
19381	Rocker switch	12	15	1" x 1 1/16" Cut-out size: 27/32" x 1 29/64"	12

BILGE PUMP CONTROL SWITCH



Lighted stainless steel 3-way bilge pump switch. When using the Momentary-On switch, bilge pump can be operated bypassing the automatic float switch - switch automatically returns to "OFF" when released. Can be used with any 12V bilge pump. Screws are also included.

Item#	Fuse	Size	Case
19391	2.5A	3 1/2" L x 2" W	12

BILGE PUMP INSTALLATION KIT



19441: Includes thru hull model 18051
19451: Includes thru hull model 18091
Kit Contains:
 • 6' corrugated hose
 • (2) #10 stainless steel hose clamps
 • White thru-hull

Item#	Description	Max Hull Thickness	Case
19441	3/4" Black	3/4"	6
19451	1 1/8" Black	1 1/8"	6

MINI BILGE PUMP



Ideal for pumping water out of small areas such as small boats, jet boats or PWC's. Constructed of white ABS plastic with an easy to clean twist off strainer. 3" W x 4" H.



Item#	GPH	Ports	Volts	Amps	Fuse	Case
19261	450	3/4"	12	1.5	3A	12

BILGE PUMP



CE Certified. ISO 8846 Marine (Ignition Protection) & ISO 8849 Marine (Bilge Pump Standard). Meets NMMA Certification Requirements.



Rugged white ABS plastic construction. 304 stainless steel fasteners. 600 and 1000 packed in double blisters. 1500 and 2000 packed in printed box. Not recommended for commercial use.

Item#	GPH	Ports	Volts	Amps	Fuse	Case
19271	600	3/4"	12	3.5	5A	12
19281	1000	1 1/8"	12	5.5	7A	12
19291	1500	1 1/8"	12	8.0	10A	12
19301	2000	1 1/8"	12	12.0	15A	12

UNIVERSAL SERIES BILGE PUMP



Meets ABYC and USCG Standards

- Submersible
- Marine grade tinned wires
- 4 3/8" H
- Snaps directly into many other strainer bases
- Bilge pump snaps into Rule bases. Strainer base connects to most Atwood, Mayfair, West Marine and Johnson bases
- Two year warranty

Item#	GPH	Ports	Volts	Amps	Fuse	Case
19211	600	3/4"	12	3	4A	12
19221	800	3/4"	12	3.8	4A	12
19231	1100	1 1/8"	12	4.1	6A	12

AUTOMATIC BILGE PUMP



Meets ABYC and USCG Standards

- Removable housing for easy cleaning.
- Fully submersible
- Anti-airlock protection
- Ignition protected
- Marine-grade wiring
- Two Year Limited Warranty

Item#	GPH	Hose	Volts	Amps	Fuse	Case
19341	600	3/4"	12	2A	5	12
19351	1100	1 1/8"	12	4A	5	12

SUBMERSIBLE BILGE PUMP - 3700 GPH



Meets ABYC and USCG Standards

- Removable housing for easy cleaning.
- Fully submersible
- Anti-airlock protection
- Ignition protected
- Marine-grade wiring
- Two Year Limited Warranty

Item#	GPH	Ports	Volts	Amps	Fuse	Case
19321	3700	1 1/2"	12	15	20A	8

SUBMERSIBLE BILGE PUMP



19241



19251



This salt water tough easy to clean pump has a water cooled motor and conforms to ISO8849. CE Rated. Lip Seal Construction. 30" of 16 Ga, Tinned Wire.

19251: Also replaces Johnson 28552
19021: Also replaces Johnson 28572

Item#	GPH	Hose	Volts	Amps	Fuse	Case
19241	500	3/4"	12	2.5	5A	12
19011	750	3/4"	12	3	5A	12
Replacement Cartridges						
19251	500	-	12	2.5	5A	12
19021	750	-	12	3	5A	12

AUTOMATIC BILGE PUMP SWITCH



- Electro-Magnetic
- Non-clogging switch
- False start protection
- Universal mounting bracket
- 6' long tin coated 16 gauge wire leads
- Switch turns pump on at 2 1/4" of water, off at 3/4"
- Fully warranted for 36 months
- 100% Factory Tested
- NMMA, ABYC and Coast Guard certified



Item#	Volts	Amps	Case
19421	12	15	12

BILGE PUMP AND FLOAT SWITCH



This salt water tough easy to clean pump has a water cooled motor and conforms to ISO8849. Rolling ball mechanism activates your bilge pump. Prewired for automatic operation with manual override. CE Rated. Lip Seal Construction. 30" of 16 Ga, Tinned Wire.

19251: Also replaces Johnson 28552
19021: Also replaces Johnson 28572



Item#	GPH	Hose	Volts	Amps	Fuse	Case
19201	500	3/4"	12	2.5	5A	12
19001	750	3/4"	12	3	5A	12
Repl. Parts	GPH	Hose	Volts	Amps	Fuse	Case
19251	500	-	12	2.5	5A	12
19021	750	-	12	3	5A	12

UNIVERSAL SERIES FLOAT SWITCH



Activates pump automatically. For use with all DC bilge pumps. Ignition protected. Marine grade tinned wires. GPH: 2000. 2 year warranty.

Item#	Volts	Amps	Case
19401	36	15	12



AUTOMATIC FLOAT SWITCH



- Converts virtually any bilge pump to automatic operation
- Made of noncorrosive ABS material
- Ball activation



Item#	Size	Volts	Amps	Case
19411	4 1/2" x 3" x 2 1/2"	12	15	10

AUTOMATIC FLOAT SWITCH



- Auto switch for bilge pump and high water alarm systems
- High impact case protects float and prevents failures due to debris lodging on top or under float
- Mercury switch potted in a urethane foam float will never water-log
- Full 5 year warranty
- **Warning:** Product contains mercury and may not be available for shipping in all areas

Item#	Volts	Amps	Case
19431	6-32	15	12

WATER PRESSURE SYSTEM



Connection: 3/8" BSP, 1/2" hose and, 1/2" BSP, 3/4" hose or US 3/8" NPT, 1/2" hose and US 1/2" NPT, 3/4" hose. US 1/2" - 14 NPS



- 12 V DC
- Quiet operation
- Smooth flowing
- Self priming
- Integrated pressure switch turns pump on and off automatically when spray nozzle is opened and closed
- Can be run dry without damage
- Low power consumption
- Quick disconnect fittings
- 3 year warranty

Item#	GPM	Case
17871	2.9 @ 41 psi	6
17881	3.5 @ 41 psi	6

WASH DOWN SYSTEM



Pump: 120 W. 12 V DC with built in thermal protection. Max suction: 8.2'. Nylon body. Connection: 3/8" BSP, 1/2" hose. US 1/2" NPT, 3/4" hose, 3/4" GHT.
System Features:

- Spray nozzle and inlet strainer included
- Smooth flowing, quiet operation
- Self-priming
- Integrated pressure switch turns pump on and off automatically when spray nozzle is opened and closed
- Can be run dry without damage
- Low power consumption
- Quick disconnect fittings
- 3 year warranty

Item#	GPM	Case
17851	2.9 @ psi 41	6
17861	3.5 @ psi 70	6

WASH DOWN PUMP KIT



Pump: 120 W. 12 V DC with built in thermal protection. Max suction: 8.2'. Nylon body. Connection: 3/8" BSP, 1/2" hose. US 1/2" NPT, 3/4" hose, 3/4" GHT.

- Kit Includes:**
- 25' coiled hose 1/2" I.D
 - Bulk head fitting with valve
 - PUMProtector™ inlet strainer
 - Spray nozzle with check valve
 - 2-way panel switches

Item#	GPM	Case
17831	3.5 @ psi 70	6
17841	5.2 @ psi 70	6

MACERATOR PUMP



The perfect disposer for the lavatory unit in boats and recreational vehicles...it takes care of toilet waste. A rotary cutter shreds waste before it is pumped out through the discharge hose. The pump can be connected directly to the bowl discharge outlet or holding tank.

Connection: Inlet: 1 1/2" hose, 1 1/2" BSP thread, 1 1/2"- 11 1/2" NPTF, Outlet: 1" hose



Item#	GPM	Volts	Case
17891	10 GPM at 6.7 ft.	12	1

LIVEWELL-BAITWELL PUMP



- Ignition protected
- Quiet running
- Marine grade tinned wires
- No burn out when run dry
- Both straight and angled fittings Included
- Two year limited warranty
- 12VDC

Item#	GPH	Outlet	Thread	Case
19461	600	3/4"	4" x 3/4"	12

12V AERATION/PUMP SYSTEM



Convert any ice chest or bait bucket into a livewell.

- Use to fill or empty livewell
- Use as a wash-down system
- Use as a bilge pump
- Two year limited warranty

Item#	GPH	Outlet	Case
19481	360	3/4"	4

STAINLESS STEEL COVERED THRU-HULL



Molded from polypropylene with glass fiber for strength. Not recommended for use below the waterline.

Item#	Hose	Flange	Max Hull Thickness	Case
18431	5/8"	1 7/8"	1 3/8"	6
18441	3/4"	1 7/8"	1 3/8"	6
18451	1"	1 7/8"	1 3/8"	6
18461	1 1/8"	1 7/8"	1 3/8"	6
18471	1 1/4"	2 3/8"	1 3/8"	6
18481	1 1/2"	2 3/8"	1 3/8"	6
18491	2"	3 1/4"	1 3/8"	6



18030

THRU-HULL CONNECTOR WITH BROAD FLANGE



Per ABYC "Safety Standards for Small Craft". Molded plastic with broad flange. Not recommended for use below the waterline.

Item#	Hose	Flange	Max Hull Thickness	Pkg.	Case
White					
18011	1/2"	1 1/2"	1 1/4"		12
18030	5/8"	1 5/8"	1 1/4"	Bulk	24
18031	5/8"	1 5/8"	1 1/4"		12
18050	3/4"	1 1/2"	1 1/4"	Bulk	24
18051	3/4"	1 1/2"	1 1/4"		12
18071	1"	1 7/8"	1 1/4"		10
18090	1 1/8"	1 7/8"	1 1/4"	Bulk	24
18091	1 1/8"	1 7/8"	1 1/4"		12
18111	1 1/2"	2 7/8"	1 1/4"		12
Black					
18151	3/4"	1 1/2"	1 1/4"		12
18171	1 1/8"	1 7/8"	1 1/4"		10

THRU-HULL CONNECTOR



Chrome plated molded plastic. Use in place of stainless steel thru-hulls. Not recommended for use below the waterline.

Item#	Hose	Flange	Max Hull Thickness	Case
17941	3/4"	1 1/2"	1 1/4"	12
17961	1 1/8"	1 7/8"	1 1/4"	12

THRU-HULL CONNECTOR



Extra long molded high impact white plastic with broad flange. Designed for installation where thick transoms or side walls require up to 2 1/2" long thread. Not recommended for use below the waterline.

Item#	Hose	Flange	Max Hull Thickness	Case
18161	3/4"	1 3/4"	2 1/2"	12
18181	1 1/8"	1 7/8"	3 3/8"	10

90° THRU-HULL CONNECTOR



Two nut application. High impact white plastic. Designed for places where hose is difficult to route. Great for livewells on bass boats. Not recommended for use below the waterline.

Item#	Hose	Flange	Max Hull Thickness	Case
18061	3/4"	1 5/8"	7/8"	12
18101	1 1/8"	2 3/8"	7/8"	12

90° THRU-HULL CONNECTOR



One nut application. Designed for use with one back nut, unlike old style 90° thru-hull with both front and back nut. Made of hi-impact white plastic. Designed for easier application where hose is difficult to route. Not recommended for use below the waterline.

Item#	Hose	Flange	Max Hull Thickness	Case
18131	3/4"	1 1/2"	3/4"	12
18141	1 1/8"	1 7/8"	1 1/8"	12
18121	1 1/2"	2 7/8"	1 3/8"	12

STAINLESS STEEL COVERED 90° THRU-HULL



Molded from polypropylene with glass fiber for strength. Not recommended for use below the waterline.

Item#	Hose	Flange	Max Hull Thickness	Case
18531	5/8"	1 1/8"	1 3/8"	6
18541	3/4"	1 7/8"	1 3/8"	6
18551	1"	1 7/8"	1 3/8"	6
18561	1 1/8"	1 7/8"	1 3/8"	6
18571	1 1/4"	2 3/8"	1 3/8"	6
18581	1 1/2"	2 3/8"	1 3/8"	6

DOUBLE-ENDED THRU-HULL CONNECTOR



Designed to provide watertight transition through tanks or bulk heads. Length: 4 3/4".

Item#	Hose	Max Hull Thickness	Case
18201	3/4" x 3/4"	1 1/4"	10

ELBOW & TEE



Can be used for plumbing or aerator systems. Made of white high impact plastic for corrosion resistance.

Item#	Description	Hose	Case
18211	90° Elbow	3/4"	12
18221	90° Elbow	1 1/8"	12
18241	Tee	3/4"	12
18251	Tee	1 1/8"	12

"Y" FITTING



3 Way "Y" fitting. Great for plumbing hard-to-reach areas.

Item#	Hose	Case
18231	3/4"	12

THREADED PIPE TAPE



Ideal for sealing threaded joints. Resists most acids and solvents. 3 mil. thick.

Item#	Size	Case
91051	1/2" x 43'	12

SCUPPER VALVE



High impact fiberglass reinforced white plastic ring with rubber flap and gasket. For boats with self bailing cockpits. Mounts on transom above water line.

Item#	Size	Fastener	Case
18261	2 7/8" dia.	(4) #6	12

SELF BAILING SCUPPER



Automatically seals and drains self bailing decks. Made of polycarbonate material. Solid polyethylene ball and PVC seal mounts on transom above water line. 18271 and 18291 designed to retrofit Model 18261.

Item#	Size	Fits	Color	Fastener	Case
18271	Small	3/4" - 1 1/2" openings	Clear	(4) #8	12
18281	Large	1 1/2" - 3" openings	Clear	(6) #10	12
18291	Small	3/4" - 1 1/2" openings	Black	(4) #8	12



DECK AND BAITWELL PLUG



For use in livewells or baitwells. Stainless steel top and bottom plate. Brass cam. Neoprene body.

Item#	Type	Fits	Card	Pack	Case
18931	Snap-Lock	3/8"	2	1 pr.	12
18941	Snap-Lock	1/2"	2	1 pr.	12
18951	Snap-Lock	5/8"	2	1 pr.	12
18961	Snap-Lock	3/4"	2	1 pr.	12

DRAIN PLUG



Rugged construction for durability. Mount from inside transom. Bulk items come in reusable bucket.

Twist-Turn Plugs: Fully adjustable, will not leak or jar loose.

Snap-Lock Plugs: Cam-action provides easy installation. Will not jar loose.

18800 & 18820: Sold in bulk. Minimum quantity of 50.

Item#	Type	Material	Fits	Pkg.	Case
18891	Twist-Turn	Stainless Steel	1"		12
18800	Twist-Turn	Brass	1"	Bucket	50
18801	Twist-Turn	Brass	1"		12
18861	Twist-Turn	Brass	1 1/4"		12
18901	Snap-Lock	Stainless Steel	1"		12
18820	Snap-Lock	Brass	1"	Bucket	50
18821	Snap-Lock	Brass	1"		12
18871	Snap-Lock	Brass	1 1/4"		12

GARBOARD DRAIN PLUG



- Cast bronze flange
- Brass plug
- 2" OD
- Fits 1/2" pipe
- Mounts with #8 screws

Item#	Description	Pkg.	Case
18750	Flange & Plug	Bulk	12
18751	Flange & Plug	Card	12
Opt. Accy.	Description	Pkg.	Case
18761	Plug	Carded	12
18760	Plug	Bulk	12

GARBOARD DRAIN PLUG



Plug Only



Flange & Plug

- 2" OD
- Fits 1/2" pipe
- Mounts with #8 screws

Item#	Description	Material	Case
18711	Flange & Plug	Stainless Steel	12
18731	Flange & Plug	Chrome Plated Brass	12
Opt. Accy.	Description	Material	Case
18741	Plug	Chrome Plated Brass	12
18721	Plug	Stainless Steel	12

SPLASHWELL DRAIN TUBE



Durable plastic drain tube for motorwell, livewell or baitwell. Fits 1" opening. Adjusts to fit bulkheads from 3/4" to 2 1/2". Flange OD 1 1/4". Use 3/4" baitwell plug to close opening (18961).

Item#	Fits	Case
19121	1" Opening	12

SPLASHWELL DRAIN TUBE



Durable plastic drain tube for motorwell, livewell or baitwell. Adjusts to fit bulkheads from 2" to 4 1/2". Use 1" drain plug to close opening (18801, 18821, 18891 or 18901).

Item#	Fits	Case
19131	1 1/4" Opening	12

DRAIN PLUG



- Black Nylon
- 1" hole diameter
- Use #10 screws

Item#	Description	Material	Case
18641	Drain Plug	Nylon	12
Opt. Accy.	Description	Case	
18651	Plug and Gasket	12	

DRAIN PLUG



Black nylon screw type drain plug features an "O" ring for positive sealing. Fine threads maintain sealing under high vibration conditions. Mounts in a 1" diameter hole and mounts with two #8 screws. Mounting flange: 1 1/2" x 2". Ideal for boat transoms, fish wells, ice chests. Plug is attached.

Item#	Material	Case
18781	Nylon	12

GARBOARD DRAIN PLUG



316 Stainless steel threaded removable plug. Retention system keeps plug from getting lost. High polished 316 stainless steel reduces corrosion. Guaranteed for life.

Item#	Material	Size	Case
18661	Stainless Steel	7/8" Dia.	12

DRAIN TUBE



Drain tube with .035" wall. For use in transom, motorwell, livewell or baitwell.

Item#	Pipe	Length	Case
19051	1" ID	1 1/8"	12
19071	1" ID	3"	12
19111	1" ID	6"	12
19091	1 1/4" ID	3"	12

COCKPIT ORGANIZER



Large Super Suction™ cups. Mounts on any smooth surface. Can be permanently attached with screws. Holds fishing gear, binoculars and other items. Non-corrosive.

Item#	Color	Case
79321	White	6

GPS/CELL PHONE CADDY



Large Super Suction™ cups. Mount vertically or on any flat, smooth surface. Can be permanently attached with screws. Non-corrosive.

Item#	Color	Case
79341	White	6

MARINE U.S. FLAG KIT



Kit Contains:

- Print dyed nylon U.S. Flag (78201)
- Chrome plated brass 3/4" flag pole socket (70701)
- Varnished mahogany 18" flag pole (77021)

Item#	Size	Case
78191	Flag: 12" x 18". Socket: 3/4"	8

DELUXE SEWN AMERICAN FLAG



- 100% Nylon
- Reinforced headings
- Double stitching for extra durability
- Brass grommets

Item#	Size	Case
78211	12" x 18"	12

FLAGS



Item#	Description	Size	Case
78201	United States	12" x 18"	12
78221	Canada	12" x 18"	12
78241	Bahamas Courtesy	12" x 18"	12
78251	Jolly Roger	12" x 18"	12
78261	Port Clearance (solid yellow)	12" x 18"	12
78271	Mexico	12" x 18"	12
78281	Puerto Rico	12" x 18"	12
78291	Cuba	12" x 18"	12

- Print-dyed nylon body
- Canvas header
- Brass grommets

SKI FLAG



- Heavy duty nylon construction
- Contains suction cup and plastic pole

Item#	Size	Length	Color	Case
78301	12" x 18"	24"	Orange	12

DIVER DOWN FLAG



Made of vinyl with stiffener. Poly bagged.

Item#	Color	Size	Case
78231	Red & White	20" x 24"	12

DISTRESS SIGNAL S.O.S. FLAG



USCG Approved Orange Flag
Black circle and square printed on international orange flag. PVC material. Reinforced grommets on each corner. Four pieces of line included for hold downs.

Item#	Size	Color	Case
78341	3' x 3'	Orange & Black	12

FLAG CLIP

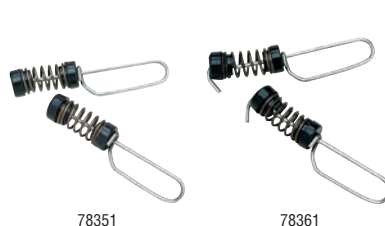

Made of 304 stainless steel. Spring loaded for easy installation. Keeps flags flying even at low speed. Attaches to halyards, antennas or outrigger lines.

Item#	Description	Pack	Case
78351	Halyard/Lines	1 pr.	12
78361	Antenna	1 pr.	12

RAIL CLAMP FLAG STAFF



Made of stainless steel.

Item#	Fits	Length	Case
77001	7/8" rail	15 3/8"	12



FLAG POLE



- Varnished mahogany pole
- Complete with two brass screw hooks

Item#	ID	Length	Case
77021	3/4"	18"	12

FLAG POLE SOCKET



- Chrome plated brass
- 3/4" Hole Size
- 2" Flange
- Fasten with #8 screws

Item#	Fits	Case
70701	77021 Flag Pole	12

76 PIECE DELUXE TOOL KIT



Made of forged chrome vanadium steel for durability. This kit is a must for every boatsman. Contents are secured in place in an attache style tough molded carrying case.

Kit Contains:

- (8) Combination Wrenches, 5/16" - 3/4"
- (2) Screwdrivers: 1 1/2" (Phillips/Slotted)
- (2) Screwdrivers: 4" (Phillips/Slotted)
- (1) Screwdriver 8" (Slotted)
- (1) Circuit Tester
- (1) 9" Crimping Tool
- (30) Terminals
- (1) 9 1/2" Water Pump Pliers
- (1) 10" Extension Bar
- (1) 10" Sliding Bar
- (6) Allen Wrenches
- (1) Battery Cleaning Brush
- (1) 5" Extension Bar
- (1) 10" Locking pliers
- (1) 1/2" Drive Ratchet Handle, 10"
- (1) Hammer
- (1) 1/2" Drive Spark Plug Socket
- (1) 1/2" Drive Universal Joint
- (1) Gapping Tool
- (13) 1/2" Drive Sockets, 5/16" - 15/16"
- (1) Carrying Case

Item#	Case
79861	3

DELUXE FASTENER KIT



Ideal for every boater. Contains 168 of the most commonly used repair and replacement stainless steel fasteners.

Kit Contains:

- (8) Phil. Oval Self-Tap 6 x 3/4
- (8) Phil. Oval Self-Tap 8 x 1
- (12) Phil. Pan Self-Tap 8 x 3/4
- (8) Phil. Flat Self-Tap 6 x 3/4
- (8) Phil. Flat Self-Tap 8 x 1
- (8) Phil. Oval Machine 8 - 32 x 3/4
- (8) Phil. Oval Machine 10 - 24 x 1
- (8) Phil. Flat Machine 6 - 32 x 3/4
- (8) Phil. Flat Machine 8 - 32 x 1
- (8) Sl. Oval Wood 4 x 1/2
- (8) Sl. Oval Wood 8 x 1
- (8) Hex Nut 6 - 32
- (12) Hex Nut 8 - 32
- (8) Hex Nut 10 - 24
- (12) Finish Washer #6
- (28) Finish Washer #8
- (8) Finish Washer #10

Item#	Description	Case
60011	Stainless steel	5

FLOATING KEY BUOY



78081

78091

Watertight. Floating key buoy used to store small items such as registration, money, etc. Distinctive color top snaps apart.

Item#	Color	Case
78081	Red	12
78091	Green	12

UNIVERSAL CLIP



Poly clip with stainless steel spring. Hundreds of uses. Including drying clothes, towels, hanging signs, etc.

Item#	Fits	Pack	Case
36381	7/8" Rail	1 pr.	12

GEAR HAMMOCK



Fits over bunks, corners and other out of the way places. A must for items that need ventilation.

Item#	Length	Color	Material	Case
71401	60"	White	Nylon	12

STAINLESS STEEL UTILITY HOOK



Corrosion resistant, light duty stainless steel lashing hooks for items requiring wall hanging. Ideal for hammocks. Fasten with #8 pan head screws.

Item#	Size	Pack	Case
71411	1 1/4" x 1 1/4"	1 pr.	12

PADLOCK



Solid brass body and hasp with 2 nickel plated brass keys.

Item#	Description	Size	Pack	Case
37201	Single lock	1 1/4"	1	12
37211	Single lock	1 1/2"	1	12
37231	Single lock	2"	1	12
37301	Three Locks, keyed alike	1 1/4"	3	12
37311	Three Locks, keyed alike	1 1/2"	3	12
37331	Three Locks, keyed alike	2"	3	12

COILED WASHDOWN HOSE WITH SPRAYER



White poly hose is UV and chemical resistant and has brass hose fittings.

Item#	Size	Color	Case
79691	1/2" Dia. x 25' L	White	3

HOSE NOZZLE



79601

79631

- 5 1/2" hose nozzle
- Fully adjustable spray with locking lever
- Threaded front
- Contour handle

Item#	Description	Case
79601	Plastic w/stainless steel return spring	12
79631	Brass w/adjustable spray locking lever	12

SHUT-OFF CONNECTOR



Non corrosive plastic. Dual shut-off valves with heavy duty handles and ball valves. **Not recommended for hot water.**

Item#	Description	Case
79671	"Y" Double Hose	12

HOSE MENDER & COUPLING



79641 79651 79661

Non-corrosive indestructible black nylon. Fits rubber or plastic hoses 5/8" to 3/4".

Item#	Description	Size	Case
79641	Hose Mender	5/8" to 3/4"	12
79651	Female Hose Coupling	5/8" to 3/4"	12
79661	Male Hose Coupling	5/8" to 3/4"	12

"WELCOME ABOARD" MAT



Navy with white lettering. Heavy olefin backing. Constructed to stand up to the elements.

Item#	Size	Case
78180	18" H x 27" W	12

WINDPROOF ASHTRAY



Non corrosive stainless steel non-slip bean bag ashtray with attractive nautical design.

Item#	Color	Size	Case
79401	Blue	4 1/8" dia.	12

BOTTLE OPENER



Manufactured of 304 polished stainless steel, stamped and formed. #8 screws included.

Item#	Size	Case
32681	1 1/2" W x 3" H	12

New STAINLESS STEEL TUMBLER



- Double wall insulation with vacuum seal gives superior insulation keeps drinks hot or cold for hours
- 18-8 grade stainless steel for excellent performance and long life
- Special interior coating process to ensure vacuum seal stays air tight
- Sweat free. The double wall construction keeps the heat or cool in the cup while the outside surface stays at room temperature
- Crystal clear Tritan BPA free lid insulates and keeps a great seal
- "Tall" base design allows fit in more vehicle cup holders and is easier to grip

Item#	Size	Case
08211	30 oz	24

FOLDING AND ADJUSTABLE DRINK HOLDER

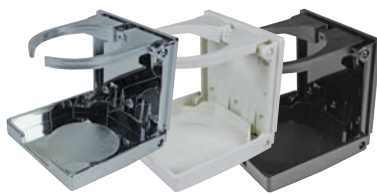

79411 79451 79461

Made of fiberglass reinforced nylon with stainless steel springs and nickel plated brass rivets. Adjustable arms hold cans, glasses, insulated drink holders and bottles. Folds up neatly when not in use.

Item#	Color	Case
79411	Chrome Plated	12
79451	White	12
79461	Black	12

DRINK HOLDER



Beverage holder with foam thermal insulator and two mounting brackets. Swings freely to prevent spills and is easily detachable. Fasten with #8 screws (supplied).

Item#	Material	Case
79471	Chrome Plated Brass	12

STAINLESS STEEL RECESSED DRINK HOLDER WITH LED LIGHT



79371



- 3 LEDs (12V)
- Includes 1/4" drain

Item#	Color	Size	Hole	Case
79371	Stainless Steel w/Blue Light	4 1/4" OD x 3 7/8" D	3 3/8"	6
79391	Stainless Steel w/Red Light	4 1/4" OD x 3 7/8" D	3 3/8"	6

PLASTIC RECESSED DRINK HOLDER



79481



79490

79430, 79490: 3/8" hose fitting. Drain hole on bottom.

Item#	Color	Size	Hole	Case
79481	Black	3 3/8" OD x 3" D	3"	12
79441	White	3 3/8" OD x 3" D	3"	12
79430	Black	4 3/8" OD x 4 1/4" D	4 1/4"	12
79490	White	4 3/8" OD x 4 1/4" D	4 1/4"	12

STAINLESS STEEL RECESSED DRINK HOLDER



Includes 1/4" drain.

Item#	Color	Size	Hole	Case
79421	Stainless Steel	4 1/4" OD x 3 7/8" D	3 3/8"	6

STAINLESS STEEL RECESSED DRINK HOLDER



Includes 3/8" drain.

Item#	Color	Size	Hole	Case
79420	Stainless Steel	4" OD x 3 3/4" D	3 3/4"	12



DRINK HOLDER



Large Super Suction™ cups. Non-corrosive. Mounts on any smooth surface. Can be permanently attached with screws.

Item# 79381	Color White	Case 6
-----------------------	-----------------------	------------------

CRUISIN' CADDY



Super Suction™ Cups. Non-corrosive. Mounts easily either vertically or on any flat surface. Can be permanently attached by using screws. Holds your beverage, personal items and even a couple of lures.

Item# 79361	Color White	Case 6
-----------------------	-----------------------	------------------

COOLER CUSHION



White UV resistant marine grade vinyl.

Item#	Description	Fits	Color	Size	Case
76811	Velcro® Straps	48 Qt.	White	23 1/4" x 13 3/8" x 3"	6
76821	Velcro® Straps	54 Qt.	White	22 1/8" x 10 5/8" x 3"	6
76831	Snap Straps	72 Qt.	White	26 1/4" x 15 1/4" x 3"	3
76841	Snap Straps	94 Qt.	White	31 1/4" x 15 5/8" x 3"	3
76851	Snap Straps	128 Qt.	White	38 1/4" x 17 1/2" x 3"	2
76861	Snap Straps	162 Qt.	White	40" x 17" x 3 1/8"	2

IGLOO REPLACEMENT PARTS



Most popular replacement parts for Igloo coolers. 76901, 76891 and 76921 are sold in pairs.

- 76881: Fits Size (Qts.): 28, 36, 40, 48, 54, 72, 94, 128, 162
- 76891: Fits Size (Qts.): 28, 36, 40, 48, 54, 72, 94, 128, 162
- 76901: Fits Size (Qts.): 28, 36, 40, 48, 54, 72, 94, 128, 162
- 76921: Fits Size (Qts.): 28, 36, 40, 48, 54, 72, 94, 128, 162
- 76931: Fits Size (Qts.): 28, 36, 40, 48, 54
- 76941: Fits Size (Qts.): 72, 94, 128, 162
- 76951: Fits Size (Qts.): 28, 36, 40, 48, 54

Item#	Description	Material	Pack	Case
76881	Latch	SS & Plastic	1	12
76891	Hinges	SS	1	12
76901	Hinges	Plastic	1 pr.	12
76921	Latch set	Plastic	1 pr.	12
76931	Non-threaded drain plug	Plastic	1	12
76941	Threaded drain plug	Plastic	1	12
76951	Handle assembly	Plastic	1	12

COOLER MOUNTING KIT



Cooler's corners stay put with straps. Prevents injury, boat and cooler damage. Quick disconnect strap design. Corrosion proof. Fastens with #8 screws (not included).

Item#	Description	Pack	Case
76991	Mounting Kit	1	12
76971	Mounting Kit Straps	2	12

3 1/4" LETTER & NUMBER KITS



Solid self-aligning mylar. Each kit contains 4 of each letter and number totaling 148 pieces. Numbers and letters are pressure sensitive. Just peel off backing and press on.

Item#	Description	Case
77111	Black	6
77121	White	6

3" LETTER AND NUMBER KIT



Solid self-aligning mylar. Each display contains 360 pieces. 10 each of letters A to Z. 10 each of numbers 0 thru 9. Rack and header included.

Item#	Description	Case
77501	Complete Display - Black	1
77901	Complete Display - White	1



3" GOTHIC LETTERS & NUMBERS



Black

White

Priced and sold in packs of 10.
Not available in all locations.

Item#	Letters	Color	Pack
74131	A	Black	10
74141	B	Black	10
74151	C	Black	10
74161	D	Black	10
74171	E	Black	10
74181	F	Black	10
74191	G	Black	10
74201	H	Black	10
74211	I	Black	10
74221	J	Black	10
74231	K	Black	10
74241	L	Black	10
74251	M	Black	10
74261	N	Black	10
74271	O	Black	10
74281	P	Black	10
74291	Q	Black	10
74301	R	Black	10
74311	S	Black	10
74321	T	Black	10
74331	U	Black	10
74341	V	Black	10
74351	W	Black	10
74361	X	Black	10
74371	Y	Black	10
74381	Z	Black	10
74401	0	Black	10
74411	1	Black	10
74421	2	Black	10
74431	3	Black	10
74441	4	Black	10
74451	5	Black	10
74461	6	Black	10
74471	7	Black	10
74481	8	Black	10
74491	9	Black	10
74511	A	White	10
74521	B	White	10
74531	C	White	10
74541	D	White	10
74551	E	White	10
74561	F	White	10
74571	G	White	10
74581	H	White	10
74591	I	White	10
74601	J	White	10
74611	K	White	10
74621	L	White	10
74631	M	White	10
74641	N	White	10
74651	O	White	10
74661	P	White	10
74671	Q	White	10
74681	R	White	10
74691	S	White	10
74701	T	White	10
74711	U	White	10
74721	V	White	10
74731	W	White	10
74741	X	White	10
74751	Y	White	10
74761	Z	White	10
74801	0	White	10
74811	1	White	10
74821	2	White	10
74831	3	White	10
74841	4	White	10
74851	5	White	10
74861	6	White	10
74871	7	White	10
74881	8	White	10
74891	9	White	10

3" SOLID LETTERS & NUMBERS



Item#	Letters	Color	Pack
77131	A	Black	10
77141	B	Black	10
77151	C	Black	10
77161	D	Black	10
77171	E	Black	10
77181	F	Black	10
77191	G	Black	10
77201	H	Black	10
77211	I	Black	10
77221	J	Black	10
77231	K	Black	10
77241	L	Black	10
77251	M	Black	10
77261	N	Black	10
77271	O	Black	10
77281	P	Black	10
77291	Q	Black	10
77301	R	Black	10
77311	S	Black	10
77321	T	Black	10
77331	U	Black	10
77341	V	Black	10
77351	W	Black	10
77361	X	Black	10
77371	Y	Black	10
77381	Z	Black	10
77401	0	Black	10
77411	1	Black	10
77421	2	Black	10
77431	3	Black	10
77441	4	Black	10
77451	5	Black	10
77461	6	Black	10
77471	7	Black	10
77481	8	Black	10
77491	9	Black	10
77511	A	White	10
77521	B	White	10
77531	C	White	10
77541	D	White	10
77551	E	White	10
77561	F	White	10
77571	G	White	10
77581	H	White	10
77591	I	White	10
77601	J	White	10
77611	K	White	10
77621	L	White	10
77631	M	White	10
77641	N	White	10
77651	O	White	10
77661	P	White	10
77671	Q	White	10
77681	R	White	10
77691	S	White	10
77701	T	White	10
77711	U	White	10
77721	V	White	10
77731	W	White	10
77741	X	White	10
77751	Y	White	10
77761	Z	White	10
77801	0	White	10
77811	1	White	10
77821	2	White	10
77831	3	White	10
77841	4	White	10
77851	5	White	10
77861	6	White	10
77871	7	White	10
77881	8	White	10
77891	9	White	10



CANVAS FOLDING CHAIR



- High back canvas chair
- Canvas back has a handy storage pouch for magazines, books, etc.
- Double leg construction for added support
- 1" anodized aluminum tubing frame
- Varnished arm rests
- Seat: 19" W x 15.5" D

Item#	Color	Size	Case
78511	Blue w/ Red Trim	38" H x 23.5" W	1

FOLDING DECK CHAIR



- White UV resistant marine vinyl
- 1" anodized aluminum tubing
- Safe with open-position locking device
- Folds for easy storage
- 300 lb. Weight capacity
- Use only soap and water to clean
- Seat: 18.5" W x 14" D

Item#	Color	Size	Case
78501	White	31" H x 25" W	1

SEAT SWIVEL



360° swivel. Cadmium plated frame with 6 ball bearings. Specially designed for padded seats. Base and seat hole pattern are adjustable from 4¾" to 5¾" on centers.

Item#	Pack	Case
78400	Bulk	10

SAFETY EQUIPMENT

New 62 SERIES CARBON DETECTOR



Space saving compact design for boats. Designed for the harsh marine environment. No False Alarms due to new boat smell, outgassing or non-hazardous levels of hydrocarbon gases encountered while boating. Alarm Mute button silences alarm while boat is ventilated. Rapid recovery sensor resets when silenced or reactivates alarm if dangerous levels of CO remain. Memory Scan™ - Retains the CO level that activated the alarm. Micro Current Technology - Saves precious battery power in a boat. End of Life Signal alerts boater to replace the alarm after 5 years of service. Listed to UL 2034 Marine Use and CSA 6.19-01.



Item#	Description	Color	Case
46361	Flush Mount	White	10
46371	Surface Mount	White	10

New SMOKE DETECTOR



Detector automatically resets. Easy to install; no wiring required. 24 hour continuous protection. Alarm mute with auto reset and a low battery signal. Safe ionization technology. Micro design and engineered. Battery operated - 9 volt battery included. UL listed to 10/1/99 UL standard for recreational vehicle smoke alarms.



Item#	Description	Dia.	Color	Case
46331	Surface Mount	4"	White	10

New GAS/PROPANE FUME DETECTOR



Provides protection against accidents caused by Gas/Propane spills or leaks. Remote sensor monitors bilge/engine compartment during and after fueling. Install sensor in galley or LP tank locker to protect against propane leaks. Sight and Sound Alarm Indicator. Dual signaling sounds an alarm and activates warning light. Exclusively designed for the harsh marine environment. Detects the build up of explosive gases. On/Off/Test For one touch analysis of detector performance. UL listed.



Item#	Description	Color	Case
46381	Surface Mount	Black	10

New FUME, FIRE & FLOOD DETECTOR



Fume: Protection against accidents caused by gas/propane spills or leaks.
Fire: Thermal sensor alarms when fire conditions exist.
Flood Detector: Alerts you to bilge flooding and pump problems.

- Sight and Sound alarm indicator. Dual signaling sounds an alarm/activates warning light.
- Smart Fume Sensor - Detects the build up of explosive gases.
- Thermal Sensor - Monitors for high heat and heat from fire
- Water Sensor - Monitors bilge for high water
- On/Off/Test for one touch analysis of detector performance. Exclusively designed for the harsh marine environment.

Item#	Description	Color	Case
46391	Surface Mount	Black	10

EMERGENCY WOOD PLUGS



Assorted wood plugs are used for emergency leaks.

Item#	Size	Bag	Case
45411	½" - 2"	6	10

DISTRESS SIGNAL S.O.S. FLAG



USCG Approved Orange Flag
 Black circle and square printed on international orange flag. PVC material. Reinforced grommets on each corner. Four pieces of line included for hold downs.

Item#	Size	Color	Case
78341	3' x 3'	Orange & Black	12

FOG BELL



Hand polished cast triple chrome plated brass. Complete with removable bracket. Fasten with #6 screws.

Item#	Size	Case
46021	6" Dia. x 4" H	9

JETSCREAM™ FLOATING WHISTLE



The JetScream Whistle is a powerful signaling device that can easily be heard above most natural and man-made noises. It's ear-piercing 122db shriek makes it one of the loudest whistles of its kind. Pea-less construction allows for all-weather use. Made of durable ABS - waterproof and it floats.

Item#	Description	Size	Pack	Case
46431	Individual Whistle	2"	1	6

WHISTLE



Meets USCG requirements as a signal device
 Perfect for attachment to life vest as a signal whistle. Lanyard included.
46010: Sold in bulk. Minimum quantity of 100.

Item#	Pkg.	Case
46010	Bucket	1
46011	Card	12

STREAMLINED SAFETY WHISTLE



Bucket



46041

Meets USCG requirements as a signal device

Rugged marine whistle colored bright orange and made of non-corroding, high impact plastic. Comes with lanyard.

46040: Sold in bulk. Minimum quantity of 50.

Item#	Pkg.	Pack	Case
46040	Bucket	50	1
46041	Card	1	12

TRIPLEX MOTOR BOAT WHISTLE



Meets USCG requirements as a signal device

International orange color with lanyard hole. Loud triple tone.

Item#	Size	Case
46031	6" L x 1 3/4" W	12

PUMP BLAST AIR HORN



46311



Meets U.S. Coast Guard requirements for boats up to 65'. Patent Pending.

- Eco-Friendly - no replacement cans or chemicals
- Easy to use
- Not just for boating - use at sporting events or for your auto
- No shipping restrictions

Item#	Description	Rating	Case
46311	Large w/ Metal Plunger	110 Decibels	8

SIGNAL HORN KIT



Meets USCG requirements as a signal device
Signal horn kit complete with trumpet. 100% non-flammable. The trumpet is made of a high impact plastic. 120 decibels at over 3 feet.

Item#	Description	Case
46111	8 oz. Horn kit	12
46101	8 oz. Horn refill	12

HIDDEN HORN



Meets ABYC, NMMA specifications

Contains stainless steel cover and 2 electrical connectors (packard and 2-T quick disconnect).

Fastener on center width: 2.1". Cut Out: 3.5" L x 2.5" H, with rounded edges.

Item#	Size	Volts	Max Amps	Case
14571	3.1" H x 5.6" W x 3.6" D	12	6	6

COMPACT ELECTRIC HORN



14501



14521

Stainless steel cover. 12V DC. For use in extreme weather exposure locations and limited space applications. Complete with mounting pad and wire harness.

Item#	Description	Size	Rating	Max Amps	Case
14501	Single	3 1/2" x 3 1/4" x 2 5/16"	105 db	4	12
14521	Double	7 3/4" x 3 3/32" x 2 7/32"	108 db	8	10

TRUMPET HORN



14541

14561

All stainless steel trumpet tube, mounting bracket and motor cover. Vibration free mounting with rubber pad. Fastens with #10 screws.

Item#	Description	Length	Rating	Volts	Max Amps	Case
14541	Single	16 3/4"	106 db	12	6	1
14561	Dual	20 3/4"	109 db	12	6	1

SURVIVAL TOOL

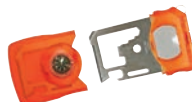

Stainless-steel multi-tool encased in orange plastic.

10+ Tools in One:

- Liquid-filled compass
- Magnifying glass
- 1 inch/5 cm ruler
- Mini-flat head screwdriver
- Mini Phillips screwdriver
- Large flathead screwdriver
- Position wrench (4 different sizes)

- Butterfly wrench
- Can & bottle opener
- Sharp knife edge
- Attachment for lanyard or key ring
- File edge
- Small 8-sided bolt head wrench
- Striker

Item#	Size	Case
46801	3.25" x 2.2" x .5"	6

WATERPROOF NOTEBOOK



Great for keeping logs in wet environments

- Tear-proof
- Conveniently fits in your pocket, backpack, etc.
- Includes all-weather pencil

Item#	Size	Case
46741	3" x 5"	6

SEA-BAND® WRIST BAND



The Sea-Band has been designed to end worries about motion sickness caused by rough seas, bumpy air flights and endlessly winding roads. There are no drugs, no side effects, only a gentle pressure on each wrist. Sold as a pair.

Item#	Pack	Case
42061	1 pr.	6

BASIC FIRST AID KIT



Waterproof Kit Contains:

- (2) Ammonia Inhalants
- (4) Antiseptic Towelettes
- (35) Bandages 1" x 3"
- (1) First Aid Cream
- (1) First Aid Sheet
- (3) Gauze Pads 3" x 3"
- (4) Non-aspirin Tablets
- (2) PVP Iodine U.S.P. Prep Pads
- (1) Scissors
- (1) Tape, 1/2" x 90"
- (2) Triple Antibiotic Foil Packs

Item#	Case
42021	12



DELUXE FIRST AID KIT



Waterproof Kit

Contains:

- (2) Ammonia Inhalants
- (4) Antiseptic Towelettes
- (35) Bandages 1" x 3"
- (1) Cotton ½ oz.
- (1) First Aid Book
- (1) First Aid Cream, 7/8 oz.
- (3) Gauze Pads 2" x 2"
- (3) Gauze Pads 2" x 3"
- (3) Gauze Pads 3" x 3"
- (4) Non-Aspirin Tablets
- (4) Aspirin Tablets
- (1) Scissors
- (1) Tape, ½" x 90"
- (1) Tweezers
- (2) Triple Antibiotic Foil Packs

Item#
42041

Case
12

TELESCOPING BOAT HOOK



Tubing made with 6063 aluminum for years of maintenance-free service. Hook is made of glass reinforced nylon. Features special locking cam action. Handle Diameter: 1 3/8"

Item#	Length	Pack	Case
71050	4' to 7' (Fully Extended)	Bulk	12

BOAT HOOK HOLDER



Made of stainless steel with a polished finish. Holds poles up to 1 1/2" diameter.

Item#	Size	Fastener	Pack	Case
71011	3 1/2" x 1"	#6	1 pr.	12

SPRING CLAMP



Made of stainless steel with a polished finish. Fastens with #6 P.H. screws.

Item#	Size	Pack	Case
72011	5/8" - 1 1/4"	1 pr.	12
72031	1" - 1 3/4"	1 pr.	12

RUBBER STORAGE CLIP



Perfect solution for storing pole lights, boat hooks, gaffs, boat mops, etc. Made of molded black rubber, these clips will accommodate diameters of 3/4" to 1".

Item#	Size	Pack	Case
72051	2" x 1 5/8"	1 pr.	12

TELESCOPING PADDLE/BOAT HOOK



- Lightweight
- Corrosion resistant aluminum
- High strength molded material

Item#	Length	Color	Case
71090	18" - 31"	Orange	6
71080	26" - 72"	Orange	6

PADDLE/BOAT HOOK



Corrosion resistant anodized aluminum construction with a high impact plastic handle. Handle has a positive non-slip cam lock with a built-in boat hook. Easy stowing and it floats!

Item#	Length	Color	Pack	Case
71070	4' to 6' (Fully Extended)	White	Bulk	12

CLAMP-ON OARLOCKS



Resists rust. Shank is 1/2" x 2" and fastens securely to oars with one adjustable bolt. Inside diameter: 1 3/8". Packaged 2 per card.

Item#	Material	Pack	Case
70521	Zinc Plated Steel	1 pr.	12

ROWLOCK SET



70401



70501

Top mounted.

70401 Includes:

- (2) Rowlock horns: OD shank: 1/2", Shank length: 1 3/4"
- Between horns: 1 3/4" Complete with

locking pin

- (2) Rowlock sockets
- Plastic bearings
- Dimensions: 2 7/8" x 1 1/8" x 1 1/8", ID Hole: 1/2"

Item#	Type	Material	Pack	Case
70401	Oarlock Set	Chrome Plated Zinc	1 pr.	12
70501	Horns Only	Chrome Plated Zinc	1 pr.	12

OARLOCK SOCKET



Item#	Material	Shank	Size	Pack	Case
70421	Chrome Plated Zamak	1/2"	2 7/8" x 1 1/8" x 1 1/8"	1 pr.	12

LIGHT STICKS



- Battery-free emergency lighting
- Provides hours of soft, glowing light
- Weatherproof
- Attach easily anywhere you need, with integrated hook and lanyard hole
- Contents are non-flammable
- 32" breakaway lanyard included

Item#	Description	Color	Pack	Case
46411	6" Sticks	1 Green, 1 White	2	12
46421	6" Sticks	2 Green, 1 White, 1 Red	4	12

LIFE JACKET LIGHT STICK



Coast Guard Approved
Attaches to life jacket. 100% safe, non-toxic, non-flammable. Simply squeeze handle to break seal. Slide cover off. Lasts up to 12 hours. Never worry about replacing batteries or bulbs.

Item#	Case
46151	12

GREEN LIGHT STICK



An ideal source of light during any night time situation. They are waterproof, self-igniting (no need for matches or batteries) and will not corrode. Lasts up to 12 hours. 2 pack.

Item#	Pack	Case
45961	1 pr.	12

RING BUOY BRACKET



- Polished 304 stainless steel
- 7" L x 3/4" W
- 4" opening
- Fasten with #10 screws.

Item#	Case
71021	12

EMERGENCY PONCHO



- Hooded
- Lightweight
- Reusable
- One size fits all
- A must for emergencies, sporting events, travel etc.

Item#	Size	Color	Case
46711	50" x 80"	Yellow	6

SURVIVAL PONCHO



- Keeps wearer dry in the rain
- Compact, lightweight, waterproof
- Can be used for heat deflection or body heat retention
- Can act as a wind & rain barrier
- Can be used as a reflective tool because it is easily spotted from a distance

Item#	Size	Color	Case
46721	87" x 55"	Reflective	24

FOAM SAFETY CUSHION



Type IV PFD Fully U.S. Coast Guard Approved
Designed to be thrown to someone who has fallen overboard. PE foam filling.

Item#	Color	Size	Case
44930	Blue	15" x 15"	12
44910	Camo	15" x 15"	12
44940	Red	15" x 15"	12
44920	White	15" x 15"	12
44900	Yellow	15" x 15"	12

GEAR BAG



Large capacity. Made of heavy duty nylon with red lettering. Non-corrosive zippered top closure and carrying handles. Keeps contents dry and clean.

Item#	Description	Size	Pack	Case
44990	Life Jacket	20" L x 18" W x 12" H (Holds 6)	Bulk	35
44980	Safety Gear	26" L x 12" W x 17" H	Bulk	35

LIFE VEST 4-PACK WITH BAG



Type II PFD, Fully U.S. Coast Guard Approved
UV resistant marine grade vinyl carry bag. Contains (4) adult sized Universal Life Vests (Type II PFD)

86010: Contains Model 86020
85510: Contains Model 85520

Item#	Description	Size	Case
86010	Yellow	20" L x 12" W x 10" H	2
85510	Orange	20" L x 12" W x 10" H	2



**"BOSUN" SAFETY KIT****Boats Up to 25 Feet**

- (2) Dock Lines - $\frac{3}{8}$ " x 20'
- (1) Anchor Line - $\frac{3}{8}$ " x 100'
- (1) Fire Extinguisher - 10BC
- (4) Life Jackets

Item#
45001

- (4) Handheld Flares, Red
- (1) Signal Horn Kit
- (1) Foam Cushion
- (1) Coast Guard pamphlet

Case
1

"ECONOMY" SAFETY KIT**Boats Up to 19 Feet**

- (2) Dock Lines - $\frac{3}{8}$ " x 15'
- (1) Anchor - #7 Utility
- (1) Fire Extinguisher - 5BC
- (1) Signal Horn Kit
- (4) Hand Held Flares, Red

Item#
45051

- (1) Anchor Line - $\frac{3}{8}$ " x 100'
- (4) Life Jackets
- (1) Anchor Shackle - $\frac{1}{4}$ "
- (1) Foam Cushion
- (1) Coast Guard pamphlet

Case
1

"BOATMAN" SAFETY KIT**Boats Up to 19 Feet**

- (2) Dock Lines - $\frac{3}{8}$ " x 20'
- (1) Anchor - #7 Utility
- (1) Fire Extinguisher - 5BC
- (1) Anchor Chain - $\frac{1}{4}$ " x 4' Galv.
With (2) shackles $\frac{5}{16}$ "
- (1) 12 Gauge Gun w/4 Red Shells

Item#
45101

- (1) Anchor Line - $\frac{3}{8}$ " x 100'
- (4) Life Jackets
- (1) Signal Horn Kit
- (1) Foam Cushion
- (1) Coast Guard pamphlet
- (1) Safety Gear Bag

Case
1

"SPORTSMAN A" SAFETY KIT**Boats 20 to 25 Feet**

- (2) Dock Lines - $\frac{3}{8}$ " x 20'
- (1) Anchor - #10 Utility
- (1) Fire Extinguisher - 10BC
- (1) Anchor Chain - $\frac{1}{4}$ " x 4' Galv. with (2) shackles $\frac{5}{16}$ "
- (1) 12 Gauge Gun with (4) Red Shells

Item#
45151

- (1) Anchor Line - $\frac{3}{8}$ " x 150'
- (4) Life Jackets
- (1) Signal Horn Kit
- (1) Safety Gear Bag
- (1) Coast Guard pamphlet
- (1) Foam Cushion

Case
1



"SPORTSMAN B" SAFETY KIT



Boats 20 to 25 Feet

- (2) Dock Lines - 1/2" x 20'
- (1) Anchor - 8lb. Deluxe
- (1) Fire Extinguisher - 10BC
- (1) Anchor Chain - 1/4" x 4' Galv.with (3) shackles 5/16"
- (1) 12 Gauge Gun with (4) Red Shells

- (1) Anchor Line - 1/2" x 150'
- (4) Life Jackets
- (1) Safety Gear Bag
- (1) Signal Horn Kit
- (1) Foam Cushion
- (1) Coast Guard pamphlet

Item#
45201

Case
1

"YACHTMAN A" SAFETY KIT



Boats 26 to 32 Feet

- (4) Dock Lines - 1/2" x 25'
- (1) Anchor - #15 Utility
- (2) Fire Extinguisher - 10BC
- (1) Anchor Chain - 5/16" x 5' PVC
- (1) Alert Flare
- (1) Anchor Line - 1/2" x 150'

- (6) Life Jackets
- (2) Anchor Shackle - 3/8"
- (1) Safety Gear Bag
- (1) Signal Horn Kit
- (1) Foam Cushion
- (1) Coast Guard pamphlet

Item#
45251

Case
1

"YACHTMAN B" SAFETY KIT



Boats 26 to 32 Feet

- (4) Dock Lines - 1/2" x 25'
- (1) Anchor - 13lb. Deluxe
- (2) Fire Extinguisher - 10BC
- (1) Anchor Chain - 5/16" x 5' PVC
- (1) Alert Flare
- (1) Anchor Line - 1/2" x 150'

- (6) Life Jackets
- (2) Anchor Shackle - 3/8"
- (1) Safety Gear Bag
- (1) Signal Horn Kit
- (1) Foam Cushion
- (1) Coast Guard pamphlet

Item#
45301

Case
1

"YACHTMAN C" SAFETY KIT



Boats 26 to 32 Feet

- (4) Dock Lines - 1/2" x 25'
- (6) Life Jackets
- (2) Fire Extinguisher - 10BC
- (1) Safety Gear Bag

- (1) Alert Flare
- (1) Signal Horn Kit
- (1) Foam Cushion
- (1) Coast Guard pamphlet

Item#
45351

Case
1



TYPE II LIFE VEST



Type II PFD. Fully U.S. Coast Guard Approved
PE foam filling. Designed specifically to provide minimum buoyancy and turn unconscious person face up in calm water situations.

Item#	Size	Weight	Chest	Color	Case
86020					
86040	Child	30 - 50 lbs.	-	Yellow	12
86060	Youth	50 - 90 lbs.	-	Yellow	12
86020	Adult	90 lbs & up	30" - 52"	Yellow	12
86080	Adult XL	90 lbs. & up	40" - 60"	Yellow	12
85540	Child	30 - 50 lbs.	-	Orange	12
85560	Youth	50 - 90 lbs.	-	Orange	12
85520	Adult	90 lbs & up	30" - 52"	Orange	12
85580	Adult XL	90 lbs. & up	40" - 60"	Orange	12
86030	Adult	90 lbs. & up	30" - 52"	Camo	12
86090	Adult XL	90 lbs & up	40" - 60"	Camo	12

TYPE I COMMERCIAL OFFSHORE VEST



Classified/graded for use on Commercial Vessels. Universal sizing. Designed to keep unconscious wearer face up. Highly visible color with Solas reflective tape and approved hardware.

Coast Guard Type: USCG Type I
Flotation: Soft Foam
Shell: Durable 100 % polyester
Closure: 1" nylon belt w/ D-ring and clip

Item#	Size	Weight	Color	Case
85910	Youth	Under 90 lb.	Flouro Orange	6
85900	Adult	Over 90 lb.	Flouro Orange	6

TYPE I COMMERCIAL OFFSHORE JACKET



Classified/graded for use on Commercial Vessels. Universal sizing. Comfortable design for easy wearing. Designed to keep unconscious wearer face up. Highly visible color with Solas reflective tape and approved hardware.

Coast Guard Type: USCG Type I
Flotation: Soft Foam
Shell: Durable 100 % polyester
Closure: 1" Adjustable chest strap to keep vest from riding up and 1" nylon waist belt w/ D-ring and clip

Item#	Size	Weight	Color	Case
85940	Youth	Under 90 lb.	Flouro Orange	6
85930	Adult	Over 90 lb.	Flouro Orange	6

RE-ARMING KITS



USCG Approved kit and components.

Manual Kit: CO2 cylinder with 1/2" thread
(1) Halkey-Roberts Green Indicator Pin

Automatic Kit: CO2 cylinder with 1/2" thread
(1) Halkey-Roberts Green Indicator Pin
(1) Halkey-Roberts Yellow Bobbin

Item#	Description	Size	Fits	Case
85700	Manual	24 g	85800, 85600	5
85740	Automatic	24 g	85810, 85610	5
85710	Manual	33 g	85830, 85630	5
85750	Automatic	33 g	85860, 85840, 85640, 85660	5

TYPE V INFLATABLE PFD



Light weight and low profile for safety and peace of mind. This PFD remains cool while wearing in heat of the summer and can be worn over wet weather clothing in winter. Can be used for recreational boating, fishing, stand up paddle boarding, sailing, and hunting. The 33 gram models feature a zipper pouch for storage, Shipped not active. Internal pocket with CO2 Cylinder.

Note: Manual / Automatic PFD inflates upon immersion in the water or when the wearer pulls the inflation handle.

Coast Guard Type: USCG Type V.
(has Type III Performance)
Flotation: Co2 Cylinder - Halkey Roberts mechanisms
Shell: Durable 100 % polyester outer
Closure: 1.5" nylon belt w/ buckle

- Weight: 107 lbs. & up
- Chest: 30" - 52"

Item#	Model	Description	Color	Case
85800	24g / 100N	Manual	Yellow	3
85830	33g / 150N	Manual	Red/Black	3
85810	24g / 100N	Man/Auto	Blue	3
85840	33g / 150N	Man/Auto	Blue/Black	3
85860	33g / 150N	Man/Auto	Camo	3

Repl. Parts	Description	Size	Fits	Case
85700	Manual	24 g	85800, 85600	5
85740	Automatic	24 g	85810, 85610	5
85750	Automatic	33 g	85860, 85840, 85640, 85660	5
85710	Manual	33 g	85830, 85630	5

TYPE V INFLATABLE PFD - CANADA ONLY



Light weight and low profile for safety and peace of mind. This PFD remains cool while wearing in heat of the summer and can be worn over wet weather clothing in winter. Can be used for recreational boating, fishing, stand up paddle boarding, sailing, and hunting. The 33 gram models feature a zipper pouch for storage, Shipped not active. Internal pocket with CO2 Cylinder.

Note: Manual / Automatic PFD inflates upon immersion in the water or when the wearer pulls the inflation handle.

Coast Guard Type: CCG Type V. (has Type III Performance)
Flotation: Co2 Cylinder-Halkey Roberts mechanisms
Shell: Durable 100 % polyester outer
Closure: 1.5" nylon belt w/ buckle

- Weight: 48.5 kg & up
- Chest: 76 cm - 132 cm

Item#	Model	Description	Color	Case
85600	24g / 100N	Manual	Yellow	3
85630	33g / 150N	Manual	Red/Black	3
85610	24g / 100N	Man/Auto	Blue	3
85640	33g / 150N	Man/Auto	Blue/Black	3
85660	33g / 150N	Man/Auto	Camo	3

Repl. Parts	Description	Size	Fits	Case
85700	Manual	24 g	85800, 85600	5
85740	Automatic	24 g	85810, 85610	5
85750	Automatic	33 g	85860, 85840, 85640, 85660	5
85710	Manual	33 g	85830, 85630	5

TYPE II DELUXE CHILDRENS VEST



Vest has a pop-up pillow for added head support and a 1" Grab Strap for quick recovery. The foam filling is lightweight so it doesn't hinder a child's mobility.

- **Made in the USA.**
- **Coast Guard Type:** USCG Type II
- **Flotation Material:** Lightweight foam
- **Shell:** 200 Denier oxford fabric

- **Closure:** Infant: Zipper front Infant & Child: 1" Nylon leg strap Youth: 1" Adjustable chest strap to keep vest from riding up

Item#	Size	Weight	Chest	Case
86100	Infant	Less than 30 lbs.	-	12
86110	Child	Less than 50 lbs.	-	10
86120	Youth	50 - 90 lbs.	25" - 29"	6

TYPE III DELUXE DELUXE CHILD/YOUTH VEST



Vests have an adjustable chest strap to keep vest from riding up. The foam filling is lightweight so it doesn't hinder a child's mobility. Color: Yellow/Red.

- **Made in the USA.**
- **Coast Guard Type:** USCG Type III
- **Flotation Material:** Lightweight foam
- **Shell:** 200 Denier oxford fabric
- **Closure:** 1" Nylon. (2) belts & (1) chest strap. Child: leg strap for added safety

Item#	Size	Weight	Chest	Case
86130	Child	30 - 50 lbs.	20" - 25"	10
86170	Youth	50 - 90 lbs.	24" - 29"	8

TYPE III GENERAL PURPOSE VEST



Provides safety and comfort for all types of water activities.

- **Coast Guard Type:** USCG Type III (Infant: Type II)
- **Flotation Material:** Lightweight foam
- **Shell:** 150 Denier polyester fabric
- **Closure:** 1" Nylon webbing. Equipped with grab handle (Infant) and leg strap for added safety (Infant & Child)

Item#	Size	Weight	Chest	Color	Case
86500	Infant	Less than 30 lbs.	-	Yellow	6
86510	Child	30 - 50 lbs.	-	Yellow	6
86520	Youth	50 - 90 lbs.	25" - 29"	Yellow	6
86530	Adult Universal	90 lbs. & Up	30" - 52"	Yellow	6
86540	Adult XL	90 lbs. & Up	40" - 62"	Yellow	6
86550	Adult Universal	90 lbs. & Up	30" - 52"	Camo	6
86560	Adult XL	90 lbs. & Up	40" - 62"	Camo	6

TYPE III BOAT VEST



Vests have adjustable belts for secure fit and are filled with a lightweight durable foam that doesn't hinder mobility. Adult sizes have large armholes for greater range of motion and open-sided styling for adjustability. **Made in the USA.**

- **Coast Guard Type:** USCG Type III
- **Flotation Material:** Lightweight foam
- **Shell:** 200 Denier oxford fabric
- **Closure:** 1" Nylon
- Child: (1) belt, (1) chest strap & leg strap for added safety
- Youth: (1) belt & (1) chest strap
- Adult: (2) belts & (1) chest strap

Item#	Size	Weight	Chest	Color	Case
86140	Child	30 - 50 lbs.	20" - 25"	Bl/Yel	10
86180	Youth	50 - 90 lbs.	25" - 29"	Bl/Yel	8
86220	Univ.	90 lbs. & Up	30" - 52"	Bl/Yel	5
86240	XL	90 lbs. & Up	40" - 60"	Bl/Yel	5
86150	Child	30 - 50 lbs.	20" - 25"	Org/Yel	10
86190	Youth	50 - 90 lbs.	25" - 29"	Org/Yel	8
86230	Univ.	90 lbs. & Up	30" - 52"	Org/Yel	5
86250	XL	90 lbs. & Up	40" - 60"	Org/Yel	5

DOG LIFE VEST



Provides buoyancy and comfort for man's best friend.

- **Flotation Material:** Polyethylene foam
- **Shell:** 150 Denier polyester fabric
- **Closure:** 1" Nylon. (2) belts

Item#	Size	Weight	Color	Case
86300	XXS	Up to 6 lbs.	Yellow	6
86310	XS	7 to 15 lbs.	Yellow	6
86320	S	15 to 20 lbs.	Yellow	6
86330	M	20 to 50 lbs.	Yellow	6
86340	L	50 to 90 lbs.	Yellow	6
86350	XL	Over 90 lbs.	Yellow	6
86260	XXS	Up to 6 lbs.	Blue Polka Dot	6
86270	XS	7 to 15 lbs.	Blue Polka Dot	6
86280	S	15 to 20 lbs.	Blue Polka Dot	6
86360	XXS	Up to 6 lbs.	Pink Polka Dot	6
86370	XS	7 to 15 lbs.	Pink Polka Dot	6
86380	S	15 to 20 lbs.	Pink Polka Dot	6
86470	S	15 to 20 lbs.	Camo	6
86480	M	20 to 50 lbs.	Camo	6
86490	L	50 to 90 lbs.	Camo	6



TYPE III DELUXE 4-BELT SKI VEST



This dual sized vest is great for skiing, boating, fishing or relaxing on the water. Lightweight, durable foam contours to your body and doesn't hinder mobility. Adjustable belts and chest strap to keep vest from riding up or shifting.

Made in the USA.

- **Coast Guard Type:** USCG Type III
- **Flotation Material:** Lightweight foam
- **Shell:** 200 Denier oxford fabric
- **Closure:** 1½" Nylon

Item#	Size	Weight	Chest	Case
86410	S/M	90 lbs. & Up	32" to 40"	5
86420	L/XL	90 lbs. & Up	40" to 52"	5
86430	XXL/XXXL	90 lbs. & Up	50" to 60"	5

WATER SKI ROPE



This product is designed to tow one (1) person, maximum rider weight 225 lbs.

- **Handle:** EVA, 15" wide - for firm grip
- **Line Material / Strand:** Polypropylene, 16 strand (5/16" Diameter)

Item#	Length	Sections	Tensile Strength	Case
86821	75'	1	2,050 lbs.	6

DELUXE SKI ROPE



Color may vary. This product is designed to tow one (1) person, maximum rider weight 225 lbs.

- **Handle:** Padded, 12" wide - for firm grip
- **Line Material / Strand:** Hollow braid polypropylene, 16 strand (5/16" Diameter)

Item#	Length	Sections	Tensile Strength	Case
86601	75'	1	2,050 lbs.	12

4-SECTION WATER SKI ROPE



This product is designed to tow one (1) person, maximum rider weight 225 lbs.

- **Handle:** EVA, 15" wide - for firm grip
- **Line Material / Strand:** Polypropylene, 16 strand (5/16" Diameter)

Item#	Length	Sections	Tensile Strength	Case
86811	75'	4 Color Coded (5', 40', 10', 10', 10')	2,050 lbs.	6

TOURNAMENT SKI TOW ROPE



Meets AWSA. Color may vary. This product is designed to tow one (1) person, maximum rider weight 225 lbs.

- **Handle:** Cushion soft, 12" wide - for firm grip
- **Line Material / Strand:** Polypropylene, 16 strand (5/16" Diameter)

Item#	Length	Sections	Tensile Strength	Case
86621	75'	1	2,050 lbs.	12

COMPETITION SKI TOW ROPE



Meets AWSA. Color may vary. This product is designed to tow one (1) person, maximum rider weight 225 lbs.

- **Handle:** One-piece molded rubber locked spliced, 12" wide for firm grip
- **Line Material / Strand:** Polypropylene, 16 strand (5/16" Dia.)

Item#	Length	Sections	Tensile Strength	Case
86651	75'	1	2,050 lbs.	12

TOW ROPE - 1 RIDER



Meets AWSA. Color may vary. Designed to tow one (1) person, maximum rider weight 225 lbs. in an inflatable tube.

- **Line Material / Strand:** Polypropylene, 16 strand (5/16" Dia.), 2 looped ends. Quick connect hook to boat only.
- **Connection:** 6" Loop at end

Item#	Length	Sections	Tensile Strength	Case
86681	50'	1	2,375 lbs.	12

TOW ROPE - 2 RIDER



This product is designed to tow two (2) riders, maximum rider weight 340 lbs. Reusable storage keeper included.

- **Line Material / Strand:** 16 strand (5/16" Dia.)
- **Connection:** 6" Loop at end

Item#	Length	Sections	Tensile Strength	Case
86661	60'	2 (50' & 10')	3,000 lbs.	12

HEAVY DUTY TOW ROPE - 6 RIDER



Will accommodate up to 6 riders. Reusable storage keeper included.

- **Line Material / Strand:** 16 strand (5/16" Dia.)
- **Connection:** 6" Loop at end

Item#	Length	Sections	Tensile Strength	Case
86671	60'	1	6,000 lbs.	6

5-SECTION WAKEBOARD ROPE



Trick-Handle and Float included. This product is designed to tow one (1) person, maximum rider weight 225 lbs.

- **Handle:** EVA, 15" wide - for firm grip
- **Line Material / Strand:** Polypropylene, 16 strand (5/16" Diameter)

Item#	Length	Sections	Tensile Strength	Case
86801	75'	5 Color Coded (5', 55', 5', 5', 5')	2,050 lbs.	6

UNIVERSAL BOAT MIRROR



Black durable ABS housing with aluminum mounting bracket and stainless steel hardware. 360° swivel convex back coated aluminized mirror. Mounts on decks, frames and windshields. Easily adjustable to any position. Fasten with #10 screws (included).

Item#	Size	Fits	Case
79501	8" W x 4" H	Windshields up to 1" thick	20

SKI TOW



- Stainless steel
- Transom mount
- Nut and washer included
- 3/8" x 3" threaded legs

Item#	Size	Case
30101	2 3/8"	10

TOW HARNESS



8' or 12' usable rope tow harness. Helps improve towing and boat control. High impact plastic float pulley helps keep tow line away from propeller. Large snap hooks for quick attachment.

86721: Fits pontoon boats & boats with twin motors.

Item#	Size	Tow Capacity	Case
86701	3/8" x 8'	1,000 lbs.	12
86721	3/8" x 12'	1,000 lbs.	12

TOW HARNESS W/WIRE CABLE



8' usable cable length. Unique design molded high impact plastic float/pulley. Allows easy attachment of ski rope for better towing and boat control. Full 1/4" diameter vinyl jacketed steel cable. Large snap hooks for quick attachment to boat.

Item#	Size	Tow Capacity	Case
86711	1/4" x 8'	1,500 lbs.	12



HEX NUTS



Item#	Size	Bag	Case
18-8 Stainless Steel			
00597	4-40	100	10
00598	6-32	100	10
00599	8-32	100	10
00601	10-24	100	10
00603	10-32	100	10
00604	12-24	100	10
00606	1/4"-20	100	10
00607	5/16"-18	100	10
00608	3/8"-16	100	10
00609	7/16"-14	50	10
00611	1/2"-13	50	10
00613	5/8"-11	10	10
00614	3/4"-10	10	10
316 Stainless Steel			
01664	10-24	100	10
01665	10-32	100	10
01666	1/4"-20	100	10
01668	5/16"-18	100	10
01669	3/8"-16	100	10
01670	7/16"-14	50	10
01672	1/2"-13	50	10
01673	5/8"-11	10	10
01674	3/4"-10	10	10
01675	7/8"-9	1	10
01677	1"-8	1	10
(Metric) 18-8 Stainless			
01214	M4-.7	100	10
01216	M5-.8	100	10
01217	M6-1	100	10
01218	M8-1.25	50	10
01219	M10-1.5	25	10
01221	M12-1.75	25	10
Silicon Bronze			
01379	1/4"-20	100	10
01381	5/16"-18	100	10
01383	3/8"-16	100	10
01384	1/2"-13	25	10
Hot Dipped Galvanized			
01531	3/8"-16	100	1
01533	1/2"-13	100	1

NYLON INSERT LOCKNUTS - STAINLESS



Item#	Size	Bag	Case
00616	4-40	100	10
00617	6-32	100	10
00618	8-32	100	10
00619	10-24	100	10
00621	10-32	100	10
00623	12-24	100	10
00624	1/4"-20	100	10
00626	5/16"-18	50	10
00627	3/8"-16	50	10
00628	7/16"-14	25	10
00629	1/2"-13	25	10
00631	5/8"-11	10	10
00633	3/4"-10	10	10
Metric			
01223	M4-.7	100	10
01224	M5-.8	100	10
01226	M6-1	100	10
01227	M8-1.25	50	10
01228	M10-1.5	25	10
01229	M12-1.75	25	10

ACORN CAP NUT



Item#	Size	Bag	Case
00581	6-32	100	10
00583	8-32	100	10
00584	10-24	100	10
00586	10-32	100	10
00587	12-24	100	10
00588	1/4"-20	100	10
00589	5/16"-18	50	10
00591	3/8"-16	50	10
00593	7/16"-14	10	10
00594	1/2"-13	10	10
00596	5/8"-11	1	10

MARINE FASTENERS

WITH A DIFFERENCE



Large Selection of Stainless Steel Fasteners Including Metric and Hard To Find Items





PHILLIPS BARREL NUTS - TRUSS HEAD

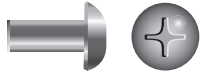

18-8 Stainless Steel.

Item#	Size	Bag	Case
00573	6-32 x 3/8"	25	10
00574	8-32 x 3/8"	25	10
00576	10-24 x 1/2"	25	10
00577	1/4-20 x 5/8"	25	10
00578	3/16-18 x 3/4"	10	10
00579	3/8-16 x 3/4"	10	10

TEE NUT - STAINLESS



18-8 Stainless Steel.

Item#	Size	Bag	Case
00634	10-24	25	10
00636	1/4"-20	25	10
00637	5/16"-18	10	10
00638	3/8"-16	10	10

THREADED INSERTS

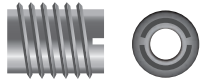

316 Stainless Steel.

Item#	Size	Bag	Case
01098	10-24	25	10
01099	1/4"-20	25	10
01101	3/8"-16	10	10
01103	5/16"-18	10	10

WING NUTS



18-8 Stainless Steel.

Item#	Size	Bag	Case
01104	10-24	100	10
01106	1/4"-20	100	10
01107	5/16"-18	50	10
01108	3/8"-16	50	10

STAINLESS FENDER WASHERS



Item#	Size	OD	Bag	Case
18-8 Stainless Steel				
00977	#6	3/4"	100	10
00978	#8	3/4"	100	10
00979	#10	3/4"	100	10
00981	#10	1"	100	10
00983	1/4"	1"	100	10
00984	1/4"	1 1/4"	100	10
00986	1/4"	1 1/2"	100	10
00987	5/16"	1 1/2"	50	10
00988	3/8"	1 1/2"	50	10
00989	1/2"	2"	25	10
00991	5/8"	2"	10	10
316 Stainless Steel				
01697	1/4"	1"	100	10
01698	3/16"	1 1/2"	50	10

FLAT WASHERS

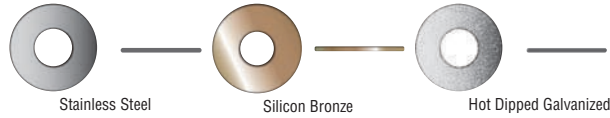

(A/N Style) = (Air Force/Navy) - code for a certain type of small outside diameter flat washer.

Item#	Size	OD	Bag	Case
316 Stainless				
00958	#4	5/16"	100	10
00959	#6	3/8"	100	10
00961	#8	3/8"	100	10
00963	#10	7/16"	100	10
00964	#10	3/16"	100	10
00966	#12	1/2"	100	10
01678	1/4"	5/8"	100	10
01691	1/4"	1 1/16"	100	10
01679	5/16"	3/4"	100	10
01693	3/16"	7/8"	100	10
01681	3/8"	7/8"	100	10
01694	3/8"	1"	100	10
01682	7/16"	1 1/8"	50	10
01683	1/2", .062 thick	1 1/4"	50	10
01695	1/2", .078 thick	1 1/4"	50	10
01685	3/16"	1"	50	10
01686	5/8"	1 1/2"	25	10
01687	3/4"	1 7/8"	25	10
01689	7/8"	2 1/4"	10	10
01699	1"	2"	10	10
01690	1"	2 1/2"	10	10
18-8 Stainless				
00967	1/4"	1 1/16"	100	10
00968	3/16"	7/8"	100	10
00969	3/8"	1"	100	10
00971	7/16"	1 1/8"	50	10
00973	1/2"	1 1/4"	50	10
00974	5/8"	1 1/2"	25	10
00976	3/4"	1 7/8"	25	10
00993	1/4"	1/2" (A/N Style)	100	10
00994	3/16"	3/16" (A/N Style)	100	10
00996	3/8"	3/8" (A/N Style)	100	10
00997	7/16"	3/4" (A/N Style)	50	10
00998	1/2"	7/8" (A/N Style)	50	10
00999	5/8"	1 3/16" (A/N Style)	25	10
01001	3/4"	1 3/16" (A/N Style)	25	10
316 Stainless (Metric)				
01231	M4	9 mm	100	10
01233	M5	10 mm	100	10
01234	M6	12 mm	100	10
01236	M8	16 mm	100	10
01237	M10	20 mm	50	10
01238	M12	24 mm	50	10
Silicon Bronze				
01386	1/4"	1 1/16"	100	10
01387	5/16"	7/8"	100	10
01388	3/8"	1"	100	10
01389	1/2"	1 1/4"	50	10
Hot Dipped Galvanized				
01526	1/4"	3/4"	100	1
01527	5/16"	7/8"	100	1
01528	1"	1"	100	1
01529	1/2"	1 3/8"	100	1

COUNTERSUNK FINISHING WASHER - STAINLESS



Item#	Size	Material	Bag	Case
00948	#4	316 Stainless Steel	100	10
00949	#6	316 Stainless Steel	100	10
00951	#8	316 Stainless Steel	100	10
00953	#10	316 Stainless Steel	100	10
00954	#12	316 Stainless Steel	100	10
00956	1/4"	316 Stainless Steel	100	10
00957	5/16"	18-8 Stainless Steel	50	10

NYLON FLAT WASHERS



Item#	Size	Bag	Case
01026	#6	100	10
01027	#8	100	10
01028	#10	100	10
01029	1/4"	100	10
01031	5/16"	100	10
01033	3/8"	100	10
01034	1/2"	50	10
01036	5/8"	25	10

LOCK WASHERS



Item#	Size	Bag	Case
316 Stainless			
01003	#4	100	10
01004	#6	100	10
01006	#8	100	10
01007	#10	100	10
01008	#12	100	10
01009	1/4"	100	10
01011	5/16"	100	10
01013	3/8"	100	10
01701	7/16"	50	10
01702	1/2"	50	10
01703	5/8"	25	10
01705	3/4"	25	10
18-8 Stainless			
01014	7/16"	50	10
01016	1/2"	50	10
01017	5/8"	25	10
01018	3/4"	25	10
(Metric) 316 Stainless			
01239	M4	100	10
01241	M5	100	10
01243	M6	100	10
01244	M8	100	10
01246	M10	50	10
01247	M12	50	10
Silicon Bronze			
01391	1/4"	100	10
01393	5/16"	100	10
01394	3/8"	100	10
01396	1/2"	50	10

STAINLESS EXTERNAL TOOTH LOCK WASHERS



Item#	Size	Bag	Case
01019	#10	100	10
01021	1/4"	100	10
01023	5/16"	100	10
01024	3/8"	100	10

CAP SCREWS - HEX HEAD



Item#	Size	Bag	Case
18-8 Stainless Steel			
00001	1/4-20 x 1/2"	100	10
00003	1/4-20 x 5/8"	100	10
00004	1/4-20 x 3/4"	100	10
00006	1/4-20 x 1"	100	10
00007	1/4-20 x 1 1/4"	10	10
00008	1/4-20 x 1 1/2"	50	10
00009	1/4-20 x 1 3/4"	50	10

18-8 Stainless Steel			
00011	1/4-20 x 2"	50	10
00013	1/4-20 x 2 1/2"	25	10
00014	1/4-20 x 3"	25	10
00016	1/4-20 x 3 1/2"	25	10
00017	1/4-20 x 4"	25	10
00018	1/4-20 x 4 1/2"	10	10
00019	1/4-20 x 5"	10	10
00021	1/4-20 x 6"	10	10
00023	5/16-18 x 1 1/2"	25	10
00024	5/16-18 x 5/8"	25	10
00026	5/16-18 x 3/4"	25	10
00027	5/16-18 x 1"	25	10
00028	5/16-18 x 1 1/4"	25	10
00029	5/16-18 x 1 1/2"	25	10
00031	5/16-18 x 1 3/4"	25	10
00033	5/16-18 x 2"	25	10
00034	5/16-18 x 2 1/2"	10	10
00036	5/16-18 x 3"	10	10
00037	5/16-18 x 3 1/2"	10	10
00038	5/16-18 x 4"	10	10
00039	5/16-18 x 4 1/2"	5	10
00041	5/16-18 x 5"	5	10
00043	5/16-18 x 6"	5	10
00044	3/8-16 x 3/4"	25	10
00046	3/8-16 x 1"	25	10
00047	3/8-16 x 1 1/4"	25	10
00048	3/8-16 x 1 1/2"	25	10
00049	3/8-16 x 1 3/4"	25	10
00051	3/8-16 x 2"	25	10
00053	3/8-16 x 2 1/2"	10	10
00054	3/8-16 x 3"	10	10
00056	3/8-16 x 3 1/2"	10	10
00057	3/8-16 x 4"	10	10
00058	3/8-16 x 4 1/2"	5	10
00059	3/8-16 x 5"	5	10
00061	3/8-16 x 6"	5	10
00063	7/16-14 x 3/4"	10	10
00064	7/16-14 x 1"	10	10
00066	7/16-14 x 1 1/4"	10	10
00067	7/16-14 x 1 1/2"	10	10
00068	7/16-14 x 1 3/4"	10	10
00069	7/16-14 x 2"	10	10
00071	7/16-14 x 2 1/2"	10	10
00073	7/16-14 x 3"	10	10
00074	7/16-14 x 3 1/2"	5	10
00076	7/16-14 x 4"	5	10
00077	1/2-13 x 3/4"	10	10
00078	1/2-13 x 1"	10	10
00079	1/2-13 x 1 1/4"	10	10
00081	1/2-13 x 1 1/2"	10	10
00083	1/2-13 x 1 3/4"	10	10
00084	1/2-13 x 2"	10	10
00086	1/2-13 x 2 1/2"	10	10
00087	1/2-13 x 3"	10	10
00088	1/2-13 x 3 1/2"	5	10
00089	1/2-13 x 4"	5	10
00091	1/2-13 x 4 1/2"	5	10
00093	1/2-13 x 5"	5	10
00094	1/2-13 x 6"	5	10
01597	1/2-13 x 7"	1	10
01598	1/2-13 x 8"	1	10
01599	1/2-13 x 10"	1	10
00096	5/8-11 x 1"	1	10
00097	5/8-11 x 1 1/4"	1	10
00098	5/8-11 x 1 1/2"	1	10
00099	5/8-11 x 1 3/4"	1	10
00101	5/8-11 x 2"	1	10
00103	5/8-11 x 2 1/4"	1	10
00104	5/8-11 x 2 1/2"	1	10
00106	5/8-11 x 3"	1	10
00107	5/8-11 x 3 1/2"	1	10
00108	5/8-11 x 4"	1	10
00109	5/8-11 x 5"	1	10
00111	5/8-11 x 6"	1	10
316 Stainless Steel			
01601	1/4"-20 x 1/2"	100	10
01603	1/4"-20 x 3/4"	100	10
01604	1/4"-20 x 1"	100	10
01606	1/4"-20 x 1 1/4"	50	10
01607	1/4"-20 x 1 1/2"	50	10
01608	1/4"-20 x 2"	50	10
01609	1/4"-20 x 2 1/2"	25	10
01611	1/4"-20 x 2 3/4"	25	10



316 Stainless Steel			
01612	1/4"-20 x 3"	25	10
01613	1/4"-20 x 4"	25	10
01615	5/16"-18 x 3/4"	25	10
01616	5/16"-18 x 1"	25	10
01617	5/16"-18 x 1 1/4"	25	10
01619	5/16"-18 x 1 1/2"	25	10
01620	5/16"-18 x 1 3/4"	25	10
01621	5/16"-18 x 2"	25	10
01623	5/16"-18 x 2 1/4"	10	10
01624	5/16"-18 x 2 1/2"	10	10
01625	5/16"-18 x 2 3/4"	10	10
01627	5/16"-18 x 3"	10	10
01628	5/16"-18 x 3 1/2"	10	10
01629	5/16"-18 x 4"	10	10
01631	3/8"-16 x 1"	25	10
01632	3/8"-16 x 1 1/4"	25	10
01633	3/8"-16 x 1 1/2"	25	10
01635	3/8"-16 x 2"	25	10
01636	3/8"-16 x 2 1/2"	10	10
01637	3/8"-16 x 3"	10	10
01638	3/8"-16 x 3 1/2"	10	10
01640	3/8"-16 x 4"	10	10
01641	3/8"-16 x 4 1/2"	5	10
01642	3/8"-16 x 5"	5	10
01644	3/8"-16 x 6"	5	10
01645	1/2"-13 x 1"	10	10
01646	1/2"-13 x 1 1/4"	10	10
01648	1/2"-13 x 1 1/2"	10	10
01649	1/2"-13 x 2"	10	10
01650	1/2"-13 x 2 1/4"	10	10
01652	1/2"-13 x 2 1/2"	10	10
01653	1/2"-13 x 3"	10	10
01654	1/2"-13 x 3 1/2"	5	10
01656	1/2"-13 x 4"	5	10
01657	1/2"-13 x 4 1/2"	5	10
01658	1/2"-13 x 5"	5	10
01660	1/2"-13 x 6"	5	10
01661	1/2"-13 x 7"	1	10
01662	1/2"-13 x 8"	1	10
Metric			
01248	M4-.7 x 10	50	10
01249	M4-.7 x 20	50	10
01251	M4-.7 x 25	50	10
01253	M4-.7 x 30	50	10
01254	M4-.7 x 40	50	10
01256	M5-.8 x 10	50	10
01257	M5-.8 x 20	50	10
01258	M5-.8 x 25	50	10
01259	M5-.8 x 30	50	10
01261	M5-.8 x 35	50	10
01263	M5-.8 x 40	50	10
01264	M6-1 x 10	50	10
01266	M6-1 x 16	50	10
01267	M6-1 x 20	50	10
01268	M6-1 x 25	50	10
01269	M6-1 x 30	50	10
01271	M6-1 x 35	25	10
01273	M6-1 x 40	25	10
01274	M6-1 x 45	25	10
01276	M6-1 x 50	25	10
01277	M6-1 x 60	10	10
01278	M6-1 x 80	1	10
01279	M8-1.25 x 20	25	10
01281	M8-1.25 x 25	25	10
01283	M8-1.25 x 30	25	10
01284	M8-1.25 x 35	25	10
01286	M8-1.25 x 40	25	10
01287	M8-1.25 x 45	25	10
01288	M8-1.25 x 50	25	10
01289	M8-1.25 x 60	10	10
01291	M8-1.25 x 80	1	10
01293	M8-1.25 x 100	1	10
01294	M10-1.5 x 25	10	10
01296	M10-1.5 x 30	10	10
01297	M10-1.5 x 35	10	10
01298	M10-1.5 x 40	10	10
01299	M10-1.5 x 45	10	10
01301	M10-1.5 x 50	10	10
01303	M10-1.5 x 60	10	10
01304	M10-1.5 x 80	1	10
01306	M12-1.75 x 25	1	10
01307	M12-1.75 x 30	1	10
01308	M12-1.75 x 35	1	10

Metric			
01309	M12-1.75 x 40	1	10
01311	M12-1.75 x 45	1	10
01313	M12-1.75 x 50	1	10
01314	M12-1.75 x 60	1	10
01316	M12-1.75 x 80	1	10

CARRIAGE BOLTS

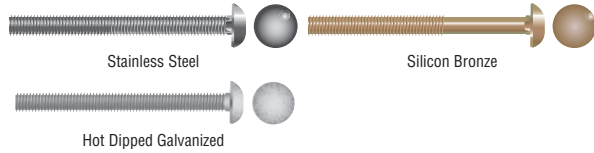

Item#	Size	Bag	Case
18-8 Stainless			
00113	1/4"-20 x 1"	25	10
00114	1/4"-20 x 1 1/2"	25	10
00116	1/4"-20 x 2"	25	10
00117	1/4"-20 x 2 1/2"	25	10
00118	1/4"-20 x 3"	25	10
00119	1/4"-20 x 3 1/2"	10	10
00121	1/4"-20 x 4"	10	10
00123	1/4"-20 x 5"	10	10
00124	1/4"-20 x 6"	10	10
00126	5/16"-18 x 1"	25	10
00127	5/16"-18 x 1 1/2"	25	10
00128	5/16"-18 x 2"	25	10
00129	5/16"-18 x 2 1/2"	10	10
00131	5/16"-18 x 3"	10	10
00133	5/16"-18 x 3 1/2"	10	10
00134	5/16"-18 x 4"	10	10
00136	5/16"-18 x 5"	5	10
00137	5/16"-18 x 6"	5	10
00138	3/8"-16 x 1 1/2"	25	10
00139	3/8"-16 x 2"	25	10
00141	3/8"-16 x 2 1/2"	10	10
00143	3/8"-16 x 3"	10	10
00144	3/8"-16 x 3 1/2"	10	10
00146	3/8"-16 x 4"	10	10
00147	3/8"-16 x 5"	5	10
00148	3/8"-16 x 6"	5	10
00149	1/2"-13 x 1 1/2"	5	10
00151	1/2"-13 x 2"	5	10
00153	1/2"-13 x 2 1/2"	5	10
00154	1/2"-13 x 3"	5	10
00156	1/2"-13 x 3 1/2"	1	10
00157	1/2"-13 x 4"	1	10
00158	1/2"-13 x 5"	1	10
00159	1/2"-13 x 6"	1	10
Silicon Bronze			
01477	1/4"-20 x 2"	25	10
01478	1/4"-20 x 2 1/2"	25	10
01479	1/4"-20 x 3"	25	10
01481	1/4"-20 x 3 1/2"	10	10
01483	1/4"-20 x 4"	10	10
01484	1/4"-20 x 5"	5	10
01486	1/4"-20 x 6"	5	10
01487	5/16"-18 x 2"	10	10
01488	5/16"-18 x 2 1/2"	10	10
01489	5/16"-18 x 3"	10	10
01491	5/16"-18 x 3 1/2"	10	10
01493	5/16"-18 x 4"	10	10
01494	5/16"-18 x 5"	5	10
01496	5/16"-18 x 6"	5	10
01559	3/8"-16 x 2 1/2"	10	10
01497	3/8"-16 x 3"	10	10
01498	3/8"-16 x 3 1/2"	10	10
01499	3/8"-16 x 4"	10	10
01501	3/8"-16 x 4 1/2"	5	10
01503	3/8"-16 x 5"	5	10
01504	3/8"-16 x 6"	5	10
Hot Dipped Galvanized			
01534	3/8"-16 x 3"	50	1
01536	3/8"-16 x 4"	25	1
01537	3/8"-16 x 5"	25	1
01538	1/2"-13 x 3"	25	1
01539	1/2"-13 x 4"	25	1
01541	1/2"-13 x 5"	10	1



SLOTTED STRUT BOLT - FLAT HEAD



- Silicon Bronze—alloy made up of 95-98% copper plus a small amount of silicon added for strength
- Full body
- Used extensively in marine running gear, including struts and rudder ports
- Highly resistant to seawater corrosion

Item#	Size	Bag	Case
01543	3/8-16 x 3"	1	10
01544	3/8-16 x 4"	1	10
01546	3/8-16 x 5"	1	10
01547	3/8-16 x 6"	1	10
01548	1/2-13 x 3"	1	10
01549	1/2-13 x 4"	1	10
01551	1/2-13 x 5"	1	10
01553	1/2-13 x 6"	1	10
01554	1/2-13 x 8"	1	10

LAG SCREWS



Item#	Size	Bag	Case
18-8 Stainless			
00161	1/4 x 1"	25	10
00163	1/4 x 1 1/2"	25	10
00164	1/4 x 2"	25	10
00166	1/4 x 2 1/2"	25	10
00167	1/4 x 3"	25	10
00168	1/4 x 3 1/2"	10	10
00169	1/4 x 4"	10	10
00171	1/4 x 5"	5	10
00173	5/16 x 1"	25	10
00174	5/16 x 1 1/2"	25	10
00176	5/16 x 2"	25	10
00177	5/16 x 2 1/2"	10	10
00178	5/16 x 3"	10	10
00179	5/16 x 3 1/2"	10	10
00181	5/16 x 4"	10	10
00183	5/16 x 5"	5	10
00184	3/8 x 1"	25	10
00186	3/8 x 1 1/2"	25	10
00187	3/8 x 2"	25	10
00188	3/8 x 2 1/2"	10	10
00189	3/8 x 3"	10	10
00191	3/8 x 3 1/2"	10	10
00193	3/8 x 4"	10	10
00194	3/8 x 5"	5	10
00196	3/8 x 6"	5	10
00197	1/2 x 1 1/2"	5	10
00198	1/2 x 2"	5	10
00199	1/2 x 2 1/2"	5	10
00201	1/2 x 3"	5	10
00203	1/2 x 3 1/2"	1	10
00204	1/2 x 4"	1	10
00206	1/2 x 5"	1	10
00207	1/2 x 6"	1	10
Hot Dipped Galvanized			
01506	1/4 x 2"	75	1
01507	1/4 x 3"	50	1
01508	1/4 x 4"	50	1
01509	5/16 x 1 1/2"	100	1
01511	5/16 x 2"	100	1
01513	5/16 x 3"	50	1
01514	5/16 x 4"	50	1
01516	5/16 x 5"	50	1
01517	3/8 x 1 1/2"	50	1
01518	3/8 x 2"	50	1
01519	3/8 x 3"	25	1
01521	3/8 x 4"	25	1
01523	3/8 x 5"	25	1
01524	3/8 x 6"	25	1

PHILLIPS TAPPING SCREWS - FLAT HEAD



18-8 Stainless Steel.

Item#	Size	Bag	Case
00678	#2 x 3/8"	100	10
00679	#2 x 1/2"	100	10
00681	#4 x 3/8"	100	10
00683	#4 x 1/2"	100	10
00684	#4 x 5/8"	100	10
00686	#4 x 3/4"	100	10
00687	#4 x 1"	100	10
00688	#6 x 3/8"	100	10
00689	#6 x 1/2"	100	10
00691	#6 x 5/8"	100	10
00693	#6 x 3/4"	100	10
00694	#6 x 1"	100	10
00696	#6 x 1 1/4"	100	10
00697	#6 x 1 1/2"	100	10
00698	#6 x 2"	50	10
00699	#8 x 3/8"	100	10
00701	#8 x 1/2"	100	10
00703	#8 x 5/8"	100	10
00704	#8 x 3/4"	100	10
00706	#8 x 1"	100	10
00707	#8 x 1 1/4"	100	10
00708	#8 x 1 1/2"	100	10
00709	#8 x 1 3/4"	50	10
00711	#8 x 2"	50	10
00713	#8 x 2 1/2"	50	10
00714	#8 x 3"	50	10
00716	#10 x 1/2"	100	10
00717	#10 x 3/8"	100	10
00718	#10 x 3/4"	100	10
00719	#10 x 1"	100	10
00721	#10 x 1 1/4"	100	10
00723	#10 x 1 1/2"	100	10
00724	#10 x 1 3/4"	50	10
00726	#10 x 2"	50	10
00727	#10 x 2 1/2"	50	10
00728	#10 x 3"	50	10
00729	#10 x 3 1/2"	25	10
00731	#10 x 4"	25	10
00733	#12 x 5/8"	100	10
00734	#12 x 3/4"	100	10
00736	#12 x 1"	100	10
00737	#12 x 1 1/4"	50	10
00738	#12 x 1 1/2"	50	10
00739	#12 x 1 3/4"	50	10
00741	#12 x 2"	50	10
00743	#12 x 2 1/2"	50	10
00744	#12 x 3"	50	10
00746	#12 x 3 1/2"	25	10
00747	#12 x 4"	25	10
00748	#14 x 3/4"	100	10
00749	#14 x 1"	100	10
00751	#14 x 1 1/4"	50	10
00753	#14 x 1 1/2"	50	10
00754	#14 x 1 3/4"	50	10
00756	#14 x 2"	50	10
00757	#14 x 2 1/2"	50	10
00758	#14 x 3"	50	10
00759	#14 x 3 1/2"	25	10
00761	#14 x 4"	25	10
00763	#18 x 1 1/2"	25	10
00764	#18 x 2"	25	10
00766	#18 x 2 1/2"	25	10
00767	#18 x 3"	25	10
00768	#18 x 4"	25	10





PHILLIPS TAPPING SCREWS - PAN HEAD



Item#	Size	Bag	Case
00841	#2 x 3/8"	100	10
00843	#2 x 1/2"	100	10
00844	#4 x 3/8"	100	10
00846	#4 x 1/2"	100	10
00847	#4 x 5/8"	100	10
00848	#4 x 3/4"	100	10
00849	#4 x 1"	100	10
00851	#6 x 3/8"	100	10
00853	#6 x 1/2"	100	10
00854	#6 x 5/8"	100	10
00856	#6 x 3/4"	100	10
00857	#6 x 1"	100	10
00858	#6 x 1 1/4"	100	10
00859	#6 x 1 1/2"	100	10
00861	#6 x 2"	50	10
00863	#8 x 3/8"	100	10
00864	#8 x 1/2"	100	10
00866	#8 x 5/8"	100	10
00867	#8 x 3/4"	100	10
00868	#8 x 1"	100	10
00869	#8 x 1 1/4"	100	10
00871	#8 x 1 1/2"	100	10
00873	#8 x 1 3/4"	50	10
00874	#8 x 2"	50	10
00876	#8 x 2 1/2"	50	10
00877	#8 x 3"	50	10
00878	#10 x 3/8"	100	10
00879	#10 x 1/2"	100	10
00881	#10 x 5/8"	100	10
00883	#10 x 3/4"	100	10
00884	#10 x 1"	100	10
00886	#10 x 1 1/4"	100	10
00887	#10 x 1 1/2"	100	10
00888	#10 x 1 3/4"	50	10
00889	#10 x 2"	50	10
00891	#10 x 2 1/2"	50	10
00893	#10 x 3"	50	10
00894	#12 x 1/2"	100	10
00896	#12 x 5/8"	100	10
00897	#12 x 3/4"	100	10
00898	#12 x 1"	100	10
00899	#12 x 1 1/4"	50	10
00901	#12 x 1 1/2"	50	10
00903	#12 x 1 3/4"	50	10
00904	#12 x 2"	50	10
00906	#12 x 2 1/2"	50	10
00907	#12 x 3"	50	10
00908	#14 x 3/4"	100	10
00909	#14 x 1"	100	10
00911	#14 x 1 1/4"	50	10
00913	#14 x 1 1/2"	50	10
00914	#14 x 1 3/4"	50	10
00916	#14 x 2"	50	10
00917	#14 x 2 1/2"	50	10
00918	#14 x 3"	50	10
00919	#14 x 3 1/2"	25	10

PHILLIPS TAPPING SCREWS - OVAL HEAD



Item#	Size	Bag	Case
00769	#4 x 3/8"	100	10
00771	#4 x 1/2"	100	10
00773	#4 x 5/8"	100	10
00774	#4 x 3/4"	100	10
00776	#4 x 1"	100	10
00777	#6 x 3/8"	100	10
00778	#6 x 1/2"	100	10
00779	#6 x 5/8"	100	10
00781	#6 x 3/4"	100	10
00783	#6 x 1"	100	10
00784	#6 x 1 1/4"	100	10
00786	#6 x 1 1/2"	100	10
00787	#6 x 2"	50	10
00788	#8 x 1/2"	100	10
00789	#8 x 5/8"	100	10
00791	#8 x 3/4"	100	10
00793	#8 x 1"	100	10
00794	#8 x 1 1/4"	100	10
00796	#8 x 1 1/2"	100	10
00797	#8 x 1 3/4"	50	10
00798	#8 x 2"	50	10
00799	#8 x 2 1/2"	50	10
00801	#8 x 3"	50	10
00803	#10 x 1/2"	100	10
00804	#10 x 5/8"	100	10
00806	#10 x 3/4"	100	10
00807	#10 x 1"	100	10
00808	#10 x 1 1/4"	100	10
00809	#10 x 1 1/2"	100	10
00811	#10 x 1 3/4"	50	10
00813	#10 x 2"	50	10
00814	#10 x 2 1/2"	50	10
00816	#10 x 3"	50	10
00817	#12 x 5/8"	100	10
00818	#12 x 3/4"	100	10
00819	#12 x 1"	100	10
00821	#12 x 1 1/4"	50	10
00823	#12 x 1 1/2"	50	10
00824	#12 x 1 3/4"	50	10
00826	#12 x 2"	50	10
00827	#12 x 2 1/2"	50	10
00828	#12 x 3"	50	10
00829	#14 x 3/4"	100	10
00831	#14 x 1"	100	10
00833	#14 x 1 1/4"	50	10
00834	#14 x 1 1/2"	50	10
00836	#14 x 1 3/4"	50	10
00837	#14 x 2"	50	10
00838	#14 x 2 1/2"	50	10
00839	#14 x 3"	50	10





PHILLIPS TAPPING SCREWS - TRUSS HEAD



Item#	Size	Bag	Case
00921	#6 x 1/2"	100	10
00923	#6 x 3/4"	100	10
00924	#6 x 1"	100	10
00926	#8 x 1/2"	100	10
00927	#8 x 3/4"	100	10
00928	#8 x 1"	100	10
00929	#8 x 1 1/4"	100	10
00931	#8 x 1 1/2"	100	10
00933	#10 x 1 1/2"	100	10
00934	#10 x 3/4"	100	10
00936	#10 x 1"	100	10
00937	#10 x 1 1/4"	100	10
00938	#10 x 1 1/2"	100	10
00939	#10 x 2"	50	10

SQUARE TAPPING SCREWS - FLAT HEAD



Item#	Size	Bag	Case
01138	#6 x 1/2"	100	10
01139	#6 x 3/4"	100	10
01141	#6 x 1"	100	10
01143	#8 x 1/2"	100	10
01144	#8 x 3/4"	100	10
01146	#8 x 1"	100	10
01147	#8 x 1 1/4"	100	10
01148	#8 x 1 1/2"	100	10
01149	#8 x 2"	50	10
01151	#10 x 3/4"	100	10
01153	#10 x 1"	100	10
01154	#10 x 1 1/4"	100	10
01156	#10 x 1 1/2"	100	10
01157	#10 x 2"	50	10
01158	#10 x 2 1/2"	50	10
01159	#12 x 1"	100	10
01161	#12 x 1 1/4"	50	10
01163	#12 x 1 1/2"	50	10
01164	#12 x 2"	50	10
01166	#12 x 2 1/2"	50	10
01167	#14 x 1"	100	10
01168	#14 x 1 1/4"	50	10
01169	#14 x 1 1/2"	50	10
01171	#14 x 2"	50	10
01173	#14 x 2 1/2"	50	10



SQUARE TAPPING SCREWS - PAN HEAD



Item#	Size	Bag	Case
01174	#6 x 1/2"	100	10
01176	#6 x 3/4"	100	10
01177	#6 x 1"	100	10
01178	#8 x 1/2"	100	10
01179	#8 x 3/4"	100	10
01181	#8 x 1"	100	10
01183	#8 x 1 1/4"	100	10
01184	#8 x 1 1/2"	100	10
01186	#8 x 2"	50	10
01187	#10 x 1/2"	100	10
01188	#10 x 3/4"	100	10
01189	#10 x 1"	100	10
01191	#10 x 1 1/4"	100	10
01193	#10 x 1 1/2"	100	10
01194	#10 x 2"	50	10
01196	#10 x 2 1/2"	50	10
01197	#12 x 3/4"	100	10
01198	#12 x 1"	100	10
01199	#12 x 1 1/4"	50	10
01201	#12 x 1 1/2"	50	10
01203	#12 x 2"	50	10
01204	#14 x 3/4"	100	10
01206	#14 x 1"	100	10
01207	#14 x 1 1/2"	50	10
01208	#14 x 2"	50	10

SQUARE TAPPING SCREWS - OVAL HEAD



Item#	Size	Bag	Case
01118	#6 x 1/2"	100	10
01119	#6 x 3/4"	100	10
01121	#6 x 1"	100	10
01123	#8 x 3/4"	100	10
01124	#8 x 1"	100	10
01126	#8 x 1 1/4"	100	10
01127	#8 x 1 1/2"	100	10
01128	#8 x 2"	50	10
01129	#10 x 3/4"	100	10
01131	#10 x 1"	100	10
01133	#10 x 1 1/4"	100	10
01134	#10 x 1 1/2"	100	10
01136	#10 x 2"	50	10
01137	#10 x 2 1/2"	50	10

PHILLIPS SELF DRILLING SCREWS - PAN HEAD



Item#	Size	Bag	Case
00941	#8 x 3/4"	100	10
00943	#8 x 1"	100	10
00944	#10 x 3/4"	100	10
00946	#10 x 1"	100	10
00947	#10 x 1 1/4"	100	10



PHILLIPS MACHINE SCREW - FLAT HEAD



18-8 Stainless Steel.

Item#	Size	Bag	Case
00208	4-40 x 1/2"	100	10
00209	4-40 x 3/4"	100	10
00211	4-40 x 1"	100	10
00213	6-32 x 3/8"	100	10
00214	6-32 x 1/2"	100	10
00216	6-32 x 5/8"	100	10
00217	6-32 x 3/4"	100	10
00218	6-32 x 1"	100	10
00219	6-32 x 1 1/4"	100	10
00221	6-32 x 1 1/2"	100	10
00223	6-32 x 2"	50	10
00224	8-32 x 3/8"	100	10
00226	8-32 x 1/2"	100	10
00227	8-32 x 5/8"	100	10
00228	8-32 x 3/4"	100	10
00229	8-32 x 1"	100	10
00231	8-32 x 1 1/4"	100	10
00233	8-32 x 1 1/2"	100	10
00234	8-32 x 2"	50	10
00236	8-32 x 2 1/2"	50	10
00237	8-32 x 3"	50	10
00238	10-24 x 3/8"	100	10
00239	10-24 x 1/2"	100	10
00241	10-24 x 3/4"	100	10
00243	10-24 x 1"	100	10
00244	10-24 x 1 1/4"	100	10
00246	10-24 x 1 1/2"	100	10
00247	10-24 x 2"	100	10
00248	10-24 x 2 1/2"	50	10
00249	10-24 x 3"	50	10
00251	10-24 x 3 1/2"	25	10
00253	10-24 x 4"	25	10
00254	10-24 x 4 1/2"	25	10
00256	10-24 x 5"	25	10
00257	10-32 x 3/8"	100	10
00258	10-32 x 1/2"	100	10
00259	10-32 x 3/4"	100	10
00261	10-32 x 1"	100	10
00263	10-32 x 1 1/4"	100	10
00264	10-32 x 1 1/2"	100	10
00266	10-32 x 2"	50	10
00267	12-24 x 1/2"	100	10
00268	12-24 x 3/4"	100	10
00271	12-24 x 1"	100	10
00273	12-24 x 1 1/4"	50	10
00274	12-24 x 1 1/2"	50	10
00276	12-24 x 2"	50	10
00277	12-24 x 2 1/2"	25	10
00278	12-24 x 3"	25	10
00279	1/4-20 x 3/8"	100	10
00281	1/4-20 x 1/2"	100	10
00283	1/4-20 x 3/4"	100	10
00284	1/4-20 x 1"	100	10
00286	1/4-20 x 1 1/4"	50	10
00287	1/4-20 x 1 1/2"	50	10
00288	1/4-20 x 1 3/4"	50	10
00289	1/4-20 x 2"	50	10
00291	1/4-20 x 2 1/2"	25	10
00293	1/4-20 x 3"	25	10
00294	1/4-20 x 3 1/2"	25	10
00296	1/4-20 x 4"	25	10
00297	1/4-20 x 4 1/2"	10	10
00298	1/4-20 x 5"	10	10
00299	1/4-20 x 5 1/2"	10	10
00301	1/4-20 x 6"	10	10
00303	5/16-18 x 3/4"	25	10
00304	5/16-18 x 1"	25	10
00306	5/16-18 x 1 1/4"	25	10
00307	5/16-18 x 1 1/2"	25	10
00308	5/16-18 x 1 3/4"	25	10
00309	5/16-18 x 2"	25	10
00311	5/16-18 x 2 1/2"	10	10
00313	5/16-18 x 3"	10	10
00314	5/16-18 x 3 1/2"	10	10
00316	5/16-18 x 4"	10	10
00317	5/16-18 x 5"	5	10
00318	5/16-18 x 6"	5	10

Item#	Size	Bag	Case
00319	3/8-16 x 3/4"	25	10
00321	3/8-16 x 1"	25	10
00323	3/8-16 x 1 1/4"	25	10
00324	3/8-16 x 1 1/2"	25	10
00326	3/8-16 x 2"	25	10
00327	3/8-16 x 2 1/2"	10	10
00328	3/8-16 x 3"	10	10
00329	3/8-16 x 3 1/2"	10	10
00331	3/8-16 x 4"	10	10
00333	3/8-16 x 5"	5	10
00334	3/8-16 x 6"	5	10
Metric			
01317	M4-.7 x 10	50	10
01318	M4-.7 x 20	50	10
01319	M4-.7 x 25	50	10
01321	M4-.7 x 30	50	10
01323	M4-.7 x 40	50	10
01324	M5-.8 x 10	50	10
01326	M5-.8 x 20	50	10
01327	M5-.8 x 25	50	10
01328	M5-.8 x 30	50	10
01329	M5-.8 x 40	50	10
01331	M6-1 x 20	50	10
01333	M6-1 x 25	50	10
01334	M6-1 x 30	50	10
01336	M6-1 x 40	25	10
01337	M6-1 x 50	25	10
01338	M6-1 x 60	10	10
01339	M8-1.25 x 20	25	10
01341	M8-1.25 x 25	25	10
01343	M8-1.25 x 30	25	10
01344	M8-1.25 x 40	25	10
01346	M8-1.25 x 50	25	10
01347	M8-1.25 x 60	10	10





PHILLIPS MACHINE SCREW - PAN HEAD

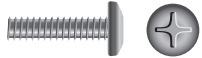

18-8 Stainless Steel.

Item#	Size	Bag	Case
00431	4-40 x 1/2"	100	10
00433	4-40 x 3/4"	100	10
00434	4-40 x 1"	100	10
00436	6-32 x 3/8"	100	10
00437	6-32 x 1/2"	100	10
00438	6-32 x 5/8"	100	10
00439	6-32 x 3/4"	100	10
00441	6-32 x 1"	100	10
00443	6-32 x 1 1/4"	100	10
00444	6-32 x 1 1/2"	100	10
00446	6-32 x 2"	50	10
00447	8-32 x 3/8"	100	10
00448	8-32 x 1/2"	100	10
00449	8-32 x 5/8"	100	10
00451	8-32 x 3/4"	100	10
00453	8-32 x 1"	100	10
00454	8-32 x 1 1/4"	100	10
00456	8-32 x 1 1/2"	100	10
00457	8-32 x 2"	50	10
00458	8-32 x 2 1/2"	50	10
00459	8-32 x 3"	50	10
00461	10-24 x 1/4"	100	10
00463	10-24 x 3/8"	100	10
00464	10-24 x 1/2"	100	10
00466	10-24 x 5/8"	100	10
00467	10-24 x 3/4"	100	10
00468	10-24 x 1"	100	10
00469	10-24 x 1 1/4"	100	10
00471	10-24 x 1 1/2"	100	10
00473	10-24 x 1 3/4"	50	10
00474	10-24 x 2"	50	10
00476	10-24 x 2 1/2"	50	10
00477	10-24 x 3"	50	10
00478	10-24 x 3 1/2"	25	10
00479	10-24 x 4"	25	10
00481	10-32 x 3/8"	100	10
00483	10-32 x 1/2"	100	10
00484	10-32 x 5/8"	100	10
00486	10-32 x 3/4"	100	10
00487	10-32 x 1"	100	10
00488	10-32 x 1 1/4"	100	10
00489	10-32 x 1 1/2"	100	10
00491	10-32 x 2"	50	10
00493	12-24 x 1/2"	100	10
00494	12-24 x 3/4"	100	10
00496	12-24 x 1"	100	10
00497	12-24 x 1 1/4"	50	10
00498	12-24 x 1 1/2"	50	10
00499	12-24 x 2"	50	10
00501	12-24 x 2 1/2"	25	10
00503	12-24 x 3"	25	10
00504	1/4-20 x 1/2"	100	10
00506	1/4-20 x 3/8"	100	10
00507	1/4-20 x 3/4"	100	10
00508	1/4-20 x 1"	100	10
00509	1/4-20 x 1 1/4"	50	10
00511	1/4-20 x 1 1/2"	50	10
00513	1/4-20 x 1 3/4"	50	10
00514	1/4-20 x 2"	50	10
00516	1/4-20 x 2 1/2"	25	10
00517	1/4-20 x 3"	25	10
00518	1/4-20 x 3 1/2"	25	10
00519	1/4-20 x 4"	25	10
00521	1/4-20 x 5"	10	10
00523	1/4-20 x 6"	10	10
00524	5/16-18 x 1/2"	25	10
00526	5/16-18 x 3/4"	25	10
00527	5/16-18 x 1"	25	10
00528	5/16-18 x 1 1/4"	25	10
00529	5/16-18 x 1 1/2"	25	10
00531	5/16-18 x 2"	25	10
00533	5/16-18 x 2 1/2"	10	10
00534	5/16-18 x 3"	10	10
00536	5/16-18 x 4"	10	10
00537	5/16-18 x 5"	5	10
00538	5/16-18 x 6"	5	10
00539	3/8-16 x 3/4"	25	10

Item#	Size	Bag	Case
00541	3/8-16 x 1"	25	10
00543	3/8-16 x 1 1/2"	25	10
00544	3/8-16 x 2"	25	10
00546	3/8-16 x 2 1/2"	10	10
00547	3/8-16 x 3"	10	10
00548	3/8-16 x 4"	10	10
Metric			
01348	M4-.7 x 10	50	10
01349	M4-.7 x 20	50	10
01351	M4-.7 x 25	50	10
01353	M4-.7 x 30	50	10
01354	M4-.7 x 40	50	10
01356	M5-.8 x 10	50	10
01357	M5-.8 x 20	50	10
01358	M5-.8 x 25	50	10
01359	M5-.8 x 30	50	10
01361	M5-.8 x 40	50	10
01363	M6-1 x 10	50	10
01364	M6-1 x 20	50	10
01366	M6-1 x 25	50	10
01367	M6-1 x 30	50	10
01368	M6-1 x 40	25	10
01369	M6-1 x 50	25	10
01371	M8-1.25 x 20	25	10
01373	M8-1.25 x 25	25	10
01374	M8-1.25 x 30	25	10
01376	M8-1.25 x 40	25	10
01377	M8-1.25 x 50	25	10
01378	M8-1.25 x 60	10	10

PHILLIPS MACHINE SCREWS - TRUSS HEAD

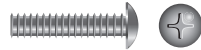

18-8 Stainless Steel.

Item#	Size	Bag	Case
00549	8-32 x 1/2"	100	10
00551	8-32 x 3/4"	100	10
00553	8-32 x 1"	100	10
00554	10-24 x 1/2"	100	10
00556	10-24 x 3/4"	100	10
00557	10-24 x 1"	100	10
00558	10-24 x 1 1/4"	100	10
00559	10-24 x 1 1/2"	100	10
00561	10-24 x 2"	50	10
00563	1/4-20 x 1/2"	100	10
00564	1/4-20 x 3/8"	100	10
00566	1/4-20 x 3/4"	100	10
00567	1/4-20 x 1"	100	10
00568	1/4-20 x 1 1/4"	50	10
00569	1/4-20 x 1 1/2"	50	10
00571	1/4-20 x 2"	50	10

PHILLIPS WOOD SCREWS - FLAT HEAD



18-8 Stainless Steel.

Item#	Size	Bag	Case
01037	#6 x 3/4"	100	10
01038	#6 x 1"	100	10
01039	#8 x 3/4"	100	10
01041	#8 x 1"	100	10
01043	#8 x 1 1/4"	100	10
01044	#8 x 1 1/2"	100	10
01046	#8 x 1 3/4"	50	10
01047	#8 x 2"	50	10
01048	#10 x 1"	100	10
01049	#10 x 1 1/4"	100	10
01051	#10 x 1 1/2"	100	10
01053	#10 x 1 3/4"	50	10
01054	#10 x 2"	50	10
01056	#10 x 2 1/2"	50	10
01057	#10 x 3"	50	10
01058	#12 x 1 1/2"	50	10
01059	#12 x 1 3/4"	50	10
01061	#12 x 2"	50	10
01063	#12 x 2 1/2"	25	10
01064	#12 x 3"	25	10
01066	#14 x 1 1/2"	50	10
01067	#14 x 1 3/4"	50	10
01068	#14 x 2"	50	10
01069	#14 x 2 1/2"	25	10
01071	#14 x 3"	25	10



PHILLIPS MACHINE SCREW - OVAL HEAD



18-8 Stainless Steel.

Item#	Size	Bag	Case
00336	6-32 x 1/2"	100	10
00337	6-32 x 5/8"	100	10
00338	6-32 x 3/4"	100	10
00339	6-32 x 1"	100	10
00341	6-32 x 1 1/4"	100	10
00343	6-32 x 1 1/2"	100	10
00344	6-32 x 2"	50	10
00346	8-32 x 1/2"	100	10
00347	8-32 x 5/8"	100	10
00348	8-32 x 3/4"	100	10
00349	8-32 x 1"	100	10
00351	8-32 x 1 1/4"	100	10
00353	8-32 x 1 1/2"	100	10
00354	8-32 x 2"	50	10
00356	10-24 x 1/2"	100	10
00357	10-24 x 5/8"	100	10
00358	10-24 x 3/4"	100	10
00359	10-24 x 1"	100	10
00361	10-24 x 1 1/4"	100	10
00363	10-24 x 1 1/2"	100	10
00364	10-24 x 1 3/4"	50	10
00366	10-24 x 2"	50	10
00367	10-24 x 2 1/2"	50	10
00368	10-24 x 3"	50	10
00369	10-24 x 3 1/2"	25	10
00371	10-24 x 4"	25	10
00373	10-32 x 1/2"	100	10
00374	10-32 x 5/8"	100	10
00376	10-32 x 3/4"	100	10
00377	10-32 x 1"	100	10
00378	10-32 x 1 1/4"	100	10
00379	10-32 x 1 1/2"	100	10
00381	10-32 x 2"	50	10
00383	12-24 x 3/4"	100	10
00384	12-24 x 1"	100	10
00386	12-24 x 1 1/4"	50	10
00387	12-24 x 1 1/2"	50	10
00388	12-24 x 2"	50	10
00389	12-24 x 2 1/2"	25	10
00391	12-24 x 3"	25	10
00393	1/4-20 x 1/2"	100	10
00394	1/4-20 x 3/4"	100	10
00396	1/4-20 x 1"	100	10
00397	1/4-20 x 1 1/4"	50	10
00398	1/4-20 x 1 1/2"	50	10
00399	1/4-20 x 1 3/4"	50	10
00401	1/4-20 x 2"	50	10
00403	1/4-20 x 2 1/2"	25	10
00404	1/4-20 x 3"	25	10
00406	1/4-20 x 3 1/2"	25	10
00407	1/4-20 x 4"	25	10
00408	1/4-20 x 5"	10	10
00409	1/4-20 x 6"	10	10
00411	5/16-18 x 3/4"	25	10
00413	5/16-18 x 1"	25	10
00414	5/16-18 x 1 1/2"	25	10
00416	5/16-18 x 2"	25	10
00417	5/16-18 x 2 1/2"	10	10
00418	5/16-18 x 3"	10	10
00419	5/16-18 x 4"	10	10
00421	5/16-18 x 5"	5	10
00423	3/8-16 x 1"	25	10
00424	3/8-16 x 1 1/2"	25	10
00426	3/8-16 x 2"	25	10
00427	3/8-16 x 2 1/2"	10	10
00428	3/8-16 x 3"	10	10
00429	3/8-16 x 4"	10	10

SLOTTED WOOD SCREWS - FLAT HEAD



Silicon Bronze.

Item#	Size	Bag	Case
01438	#6 x 3/4"	100	10
01439	#6 x 1"	100	10
01441	#8 x 3/4"	100	10
01443	#8 x 1"	100	10
01444	#8 x 1 1/4"	100	10
01446	#8 x 1 1/2"	100	10
01447	#8 x 1 3/4"	50	10
01448	#8 x 2"	50	10
01449	#10 x 1"	100	10
01451	#10 x 1 1/4"	100	10
01453	#10 x 1 1/2"	100	10
01454	#10 x 1 3/4"	50	10
01456	#10 x 2"	50	10
01457	#10 x 2 1/2"	50	10
01458	#10 x 3"	50	10
01459	#12 x 1"	50	10
01461	#12 x 1 1/4"	50	10
01463	#12 x 1 1/2"	50	10
01464	#12 x 1 3/4"	50	10
01466	#12 x 2"	50	10
01467	#12 x 2 1/2"	25	10
01468	#12 x 3"	25	10
01469	#14 x 1 1/2"	50	10
01471	#14 x 1 3/4"	50	10
01473	#14 x 2"	50	10
01474	#14 x 2 1/2"	25	10
01476	#14 x 3"	25	10

FREARSON WOOD SCREWS - FLAT HEAD



Silicon Bronze.

Item#	Size	Bag	Case
01556	#6 x 1/2"	100	10
01557	#6 x 1 1/4"	100	10
01558	#6 x 1 1/2"	100	10
01397	#6 x 3/4"	100	10
01398	#6 x 1"	100	10
01399	#8 x 3/4"	100	10
01401	#8 x 1"	100	10
01403	#8 x 1 1/4"	100	10
01404	#8 x 1 1/2"	100	10
01406	#8 x 1 3/4"	50	10
01407	#8 x 2"	50	10
01408	#10 x 1"	100	10
01409	#10 x 1 1/4"	100	10
01411	#10 x 1 1/2"	100	10
01413	#10 x 1 3/4"	50	10
01414	#10 x 2"	50	10
01416	#10 x 2 1/2"	50	10
01417	#10 x 3"	50	10
01418	#12 x 1"	50	10
01419	#12 x 1 1/4"	50	10
01421	#12 x 1 1/2"	50	10
01423	#12 x 1 3/4"	50	10
01424	#12 x 2"	50	10
01426	#12 x 2 1/2"	25	10
01427	#12 x 3"	25	10
01428	#14 x 1 1/2"	50	10
01429	#14 x 1 3/4"	50	10
01431	#14 x 2"	50	10
01433	#14 x 2 1/2"	25	10
01434	#14 x 3"	25	10

STEEL DRIVER BITS



Square

Frearson

2" Long, 1/4" Hex Drive

Item#	Size	Bag	Case
Square			
01209	#1	1	10
01211	#2	1	10
01213	#3	1	10
Frearson			
01436	#2	1	10
01437	#3	1	10



SOCKET SET SCREWS



18-8 Stainless Steel.

Item#	Size	Bag	Case
01109	8-32 x 1/4"	100	10
01111	10-24 x 1/4"	100	10
01113	10-32 x 1/4"	100	10
01114	1/4"-20 x 1/4"	100	10
01116	1/4"-28 x 3/16"	100	10
01117	1/4"-28 x 1/4"	100	10

STAINLESS COTTER PINS



18-8 Stainless Steel.

Item#	Size	Bag	Case
01073	1/16" x 1/2"	100	10
01074	1/16" x 3/4"	100	10
01076	1/16" x 1"	100	10
01077	3/32" x 3/4"	100	10
01078	3/32" x 1"	100	10
01079	3/32" x 1 1/4"	100	10
01081	3/32" x 1 1/2"	100	10
01083	1/8" x 3/4"	100	10
01084	1/8" x 1"	100	10
01086	1/8" x 1 1/4"	100	10
01087	1/8" x 1 1/2"	100	10
01088	1/8" x 2"	50	10
01089	5/32" x 1"	50	10
01091	5/32" x 1 1/4"	50	10
01093	5/32" x 1 1/2"	50	10
01094	5/32" x 2"	50	10
01096	3/16" x 1 1/2"	50	10
01097	3/16" x 2"	50	10

BLIND RIVETS



Item#	Size	Bag	Case
18-8 Stainless Steel.			
00639	1/8" x 1/8"	100	10
00641	1/8" x 1/4"	100	10
00643	1/8" x 3/8"	100	10
00644	1/8" x 1/2"	100	10
00646	5/32" x 1/4"	100	10
00647	5/32" x 3/8"	100	10
00648	5/32" x 1/2"	100	10
00649	3/16" x 1/4"	100	10
00651	3/16" x 3/8"	100	10
00653	3/16" x 1/2"	100	10
00654	3/16" x 5/8"	50	10
00656	3/16" x 3/4"	50	10
Aluminum			
00657	1/8" x 1/4"	100	10
00658	5/32" x 1/4"	100	10
00659	5/32" x 3/8"	100	10
00661	3/16" x 1/4"	100	10
00663	3/16" x 3/8"	100	10
00664	3/16" x 1/2"	100	10
00666	3/16" x 5/8"	50	10
00667	3/16" x 3/4"	50	10

THREADED RODS - STAINLESS



18-8 Stainless Steel.

Item#	Size	Bag	Case
00668	10-24 x 3"	1	10
00669	1/4"-20 x 3'	1	10
00671	5/16"-18 x 3'	1	10
00673	3/8"-16 x 3'	1	10
00674	1/2"-13 x 3'	1	10
00676	5/8"-11 x 3'	1	10
00677	3/4"-10 x 3'	1	10

308 PIECE STAINLESS STEEL FASTENER DISPLAY



Fully Assembled Kit

Kit Includes:

- Variety of popular fastener types and sizes.
- (3) Unit Header Signs - Model 01979
- (1) Bin Labels
- (2) 18 Drawer Clear Cabinets - Model 01986
- (3) 13 Shelf Units - Model 01987
- (12 cases of 24) Blue Bins - Model 01988
- (12 cases of 24) Bin Dividers - Model 01989

13 Shelf Units are manufactured from high-grade, 22-gauge steel with a powder-coated finish. Assembly required: units are easily assembled with the included hardware, and include adjustable shelves w/clips. Capacity: 500 lbs. per shelf.

Item#	Description	Case	
01991	Display (Fasteners & Shelving)	1	
01981	Fasteners Only (6 Boxes)	1	
Repl. Parts	Description	Size	Case
01979	Unit Header Signs	32" W x 8" H	N/A
02006	Bin Labels	N/A	1
01986	18 Drawer Clear Cabinet	18" x 6" x 9 1/2"	1
01987	13 Shelf Unit (22 Ga. steel)	36" W x 12" D x 75" H	1
01988	Blue Bins (Pack of 24)	11 5/8" W x 4 1/8" D x 4 H	24
01989	Bin Dividers (Pack of 24)	N/A	24

212 PIECE STAINLESS STEEL FASTENER DISPLAY



Fully Assembled Kit

Kit Includes:

- Variety of popular fastener types and sizes.
- (2) Unit Header Signs - Model 01979
- (1) Bin Labels
- (2) 18 Drawer Clear Cabinets - Model 01986
- (2) 13 Shelf Units - Model 01987
- (8 cases of 24) Blue Bins - Model 01988
- (8 cases of 24) Bin Dividers - Model 01989

13 Shelf Units are manufactured from high-grade, 22-gauge steel with a powder-coated finish. Units are easy to assemble and shelves can be adjusted with compression clips. Assembly required. All hardware included. Per shelf weight capacity: 500 lbs.

Item#	Description	Case	
01993	Display (Fasteners & Shelving)	1	
01983	Fasteners Only (6 Boxes)	1	
Repl. Parts	Description	Size	Case
01979	Unit Header Signs	32" W x 8" H	N/A
02007	Bin Labels	N/A	1
01986	18 Drawer Clear Cabinet	18" x 6" x 9 1/2"	1
01987	13 Shelf Unit (22 Ga. steel)	36" W x 12" D x 75" H	1
01988	Blue Bins (Pack of 24)	11 5/8" W x 4 1/8" D x 4 H	24
01989	Bin Dividers (Pack of 24)	N/A	24



PULL UP CLEAT



316 Cast stainless steel. Cleat recesses flush to deck. Four countersunk holes for four fasteners (fasteners not included). Easy to install. Needs 3/2" below deck clearance.

Item#	Size	Fastener	Case
30061	4 1/4"	#10	12
30071	6"	1/4"	12

PULL UP CLEAT WITH STUDS



Made of 316 stainless steel. Streamline design. 2 1/2" clearance under deck

Item#	Size	Stud	Case
30041	4 1/2"	1/4"-20 thread	6
30051	6"	3/8"-16 thread	6

LIFTING RING / CLEAT



316 stainless steel. Base diameter: 2" Height: 2". For threaded rod size 5/8"-11. Maximum vertical load 4000 lbs. Fasten with #10 screws. If used for overhead lifting, Seachoice lifting adapter plate (30201) and threaded rod (30190) must be properly installed.

Item#	Size	Eye	Case
30241	6" x 2"	1 1/8" dia.	10

LIFTING EYE WITHOUT CLEAT



Stainless steel. Tapped for 5/8" threaded connecting rod. Maximum vertical load 3000 lbs. If used for overhead lifting, both Seachoice lifting adapter plate (30201) and threaded rod (30190) must be properly installed.

Item#	Eye	Case
30231	1 1/2"	10

LIFTING ADAPTER PLATE



Adapter plate with 5/8" right hand threaded tapping pinion. For use with Seachoice lifting eyes (30231, 30241) when overhead lifting is required.

Item#	Material	Fits	Case
30201	304 Stainless Steel	1 1/4" ID Eyes	12

THREADED ROD



For use with Seachoice lifting adapter plate (30201) and choice of lifting eyes (30231 & 30241). 304 Stainless steel.

Item#	Size	Pack	Case
30190	5/8"-11 x 36" L	Bulk	10

TIE DOWN CLEAT



Chrome plated zinc.

Item#	Size	Base	Fastener	Case
30351	4 1/16" L x 7/8" H	1 1/16" L	#10	12

BLACK PLASTIC CLEAT



30800



30820



30840



30860

Durable and non-corrosive.

Item#	Size	Center to Center	Line Size	Fastener	Pack	Case
30800	4 1/2" L	1 3/16"	Up To 5/16"	3/16"	Bulk	50
30801	4 1/2" L	1 3/16"	Up To 5/16"	3/16"		12
30820	6" L	1 1/16"	Up To 7/16"	1/4"	Bulk	50
30821	6" L	1 1/16"	Up To 7/16"	1/4"		12
30840	8" L	2 1/4"	Up To 5/8"	5/16"	Bulk	50
30841	8" L	2 1/4"	Up To 5/8"	5/16"		12
30860	10" L	3 1/8"	Up To 1"	5/16"	Bulk	50
30861	10" L	3 1/8"	Up To 1"	5/16"		12

HOLLOW BASE YACHT CLEAT



Chrome plated polished cast brass.

Item#	Size	Center to Center	Fastener	Case
30301	5 1/2" L x 1 1/4" H	2 1/8" L; 1" W	#10	12
30311	6 1/2" L x 1 1/4" H	2 5/8" L; 1" W	1/4"	12
30321	8" L x 1 3/4" H	3 5/8" L; 1 1/2" W	1/4"	12

HOLLOW BASE CLEAT



316 Stainless steel.

Item#	Size	Center to Center	Fastener	Case
30251	6" L x 1 1/4" H	2 1/4" L; 1 3/8" W	#14	12
30261	8" L x 1 1/2" H	2 13/16" L; 1 1/2" W	1/4"	12
30271	10" L x 2" H	3 5/8" L; 1 3/8" W	1/4"	12

HOLLOW BASE CLEAT



Chrome plated zinc.

Item#	Size	Center to Center	Fastener	Case
30481	4" L x 3/4" H	1 1/2" L; 1" W	#10	12

HOLLOW BASE CLEAT



Chrome plated zinc.

Item#	Size	Center to Center	Fastener	Case
30561	4 1/2" L x 3/4" H	1.65" L; 1.15" W	#8	12
30571	6" L x 7/8" H	2.20" L; 1.50" W	#8	12

OPEN BASE DOCK CLEAT



Galvanized gray iron. Hot dipped. Suitable for work boats, seawalls and dock use.

Item#	Size	Center to Center	Fastener	Pack	Case
30580	4"	.85"	#10	Bulk	12
30600	6"	1.25"	5/16"	Bulk	12
30610	8"	1.56"	3/8"	Bulk	12
30620	10"	2.40"	7/16"	Bulk	12
30630	12"	3.20"	7/16"	Bulk	12

CAST ALUMINUM "S" DOCK CLEAT



Tie your boat with the quick, easy and secure "S" shaped dock cleat. The oversized "S" shaped horns are easy to loop and are designed to accept oversized lines. Made from corrosion-resistant aluminum, this well designed cleat features recessed mounting holes to eliminate line snag and fray without sacrificing strength and durability. Mounting hardware not included.

Item#	Size	Center to Center	Fastener	Case
30760	10"	6 1/8"	1/2"	24
30770	12"	6 1/4"	1/2"	12
30780	15"	7 1/2"	1/2"	12

BOW CHOCKS



Skene type bow chocks have an overall length of 3 1/2". Both mount with #8 screws.

Item#	Material	Fits	Pack	Case
31501	Chrome plated zinc	3/4" Line	1 pr.	12
31601	Black nylon, etched finish	7/16" Line	1 pr.	12

BOW CHOCK



316 Stainless steel. Overall length: 4 3/4". Width: 3/4". Pre-drilled for two #10 screws.

Item#	Line Size	Pack	Case
31251	Up To 5/8"	1 pr.	12

BOW EYE



SINGLE SHANK

33531: Die-cast ZAMAK eye with Perma-Plate finish. Cadmium plated shank. 4000 lb. pull. Shank length: 3" x 3/8"

DOUBLE SHANK

33501: Chrome plated zinc eye. Zinc plated steel U-bolt, nuts and washers. 5000 lb. pull. Shank length: 3" x 5/16". Thread length: 2 3/4"

Item#	Description	Eye	Case
33531	Single Shank	1" ID	12
33501	Double Shank	1 1/4" ID	12

BOW AND STERN EYE



304 Stainless steel

BOW EYES

33601: 3200 lbs. pull. Face plate: 3/4" x 2 1/4". ID 1 1/8"

33631: 4800 lbs. pull. Face plate: 3/4" x 3". ID 1 1/4"

33641: 4800 lbs. pull. Face plate: 3/4" x 3". ID 1 1/4"

STERN EYES

33701: 3200 lbs. pull. Face plate: 1 1/4" x 2 3/4". ID 1 1/8"

33731: 4800 lbs. pull. Face plate: 1 1/2" x 3 1/2". ID 1 1/4"

Item#	Description	Size	Thread	Pack	Case
33601	Bow Eye	3/8"	3 7/16"		12
33600	Bow Eye	3/8"	3 7/16"	Bulk	12
33631	Bow Eye	1/2"	3 7/16"		12
33630	Bow Eye	1/2"	3 7/16"	Bulk	12
33641	Bow Eye	1/2"	4 3/4"		12
33701	Stern Eye	3/8"	3 7/16"		12
33731	Stern Eye	1/2"	3 7/16"		12
33730	Stern Eye	1/2"	3 7/16"	Bulk	12

COVER PLATE



- UV stabilized
- Acetone resistant polypropylene
- Requires #8 fasteners

Item#	OD	For	Color	Case
39621	4 1/8"	Hole size up to 2 3/4"	Arctic White	10
39601	5 5/8"	Hole size up to 4"	Arctic White	10
39591	7 7/8"	Hole size up to 6"	Arctic White	12

TWIST 'N' LOCK DECK PLATE



Cam-action watertight O-ring seal. Acetone resistant polypropylene. Easy to clean! Requires #8 fasteners.

Item#	ID	OD	Hole	Color	Case
39251	3 7/8"	5 5/8"	4 1/2"	White	12
39261	3 7/8"	5 5/8"	4 1/2"	Arctic White	12
39291	3 7/8"	5 5/8"	4 1/2"	White w/Clear Insert	12
39271	3 7/8"	5 5/8"	4 1/2"	Black	12
39351	5 7/8"	7 7/8"	6 1/2"	White	12
39361	5 7/8"	7 7/8"	6 1/2"	Arctic White	12
39401	5 7/8"	7 7/8"	6 1/2"	White w/Clear Insert	12
39371	5 7/8"	7 7/8"	6 1/2"	Black	12
39421	7 3/4"	9 7/8"	8 1/2"	White	12

PRY-UP DECK PLATE



Easy to clean non-skid surface. Water tight O-ring seal. Acetone resistant polypropylene. Requires #8 fasteners.

Item#	ID	OD	Hole	Color	Case
39461	4"	5 1/2"	4 3/8"	White	12
39471	4"	5 1/2"	4 3/8"	Arctic White	12
39501	6"	8"	6 1/2"	White	12
39511	6"	8"	6 1/2"	Arctic White	12
39561	8"	9 7/8"	8 1/2"	White	12
39541	8"	9 7/8"	8 1/2"	Arctic White	12
39581	10"	12 5/8"	10 5/8"	White	12

7" x 11" ID HATCH



Made of Polypropylene and is acetone proof. Requires #8 fasteners.

39121: Pry-out Type

39131: Molded in Stainless Steel Hinge 100°

39141: Molded in Stainless Steel Hinge 100°

Item#	ID	OD	Cut Out	Color	Case
39121	6 7/8" x 10 7/8"	10 1/4" x 14 3/8"	8 1/4" x 12 3/8"	White	10
39131	6 7/8" x 10 7/8"	10 1/4" x 14 3/8"	8 1/4" x 12 3/8"	White	10
39141	6 7/8" x 10 7/8"	10 1/4" x 14 3/8"	8 1/4" x 12 3/8"	Arctic White	10
Repl. Parts	Description		Color	Case	
39171	Replacement Handle		Clear	12	



OFFSHORE HATCH



- Low profile
- UV stabilized
- Acetone resistant polypropylene
- Integrated hinge system allows 180° opening
- Flush handle for easy access
- #8 Fasteners required

Item#	ID	OD	Cut Out	Color	Case
39181	7 3/8" x 11 1/8"	10 1/8" x 14 1/8"	8 1/8" x 11 1/8"	White	10
39201	10 3/8" x 20 1/2"	13 1/4" x 23 3/8"	11 1/8" x 21 1/8"	White	10

Repl. Parts	Description	Color	Case
39191	Replacement Handle	White	12

10" x 20" ID HATCH



39151

39161

- Built-in cam action handle
- #8 Fasteners required
- Stainless Steel Hinge 100°

Item#	ID	OD	Cut Out	Color	Case
39151	9 3/8" x 19 3/8"	13 1/8" x 23 3/8"	11 1/4" x 21 3/8"	White	10
39161	9 3/8" x 19 3/8"	13 1/8" x 23 3/8"	11 1/4" x 21 3/8"	Arctic White	10

Repl. Parts	Description	Color	Case
39171	Replacement Handle	Clear	12



DECK FILL PLATE



32011

32041

32051

32061

32091

32101

32251

32271

32011: Chrome Plated Zinc. Has grounding screw. Length 1 7/8". Overall OD 3 1/8". Mount w/#6 screws.

32041: Chrome Plated Zinc. Cap is marked "GAS". Rubber gasket for secure fitting. Mount w/#10 screws.

32051: Investment Cast 316 Stainless Steel. Locking cap is marked "GAS". Includes (2) keys. Mount w/#10 screws.

32061: Molded Plastic. Tough molded plastic flip top "GAS" fill with integral tank vent. In compliance with USCG regulations, fuel splash back goes back down neck instead of overboard due to the integral tank vent with flame arrestor. Hinged flip top cap makes deck plate key obsolete and eliminates cap loss. CE certified.

32091, 32101: Nylon. 1 1/2" fiberglass nylon deck fill. Cap is marked "GAS" or "WATER". Rubber gasket included for secure closing. Built-in tap for easy opening without special tools. Mount w/#10 screws.

32251, 32261, 32271, 32281: Cast 316 SS. Precision cast hose fills. Mount w/#10 screws. 3" Flange width.

Replacement Parts

32551 Gas Cap: Cast 316 SS

32531 Gas Cap: Nylon

32501 Cap: Plastic

32521 Cap: Chrome Plated Zamak.

Item#	Description	Cap Tether	Hose	Case
32011	Gas Fill w/Cap	Strap	1 1/2"	12
32041	Gas Fill w/Cap	Beaded Chain	1 1/2"	12
32051	Gas Fill w/Locking Cap	Cable	1 1/2"	12
32061	Gas Fill w/Vent & Cap (CE certified)	Hinged Flip Top Cap	1 1/2"	12
32091	Gas Fill w/Cap	Beaded Chain	1 1/2"	12
32101	Water Fill w/Cap	Beaded Chain	1 1/2"	12
32251	Gas Fill w/Cap	Safety Chain	1 1/2"	12
32261	Diesel Fill w/Cap	Safety Chain	1 1/2"	12
32271	Water Fill w/Cap	Safety Chain	1 1/2"	12
32281	Waste Fill w/Cap	-	1 1/2"	12

Repl. Parts	Description	Fits	Case
32551	Gas Cap	32251, 32261, 32271, 32281	12
32531	Gas Cap	32091	12
32501	Cap	32011 & Perko 1313 / 1314 Series	12
32521	Cap	32041	12

DECK PLATE KEY



Black poly carb. Will fit 1 1/4" and 1 1/2" deck plates. Overall length: 3 3/8".

Item#	Case
32651	12

DECK PLATE KEY AND TOOL



Non-magnetic stainless steel. Universal key has many applications including bottle opener and screwdriver. Overall length: 3 3/8".

Item#	Case
32671	12

HATCH HINGE



Chrome plated brass. Includes cotter pin.

Item#	Size	Fastener	Case
35101	2 3/8" x 2 7/8" x 1 1/4"	#10	12

TAKE-APART MOTOR BOX HINGE



Chrome plated cast brass. Removable feature allows motor box to be pulled apart for engine access.

Item#	Size	Fastener	Case
35111	3 5/16" x 2 1/8"	#10	12

CONTINUOUS HINGE



.040 gauge 304 stainless steel. Drilled and countersunk on 2" centers. Bright annealed.

Item#	Size	Fastener	Case
34971	1 1/4" x 72"	#5	12
34981	1 1/2" x 72"	#6	12
34991	2" x 72"	#6	12

BUTT HINGE

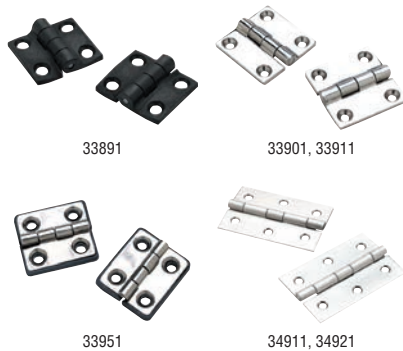

33891: Molded from fiberglass filled Black nylon with stainless steel pin. Very sturdy and extremely lightweight.
33901, 33911: 316 Stainless steel.
33951: Polished 304 Stamped stainless steel. Black nylon base plate. Note: Can be used without base.
34911, 34921: 304 stainless steel. Fast pin type butt hinges.

Item#	Type	Size	Fastener	Pack	Case
33891	Hinge	1 1/2" x 1 3/8"	#8	1 pr.	12
33901	Hinge	1 1/2" x 1 1/2"	#8	1 pr.	12
33911	Hinge	2" x 2"	#8	1 pr.	12
33951	Hinge w/ Base	1 5/16" x 1 1/2"	#8	1 pr.	12
34911	Hinge	1 5/8" x 2 1/2"	#8	1 pr.	12
34921	Hinge	2" x 3"	#8	1 pr.	12

UTILITY HINGE



34141: Fiberglass filled black nylon with stainless steel pin. Very sturdy and extremely lightweight.
34151: Polished 304 stamped stainless steel. Black nylon base plate. Note: Can be used without base.
34231: Chrome plated zinc.
34241: Chrome plated zinc. 120° opening.

Item#	Size	Fastener	Pack	Case
34141	3" x 1 3/8"	#8	1 pr.	12
34151	2 7/8" x 1 1/2"	#8	1 pr.	12
34231	3" x 1 1/2"	#8	1 pr.	12
34241	3" x 1 1/2"	#8	1 pr.	12

DOOR HINGE



316 Stainless steel. Drilled and counter sunk.

Item#	Size	Fastener	Pack	Case
34101	1 1/2" x 3"	#8	1 pr.	12
34111	1 1/2" x 4"	#8	1 pr.	12

SHORT SIDE HINGE



34351: Polished 304 stamped stainless steel. Black nylon base plate. Note: Can be used without base.
34401: Chrome plated zinc.
34471: Polished 304 stamped stainless steel. Black nylon base plate. Offset: 3/8". Note: Can be used without base.

Item#	Type	Size	Short Side	Fastener	Pack	Case
34351	Hinge with Base	2 1/4" x 1 1/2"	3/4"	#8	1 pr.	12
34401	Hinge	2 1/4" x 1 1/2"	3/4"	#8	1 pr.	12
34471	Offset with Base	2 1/4" x 1 1/2"	3/4"	#8	1 pr.	12

INSET HINGE



Made of brass with a chrome plated finish. Semi-concealed for 3/8" inset.

Item#	Size	Fastener	Pack	Case
34601	2 3/4" x 2 1/8"	#4	1 pr.	12

STRAP HINGES WITH BASE



304 Stamped polished stainless steel. Black nylon base plates. Note: Can be used without base.

Item#	Size	Fastener	Pack	Case
33851	4" x 1 1/16"	#8	1 pr.	12



STRAP HINGE



33821

33831

Made of cast brass with a triple chrome plated finish. Drilled and countersunk.

Item#	Size	Fastener	Pack	Case
33821	4" x 1 1/8"	#8	1 pr.	12
33831	6" x 1 1/8"	#8	1 pr.	12

STRAP HINGE



33801

33811

Made of 316 Stainless steel. Drilled and countersunk.

Item#	Size	Fastener	Pack	Case
33801	4" x 1"	#10	1 pr.	12
33811	6" x 1 1/8"	#10	1 pr.	12

SAFETY HASP



Made of 304 polished stainless steel.

Item#	Size	Fastener	Case
37021	1" x 2 1/8"	#8	12

SWIVEL EYE SAFETY HASP



Made of 304 polished stainless steel.

Item#	Size	Fastener	Case
37111	1" x 2 3/4"	#8	12

SWIVEL EYE HASP



37091

37101

Eye swivels to act as a latch.

Item#	Material	Size	Fastener	Case
37091	Triple chrome plated cast brass	3"	#8	12
37101	Chrome plated zinc	3", lock clearance: 1 1/2"	#6	12

SWIVEL HASP



Made of heavy duty cast 316 stainless steel. Fits padlocks with 1/4" shank or smaller.

Item#	Size	Fastener	Case
37051	3" L (closed) x 1 1/4" W	#8	12

LOCKABLE HASP



Made of 304 stainless steel with a electro polished finish. Supplied with 2 keys.

Item#	Size	Plate	Fastener	Case
37031	1 1/8" x 3"	1 5/8" x 1 5/8"	#6	12

HATCH FASTENER



Made of cast brass with a chrome plated finish. Anti-Rattle.

Item#	Size	Fastener	Case
35841	3 3/4" L x 1 1/8" W	#8	12

BARREL BOLT



Made of heavy duty cast brass with a chrome plated finish. 1" Width. 1/4" Barrel.

Item#	Size	Fastener	Case
35751	2" x 1 1/16" (Closed)	#6	12
35761	2 1/2" x 1 1/16" (Closed)	#6	12
35781	3 1/2" x 1 1/16" (Closed)	#6	12

BARREL BOLT



35691

35701

Items 35701 and 35731 include a friction pad which eliminates rattle, 35691 does not include a friction pad. Bolt slides past base in open position.

Item#	Material	Size	Fastener	Case
35691	Chrome Plated Brass	2 7/8" x 1 1/8" (Closed)	#6	12
35701	Chrome Plated Bronze	3 3/8" x 1 1/8" (Closed)	#6	12
35731	Chrome Plated Bronze	4 7/8" x 1 1/8" (Closed)	#6	12

CABIN DOOR HOOK



Made of cast brass with a chrome plated finish.

Item#	Size	Fastener	Case
36121	2"	#6	12
36141	3"	#6	12

CABIN DOOR HOOK



Made of 304 stainless steel. Provides maximum strength and corrosion resistance. Plastic bushing in the eye prevents accidental unhooking due to vibration and reduces most of the rattling noise associated with other door hooks.

Item#	Size	Fastener	Case
36161	2 3/8"	#8	12
36171	3"	#8	12
36181	3 1/16"	#8	12

CABIN DOOR HOOK



Made of zinc with a chrome plated finish.

Item#	Size	Fastener	Case
36211	1 3/4"	#6	12
36231	2 1/4"	#6	12

FRICTION CATCH



Made of brass with a chrome plated finish. Adjustable pressure by means of top screw.

Item#	Size	Fastener	Case
35981	1 3/4" x 5/16"	#6	12
35991	1 1/16" x 3/8"	#6	12
36001	2 3/8" x 7/16"	#6	12

DOOR CATCH



Black plastic ball stud and catch holds door firmly in place against motion and vibration. Stud - 1 1/8" x 3/8". Catch - 1 3/8" x 7/8". Includes 2 male and 2 female pieces.

Item#	Fastener	Pack	Case
35971	#4	1 pr.	12

DOOR BUTTON



Made of zinc with a chrome plated finish. Black plastic knob and phosphor bronze tension spring.

Item#	Size	Fastener	Case
35951	1 3/4" dia.	#6	12

CUPBOARD BOLT



Made of zinc with a chrome plated finish. Black plastic slide and knob.

Item#	Size	Fastener	Case
35921	2 1/8" x 1 1/2"	#6	12

90° ANGLE BRACKET



Made of stainless steel.

Item#	Size	Fastener	Pack	Case
37551	2 3/8" x 1/2"	#8	1 pr.	12

CAM LOCK



Made of steel with a chrome plated finish. Comes with complete set of installation hardware. 1 1/8" L. Includes 2 keys.

Item#	Case
37241	12

LOCKING LIFTING RING



Made of cast stainless steel. Requires 3/4" hole to insert lock. To lock, just turn key to locked position. Face plate: 1 7/8" x 2 1/8" x 1" deep.

Item#	Case
35511	12

ROUND HATCH HANDLE



Item#	Material	Size	Hole	Case
35531	Cast Stainless Steel	Face: 2 3/8", Overall Length: 3 3/4"	2"	12

SLAM LATCH

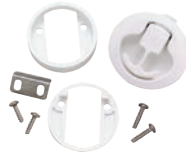

Corrosive resistant 2" diameter accommodates material thickness from 7/16" to 7/8".

Item#	Case
35521	12

FLUSH LOCK



Made of zinc with a chrome plated finish. Ideal for locking compartment doors, dock boxes, etc. Eliminates bulky padlocks. Installs in 1 3/8" diameter hole. For door thickness: 1/2" - 3/4". Includes 2 keys.

Item#	Size	Case
35501	2 1/4" x 2"	12

RING PULL

Made of 304 polished stainless steel.



Item#	Size	Fastener	Case
36641	2 3/16" x 2 5/8"	#8	12

FLUSH RING PULL



Item#	Material	Size	Fastener	Case
36601	Chrome Plated Zinc	1 3/4" x 1 3/8"	#6	12
36661	Chrome Plated Cast Brass	1 1/2" x 1 3/4"	#6	12
36681	Chrome Plated Cast Brass	1 7/8" x 2 1/2"	#8	12

FLUSH HATCH HANDLE



Made of stamped 304 stainless steel. Spring loaded flush lifting handle.

Item#	Size	Fastener	Case
36701	3" x 2 1/4"	#8	12

FLUSH LIFTING HANDLE



Item#	Material	Size	Fastener	Case
36741	Chrome Plated Brass	3" x 2 1/16"	#8	12
36811	Chrome Plated Zinc	3" x 2 1/4"	#8	12



HATCH COVER PULL



Made of 304 stainless steel with an electro-polished finish. Easy installation.

Item#	Size	Shank	Case
36691	1 1/4" dia. x 1/8"	2" x 3/16" dia.	12

COMBINATION HANDLE / STEP



Made of nylon. Black. 2 5/16" protrusion from transom.

Item#	Size	Fastener	Case
37491	6 1/2" L x 1 5/8" W	1/4"	12

TRANSOM HANDLE



Item#	Material	Size	Fastener	Case
37501	Chrome Plated Zinc	6" L x 1 5/16" W x 3 1/2" H	1/4"	12
37511	Triple Chrome Plated Cast Brass	4 3/4" L x 1" W x 1" H	#10	12
37521	Triple Chrome Plated Cast Brass	6" L x 1 1/2" H	#10	12

HANDRAIL WITH STUDS



Made of 304 stainless steel with an electro-polished finish. Stud Center-to-Center x 2" H.

Item#	Size	Stud	Case
38341	12"	5/16"-18 x 1 7/8" long	12
38351	18"	5/16"-18 x 1 7/8" long	5
38361	24"	5/16"-18 x 1 7/8" long	5

HANDRAIL



Made of 304 stainless steel with an electro-polished finish. Built-in round plates and 1/4" threads for under deck fastening. Center-to-Center x 2" H.

Item#	Size	Fastener	Case
38301	12"	1/4" - 20	12
38311	18"	1/4" - 20	5
38321	24"	1/4" - 20	5

HAND RAIL FITTINGS



- Made of cast 316 stainless steel, polished
- Corrosion resistant
- Ideal for cabin top, dash, side or stern handrails
- Pre-drilled for two #10 screws
- Height: 1 1/2"

Item#	Type	Angle	Tube	Case
38231	Forward	60°	7/8" OD	12
38251	Center	60°	7/8" OD	12
38291	Aft	60°	7/8" OD	12

ROUND BASE RAIL FITTING



- Polished
- 1/4" - 28 cup - point set screws included
- Pre-drilled for three #10 screws
- Base OD 2 5/8"

Item#	Material	Angle	Tube	Case
37751	Cast 316 Stainless Steel	30°	7/8" OD	12
37771	Cast 316 Stainless Steel	45°	7/8" OD	12
37791	Cast 316 Stainless Steel	60°	7/8" OD	12
37811	Cast 316 Stainless Steel	90°	7/8" OD	12
37761	Chrome Plated Zamak	30°	7/8" OD	12
37801	Chrome Plated Zamak	60°	7/8" OD	12
37821	Chrome Plated Zamak	90°	7/8" OD	12

RECTANGULAR BASE RAIL FITTING



- Polished
- 1/4" - 28 cup-point set screws included
- Pre-drilled for four #10 screws
- Base: 3" x 1 3/4"

Item#	Material	Angle	Tube	Case
37891	Cast 316 Stainless Steel	60°	7/8" OD	12
37911	Cast 316 Stainless Steel	90°	7/8" OD	12
37901	Chrome Plated Zamak	60°	7/8" OD	12
37921	Chrome Plated Zamak	90°	7/8" OD	12



RAIL FITTING TEE

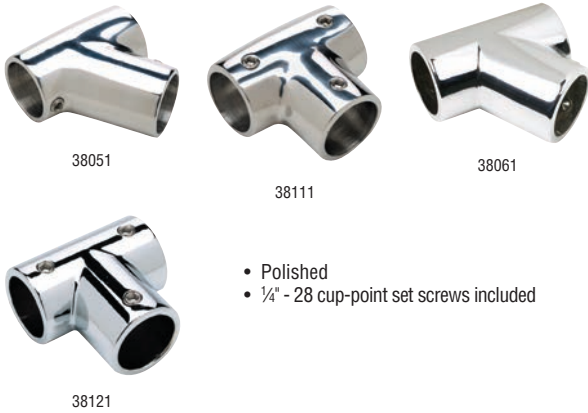

- Polished
- 1/4" - 28 cup-point set screws included

Item#	Material	Angle	Tube	Case
38051	Cast 316 Stainless Steel	60°	7/8" OD	12
38111	Cast 316 Stainless Steel	90°	7/8" OD	12
38061	Chrome Plated Zamak	60°	7/8" OD	12
38121	Chrome Plated Zamak	90°	7/8" OD	12

BOW ELBOW

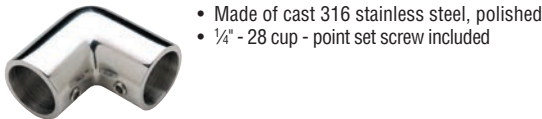

- Made of cast 316 stainless steel, polished
- 1/4" - 28 cup - point set screw included

Item#	Angle	Tube	Case
38421	90°	7/8" OD	12

RAIL END FITTING



- Made of cast 316 stainless steel, polished
- 1/4" - 28 cup - point set screw included
- Pre-drilled for two #10 screws

Item#	Angle	Tube	Case
38471	5.5°	7/8" OD	12

SWIVEL BABY SNAP



Made of brass with a chrome plated finish.

Item#	Length	Eye	Case
36961	1 7/8"	3/8" ID	12

SWIVEL EYE SNAP



Made of cast brass.

Item#	Size	Length	Eye	Snap ID	Case
36881	#1	3 1/4"	5/8" ID	3/8"	12
36891	#2	3 3/4"	3/4" ID	1/2"	12
36901	#3	4 1/2"	3/4" ID	5/8"	12

SWIVEL EYE SNAP



Made of cast stainless steel with a polished finish.

Item#	Size	Length	Eye	Snap ID	Break Strength	Case
36401	#1	3 3/8"	5/8" ID	3/8"	400#	12
36421	#2	4"	3/4" ID	1/2"	500#	12
36441	#3	4 3/4"	3/4" ID	9/16"	800#	12

SWIVEL EYE BOLT SNAP



Item#	Material	Length	Case
36491	Chrome Plated Brass	3"	12
36521	Stainless Steel	3"	12

SPRING SNAPS



Made of brass with a chrome plated finish.

Item#	ID	Size	Eye	Pack	Case
36951	1"	2 1/8" L	1/4"	1 pr.	12

FAST EYE SNAP



Made of cast brass with a polished finish.

Item#	Size	Length	Eye	Snap ID	Case
36911	#0	2"	7/16" ID	1/4"	12
36921	#1	2 7/8"	5/8" ID	3/8"	12
36931	#2	3 1/4"	1 1/16" ID	5/8"	12
36941	#3	3 7/8"	3/4" ID	1 1/16"	12

FAST EYE SNAP



Made of stainless steel with a polished finish.

Item#	Size	Length	Eye	Snap ID	Case
36451	#0	2"	7/16" ID	1/4"	12
36461	#1	2 7/8"	5/8" ID	3/8"	12
36471	#2	3 1/4"	1 3/16" ID	1/2"	12
36481	#3	3 7/8"	1 5/16" ID	5/8"	12

SAFETY SPRING HOOK



Spring loaded interlocking safety snap, made of zinc plated steel.

Not recommended for towing or commercial applications.

Item#	Size	Case
36821	5/16" x 3 1/8"	12
36831	3/8" x 4"	12
36841	7/16" x 4 3/4"	12



SAFETY SPRING HOOK



Spring loaded interlocking safety snap, made of 316 stainless steel.

Not recommended for towing or commercial applications.

Item#	Size	Break Strength	Max Load	Pkg.	Case
36851	1/4" x 2 1/2"	1200 lbs.	240 lbs.		12
36850	1/4" x 2 1/2"	1200 lbs.	240 lbs.	Bulk	10
36861	5/16" x 3 1/4"	2400 lbs.	480 lbs.		12
36860	5/16" x 3 1/4"	2400 lbs.	480 lbs.	Bulk	10
36871	3/8" x 4"	3000 lbs.	600 lbs.		12
36870	3/8" x 4"	3000 lbs.	600 lbs.	Bulk	10

SNAP HOOK



Rugged and heavy-duty snap hook with spring loaded safety snap to prevent hook from unhooking. Nickel plated. 5/8" eye with 3/16" snap ID

Not recommended for overhead lifting.

Item#	Length	Break Strength	Case
37151	3 1/2"	2300 lbs.	12

WINCH HOOK



Made of heavy duty, forged steel with a zinc plated finish.

Not recommended for overhead lifting.

Item#	Size	Break Strength	Case
36981	5/8" x 3 3/8"	7000 lbs.	12

WINCH HOOK



Made of heavy duty, forged steel with a zinc plated finish. Closure is spring loaded. 5/8" throat.

Not recommended for overhead lifting.

Item#	Size	Break Strength	Case
36971	5/8" x 4 1/4"	6000 lbs.	12

UTILITY SNAP HOOK



Made of wire cast steel with a zinc plated finish.

Item#	Size	Break Strength	Case
36551	4 1/4"	1000 lbs.	12

CHAIN LINK



Made of cast stainless steel.

Item#	Size	Max Load	Break Strength	Case
43451	3/16" x 2"	450 lbs.	4,000 lbs.	12
43461	1/4" x 2 1/4"	880 lbs.	5,000 lbs.	12
43471	5/16" x 3"	1,760 lbs.	8,800 lbs.	12

BOAT HOOK HOLDER



Made of stainless steel with a polished finish. Holds poles up to 1 1/2" diameter.

Item#	Size	Fastener	Pack	Case
71011	3 1/2" x 1"	#6	1 pr.	12

BOAT HOOK CLIP



Made of fiberglass reinforced black nylon. Holds poles up to 1 1/2" diameter.

Item#	Size	Fastener	Pack	Case
71001	2 3/8" L x 3/16" W	#8	1 pr.	12

SPRING CLAMP



Made of stainless steel with a polished finish. Fastens with #6 P.H. screws.

Item#	Size	Pack	Case
72011	5/8" - 1 1/4"	1 pr.	12
72031	1" - 1 3/4"	1 pr.	12

RUBBER STORAGE CLIP



Perfect solution for storing pole lights, boat hooks, gaffs, boat mops, etc. Made of molded black rubber, these clips will accommodate diameters of 3/4" to 1".

Item#	Size	Pack	Case
72051	2" x 1 5/8"	1 pr.	12

BOARDING LADDER



71550



71560

Non-anodized aluminum 7/8" tubing. Polyethylene steps, 11" hooks and support legs. Folds flat for storage. Portable, hooks to the boat gunwale. Weight capacity of 250 lbs.

71550: Width: 15". Height 36"
71560: Width: 15". Height 47"

Item#	Steps	Pkg.	Case
71550	3	Bulk	4
71560	4	Bulk	4

POLY SWIM PLATFORM



Maintenance-free. High strength polyethylene will not bleach, fade or crack. 7/8" dia. tubing is polished stainless steel. All stainless steel hardware included. 300 lb. capacity. Platform is 14" L x 18" W.

71501: One wraparound stainless steel rail. One underside bracket and support tube.
71521: Twin wraparound stainless steel rails.

Item#	Description	Case
71501	O/B Poly Swim Platform	1
71521	I/O Poly Swim Platform	1

UNIVERSAL SWIM PLATFORMS WITH TOP MOUNT LADDER



- Ladder is secured with a Velcro® strap when in the stowed position
- Fiberglass platform, stainless steel tubing
- Includes hardware for both outboard and inboard/outboard applications
- Telescoping capability
- Maintenance-free high strength platform
- Black plastic treads provide a secure stepping area
- All stainless steel hardware included
- 300 lb. Capacity
- Platform: 14" L x 18" W
- Ladder Overall Width: 12". Step Tread: 7.25" x 1.5"

71281: Length deployed: 21.5". Length stowed: 13.5"
71301: Length deployed: 34.5". Length stowed: 15"
71321: Length deployed: 46". Length stowed: 15.5"

Item#	Description	Steps	Case
71351	Ladder & Platform	2	2
71361	Ladder & Platform	3	2
71281	Ladder Only	2	5
71301	Ladder Only	3	5
71321	Ladder Only	4	5

DELUXE UNIVERSAL SWIM PLATFORM WITH SLIDE MOUNT TELESCOPING LADDER



Automatically locks into stowed position. To release press locking button on lower left rung.

- Fiberglass platform, stainless steel tubing
- Includes ladder and hardware for both outboard and inboard/outboard applications
- Telescoping
- Maintenance-free high strength platform
- Black plastic treads provide a secure stepping area
- All stainless steel hardware included
- 300 lb. Capacity
- Platform: 14" L x 18" W
- Ladder Overall Width: 11.75". Step Tread: 7.25" x 1.5"

Ladder Measurements

2 Step: Length deployed: 24". Length stowed: 14.75"
3 Step: Length deployed: 35". Length stowed: 15"

Item#	Description	Steps	Case
71181	Ladder & Platform	2	2
71191	Ladder & Platform	3	2
Repl. Parts	Description	Steps	Case
71241	Ladder Only	2	5
71251	Ladder Only	3	5

UNIVERSAL SWIM PLATFORM WITH UNDER MOUNT TELESCOPING LADDER



- Ladder is secured with a Velcro® strap when in the stowed position
- Fiberglass platform, stainless steel tubing
- Includes ladder and hardware for both outboard and inboard/outboard applications
- Telescoping
- Maintenance-free high strength platform
- Black plastic treads provide a secure stepping area
- All stainless steel hardware included
- 300 lb. Capacity
- Platform: 14" L x 18" W
- Ladder Overall Width: 11.25". Step Tread: 7.25" x 1.5"

Ladder Measurements

2 Step: Length deployed: 23". Length stowed: 13.5"
3 Step: Length deployed: 35". Length stowed: 14"

Item#	Description	Steps	Case
71201	Ladder & Platform	2	2
71211	Ladder & Platform	3	2
Repl. Parts	Description	Steps	Case
71261	Ladder Only	2	5
71271	Ladder Only	3	5



TELESCOPING TRANSOM MOUNT LADDER



71221: Length deployed: 23". Length stowed: 13.5"
 Overall Width: 13.5". Step Tread: 7.25" x 1.5"
71231: Length deployed: 31". Length stowed: 15".
 Overall Width: 13.5". Step Tread: 7.25" x 1.5"
 • Stainless Steel
 • Vertical surface mount
 • Black plastic treads provide a secure stepping area
 • 300 lb. Capacity

Item#	Steps	Case
71221	2	2
71231	3	2

LIP TRIM AND Q TRIM



Trims fiberglass, metal, plywood and glass edges. Installs fast and permanent without the use of adhesives on flanges with a 3/4" minimum radius and with 1/2" minimum clearance from the edge. Vinyl over aluminum.

Lip Trim: Use on flanges from .090" to .190" thick.
Q Trim: Use on flanges from .135" to .250" thick.

Item#	Description	Color	Length	Case
39001	Lip Trim	White	200 ft.	1
39011	Lip Trim	Black	200 ft.	1
39101	Q Trim	White	125 ft.	1
39111	Q Trim	Black	125 ft.	1

FISHING ACCESSORIES

COMPLETE OUTRIGGER KIT



• Complete kit to outfit any boat. Kit Contains:
 • (1 Set) 15' fiberglass outrigger poles (88201 or 88211)
 • (1 Set) Outrigger pole holders (88761)
 • (1 Kit) Rigging kit (88121)

Item#	Color	Size	Case
88251	White/Blue	15' Kit	1
88261	Black	15' Kit	1

OUTRIGGER POLES



• Telescoping fiberglass
 • 3-sections
 • Quality construction
 • Three chrome brass guides
 • Epoxy finish over fiberglass
 • Sold in pairs

Item#	Color	Retracted	Extended	Base	Pack	Case
88201	White / Blue	67"	15'	1 1/8"	1 pr.	1
88211	Black / Gold	67"	15'	1 1/8"	1 pr.	1

OUTRIGGER POLE HOLDER



For Fiberglass Poles Only. Made of heavy duty highly polished stamped stainless steel. Supplied with black rubber mounting pads. Adjustable tube positions. Fits standard fiberglass 1 1/8" ID base, 15' outrigger poles. Base: 30° (Dim: 4' x 2 3/8"). Fasten with #10 screws.

Item#	Description	Pack	Case
88770	Tube Only	Bulk	1
88780	Base Only	Bulk	1
88761	Outrigger Pole Holders	1 pr.	6

PREMIUM OUTRIGGER RIGGING KIT



Complete with release clips and stainless steel hardware. Rigs 1 pair of outriggers up to 22'.

Kit Contains:
 (2) Release clip
 (2) Shock cord w/SS snaps & pulley
 (2) 100 ft. UV Protected black dacron line
 (2) Barrel swivels
 (4) Snap swivels
 (2) Crimps
 (2) SS Eye Strap
 (2) Balsa wood floats
 (2) SS Screws

Item#	Case
88131	10

ULTIMATE OUTRIGGER RIGGING KIT



For poles up to 25 feet, Kit Contains:

• (2 Ea) Outrigger clips (88041)
 • (2 Ea.) Pro outrigger snubbers (88051)
 • (2 Ea.) Stainless Steel eye straps (28801)
 • (1 Ea.) #400 Black mono line - 100' (88061)
 • (4 Ea.) Line clamps

Item#	Case
88121	10

OUTRIGGER CLIP



Designed to keep rigger and fishing lines from fouling. Made of high impact nylon and has a tension adjustment and standard release clip.

Item#	Pack	Case
88041	1 pr.	12

BRAIDED UTILITY LINE



Made of synthetic fiber. Excellent all-purpose rigging rope. Strong, wear resistant, rot resistant. Great for outriggers, tie downs, etc.

Item#	Color	Size	Pack	Case
40151	White	1/8" x 100'	Bulk	6
40511	Black	1/8" x 100'	Bulk	6

MONO LINE



#400 black mono line. Included are four line clamps. Ideal for replacing rigging lines on all outrigger poles.

Item#	Length	Case
88061	100'	10

PRO OUTRIGGER SNUBBER



Plated, non-corrosive baby eye snapper with 1/4" bungee cord and glass ring. Ideal for outrigger line tension.

Item#	Length	Pack	Case
88051	10"	1 pr.	12

ROD HOLDER PLASTIC - 30°



89211, 89250, 89251: Injection molded ABS flange with heavy walled PVC tube.
89271, 89270: Molded high impact plastic. Etched finish on flange. One-piece construction. Non-corrosive. Uses (3) fasteners #12 for installation.
89221: Nylon reinforced with fiberglass. Stamped 304 stainless steel cover.
89231: Nylon reinforced with fiberglass. Stamped 304 stainless steel cover. Includes black rubber cap.

Item#	Flange	Size	Pack	Case
89211	White	9" L x 1 17/32" ID		10
89221	Stainless Steel	9" L x 1 17/32" ID		10
89231	Stainless Steel	9" L x 1 17/32" ID		10
89250	White	9 1/2" L x 1 5/8" ID	Bulk	12
89251	White	9 1/2" L x 1 5/8" ID		10
89270	Black	9 1/2" L x 1 5/8" ID	Bulk	12
89271	Black	9 1/2" L x 1 5/8" ID		10

ROD HOLDER STAINLESS STEEL - 30°



The mounting flange is made of heavy duty cast 316 stainless steel. 304 stainless steel tube with white vinyl liner for rod protection.

Item#	Finish	Flange	Size	Case
89021	Polished SS	4 1/2" L x 3 1/2" W	9" L x 1 5/8" ID	10

ROD HOLDER PLASTIC - 90°



One piece injection molded ABS plastic allows easy installation. Drain hole pre-drilled in bottom. Fasteners: #12

Item#	Finish	Flange	Size	Case
89301	ABS Plastic/Black	4" L x 2 1/2" W	9 1/2" L x 1 1/4" ID	10

ROD HOLDER STAINLESS STEEL



Made of 304 highly polished stamped stainless steel. Supplied with flange gasket and vinyl rod liner with cap. Fasteners: #14 screws (3).

Item#	Finish	Flange	Size	Case
89121	Polished SS	4 17/32" L x 3 1/2" W	9" L x 1 15/16" ID	10

SIDE MOUNT ROD HOLDER



Made of high density polyurethane. Accommodates standard rod grip sizes up to 1 3/4" (4.4 cm). Mounting spacers are permanently attached. Fasteners included. UV Resistant.

Item#	Size	Color	Case
89421	12" L x 1 3/4" ID	White	12
89461	12" L x 1 3/4" ID	Black	12

SIDE MOUNT ROD HOLDER



Excellent for where a flush mount holder cannot be installed.

Item#	Description	Size	Case
89311	SS tube and mounting brackets	9" L x 1 5/8" W	8
89321	PVC tube and Poly brackets	8 3/4" L x 1 3/4" W	6

ROD RACKS



Excellent alternative to the hassles of teak. Easily cleaned with soap and water. Made of high density polyurethane. Accommodates standard rod grip sizes up to 1 3/4" (4.4 cm). Mounting spacers are permanently attached. Fasteners included. UV Resistant.

Item#	Holds	Color	Size	Case
89401	2 Rods	White	8 3/4" W x 10 13/16" H	10
89441	2 Rods	Black	8 3/4" W x 10 13/16" H	10
89411	3 Rods	White	12 5/8" W x 10 13/16" H	10
89451	3 Rods	Black	12 5/8" W x 10 13/16" H	10

VERTICAL MOUNT FISHING ROD HOLDER



Made of 304 stainless steel. Black plastic liner.

Item#	Size	Fits	Case
89141	9" L x 1 3/4" ID	up to 1" Dia	8



CLAMP-ON FISHING ROD HOLDER



Made of 304 stainless steel. Black plastic liner. Can be used on vertical or horizontal rails.

Item#	Size	Fits	Case
89151	9" L x 1 1/4" ID	7/8" to 1" Dia	8

CHAIR ROD GIMBAL



Made of cast brass with a triple chrome plated finish. Projects 4 1/4" x 3 1/4" H x 4 1/4" W flat. Bolts under chair. Fastens with 1/4" screws.

Item#	Case
89181	8

ROD STORAGE HOLDER - 3 ROD



Will hold 3 fishing rods securely with slit closed cell foam inserts. Mounts horizontally or vertically. Pre-drilled mounting holes. 2 per set.

Item#	Material	Size	Pack	Case
89501	Black ABS Plastic	2 1/2" x 7.5" L	1 pr.	6

COURTESY LIGHT



05421

Clean-looking, functional and totally submersible waterproof light. Allows for a wide variety of uses in livewells, baitwells, storage lockers, rod lockers, swim platforms and stepwells. 4W 12V DC.

Item#	Description	Hole	Case
05421	Rear Mount	1"	12
Repl. Parts	Description	Pack	Case
09961	Bulb - Wedge Base 4W (GE 194)	1 pr.	12
09821	LED 13SMD T10 Wedge	1	12

LED BAITWELL/COURTESY LIGHT



05461

05451



Totally waterproof so it can be mounted underwater. Neoprene sealing gasket included. Bright 3-element LED bulb.

Item#	Hole	Size	Case
05461	5/8"	1/4" H x 1" dia.	12
05451	1"	3/8" H x 1 1/4" dia.	12

12V AERATION/PUMP SYSTEM



Convert any ice chest or bait bucket into a livewell.

- Use to fill or empty livewell
- Use as a wash-down system
- Use as a bilge pump
- Two year limited warranty

Item#	GPH	Outlet	Case
19481	360	3/4"	4

12V LIVE BAIT AERATOR KIT



Adjustable spray volume keeps bait alive longer. Includes foam filter, side-mount bracket, battery clips and super-strong suction cups.

- Easily converts any container to baitwell tank
- Use in salt or fresh water
- No drilling / no screws required
- Completely portable
- Two year limited warranty

Item#	GPH	Outlet	Volts	Case
19471	360	3/4"	12	12

LIVEWELL-BAITWELL PUMP



- Ignition protected
- Quiet running
- Marine grade tinned wires
- No burn out when run dry
- Both straight and angled fittings Included
- Two year limited warranty
- 12VDC

Item#	GPH	Outlet	Thread	Case
19461	600	3/4"	4" x 3/4"	12

BAIT TANK PLUMBING KIT



Kit Contains:

- (1) Overflow fitting with filter
- (1) Directional inlet
- (1) Drain plug

Item#	Hose	Case
89631	1 1/2" ID	12

THRU-HULL STRAINER MOUNT



For remote mounted pumps. Designed to enable a 3/4" thru-hull passage through a transom or livewell.

Item#	Max Panel Thickness	Case
18191	1 1/2"	12

MESH STRAINER



Stainless steel wire mesh strainer with 3/4"-14 female threads. Prevents trash, fish, scales, etc., from entering pumps.

Item#	Case
89621	12

STAINLESS STEEL DE-HOOKER



- 420 Stainless steel tube and plunger
- Non-slip molded handles for improved grip
- Spring-loaded for ease of use
- Adjustable lanyard

Item# 87051	Size 7½"	Case 10
-----------------------	--------------------	-------------------

ANODIZED FISHING PLIERS WITH CUTTER



- These pliers are a must have for the fisherman. The coiled tether, clasp and holster mean they will always be handy.
- Anodized air-craft grade aluminum - light weight, durable and corrosion resistant
 - Spring loaded handles keep pliers open and ready to use
 - Tungsten coated blades effortlessly cut mono, braid, fluorocarbon and light wire line
 - One year Limited Warranty

Item# 87010	Size 6½"	Pkg. Bulk	Case 12
87011	6½"	Card	12
Repl. Parts 87021	Description Blades w/ screws		Pack 1 (Pr.)

CERAMIC KNIFE SHARPENER



- Two stage sharpening: Fine Ceramic & Coarse Carbide
- Hard plastic case
- Pocket sized
- Carabiner clip included

Item# 46811	Size 2¼" x 1½" x 1"	Case 6
-----------------------	-------------------------------	------------------

New BONING KNIFE



- #4116 German stainless steel flex blade for excellent versatility
- Dupont™ Teflon® coated for easy cleaning and increased corrosion resistance
- Oversized rubber grip for maximum comfort and control
- Locking ported sheath for safety and blade protection

Item# 87131	Size 9.125"	Case 12
-----------------------	-----------------------	-------------------

STAINLESS STEEL FILET KNIFE



The knife's tapered razor sharp blade is made of German stainless steel and is sturdy yet flexible enough for delicate work. The blade features a serrated top for de-scaling and a line-cutter which is accessible even when the knife is in its sheath. Includes a vented, easy open, locking sheath for safe storage and easy cleaning. Lanyard ready, or hang from handle holes. The contoured white handle fits comfortably in the palm.

Item# 87101	Size 6"	Case 12
87121	9"	12

STAINLESS STEEL BAIT KNIFE



The perfect size for preparing bait and performing other boatside tasks. The stainless steel blade features a serrated top for de-scaling and a line-cutter which is accessible even when the knife is in its sheath. Includes a vented, easy open, locking sheath for safe storage and easy cleaning. Lanyard ready, or hang from handle holes. The contoured white handle fits comfortably in the palm. Minimum order 24 pcs for 87200 display bucket. Priced individually

Item# 87201	Pkg. Card	Pack 1	Case 12
87200	Bucket	24	1

12" LURE RACK



Large Super Suction™ cups. Mounts on any smooth surface. Non-corrosive, white. Each rack holds up to 25 baits plus a place for fillet knife. Can be permanently attached with screws.

Item# 79301	Case 6
-----------------------	------------------





CUBE® ELECTRONIC FUEL PUMP KIT



Compatible with gasoline, diesel, biodiesel, blended alcohol fuels and fuel additives. For 12 volt systems only. Not intended for aircraft use.

- Easy to install
- Coast Guard ignition test approved
- UL (574A) Certified
- Built-in Anti-Siphon Valve

- 74 Micron filter included
- Self-regulating
- Transient Protection
- Internal check valve, self-priming
- Reliable solid state design provides longer life
- Made in Made in U.S.A. by FACET

Item #	Lift	Thread	Check Valve
20311	60"	1/8" x 27	Yes
20341	60"	1/8" x 27	Yes
20351	60"	1/8" x 27	Yes
20321	96"	1/8" x 27	Yes

Item#	PSI	GPH	OEM #	Volts	Case
20311	5.0 - 3.5	19	40176	12	14
20341	4.5 - 3.0	30	40288	12	14
20351	7.0 - 4.0	30	40289	12	14
20321	11.5-9.0	32	40185	12	14

Repl. Parts	Description	Micron	Case
20401	Gas & Diesel Fuel Filter, 5/16" Barb - Steel	74	30
20381	Gas & Diesel Fuel Filter, 5/16" Barb- Clear	74	20
20391	Gas & Diesel Fuel Filter, 3/8" Barb - Clear	74	20

DURA-LIFT® ELECTRONIC FUEL PUMP



This solid state fuel pump can be used on: refrigeration trucks, marine generator sets, diesel filtration systems, industrial applications, and other diesel lift applications. Compatible with gasoline, diesel, biodiesel, blended alcohol fuels and fuel additives.

- Easy to install
- 4 Hour dry run
- 80 Micron stainless steel filter included
- Self-regulating
- Voltage spike protection

- Internal check valve
- Reliable solid state design provides longer life
- Made in U.S.A. by FACET

Item #	Lift	Thread	Check Valve
20331	120"	1/8" x 27	Yes

Item#	PSI	GPH	OEM #	Volts	Case
20331	11.5 - 9	33	FACET 40222	12	12

Repl. Parts	Description	Micron	Case
20371	Fuel Filter & Gasket	80	30

GOLD-FLO® HIGH PERFORMANCE ELECTRONIC FUEL PUMP KIT



This rugged, lightweight, solid state fuel pump provides the high output performance required by heavy duty construction, agricultural, industrial, marine or military equipment in addition to the power plant requirements of sports cars, sedans, light trucks and SUV's. Compatible with gasoline, diesel, biodiesel, blended alcohol fuels and fuel additives.

- Easy to install
- Coast Guard ignition test approved
- 74 Micron filter included
- Reliable solid state design provides longer life
- Made in U.S.A. by FACET

Item #	Lift	Thread	(+) Shut-off Valve
20301	24"	1/8" x 27	Yes
20291	24"	1/4" x 18	No

Item#	PSI	GPH	OEM #	Volts	Case
20301	5.5 - 4	34	40131E	12	14
20291	8.0 - 6.5	45	480532E	12	14

Repl. Parts	Description	Micron	Case
20361	Fuel Filter & Gasket	74	30

New TEMPERATURE SENDER



- Ground: Standard
- Connection: .250" Spade

Item#	Thread	Temp.	Case
15341	1/8-27 NPTF	250° F	12

New OIL PRESSURE SENDER



- 80PSI / 5 bar
 - Ground: Standard
- This sender has tapered threads and should NOT be used with thread seal tape or pipe sealant. This will interfere with grounding causing incorrect instrument readings.**

Item#	Thread	Terminal	Case
15351	1/8-27 NPTF	10-32 Stud	12

OUTBOARD ENGINE FUEL/WATER SEPARATING FILTER



Reusable see-thru plastic bowl with drain, and 10 micron filter (20951).

Item#	Application	Case
20931	Seachoice, Racor, Moeller, Yamaha, Suzuki, SMI, Volvo Penta, Sierra, Aqua Power, and other filter heads.	12

Repl. Parts	Description	Case
20951	Fuel/Water Separator Canister	48

INBOARD ENGINE FUEL/WATER SEPARATING FILTER



Metal bowl with 10 micron filter (20951).

Item#	Application	Case
20921	Seachoice, Racor, Moeller, SMI, Sierra, Aqua Power, and other filter heads.	12

Repl. Parts	Description	Case
20951	Fuel/Water Separator Canister	48

FUEL/WATER SEPARATOR AND CANISTER



28 Micron filter. Universal 3/8" Ports.

20901: Fits most 2 and 4 cycle gasoline engines. Powder coated bracket included. Includes 2 brass plugs. One complete set per box. **Replaces** Seachoice 20901, Valmar 52103, Sierra 78481, Moeller 03332010, Mercury 35-802893Q4

20911 Replacement Canister replaces: Seachoice 20911, Valmar 52113, Sierra 7844, Racor PFF 5510, Moeller 03332410, Mercury 35-802893Q01

Item#	Description	Case
20901	Fuel/Water Separator Kit	10

Repl. Parts	Description	Case
20911	Fuel/Water Separator Canister	48

IN-LINE FUEL FILTER



In-line style universal fuel filter replaces any 1/4", 5/8" or 3/8" filter. Protects all carbureted engines. Clear body permits visual inspection.

Item#	Description	Pack	Case
20941	Replacement Filters	3	12

Repl. Parts	Description	Pack	Case
20971	Replacement Filters	3	12

IN-LINE FUEL FILTER



Molded white plastic.

Item#	Barb	Application	Case
21101	1/4"	Mercury 35-16494 and 35-816296Q2	12
21111	3/16"	Mercury 35-816296-1, 35-16494, J/E 398327	12
21121	3/8"	J/E 398319	12

FUEL TANK HOLD DOWN KIT



Two 63" poly straps with quick release buckles. Mounting hardware included.

Item#	Pack	Case
78991	1 pr.	12

New FUEL SENDER REED SWITCH



Compatible with most fuel gauges on the market today, with 33 (full) and 240 (empty) ohm gauges, and no moving mechanical parts makes them extremely durable. Our senders feature stainless steel immersion tubes, corrosion resistant plated mounting flange and gasket (SAE 5 hole), and .250" insulated spade connectors.

Item#	Length	Case
15521	6"	1
15531	7"	1
15541	8"	1
15551	10"	1
15561	14"	1
15571	18"	1

ELECTRIC SENDING UNIT

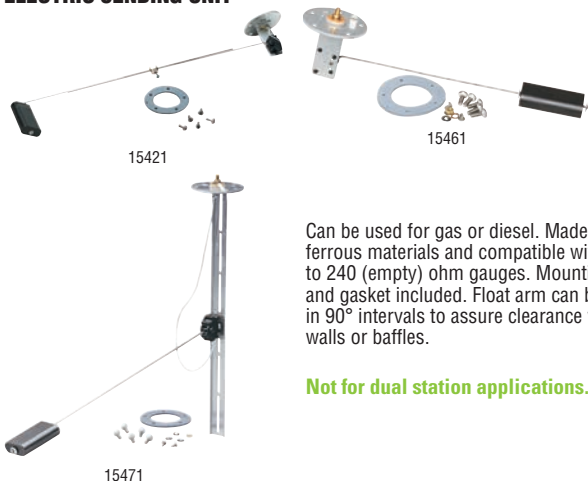

Can be used for gas or diesel. Made of non-ferrous materials and compatible with 35 (full) to 240 (empty) ohm gauges. Mounting screws and gasket included. Float arm can be rotated in 90° intervals to assure clearance with tank walls or baffles.

Not for dual station applications.

Item#	Tank Depth	Case
15421	6" to 27"	12
15461	6" to 12"	12
15471	4" to 24"	4

Repl. Parts	Description	Case
15511	Gasket Only	12

FUEL GAUGE KIT



Can be used for gas or diesel.

15501: Combination of 15421 and 15441.

15441: Fuel Gauge: Black bezel low profile fuel gauge for 12V negative ground systems. Use in conjunction with Model 15421 fuel sender. Complete with light kit.

15501: Not for dual station applications.

Item#	Description	Case
15501	Fuel Gauge Kit	12
15441	Fuel Gauge, Black Bezel	8

Repl. Parts	Description	Case
15511	Gasket Only	12

LOW PERM FUEL LINE KIT

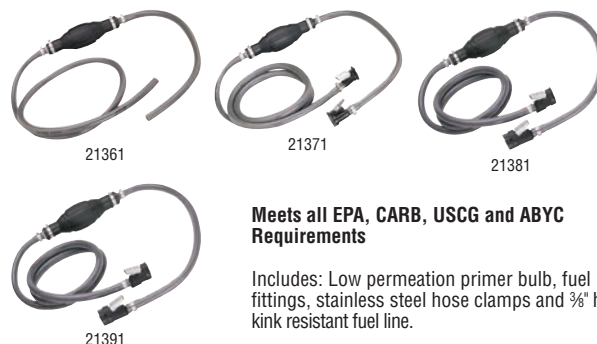

Meets all EPA, CARB, USCG and ABYC Requirements

Includes: Low permeation primer bulb, fuel line fittings, stainless steel hose clamps and 3/8" heavy duty, kink resistant fuel line.

- Fast priming high output primer bulb
- Kink resistant heavy duty fuel line
- Compatible with ethanol blended fuels
- Engineered low permeation material prevents fuel evaporation, saving fuel and money
- Bulb engineered to maintain flexibility and prevent collapse in hot and cold temperatures
- Industry leading vertical fuel draw for priming in any application

Item#	Application	Size	Case
21361	Universal (w/o connectors)	3/8" x 7'	6
21371	OMC/Johnson/Evinrude	3/8" x 7'	6
21381	Yamaha	3/8" x 7'	6
21391	Mercury	3/8" x 7'	6

FUEL HOSE EPA COMPLIANT



Type B1-15. ISO 8469

Used for repair and replacement on outboard engines.

- Complies with SAE J1527
- Class 1 and CE requirements.
- Meets new EPA requirements for low permeation hose

Item#	Type	ID	Length	Case
21231	B1-15	5/16"	50'	10
21221	B1-15	3/8"	50'	10



HOSE CLAMP



Made of stainless steel. Interlocked construction with no welds and no bumps. Exceeds all SAE requirements. 2 of each size per card.

Item#	Size	Pack	Case
23431	7/32" - 5/8" & 7/16" - 25/32"	4	12
23501	1/2" - 29/32" & 11/16" - 1 1/4"	4	12

LOW PERM PRIMER BULB



Meets all EPA, CARB, USCG and ABYC Requirements

High output primer bulb with 60% more output per pump than leading competitors. High flow double check valves ensure fast priming and low-restriction fuel flow to your engine. Compatible with ethanol blended fuels. Engineered low permeation material prevents primer bulb fuel evaporation, saving fuel and money while protecting air quality. Engineered to maintain flexibility and prevent collapse in extreme temperatures. Industry leading vertical fuel draw for priming in any application. Meets maximum 15 grams/m²/day permeation allowance as demonstrated through California Air Resources Board test TP-512.

Item#	Fits	Case
21321	5/16" ID Fuel Hose	12
21301	3/8" ID Fuel Hose	12

BRASS TEE FITTING



NOT TO BE USED IN POTABLE WATER SYSTEMS.
Used to withdraw fuel from a single tank for dual motors or to withdraw fuel from dual tanks for a single motor.

Item#	Connector	Thread	Case
20891	Female	1/4" NPT	12

MALE HOSE BARB



NOT TO BE USED IN POTABLE WATER SYSTEMS.
All brass machined fittings. Ideal for fuel fitting applications.

Item#	Thread	Hose	Case
20801	1/4" NPT	1/4"	12
20811	1/4" NPT	5/16"	12
20821	1/4" NPT	3/8"	12
20771	3/8" NPT	1/4"	12
20781	3/8" NPT	5/16"	12
20791	3/8" NPT	3/8"	12

FUEL CONNECTOR

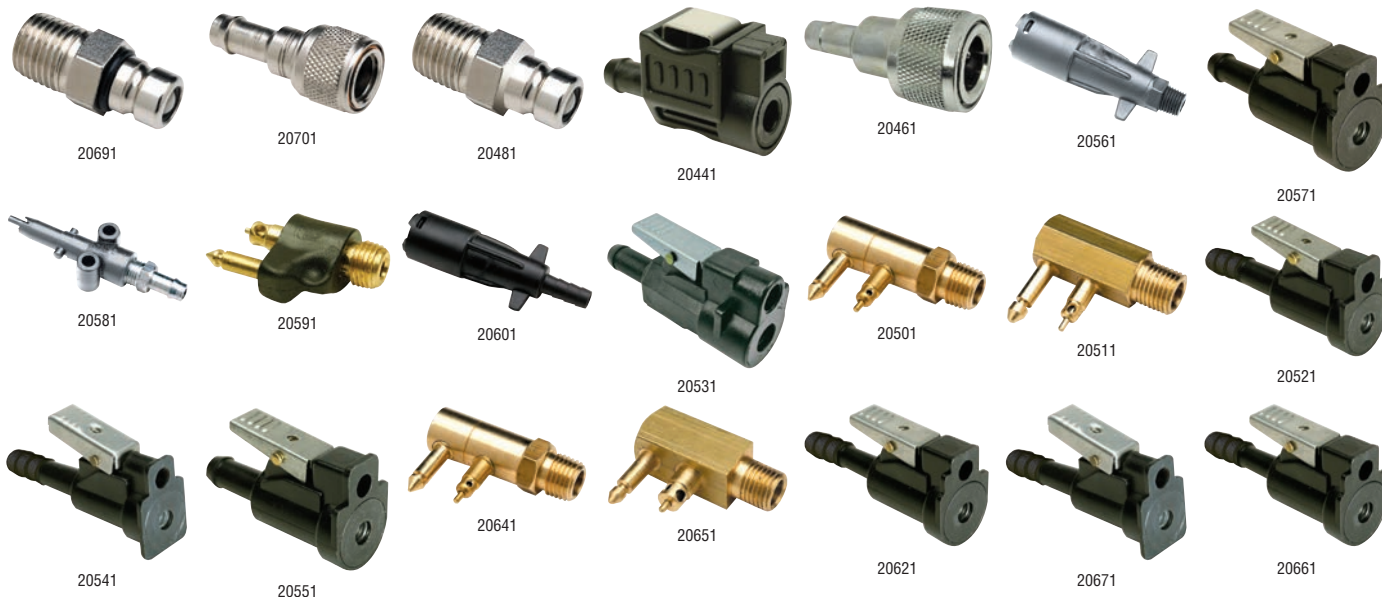

Precision engineered fuel connectors.

Item#	Connector	Fits	Material	Type	Thread	Hose	Case
20691	Tank Fitting - Male	Chrysler/Force	CP Brass	Deluxe	1/4" NPT	-	12
20701	Hose Fitting - Female	Chrysler/Force	CP Brass	Deluxe	-	3/8" Barb	12
20481	Tank Fitting - Male	Honda	CP Brass	Deluxe	1/4" NPT	-	12
20441	Hose Fitting - Female	Honda	Hi-Impact Nylon	Deluxe	-	3/8" Barb	12
20461	Hose Fitting - Female	Honda	Brass	Deluxe	-	3/8" Barb	12
20561	Tank Fitting - Female	Mercury/Mariner	Hi-Impact Nylon	Deluxe	1/4" NPT	-	12
20571	Hose Fitting - Female	Mercury/Mariner ('98 & Newer)	Hi-Impact Nylon	-	-	3/8" Barb	12
20581	Hose Fitting - Male	Mercury/Mariner	Hi-Impact Nylon	Deluxe	-	3/8" Barb	12
20591	Tank Fitting - Male	Mercury/Mariner ('98 & Newer)	Hi-Impact Nylon	Deluxe	1/4" NPT	-	12
20601	Hose Fitting - Female	Mercury/Mariner	Hi-Impact Nylon	Deluxe	-	3/8" Barb	12
20531	Tank Fitting - Female	Mercury/Mariner	Hi-Impact Nylon	Deluxe	-	3/8" Barb	12
20501	Tank Fitting - Male	OMC (Evinrude/Johnson)	Brass	Deluxe	1/4" NPT	-	12
20511	Tank Fitting - Male	OMC (Evinrude/Johnson)	Brass	Deluxe	1/4" NPT	-	12
20521	Hose Fitting - Female	OMC (Evinrude/Johnson)	Hi-Impact Nylon	Deluxe	-	3/8" Barb	12
20541	Hose Fitting - Female	OMC (Evinrude/Johnson)	Hi-Impact Nylon	-	-	3/8" Barb	12
20551	Hose Fitting - Female	OMC (Evinrude/Johnson)	Hi-Impact Nylon	Deluxe	-	3/8" Barb	12
20641	Tank Fitting - Male	Yamaha/Mercury/Mariner	Brass	-	1/4" NPT	-	12
20651	Tank Fitting - Male	Yamaha/Mercury/Mariner	Brass	Deluxe	1/4" NPT	-	12
20621	Hose Fitting - Female	Yamaha/Mercury/Mariner	Hi-Impact Nylon	Deluxe	-	3/8" Barb	12
20671	Hose Fitting - Female	Yamaha/Mercury/Mariner	Hi-Impact Nylon	-	-	3/8" Barb	12
20661	Hose Fitting - Female	Yamaha/Mercury/Mariner	Hi-Impact Nylon	Deluxe	-	3/8" Barb	12

90° FUEL ELBOW

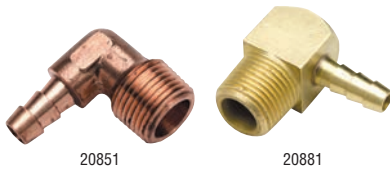

All brass machined fittings. Ideal for fuel fitting applications. Excellent for use with fuel/water separator where space is limited.

Not to be used in potable water systems.

Item#	Thread	Hose	Case
20851	1/4" NPT	3/8"	12
20861	3/8" NPT	3/8"	12
20871	3/8" NPT	5/16"	12
20881	3/8" NPT	1/4"	12

BRASS TANK VENT ELBOW



Designed for use where vertical space is limited. Replaces 3/8" plug on fuel tank.

Not to be used in potable water systems.

Item#	Thread	Case
20831	1/4" NPT	12
20841	3/8" NPT	12

BRASS TWO WAY FUEL LINE VALVE



Not to be used in potable water systems.

Item#	Size	Case
20721	1/4" x 1/4" NPT (Male/Female Ports)	12
20731	1/4" x 1/4" NPT (Female Ports)	12
20741	3/8" x 3/8" NPT (Female Ports)	12

THREE WAY FUEL LINE VALVE



- Female ports
- Brass
- Positive lock with audible click

Not to be used in potable water systems.

Item#	Size	Case
20751	1/4" x 1/4" x 1/4" NPT	12
20761	3/8" x 3/8" x 3/8" NPT	12

ALUMINUM ANTI-SIPHON VALVE



Coast Guard industry standards require anti-siphon protection on all gasoline powered boats. This valve combines anti-siphon protection with a convenient hose barb design. Made of corrosion resistant aluminum.

Item#	Thread	Hose	Case
20991	1/4" NPT	3/8" ID	12

GAS TANK VENT



23001: Reinforced black nylon with stainless steel screen flame arrestor.
23011: Meets USCG safety standards. Chrome plated zinc vent with removable wire screen flame arrestor.

Item#	Material	Hose	Max Hull Thickness	Case
23001	Nylon	5/8"	3/4"	12
23011	Chrome Plate Zinc	5/8"	3/4"	12

THRU-HULL VENT



Made of brass with a highly polished chrome plated finish. Two vent holes. Monel fire screen.

Item#	Type	Hose	Max Hull Thickness	Case
23031	Straight	5/16" or 5/8"	1/2"	12
23041	90°	5/16" or 5/8"	1/2"	12

90° FLUSH MOUNT FUEL VENT



Made of 316 stainless steel. On the exterior, they have a smooth edge over the competition. Unlike some others, there is no protruding cap to cause damage or be damaged by hull bumps and scrapes. Cap unscrews with hex head wrench for easy cleaning of filter and pressure testing of entire fuel system.

Item#	Hose	Max Hull Thickness	Hole	Case
23061	5/8" ID	7/8"	1 3/8"	12

VENTILATOR



Made of stamped stainless steel. Allows ventilation to confined areas. Will cover holes up to 2 1/2".

Item#	Size	Fastener	Case
16081	3 1/4" Dia.	#6 (4)	12





VENTILATOR

Great for routing cables.



16141

16101

Item#	Size	Screws	Case
Polished Stainless Steel			
16141	1 ²¹ / ₃₂ " x 1 ³ / ₄ " x 7 ¹ / ₁₆ "	#6	12
16151	2 ⁵ / ₃₂ " x 2 ¹ / ₈ " x 1 ⁹ / ₃₂ "	#6	12
16231	3 ³ / ₄ " x 3 ³ / ₄ " x 1 ⁷ / ₈ "	#6	12
Chrome Plated Brass			
16101	1 ¹ / ₁₆ " x 1 ¹ / ₂ " x 1 ⁵ / ₃₂ "	#4	12
16131	2" x 2 ³ / ₃₂ " x 1 ⁹ / ₃₂ "	#6	12
16201	3 ³ / ₄ " x 3 ³ / ₄ " x 1 ⁷ / ₈ "	#6	12

COWL VENTILATOR



Made of die cast zamak with a chrome finish. Black polypropylene flange. Pre-drilled for three screws.

Item#	Size	Fastener	Case
16031	5 ¹ / ₄ " L x 5 ⁷ / ₈ " W x 2 ¹ / ₄ " H	#8	12

New IN-LINE BILGE BLOWER



Spark proof. Blower meets or exceeds the following standards: ABYCH H-2, USCG 33 CFR Sections 183.410 and 183.425, ISO 8846 and 909, SAE J1171. Housing is molded, tough corrosion-proof ABS plastic. Rugged built-in mounting brackets for easy installation. Molded tabs on all hose flanges provide positive hose connections. Ignition protected. Spark proof. 18 gauge marine-grade tinned wire.

41861: 3" Intake, 3" exhaust with remote bracket. 5" length. 3⁷/₈" mounted height. CFM 170 air movement. Ignition protected 12V DC. Use 4 Amp fuse.
41871: 4" Intake, 4" exhaust with remote bracket. 5¹/₄" length. 4⁷/₈" mounted height. CFM 240 air movement. Ignition protected 12V DC. Use 4 Amp fuse.

Item#	Hose	CFM	Case
41871	3"	170	6
41861	4"	240	6

6" OSCILLATING FAN



Plastic base with power control toggle switch. The toggle switch on the motor housing controls the 90° oscillating motion and stationary position. Rust proof white vinyl coated fan guard. Dimensions: 9¹/₂" overall height, 6¹/₂" depth (front to back), 7" dia. fan guard, 6" fan blade, 3⁵/₈" x 1⁵/₈" base.

Item#	Size	Volts	Amps	Case
71451	6"	12	3	12

HATCH HOLDER



Made of 304 stainless steel. Recommended for hatches up to 10 lbs.

Item#	Size	Case
35871	8 ¹ / ₂ "	12

LID AND HATCH SUPPORT



Made of stainless steel with molded nylon mounting ends. Recommended for hatches up to 20 lbs.

Item#	Size	Case
35861	12"	12

FUNNEL



Fabricated of light-weight polyethylene. Allows access to hard to reach openings. **90210 & 90220:** 2-part funnel separates by twisting.

Item#	Description	Pack	Case
90200	Short Rigid	Bulk	12
90210	Long Flexible w/handle	Bulk	12
90220	Long Flexible w/ss strainer & handle	Bulk	24



MERCURY ALPHA ONE GEN I ANODE KIT



Cadmium free, environmentally friendly.
Aluminum: For salt and brackish water. Conform to: Mil-Spec A-24779(SH)
Magnesium: For freshwater only. Conform to: Mil-Spec A-21412(SH)
Includes:

- Block anode for gimbal housing (1)
- Skeg for ventilation plate (1)
- Nut for stern drive (2)
- 18-8/304 Stainless steel screws

Item#	Fits	Material	Case
95001	1984-1990	Aluminum	6
95011	1984-1990	Magnesium	6

MERCURY ALPHA ONE GEN II ANODE KIT



Cadmium free, environmentally friendly.
Aluminum: For salt and brackish water. Conform to: Mil-Spec A-24779(SH)
Magnesium: For freshwater only. Conform to: Mil-Spec A-21412(SH)
Includes:

- Block anode for gimbal housing (1)
- Anode plate for top of ventilation plate (1)
- Skeg for ventilation plate (1)
- Collar anode for trim rams (2)
- Anode collar between prop and gear housing (1)
- 18-8/304 Stainless steel screws

Item#	Material	Case
95021	Aluminum	7
95031	Magnesium	7

MERCURY BRAVO ONE ANODE KIT



Cadmium free, environmentally friendly.
Aluminum: For salt and brackish water. Conform to: Mil-Spec A-24779(SH)
Magnesium: For freshwater only. Conform to: Mil-Spec A-21412(SH).
Includes:

- Anode plate for top of ventilation plate (1)
- Skeg for ventilation plate (1)
- Anode collar between prop and gear housing (1)
- Collar anode for trim rams (2)
- 18-8/304 Stainless steel screws

Item#	Material	Case
95041	Aluminum	8
95051	Magnesium	8

MERCURY BRAVO II-III ANODE KIT



Cadmium free, environmentally friendly.
Aluminum: For salt and brackish water. Conform to: Mil-Spec A-24779(SH)
Magnesium: For freshwater only. Conform to: Mil-Spec A-21412(SH)
Includes:

- Anode plate for top of ventilation plate (1)
- Skeg for ventilation plate (1)
- Collar anode for trim rams (2)
- 18-8/304 Stainless steel screws

Item#	Fits	Material	Case
95061	Bravo II 1989-Pres. Bravo III 1989-2003	Aluminum	8
95071	Bravo II 1989-Pres. Bravo III 1989-2003	Magnesium	8

MERCURY BRAVO III, 2004 ANODE KIT



Cadmium free, environmentally friendly.
Aluminum: For salt and brackish water. Conform to: Mil-Spec A-24779(SH)
Magnesium: For freshwater only. Conform to: Mil-Spec A-21412(SH)
Includes:

- Anode plate for top of ventilation plate (1)
- Skeg for ventilation plate (2)
- Collar anode for trim rams (3, various)
- Prop nut anode (1)
- 18-8/304 Stainless steel screws

Item#	Fits	Material	Case
95081	2004-present	Aluminum	6
95091	2004-present	Magnesium	6

MERCURY VERADO 4 ANODE KIT

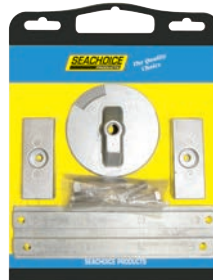

Cadmium free, environmentally friendly.
Aluminum: For salt and brackish water. Conform to: Mil-Spec A-24779(SH)
Magnesium: For freshwater only. Conform to: Mil-Spec A-21412(SH)
Includes:

- Block anode for gimbal housing (1)
- Plates for side of lower unit (2)
- Skeg for ventilation plate (1)
- 18-8/304 Stainless steel screws

Item#	Fits	Material	Case
95101	4 Cylinder	Aluminum	10
95111	4 Cylinder	Magnesium	10

MERCURY VERADO 6 ANODE KIT



Cadmium free, environmentally friendly.
Aluminum: For salt and brackish water. Conform to: Mil-Spec A-24779(SH)
Magnesium: For freshwater only. Conform to: Mil-Spec A-21412(SH)
Includes:

- Block anode for gimbal housing (5)
- Skeg for ventilation plate (1)
- Plates for side of lower unit (2)
- 18-8/304 Stainless steel screws

Item#	Fits	Material	Case
95121	6 Cylinder	Aluminum	10
95131	6 Cylinder	Magnesium	10

SUZUKI ANODE KITS



40-50 HP



90-140 HP

Cadmium free, environmentally friendly.
Aluminum: For salt and brackish water. Conform to: Mil-Spec A-24779(SH)
Magnesium: For freshwater only. Conform to: Mil-Spec A-21412(SH)

95451, 95461 Includes:

- Block anode for lower bracket unit (2)
- Skeg anode (1)
- Button anode for engine cooling system (4)

95431, 95441 Includes:

- Block anode for lower unit (1)
- Bar anode for mounting bracket (1)
- Button anode for lower unit and engine cooler system (4)

Item#	Fits	Material	Case
95451	40-50 HP	Aluminum	12
95461	40-50 HP	Magnesium	12
95431	90-140 HP	Aluminum	12
95441	90-140 HP	Magnesium	12



YAMAHA ANODE KITS



Cadmium free, environmentally friendly.
Aluminum: For salt and brackish water. Conform to: Mil-Spec A-24779(SH)
Magnesium: For freshwater only. Conform to: Mil-Spec A-21412(SH)
Includes:

- Block anode for gimbal housing (1)
- Skeg for ventilation plate (1)

Item#	Fits	Material	Case
95201	1200 HP Counter Rotation	Aluminum	4
95211	1200 HP	Aluminum	4
95231	200-250 HP	Aluminum	4
95251	200-300 HP	Aluminum	4
95221	1200 HP	Magnesium	4
95241	200-250 HP	Magnesium	4

HONDA BF ANODE KIT



Cadmium free, environmentally friendly.
Aluminum: For salt and brackish water. Conform to: Mil-Spec A-24779(SH)
Magnesium: For freshwater only. Conform to: Mil-Spec A-21412(SH)
Includes:

- Skeg anode (1)
- Bar anode for Bracket (1)
- Block anode for lower unit (2)

Item#	Material	Case
95411	Aluminum	12
95421	Magnesium	12

VOLVO ANODE KITS



290 HP



290 HP Dual Prop



DPH/DPR



SXA/DPSA



SX

Cadmium free, environmentally friendly.
Aluminum: For salt and brackish water. Conform to: Mil-Spec A-24779(SH)
Magnesium: For freshwater only. Conform to: Mil-Spec A-21412(SH)
290 HP & 290 HP Dual Prop - Include:

- Anode collar between prop and gear housing (1)
- Block anode for gimbal housing (1)
- 18-8/304 Stainless steel screws

DPH/DPR, SXA/DPSA & SX - Include:

- Anode plate for top of ventilation plate (1)
- Block anode for gimbal housing (1)
- 18-8/304 Stainless steel screws

Item#	Fits	Material	Case
95301	290 HP	Aluminum	7
95311	290 HP Dual Prop	Aluminum	7
95321	DPH/DPR	Aluminum	12
95331	SXA/DPSA	Aluminum	8
95341	SX	Aluminum	6
95351	290 HP	Magnesium	7
95361	290 HP Dual Prop	Magnesium	7
95371	DPH/DPR	Magnesium	12
95381	SXA/DPSA	Magnesium	8

ANCHORING

ANCHOR RACK DISPLAY

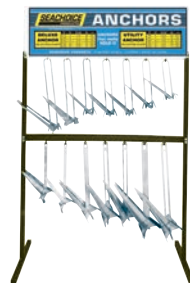

A cost effective way of displaying anchors. 48" wide unit with self-selling header which draws customers' attention. Display features adjustable rack and can hold between 14 and 20 anchors depending on size. **Anchors not included.**

Item#	Description
RACKANCHOR	Rack and Sign
HEADERRACKSIGN	Sign Only

UTILITY ANCHOR



Quality at an economical price. Great holding power at a price everyone will enjoy. Hot dipped galvanized for maximum corrosion protection. Each anchor is individually inspected for quality and workmanship. The effective slip-ring design assures easy retrieval. Single piece crown construction for extra anchor strength. Firm penetration is attained by special fluke strengthening design.

Item#	Size	Length	Stock Width	Fluke Length	Boat Size	Line	Chain	Case
41600	5E	11 1/2"	11 1/2"	8 1/2"	10'-15'	3/8"	3/16" x 4'	20
41610	7E	14 1/2"	12 3/4"	9"	15'-19'	3/8"	1/4" x 4'	20
41620	10E	16 3/4"	14 1/2"	9 1/2"	20'-24'	3/8"	1/4" x 4'	14
41630	13E	19 1/2"	18"	11 1/4"	25'-28'	3/8"	1/4" x 4'	6
41640	15E	21 3/4"	18"	13"	28'-30'	1/2"	5/16" x 5'	6



DELUXE ANCHOR

Dollar for dollar your best buy in anchors. Superior holding power in a traditional designed anchor. Each anchor is hot dipped galvanized for maximum corrosion protection. Individually inspected to assure quality and workmanship. Reinforced wide flukes penetrate deeply and firmly for maximum holding power. Specially engineered angles and welded crown configuration provide unsurpassed strength and durability.

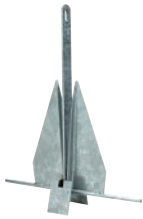

Item#	Size	Length	Stock Width	Fluke Length	Boat Size	Line	Chain	Pack	Case
41710	4S	19 1/4"	14 3/4"	9 1/2"	12'-16'	3/8"	3/16" x 4'		20
41720	8S	22 1/2"	18"	11 3/4"	17'-24'	3/8"	1/4" x 4'		8
41730	13S	27 1/8"	21"	14 1/2"	25'-30'	3/8"	5/16" x 5'	Bulk	1
41740	18S	30"	24 1/4"	16 1/2"	31'-34'	3/8"	5/16" x 5'	Bulk	1
41750	22S	34 3/4"	26 3/4"	19"	35'-38'	1/2"	5/16" x 5'	Bulk	1
41760	43S	40 3/4"	31 1/2"	22"	39'-45'	1/2"	5/16" x 5'	Bulk	1

CLAW ANCHOR



Hot dipped galvanized for lasting corrosion protection. Designed for use in various sea beds, tides and wind conditions. Stows easily on bow roller.

Item#	Weight	Boat Size	Case
41650	4.4 lbs.	18'	1
41660	11 lbs.	23'	1
41670	16 1/2 lbs.	30'	1
41680	22 lbs.	30'	1
41690	33 lbs.	40'	1
41700	44 lbs.	47'	1

NAVY ANCHOR



Aluminum painted iron. Double-dipped painted aluminum for rust resistance. Large cast rope eye. For use in gravel, stone and shale bottoms.

Item#	Weight	Pack	Case
41360	10 lbs.	Bulk	4
41370	15 lbs.	Bulk	4
41380	20 lbs.	Bulk	4

ANCHOR KIT



41722



41622



41732

Kit Contains:

- One (1) Anchor
- One (1) Anchor Lead Chain
- One (1) Nylon Anchor Line
- Anchor Lead Chain with Shackle:** Hot Dipped Galvanized proof coil anchor lead chain 1/4" x 4' with two (2) 3/8" shackles.
- Nylon Anchor Line:** 3/8" x 150'
- Anchors:** Each anchor is hot dipped galvanized for maximum corrosion protection

Item#	Model	Boat Size
41722	8S Deluxe (41720)	17'-24'
41622	10E Utility (41620)	20'-24'
41732	13S Deluxe (41730)	25'-30'

PLOW ANCHOR



Hot dipped galvanized for lasting corrosion protection. Quick setting geometric design provides stability and high holding power. Perfect for sand, pebble, rock, grass, kelp and coral bottoms.

Item#	Weight	Anchor Size	Boat Size	Case
41540	14 lbs.	21 1/4" L x 8" W	24 - 31'	1
41550	22 lbs.	24 1/2" L x 12 3/4" W	32 - 41'	1
41560	35 lbs.	28 3/4" L x 10 3/4" W	42 - 52'	1
41570	44 lbs.	34 1/4" L x 15 1/2" W	47 - 58'	1

FOLDING GRAPNEL ANCHOR



Anchor Closed

Made of malleable iron, heavily galvanized. Operates and folds up easily to store. Lockable in open and closed position. Great for small craft and dinghies.

Item#	Weight	Pack	Case
41050	1 1/2 lbs.	Bulk	6
41000	3 1/2 lbs.	Bulk	6
41010	5 1/2 lbs.	Bulk	4
41020	7 lbs.	Bulk	4
41030	9 lbs.	Bulk	4
41040	13 lbs.	Bulk	4





GALVANIZED ANCHOR LEAD CHAIN WITH SHACKLES



Hot dipped galvanized proof coil anchor lead chain supplied with 2 hot dipped galvanized shackles. Grade 30.

Item#	Size	Shackle	Work Load	Break Strength	Boat Size	Case
44101	3/16" x 4'	1/4"	705 lbs.	3,000 lbs.	10' - 15'	10
44121	1/4" x 4'	5/16"	1,250 lbs.	5,000 lbs.	16' - 32'	5
44141	5/16" x 5'	3/8"	1,875 lbs.	7,500 lbs.	26' - 40'	3

GRAPNEL ANCHOR KIT



For boats, sailboats, PWC and canoes. Use in sand, rock, mud and gravel bottoms. Painted hot dipped galvanized iron with forged flukes. Includes: Anchor, Anchor Line, Adjustable Buoy, Stainless Steel Hook and Storage Bag.

Item#	Weight	Line Size	Boat Size	Case
41002	3.5 lb.	1/4" x 25'	5' - 12'	6

RIVER ANCHOR



Vinyl coated iron anchors. Will catch and hold to rough bottom. Penetrates better than regular mushroom anchors.

Item#	Weight	Color	Case
41500	12 lbs.	Black	4
41510	15 lbs.	Black	4
41520	20 lbs.	Black	2
41530	30 lbs.	Black	2

MUSHROOM ANCHOR



Vinyl Coated

Aluminum Paint

Aluminum painted iron with a vinyl coating. For small boats and mooring buoys. One-piece cast iron in two coating choices: double dipped painted aluminum for rust resistance and heavy gauge black vinyl for hull protection. Most effective in sand or mud.

Item#	Weight	Boat Size	Color	Pack	Case
41200	8 lbs.	Up to 10'	Vinyl Coated	Bulk	4
41220	10 lbs.	Up to 12'	Vinyl Coated	Bulk	4
41260	15 lbs.	Up to 16'	Vinyl Coated	Bulk	4
41270	20 lbs.	Up to 24'	Vinyl Coated	Bulk	2
41250	30 lbs.	-	Vinyl Coated	Bulk	2
41280	8 lbs.	Up to 10'	Aluminum Painted	Bulk	4
41300	10 lbs.	Up to 12'	Aluminum Painted	Bulk	4
41340	15 lbs.	Up to 16'	Aluminum Painted	Bulk	4
41350	20 lbs.	Up to 24'	Aluminum Painted	Bulk	2

LIFT 'N' LOCK ANCHOR CONTROL



Zinc plated steel anchor lift and nylon pulley system. Zinc plated steel sleeve controls anchor from any position. Accommodates 1/4" to 7/16" diameter line. Supports anchors up to 20 lbs.

Item#	Case
41481	12

PVC COATED ANCHOR LEAD CHAIN



White PVC coated galvanized proof coil chain. Grade G4. Oversized links on both ends.

Note: Recommendations vary based on displacement of boat. For example, a heavy displacement boat would require a larger diameter chain.

Item#	Size	Boat Size	Case
44401	3/16" x 4'	Up to 27'	10
44421	1/4" x 4'	Up to 32'	10
44441	5/16" x 5'	Up to 40'	6
44461	3/8" x 6'	Up to 54'	4

PROOF COIL CHAIN



Hot dipped galvanized-Grade 30. Packed in 100 lb. plastic pails.

Item#	Size	Work Load	Break Strength	Case
44251	3/16" x 250'	705 lbs.	3,000 lbs.	1
44261	1/4" x 141'	1,250 lbs.	5,000 lbs.	1
44271	5/16" x 92'	1,875 lbs.	7,500 lbs.	1
44281	3/8" x 63'	2,625 lbs.	10,500 lbs.	1

ROPE DECK PIPE



Made of hand cast brass with a triple chrome plated finish. Flange diameter 3 1/4" x 1 1/2" ID. Accommodates rope up to 3/8".

Item#	Description	Fastener	Case
33021	Hinged	#8	12

ANCHOR SWIVEL



Made of 316 stainless steel. Used between anchor and lead chain or between chain and anchor line. Prevents chain and anchor rope from getting twisted.

Item#	Length	Anchor Side	Chain Side	Case
44501	3 1/2"	5/8"	3/32"	6
44511	4 5/8"	7/8"	1/2"	6
44521	6"	1 3/16"	9/16"	6

STAINLESS STEEL ANCHOR SHACKLE



Made of 316 forged stainless steel.

Item#	Size	Max Load	Break Strength	Pack	Pkg.	Case
43151	3/16"	600 lbs.	3,000 lbs.	1	Card	12
43161	1/4"	600 lbs.	3,000 lbs.	1	Card	12
43160	1/4"	600 lbs.	3,000 lbs.	3	Bulk	12
43171	5/16"	1,000 lbs.	5,000 lbs.	1	Card	12
43170	5/16"	1,000 lbs.	5,000 lbs.	2	Bulk	12
43181	3/8"	1,600 lbs.	8,000 lbs.	1	Card	12
43180	3/8"	1,600 lbs.	8,000 lbs.	2	Bulk	12
43201	1/2"	2,000 lbs.	10,000 lbs.	1	Card	12



GALVANIZED ANCHOR SHACKLE



43040

Weldless, drop forged, galvanized to mil-spec. Packed 2 per card except for 1/2", single packed.

Item#	Size	Max Load	Break Strength	Pack	Pkg.	Case
43040	3/16"	275 lbs.	1,100 lbs.		Bulk	1
43051	1/4"	1,100 lbs.	4,400 lbs.	1 pr.	Card	12
43050	1/4"	1,100 lbs.	4,400 lbs.		Bulk	1
43061	5/16"	1,650 lbs.	6,600 lbs.	1 pr.	Card	12
43060	5/16"	1,650 lbs.	6,600 lbs.		Bulk	1
43071	3/8"	2,200 lbs.	8,800 lbs.	1 pr.	Card	12
43070	3/8"	2,200 lbs.	8,800 lbs.		Bulk	1
43080	7/16"	3,300 lbs.	13,200 lbs.		Bulk	1
43091	1/2"	4,400 lbs.	17,600 lbs.	1 pr.	Card	12
43090	1/2"	4,400 lbs.	17,600 lbs.		Bulk	1
43110	5/8"	6,150 lbs.	20,600 lbs.		Bulk	1
43120	3/4"	7,164 lbs.	31,800 lbs.		Bulk	1
43130	7/8"	9,369 lbs.	39,682 lbs.		Bulk	1
43140	1"	10,000 lbs.	44,000 lbs.		Bulk	1
43150	1 1/4"	14,000 lbs.	60,000 lbs.		Bulk	1

D ANCHOR SHACKLE



Made of 316 stainless steel.

Item#	Size	Max Load	Break Strength	Pack	Pkg.	Case
44581	3/16"	700 lbs.	2,800 lbs.	1	Card	12
44591	1/4"	900 lbs.	3,900 lbs.	1	Card	12
44601	5/16"	1,900 lbs.	7,700 lbs.	1	Card	12
44611	3/8"	2,900 lbs.	11,900 lbs.	1	Card	12
44621	1/2"	6,100 lbs.	24,700 lbs.	1	Card	12

TWISTED ANCHOR SHACKLE



Made of 316 stainless steel.

Item#	Size	Max Load	Break Strength	Pack	Pkg.	Case
44651	3/16"	700 lbs.	2,800 lbs.	1	Card	12
44661	1/4"	900 lbs.	3,900 lbs.	1	Card	12
44671	5/16"	1,900 lbs.	7,700 lbs.	1	Card	12
44681	3/8"	2,900 lbs.	11,900 lbs.	1	Card	12
44691	1/2"	6,100 lbs.	24,700 lbs.	1	Card	12

GALVANIZED WIRE ROPE THIMBLE



Wire rope style thimbles. Meets federal specs. FFT- 276b type 2.

Item#	Size	Pack	Pkg.	Case
43331	3/8"	2	Card	12
43330	3/8"		Bulk	1
43341	1/2"	1	Card	12
43340	1/2"		Bulk	1
43351	5/8"	1	Card	12
43350	5/8"		Bulk	1

STAINLESS STEEL WIRE ROPE THIMBLE



Wire rope style thimbles. Meets federal specs. FFT- 276b type 2.

Item#	Size	Pack	Pkg.	Case
43391	3/16"	2	Card	12
43401	1/4"	2	Card	12
43411	5/16"	2	Card	12
43421	3/8"	2	Card	12
43431	1/2"	2	Card	12
43370	5/8"		Bulk	1
43380	3/4"		Bulk	1

AUTOMATIC FENDER ADJUSTER



For use with wooden rails and pipe rails. Makes placing fenders easy. Eliminates tying/untying fender lines. Instant self locking action works automatically to raise and lower the fender and hold it securely in place. White vinyl strap w/stainless steel hardware. Snaps around rails. Accommodates up to 1/2" diameter line.

Item#	Case
79101	12

FENDER LOCK



Made of stainless steel. Eye is to be permanently attached to fender line.

Item#	Description	Eye	Fastener	Pack	Flange	Case
30121	Lock	3/8" ID	#8	2	1 1/2"	12
Opt. Accy. 30131	Spare Eye Only	3/8"		2		12

TWIN EYE FENDER



Roto-molded fenders are manufactured from Marine Grade vinyl for superior strength, cushioning and a high gloss finish. Recessed valve to prevent valve lug from pulling away from fender. Valve plug housing molded into fender. Heavy-duty integral lugs for longer durability. Rotomolded for even wall thickness. Unique quality ribbed material ensures softness.

Item#	Size	Color	Eye	Boat Size	Case
79001	4.5" x 16"	White	1/2"	10'-20'	12
79011	5.5" x 20"	White	5/8"	15'-20'	6
79021	6.5" x 23"	White	3/4"	20'-25'	6
79031	8.5" x 27"	White	3/4"	25'-35'	4
79041	4.5" x 16"	Black	1/2"	10'-20'	12
79051	5.5" x 20"	Black	5/8"	15'-20'	6
79061	6.5" x 23"	Black	3/4"	20'-25'	6
79071	8.5" x 27"	Black	3/4"	25'-35'	4
79081	5.5" x 20"	Blue	5/8"	15'-20'	6

TWIN EYE FENDER KIT - 2 PACK



Includes two 3/8" x 5' double braided MFP fender lines with a reinforced nylon mesh loop on one end and two twin eye fenders. The fenders are Roto-molded and manufactured from Marine Grade vinyl for superior strength, cushioning and a high gloss finish. Recessed valve to prevent valve lug from pulling away from fender. Valve plug housing molded into fender. Heavy-duty integral lugs for longer durability. Roto-molded for even wall thickness. Unique quality ribbed material ensures softness.

Item#	Size	Color	Boat Size	Case
79251	5.5" x 20"	White	15'-20'	3
79271	6.5" x 23"	White	20'-25'	3
79261	5.5" x 20"	Black	15'-20'	3
79281	6.5" x 23"	Black	20'-25'	3



TWIN EYE FENDER KIT - 4 PACK



- Finest grade marine vinyl
- High gloss finish
- Soft and durable
- One piece construction
- Rubber inflation valve
- Includes four 1/4" x 5' double braided MFP fender lines

Item#	Size	Color	Boat Size	Case
79291	4.5" x 16"	White	10'-20'	4

CENTER HOLE FENDER



Center Hole Roto-molded fenders are manufactured from Marine Grade vinyl for superior strength, cushioning and a high gloss finish. The valve plug housing is molded into the fender and recessed to prevent the valve lug from pulling away. Heavy-duty integral lugs for longer durability. Rotomolded for even wall thickness. Center Hole fenders have a central tube through the center to allow end-to-end line passage and the unique quality ribbed material ensures softness. Fenders can be hung vertically or horizontally with a single line. The ribbed design adds additional strength and abrasion resistance while minimizing rolling.

Item#	Size	Color	Eye	Boat Size	Case
79111	6" x 15"	White	5/8"	20'-25'	6
79121	8" x 20"	White	5/8"	25'-35'	6
79131	10" x 25"	White	5/8"	35'-50'	4
79141	6" x 15"	Black	5/8"	20'-25'	6
79151	8" x 20"	Black	5/8"	25'-35'	6
79161	10" x 25"	Black	5/8"	35'-50'	4

DOUBLE BRAIDED NYLON FENDER LINE



Premium double braid. Spliced on one end

Item#	Size	Color	Pack	Case
40861	1/4" x 6'	Black	2	12
40831	1/4" x 6'	Blue	2	12
40911	1/4" x 6'	Burgundy	2	12
40851	1/4" x 6'	Forrest Green	2	12
41891	1/4" x 6'	Gold/White	2	12
40881	1/4" x 6'	Navy	2	12
40891	1/4" x 6'	Purple	2	12
40841	1/4" x 6'	Red	2	12
40871	1/4" x 6'	Teal	2	12
40901	1/4" x 6'	White	2	12
40821	1/4" x 6'	Yellow	2	12
40961	3/8" x 6'	Black	2	12
40931	3/8" x 6'	Blue	2	12
40981	3/8" x 6'	Burgundy	2	12
40951	3/8" x 6'	Forrest Green	2	12
40991	3/8" x 6'	Gold/White	2	12
40971	3/8" x 6'	Navy	2	12
40941	3/8" x 6'	Red	2	12
40921	3/8" x 6'	White	2	12

DOUBLE BRAIDED 100% MFP DOCK LINE

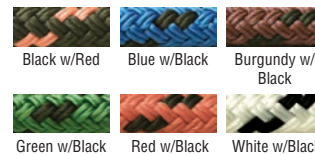

New high tenacity, colored, braided, polypropylene line. Made of non-stretch material that floats. Clamshell packed.

Item#	Color	Size	Case
42431	Black w/ Red Tracer	3/8" x 15'	12
42411	Blue w/ Black Tracer	3/8" x 15'	12
42451	Burgundy w/ Black Tracer	3/8" x 15'	12
42441	Green w/ Black Tracer	3/8" x 15'	12
42421	Red w/ Black Tracer	3/8" x 15'	12
42401	White w/ Black Tracer	3/8" x 15'	12

PREMIUM THREE STRAND TWISTED NYLON DOCK LINE WITH TRACER



Extremely strong rope with 10" eye splice (3/4" rope: 18" eye splice). Designed to absorb sudden shock loads. Very good resistance to abrasion, rot, oils, gasoline and marine growth. Clamshell packed. White with contrasting blue tracer.

Item#	Color	Size	Case
47501	White/Blue Tracer	3/8" x 10'	12
47511	White/Blue Tracer	3/8" x 15'	12
47521	White/Blue Tracer	3/8" x 20'	12
47531	White/Blue Tracer	3/8" x 25'	12
47551	White/Blue Tracer	1/2" x 15'	12
47561	White/Blue Tracer	1/2" x 20'	12
47571	White/Blue Tracer	1/2" x 25'	12
47581	White/Blue Tracer	1/2" x 30'	6
47591	White/Blue Tracer	5/8" x 20'	6
47601	White/Blue Tracer	5/8" x 25'	6
47611	White/Blue Tracer	5/8" x 30'	6
47621	White/Blue Tracer	5/8" x 35'	6
47631	White/Blue Tracer	3/4" x 25'	6
47641	White/Blue Tracer	3/4" x 35'	6
47651	White/Blue Tracer	3/4" x 50'	4

3-STRAND TWISTED NYLON DOCK LINE



Extremely strong rope with 10" eye splice (3/4" rope: 18" eye splice). Designed to absorb sudden shock loads. Very good resistance to abrasion, rot, oils, gasoline and marine growth. Clamshell packed.

Item#	Color	Size	Case
42501	White	3/8" x 10'	12
42511	White	3/8" x 15'	12
42521	White	3/8" x 20'	12
42531	White	3/8" x 25'	12
42551	White	1/2" x 15'	12
42561	White	1/2" x 20'	12
42571	White	1/2" x 25'	12
42581	White	1/2" x 30'	6
42591	White	5/8" x 20'	6
42601	White	5/8" x 25'	6
42611	White	5/8" x 30'	6
42621	White	5/8" x 35'	6
42631	White	3/4" x 25'	6
42641	White	3/4" x 35'	6
42651	White	3/4" x 50'	4



DOUBLE BRAID NYLON DOCK LINE



Premium double braid dock lines complete with 15" eye splice (3/4" rope: 18" eye splice). Pre-shrunk and heat stabilized. These lines offer higher wet strength and better abrasion resistance than other nylons. Won't mold or mildew. Individually clamshell packed.

Item#	Color	Size	Case
40501	Black	3/8" x 10'	12
40291	Black	3/8" x 15'	12
40271	Black	3/8" x 20'	12
40321	Black	3/8" x 25'	12
40351	Black	1/2" x 15'	12
40401	Black	1/2" x 20'	12
40381	Black	1/2" x 25'	6
40461	Black	5/8" x 20'	6
40441	Black	5/8" x 25'	6
46961	Black	5/8" x 30'	6
40421	Black	5/8" x 35'	6
47201	Black	3/4" x 25'	6
47211	Black	3/4" x 35'	6
47221	Black	3/4" x 50'	4
40301	Blue	3/8" x 15'	12
40281	Blue	3/8" x 20'	12
40331	Blue	3/8" x 25'	12
40361	Blue	1/2" x 15'	12
40411	Blue	1/2" x 20'	12
40391	Blue	1/2" x 25'	6
40471	Blue	5/8" x 20'	6
40451	Blue	5/8" x 25'	6
40431	Blue	5/8" x 35'	6
47301	Blue	3/4" x 25'	6
47311	Blue	3/4" x 35'	6
47321	Blue	3/4" x 50'	4
39931	Burgundy	3/8" x 15'	12
39941	Burgundy	3/8" x 20'	12
39951	Burgundy	1/2" x 15'	12
39961	Burgundy	1/2" x 20'	12
39971	Burgundy	1/2" x 25'	6
39681	Forest Green	3/8" x 15'	12
39691	Forest Green	3/8" x 20'	12
39701	Forest Green	1/2" x 15'	12
39711	Forest Green	1/2" x 20'	12
46981	Forest Green	5/8" x 30'	6
40011	Gold/White	3/8" x 15'	12
40081	Gold/White	3/8" x 20'	12
40021	Gold/White	3/8" x 25'	12
40031	Gold/White	1/2" x 15'	12
40241	Gold/White	1/2" x 20'	12
40041	Gold/White	1/2" x 25'	6
40071	Gold/White	5/8" x 20'	6
40051	Gold/White	5/8" x 25'	6
46971	Gold/White	5/8" x 30'	6
40061	Gold/White	5/8" x 35'	6
47401	Gold/White	3/4" x 25'	6
47411	Gold/White	3/4" x 35'	6
47421	Gold/White	3/4" x 50'	4
39831	Navy	3/8" x 15'	12
39841	Navy	3/8" x 20'	12
39851	Navy	1/2" x 15'	12
39861	Navy	1/2" x 20'	12
39871	Navy	1/2" x 25'	6
39631	Navy	5/8" x 20'	6
39821	Navy	5/8" x 25'	6
46991	Navy	5/8" x 30'	6
39881	Navy	5/8" x 35'	6
39981	Purple	3/8" x 15'	12
39991	Purple	3/8" x 20'	12
40001	Purple	1/2" x 25'	6
39721	Red	3/8" x 15'	12
39731	Red	3/8" x 20'	12
39741	Red	1/2" x 15'	12
39751	Red	1/2" x 20'	12
39761	Red	1/2" x 25'	6

Item#	Color	Size	Case
39771	Teal	3/8" x 15'	12
39781	Teal	3/8" x 20'	12
39791	Teal	1/2" x 15'	12
39801	Teal	1/2" x 20'	12
39811	Teal	1/2" x 25'	6
40091	White	3/8" x 15'	12
40101	White	3/8" x 20'	12
40111	White	1/2" x 15'	12
40121	White	1/2" x 20'	12
40131	White	1/2" x 25'	6
40261	White	5/8" x 20'	6
40251	White	5/8" x 25'	6
46951	White	5/8" x 30'	6
40141	White	5/8" x 35'	6
47101	White	3/4" x 25'	6
47111	White	3/4" x 35'	6
47121	White	3/4" x 50'	4
39891	Yellow	3/8" x 15'	12
39901	Yellow	3/8" x 20'	12
39911	Yellow	1/2" x 20'	12

ANCHOR LINE - NYLON



Solid nylon braid. Rot proof and abrasion resistant. Zinc galvanized spring hook.

Item#	Color	Size	Case
40221	White	3/16" x 100'	6
40231	White	3/8" x 50'	6

ANCHOR LINE - POLYPROPYLENE



Hollow braided polypropylene. Rot proof. Great for small boats and mushroom anchors. Zinc galvanized spring hook.

Item#	Color	Size	Case
40201	White	1/4" x 50'	6
40211	White	3/8" x 75'	6

3-STRAND TWISTED NYLON ANCHOR LINE



Extremely strong line designed to absorb sudden shock loads. Comes with galvanized steel thimble.

Item#	Color	Size	Case
40691	White	3/8" x 50'	4
40711	White	3/8" x 100'	4
40721	White	3/8" x 150'	4
40731	White	1/2" x 100'	1
40741	White	1/2" x 150'	1
40751	White	1/2" x 200'	1
40781	White	1/2" x 250'	1

PREMIUM 3-STRAND TWISTED NYLON ANCHOR LINE WITH TRACER



Extremely strong line designed to absorb sudden shock loads. Comes with galvanized steel thimble.

Item#	Color	Size	Case
47691	White / Blue Tracer	3/8" x 50'	4
47711	White / Blue Tracer	3/8" x 100'	4
47721	White / Blue Tracer	3/8" x 150'	1
47911	White / Blue Tracer	3/8" x 200'	1
47731	White / Blue Tracer	1/2" x 100'	1
47741	White / Blue Tracer	1/2" x 150'	1
47751	White / Blue Tracer	1/2" x 200'	1
47781	White / Blue Tracer	1/2" x 250'	1
47921	White / Blue Tracer	5/8" x 200'	1
47931	White / Blue Tracer	5/8" x 250'	1



DOUBLE BRAID NYLON ANCHOR LINE



Extremely strong line designed to absorb sudden shock loads. Comes with galvanized steel thimble.

Item#	Color	Size	Case
42201	Black	3/8" x 100'	1
42161	Blue	3/8" x 100'	1
42241	Burgundy	3/8" x 100'	1
42181	Forest Green	3/8" x 100'	1
42321	Gold / White	3/8" x 100'	1
42331	Gold / White	3/8" x 150'	1
42341	Gold / White	3/8" x 200'	1
42221	Navy	3/8" x 100'	1
42231	Purple	3/8" x 100'	1
42171	Red	3/8" x 100'	1
42211	Teal	3/8" x 100'	1
42101	White	3/8" x 100'	1
42111	White	3/8" x 150'	1
42151	Yellow	3/8" x 100'	1
42361	Gold / White	1/2" x 100'	1
42281	Black	1/2" x 150'	1
42251	Blue	1/2" x 150'	1
42271	Forest Green	1/2" x 150'	1
42371	Gold / White	1/2" x 150'	1
42381	Gold / White	1/2" x 200'	1
42391	Gold / White	1/2" x 250'	1
42261	Red	1/2" x 150'	1
42291	Teal	1/2" x 150'	1
42121	White	1/2" x 100'	1
42131	White	1/2" x 150'	1
42141	White	1/2" x 200'	1
42311	Gold / White	3/8" x 250'	1

DIAMOND BRAID POLYPROPYLENE ROPE SPOOL



It Floats!
100% Polypropylene. Easy to splice. Resistant to rot, mildew and marine growth. 100% Monofilament fiber. Stronger than manila rope. Resists rot, mildew, acids, oils, etc. May be stored wet without damaging fibers.

Item#	Size	Strands	Color	Case
42750	1/4" x 1000'	8	Yellow	1
42760	1/4" x 1000'	16	Yellow	1

TWISTED BRAID POLYPROPYLENE SPOOL



It Floats!
100% Polypropylene. Easy to splice. Resistant to rot, mildew and marine growth. 100% Monofilament fiber. Stronger than manila rope. Resists rot, mildew, acids, oils, etc. May be stored wet without damaging fibers.

Item#	Size	Color	Case
42710	1/4" x 600'	Yellow	1
42720	3/8" x 600'	Yellow	1
42730	1/2" x 600'	Yellow	1

PREMIUM 3-STRAND – TWISTED NYLON SPOOL WITH TRACER



Manufactured from 100% filament nylon fibers. Has great elasticity properties and the ability to absorb sudden shock loads. Excellent resistance to abrasion, rot, mildew, oil, grease, gasoline, acids and most chemicals. White with contrasting blue tracer.

Item#	Size	Color
47790	1/4" x 600'	White / Blue Tracer
47850	5/16" x 600'	White / Blue Tracer
47800	3/8" x 600'	White / Blue Tracer
47810	1/2" x 600'	White / Blue Tracer
47820	5/8" x 600'	White / Blue Tracer
47860	3/4" x 600'	White / Blue Tracer
47870	1" x 600'	White / Blue Tracer

3-STRAND TWISTED NYLON ROPE SPOOL



Manufactured from 100% filament nylon fibers. Has great elasticity properties and the ability to absorb sudden shock loads. Excellent resistance to abrasion, rot, mildew, oil, grease, gasoline, acids and most chemicals.

Item#	Size	Color
40790	1/4" x 600'	White
42820	5/16" x 600'	White
40800	3/8" x 600'	White
40810	1/2" x 600'	White
40820	5/8" x 600'	White
42830	3/4" x 600'	White
42840	1" x 600'	White
42850	1 1/4" x 600'	White
42860	1 1/2" x 600'	White

DOUBLE BRAID ROPE SPOOL



Excellent high grade nylon. Long wearing and resists kinking. Can be used to make dock, anchor and mooring lines.

Item#	Size	Color
47090	3/8" x 600'	Black
47080	1/2" x 600'	Black
40160	3/8" x 600'	Gold/White
40170	1/2" x 600'	Gold/White
40180	5/8" x 600'	Gold/White
40190	3/4" x 600'	Gold/White
47060	3/8" x 600'	Navy
47000	3/8" x 600'	White
47010	1/2" x 600'	White
47020	5/8" x 600'	White
47030	3/4" x 600'	White
47040	1" x 600'	White

SOLID BRAID NYLON ROPE SPOOL



A strong, firm, uniformly round rope. Works exceptionally well in blocks and on winches. Does not flatten under load. Has elasticity that allows it to absorb sudden shock loads. Resistant to rot, abrasion, mildew, gas and oil.

Item#	Size	Color
42880	1/8" x 1000'	White
42890	5/32" x 1000'	White
42910	3/16" x 1000'	White
42900	1/4" x 1000'	White
42940	5/16" x 500'	White
42920	3/8" x 500'	White
42930	1/2" x 250'	White



SOLID BRAID 100% MFP MULTI-PURPOSE ROPE SPOOL



- Polypropylene
- Multi-purpose
- Buoyant
- Resistant to rot, mildew and marine growth

Item#	Size	Color
42780	3/8" x 500'	Blue/White
42770	3/8" x 500'	Red/White
42790	3/8" x 500'	Green/White

SHOCK CORD



Elastic shock cords are useful in many applications. Hooks are coated to prevent scratching.

Item#	Size	Pack	Case
79551	18"	5	10
79571	30"	5	10

ROPE REEL RACK DISPLAY



- Simple and easy way to display rope reels
- Gloss black finish with three crossbar
- Holds 6-12 reels of rope depending on size
- No assembly required

Item#	Case
ROPERACK	1

TIE DOWN CORD



An economical general purpose rope. Constructed of 8 strand white braided polypropylene cover with a knot holding control core. Excellent knot retention. Ideal for use with boat covers or to form the support structure for shrink wrapping boats.

Item#	Size	Tensile Strength	Color
48001	3/16" x 1000'	600 lbs.	White
48011	7/32" x 1000'	825 lbs.	White
48021	1/4" x 1000'	1000 lbs.	White

ELECTRIC ROPE CUTTING GUN



Rope cutter quickly cuts and seals the end of synthetic ropes in one fast movement. 120V AC at 60 Cycle. 1.1A 100W. 5' cord.

Item#	Description	Case
79901	Complete Cutting Gun	12
Repl. Parts	Description	Case
79911	Blade	12



**MOLDED "Y" BOW STOP**

Black rubber. Products ending in "0" are bulk. Products ending in "1" are UPC packaged.

Item#	Base	Span	Hole	Pack	Case
56250	2" x 2"	4"	3/8" ID	Bulk	12
56251	2" x 2"	4"	3/8" ID		12
56260	3" x 3"	6"	1/2" ID	Bulk	12
56261	3" x 3"	6"	1/2" ID		12

BOW ROLLER

Black rubber. Products ending in "0" are bulk. Products ending in "1" are UPC packaged.

Item#	Length	Hole	Pack	Case
56300	3"	1/2" ID	Bulk	12
56301	3"	1/2" ID		12
56310	4"	1/2" ID	Bulk	12
56311	4"	1/2" ID		12

WOBBLE ROLLER

Black rubber with chemically bonded zinc chromate washers. Products ending in "0" are bulk. Products ending in "1" are UPC packaged.

Item#	Size	Hole	Pack	Case
56350	4 1/4" D x 4 1/4" W	3/4" ID	Bulk	12
56351	4 1/4" D x 4 1/4" W	3/4" ID		12

RIBBED ROLLER

Black rubber. Accommodates a 3/4" insert.

Item#	Size	Hole	Pack	Case
56330	4 3/8" D x 3" W	7/8" ID	Bulk	12

SPOOL ROLLER

Black rubber with plastic sleeve. Products ending in "0" are bulk. Products ending in "1" are UPC packaged.

Item#	Length	Hole	Pack	Case
56140	4"	1/2" ID	Bulk	12
56141	4"	1/2" ID		12
56150	4"	5/8" ID	Bulk	10
56151	4"	5/8" ID		10
56180	5"	1/2" ID	Bulk	10
56181	5"	1/2" ID		10
56190	5"	5/8" ID	Bulk	10
56191	5"	5/8" ID		10
56210	8"	5/8" ID	Bulk	10
56211	8"	5/8" ID		10

HEAVY-DUTY KEEL ROLLER

Black rubber with 5/8" nylon inserts. Heavy duty steel sleeve and tapered design provide longer life especially with heavy boats. Stress weight, recommended max load 400 lb. Products ending in "0" are bulk. Products ending in "1" are UPC packaged.

Item#	Length	Pack	Case
56070	8"	Bulk	12
56071	8"		12
56090	10"	Bulk	12
56091	10"		12
56110	12"	Bulk	12
56111	12"		12

STRAIGHT ROLLER

Non-marking black rubber.

Item#	Size	Hole	Pack	Case
56360	12" x 2 1/2"	5/8" ID	Bulk	10

SIDE GUIDE END CAP

Black rubber.

Item#	Size	Hole	Pack	Case
56380	2 1/2"	5/8" ID	Bulk	20

ROLLER END CAP

Black rubber.

Item#	Size	Hole	Pack	Case
56400	3 1/2" dia. x 1 1/4" W	5/8" ID	Bulk	20

V-BOW STOP

- Non-marking TP yellow rubber
- 5 year warranty

Item#	Size	Pkg.	Case
56550	3" x 1/2"	Bulk	12

BOW ROLLER

- Non-marking TP yellow rubber
- 5 year warranty

Item#	Length	Hole	Pkg.	Case
56560	3" Overall	1/2" ID	Bulk	12
56580	4" Overall	1/2" ID	Bulk	12

BOW ROLLER WITH BELLS



- Non-marking TP yellow rubber
- 5 year warranty
- Includes: bolt, nuts and washers for mounting

Item#	Length	Hole	Pkg.	Case
56590	3"	1/2" ID	Bulk	10
56600	4"	1/2" ID	Bulk	10

RIBBED ROLLER



- Non-marking TP yellow rubber
- 5 year warranty
- Shaft size is 1 1/8" but can be reduced to 3/4" with supplied bushing

Item#	Size	Hole	Pkg.	Case
56540	5" D x 3" W	1 1/8" ID	Bulk	12

SPOOL ROLLER



- Non-marking TP yellow rubber
- 5 year warranty

Item#	Length	Hole	Pkg.	Case
56480	4" Overall	1/2" ID	Bulk	12
56500	5" Overall	1/2" ID	Bulk	10
56490	4" Overall	5/8" ID	Bulk	10
56520	5" Overall	5/8" ID	Bulk	10

KEEL PAD



- Non-marking TP yellow rubber
- Fits 3" wide channel
- Side hole mount
- 5 year warranty

Item#	Size	Pkg.	Case
56640	12" L x 3 1/2" W x 1" H	Bulk	10

KEEL ROLLER



- Non-marking TP yellow rubber
- 5 year warranty

Item#	Length	Hole	Pkg.	Case
56420	8" Overall	5/8" ID	Bulk	12
56440	10" Overall	5/8" ID	Bulk	12
56460	12" Overall	5/8" ID	Bulk	12

ROLLER END CAP



- Non-marking TP yellow rubber
- 5 year warranty

Item#	Length	Hole	Pkg.	Case
56620	3 1/2"	1 1/4" ID	Bulk	20

ROLLER SHAFT AND PAL NUTS



Made of zinc plated steel. Roller shaft comes complete with 2 pal nuts.

Item#	Shaft	Roller Size	Length	Case
55701	1/2" OD	3"	4 3/8"	12
55721	1/2" OD	4"	5 3/8"	12
55731	1/2" OD	5" & 5 1/4"	6 5/8"	12
55741	5/8" OD	4"	5 3/8"	12
55751	5/8" OD	5" & 5 1/4"	6 5/8"	12
55771	5/8" OD	8"	9 3/8"	12
55791	5/8" OD	10"	11 3/8"	12
55811	5/8" OD	12"	13 3/8"	12

Opt. Accy.	Description	Size	Pack	Case
55851	Pal Nuts	1/2"	10	12
55861	Pal nuts	5/8"	10	12

SPLIT KEEL ROLLER BRACKET

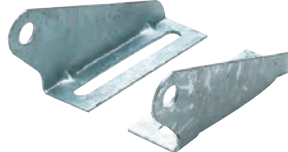

The left and right bracket are made of 9 Gauge galvanized steel and can be used for any width roller. Features a 5" slot for vertical adjustments. Mounts with 1/2" bolt and is designed to be used with a 5/8" roller shaft.

Item#	Pack	Case
55530	Bulk	12

KEEL ROLLER BRACKET

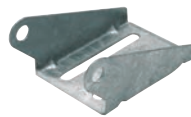

Made of 11 gauge galvanized steel. One-piece keel roller bracket with 5" slot for vertical adjustment. Mounts with 1/2" bolt and is designed to be used with a 5/8" roller shaft.

Item#	Size	Slot Center	Pack	Case
55580	5"	2 3/4"	Bulk	12
55600	8"	5 3/4"	Bulk	12
55620	10"	8 3/8"	Bulk	12
55640	12"	10 1/8"	Bulk	12

SWIVEL BOLSTER BRACKET



Made of heavy 11 gauge galvanized steel that is slotted for vertical adjustment. Non-slip dimples for secure hold. Angle bracket pivots for angled or flat mounting of 2" x 6" bunk or bolster boards. Complete with nut and bolt for angle bracket. Mounts with 1/2" bolt. Bracket angle 3.5" W.

U-BOLT APPLICATION CHART

Frame Size Use Item #

2" Frame 57210

3" Frame 57220

4" Frame 57240

Item#	Length	Assembled	Pack	Case
55310	8"	9"	Bulk	12
55330	10"	11"	Bulk	12
55350	12"	13"	Bulk	12

Opt. Accy.	Description	Pkg.	Case
55300	Angle Bracket Only	Bulk	12

BUNK BRACKET



Made of 11 gauge galvanized steel. For mounting bunks. Slotted for vertical adjustments. Mounts with 1/2" bolt.

Item#	Size	Pack	Case
55490	8" L x 2" W	Bulk	12
55510	10" L x 2" W	Bulk	12



U-BOLT

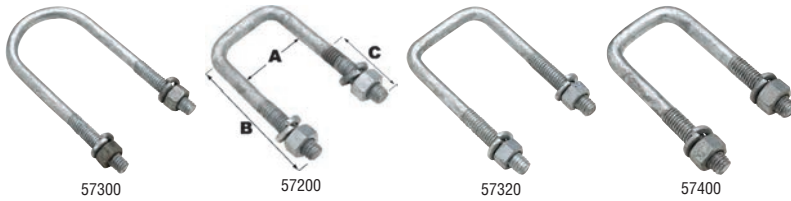

Made of galvanized steel. Include nuts and lock washers. Covers most U-Bolt applications. One per card or in bulk.

Item#	Thread	A	B	C	Type	For	Plate	Pkg.	Case
Round									
57300	3/8"-16	1 3/4"	4 3/8"	1 3/4"	RD	Axle U-Bolt Plates (Round Axles)	55081	Bulk	12
57301	3/8"-16	1 3/4"	4 3/8"	1 3/4"	RD	Axle U-Bolt Plates (Round Axles)	55081		12
57310	3/8"-16	1 3/8"	4 5/16"	1 3/4"	RD	Pipe Bunks 2", 3", 4" & 5" Frames	55081	Bulk	12
57311	3/8"-16	1 3/8"	4 5/16"	1 3/4"	RD	Pipe Bunks 2", 3", 4" & 5" Frames	55081		12
57420	1/2"-13	2 3/8"	5 3/8"	2"	RD	Axle U-Bolt Plates	55161	Bulk	12
57421	1/2"-13	2 3/8"	5 3/8"	2"	RD	Axle U-Bolt Plates	55161		12
Square									
57200	7/16"-14	1 9/16"	3 9/16"	1 3/4"	SQ	Axle U-Bolt Plates	-	Bulk	12
57201	7/16"-14	1 9/16"	3 9/16"	1 3/4"	SQ	Axle U-Bolt Plates	-		12
57210	7/16"-14	2 1/16"	2 13/16"	1 3/4"	SQ	Bolster Brackets for 2" Frames	55311, 55331, 55351	Bulk	12
Square									
57211	7/16"-14	2 1/16"	2 13/16"	1 3/4"	SQ	Bolster Brackets for 2" Frames	55311, 55331, 55351		12
57220	7/16"-14	3 1/16"	2 13/16"	1 3/4"	SQ	Bolster Brackets for 3" Frames	55311, 55331, 55351	Bulk	12
57221	7/16"-14	3 1/16"	2 13/16"	1 3/4"	SQ	Bolster Brackets for 3" Frames	55311, 55331, 55351		12
57230	7/16"-14	3 1/16"	4 5/16"	1 3/4"	SQ	-	-	Bulk	12
57231	7/16"-14	3 1/16"	4 5/16"	1 3/4"	SQ	-	-		12
57240	7/16"-14	4 1/16"	2 13/16"	1 3/4"	SQ	Bolster Brackets for 4" Frames 4" Frame Tie Plates	55311, 55331, 55351	Bulk	12
57241	7/16"-14	4 1/16"	2 13/16"	1 3/4"	SQ	Bolster Brackets for 4" Frames 4" Frame Tie Plates	55311, 55331, 55351		12
57320	3/8"-16	1 5/8"	3 3/8"	1 3/4"	SQ	Axle U-Bolt plates	55081	Bulk	12
57321	3/8"-16	1 5/8"	3 3/8"	1 3/4"	SQ	Axle U-Bolt plates	55081		12
57330	3/8"-16	2 1/16"	3 3/8"	1 3/4"	SQ	2" Frame Tie Plates	55201	Bulk	12
57331	3/8"-16	2 1/16"	3 3/8"	1 3/4"	SQ	2" Frame Tie Plates	55201		12
57340	3/8"-16	2 1/16"	7 7/8"	4"	SQ	Guide On Assemblies	-	Bulk	12
57341	3/8"-16	2 1/16"	7 7/8"	4"	SQ	Guide On Assemblies	-		12
57350	3/8"-16	3 1/16"	3 7/8"	1 3/4"	SQ	-	-	Bulk	12
57351	3/8"-16	3 1/16"	3 7/8"	1 3/4"	SQ	-	-		12
57360	3/8"-16	3 1/16"	4 7/8"	1 3/4"	SQ	3" Frame Tie Plate	55221	Bulk	12
57361	3/8"-16	3 1/16"	4 7/8"	1 3/4"	SQ	3" Frame Tie Plate	55221		12
57400	1/2"-13	1 9/16"	4 1/16"	2"	SQ	Axle U-Bolt Plates	55111	Bulk	12
57401	1/2"-13	1 9/16"	4 1/16"	2"	SQ	Axle U-Bolt Plates	55111		12
57410	1/2"-13	2 1/16"	4 13/16"	2"	SQ	Axle U-Bolt Plates	55051	Bulk	12
57411	1/2"-13	2 1/16"	4 13/16"	2"	SQ	Axle U-Bolt Plates	55051		12
57430	1/2"-13	3 1/16"	3 13/16"	2"	SQ	Axle U-Bolt Plates	55021	Bulk	12
57431	1/2"-13	3 1/16"	3 13/16"	2"	SQ	Axle U-Bolt Plates	55021		12
57440	1/2"-13	3 1/16"	3 5/16"	2"	SQ	-	-	Bulk	12
57441	1/2"-13	3 1/16"	3 5/16"	2"	SQ	-	-		12
57450	1/2"-13	3 1/16"	4 5/16"	2"	SQ	-	-	Bulk	12
57451	1/2"-13	3 1/16"	4 5/16"	2"	SQ	-	-		12
57460	1/2"-13	3 1/16"	5 5/16"	2"	SQ	-	-	Bulk	12
57461	1/2"-13	3 1/16"	5 5/16"	2"	SQ	-	-		12
57470	1/2"-13	3 1/16"	6 5/16"	2"	SQ	-	-	Bulk	12
57471	1/2"-13	3 1/16"	6 5/16"	2"	SQ	-	-		12

BUNK CARPETING



Protects boat hull from mars and scratches. Helps in launching and loading. Made of black solution-dyed polyester that is superior to polypropylene. Won't fray or unravel. Resists mold and mildew. Easy to cut to any size. Restricted from sale in California.

Item#	Size	Color	Case
55981	8' x 12'	Black	16
55991	12' x 12'	Black	10

MEDIUM-DUTY AXLE U-BOLT PLATE

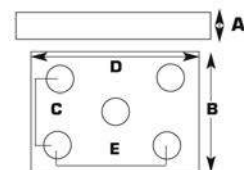

Made of solid galvanized steel. For use on square beam and tube axles. 4-hole bolt pattern. Use spring 1 1/4".

Item #	A	B	C	D	E	Case
55051	1/4"	4"	2 5/8"	3 3/8"	2 3/8"	12
55081	1/4"	3 1/2"	2 1/4"	3"	2"	12
55111	1/4"	3 1/2"	2 1/4"	3"	2"	12
Item#	Fits	Case				
55051	U Bolt 5741	12				
55081	U Bolt 5732 or 5730	12				
55111	U Bolt 5740	12				

HEAVY-DUTY AXLE U-BOLT PLATE

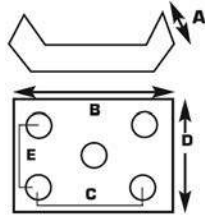

Made of solid galvanized steel. For use on 2 3/8" round beam axles. For 1 3/4" springs. Use 1/2" Bolts. Use U-bolt model 57421.

Item#	A	B	C	D	E	Case
55161	1/4"	3 3/8"	2 1/4"	3 3/4"	2 15/16"	12

FRAME TIE PLATE

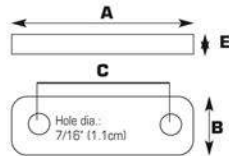

Frame tie plates are used in applications such as mounting boat trailer brackets and fastening spring sliders. Made of 1/4" plated steel with radius ends. Hole diameter 7/16". Use bolt size 3/8".

Item#	Fits	Width	A	B	C	E	Pack	Case
55201	U Bolt 5733	2"	4 1/16"	1"	2 3/16"	1/4"	1 pr.	12
55221	U Bolt 5736	3"	5 1/16"	1"	3 3/16"	1/4"	1 pr.	12
55231	U Bolt 5724	4"	6 1/16"	1"	4 3/16"	1/4"	1 pr.	12

LIGHT-DUTY AXLE U-BOLT PLATE

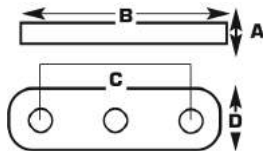

Made of solid galvanized steel. For use on 1 1/4" x 1 1/2" square beam axles and light-duty tube axles. For 1 3/4" wide springs. Use 1/2" bolts. Use U-bolt Model 57431.

Item#	Description	A	B	C	D	Case
55021	2 bolt pattern	1/4" Solid Steel	5 1/16"	3 3/16"	1 1/2"	12

SPRING SHACKLE



Made of 1/4" zinc plated steel. Punched to accept 5/16" splined shackle bolt Model 54911.

Item#	Center to Center	Width	Dia.	Pack	Case
54861	2 1/4"	1 1/4"	5/16"	1 pr.	12
54881	2 3/4"	1 1/4"	5/16"	1 pr.	12
54901	3 3/8"	1 1/4"	5/16"	1 pr.	12

SHACKLE BOLT



Zinc splined bolt that keeps bolt from rotating. Nut included. For use with spring shackles Models 54861, 54881, 54901.

Item#	Size	Pack	Case
54911	5/16"-18 x 3"	1 pr.	12

1" TRAILER WHEEL HUB



4 Lug (Galv.)



5 Lug (Galv.)

One piece cast hubs complete with pregreased bearings, seals, dust caps, cotter pin and lug nuts. 1/2"-20 Studs.

Inner Bearing Code: L44643, Outer Bearing Code: L44643, Inner Race Code: L44610, Outer Race Code: L44610, Seal Code: 125255UC



4 Lug (Painted)



5 Lug (Painted)

4 Lug: Lug nuts on a 4" bolt pattern.
5 Lug: Lug nuts on a 4.5" bolt pattern.

Item#	Description	Lugs	Capacity	Case
53021	Galvanized	4	1,250 lbs.	1
53041	Galvanized	5 UHI	1,250 lbs.	1
53121	Painted	4	1,250 lbs.	1
53141	Painted	5 UHI	1,250 lbs.	1

1 1/16" TRAILER WHEEL HUB



5 Lug (Galv.)



5 Lug (Painted)

One piece cast hubs complete with pregreased bearings, seals, dust caps, cotter pin and lug nuts. 1/2"-20 Studs.

Inner Bearing Code: L44649, Outer Bearing Code: L44649, Inner Race Code: L44610, Outer Race Code: L44610, Seal Code: 125255UC

Lug nuts on a 4.5" bolt pattern.

Item#	Description	Lugs	Capacity	Case
53061	Galvanized	5 UHI	1,350 lbs.	1
53161	Painted	5 UHI	1,350 lbs.	1

REPLACEMENT WHEEL PARTS



53901

53911

Replacement parts for commonly used trailer wheels.

Item#	Description	Pack	Case
53901	Spare Wheel Bolts - 1/2-20	5	12
53911	Spare Lug Nuts - 1/2-20	5	12

BEARING PROTECTORS WITH COVER



Triple chrome plated housing. All stainless steel internal parts. Avoids bearing corrosion by preventing intrusion of water and dirt. Continuous bearing protection and lubrication by means of grease fitting for simple and easy filling. 1.980 diameter fits L44643, L44649, L44640 cone and L44610 cup.

Item#	Size	Pack	Case
51501	1.980"	1 pr.	10

BEARING PROTECTOR COVER



Helps prevent grease from splattering trailer wheels.

Item#	Pack	Case
51521	1 pr.	12



GREASE CAP



Steel caps for most common application used in bearing kits.

Item#	Size	For	Pack	Case
53631	1.980"	Bearing Kit 53531, 53541, 53571	1 pr.	10

TRAILER WHEEL BEARING KIT



Each Kit Contains:

- 2 bearings with races
- 1 grease seal
- 1 cotter pin

Model	Cone/Bearing	Cup/Race	Seal
53521:	LM11949	LM11910	Sngl. Lip, AE8439N
53531:	L44643	L44610	Dbl. Lip
53541:	L44649	L44610n	Dbl. Lip, AD1836N
53551:	LM67048	LM67010	Sngl Lip, AE2253N
53561:	LM67048/LM11949	M67010/LM11910	Sngl Lip
53571:	L68149/L44649	L68111/L44610	Dbl. Lip, AE2592N
53581:	L68149/L44649	L68111/L44610	Dbl. Lip, 11097
53591:	L68149/L44649	L68111/L44610	Dbl. Lip, 11097
53601:	L68149 (2)	L68110 (2)	Dbl. Lip, 11097

Item#	Axle	Case
Kits		
53521	3/4"	12
53531	1"	12
53541	1 1/16"	12
53551	1 1/4"	12
53561	1 1/4" x 3/4"	12
53571	1 3/8" x 1 1/16"	12
Ranger Kits		
53581	1986 and older	12
53591	1987-1989	12
53601	1990 and newer	12

TRAILER JACK STAND WHEEL STOP



Made of ABS plastic. Wheel stop prevents trailer from moving around or sinking in dirt or asphalt. For use with trailer jacks for boats and personal watercraft. Color: Black.

Item#	Size	Case
52101	6 1/4"	12

LOCKABLE SPARE TIRE CARRIER



Zinc plated U-Bolt carrier secures tire on tongue or frame up to 3" wide. May be used on 4 or 5 hole rims. Will fit all 8" - 14" and most 15" wheels. Will prevent theft of spare tire. Does not include lock.

Item#	Case
53851	12



ALUMINUM TRAILER STEP

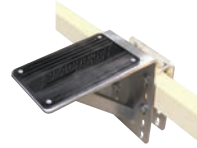

Made of 6005 aluminum for excellent corrosion resistance. Mount on frames up to 3 1/2" W x 5" H. Slip resistant rubber logo pad offers sure footing. Step Dimension: 5" W x 9 1/4" H x 9" D. Capacity: 300 lb.

Hardware Included:

- (1) Aluminum mounting plate
- (4) Zinc coated carriage bolts
- (4) Zinc coated washers
- (4) Zinc coated locking nuts

Item#	Case
52271	6

SIDE MOUNT SPARE TIRE CARRIER



Heavy duty, welded and reinforced steel plate construction. Zinc plated for superior corrosion resistance. One-piece construction for extra strength to withstand vibration. Mounts tire up and out from trailer frame for that custom trailer look. Mounts on frames up to 3" W x 4" H. All mounting hardware included. Packed in display box.

Item#	Description	Case
53871	Zinc Plated	12

TRAILER HITCH LOCK



Designed to fit in padlock hole of trailer coupler for trailer security. Solid brass body hasp. Heat treated lock is pick resistant. Pin diameter 1/4". Closed position 1 3/4".

Item#	Case
37401	12

LOCKING PIN



Keeps coupler release handle from disengaging while in travel. Will not prevent theft.

Item#	Pin	Fits	Case
52081	5/16"	2" and 3" coupler	12
52091	1/4"	1 3/4" coupler	12

TRAILER COUPLER



Constructed of durable steel. Can be used with all Seachoice trailer coupler balls.

Item#	Channel Size	Ball	Max Load	Receiver	Case
52411	2 1/2"	1 7/8"	2,000 lbs.	Class I	6
52421	3"	1 7/8"	2,000 lbs.	Class I	6
52451	2 1/2"	2"	3,500 lbs.	Class II	5
52461	3"	2"	3,500 lbs.	Class II	5

COUPLER REPAIR KIT



Steel construction. Will fit Seachoice couplers and most other brands.

Item#	Ball	Case
52471	1 7/8"	12
52481	2"	12

TRAILER BALL MOUNT

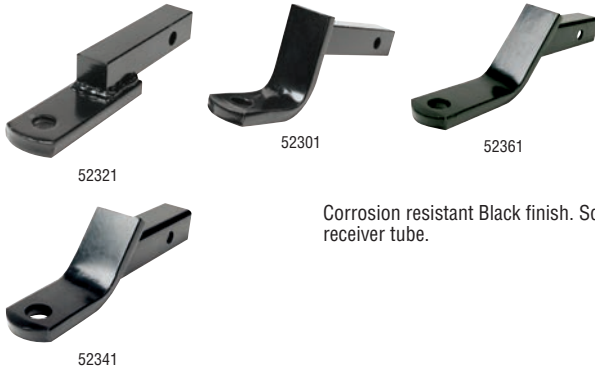

Corrosion resistant Black finish. Square receiver tube.

Item#	Receiver	Rise	Drop	Tongue Capacity	Tow Capacity	Case
52321	1 1/4", Straight	5/8"	1 1/4"	300 lbs.	3,500 lbs.	8
52301	1 1/4" Hi-Low	3 1/8"	3 3/4"	300 lbs.	3,500 lbs.	10
52361	2", Straight	3/4"	2"	500 lbs.	5,000 lbs.	8
52341	2", Hi-Low	2"	3 1/4"	500 lbs.	5,000 lbs.	10

RECEIVER PIN WITH CLIP



Made of zinc plated steel.

Item#	Size	Receiver	Case
52381	1/2"	Class I & II	12
52391	5/8"	Class III, IV and V	12

BRAKE LIGHT HITCH COVER



Red brake light that fits 2" receivers. Includes 4-way flat connector.

Item#	Case
51801	12

ADJUSTABLE TRI-BALL TRAILER HITCH



- Powder coated
- 2" Square solid shank
- 3 different size chrome balls, each with its own tow capacity
- 3 Hitch pins

Item#	Drop	Tow Capacity	Ball	Case
52291	4.79"	3,500, 6,000, 10,000	1 7/8", 2", 2 5/16"	1

TRI-BALL TRAILER HITCH



- Powder coated
- 2" Square solid shank
- 3 different size chrome balls, each with its own tow capacity

Item#	Length	Tow Capacity	Ball	Case
52281	8", 8", 6 3/4"	3,500, 6,000, 10,000	1 7/8", 2", 2 5/16"	1

TRAILER COUPLER BALL



Made of chrome plated steel. Complete with lock washer and nut. Packaging can be peg-hooked or self standing.

Item#	Ball	Shank	SAE Class	Capacity	Case
51301	1 7/8" dia.	3/4" x 1 1/2"	I	2000 lbs.	12
51311	1 7/8" dia.	3/4" x 2 5/16"	I	2000 lbs.	12
51321	2" dia.	3/4" x 1 1/2"	II	3500 lbs.	12
51331	2" dia.	3/4" x 2 5/16"	II	3500 lbs.	12
51341	2" dia.	1" x 2"	III	5000 lbs.	12
51361	2 5/16" dia.	1" x 2"	IV	6000 lbs.	12

TRAILER SAFETY CHAIN



Zinc plated. Welded link chain with safety hooks.

Item#	Size	Receiver	Max Load	Case
51271	7/32" x 36"	Class I	700 Lbs.	10
51281	1/4" x 42"	Class III	900 lbs.	10

DROP LEG TRAILER JACK - HEAVY DUTY



Fixed mount jack with drop leg. Suited for heavy duty applications and fits trailer frames up to 3" x 5". Bolt-on style and includes all mounting hardware. 28" of lift.

Item#	Max Load	Case
52051	2500 lbs.	2

FOLD UP TRAILER JACK



Swings from vertical position to horizontal for fast getaway. Spring loaded latch locks and releases the jack from one position to the other.

Lift travel: 10". Maximum lift 24". Individually boxed.

52021: 22.83" Extended. Fits up to 3" x 5" Trailer Tongue. Zinc finish.

52031: 24" Extended. Fits up to 3" x 4" Trailer Tongue. Manufactured of corrosion resistant steel.

Item#	Max Load	Wheel Size	Case
52021	1000 lbs.	6"	2
52031	1500 lbs.	8"	2

Repl. Parts	Description	Pack	Case
52070	6" Spare wheel	Bulk	8
52060	8" Spare wheel	Bulk	6

TRAILER JACK REPLACEMENT WHEEL



Black poly reinforced replacement wheel.

Item#	Description	Pack	Case
52070	6" Spare wheel	Bulk	8
52060	8" Spare wheel	Bulk	6

New WHEEL CHOCK WITH ROPE

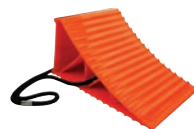

- Keeps your trailer in place so you can re-hitch safely
- Constructed of durable hard plastic with UV inhibitors
- Includes rope for convenient placement and removal

Item#	Case
52110	6



TRAILER WINCHES



Includes winch strap. Made of zinc plated steel. Features 1 or 2-way ratchet with free spool center position. Has one piece solid gear. Pre-drilled for 3 bolt mounting.

52131: Strap 2" x 16'

52161, 52191, 52251 & 52261: Strap 2" x 25'

Item#	Max Load	Ratchet	Gear Ratio	Hub	Case
52131	800 lbs.	1-Way	3.2:1	3/4" dia.	10
52161	1000 lbs.	1-Way	4.1:1	3/4" dia.	10
52191	1200 lbs.	1-Way	4.1:1	3/4" dia.	10
52251	2000 lbs.	2-Way	4.1:1/9:8:1	1" dia.	4
52261	3000 lbs.	2-Way	4.1:1/9:8:1	1" dia.	4

WINCH STRAP



High strength 2" wide polyester strap with 4000 lbs. break strength. Safe working load of 1000 lbs. Not recommended for use where personal safety is involved.

Item#	Type	Length	Case
51241	With Loop End	20'	6
51251	With Tail End	20'	6
51261	PWC, w/Loop End	12'	6

WINCH CABLE



DO NOT USE FOR LIFTING
Galvanized 7 x 19 aircraft cable. Heavy duty galvanized snap hook.

Item#	Size	Length	Break Strength	Hook	Case
51171	5/32"	25'	2,800 lbs.	4,500 lbs.	10
51181	3/16"	25'	4,000 lbs.	7,000 lbs.	10

WINCH HOOK



Made of heavy duty, forged steel with a zinc plated finish. Closure is spring loaded. 5/8" throat.

Not recommended for overhead lifting.

Item#	Size	Break Strength	Case
36971	5/8" x 4 1/4"	6000 lbs.	12

WINCH HOOK



Made of heavy duty, forged steel with a zinc plated finish.

Not recommended for overhead lifting.

Item#	Size	Break Strength	Case
36981	5/8" x 3 7/8"	7000 lbs.	12

TRANSOM TIE DOWN STRAP



Constructed of black heavy-duty weather resistant webbing. Rust resistant plated "S" hook on each end. Center cam-action buckle adjusts length and tension. Velcro closure pad helps to protect boat finish.

Item#	Length	Width	Pack	Case
51221	4'	2"	1 pr.	10

PREMIUM TRANSOM TIE DOWN STRAP



Constructed of strong polypropylene webbing. Coated "S" hooks on both ends eliminate rusting. Positive lock/quick release buckle provides easy on/off access, yet provides a strong hold.

Item#	Length	Width	Pack	Case
51211	4'	2"	1 pr.	6

GUNWALE TRAILER TIE DOWN STRAP



Black polyester strap with cadmium plated "J" hook. Quick release adjuster.

Item#	Length	Width	Case
51021	10'	2"	10
51041	12'	2"	10
51061	14'	2"	10
51081	16'	2"	10
51101	18'	2"	10
51121	20'	2"	10

PREMIUM GUNWALE TRAILER TIE DOWN STRAP



Premium gunwale straps are manufactured with high quality USA made polyester webbing. All stitches are made in a box stitch pattern for maximum strength. Single "J" hook on each side. Quick release adjuster for easy operation.

Item#	Length	Width	Case
51051	12'	2"	6
51071	14'	2"	6
51091	16'	2"	6

ADJUSTABLE TRANSOM SAVER



Fits all outboard motors. Must have power tilt and trim to use this unit. Stainless steel fasteners suited for saltwater applications.

Item#	Length	Case
28001	20"-30"	4

SUBMERSIBLE UNDER 80" TRAILER LIGHT KIT



Contains two tail lights with red side marker/reflectors, license bracket, 25' wiring harness and hardware.
Meets the requirements of SAE/DOT/FMVSS/CMVSS standards when properly installed

- Grounds through mounting studs
- Shock-proof socket guarantees long bulb life
- Acrylic lens, corrosion proof plastic housing
- Screw-on lens, easy to change bulbs
- Stud mount on 2" centers

Item#	Description	Case
52911		2
Repl. Parts	Description	Case
53001	Driver Side Light / 7-function	6
52991	Passenger Side Light / 6-function	6

WATERPROOF OVER 80" UNIVERSAL TAIL LIGHT



51921

51931

51921: 8-Function, Driver Side: Stop, Turn, Tail, Side Marker, Side/Rear Reflectors, Rear Clearance and License Light
51931: 7-Function, Passenger Side: Stop, Turn, Tail, Side Marker, Side/Rear Reflectors, and Rear Clearance

- **Meets the requirements of SAE/DOT/FMVSS/CMVSS standards when properly installed**
- Waterproof construction, low profile design
- Acrylic lens, corrosion proof plastic housing
- Includes separate ground wire with eyelet
- Mount on 2" centers
- Size: 8.063" x 2.875" x 2.813"

Item#	Description	Case
51921	8-Function, Driver Side	10
51931	7-Function, Passenger Side	10

LED WATERPROOF OVER 80" TRAILER LIGHT SET

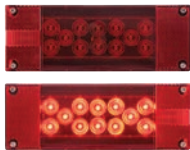

Contains two low profile lights designed for marine trailer application.



- **Meets the requirements of SAE/DOT/FMVSS/CMVSS standards when properly installed**
- Designed for marine trailer application
- Sealed, waterproof construction
- Universal mount
- Hard wired, with separate ground wire

Item#	Case
52711	2

SUBMERSIBLE OVER 80" TRAILER LIGHT SET



Contains two tail lights. Passenger side light is 7-function: stop, turn, tail, rear clearance, rear reflex, side marker, and side reflex. Driver side light also includes license illuminator.

- **Meets the requirements of SAE/DOT/FMVSS/CMVSS standards when properly installed**
- Includes mounting hardware
- Corrosion resistant hardware
- Screw-on lens, easy to change bulbs
- Stud mount on 2" centers
- Grounds through mounting studs

Item#	Case
52921	2

LED GLOLIGHT™ UNDER 80" COMBINATION TAIL LIGHT KIT



Contains two waterproof stop, tail, turn lights and all installation hardware included.



- **Meets the requirements of SAE/DOT/FMVSS/CMVSS standard for under 80" trailers when properly installed**
- Waterproof performance
- Stud mount lights mount on 2" centers
- Hard wired, with separate ground wire
- 5.031" W x 4.563" H x 2.625" D

Item#	Case
52752	2

LED GLOLIGHT™ LOW PROFILE TAIL LIGHT KIT

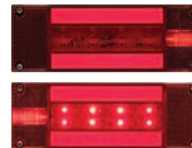

Contains two waterproof stop, tail, turn lights.



- **Meets the requirements of SAE/DOT/FMVSS/CMVSS standards when properly installed**
- Designed for marine trailer application
- Sealed, waterproof construction
- Universal mount
- Hard wired, with separate ground wire
- Installation hardware included
- 8" W x 2.9" H x 2.6" D

Item#	Case
52772	2

WATERPROOF UNIVERSAL MOUNT COMBINATION TAIL LIGHT KIT

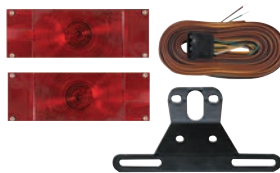

- **Meets the requirements of SAE/DOT/FMVSS/CMVSS standards when properly installed**
- Kit Includes: License Plate Bracket, 25-ft Harness and Stainless steel mounting hardware
- Waterproof construction, low profile design
- Acrylic lens, corrosion proof plastic housing
- Includes separate ground wire with eyelet

- Mount on 2" centers
- Passenger side light is 7-Functions: Stop, Turn, Tail, Rear Clearance, Rear Reflex, Side Marker, and Side Reflex
- Driver side light is 8-Functions: Stop, Turn, Tail, Rear Clearance, Rear Reflex, Side Marker, Side Reflex and License Illuminator
- Size: 8.063" x 2.875" x 2.813"

Item#	Case
51951	2

SUBMERSIBLE UNDER 80" COMBINATION REPLACEMENT LIGHT



- **Meets the requirements of SAE/DOT/FMVSS/CMVSS standards when properly installed**
- Screw-on lens, easy to change bulbs
- Stud mount on 2" centers
- Grounds through mounting studs
- Shock-proof socket guarantees long bulb life
- Acrylic lens, corrosion proof plastic housing

Item#	Description	Case
52991	Passenger Side Light / 6-function	6
53001	Driver Side Light / 7-function	6



SUBMERSIBLE UNIVERSAL MOUNT COMBINATION TAIL LIGHT



51471

51481

51471: Driver Side (7-Functions: Stop, Turn, Tail, Side Marker, Side and Rear Reflectors, and License Light)

51481: Passenger Side (6-Functions: Stop, Turn, Tail, Side Marker, Side and Rear Reflectors)

• Meets the requirements of SAE/DOT/FMVSS/CMVSS standards when properly installed

- Over 80" wide combination
- Waterproof construction
- Acrylic lens and plastic housing
- Includes separate ground wire with eyelet
- Mount on 2" centers
- Mounting hardware included
- Size: 6.063" x 3.75" x 2.25"

Item#	Description	Case
51471	7-Function, Driver Side	10
51481	6-Function, Passenger Side	10

WATERPROOF UNIVERSAL MOUNT COMBINATION TAIL LIGHT



51871

51881

51871: 8-Function, Driver Side: Stop, Turn, Tail, Side Marker, Side/Rear Reflectors, Rear Clearance and License Light

51881: 7-Function, Passenger Side: Stop, Turn, Tail, Side Marker, Side/Rear Reflectors, and Rear Clearance

• Meets the requirements of SAE/DOT/FMVSS/CMVSS standards when properly installed

- Waterproof construction, low profile design
- Acrylic lens, corrosion proof plastic housing
- Screw-on lens, easy to change bulbs
- Includes separate ground wire with eyelet
- Mount on 2" centers
- Size: 7.875" x 3.25" x 2.875"

Item#	Description	Case
51871	8-Function, Driver Side	10
51881	7-Function, Passenger Side	10

SUBMERSIBLE LED COMBINATION LIGHT



Features 14 Super LED lights. Sealed acrylic lens and impact housing

- Electronics completely sealed in epoxy to resist corrosion and moisture
- Meets DOT requirements
- 6 1/16" x 3 3/8" x 2 1/4"
- **Functions:** Tail light, Stop, Red side marker, Rear clearance light, Turn signal, Side and rear reflector.



Item#	Description	Case
52651	Right Side: Stop, tail, turn, rear and side reflector, side marker.	10
52661	Left Side: Stop, tail, turn, rear and side reflector, side marker and license illuminator.	10

LED WATERPROOF TRAILER LIGHT KIT



Contains two LED tail lights:
 (1) 6-function: stop, turn, tail, rear reflex, side marker, side reflex
 (1) 7-function: LED tail light with license light



• Meets the requirements of SAE/DOT/FMVSS/CMVSS standards when properly installed

- Traditional style fits many applications
- Waterproof performance
- Stud mount lights mount on 2" centers
- Hard wired, with separate ground wire
- Mounting hardware included

Item#	Case
52701	2

LED GLOLIGHT™ WATERPROOF TAIL LIGHTS

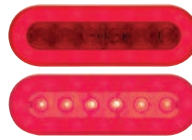

Contains two waterproof stop, tail, turn lights, Grommets and 3-Wire Plugs



• Meets the requirements of SAE/DOT/FMVSS/CMVSS standards when properly installed

- Sonically sealed, waterproof
- Mount in any 360 degree position
- 6.5" W x 2.25" H"

Item#	Case
52722	2

LED 6" OVAL SEALED LIGHTS FOR SURFACE MOUNT

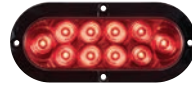

Meets the requirements of SAE/DOT/FMVSS/CMVSS standards when properly installed.

- Mount in any 360 degree position
- Sonically sealed, waterproof
- Flange surface mount—no panel cut-out required
- 3-function: Red stop/turn/tail light



Item#	Size	Case
52841	7.56" W x 3.31" H x 0.75" D	6

LED 6" OVAL SEALED TAIL LIGHT KIT FOR FLUSH MOUNT



• Meets the requirements of SAE/DOT/FMVSS/CMVSS standards when properly installed

- Sonically sealed, waterproof
- Kit includes light, grommet and plug
- 3-Function: Red stop/turn/tail light
- With A70GB grommet and A47PB pigtail, PL-3 connection



Item#	Size	Case
52831	6.5" W x 2.25" H x 1.75" D	6

3-FUNCTION SEALED OVAL FLUSH-MOUNT TAIL LIGHT



• Meets the requirements of SAE/DOT/FMVSS/CMVSS standards when properly installed

- Sonically sealed, waterproof
- 3-Function: Stop, Tail, Turn
- Polycarbonate lens and housing
- Installation hardware included
- Kit Includes: Light, Grommet, Plug (Pigtail)
- Size: 6.5" x 2.313" x 2.375"

Item#	Case
52931	6





LED FLEET COUNT® SEALED TAIL LIGHT



52791

52791: 12-LED, Passenger Side.
7-Function: Stop, turn, tail, rear clearance, rear reflex, side marker, side reflex.
Hard wired, with separate ground wire

52801: 18-LED, Driver Side.
8-Function: Stop, turn, tail, rear clearance, rear reflex, side marker, side reflex, license illuminator.
Hard wired, with separate ground wire

- Meets the requirements of SAE/DOT/FMVSS/CMVSS standards when properly installed
- Universal Mount
- Waterproof
- Low profile
- Acrylic lens, ABS plastic housing

Item#	Size	Case
52791	8" W x 2.875" H x 2.813" D	6
52801	8" W x 2.875" H x 2.813" D	6



SUBMERSIBLE IDENTIFICATION LIGHT BAR



- Snap out bulb slide
- Change bulbs without tools
- Red body
- 60" lead

Item#	Case
51851	10

SUBMERSIBLE IDENTIFICATION LIGHT BAR



- Meets the requirements of SAE/DOT/FMVSS/CMVSS standards when properly installed
- Meets Requirements for Over 80" Wide Trailers
- Sealed, waterproof
- Surface mount
- Polycarbonate lens and housing, stainless steel base
- Single wire self grounding

Item#	Size	Case
52511	14.25" L x 1.188" H x 1.313" W	10

LED SEALED 3-PIECE IDENTIFICATION LIGHT BAR



- Meets the requirements of SAE/DOT/FMVSS/CMVSS standards when properly installed
- Designed for Over 80" Wide Trucks/Trailers
- Waterproof
- 9 LED lights
- Single wire
- Grounds through mounting hardware
- Stainless steel base

Item#	Size	Case
52901	14.25" W x 1.188" H x 1.313" D	6

IDENTIFICATION LIGHT BAR



- Meets the requirements of SAE/DOT/FMVSS/CMVSS standards when properly installed
- Surface mount on 7 1/2" centers
- Sealed, waterproof lights
- Hard wired, power and ground
- Polycarbonate lens and housing, ABS base

Item#	Size	Case
52941	17" W x 1.438" H x 1.625" D	6

LED SEALED IDENTIFICATION LIGHT BAR



- Meets the requirements of SAE/DOT/FMVSS/CMVSS standards when properly installed
- Sonically sealed, waterproof
- Polycarbonate lens and housing
- Design includes both lead and ground wire

Item#	Size	Case
51831	15.938" x 1.469" x 1.625"	12

LED 7° BEND LIGHT BAR



- 6 LEDs
- "V" Shaped bend to fit contour of trailer
- 5/8" wire leads are copper braided and tinned for corrosion resistance
- Mounting holes are 8 1/2" on center

Item#	Size	Case
52501	14" L x 1" W x 1/2" D	10

SEALED MARKER/CLEARANCE LIGHT



52521

52531

- Meets the requirements of SAE/DOT/FMVSS/CMVSS standards when properly installed
- Sonically sealed, waterproof
- Stud-Mount
- Polycarbonate lens and housing, stainless steel base
- Single wire design grounds through mounting hardware
- Size: 2.063" x .688" x 1"

Item#	Lens	Case
52521	Amber	12
52531	Red	12

SUBMERSIBLE SEALED CLEARANCE MARKER LIGHT

- 18" lead wire
- Poly lens and housing are sonic welded

Opt. Accy.	Description	Case
52601	Red module only	12
52591	Amber module only	12





SUBMERSIBLE AMBER SIDE MARKER LIGHT W/ REFLECTOR



One piece made of Lexan™ with patented air trapping.

Item#	Size	Case
51841	5 1/2" x 3/4" x 1 1/2"	12

LED SQUARE STUD-MOUNT CLEARANCE/MARKER LIGHT

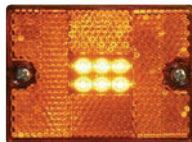

- Meets the requirements of SAE/DOT/FMVSS/CMVSS standards when properly installed
- Stud mount black base; two-wire design
- Lens with reflex eliminates need for separate reflector
- 6 diodes
- Installation hardware included
- Acrylic lens, ABS housing



Item#	Description	Size	Case
52891	Amber	2.875" x 2.125" x .938"	12

SURFACE MOUNT MARKER/CLEARANCE LIGHT WITH REFLEX

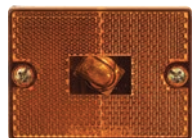

- Meets the requirements of SAE/DOT/FMVSS/CMVSS standards when properly installed
- Lens with reflex eliminates need for separate reflector
- Single wire design grounds through mounting hardware
- Screw-on lens, replaceable bulb, black plastic base
- Size: 3.875" x 2.375" x 1.094"

Item#	Mount	Color	Case
52611	Stud	Amber	6

LED MINI SEALED MARKER/CLEARANCE LIGHTS



- Meets the requirements of SAE/DOT/FMVSS/CMVSS standards when properly installed

- Sonically sealed, waterproof
- Accepts standard 1 or 2-wire plugs
- Single wire design grounds through mounting hardware
- Base and mounting hardware included
- Single diode
- Polycarbonate lens and housing

Item#	Description	Size	Case
52851	Amber	2.5" x 1.25" x 1"	12
52861	Red	2.5" x 1.25" x 1"	12

LED MINI SEALED CLEARANCE/MARKER LIGHTS



- Meets the requirements of SAE/DOT/FMVSS/CMVSS standards when properly installed

- Sonically sealed, waterproof
- Surface mount installation
- Accepts standard 2-wire plugs
- Chrome trim ring base and mounting hardware included
- Two diode
- Polycarbonate lens and housing

Item#	Description	Size	Case
52871	Amber	2.5" x 1.063" x 0.688"	12
52881	Red	2.5" x 1.063" x 0.688"	12

3/4" MINI SEALED MARKER/CLEARANCE KIT



- Meets the requirements of SAE/DOT/FMVSS/CMVSS standards when properly installed
- Fits any 3/4" opening
- Single diode
- Sealed, waterproof construction
- Polycarbonate lens and housing
- Hard wired, with separate ground wire
- Size: .074" x .074" x 0.90"



Item#	Lens	Case
52671	Amber	12
52681	Red	12

LED SEALED STUD MOUNT SIDE MARKER/CLEARANCE LIGHT



- Meets the requirements of SAE/DOT/FMVSS/CMVSS standards when properly installed

- Sonically sealed, waterproof
- Polycarbonate lens and housing, plated steel stud
- Single wire design grounds through mounting hardware (6" Lead)
- Size: 2.125" x 1.125" x 1.063"

Item#	Lens	Case
52561	Amber	6
52691	Red	6

REFLECTIVE TAPE KIT



- Complies with J1967 for vehicle conspicuity material, as well as meeting all D.O.T. requirements
- Rated at over 600 candlepower per square foot
- Hermetically sealed and unbreakable
- Mounts on flat or curved surfaces
- Not to replace legally required reflector

Item#	Size	Pack	Case
52951	18"	4	12

SUBMERSIBLE RECTANGULAR REFLECTOR

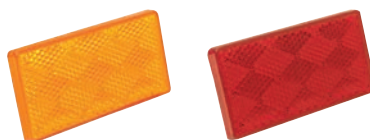

- Adhesive back for quick mounting
- Size: 3 1/4" x 1 5/8"

Item#	Lens	Pack	Case
52571	Amber	1 pr.	12
52581*	Red	1 pr.	12

TRAILER LIGHT BRACKET



Bolt these brackets on trailer frame to mount many different styles of lighting. Pre-drilled for easy attachment. Made of 11 gauge galvanized steel.

Item#	Size	Pack	Case
51751	4 1/2" x 3"	1 pr.	12

LICENSE PLATE BRACKET



- Black heavy duty plastic, corrosion-proof
- Universal Application
- Meets the requirements of SAE/DOT/FMVSS/CMVSS standards when properly installed

This Universal License Plate Bracket must be installed on the rear of the vehicle or trailer.

Item# 51811	Case 12
-----------------------	-------------------

MOLDED LINE CONNECTOR



Corrosion resistant construction. For 6, 12 and 24 volt applications. 7A @ 12V.

Item# 13841	Connector 2 Pole	Lead 12" on each side	Case 12
-----------------------	----------------------------	---------------------------------	-------------------

4-WAY FLAT CONNECTORS



Industry standard connector used for most light-duty applications including RV, marine & utility trailers where electric brakes or other additional power demands are not required.

- 18 Ga. Bonded Wire
- Tin Plated .187 Terminals for Improved Current Capacity and Corrosion Resistance
- Flexible Molded PVC Connectors
- 7.5 Amp Max Load
- Contains: Harness, Attachment Hardware, Detailed Wiring Instruction

Item#	Description	Lead	Case
57841	Car Side, for 2-Wire Systems	48"	6
57931	Car & Trailer Side Loop	60"	6
57851	Trailer Side	12"	6
57971	Trailer Side w/Separate Tail Light Wires	24"	6
57901	Trailer Side	48"	6
Opt. Accy. 58121	Description 4-Way Connector Cover w/ LED tester		6
57701	4-Way Flat Mounting Bracket		6

POWERED TAIL LIGHT CONVERTERS



Adapts import and domestic tow vehicles with 3-wire systems to tow trailers equipped with 2-wire systems. Powers trailer lighting directly from the tow vehicle's battery, keeping additional current draw away from sensitive vehicle circuits.

- Features advanced circuit protection to protect the tow vehicle's wiring systems from short-circuit or mis-wire situations
- Designed to operate with both incandescent and LED trailer lighting systems
- 16 ga. Single 60" input wires for stop lamp, tail lights, left turn & ground circuits (red, yellow, brown & white)
- 16 ga. Single 60" input wire for left turn circuit (green)
- 16 ga. Bonded 60" output wires with a molded 4-flat car-side connector
- Tin plated .187 4-flat connector terminals for improved current capacity and corrosion resistance

Item#	Description	Case
58001	Standard Duty. 11.2 Amp Max Load	6
58011	Standard Duty w/ Wiring Kit. 11.2 Amp Max Load	6
58021	Heavy Duty w/ Wiring Kit. 15.4 Amp Max Load	6

5-WAY FLAT CONNECTOR

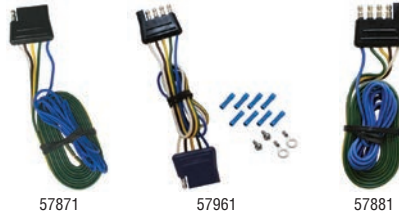

Industry standard connector used for light-duty applications where an auxiliary circuit is required for surge brake lockout or back-up lamp functionality.

- 16 Ga. Bonded Wire (Green, Yellow, Brown, White)
- 16 Ga. Single Wire (Blue)
- Tin Plated .187 Terminals for Improved Current Capacity and Corrosion Resistance
- Flexible Molded PVC Connectors
- 7.5 Amp Max Load
- Contains: Harness, Detailed Wiring Instructions

Item#	Connector	Lead	Case
57871	Car	48"	6
57961	Car & Trailer	60"	6
57881	Trailer	12"	6
Opt. Accy. 57951	Description 5-Way Connector Cover	Fits	Case 6

7-WAY MOLDED CONNECTOR WITH WIRING HARNESS



UV resistant cable. Blade-type connector. Molded connector design resists breakdown. Compatible with both RV and USCar style vehicle connectors.

Item#	Connector	Lead	Case
58111	7-Way	8'	1

7-WAY ROUND RV-STYLE CONNECTORS



Designed for use with RV's and heavier utility & equipment trailers equipped with electric brakes.

57991: Spring loaded connector door repels moisture when not in use. Oversize door hinge provides long lasting durability. Attachment holes align with most industry mounting brackets. Flat blade tin-plated terminals feature convenient Phillips screw wire attachment

57981: Spring loaded connector door repels moisture when not in use. Slotted attachment holes align with most industry mounting brackets. Flat blade brass terminals feature convenient Phillips screw wire attachment.

57921: Flat blade tin-plated terminals feature convenient Phillips screw wire attachment

- Supports tail lights, stop & turn lamps, trailer brake 12V+ feed and auxiliary connections
- Heavy-duty molded ABS plastic connector body resists corrosion
- Stylish and ergonomic
- 30 Amp max load

Item#	Description	Case
57991	Car Side	6
57981	Car Side w/Sealed Door	6
57921	Trailer Side, Ultra HD	6
57891	Trailer Side	6
Opt. Accy. 58031	Description Attachment Bracket w/ Clamp for Mounting	Case 6



7-WAY ROUND USCAR STYLE CONNECTORS



57861 57911 57941

Designed for use with RV and heavier utility & equipment trailers equipped with electric brakes.

57861: Attachment holes align with most industry mounting brackets. Direct replacement for factory 7-way connectors on most Audi, Chrysler, Dodge, Ford, Jeep, Porsche, Ram, Toyota and Volkswagen vehicles equipped with trailer tow package wiring.

57911: Oversize door hinge provides long lasting durability. Direct replacement for factory 7-way connectors on most Audi, Chrysler, Dodge, Ford, Jeep, Porsche, Ram, Toyota and Volkswagen vehicles equipped with trailer tow package wiring.

57941: Features Twist-Lock style mounting to factory bracket. Fits '99-Current GM "Twist-Lock".

- Supports tail lights, stop & turn lamps, trailer brake 12V+ feed and auxiliary connections
- Potted connector terminals and gasketed spring-loaded door for strong weather-resistant design
- Plastic connector body resists corrosion
- Easily snaps onto mating harness assembly
- Compatible with RV-style 7-way trailer connectors
- 30 Amp max load

Item#	Description	Case
57861	Car Side, Heavy Duty	6
57911	Car Side, Heavy Duty	6
57941	Car Side, Twist-Lock	6

Opt. Accy.	Description	Case
57711	7-Way USCar (OEM) Style Bracket	6
58031	Attachment Bracket w/ Clamp for Mounting	6

FLAT CONNECTOR COVER



58121

Keeps connector clean. Built-in tether retains cover when not in use. Helps to prevent rust & corrosion. Manufactured from black PVC rubber.
58121: Tests stop, turn and tail light functions at 4-flat connector

Item#	Description	Fits	Case
57951	5-Way Connector Cover		6
58121	4-Way Connector Cover w/ LED tester		6

TRAILER WIRE HARNESS EXTENSION



Item#	Connector	Lead	Case
13991	4 Pole	48"	12
13931	5 Pole	48"	12

TRAILER PLUG TESTER



13911 13921

Tester plugs into tow vehicle. LED illuminates to show if connections are correct and working.

Item#	Description	Case
13911	Trailer Plug Tester - Inline	12
13921	Trailer Plug Tester	12

4-FLAT TO 5-FLAT TRAILER WIRING ADAPTER



Item#
57721

- Supports tail lights, left & right stop & turn lamps and auxiliary circuit
- Durable molded plastic connectors resist corrosion
- Pin-style tin plated terminals
- 7.5 Amp max load
- Contents: Adapter and Auxiliary Circuit Lead

Case
6

6-WAY ROUND TO 4-FLAT ADAPTER



Item#
57731

- Supports tail lights, left & right stop & turn lamps
- Durable molded plastic housing resists corrosion
- 6-Way round-pin brass terminals
- 4-Way round pin-style brass terminals
- 7.5 Amp max load

Case
6

7-WAY BLADE TO 4-FLAT ADAPTER WITH LED COVER



Protective Cover

Item#
57741

- Supports tail lights, left & right stop & turn lamps
- Durable molded plastic housing resists corrosion
- 7-Way flat blade brass terminals
- 4-Way flat pin-style tin plated terminals
- 7.5 Amp max load

Case
6

7-WAY TRAILER WIRING ADAPTERS



58091

58051



58061

58081

Durable molded plastic housing resists corrosion.
58051, 58061, 58081: Flat blade brass terminals to flat pin-style tin plated terminals.

Item#	Description	Case
58091	7-Way automotive style to 4-flat	6
58051	7-Way RV style to 4-flat	6
58061	7-Way RV style to 5-flat	6
58081	7-Way RV style to 6-way	6

7-WAY ADAPTER



13831

13881

13821

Adapter mates 7-way vehicle to 4 or 5-way trailer.

Item#	Connection	Length	Case
13831	7 Way Round to 4 Way Flat	8"	12
13811	7 Way Round to 4 Way Flat	18"	12
13881	7 Way Round to 5 Way Flat	8"	12
13821	7 Way Round to 5 Way Flat	18"	12

7-WAY ROUND TO 5 WAY FLAT ADAPTER WITH LEAD



Adapts the vehicle to the trailer connector without the need for an extension.

Item#
52981

Length
16"

7-WAY BLADE TO 6-WAY ROUND AND 5-WAY FLAT ADAPTER



- Supports tail light, left & right stop & turn lamps & auxiliary circuits
- Also supports 4-way flat trailer connections
- Durable molded plastic housing resists corrosion
- 7-Way flat blade brass terminals
- 5-Way flat pin-style tin plated terminals
- Includes dust covers for both 6-way and 5-flat connector ends

Item#
58101

Case
6

7-WAY TO SINGLE 12V ACCESSORY PORT



- Ideal for tailgating
- Cigarette port provides 12V power at rear of vehicle for a wide variety of uses

Item#
58071

Case
6

4-WAY FLAT FACTORY TOW HARNESS



Factory tow harness kits offer a quick/easy method of replacing or upgrading missing or damaged tow-package wiring connector in today's most popular vehicles.

- No cutting or splicing of wires, simply plug into the tow vehicle's factory wiring harness connector

- Clean "factory" appearance
- Manufactured using OEM factory harness connectors
- 16 Ga. Bonded wire
- Flexible molded PVC 4-flat car side trailer connector
- No special tools required
- 15.4 Amp max load
- Contains: Tow Harness, Attachment Hardware, Detailed Installation Instructions

Item#
57831

Fits
Current GM Trucks & SUV's w/USCar 7-Way Harness

Case
6

4-WAY WISHBONE STYLE WIRING HARNESSSES



Wire descriptions: White - ground, Brown - tail lamps, Yellow - driver side stop/turn, Green - passenger side stop/turn. 25-ft 4-way harness with 4-ft trunk connector.

Item#
52961

Length
25'

Case
6

UNIVERSAL DUAL PLUG BRAKE CONTROL



- Use with vehicles that do not have OEM plug
- Universal fit through hardware to the towing vehicle
- Plug end quickly connects to brake control

Item#
58281

Length
24"

Case
6

TRAILER WIRING MOUNTING BRACKET



57701



58041

- Mounts wiring connectors to rear of tow vehicle
- Convenient "Push-In" connector mounting
- Black powder coat finish
- Contains mounting hardware

Item#
57701

Description
4-Way Flat Mounting Bracket

Case
6

6 AND 7-WAY ROUND CONNECTOR BRACKET



Attachment Bracket w/ Clamp

Conveniently attaches electrical connector mounting brackets to trailer hitch cross tubes without cutting, welding or drilling.

- Convenient hose clamp mounting
- Black powdercoat finish
- Contains: Mounting Bracket, Attachment Clamp, (2) Bolts & Lock Nut

Item#
58031

Description
Attachment Bracket w/ Clamp for Mounting

Case
6

TRAILER "Y" HARNESS



Flat - 4 Pole. Consists of 48" vehicle side connector and 25' trailer side color coded wires. Trailer side split to allow routing of wire down both sides of trailer for easy hook-up. Safe color coded wires. Includes 6 frame straps and 2 quick splice connectors.

Item#
13941

Description
Copper Wire

Case
12

Item#
13961

Description
Marine-grade Tinned Wire

Case
12

TRAILER LIGHT CONVERTER



Heavy duty unit allows amber turn signals (5 wire systems) on tow vehicle to operate standard 4-wire trailer systems. Made of black ABS plastic. Made to be wired directly into trailer wire harness.

Item#
51491

Case
12

OEM STYLE TRAILER CONNECTOR MOUNTING BRACKET



- Universal design
- Mounts either USCar or RV-Style 7-way wiring connectors to rear of tow vehicle
- Bolt-on connector mounting
- Black powdercoat finish
- Contains mounting hardware

Item#
57711

Description
7-Way USCar (OEM) Style Bracket

Case
6



UNIVERSAL PROFLO MOTOR FLUSHER



Flush away sand, silt and salt. Prevents clogging and corrosion. For use on most outboards and inboard/outboards with side water inlets.

Item# 18301 **Case** 25

RECTANGULAR MOTOR FLUSHER



Flush away sand, slit and salt. Prevents clogging and corrosion. For use with most outboards and inboard/outboards.

Item# 18321 **Case** 25

MOTOR FLUSHER



Heavy-duty high impact plastic flusher. Recommended for larger engines. Quickly flushes away salt, silt, alkali and sand. Extends engine life by preventing clogging and corrosion. 4 stainless steel hose clamps included.

Item# 18311 **Case** 12

OUTBOARD FLUSH KIT



Fits all outboards flushing port. Easily snaps on, quickly flushes salt water from outboard. O-ring sealed. Slide valve stays on engine permanently. EASY installation! Kit contains: slide valve, quick connect, rubber washer.

Item#	Description	Case
18401	OMC O/B Flush Kit	12
18411	Mercury/Mariner/Yamaha/Honda/Suzuki Flush Kit	12

EXHAUST GUARD COVER



Black rubber with adjustable stainless steel clamp. Flap valve prevents following seas from entering exhaust outlet when stopping or moving slowly. All stainless steel clamps included.

Item#	Size	Pack	Case
28351	3"	1 pr.	12
28361	4"	1 pr.	10

New PROPPELLER WRENCH



Includes screw to release tab washer. Made of non-corrosive material.

Item#	Fits	Color	Case
79851	1 1/16" Prop Nuts 3/16" Garboard Drain Plug	Blue	24

STEERING ACCESSORIES

DESTROYER STEERING WHEEL



28541

28551

28581

- 5 spoke for sturdy trouble free operation
- Diameter - 15"
- Dish - 25°
- Fits standard 3/4" tapered shaft
- All welded and polished 304 stainless steel construction

Item#	Description	Case
28541	Stainless Steel with turning knob & black center cap	5
28551	Stainless Steel with genuine teak cap	5
28581	Stainless Steel with permanent foam grip & black center cap	5

Repl. Parts	Description	Fits	Case
28591	Black Plastic Cap	28551/28581/28541	12
28561	Teak Center Cap	28551/28581	12

STEERING WHEEL



Rim features rich leather grain, stitching and finger grips.

- 4 spoke
- Dish - 3 1/8"
- U.V. resistant
- Fits all standard 3/4" tapered shafts
- Meets NMMA, ABYC and IMCI standards

Item#	Dia.	Pack	Case
28510	13 1/2"	Bulk	10

FLAT STEERING WHEEL



- 3 spoke
- 304 stainless steel
- Fits standard 3/4" tapered shafts
- Stainless steel center cap included

Item#	Dia.	Case
28471	15"	5

SPORTS STEERING WHEEL WITH TURNING KNOB



- 3 spoke
- Stainless steel fits 3/4" tapered shaft
- Includes 3/8" - 18 and 1/2" - 20 nut

Item#	Dia.	Case
28481	13 1/2"	5
28531	15 1/2"	5

Repl. Parts	Description	Size	Case
28431	Replacement Nut	12mm	12
28441	Replacement Nut	1/2"-20	12
28461	Replacement Nut	5/8"-18	12

STAINLESS TURNING KNOB



Easily converts existing Destroyer wheels to the most modern versions. Installation tool included. **Fits Destroyer wheels only.**

Item#
28521 **Case**
12

LARGE STAINLESS STEEL TURNING KNOB



Easily converts existing Destroyer wheels to the most modern versions. Attractive and durable black plastic center. **Fits Destroyer wheels only.**

Item#
28491 **Case**
12

TWIN LEVER CONTROL



Made of chrome plated brass. Each separate lever controls clutch and throttle for one engine. **Not for dual station applications.** Functions easily identified by red and black knobs. Designed to use 33C type control cables. Shims and cable clamps are made of brass and are supplied for easy installation. Overall height 8³/₁₆"
Base: 4⁵/₁₆" W x 5⁷/₁₆" L x 3" H

Item#	Description	Fastener	Case
28401	Twin Lever Control	# 10 screws	6
28411	Red Knob		12
28421	Black Knob		12

TILLER ROPE PULLEY



Pair of stainless steel and plastic pulleys with two stamped stainless steel eye straps. Maximum rope size: 1/4". OD of sheave: 2³/₁₆". 3³/₄" overall length.

Item#	Pack	Case
28501	1 pr.	12

TILLER ROPE CLAMP



For use with 1/8" or 3/16" rope. Chrome plated zinc. Dimensions: 1¹/₄" x 1¹/₁₆".

Item#	Pack	Case
28601	1 pr.	12

TRANSOM TRIM CONTROL



Provides a weatherproof tilt control system at the stern area of the boat. Can be used for remote adjustment of hydraulic plates. 18" wiring harness included.

Item#	Case
28131	12

STEERING TUBE CLEANING BRUSH



- Cleans tilt tubes
- For use with electric drills
- Sold in pairs

Item#	Pack	Case
90391	1 pr.	12

STEERING CABLE PROTECTOR



Heavy-duty rubber boot to fit over output end of steering cable at engine for complete protection from elements and preventing lubrication from being washed away. Fits all standard steering cables including Morse, Teleflex, Detmar, etc. Dimensions: 1" ID steering cable end, 3/8" ID output end, 1¹/₂" overall diameter, 10" extended length, 3¹/₂" minimum length.

Item#	Case
28301	10

STEERING GUARD



The Steering Guard should be installed on all cable and side-mounted hydraulic steering systems to lubricate, clean and seal the system. Will more than double the life of a new cable system. Made of stainless steel. Installs in 10 minutes. Eliminates greasy steering rods forever.

28251: Fits Honda, Mercury, Mariner, Johnson, Evinrude, Nissan, Suzuki, Tohatsu, Yamaha and Force with 7/8" thread.
28261: Fits Honda, Mercury, and Mariner with 1" thread.

Item#	Size	Case
28251	7/8"	12
28261	1"	12

MOTORWELL BOOT



29301

29251

Seals off water intake and protects cables, wiring and gas lines. Made of durable vinyl plastisol.

Item#	Size	Pack	Case
29301	3"		12
29300	3"	Bulk	24
29251	4"		12
29250	4"	Bulk	24

New LCD HOURMETER



15181

15271

- Flush mount flange
- 100K Hours
- Illuminated
- 12/24V

Item#	Size	Finish	Case
15181	2 ¹ / ₁₆ "	White & Chrome	10
15271	2 ¹ / ₁₆ "	Black & Black	10

HOURLMETERS



15301

15311

15321

High impact polycarbonate case. Self-lubricating parts, increases shelf life, reduces friction. Polarity insensitivity prevents installation errors. U-bracket mounting. 4V to 50V DC. Meets NEMA and SAE specifications.

Item#	Finish	Case
15301	Stainless Steel Bezel	10
15311	Black Bezel	10
15321	Rectangular	12

INSTRUMENT PANEL HOLE COVER



- For quick and easy concealment of holes on deck or instrument panels
- High impact plastic
- Snaps into place - no fasteners needed

Item#	Size	Case
15331	2 ¹ / ₁₆ "	10

MARINE SPEEDOMETER PITOT KIT



Kit Includes:

- 20' PVC tubing
- (1) Black plastic clam shell vent
- (4) Black plastic tube holder
- (6) Stainless steel self-tapping screws

Item#	Description	Length	Case
15391	Pitot Kit		12
15381	Pitot Tubing	100'	12



New SEACHOICE SERIES GAUGES

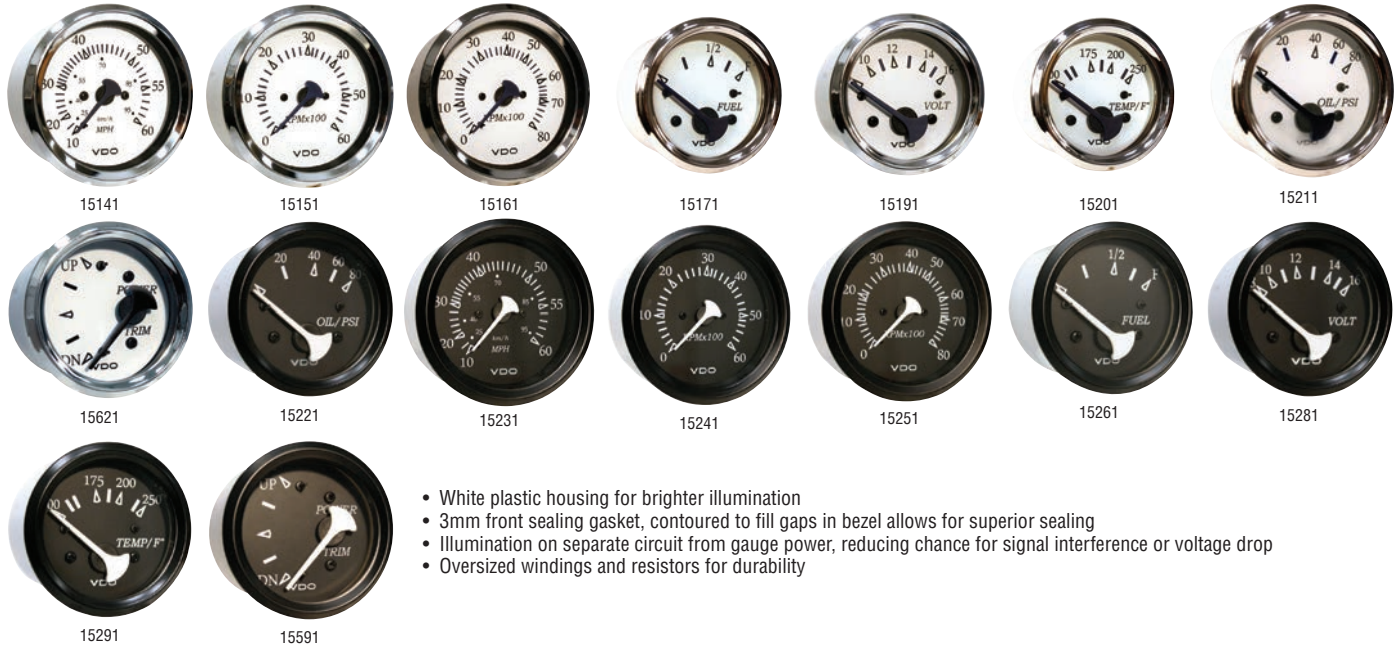

- White plastic housing for brighter illumination
- 3mm front sealing gasket, contoured to fill gaps in bezel allows for superior sealing
- Illumination on separate circuit from gauge power, reducing chance for signal interference or voltage drop
- Oversized windings and resistors for durability

Item#	Size	Type	Dial Range	Case
Chrome & White				
15141	3 3/8"	Speedometer	0 MPH - 60 MPH	12
15151	3 3/8"	Tachometer (Sterndrive)	0 RPM - 6,000 RPM	12
15161	3 3/8"	Tachometer (Outboard)	0 RPM - 8,000 RPM	12
15171	2 1/16"	Fuel Gauge	E - 1/2 - F	10
15191	2 1/16"	Voltmeter	8 - 16V	10
15201	2 1/16"	Engine Temp Gauge	100F - 250F	10
15211	2 1/16"	Oil Pressure Gauge	80 PSI	10
15611	2 1/16"	Trim Gauge (Volvo-Penta, Mercury, Yamaha)	Up - Down	10
15621	2 1/16"	Trim Gauge (Evinrude/Johnson)	Up - Down	10
15631	2 1/16"	Trim Gauge (Honda)	Up - Down	10
Black & Black				
15221	2 1/16"	Oil Pressure Gauge	80 PSI	10
15231	3 3/8"	Speedometer	0 MPH - 60 MPH	12
15241	3 3/8"	Tachometer (Sterndrive)	0 RPM - 6,000 RPM	12
15251	3 3/8"	Tachometer (Outboard)	0 RPM - 8,000 RPM	12
15261	2 1/16"	Fuel Gauge	E - 1/2 - F	10
15281	2 1/16"	Voltmeter	8 - 16V	10
15291	2 1/16"	Engine Temp Gauge	100F - 250F	10
15581	2 1/16"	Trim Gauge (Volvo-Penta, Mercury, Yamaha)	Up - Down	10
15591	2 1/16"	Trim Gauge (Evinrude/Johnson)	Up - Down	10
15601	2 1/16"	Trim Gauge (Honda)	Up - Down	10

PITOT TUBE



Weed resistant system provides steady water pressure required for accurate readings. Kick-up feature prevents breakage.

Item#	Case
15401	12

MOTORGUIDE MOUNTING BOLT AND ISOLATOR



Above deck, easy mounting. Absorbs trailering and rough water shock. Set of 4.

Item#	Case
28071	12

FOOT CONTROL SWITCH



Foot control switch for manually operated (hand controlled) trolling motors. Provides the convenience of turning the motor on by simply pressing down on the switch with your foot without having to reach the trolling motor head. The foot switch is rated up to 50A DC and features a 15° tilt angle for ease of operation. Has flip lever for continuous "on".

Item#	Volts	Case
28101	12/24	12

TROLLING MOTOR PLUG



6" Leads with yellow butt connectors attached to 10 gauge wire. Face plate 1 3/4" x 2 1/2". 13761 will not work with 13751.

Item#	Description	Volts	Case
13751	Straight Male, Motor Side	12	12
13761	Straight Female, Motor Side	12	12
13771	Receptacle Female, Boat Side	12	12



ELASTOMERIC MARINE SEALANT



3 oz. 10 oz.

For use below or above waterline

- Fast curing and permanently flexible: full cure in 1 to 7 days at 40°F to 130°F
- Non staining or sagging
- Adheres tenaciously to fiberglass, wood, metal, glass, plexiglass, Lexan and other plastics
- Sandable and paintable
- Clean-up with mineral spirits
- Not recommended for deck seams or areas in contact with gasoline

Item#	Size	Color	Case
96891	3 oz.	Clear	6
96881	3 oz.	White	6
96911	10 oz.	Clear	6
96901	10 oz.	White	6

HIGH PERFORMANCE MARINE SILICONE SEALANT - WHITE



2.8 oz. 10.1 oz.

- 100% Pure silicone
- High Performance construction silicone (used to adhere windows in sky scrapers)
- Superior adhesion on Gelcoat, metals & plastics
- Non-corrosive-unaffected by chemicals, fuel or UV
- Good Tear Resistance
- Permanently flexible & waterproof
- Low odor
- UL Recognition
- **Not for use below waterline**

Item#	Size	Color	Case
96961	2.8 oz. tube	White	12
96971	10.1 oz. cart.	White	12

MARINE SILICONE SEALANT - CLEAR



2.8 oz. 10.1 oz.

- 100% Pure silicone - uncut
- General purpose
- Permanently flexible
- Cures at room temperature
- Excellent weatherability
- Mold & mildew resistant-unaffected by chemicals, fuel or UV
- UL Recognition
- **Not for use below waterline**

Item#	Size	Color	Case
96931	2.8 oz. tube	Clear	12
96941	10.1 oz. cart.	Clear	12

WIRE BRUSHES



92001 92011

Wood handle. Brass bristles are used for softer applications.

Item#	Size	Type	Case
92001	7¾"	Stainless Steel	48
92011	7¾"	Brass	48

SAFETY GOGGLES



These high impact safety goggles meet the requirements of the Standard for Occupational and Educational Eye and Face Protection ANSI Z87.1-2003.

Item#	Lens	Case
92071	Clear, Polycarbonate	12

SAFETY GLASSES



Meet the requirements of the Standard for Occupational and Educational Eye and Face Protection ANSI Z87.1-2003.

Item#	Lens	Case
92081	Clear, Polycarbonate	12

WIRE ROLLER FRAME



92101 92141

- Plated rods
- 1½" diameter
- Plastic threaded handle

Item#	Size	Case
92101	3", 4 Wire	24
92111	4", 4 Wire	24
92121	7", 4 Wire	24
92131	9", 4 Wire	24
92141	9", 5 Wire (Heavy Duty)	24

12" WIDE ROLLER FRAME



Adjustable frame.

Item#	Size	Case
92161	12"-20"	20

PAINT TRAYS



Metal Plastic

Paint trays have ladder lock legs.

Item#	Size	Material	Case
92201	9"	Metal	24
92211	9"	Plastic	24
Opt. Accy.	Description	Size	Case
92221	Plastic Tray Liner	9"	25

12" WIDE PAINT TRAY



Accommodates wide roller frames and has an extra deep well.

Item#	Size	Material	Case
92231	12"	Plastic	20



DOUBLE WIDE BRUSH



Improved thicker handle with longer bristles. Double thick, natural color hog bristles with plain wood handle for applying fiberglass resins and adhesives. Withstands most thinners.

Sold in Full Cases Only.

Item#	Size	Pack	Case
90300	1/2"	Bulk	24
90310	1"	Bulk	24
90320	1 1/2"	Bulk	24
90330	2"	Bulk	12
90340	2 1/2"	Bulk	12
90350	3"	Bulk	12
90370	4"	Bulk	12

FOAM BRUSH



Quality, high density foam with wooden handle. For all smooth surfaces. Ideal for the application of enamel, latex, stain, oil paints and varnish. Not for shellac or lacquer. Sold by the box.

Item#	Size	Box
92411	1"	50
92421	2"	50
92431	3"	20
92441	4"	20

PAINT STRAINER - CONE TYPE



Medium nylon mesh and disposable. Sold by the box.

Item#	Box	Case
92601	100	12

FOAM ROLLER COVERS - HEAVY DUTY

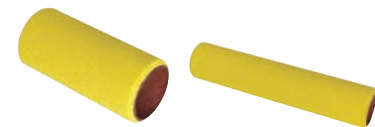

92501

92521

- Rollers are extra thick for longer painting action
- Great for tight spots
- Can be used with bottom paints
- Polypropylene core

Item#	Size	Color	Thickness	Pack	Case
92501	3"	Yellow	5mm		50
92511	7"	Yellow	5mm		50
92521	9"	Yellow	5mm		50
92311	4"	Yellow	3mm		25
92301	4"	Yellow	3mm	1 pr.	25
92321	7"	Yellow	3mm		25
92331	9"	Yellow	3mm		25

12" WIDE ROLLER COVER



Phenolic core.

Item#	Size	Nap	Color	Case
92741	12"	1/8"	White	36
92861	12"	1/4"	White	36
92851	12"	3/8"	White	36

ROLLER COVERS - HEAVY DUTY



92701

92801

92721

92841

92881

92891

All roller covers have a phenolic core and come in a variety of colors for your personal preference.

Item#	Size	Nap	Color	Material	Pack	Case
92701	3"	1/8"	Red	Mohair		50
92801	3"	3/8"	White	Polyester		50
92711	4"	1/8"	Red	Mohair		50
92811	4"	3/8"	White	Polyester		50
92721	7"	1/8"	Red	Mohair		36
92821	7"	3/8"	White	Polyester		36
92731	9"	1/8"	Red	Mohair		36
92841	9"	1/4"	White	Polyester		36
92831	9"	3/8"	White	Polyester		36
92881	9"	3/8"	White	Polyester	1 pr.	25
92891	9"	3/8"	Yellow	Polyester		36

MINI ROLLER COMPONENTS



92901

92911

92921



92931

Ideal for tight spaces.

92901: 1/2" Solvent resistant nap can be used with all paints including bottom paints.

92911: Foam is used for all smooth surfaces. Ideal for the application of enamel, latex, stain, oil paints and varnish. Not for shellac or lacquer. Domed on two sides

92921: Plated rods with plastic threaded handle

92931: Durable and solvent resistant. Features a peg hook hole for hanging storage.

Item#	Description	Size	Pack	Case
92901	Acrylic, Yellow Stripe	4"	1 pr.	50
92911	Foam, White	4"	1 pr.	50
92921	Mini Roller Frame	4"		50
92931	Plastic Tray	4"		48

MINI ROLLER PAINT KIT



92941

92951

Ideal for tight spaces.

Kits include: 4" Plastic Paint Tray (92921), Two 4" covers (Acrylic-92901 or Foam-92911) and Mini Roller Frame (92931).

Item#	Description	Case
92941	Tray & 1/2" Nap Acrylic Rollers	24
92951	Tray & Foam Rollers	24

PAINT KIT



92981



92991

Kits include: 9" wire frame (92131), 2" double wide chip brush (90330), 9" white polyester cover with 3/8" nap and phenolic core (92831) and a plastic paint tray (92211) or metal (92201).

Item#	Description	Case
92981	Plastic Tray Kit - 4 pc.	20
92991	Metal Tray Kit - 4 pc.	20

COVERALLS - SMS DISPOSABLE



Suit w/Collar

Suit w/Hood

- White disposable coveralls protect against sprays, dust, coatings and fibers
- 3 Layer breathable SMS fabric (spunbond-meltblown-spunbound)
- Protection against fine dry particles (Type 5)
- Protection against limited liquid splash and fine sprays (Type 6)
- Zipper front, elastic wrist and ankle openings and front and back pockets

Item#	Description	Size	Case
93051	Suit w/Collar	L	25
93061	Suit w/Collar	XL	25
93071	Suit w/Collar	XXL	25
93111	Suit w/Hood	L	25
93121	Suit w/Hood	XL	25
93131	Suit w/Hood	XXL	25
93141	Suit w/Hood	XXXL	25
93151	Suit w/Hood	XXXXL	25

COVERALLS - MICROPOROUS DISPOSABLE



Suit w/Collar

Suit w/Hood

- White disposable coveralls protect against sprays, dust, coatings and fibers
- Professional grade suits-breathable
- Made of Polyethylene-laminated polypropylene (spunbond-film)
- High level of protection from resins, fiberglass, paints and sanding dust (Type 5 & 6)
- Zipper front, elastic wrist and ankle openings and front and back pockets

Item#	Description	Size	Case
93171	Suit w/Collar	L	25
93181	Suit w/Collar	XL	25
93191	Suit w/Collar	XXL	25
93231	Suit w/Hood	L	25
93241	Suit w/Hood	XL	25
93251	Suit w/Hood	XXL	25
93261	Suit w/Hood	XXXL	25
93271	Suit w/Hood	XXXXL	25

ANTI-SLIP SHOE AND BOOT COVERS



Shoe

Boot

Anti-slip covers keep paint, resins, overspray and other materials off your footwear. One size fits most. Sold by the box.

Item#	Description	Box
93001	Shoe	50
93021	Boot	50

BOAT WASH



90601

90611

Heavy duty biodegradable formula foams easily and its special cleaning agents remove tar, gas stains, exhaust smudges, scum line and fish blood. It won't spot or streak.

Item#	Description	Size	Case
90601	Boat Wash	32 oz.	12
90611	Boat Wash	1 gal.	4
90615	Boat Wash (Canada Only)	950 ml (32 oz.)	12
90605	Boat Wash (Canada Only)	3.78 L (1 gal.)	4

EZ-ON EZ-OFF HULL AND BOTTOM CLEANER



90781

90791

The best and easiest way to clean dirty bottoms and hulls. Loosens tough marine deposits, removes stubborn stains quickly and without hard scrubbing. Formulated with a special buffered acid that is safer to use than the harsh acids found in traditional bottom cleaners. Water based, environmentally friendly formula. Ideal for cleaning baitwells, fish boxes or in-deck storage.

Item#	Description	Size	Case
90781	EZ-ON EZ-OFF	32 oz.	6
90791	EZ-ON EZ-OFF	1 gal.	4
90785	EZ-ON EZ-OFF (Canada Only)	950 ml (32 oz.)	6
90795	EZ-ON EZ-OFF (Canada Only)	3.78 L (1 gal.)	4

HULL CLEANER



90681

90691

Biodegradable formula removes stains from grassy marine growth, rust and waterlines. Safe for use on all surfaces.

Item#	Description	Size	Case
90681	Hull Cleaner	32 oz.	12
90691	Hull Cleaner	1 gal.	4
90695	Hull Cleaner (Canada Only)	950 ml (32 oz.)	12
90685	Hull Cleaner (Canada Only)	3.78 L (1 gal.)	4



ULTRA CLEAN



Formulated with the latest technology ingredients to be the toughest crud-buster ever. The special chelating agents attack road grime, bug bits, bird deposits, greasy smears and more, breaking the bond that holds them to the surface so they can be wiped away without heavy scrubbing. Does not contain caustic, dangerous chemicals that can damage the finish. Safe for use on all metal, fiberglass, plastic, chrome, stainless, leather and rubber surfaces.

Item#	Description	Size	Case
90661	Ultra Clean	32 oz.	6
90671	Ultra Clean	1 gal.	4
90665	Ultra Clean (Canada Only)	950 ml (32 oz.)	6
90675	Ultra Clean (Canada Only)	3.78 L (1 gal.)	4

NON-SKID DECK CLEANER



Safe on fiberglass, metal or painted surfaces. Foams out ground-in dirt and stains. No harsh chemicals. Leaves a protective coating to repel dirt and stains.

Item#	Description	Size	Case
90641	Non-Skid	32 oz.	12
90651	Non-Skid	1 gal.	4
90645	Non-Skid (Canada Only)	950 ml (32 oz.)	12
90655	Non-Skid (Canada Only)	3.78 L (1 gal.)	4

MILDEW STAIN REMOVER



Removes mildew stains on contact without heavy scrubbing. Simple to use; spray on, scrub lightly and rinse off stains. Safe for use on fiberglass, painted surfaces, rubber, plastic and vinyl headliners, bolsters and upholstery. Special buffered formula will not harm vinyl upholstery or thread. Ideal for home or RV use, too. Does not weaken fabric or thread. Formulated specifically for use on marine upholstery; will not harm vinyl or stitching.

Item#	Description	Size	Case
90621	Mildew Stain Remover	32 oz.	12
90631	Mildew Stain Remover	1 gal.	4
90625	Mildew Stain Remover (Canada Only)	950 ml (32 oz.)	6
90635	Mildew Stain Remover (Canada Only)	3.78 L (1 gal.)	4

BILGE CLEANER



Biodegradable heavy duty formula dissolves and removes grease, oil fuel sludge and foul odors. Safe on fiberglass, metal and plastic.

Item#	Description	Size	Case
90701	Bilge Cleaner	32 oz.	12
90711	Bilge Cleaner	1 gal.	4
90715	Bilge Cleaner (Canada Only)	950 ml (32 oz.)	12
90705	Bilge Cleaner (Canada Only)	3.78 L (1 gal.)	4

INSTANT FRESH TOILET TREATMENT



- Non-formaldehyde, non-staining, biodegradable formula
- Latest technological lubricants keep drain valves from sticking
- Breaks down waste quickly and efficiently
- One ounce treats five gallons
- Fresh lemon scent controls holding tank odors
- Complies with EU criteria for biodegradable products; contains lubricants that prevent drain valves from sticking

Item#	Description	Size	Scent	Case
90751		32 oz.	Lemon	6
90761		64 oz.	Lemon	4
90771		1 gal.	Lemon	4
90755	(Canada Only)	950 ml (32 oz.)	Lemon	6
90765	(Canada Only)	1.89 L (64 oz.)	Lemon	4
90775	(Canada Only)	3.78 L (1 gal.)	Lemon	4

SALT REMOVER WITH PTEF®



The concentrated formula quickly and effectively removes salt deposits from metal, fiberglass, plastic or painted surfaces. It contains special PTEF® polymers that bond to the treated surface to help prevent the formation of future deposits. Depending on the application, Salt Off can be sprayed directly onto the surface to be treated and then rinsed with fresh water, or simply left in place. Safe for use on all boats, vehicles, trailers, marine parts, engines, fishing and dive gear and more. It will not etch, stain or otherwise damage metal or plastic surfaces.

Item#	Description	Size	Case
90721	Salt Off	32 oz.	6
90741	Salt Off	1 gal.	4
90731	Salt Off Kit w/ applicator	32 oz.	12
90725	Salt Off (Canada Only)	950 ml (32 oz.)	6
90745	Salt Off (Canada Only)	3.79 L (1 gal.)	4
90735	Salt Off Kit w/ applicator (Canada Only)	950 ml (32 oz.)	6



BUCKET WITH HANDLE



Durable and practical. This bucket serves multiple purposes.

Item#	Capacity	Case
90120	5 Gallon	10

DECK BRUSH



- Fits standard size threaded handles
- Flared bristles and angled head
- Peg hook style packaging option

Item#	Size	Bristles	Case
90581	6"	Medium	6
90591	6"	Soft	6

"SUPER" HOL-TITE® HANDLE



Non-corrosive plastic handle holds two 4" suction cups. Useful for cleaning boat hulls from the water. Cups release easily from boat hull.

Item#	Case
37481	12

SELF PRIMING PUMP/SIPHON



Just shake end with glass ball while in tank to be drained. Put other end of hose in tank to be filled. Ideal for transferring liquids (fuel, water, etc.) Anti-static for transferring fuel.

Item#	Size	Case
19141	1/2" x 6'	12

DELUXE OIL CHANGE PUMP



This easy to use self priming pump is ideal for the removal of fuel, coolant and transmission fluid. Use it to pump out bilge water and trapped fluids. Perfect for any situation where draining is difficult. Includes hoses and adapters.

Item#	Case
19161	6

OIL CHANGE PUMP



For emptying oil from inboard and I/O engines. Made of solid brass with removable tubing for ease of operation and cleaning.

Item#	Case
19181	12

OIL TO GAS MIXING CONTAINER



Oil mixture container allows the addition of the exact amount of oil required for a 2 cycle engine. Oil level marks are in gallons and litres. Determines ratios for 100:1, 50:1, 24:1 and 10:1 mixes. This wide mouth, quart size bottle can prevent fouled plugs or seized engines that can result from improper oil mixing.

Item#	Pack	Case
21000	Bulk	15

GEAR LUBE PUMP



- For use with 32 oz. gear lube bottles
- Fits any outboard or sterndrive
- Yamaha / metric adapter included

Item#	Case
19191	12

BILGE ABSORBENT



Manufactured from solid sheets of 100% blown polypropylene. It absorbs oil/fuel in the bilge so that remaining water can be pumped overboard. Absorbs 2 quarts of hydrocarbon. The "safety skin", a tough universal fabric skin, absorbs small amounts of water making the bilge absorbent fire resistant without interfering with its oil absorbency. This skin assures that the absorbent material will not get into the bilge and possibly foul moving parts. Great way to avoid fines from pumping oil overboard. Help keep our waterways clean. Convenient tie downs keep booms in place.

Item#	Size	Case
91000	4" x 4" x 13.25"	12

TIE DOWN CORD



An economical general purpose rope. Constructed of 8 strand white braided polypropylene cover with a knot holding control core. Excellent knot retention. Ideal for use with boat covers or to form the support structure for shrink wrapping boats.

Item#	Size	Tensile Strength	Color
48001	3/16" x 1000'	600 lbs.	White
48011	7/32" x 1000'	825 lbs.	White
48021	1/4" x 1000'	1000 lbs.	White

New POLYETHYLENE PROTECTIVE FILM



When used as masking, this film protects any exposed areas and prevents intrusion from outside debris as well as contamination. It also helps prevent scuff marks on decks and gunnels during major and minor repairs.

- Easy on, easy off; designed not to leave residue if removed within 30 days
- Puncture resistant due to it's high rubber content
- Contains no VOC's
- Meets LEEDs requirements
- Offers PSA (Pressure Sensitive Adhesive, Light Tack)

Item#	Size	Color	Case
93300	24" x 200'	Blue	4





STERLING SERIES BOAT COVERS



- Silver, 150 Denier Polyester
- Water-resistant material reflects heat away from the boat
- Strong, color-fast and water-resistant for lasting outdoor durability
- Seams are double folded for strength
- Tie-down straps with buckles are included for securing quickly and safely
- Adjustable elastic hem cords draw the cover's hem tight against any shape hull for a snug fit
- Attachment hooks anchor to either the winch tower or tongue jack bracket for a secure fit.
- 1 Year Warranty
- Trailerable with a mesh storage bag included

SEMI-CUSTOM BOAT COVERS



- Styled to fit, trailerable boat covers
- 100% 10 oz. cotton duck
- Haze gray
- Applied water repellent, mildew & UV resistant finish
- 1/4" shock cord sewn in hem
- Joint seams are folded 4-ply
- Motor covers sewn into outboard models
- Tie Down Kit (78941) sold separately
- 2 Year warranty

STERLING SERIES FISH & SKI & PRO-STYLE BASS - BOAT COVER



Item#	Boat Size	Beam	Case
97311	16' - 18'6"	96"	2

SEMI-CUSTOM V-HULL RUNABOUT O/B - BOAT COVER



Item#	Boat Size	Beam	Case
97401	17' 6"	90"	1
97421	18' 6"	96"	1
97441	19' 6"	96"	1

SEMI-CUSTOM V-HULL RUNABOUT I/O - BOAT COVER

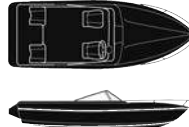

Item#	Boat Size	Beam	Case
97461	17' 6"	90"	1
97481	18' 6"	96"	1
97501	19' 6"	96"	1
97521	20' 6"	102"	1
97541	21' 6"	102"	1

STERLING SERIES V-HULL, TRI-HULL RUNABOUTS & ALUMINUM BASS BOAT - BOAT COVER

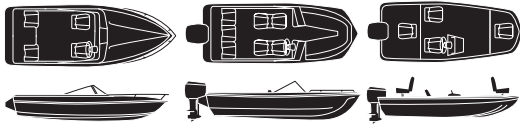

Item#	Boat Size	Beam	Case
97321	14' - 16'	90"	2

SEMI-CUSTOM WIDE BASS BOAT - BOAT COVER

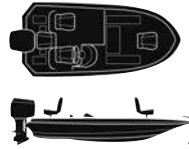

Item#	Boat Size	Beam	Case
97561	17' 6"	90"	1
97581	18' 6"	94"	1
97601	19' 6"	94"	1
97621	20' 6"	96"	1

STERLING SERIES V-HULL RUNABOUTS & LOW PROFILE CUDDY CABINS W/ RAIL - BOAT COVER

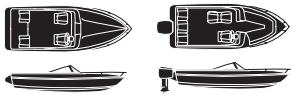

Item#	Boat Size	Beam	Case
97331	17' - 19'	102"	2
97341	19' - 21'	105"	2
97351	21' - 23'	105"	2

SEMI-CUSTOM V-HULL FISHING/WIDE SERIES - COVER



Item#	Boat Size	Beam	Case
97641	12' 6"	70"	1
97661	14' 6"	72"	1
97681	16' 6"	76"	1

SEMI-CUSTOM V-HULL CENTER CONSOLE - BOAT COVER



Item#	Boat Size	Beam	Case
97761	18' 6"	96"	1
97781	19' 6"	96"	1
97801	20' 6"	102"	1

SEMI-CUSTOM PONTOON COVER W/RAILS & TOP

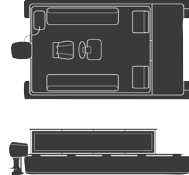

Includes Separate Motor Cover			
Item#	Boat Size	Beam	Case
97821	21' 6"	102"	1
97831	24' 6"	102"	1

STERLING SERIES CENTER CONSOLE - BOAT COVER



Item#	Boat Size	Beam	Case
97361	21' - 23'	102"	2

SEMI-CUSTOM JON BOAT - BOAT COVER



Item#	Boat Size	Beam	Case
97701	15' 6"	70"	1
97721	16' 6"	72"	1
97741	17' 6"	74"	1



TELESCOPING BOAT COVER SUPPORT POLE WITH BASE



1" Anodized aluminum construction. Supplied with mushroom top, snap-on fastener top and rubber cap.

Snap-On Fastener Top

Shown w/ Mushroom Top

Item#	Length	Case
97301	35" to 64"	12

BOAT COVER SOCKETS



Chrome plated zinc
Accommodates 3/8" battens up to 1 1/4".
Overall Size: 3 1/4" x 5/8". Opening dimensions: 1 1/8" x 7/16".

Item#	Fastener #	Pack	Case
78011	#6	1 pr.	12

TIE DOWN KIT



Tie down kit consists of (12) black polypropylene straps with quick release buckles.

Item#	Size	Pack	Case
78941	1" x 8'	12	12

3 BOW POLYGUARD BIMINI TOP



Ready-to-Assemble, complete Bimini Tops. UPS-able.

- Bright anodized aluminum frame with black nylon fittings
- White, 100% polyester marine-grade canvas with matching storage boot
- Heavy-duty snap hooks and eye straps
- Stainless steel assembly hardware included
- Storage boot included

Item#	Length	Width	Height	Color	Description
97861	6'	67"-72"	54"	White	3-Bow
97871	6'	73"-78"	54"	White	3-Bow
97881	6'	79"-84"	54"	White	3-Bow
97891	6'	85"-90"	54"	White	3-Bow

CENTER CONSOLE COVER



- Convenient protection for the console, electronics and controls
- 100% Marine-grade polyester
- UV and mildew resistant
- Excellent resistance to fading
- Extremely water repellent
- Breathable to help allow interior moisture to escape

Item#	Color	Size	Case
97911	Gray	40" D x 33" W x 36" H	1
97921	Gray	45" D x 36" W x 46" H	1
97931	Gray	50" D x 40" W x 60" H	1

ADJUSTABLE BIMINI TOP STRAPS



1" nylon webbing. Ring, snap, and buckle are corrosion resistant. Great for most size Biminis and awnings.

Item#	Length	Color	Pack	Case
78801	To 96"	White	1 pr.	12
78811	To 96"	Black	1 pr.	12

INTERNAL EYE END



Manufactured from high impact, super tough nylon. Corrosion resistant. Use on square tubing.

Item#	Color	Fits	Pack	Case
76321	Black	1" OD tube	1 pr.	12

INTERNAL EYE END



Manufactured from high impact, super tough nylon. Offers superior performance.

Item#	Color	Fits	Pack	Case
76001	White	3/4" OD Tube	1 pr.	12
76011	Black	3/4" OD Tube	1 pr.	12
76041	White	7/8" OD Tube	1 pr.	12
76051	Black	7/8" OD Tube	1 pr.	12

EXTERNAL EYE END



Super tough and corrosion resistant. Use on square tubing.

Item#	Material	Fits	Pack	Case
76341	Nylon / Black	1" OD tube	1 pr.	12

EYE STRAP



Multitude of applications.
28841: Use as battery hold down.

Item#	Material	Size	Stock	Fastener	Pack	Card	Case
28801	300 Stamped Stainless Steel	1 3/8" L x 3/8" ID Eye	Stamped	#10	1 pr.	2	12
28811	304 Forged Stainless Steel	1 1/8" L x 1 1/32" ID Eye	1/4"	#10	2 (Pr.)	4	12
28831	Chrome Plated Zinc	1 7/8" L x 3/8" ID Eye	1/4"	#8	2 (Pr.)	4	12
28841	Nickel Plated Brass Wire (Fits 1 1/4" Strap)	2 1 1/16" L x 1 1/32" x 1 1/32" ID Eye	1/4"	#8	1 pr.	2	12
28871	White Non-Corrosive Nylon	1 7/8" L x 1 1/32" ID Eye	1/4"	#8	2 (Pr.)	4	12
28881	Black Non-Corrosive Nylon	1 7/8" L x 1 1/32" ID Eye	1/4"	#8	2 (Pr.)	4	12



EXTERNAL EYE END



76081, 76091, 76101, 76111: Manufactured from high impact, super tough nylon. Offers superior performance.
75801, 75921: 316 Stainless steel. Corrosion resistant. 1/4-28 cup point set screw included. For 1/4" bolt.

Item#	Material	Fits	Pack	Case
76081	Plastic / White	3/4" OD Tube	1 pr.	12
76091	Plastic / Black	3/4" OD Tube	1 pr.	12
76101	Plastic / White	7/8" OD Tube	1 pr.	12
76111	Plastic / Black	7/8" OD Tube	1 pr.	12
75841	Chrome Plated Zamak	7/8" OD Tube	12	12
75801	Stainless Steel	7/8" OD Tube	12	12
75921	Stainless Steel	1" OD Tube	12	12

SQUARE JAW SLIDE



Manufactured from high impact, super tough nylon. Corrosion resistant. Use on square tubing.

Item#	Color	Fits	Pack	Case
76361	Black	1" OD tube	1 pr.	12

JAW SLIDE



76121, 76131, 76161, 76171: Manufactured from high impact, super tough nylon. Offers superior performance.
75811, 75931: 316 Stainless steel. Corrosion resistant. 1/4"-20 bolt and 1/4"-28 cup point set screw included.

Item#	Material	Fits	Pack	Case
76121	Plastic / White	3/4" OD Tube	1 pr.	12
76131	Plastic / Black	3/4" OD Tube	1 pr.	12
76161	Plastic / White	7/8" OD Tube	1 pr.	12
76171	Plastic / Black	7/8" OD Tube	1 pr.	12
75851	Chrome Plated Zamak	7/8" OD tube	12	12
75811	Stainless Steel	7/8" OD tube	12	12
75931	Stainless Steel	1" OD tube	12	12

SIDE MOUNT DECK HINGE



76201, 76211: Manufactured from high impact, super tough nylon. Offers superior performance.
75831: 316 Stainless steel. Base size: 7/8" x 2". Screw size: 1/4"-20.

Item#	Material	Feature	Pack	Case
76201	Plastic / White	-	1 pr.	12
76211	Plastic / Black	-	1 pr.	12
75831	Stainless Steel	-	12	12

DECK HINGE



76241, 76251, 76281, 76291: Manufactured from high impact, super tough nylon. Offers superior performance.

75861: Chrome Plated Zamak. Base size: 3/4" x 2 1/4". Screw size: 1/4"-20
75821: 316 Stainless steel. Base size: 5/8" x 2 3/8". Screw size: 1/4"-20.
75901: 316 Stainless steel. Corrosion resistant. 1/4"-20 bolt included. Predrilled for 2 #10 screws. Base size: 3/4" x 2 1/2"
75941: 316 Stainless steel. Corrosion resistant. Includes 1/4" spring loaded S.S. pin for quick removal. Predrilled for 2 #10 screws. Base size: 3/4" x 2 1/6"

Item#	Material	Feature	Pack	Case
76241	Plastic / White	-	1 pr.	12
76251	Plastic / Black	-	1 pr.	12
76281	Plastic / White	w/SS Slide Lock	1 pr.	12
76291	Plastic / Black	w/SS Slide Lock	1 pr.	12
75861	Chrome Plated Zamak	-	12	12
75821	Stainless Steel	-	12	12
75901	Stainless Steel	Heavy Duty	12	12
75941	Stainless Steel	W/Removable Pin	12	12

STAINLESS STEEL QUICK-DISCONNECT RELEASE PINS



Stainless steel with cable.

Item#	Pin	Size	Pack	Case
75961	1/4" x 1 3/8"	1" OD ring	1 pr.	12

New WINDSHIELD WIPER KIT



Kit Contains: Stainless steel motor housing with 1 7/8" shaft length and 3/8" shaft diameter. 13"-18" Adjustable pinch bolt bayonet arm. 11" Blade.

- Self Parking
- Frame Mounting Style
- Offers an adjustable Sweep (80° to 110°)

Item#	Description	Case
41811	Wiper Kit	12
Repl. Parts	Description	Case
41781	Wiper Blade	10
41791	Wiper Arm	10

SELF-PARKING WINDSHIELD WIPER KIT



Kit Contains:

- Frame Mounting Style
- Stainless steel motor housing with 1 7/8" shaft length and 3/8" shaft diameter
- Adjustable arm (110° sweep)
- 11" Blade

Item#	Description	Volts	Case
41801	Kit	12	10
Repl. Parts	Description		Case
41821	Arm		1
41831	Blade		12

MOORING ANCHORS

New and improved design-thicker shafts and larger eyes designed to accept over-size shackles. Mushroom type designed for permanent moorings. Made of heavy cast iron. **Not available in all locations.**



Item#	Model	Weight	Boat Size
44800	44800	25 lbs.	Up to 10'
44810	44810	50 lbs.	10'-14'
44820	44820	75 lbs.	14'-16'
44830	44830	100 lbs.	16'-18'
44840	44840	150 lbs.	18'-20'
44850	44850	200 lbs.	20'-24'
44860	44860	250 lbs.	25'-29'
44870	44870	300 lbs.	30'-34'
44880	44880	400 lbs.	35'-37'
44890	44890	500 lbs.	37'-39'
44780	44780	800 lbs.	40'+
44790	44790	1,000 lbs.	40'+
44750	44750	1,200 lbs.	40'+
44760	44760	1,500 lbs.	40'+
44770	44770	2,000 lbs.	40'+

PYRAMID ANCHORS



Pyramid anchors provide excellent holding power and work in tidal waters and rocky or sandy bottoms. They are superior to concrete blocks because the anchor rapidly sets itself by presenting a digging edge to penetrate the bottom. The pyramid shape presents a large surface area which creates high suction that increases the deeper it sets. The short shank allows mooring in shallower waters without chain wrap-up, a characteristic of mushroom anchors. Painted cast iron. **Not available in all locations.**

Item#	Model	Weight	Boat Size
43880	43880	25 lbs.	Up to 10'
43890	43890	50 lbs.	10'-14'
43900	43900	75 lbs.	14'-16'
43910	43910	100 lbs.	16'-18'
43920	43920	150 lbs.	18'-20'
43930	43930	200 lbs.	20'-24'
43940	43940	250 lbs.	25'-29'
43950	43950	300 lbs.	30'-34'
43960	43960	400 lbs.	35'-37'
43970	43970	500 lbs.	37'-39'
43980	43980	800 lbs.	40'+
43990	43990	1,000 lbs.	40'+
44000	44000	1,500 lbs.	40'+
44010	44010	2,000 lbs.	40'+

EYE - EYE SWIVEL

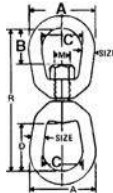

Hot dipped galvanized. Forged C-1045 steel.

Item #	A	B	C	D	M	R
43500	1 1/4"	5/8"	3/4"	1 1/16"	5/16"	2 15/16"
43510	1 5/8"	3/4"	1"	1 1/4"	3/8"	3 9/16"
43520	2"	7/8"	1 1/4"	1 1/2"	1/2"	4 5/16"
43530	2 1/2"	1 3/16"	1 1/2"	2"	5/8"	5 5/8"
43540	3"	1 1/2"	1 3/4"	2 3/8"	3/4"	6 5/8"
43550	3 1/2"	1 5/8"	2"	2 5/8"	7/8"	7 3/8"
43560	4 1/2"	2 3/16"	2 1/2"	3 1/2"	1 1/8"	9 5/8"

Item#	Size	Work Load	Break Strength	Case
43500	1/4"	850 lbs.	4,250 lbs.	12
43510	5/16"	1,250 lbs.	6,250 lbs.	12
43520	3/8"	2,250 lbs.	11,250 lbs.	12
43530	1/2"	3,600 lbs.	18,000 lbs.	12
43540	5/8"	5,200 lbs.	26,000 lbs.	6
43550	3/4"	7,200 lbs.	36,000 lbs.	6
43560	1"	12,500 lbs.	62,500 lbs.	1

LONG LINK GALVANIZED CHAIN



Grade 43 hot dipped galvanized chain. Ideal for moorings.

Not available in all locations.

Item#	Size
44710	3/8" x 200'
44720	1/2" x 200'
44730	5/8" x 150'
44740	3/4" x 100'

JAW - EYE SWIVEL

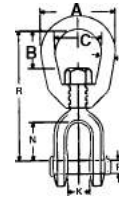

Hot dipped galvanized. Forged C-1045 steel.

Item#	A	B	C	K	N	P	R
43600	1 1/4"	5/8"	3/4"	1 3/32"	2 5/32"	1/4"	1 1/2"
43610	1 5/8"	3/4"	1"	1/2"	2 7/32"	5/16"	2 7/8"
43620	2"	7/8"	1 1/4"	5/8"	1 1/16"	7/16"	3 1/2"
43630	2 1/2"	1 1/4"	1 1/2"	7/8"	1 1/32"	1/2"	4 3/4"
43640	3"	1 1/16"	1 3/4"	1"	1 17/32"	5/8"	5 5/8"
43650	3 1/2"	1 3/4"	2"	1 1/8"	1 3/4"	3/4"	6"
43660	1"	2 3/16"	2 1/2"	1 3/4"	2 1/16"	1 1/8"	8 3/4"

Item#	Size	Work Load	Break Strength	Case
43600	1/4"	850 lbs.	4,250 lbs.	12
43610	5/16"	1,250 lbs.	6,250 lbs.	12
43620	3/8"	2,250 lbs.	11,250 lbs.	12
43630	1/2"	3,600 lbs.	18,000 lbs.	12
43640	5/8"	5,200 lbs.	26,000 lbs.	6
43650	3/4"	7,200 lbs.	36,000 lbs.	6
43660	1"	12,500 lbs.	62,500 lbs.	1

GALVANIZED ANCHOR SHACKLE



43040

Weldless, drop forged, galvanized to mil-spec. Packed 2 per card except for 1/2", single packed.

Item#	Size	Max Load	Break Strength	Pack	Pkg.	Case
43040	3/16"	275 lbs.	1,100 lbs.		Bulk	1
43051	1/4"	1,100 lbs.	4,400 lbs.	1 pr.	Card	12
43050	1/4"	1,100 lbs.	4,400 lbs.		Bulk	1
43061	5/16"	1,650 lbs.	6,600 lbs.	1 pr.	Card	12
43060	5/16"	1,650 lbs.	6,600 lbs.		Bulk	1
43071	3/8"	2,200 lbs.	8,800 lbs.	1 pr.	Card	12
43070	3/8"	2,200 lbs.	8,800 lbs.		Bulk	1
43080	7/16"	3,300 lbs.	13,200 lbs.		Bulk	1
43091	1/2"	4,400 lbs.	17,600 lbs.	1 pr.	Card	12
43090	1/2"	4,400 lbs.	17,600 lbs.		Bulk	1
43110	5/8"	6,150 lbs.	20,600 lbs.		Bulk	1
43120	3/4"	7,164 lbs.	31,800 lbs.		Bulk	1
43130	7/8"	9,369 lbs.	39,682 lbs.		Bulk	1
43140	1"	10,000 lbs.	44,000 lbs.		Bulk	1
43150	1 1/4"	14,000 lbs.	60,000 lbs.		Bulk	1

STAINLESS STEEL WIRE ROPE THIMBLE



Wire rope style thimbles. Meets federal specs. FFT- 276b type 2.

Item#	Size	Pack	Pkg.	Case
43391	3/16"	2	Card	12
43401	1/4"	2	Card	12
43411	5/16"	2	Card	12
43421	3/8"	2	Card	12
43431	1/2"	2	Card	12
43370	5/8"		Bulk	1
43380	3/4"		Bulk	1



SEACHOICE BANNER



Three-color Seachoice 2' H x 4' W banner. Constructed of 8 mil poly with sewn hems and grommets on each corner for hanging.

SEACHOICE CATEGORY SIGNS

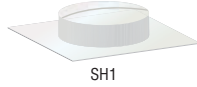

Sign Categories

- (3) Seachoice Logo
- (1) Cordage
- (1) Electrical Equipment
- (1) Electronics
- (1) Fishing Sports
- (1) Fuel Delivery
- (1) General Accessories

- (1) Hardware
- (1) Lighting
- (1) Mooring
- (1) Refinishing
- (1) Safety
- (1) Trailer Equipment
- (1) Water Sports

Item#	Description	Pack	Case
GTKIT2	Pack of 16		1
SH1	Sign Holder	1 pr.	1

ROPE REEL RACK DISPLAY



- Simple and easy way to display rope reels
- Gloss black finish with three crossbar
- Holds 6-12 reels of rope depending on size
- No assembly required

Item#
ROPERACK

Case
1

ANCHOR RACK DISPLAY

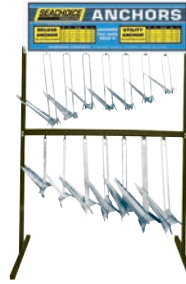

A cost effective way of displaying anchors. 48" wide unit with self-selling header which draws customers' attention. Display features adjustable rack and can hold between 14 and 20 anchors depending on size. **Anchors not included.**

Item#	Description
RACKANCHOR	Rack and Sign
Repl. Parts	Description
HEADERRACKSIGN	Sign Only

LOCK IN THE COLD LONGER

7-DAY COOLER

Features integrated insulation and a lid gasket. *Provides superior ice retention—stays cold up to 7 days.



FOUR SIZES

31.7 Qt. / 30 L

Wheeled

63.4 Qt. / 60L

84.5 Qt. / 80L

116 Qt. / 110L

- 2-1/2" of premium insulation
- FDA approved material
- Cooler box is non-toxic
- Built-in UV resistant materials
- Removable / Replaceable handle design
- Non-slip rubber feet
- Patented rubber latches
- Imprinted fish scale on lid
- Dry ice compatible

*Results might vary depending on use and environmental factors.





Commitment To Our Customers

We are committed to delivering premium quality products that appeal to consumers at a competitive price. We welcome your comments and suggestions on new products including improvement to existing Seachoice products.

Seachoice reserves the right to make changes in product specifications for the purpose of improvement without prior notice. Our products are sold to trade dealers only and possession of this catalog does not infer an offer to sell.

Limited Warranty

SEACHOICE PRODUCTS (SEACHOICE) warrants the original consumer purchaser that SEACHOICE consumer products will be free from defective materials or workmanship, under normal use and service, for a period of one (1) year from the original purchase date.

This Warranty is void if the consumer product warranted has been damaged by accident or unreasonable use, neglect, improper service, unauthorized alteration, or other cause not arising out of defects in material or workmanship.

In no event shall SEACHOICE PRODUCTS be liable for loss of use of its consumer product nor for other incidental or consequential costs, expenses or damages incurred by any person.

During the Warranty period, your SEACHOICE product will either be repaired or it will be replaced with a like product (at SEACHOICE option) when returned prepaid and insured, with proof-of-purchase date to SEACHOICE at the address listed below



THE QUALITY CHOICE



Shop for other boat parts & hardware on our website.